

TEST REPORT
On behalf of

Savant Technologies LLC, dba GE Lighting, a Savant company

Product Name: CYNCR Direct Connected Indoor Premium Light strip
(16ft.)

Model No.: CLEDSTR24CDIDP

FCC ID: PUU-STR-SCIDP

Prepared For: Savant Technologies LLC, dba GE Lighting, a Savant company
1975 Noble Road, Cleveland, OH 44112

Prepared By: Audix Technology (Shanghai) Co., Ltd.
3F and 4F, 34Bldg, 680 Guiping Rd.,
Caohejing Hi-Tech Park,
Shanghai 200233, China

Tel: +86-21-64955500



File No. : C1D2112030
Report No. : ACI-F22047
Date of Test : 2022.01.28-02.15
Date of Report : 2022.02.25

The statement is based on a single evaluation of one sample of the above-mentioned products. It does not imply an assessment of the whole production and does not permit the use of the test lab logo. The report must not be used by the client to claim product certification, approval, or endorsement by NVLAP, NIST, or any agency of the Federal Government.

TABLE OF CONTENTS

	Page
1 SUMMARY OF STANDARDS AND RESULTS.....	5
1.1 Description of Standards and Results.....	5
2 GENERAL INFORMATION.....	6
2.1 Description of Equipment Under Test.....	6
2.2 EUT Specifications Assessed in Current Report.....	7
2.3 Test Information.....	7
2.4 Sample Description.....	7
2.5 Supported equipment.....	8
2.6 Description of Test Facility.....	8
3 CONDUCTED EMISSION TEST.....	9
3.1 Test Equipment.....	9
3.2 Block Diagram of Test Setup.....	9
3.3 Conducted Emission Limits (§15.207).....	10
3.4 Test Configuration.....	10
3.5 Operating Condition of EUT.....	10
3.6 Test Procedures.....	10
3.7 Test Results.....	11
4 RADIATED EMISSION TEST.....	13
4.1 Test Equipment.....	13
4.2 Block Diagram of Test Setup.....	13
4.3 Radiated Emission Limit (§15.209).....	14
4.4 Test Configuration.....	14
4.5 Operating Condition of EUT.....	15
4.6 Test Procedures.....	15
4.7 Test Results.....	16
5 99% OCCUPIED BANDWIDTH MEASUREMENT.....	31
5.1 Test Equipment.....	31
5.2 Block Diagram of Test Setup.....	31
5.3 Operating Condition of EUT.....	31
5.4 Test Procedure.....	31
5.5 Test Results.....	32
6 6 DB BANDWIDTH MEASUREMENT.....	38
6.1 Test Equipment.....	38
6.2 Block Diagram of Test Setup.....	38
6.3 Specification Limits (§15.247(a)(2)).....	38
6.4 Operating Condition of EUT.....	38
6.5 Test Procedure.....	38
6.6 Test Results.....	39
7 MAXIMUM PEAK OUTPUT POWER MEASUREMENT.....	45
7.1 Test Equipment.....	45
7.2 Block Diagram of Test Setup.....	45
7.3 Specification Limits ((§15.247(b)(3)).....	45
7.4 Operating Condition of EUT.....	45

7.5 Test Procedure 45

7.6 Test Results 47

8 EMISSION LIMITATIONS MEASUREMENT..... 53

8.1 Test Equipment..... 53

8.2 Block Diagram of Test Setup 53

8.3 Specification Limits (§15.247(d)) 53

8.4 Operating Condition of EUT 53

8.5 Test Procedure 53

8.6 Test Results 55

9 POWER SPECTRAL DENSITY MEASUREMENT 80

9.1 Test Equipment..... 80

9.2 Block Diagram of Test Setup 80

9.3 Specification Limits (§15.247(e)) 80

9.4 Operating Condition of EUT 80

9.5 Test Procedure 80

9.6 Test Results 81

10 DEVIATION TO TEST SPECIFICATIONS 87

11 MEASUREMENT UNCERTAINTY LIST 88

TEST REPORT

Applicant : Savant Technologies LLC, dba GE Lighting, a Savant company
 EUT Description : CYNC Direct Connected Indoor Premium Light strip (16ft.)
 (A) Model No. : CLEDSTR24CDIDP
 (B) Power Supply : 120V AC 60Hz
 (C) Test Voltage : 120V/60Hz

Test Procedure Used:

*FCC RULES AND REGULATIONS PART 15 SUBPART C
 AND ANSI C63.10-2013*

The device described above is tested by Audix Technology (Shanghai) Co., Ltd. to determine the maximum emission levels emanating from the device. The maximum emission levels are compared to the FCC Part 15 Subpart C limits.

The test results are contained in this test report and Audix Technology (Shanghai) Co., Ltd. is assumed full responsibility for the accuracy and completeness of these measurements. This report also shows that the EUT (M/N: Refer to Sec2.1), which was tested is technically compliance with the FCC limits.

This report applies to above tested Sample only. This report shall not be reproduced in part without written approval of Audix Technology (Shanghai) Co., Ltd.

The test results for EUT's BLE function are contained in No.ACI-F22046 report.

Date of Test : 2022.01.28-02.15 Date of Report : 2022.02.25

Producer : 
 MINDY WANG / Assistant

Reviewer : 
 BYRON WU/ Deputy Assistant Manager

 For and on behalf of
 Audix Technology (Shanghai) Co., Ltd.

Signatory : 
 Authorized Signature(s) BYRON KWO/Assistant General Manager

1 SUMMARY OF STANDARDS AND RESULTS

1.1 Description of Standards and Results

The EUT have been tested according to the applicable standards as referenced below:

Description / Test Item	Test Standard	Results	Meets Limit
EMISSION			
Conducted Emission	FCC RULES AND REGULATIONS PART 15 SUBPART C AND ANSI C63.10:2013	Pass	15.207
Radiated Emission	FCC RULES AND REGULATIONS PART 15 SUBPART C AND ANSI C63.10:2013	Pass	15.209(a) 15.205(a)(c)
6 dB Bandwidth Measurement	FCC RULES AND REGULATIONS PART 15 SUBPART C AND ANSI C63.10:2013	Pass	15.247(a)(2)
Maximum Peak Output Power Measurement	FCC RULES AND REGULATIONS PART 15 SUBPART C AND ANSI C63.10:2013	Pass	15.247(b)(3)
Emission Limitations Measurement	FCC RULES AND REGULATIONS PART 15 SUBPART C AND ANSI C63.10:2013	Pass	15.247(d)
Band Edge Measurement	FCC RULES AND REGULATIONS PART 15 SUBPART C AND ANSI C63.10:2013	Pass	15.247(d)
Power Spectral Density Measurement	FCC RULES AND REGULATIONS PART 15 SUBPART C AND ANSI C63.10:2013	Pass	15.247(e)
N/A is an abbreviation for Not Applicable.			

2 GENERAL INFORMATION

2.1 Description of Equipment Under Test

Description : CYNC Direct Connected Indoor Premium Light strip (16ft.)

Type of EUT : Production Pre-product Pro-type

Model Number : CLEDSTR24CDIDP

Radio Tech : BLE 4.2;
IEEE 802.11 b/g/n.

Note: : 802.11n-HT40 not support.

Channel Freq. : BLE: 2402MHz-2480MHz;
802.11b/g/n: 2412MHz-2462MHz.

Modulation : BLE: GFSK;
802.11b: DSSS (CCK, DQPSK, DBPSK);
802.11g/n: OFDM (64QAM, 16QAM, QPSK, BPSK).

Antenna Info. : Antenna Type: PCB Antenna
Antenna Gain: 1.5 dBi
The Antenna was a permanently attached antenna that is comply with 15.203 requirement.

Test Mode : The EUT was set at continuous TX during all the test in the report.

Applicant : Savant Technologies LLC, dba GE Lighting, a Savant company
1975 Noble Road, Cleveland, OH 44112

Manufacturer : same as Applicant

Factory : VIETNAM CHANGHONG ELECTRIC COMPANY LIMITED
Workshop W4 (leased by WWWHP), Land plot 4.2B,
Dinh Vu Industrial Zone, Dong Hai 2 Ward, Hai An District, Haiphong City, VN.

2.2 EUT Specifications Assessed in Current Report

Mode	Modulation	Data Rate(Mbps)
802.11b	DS (DQPSK, DBPSK, CCK)	Up to 11
802.11g	OFDM (64-QAM, 16-QAM, QPSK, BPSK)	Up to 54
802.11n-HT 20	OFDM (64-QAM, 16-QAM, QPSK, BPSK)	Up to 72.2

Channel List			
Channel No.	Frequency (MHz)	Channel No.	Frequency (MHz)
1	2412	7	2442
2	2417	8	2447
3	2422	9	2452
4	2427	10	2457
5	2432	11	2462
6	2437		

2.3 Test Information

The test software “UI_mptool.exe” was used to control EUT work in TX mode, Power Index and select test channel.

Modulation	data rate (Mbps)	Test Channel		Frequency (MHz)
802.11b	11	Low:	1	2412
		Middle:	6	2437
			8	2447
		High:	11	2462
802.11g	6	Low:	1	2412
		Middle:	6	2437
			8	2447
		High:	11	2462
802.11n20	MCS0	Low:	1	2412
		Middle:	6	2437
			8	2447
		High:	11	2462

2.4 Sample Description

Test Item	Model Number	Sample Number	Date of receipted
Conducted Emission	CLEDSTR24CDIDP	E21121938-01/03	2021.12.31
Radiated Emission	CLEDSTR24CDIDP	E211118441a-01/02	2021.12.08
Conducted RF Test	CLEDSTR24CDIDP	E211118441a-02/02	2021.12.08

2.5 Supported equipment

Brand : Acer
Product Name: : Notebook PC
Model Name : TravelMate P238 series
Model Number : N15W8

2.6 Description of Test Facility

Name of Firm : Audix Technology (Shanghai) Co., Ltd.
Site Location : 3F and 4F, 34Bldg, 680 Guiping Rd.,
Caohejing Hi-Tech Park,
Shanghai 200233, China.
Accredited by NVLAP, Lab Code : 200371-0
FCC Designation Number : CN5027
Test Firm Registration Number : 954668

3 CONDUCTED EMISSION TEST

3.1 Test Equipment

The following test equipments are used during the conducted emission test in a shielded room:

Item	Type	Manufacturer	Model No.	Serial No.	Cal. Date	Cal. Interval
1.	Test Receiver	R&S	ESCI	100841	2021.02.11	1 Year
2.	Artificial Mains Network (AMN)	R&S	ESH2-Z5	843890/011	2022.01.06	1 Year
3.	Software	Audix	e3	6.2009-1-15	--	--

3.2 Block Diagram of Test Setup

3.2.1 Conducted Disturbance Test Setup

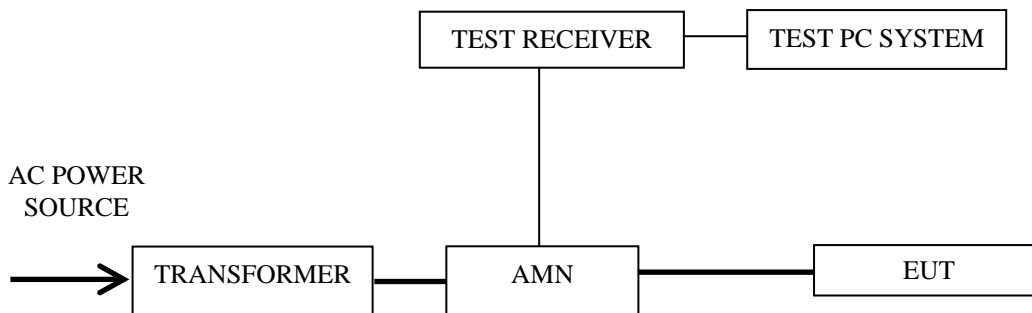

— : Signal Line
 — : Power Line

3.3 Conducted Emission Limits (§15.207)

Frequency Range (MHz)	Limits dB(μV)	
	Quasi-peak	Average
0.15 ~ 0.5	66~56	56~46
0.5 ~ 5	56	46
5 ~ 30	60	50

NOTE 1 – The lower limit shall apply at the transition frequencies.
 NOTE 2 – The limit decreases linearly with the logarithm of the frequency in the range 0.15 MHz~0.50 MHz

3.4 Test Configuration

The EUT (listed in Sec.2.1) was installed as shown on Sec.3.2 to meet FCC requirement and operating in a manner which tends to maximize its emission level in a normal application.

3.5 Operating Condition of EUT

- 3.5.1 Setup the EUT as shown in Sec. 3.2.
- 3.5.2 Turn on the power of all equipment.
- 3.5.3 Turn the EUT on the test mode, and then test.

3.6 Test Procedures

The EUT was placed upon a non-metallic table, which is 0.8 m above the horizontal conducting ground plane and 0.4 m from a vertical reference plane. The EUT was connected to the power mains through an Artificial Mains Network (AMN) to provide a 50 Ω coupling impedance for the measuring equipment. Both sides of AC line (Line & Neutral) were checked to find out the maximum conducted emission according to FCC Part 15 Subpart C and ANSI C63.10: 2013 requirements during conducted disturbance test.

The I.F. bandwidth of Test Receiver ESCI was set at 9 kHz.

The frequency range from 150 kHz to 30 MHz was checked.

Test with a dummy load in lieu of the antenna to determine compliance with Section 15.207 limits within the transmitter's fundamental emission band. (According to KDB 174176 D01 Line Conducted FAQ)

The test modes were done on conducted disturbance test and all the test results are listed in Sec. 3.7

3.7 Test Results

< **PASS** >

The frequency and amplitude of the highest conducted emission relative the limit is reported. All the emissions not reported below are too low against the FCC limit.

Worst case emission:

No.	Operation	Modulation	Channel	Frequency (MHz)	Data Page
1.	Transmitting	--	--	--	P12

NOTE 1 – Level = Read Level + AMN Factor + Cable Loss

NOTE 2 – “QP” means “Quasi-Peak” values

NOTE 3 – The emission levels which not reported are too low against the official limit.

Worst case emission

EUT : CYNC Direct Connected Indoor Premium Light strip (16ft.) Temperature : 22°C

Model No. : CLEDSTR24CDIDP Humidity : 51%RH

Test Mode : Transmitting Date of Test : 2022.01.28

Polarization	Frequency (MHz)	Meter Reading dB (µV)	AMN Factor (dB)	Cable Loss (dB)	Emission Level dB (µV)	Limits dB (µV)	Margin (dB)	Remark
Line	0.1965	36.59	0.2	0.03	36.82	63.76	26.94	QP
	0.1965	21.5	0.2	0.03	21.73	53.76	32.03	Average
	0.4812	35.42	0.2	0.04	35.66	56.32	20.66	QP
	0.4812	21.5	0.2	0.04	21.74	46.32	24.58	Average
	0.5293	38.83	0.2	0.04	39.07	56	16.93	QP
	0.5293	23.1	0.2	0.04	23.34	46	22.66	Average
	0.8897	39.71	0.2	0.06	39.97	56	16.03	QP
	0.8897	24.8	0.2	0.06	25.06	46	20.94	Average
	1.519	38.1	0.2	0.07	38.37	56	17.63	QP
	1.519	25.47	0.2	0.07	25.74	46	20.26	Average
	2.65	36.5	0.23	0.1	36.83	56	19.17	QP
	2.65	26.12	0.23	0.1	26.45	46	19.55	Average
Neutral	0.1965	43	0.2	0.03	43.23	63.76	20.53	QP
	0.1965	28.3	0.2	0.03	28.53	53.76	25.23	Average
	0.3286	41.23	0.2	0.03	41.46	59.49	18.03	QP
	0.3286	24.87	0.2	0.03	25.1	49.49	24.39	Average
	0.4661	40.7	0.2	0.04	40.94	56.58	15.64	QP
	0.4661	24.4	0.2	0.04	24.64	46.58	21.94	Average
	0.5293	39.5	0.2	0.04	39.74	56	16.26	QP
	0.5293	23.2	0.2	0.04	23.44	46	22.56	Average
	1.071	35.1	0.2	0.06	35.36	56	20.64	QP
	1.071	23.29	0.2	0.06	23.55	46	22.45	Average
	4.114	29.1	0.3	0.12	29.52	56	26.48	QP
	4.114	22.74	0.3	0.12	23.16	46	22.84	Average

TEST ENGINEER: Jarey

4 RADIATED EMISSION TEST

4.1 Test Equipment

The following test equipment are used during the radiated emission test in a semi-anechoic chamber:

Item	Type	Manufacturer	Model No.	Serial No.	Cal. Date	Cal. Interval
1.	Preamplifier	Agilent	8447D	2944A10548	2021.03.08	1 Year
2.	Preamplifier	HP	8449B	3008A00864	2021.03.08	1 Year
3.	Spectrum Analyzer	Agilent	N9010A	MY52221182	2021.09.16	1 Year
4.	Test Receiver	R&S	ESCI	101303	2021.03.08	1 Year
5.	Bilog Antenna+6dB Attenuator	Schwarz beck	VULB 9168+EMCI-N-6-06	707+AT-N0637	2021.03.30	1 Year
6.	Horn Antenna	EMCO	3115	9607-4878	2021.07.27	1 Year
7.	Horn Antenna	EMCO	3116	00062643	2020.10.10	1 Year
8.	Cavity Band Rejection Filter	Microwave	WT-A3882-R10	WT200312-1-1	2021.09.15	1 Year
9.	Software	Audix	e3	SET002009912M295-2	--	--

4.2 Block Diagram of Test Setup

4.2.1 EUT & Peripherals

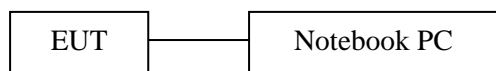

4.2.2 Below 1GHz

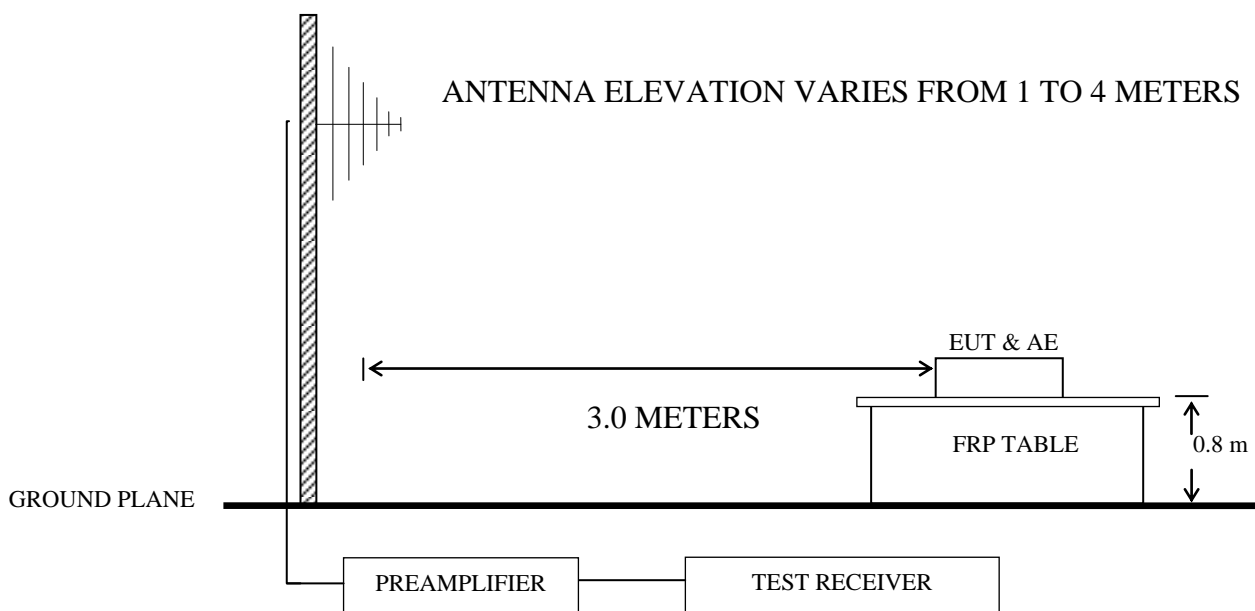

4.2.3 Above 1GHz

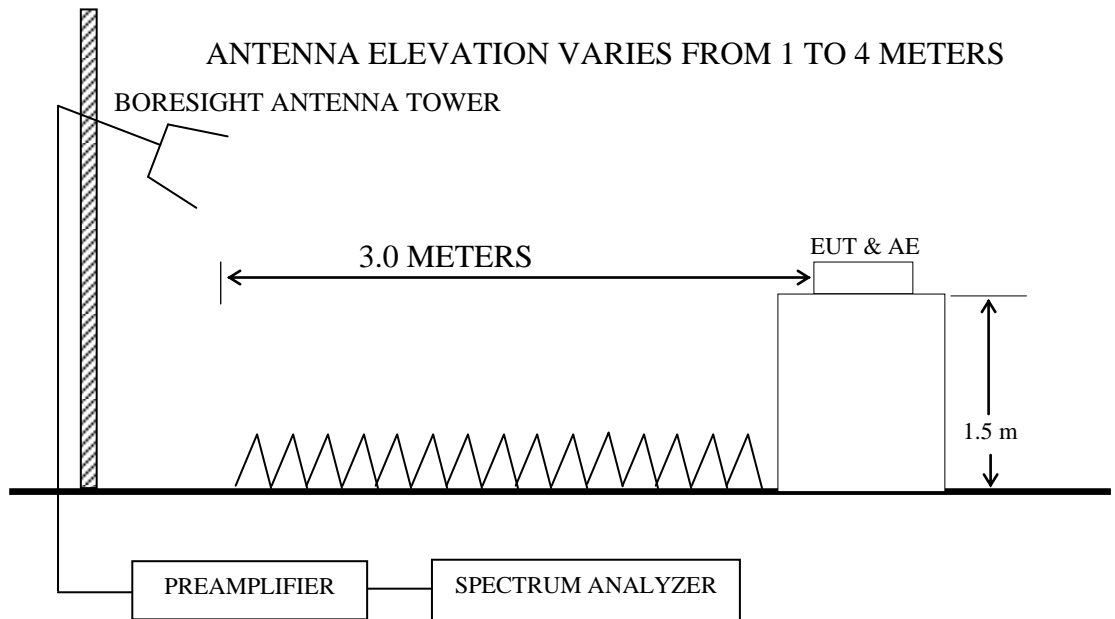

4.3 Radiated Emission Limit (§15.209)

Frequency (MHz)	Distance (m)	Field strength limits ($\mu\text{V/m}$)	
		($\mu\text{V/m}$)	($\mu\text{V/m}$)
30 ~ 88	3	100	40.0
88 ~ 216	3	150	43.5
216 ~ 960	3	200	46.0
Above 960	3	500	54.0

NOTE 1 - Emission Level dB ($\mu\text{V/m}$) = 20 log Emission Level (V/m)

NOTE 2 - The tighter limit applies at the band edges.

NOTE 3 - Distance refers to the distance in meters between the measuring instrument antenna and the closed point of any part of the device or system.

NOTE 4 - The limits shown are based on Quasi-peak value detector below or equal to 1GHz and Average value detector above 1GHz.

NOTE 5 - Above 1 GHz, the limit on peak emission is 20 dB above the maximum permitted average emission limit applicable to the EUT

4.4 Test Configuration

The EUT (listed in Sec.2.1) and the simulators (listed in Sec.2.2) were installed as shown on Sec.4.2 to meet FCC requirements and operating in a manner that tends to maximize its emission level in a normal application.

4.5 Operating Condition of EUT

4.5.1 Setup the EUT as shown in Sec. 4.2.

4.5.2 Turn on the power of all equipment.

4.5.3 Turn the EUT on the test mode, and then test.

4.6 Test Procedures

Radiated emission test applies to harmonics/spurs that fall in the restricted bands listed in Section 15.205. The maximum permitted average field strength is listed in Section 15.209. A pre-amp is necessary for this measurement. For measurement above 1 GHz, set RBW = 1MHz, VBW = 10 Hz, Sweep: Auto. If the emission is pulsed, modify the unit for continuous operation; use the settings shown above, then correct the reading by subtracting the peak-average correction factor, derived from the appropriate duty cycle calculation.

The EUT was placed on a turntable. Below 1 GHz, the table height is 80 cm above the reference ground plane. Above 1 GHz, the table height is 1.5 m. The turntable rotated 360 degrees to determine the position of the maximum emission level. The EUT was set 3 meters away from the receiving antenna, which was mounted on an antenna tower. The antenna moved up and down between 1 meter and 4 meters to find out the maximum emission level. Broadband antenna (Calibrated Bilog Antenna) or Horn antenna was used as receiving antenna. Both horizontal and vertical polarizations of the antenna were set on measurement. In order to find the maximum emission, all of the interference cables were manipulated according to ANSI C63.10: 2013 requirements during radiated emission test.

The bandwidth of Test Receiver R&S ESCI was set at 120 kHz from 30MHz to 1000MHz.

The bandwidth of Agilent N9010A was set at 1MHz for above 1GHz.

The frequency range from 30 MHz to 25 GHz (Up to 10th harmonics from fundamental frequency) was checked.

All the test results are listed in Sec.4.7.

4.7 Test Results

<PASS>

The frequency and amplitude of the highest radiated emission relative the limit is reported. All the emissions not reported below are too low against the FCC limit.

Frequency range: below 1GHz (Worst case emission)

No.	Operation	Modulation	Channel	Frequency	Data Page
1.	Transmitting	802.11b	1	2412 MHz	P18
2.			6	2437 MHz	P18
3.			11	2462 MHz	P19
4.		802.11g	1	2412 MHz	P19
5.		802.11n20	1	2412 MHz	P20

Frequency range: above 1GHz

No.	Operation	Modulation	Channel	Frequency	Data Page
1.	Transmitting	802.11b	1	2412 MHz	P21
2.			6	2437 MHz	P21
3.			11	2462 MHz	P22
4.	Transmitting	802.11g	1	2412 MHz	P22
5.	Transmitting	802.11n20	1	2412 MHz	P23

Band-Edge:

No.	Operation	Modulation	Channel	Frequency	Data Page
1.	Transmitting	802.11b	1	2412 MHz	P24
2.			11	2462 MHz	P24
3.		802.11g	1	2412 MHz	P24
4.			11	2462 MHz	P25
5.		802.11n20	1	2412 MHz	P25
6.			11	2462 MHz	P25

Restricted bands:

No.	Operation	Modulation	Channel	Frequency	Data Page
1.	Transmitting	802.11b	1	2412 MHz	P26
2.			8	2447 MHz	P26
3.			11	2462 MHz	P27
4.		802.11g	1	2412 MHz	P27
5.			8	2447 MHz	P28
6.			10	2457 MHz	P28
7.			11	2462 MHz	P29
8.		802.11n20	1	2412 MHz	P29
9.			8	2447 MHz	P30
10.			11	2462 MHz	P30

NOTE 1 – Level = Read Level + Antenna Factor + Cable Loss - Preamp Factor

NOTE 2 – “QP” means “Quasi-Peak” values

NOTE 3 – 0° was the table front facing the antenna. Degree is calculated from 0° clockwise facing the antenna.

- NOTE 4 – The emission levels which not reported are too low against the official limit.
- NOTE 5 – The emission levels recorded below is data of EUT configured in Standing direction, for Standing direction was the maximum emission direction during the test. The data of Side & Lying direction are too low against the official limit to be reported.
- NOTE 6 – All reading are Quasi-Peak values below or equal to 1GHz, Peak and Average values above 1GHz.
For above 1GHz test, if the peak measured value complies with the average limit, it is unnecessary to perform an average measurement.
- NOTE 7 – The frequency range 2310-2390MHz & 2483.5-2500MHz were tested for Restricted bands.

Worst case emission < 1GHz

EUT : CYNCR Direct Connected Indoor Premium Light strip (16ft.) Temperature : 22°C

Model No. : CLEDSTR24CDIDP Humidity : 51%RH

Test Mode : Transmitting Date of Test : 2022.02.14

802.11b CH2412MHz

Polarization	Frequency (MHz)	Meter Reading dB (µV)	Antenna Factor (dB/m)	Cable Loss (dB)	Preamplifier Factor (dB)	Emission Level dB (µV/m)	Limits dB (µV/m)	Margin (dB)	Remark
Horizontal	45.058	23.31	19.3	0.71	28.22	15.1	40	24.9	QP
	59.025	23.42	19.4	0.83	28.16	15.49	40	24.51	QP
	147.4	23.35	18.9	1.3	27.81	15.74	43.5	27.76	QP
	231.72	32.34	16	1.63	27.24	22.73	46	23.27	QP
	400.43	24.53	21.1	2.17	27.6	20.2	46	25.8	QP
	699.31	21.93	26.3	2.86	27.4	23.69	46	22.31	QP
Vertical	46.503	23.53	19.5	0.72	28.21	15.54	40	24.46	QP
	61.132	23.9	19.1	0.84	28.16	15.68	40	24.32	QP
	153.2	23.09	19.1	1.32	27.78	15.73	43.5	27.77	QP
	233.35	28.31	16.3	1.63	27.23	19.01	46	26.99	QP
	323.32	26.2	19.75	1.96	27.15	20.76	46	25.24	QP
	689.57	23.71	26.3	2.84	27.45	25.4	46	20.6	QP

802.11b CH2437MHz

Polarization	Frequency (MHz)	Meter Reading dB (µV)	Antenna Factor (dB/m)	Cable Loss (dB)	Preamplifier Factor (dB)	Emission Level dB (µV/m)	Limits dB (µV/m)	Margin (dB)	Remark
Horizontal	40.702	23.73	19	0.67	28.24	15.16	40	24.84	QP
	60.492	23.59	19.15	0.84	28.16	15.42	40	24.58	QP
	160.91	22.86	19	1.36	27.73	15.49	43.5	28.01	QP
	246.82	31.2	17.43	1.67	27.16	23.14	46	22.86	QP
	407.52	23.62	21.25	2.18	27.63	19.42	46	26.58	QP
	714.17	22.47	26.6	2.88	27.34	24.61	46	21.39	QP
Vertical	35.375	24.5	18.64	0.62	28.27	15.49	40	24.51	QP
	56.197	22.65	19.48	0.8	28.18	14.75	40	25.25	QP
	172.6	23.36	18.5	1.41	27.64	15.63	43.5	27.87	QP
	231.72	25.97	16	1.63	27.24	16.36	46	29.64	QP
	383.93	24.11	20.9	2.12	27.5	19.63	46	26.37	QP
	679.96	23.22	26	2.82	27.48	24.56	46	21.44	QP

802.11b CH2462MHz

Polarization	Frequency (MHz)	Meter Reading dB (μV)	Antenna Factor (dB/m)	Cable Loss (dB)	Preamp Factor (dB)	Emission Level dB (μV/m)	Limits dB (μV/m)	Margin (dB)	Remark
Horizontal	43.05	24.85	19.1	0.7	28.23	16.42	40	23.58	QP
	63.983	22.99	18.8	0.86	28.15	14.5	40	25.5	QP
	141.83	23.04	18.6	1.28	27.82	15.1	43.5	28.4	QP
	248.55	29.29	17.47	1.68	27.16	21.28	46	24.72	QP
	443.29	22.8	22.53	2.28	27.77	19.84	46	26.16	QP
	752.74	22.24	27.7	2.9	27.2	25.64	46	20.36	QP
Vertical	39.715	24.53	18.91	0.66	28.24	15.86	40	24.14	QP
	56.593	23.48	19.44	0.81	28.17	15.56	40	24.44	QP
	141.33	23.48	18.6	1.28	27.82	15.54	43.5	27.96	QP
	293.08	24.74	18.86	1.88	27.03	18.45	46	27.55	QP
	482.22	23.72	22.93	2.43	27.86	21.22	46	24.78	QP
	750.11	22.36	27.6	2.9	27.2	25.66	46	20.34	QP

802.11g CH2412MHz

Polarization	Frequency (MHz)	Meter Reading dB (μV)	Antenna Factor (dB/m)	Cable Loss (dB)	Preamp Factor (dB)	Emission Level dB (μV/m)	Limits dB (μV/m)	Margin (dB)	Remark
Horizontal	38.212	24.37	18.7	0.65	28.25	15.47	40	24.53	QP
	62.871	23.95	19.02	0.86	28.15	15.68	40	24.32	QP
	142.32	23.05	18.65	1.28	27.82	15.16	43.5	28.34	QP
	278.07	28.65	18.42	1.82	27.1	21.79	46	24.21	QP
	554.83	23.06	24.2	2.53	27.89	21.9	46	24.1	QP
	890.73	22.75	28.2	3.31	26.35	27.91	46	18.09	QP
Vertical	41.132	23.51	19.01	0.68	28.24	14.96	40	25.04	QP
	58.203	22.61	19.4	0.82	28.17	14.66	40	25.34	QP
	141.83	23.29	18.6	1.28	27.82	15.35	43.5	28.15	QP
	234.99	26.28	16.6	1.64	27.23	17.29	46	28.71	QP
	422.06	24.95	21.77	2.22	27.68	21.26	46	24.74	QP
	747.48	22.9	27.5	2.9	27.2	26.1	46	19.9	QP

802.11n20 CH2412MHz

Polarization	Frequency (MHz)	Meter Reading dB (μV)	Antenna Factor (dB/m)	Cable Loss (dB)	Preamplifier Factor (dB)	Emission Level dB (μV/m)	Limits dB (μV/m)	Margin (dB)	Remark
Horizontal	36.766	24.68	18.7	0.64	28.26	15.76	40	24.24	QP
	62.431	23.04	19.06	0.86	28.15	14.81	40	25.19	QP
	141.83	22.25	18.6	1.28	27.82	14.31	43.5	29.19	QP
	241.68	31.65	17.27	1.66	27.2	23.38	46	22.62	QP
	364.26	24.4	20.35	2.05	27.4	19.4	46	26.6	QP
	616.37	23.7	25.6	2.77	27.73	24.34	46	21.66	QP
Vertical	40.702	24.34	19	0.67	28.24	15.77	40	24.23	QP
	62.431	23.92	19.06	0.86	28.15	15.69	40	24.31	QP
	168.41	23.2	18.75	1.39	27.67	15.67	43.5	27.83	QP
	312.18	23.37	19.32	1.94	27.08	17.55	46	28.45	QP
	485.61	24.42	23	2.43	27.87	21.98	46	24.02	QP
	721.73	23.7	26.75	2.88	27.31	26.02	46	19.98	QP

TEST ENGINEER: Jarey

Radiated Emission > 1GHz

EUT : CYNC Direct Connected Indoor Premium Light strip (16ft.) Temperature : 22°C

Model No. : CLEDSTR24CDIDP Humidity : 51%RH

Test Mode : Transmitting Date of Test : 2022.02.14

802.11b CH2412MHz

Polarization	Frequency (MHz)	Meter Reading dB (µV)	Antenna Factor (dB/m)	Cable Loss (dB)	Preamp Factor (dB)	Emission Level dB (µV/m)	Limits dB (µV/m)	Margin (dB)	Remark
Horizontal	2890	43.8	29.77	5.82	35.39	44	74	30	Peak
	3925	41.86	32.32	6.71	35.02	45.87	74	28.13	Peak
	5302	39.17	34.06	7.94	34.7	46.47	74	27.53	Peak
	6625	38.95	34.69	8.93	34.76	47.81	74	26.19	Peak
	7489	40.55	36.8	9.79	34.8	52.34	74	21.66	Peak
	8785	38.44	38.36	10.64	34.72	52.72	74	21.28	Peak
Vertical	2899	43.42	29.8	5.82	35.38	43.66	74	30.34	Peak
	3961	42.22	32.4	6.75	35.01	46.36	74	27.64	Peak
	4906	40.32	33.6	7.61	34.73	46.8	74	27.2	Peak
	6058	39.45	34.31	8.43	34.71	47.48	74	26.52	Peak
	7462	40.36	36.7	9.69	34.8	51.95	74	22.05	Peak
	8569	37.93	38.54	10.52	34.74	52.25	74	21.75	Peak

802.11b CH2437MHz

Polarization	Frequency (MHz)	Meter Reading dB (µV)	Antenna Factor (dB/m)	Cable Loss (dB)	Preamp Factor (dB)	Emission Level dB (µV/m)	Limits dB (µV/m)	Margin (dB)	Remark
Horizontal	2845	43.71	29.64	5.78	35.43	43.7	74	30.3	Peak
	3871	42.07	32.19	6.66	35.03	45.89	74	28.11	Peak
	5086	40.46	34.02	7.78	34.7	47.56	74	26.44	Peak
	6319	39.43	34.36	8.68	34.73	47.74	74	26.26	Peak
	7417	40.52	36.6	9.69	34.8	52.01	74	21.99	Peak
	8749	38.63	38.4	10.58	34.72	52.89	74	21.11	Peak
Vertical	2719	43.41	29.24	5.68	35.54	42.79	74	31.21	Peak
	3808	41.35	32.07	6.62	35.05	44.99	74	29.01	Peak
	4888	39.16	33.55	7.61	34.73	45.59	74	28.41	Peak
	6265	38.37	34.35	8.6	34.73	46.59	74	27.41	Peak
	7471	40.24	36.75	9.69	34.8	51.88	74	22.12	Peak
	8650	38.37	38.48	10.52	34.73	52.64	74	21.36	Peak

802.11b CH2462MHz

Polarization	Frequency (MHz)	Meter Reading dB (μ V)	Antenna Factor (dB/m)	Cable Loss (dB)	Preamp Factor (dB)	Emission Level dB (μ V/m)	Limits dB (μ V/m)	Margin (dB)	Remark
Horizontal	2800	43.74	29.49	5.74	35.47	43.5	74	30.5	Peak
	3817	41.36	32.07	6.62	35.05	45	74	29	Peak
	5113	39.41	34.02	7.78	34.7	46.51	74	27.49	Peak
	6607	39.09	34.64	8.93	34.76	47.9	74	26.1	Peak
	7570	40.03	36.92	9.79	34.8	51.94	74	22.06	Peak
	8722	38.62	38.42	10.58	34.73	52.89	74	21.11	Peak
Vertical	2755	43.63	29.36	5.71	35.51	43.19	74	30.81	Peak
	3853	41.47	32.17	6.66	35.04	45.26	74	28.74	Peak
	4816	40.07	33.26	7.55	34.75	46.13	74	27.87	Peak
	6067	39.11	34.31	8.43	34.71	47.14	74	26.86	Peak
	7570	39.6	36.92	9.79	34.8	51.51	74	22.49	Peak
	8821	38.38	38.34	10.64	34.72	52.64	74	21.36	Peak

802.11g CH2412MHz

Polarization	Frequency (MHz)	Meter Reading dB (μ V)	Antenna Factor (dB/m)	Cable Loss (dB)	Preamp Factor (dB)	Emission Level dB (μ V/m)	Limits dB (μ V/m)	Margin (dB)	Remark
Horizontal	2971	43.13	30.02	5.89	35.32	43.72	74	30.28	Peak
	4240	40.28	32.2	6.99	34.92	44.55	74	29.45	Peak
	5878	38.97	34.25	8.3	34.7	46.82	74	27.18	Peak
	6832	39.53	35.22	9.09	34.78	49.06	74	24.94	Peak
	7903	39.53	37.54	10.11	34.8	52.38	74	21.62	Peak
	9163	38.69	38.23	10.79	34.68	53.03	74	20.97	Peak
Vertical	2638	43.98	28.98	5.61	35.62	42.95	74	31.05	Peak
	3799	41.75	32.04	6.62	35.05	45.36	74	28.64	Peak
	5113	39.67	34.02	7.78	34.7	46.77	74	27.23	Peak
	6517	38.63	34.45	8.85	34.75	47.18	74	26.82	Peak
	7714	40.21	37.21	10.01	34.8	52.63	74	21.37	Peak
	8875	39	38.3	10.64	34.71	53.23	74	20.77	Peak

802.11n20 CH2412MHz

Polarization	Frequency (MHz)	Meter Reading dB (µV)	Antenna Factor (dB/m)	Cable Loss (dB)	Preamplifier Factor (dB)	Emission Level dB (µV/m)	Limits dB (µV/m)	Margin (dB)	Remark
Horizontal	2953	43.36	29.97	5.85	35.34	43.84	74	30.16	Peak
	3871	40.7	32.19	6.66	35.03	44.52	74	29.48	Peak
	5158	39.38	34.03	7.83	34.7	46.54	74	27.46	Peak
	6571	38.23	34.54	8.93	34.76	46.94	74	27.06	Peak
	7561	39.77	36.92	9.79	34.8	51.68	74	22.32	Peak
	8929	38.74	38.26	10.7	34.71	52.99	74	21.01	Peak
Vertical	2737	43.64	29.29	5.68	35.53	43.08	74	30.92	Peak
	3925	41.9	32.32	6.71	35.02	45.91	74	28.09	Peak
	5131	39.94	34.03	7.78	34.7	47.05	74	26.95	Peak
	6589	39.54	34.59	8.93	34.76	48.3	74	25.7	Peak
	7741	39.95	37.25	10.01	34.8	52.41	74	21.59	Peak
	9037	38.63	38.21	10.79	34.69	52.94	74	21.06	Peak

TEST ENGINEER: Jarey

Band-Edge:

EUT : CYNC Direct Connected Indoor Premium Light strip (16ft.) Temperature : 22°C

Model No. : CLEDSTR24CDIDP Humidity : 51%RH

Test Mode : Transmitting Date of Test : 2022.02.15

802.11b CH2412MHz

Polarization	Frequency (MHz)	Meter Reading dB (μV)	Antenna Factor (dB/m)	Cable Loss (dB)	Preamp Factor (dB)	Emission Level dB (μV/m)	Limits dB (μV/m)	Margin (dB)	Remark
Horizontal	2390	55.05	28.21	5.36	35.86	52.76	74	21.24	Peak
	2390	43.13	28.21	5.36	35.86	40.84	54	13.16	Average
Vertical	2390	49.33	28.21	5.36	35.86	47.04	74	26.96	Peak
	2390	37.13	28.21	5.36	35.86	34.84	54	19.16	Average

802.11b CH2462MHz

Polarization	Frequency (MHz)	Meter Reading dB (μV)	Antenna Factor (dB/m)	Cable Loss (dB)	Preamp Factor (dB)	Emission Level dB (μV/m)	Limits dB (μV/m)	Margin (dB)	Remark
Horizontal	2483.5	54.97	28.46	5.43	35.76	53.1	74	20.9	Peak
	2483.5	45.84	28.46	5.43	35.76	43.97	54	10.03	Average
Vertical	2483.5	49.49	28.46	5.43	35.76	47.62	74	26.38	Peak
	2483.5	37.38	28.46	5.43	35.76	35.51	54	18.49	Average

802.11g CH2412MHz

Polarization	Frequency (MHz)	Meter Reading dB (μV)	Antenna Factor (dB/m)	Cable Loss (dB)	Preamp Factor (dB)	Emission Level dB (μV/m)	Limits dB (μV/m)	Margin (dB)	Remark
Horizontal	2390	61.29	28.21	5.36	35.86	59	74	15	Peak
	2390	46.47	28.21	5.36	35.86	44.18	54	9.82	Average
Vertical	2390	49.85	28.21	5.36	35.86	47.56	74	26.44	Peak
	2390	38.02	28.21	5.36	35.86	35.73	54	18.27	Average

802.11g CH2462MHz

Polarization	Frequency (MHz)	Meter Reading dB (μV)	Antenna Factor (dB/m)	Cable Loss (dB)	Preamp Factor (dB)	Emission Level dB (μV/m)	Limits dB (μV/m)	Margin (dB)	Remark
Horizontal	2483.5	55.76	28.46	5.43	35.76	53.89	74	20.11	Peak
	2483.5	44.15	28.46	5.43	35.76	42.28	54	11.72	Average
Vertical	2483.5	49.38	28.46	5.43	35.76	47.51	74	26.49	Peak
	2483.5	37.16	28.46	5.43	35.76	35.29	54	18.71	Average

802.11n20 CH2412MHz

Polarization	Frequency (MHz)	Meter Reading dB (μV)	Antenna Factor (dB/m)	Cable Loss (dB)	Preamp Factor (dB)	Emission Level dB (μV/m)	Limits dB (μV/m)	Margin (dB)	Remark
Horizontal	2390	62.26	28.21	5.36	35.86	59.97	74	14.03	Peak
	2390	46.11	28.21	5.36	35.86	43.82	54	10.18	Average
Vertical	2390	49.32	28.21	5.36	35.86	47.03	74	26.97	Peak
	2390	37.54	28.21	5.36	35.86	35.25	54	18.75	Average

802.11n20 CH2462MHz

Polarization	Frequency (MHz)	Meter Reading dB (μV)	Antenna Factor (dB/m)	Cable Loss (dB)	Preamp Factor (dB)	Emission Level dB (μV/m)	Limits dB (μV/m)	Margin (dB)	Remark
Horizontal	2483.5	57.27	28.46	5.43	35.76	55.4	74	18.6	Peak
	2483.5	45.43	28.46	5.43	35.76	43.56	54	10.44	Average
Vertical	2483.5	50.52	28.46	5.43	35.76	48.65	74	25.35	Peak
	2483.5	37.47	28.46	5.43	35.76	35.6	54	18.4	Average

Emissions in restricted frequency bands:

EUT : CYNCR Direct Connected Indoor Premium Light strip (16ft.) Temperature : 22°C

Model No. : CLEDSTR24CDIDP Humidity : 51%RH

Test Mode : Transmitting Date of Test : 2022.02.15

802.11b CH2412MHz

Polarization	Frequency (MHz)	Meter Reading dB (µV)	Antenna Factor (dB/m)	Cable Loss (dB)	Preamp Factor (dB)	Emission Level dB (µV/m)	Limits dB (µV/m)	Margin (dB)	Remark
Horizontal	2338.3	49.39	28.08	5.29	35.92	46.84	74	27.16	Peak
	2338.3	38.54	28.08	5.29	35.92	35.99	54	18.01	Average
	2357.3	50.65	28.14	5.32	35.89	48.22	74	25.78	Peak
	2357.3	39.36	28.14	5.32	35.89	36.93	54	17.07	Average
	2386.5	54.34	28.21	5.36	35.87	52.04	74	21.96	Peak
	2386.5	44.53	28.21	5.36	35.87	42.23	54	11.77	Average
Vertical	2331.6	49.08	28.06	5.29	35.93	46.5	74	27.5	Peak
	2331.6	36.42	28.06	5.29	35.93	33.84	54	20.16	Average
	2355.2	48.75	28.12	5.32	35.9	46.29	74	27.71	Peak
	2355.2	36.38	28.12	5.32	35.9	33.92	54	20.08	Average
	2386.3	48.86	28.21	5.36	35.87	46.56	74	27.44	Peak
	2386.3	37.59	28.21	5.36	35.87	35.29	54	18.71	Average

802.11b CH2447MHz

Polarization	Frequency (MHz)	Meter Reading dB (µV)	Antenna Factor (dB/m)	Cable Loss (dB)	Preamp Factor (dB)	Emission Level dB (µV/m)	Limits dB (µV/m)	Margin (dB)	Remark
Horizontal	2487.3	52.16	28.46	5.47	35.76	50.33	74	23.67	Peak
	2487.3	40.41	28.46	5.47	35.76	38.58	54	15.42	Average
	2495	49.5	28.48	5.47	35.76	47.69	74	26.31	Peak
	2495	40.25	28.48	5.47	35.76	38.44	54	15.56	Average
	2499.6	50.78	28.5	5.47	35.75	49	74	25	Peak
	2499.6	39.18	28.5	5.47	35.75	37.4	54	16.6	Average
Vertical	2488.2	49.76	28.46	5.47	35.76	47.93	74	26.07	Peak
	2488.2	36.37	28.46	5.47	35.76	34.54	54	19.46	Average
	2494.9	48.53	28.48	5.47	35.76	46.72	74	27.28	Peak
	2494.9	36.25	28.48	5.47	35.76	34.44	54	19.56	Average
	2497.4	48.38	28.5	5.47	35.76	46.59	74	27.41	Peak
	2497.4	36.54	28.5	5.47	35.76	34.75	54	19.25	Average

802.11b CH2462MHz

Polarization	Frequency (MHz)	Meter Reading dB (μV)	Antenna Factor (dB/m)	Cable Loss (dB)	Preamp Factor (dB)	Emission Level dB (μV/m)	Limits dB (μV/m)	Margin (dB)	Remark
Horizontal	2487.8	56.17	28.46	5.47	35.76	54.34	74	19.66	Peak
	2487.8	47.31	28.46	5.47	35.76	45.48	54	8.52	Average
	2492.4	52.41	28.48	5.47	35.76	50.6	74	23.4	Peak
	2492.4	42.54	28.48	5.47	35.76	40.73	54	13.27	Average
	2497.1	50.88	28.5	5.47	35.76	49.09	74	24.91	Peak
	2497.1	40.39	28.5	5.47	35.76	38.6	54	15.4	Average
Vertical	2489.3	49.41	28.48	5.47	35.76	47.6	74	26.4	Peak
	2489.3	38.23	28.48	5.47	35.76	36.42	54	17.58	Average
	2494.2	48.56	28.48	5.47	35.76	46.75	74	27.25	Peak
	2494.2	37.46	28.48	5.47	35.76	35.65	54	18.35	Average
	2498.4	48.93	28.5	5.47	35.76	47.14	74	26.86	Peak
	2498.4	37.39	28.5	5.47	35.76	35.6	54	18.4	Average

802.11g CH2412MHz

Polarization	Frequency (MHz)	Meter Reading dB (μV)	Antenna Factor (dB/m)	Cable Loss (dB)	Preamp Factor (dB)	Emission Level dB (μV/m)	Limits dB (μV/m)	Margin (dB)	Remark
Horizontal	2327.9	50.06	28.05	5.29	35.93	47.47	74	26.53	Peak
	2327.9	38.41	28.05	5.29	35.93	35.82	54	18.18	Average
	2355.2	48.72	28.12	5.32	35.9	46.26	74	27.74	Peak
	2355.2	38.27	28.12	5.32	35.9	35.81	54	18.19	Average
	2388.8	60.68	28.21	5.36	35.86	58.39	74	15.61	Peak
	2388.8	45.37	28.21	5.36	35.86	43.08	54	10.92	Average
Vertical	2330	49.21	28.06	5.29	35.93	46.63	74	27.37	Peak
	2330	36.23	28.06	5.29	35.93	33.65	54	20.35	Average
	2358.2	49.12	28.14	5.32	35.89	46.69	74	27.31	Peak
	2358.2	36.21	28.14	5.32	35.89	33.78	54	20.22	Average
	2387.4	49.59	28.21	5.36	35.86	47.3	74	26.7	Peak
	2387.4	37.36	28.21	5.36	35.86	35.07	54	18.93	Average

802.11g CH2447MHz

Polarization	Frequency (MHz)	Meter Reading dB (μV)	Antenna Factor (dB/m)	Cable Loss (dB)	Preamp Factor (dB)	Emission Level dB (μV/m)	Limits dB (μV/m)	Margin (dB)	Remark
Horizontal	2486.6	53.22	28.46	5.47	35.76	51.39	74	22.61	Peak
	2486.6	41.42	28.46	5.47	35.76	39.59	54	14.41	Average
	2490.3	53.17	28.48	5.47	35.76	51.36	74	22.64	Peak
	2490.3	41.21	28.48	5.47	35.76	39.4	54	14.6	Average
	2497.9	50.59	28.5	5.47	35.76	48.8	74	25.2	Peak
	2497.9	39.36	28.5	5.47	35.76	37.57	54	16.43	Average
Vertical	2485.6	48.77	28.46	5.47	35.76	46.94	74	27.06	Peak
	2485.6	37.47	28.46	5.47	35.76	35.64	54	18.36	Average
	2490.9	48.76	28.48	5.47	35.76	46.95	74	27.05	Peak
	2490.9	37.37	28.48	5.47	35.76	35.56	54	18.44	Average
	2496.7	49.27	28.5	5.47	35.76	47.48	74	26.52	Peak
	2496.7	37.23	28.5	5.47	35.76	35.44	54	18.56	Average

802.11g CH2462MHz

Polarization	Frequency (MHz)	Meter Reading dB (μV)	Antenna Factor (dB/m)	Cable Loss (dB)	Preamp Factor (dB)	Emission Level dB (μV/m)	Limits dB (μV/m)	Margin (dB)	Remark
Horizontal	2486.3	55.72	28.46	5.47	35.76	53.89	74	20.11	Peak
	2486.3	43.57	28.46	5.47	35.76	41.74	54	12.26	Average
	2491.9	53.84	28.48	5.47	35.76	52.03	74	21.97	Peak
	2491.9	42.49	28.48	5.47	35.76	40.68	54	13.32	Average
	2497.4	52.18	28.5	5.47	35.76	50.39	74	23.61	Peak
	2497.4	41.32	28.5	5.47	35.76	39.53	54	14.47	Average
Vertical	2487.4	50	28.46	5.47	35.76	48.17	74	25.83	Peak
	2487.4	37.4	28.46	5.47	35.76	35.57	54	18.43	Average
	2491.9	48.41	28.48	5.47	35.76	46.6	74	27.4	Peak
	2491.9	37.24	28.48	5.47	35.76	35.43	54	18.57	Average
	2496.9	49.07	28.5	5.47	35.76	47.28	74	26.72	Peak
	2496.9	37.51	28.5	5.47	35.76	35.72	54	18.28	Average

802.11n20 CH2412MHz

Polarization	Frequency (MHz)	Meter Reading dB (μV)	Antenna Factor (dB/m)	Cable Loss (dB)	Preamp Factor (dB)	Emission Level dB (μV/m)	Limits dB (μV/m)	Margin (dB)	Remark
Horizontal	2335.5	49.7	28.06	5.29	35.92	47.13	74	26.87	Peak
	2335.5	39.48	28.06	5.29	35.92	36.91	54	17.09	Average
	2363.2	49.81	28.15	5.32	35.89	47.39	74	26.61	Peak
	2363.2	38.29	28.15	5.32	35.89	35.87	54	18.13	Average
	2389.2	61.35	28.21	5.36	35.86	59.06	74	14.94	Peak
	2389.2	45.13	28.21	5.36	35.86	42.84	54	11.16	Average
Vertical	2336	48.56	28.08	5.29	35.92	46.01	74	27.99	Peak
	2336	37.46	28.08	5.29	35.92	34.91	54	19.09	Average
	2369	48.65	28.15	5.32	35.89	46.23	74	27.77	Peak
	2369	37.28	28.15	5.32	35.89	34.86	54	19.14	Average
	2388.8	49.28	28.21	5.36	35.86	46.99	74	27.01	Peak
	2388.8	37.63	28.21	5.36	35.86	35.34	54	18.66	Average

802.11n20 CH2447MHz

Polarization	Frequency (MHz)	Meter Reading dB (μV)	Antenna Factor (dB/m)	Cable Loss (dB)	Preamp Factor (dB)	Emission Level dB (μV/m)	Limits dB (μV/m)	Margin (dB)	Remark
Horizontal	2483.9	52.86	28.46	5.43	35.76	50.99	74	23.01	Peak
	2483.9	41.69	28.46	5.43	35.76	39.82	54	14.18	Average
	2489.3	52.77	28.48	5.47	35.76	50.96	74	23.04	Peak
	2489.3	41.27	28.48	5.47	35.76	39.46	54	14.54	Average
	2496.6	50.7	28.5	5.47	35.76	48.91	74	25.09	Peak
	2496.6	39.47	28.5	5.47	35.76	37.68	54	16.32	Average
Vertical	2485.6	48.46	28.46	5.47	35.76	46.63	74	27.37	Peak
	2485.6	37.34	28.46	5.47	35.76	35.51	54	18.49	Average
	2492.1	48.92	28.48	5.47	35.76	47.11	74	26.89	Peak
	2492.1	36.59	28.48	5.47	35.76	34.78	54	19.22	Average
	2498	48.9	28.5	5.47	35.76	47.11	74	26.89	Peak
	2498	36.79	28.5	5.47	35.76	35	54	19	Average

802.11n20 CH2462MHz

Polarization	Frequency (MHz)	Meter Reading dB (μV)	Antenna Factor (dB/m)	Cable Loss (dB)	Preamp Factor (dB)	Emission Level dB (μV/m)	Limits dB (μV/m)	Margin (dB)	Remark
Horizontal	2486.8	55.23	28.46	5.47	35.76	53.4	74	20.6	Peak
	2486.8	43.42	28.46	5.47	35.76	41.59	54	12.41	Average
	2493.1	54.28	28.48	5.47	35.76	52.47	74	21.53	Peak
	2493.1	42.23	28.48	5.47	35.76	40.42	54	13.58	Average
	2498.2	51.99	28.5	5.47	35.76	50.2	74	23.8	Peak
	2498.2	40.6	28.5	5.47	35.76	38.81	54	15.19	Average
Vertical	2485.5	49.25	28.46	5.47	35.76	47.42	74	26.58	Peak
	2485.5	37.42	28.46	5.47	35.76	35.59	54	18.41	Average
	2490.3	49.28	28.48	5.47	35.76	47.47	74	26.53	Peak
	2490.3	38.12	28.48	5.47	35.76	36.31	54	17.69	Average
	2497.9	48.39	28.5	5.47	35.76	46.6	74	27.4	Peak
	2497.9	37.24	28.5	5.47	35.76	35.45	54	18.55	Average

TEST ENGINEER: Jarey

5 99% OCCUPIED BANDWIDTH MEASUREMENT

5.1 Test Equipment

The following test equipment was used during the Emission Bandwidth measurement:

Item	Type	Manufacturer	Model No.	Serial No.	Cal. Date	Cal. Interval
1.	Spectrum Analyzer	Agilent	N9010A	MY52221182	2021.09.15	1 Year
2.	Coaxial Cable	WOKEN	SFL402-105F LEX	F02-150819-045	2021.03.08	1 Year
3.	20 dB Attenuator	Mini-Circuits	VAT-20+	001	2021.08.06	1 Year

5.2 Block Diagram of Test Setup

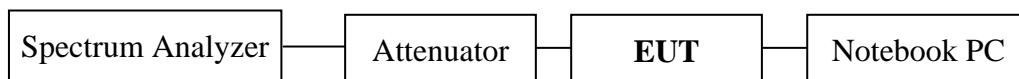

5.3 Operating Condition of EUT

The switch ON/OFF was used to enable the EUT to change the channel one by one.

5.4 Test Procedure

The transmitter output was connected to the spectrum analyzer. The bandwidth of 99% power bandwidth was measure by spectrum analyzer with settings: Span = between 1.5 times and 5.0 times of the OBW, RBW = 1% to 5% of the OBW, VBW $\geq 3 \times$ RBW, Detector = Peak, Trace = Max Hold.

Use the 99% power bandwidth function of the instrument and report the measured bandwidth.

The test procedure is defined in ANSI C63.10-2013 (the 6.9.3 Measurement Procedure “Occupied bandwidth—power bandwidth (99%) measurement procedure” was used).

5.5 Test Results

PASSED.

All the test results are attached in next pages.

(Test Date: 2022.02.15 Temperature: 23°C Humidity: 51 %)

Modulation	Channel	Frequency (MHz)	99% Bandwidth (MHz)
802.11b	1	2412	14.04
	6	2437	14.028
	11	2462	14.046
802.11g	1	2412	17.293
	6	2437	17.293
	11	2462	17.156
802.11n20	1	2412	18.24
	6	2437	18.267
	11	2462	18.16

802.11b CH2412MHz

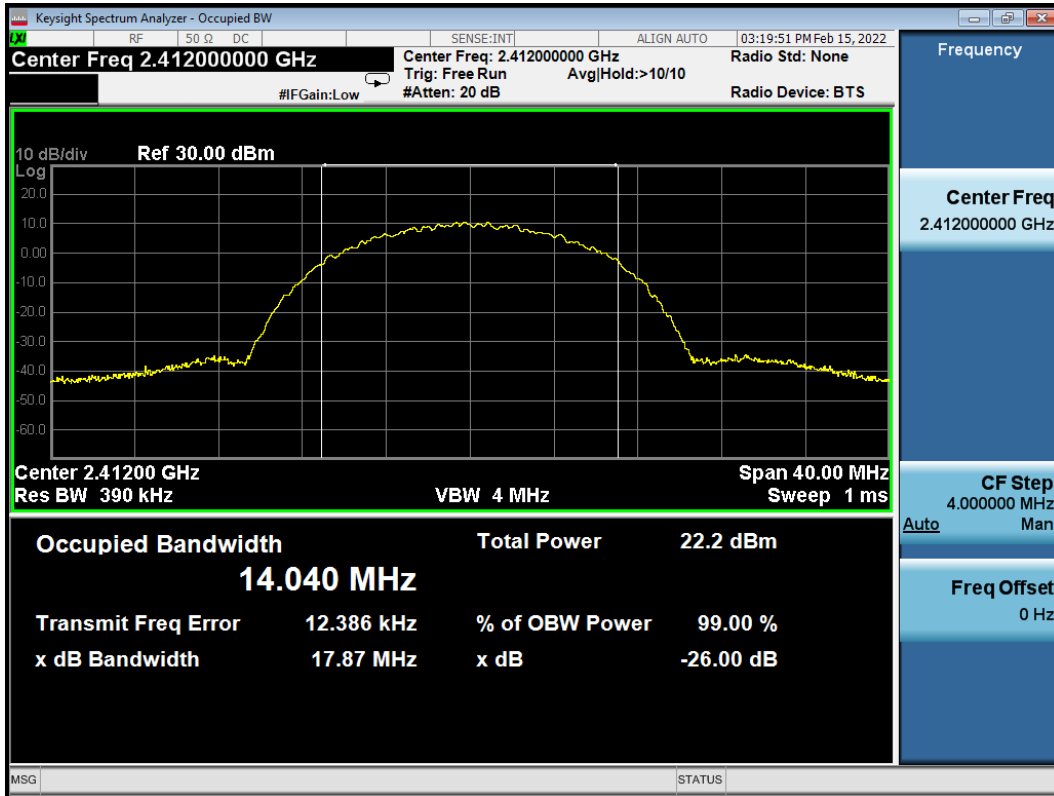

802.11b CH2437MHz

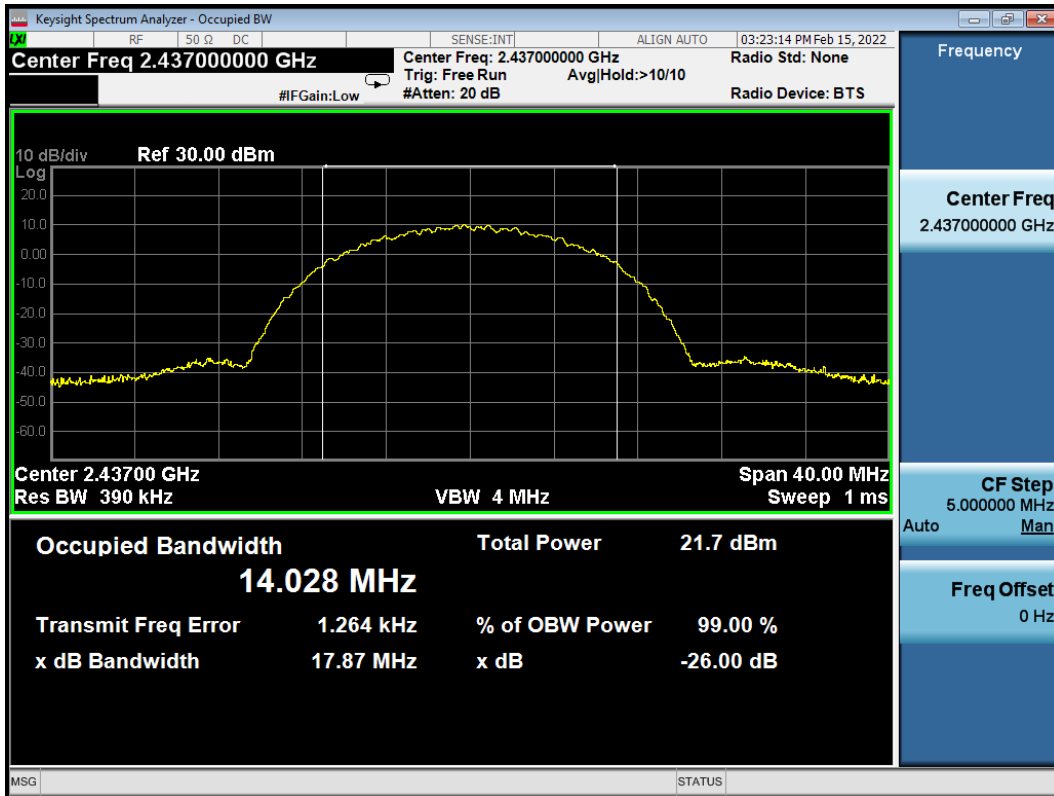

802.11b CH2462MHz

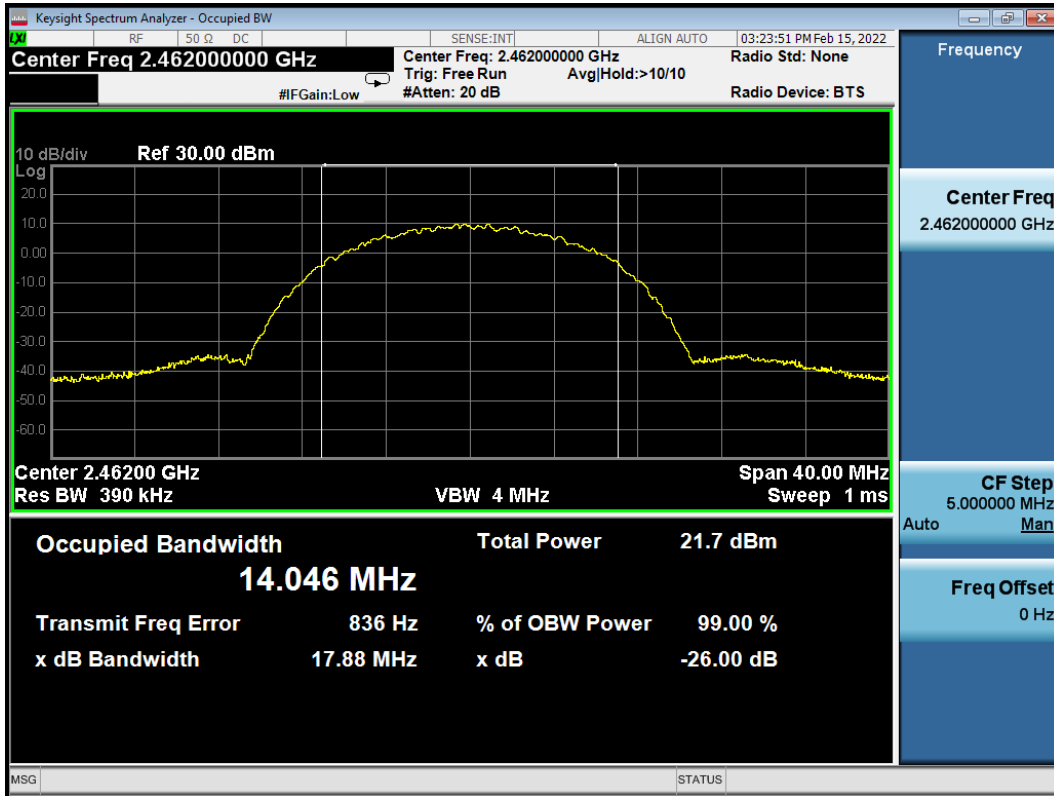

802.11g CH2412MHz

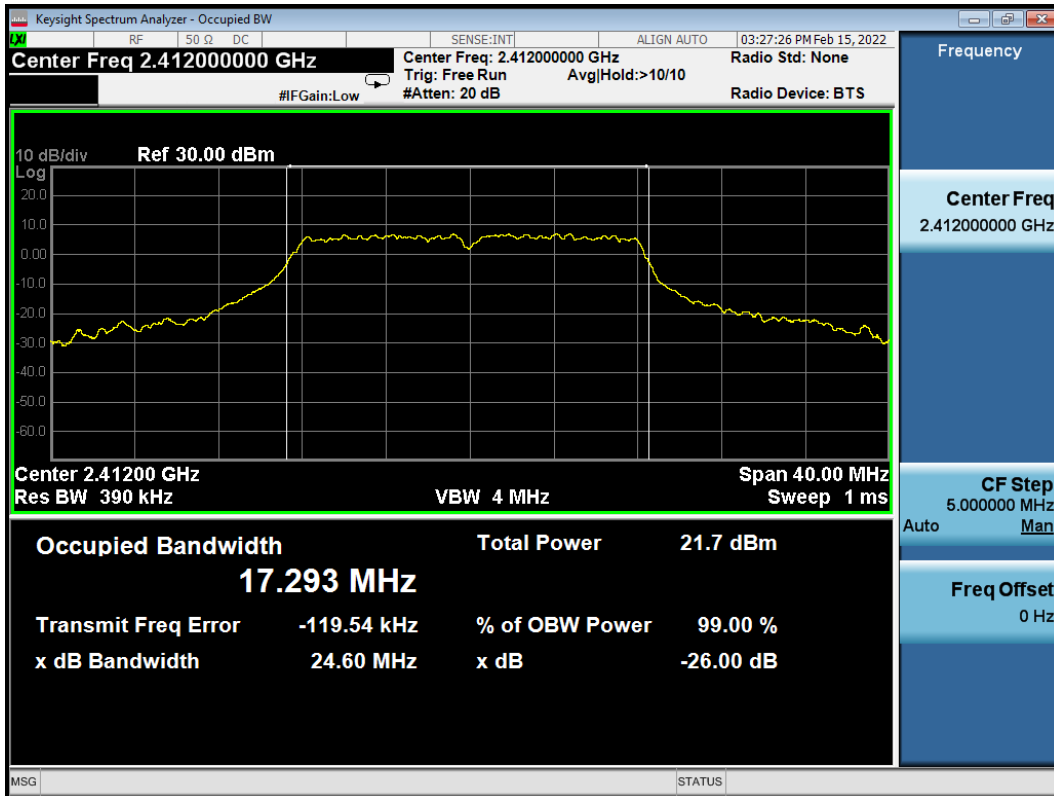

802.11g CH2437MHz

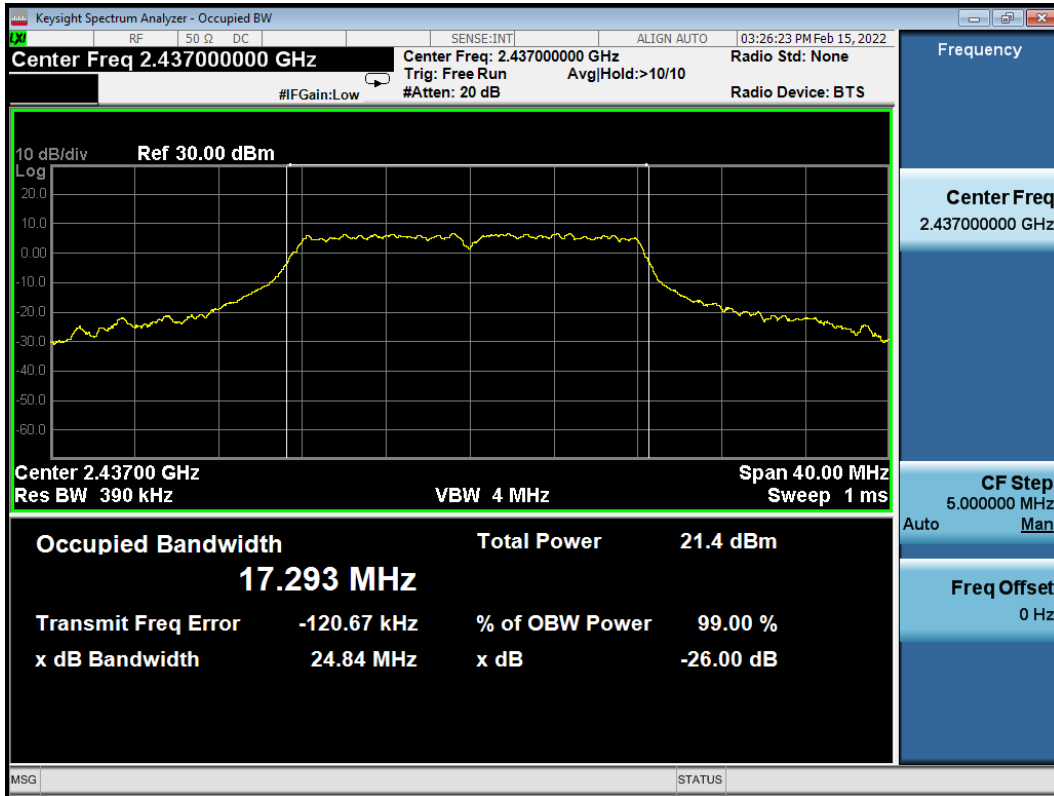

802.11g CH2462MHz

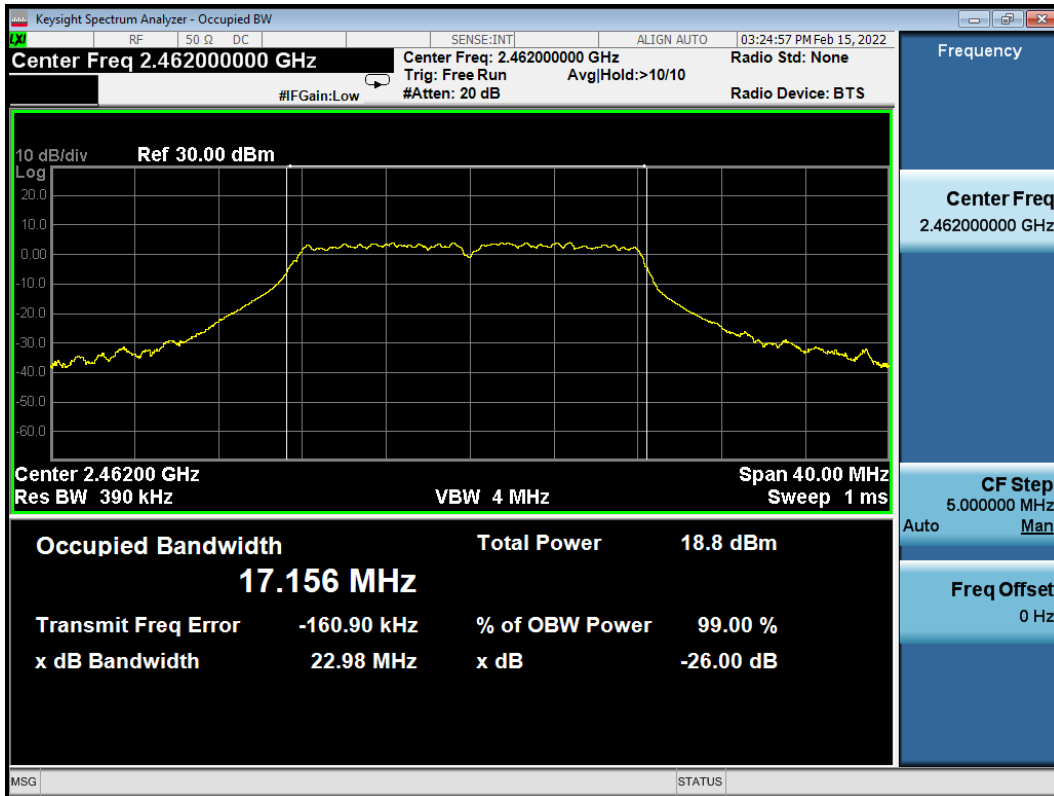

802.11n20 CH2412MHz

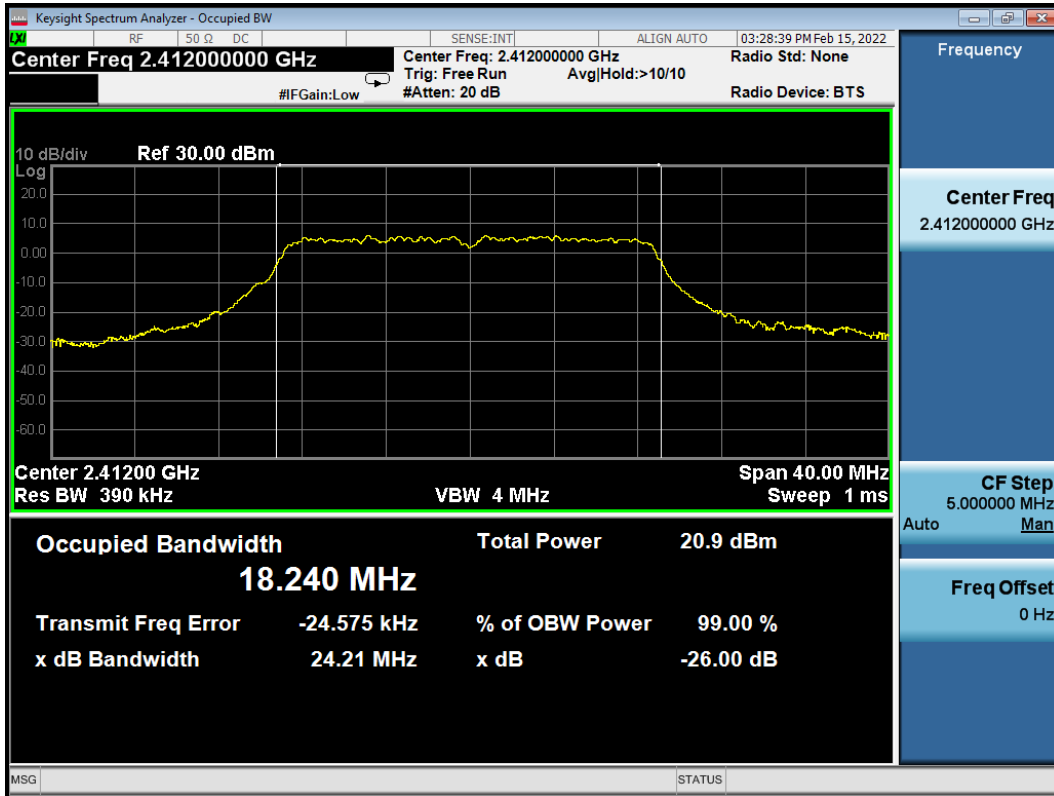

802.11n20 CH2437MHz

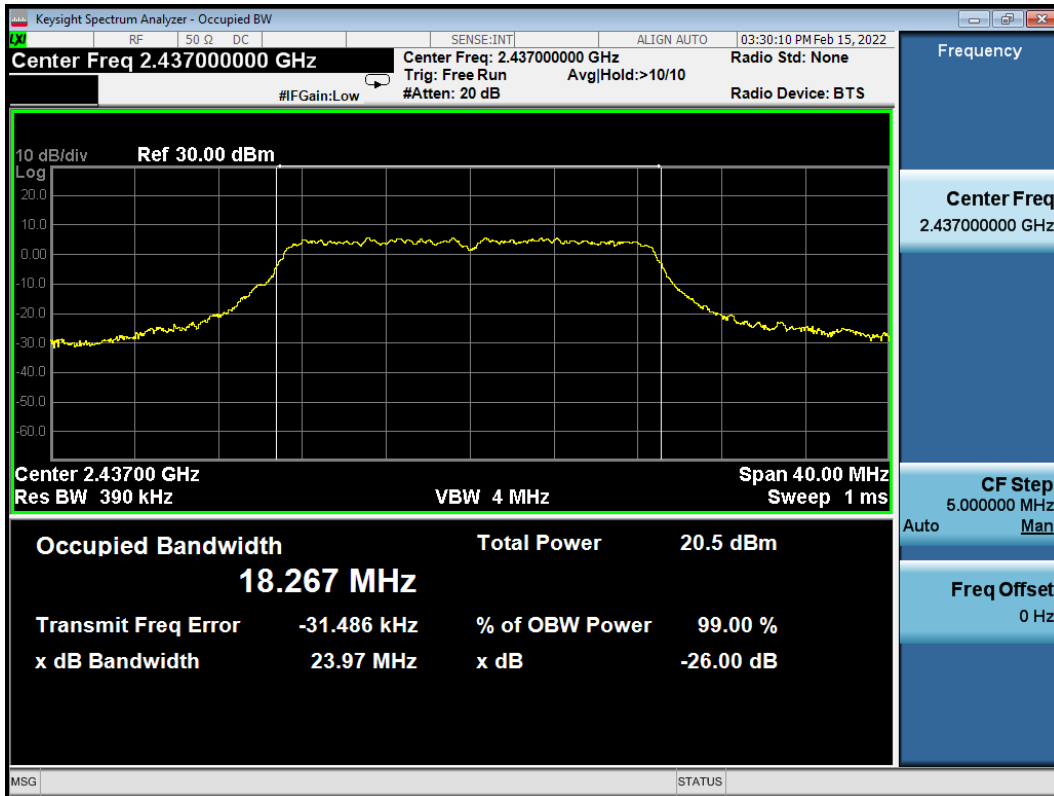

802.11n20 CH2462MHz

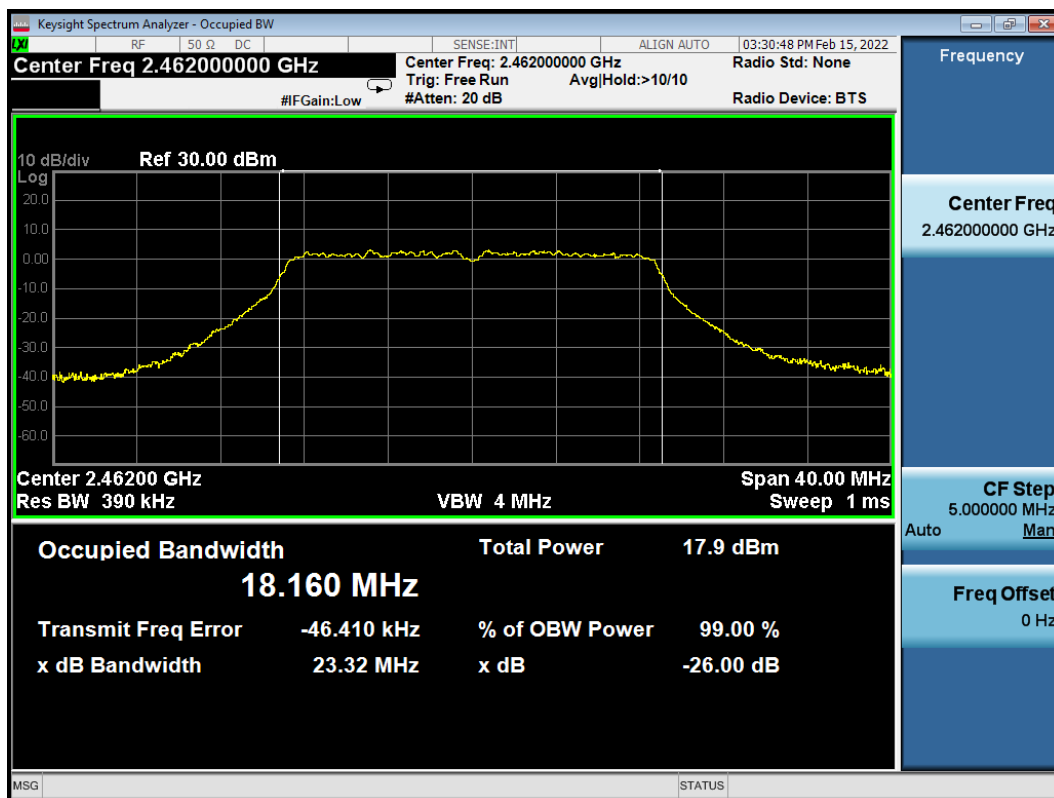

6 6 dB BANDWIDTH MEASUREMENT

6.1 Test Equipment

The following test equipment was used during the Emission Bandwidth measurement:

Item	Type	Manufacturer	Model No.	Serial No.	Cal. Date	Cal. Interval
1.	Spectrum Analyzer	Agilent	N9010A	MY52221182	2021.09.15	1 Year
2.	Coaxial Cable	WOKEN	SFL402-105F LEX	F02-150819-045	2021.03.08	1 Year
3.	20 dB Attenuator	Mini-Circuits	VAT-20+	001	2021.08.06	1 Year

6.2 Block Diagram of Test Setup

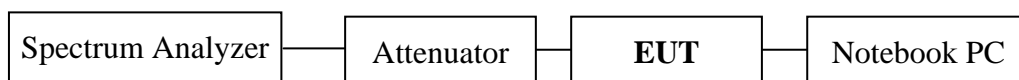

6.3 Specification Limits (§15.247(a)(2))

The minimum 6 dB bandwidth shall be at least 500 kHz.

6.4 Operating Condition of EUT

The switch ON/OFF was used to enable the EUT to change the channel one by one.

6.5 Test Procedure

The transmitter output was connected to the spectrum analyzer. The bandwidth of the fundamental frequency was measure by spectrum analyzer with settings: RBW = 100kHz, VBW $\geq 3 \times$ RBW.

The 6 dB bandwidth is defined as the total spectrum the power of which is lower than peak power minus 6 dB .

The test procedure is defined in ANSI C63.10-2013 (the 11.8.2 Measurement Procedure “Option 2” was used).

6.6 Test Results

PASSED.

All the test results are attached in next pages.

(Test Date: 2022.01.19 Temperature: 23°C Humidity: 51 %)

Modulation	Channel	Frequency (MHz)	6dB Bandwidth (MHz)	Limit
802.11b	1	2412	7.925	500 kHz
	6	2437	7.916	500 kHz
	11	2462	7.915	500 kHz
802.11g	1	2412	16.54	500 kHz
	6	2437	16.54	500 kHz
	11	2462	16.54	500 kHz
802.11n20	1	2412	17.78	500 kHz
	6	2437	17.76	500 kHz
	11	2462	17.76	500 kHz

802.11b CH2412MHz

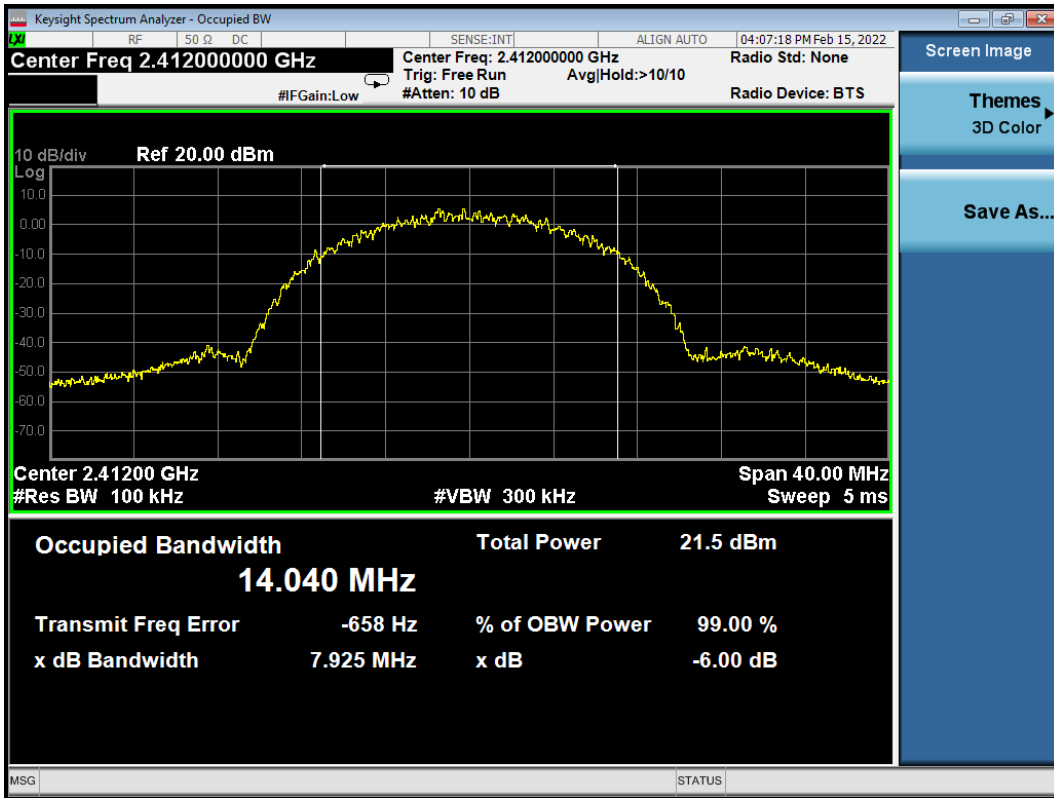

802.11b CH2437MHz

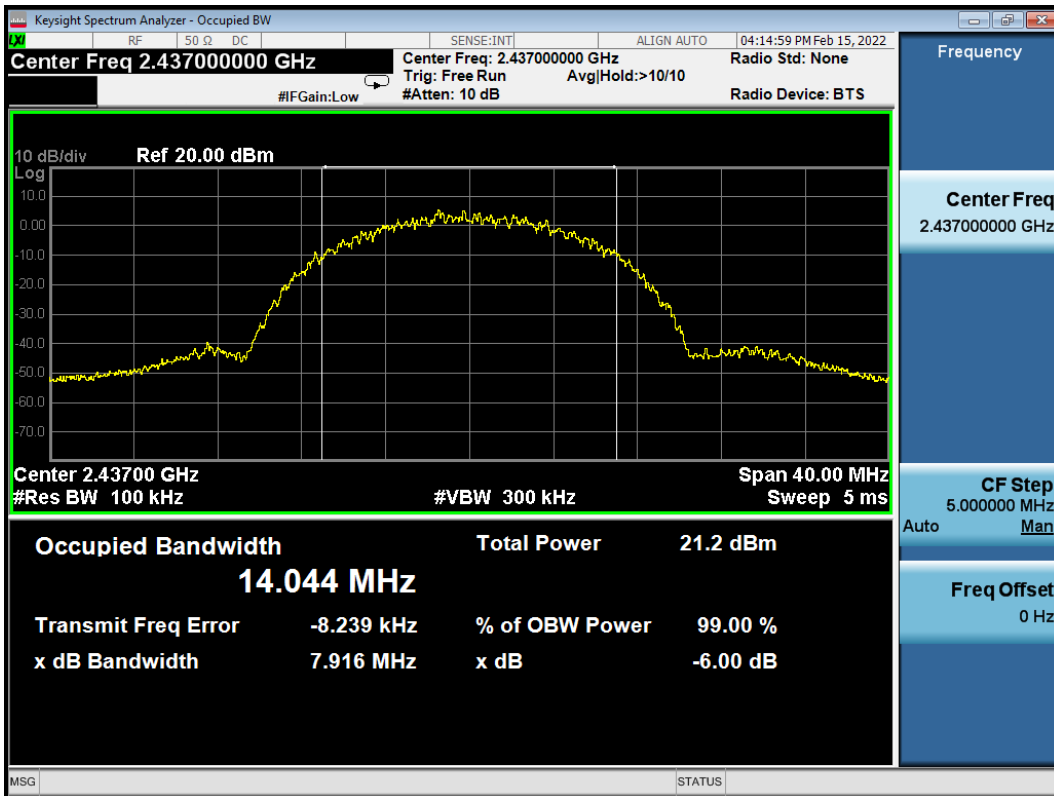

802.11b CH2462MHz



802.11g CH2412MHz

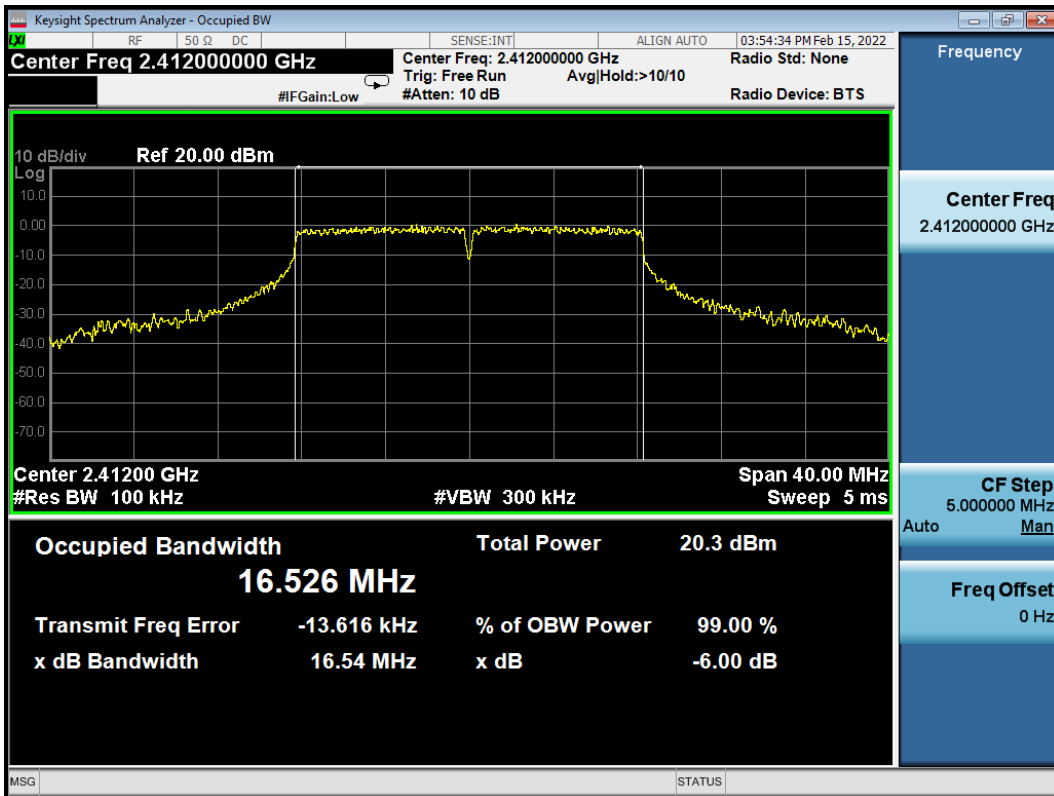

802.11g CH2437MHz

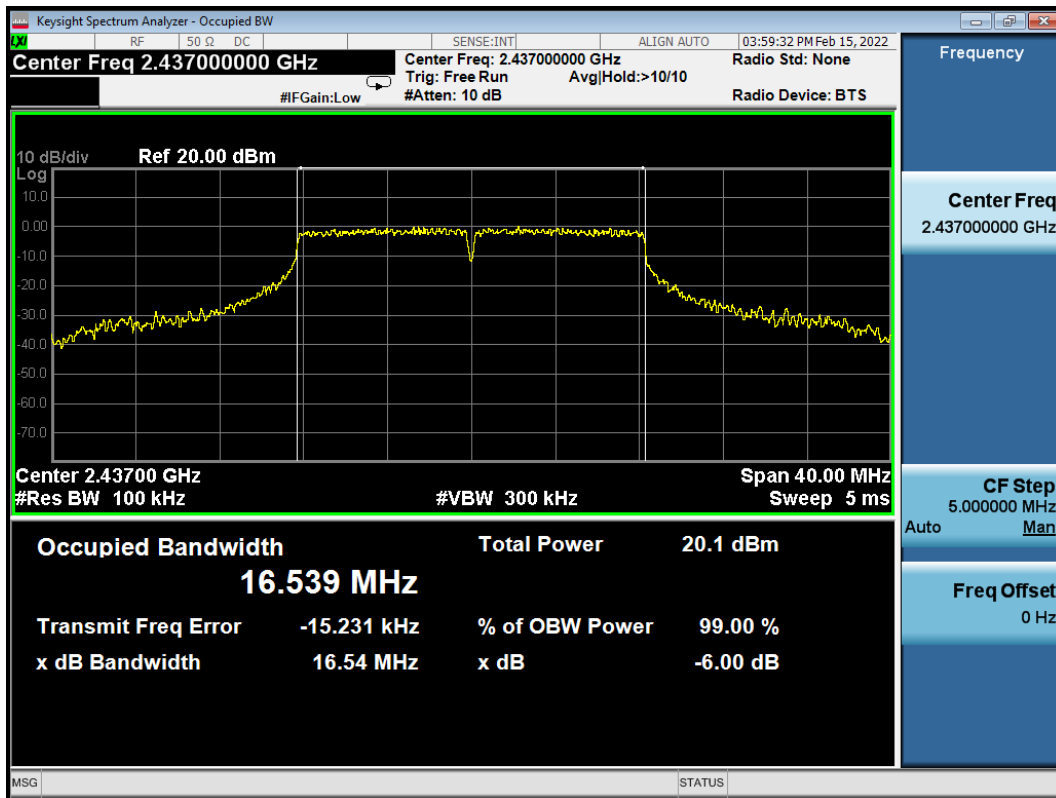

802.11g CH2462MHz

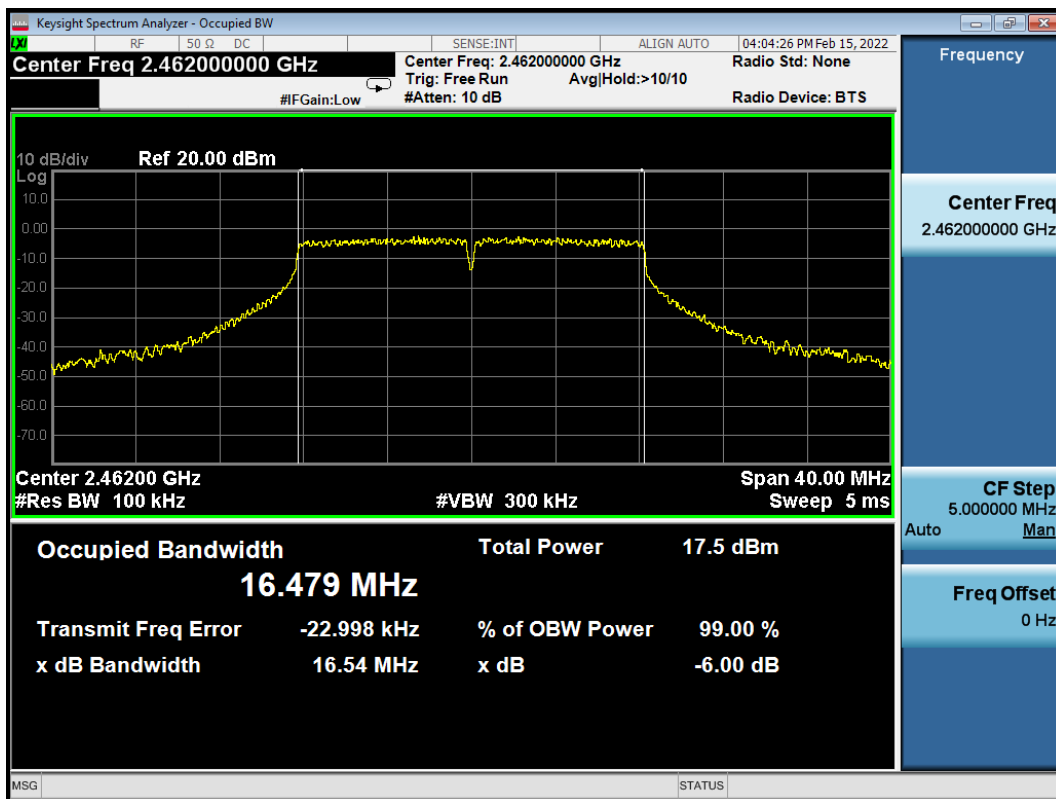

802.11n20 CH2412MHz

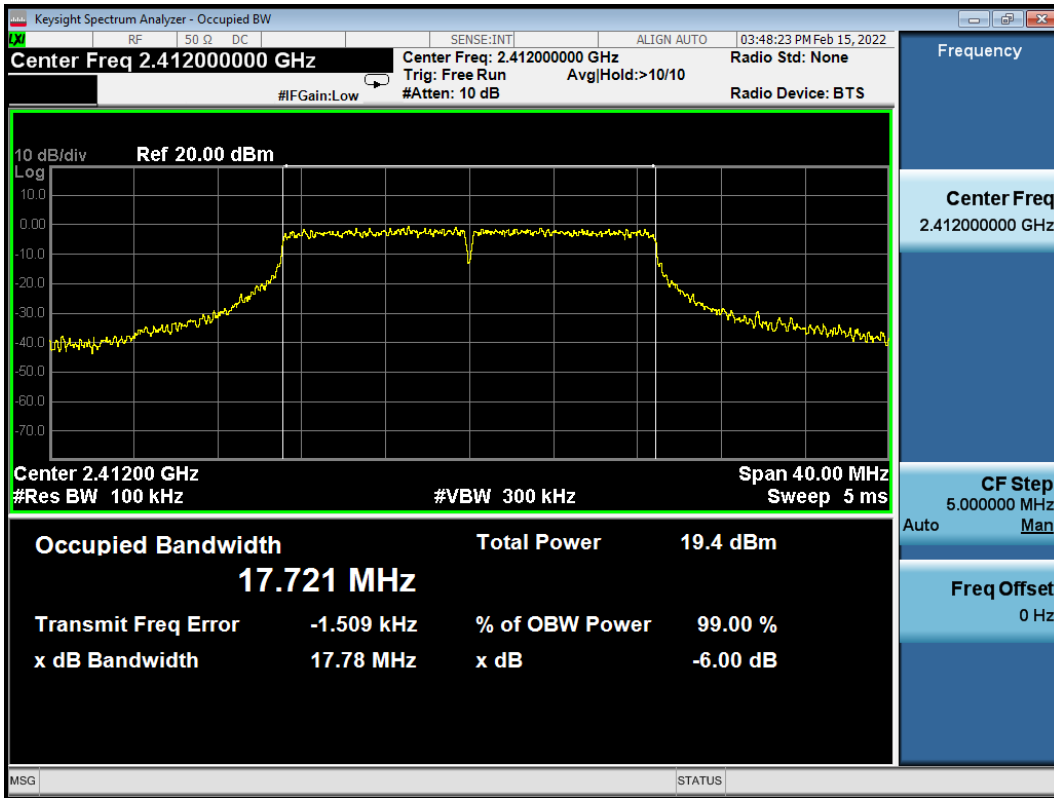

802.11n20 CH2437MHz

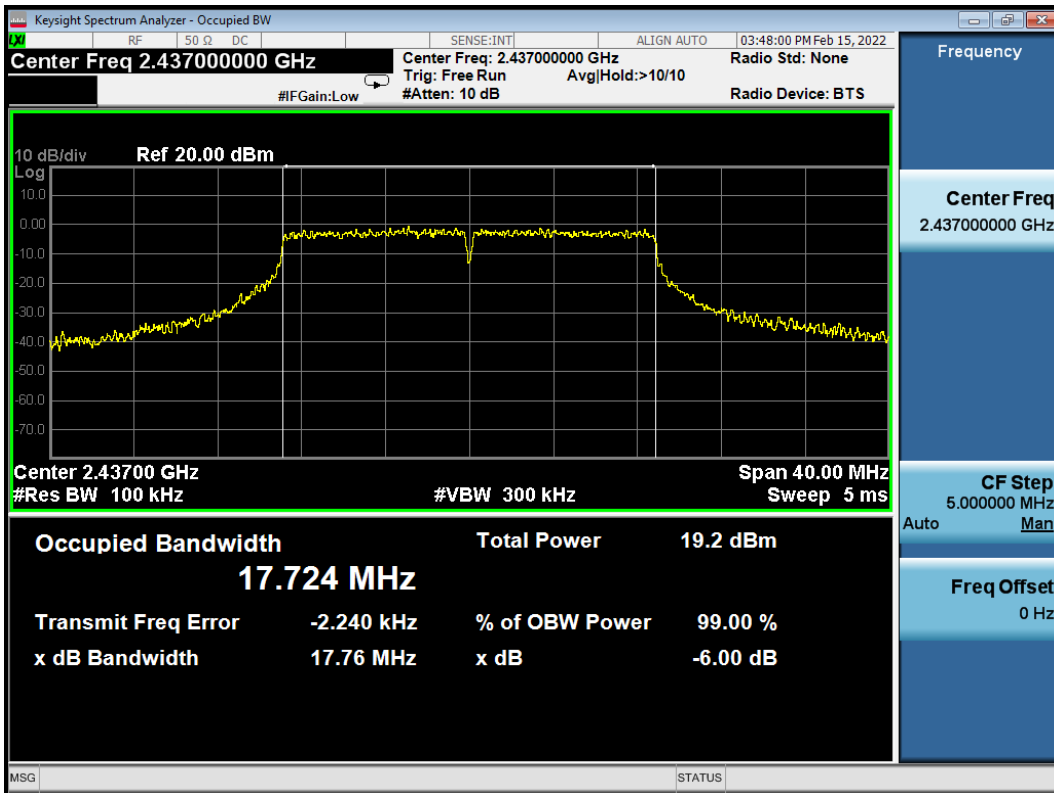

802.11n20 CH2462MHz

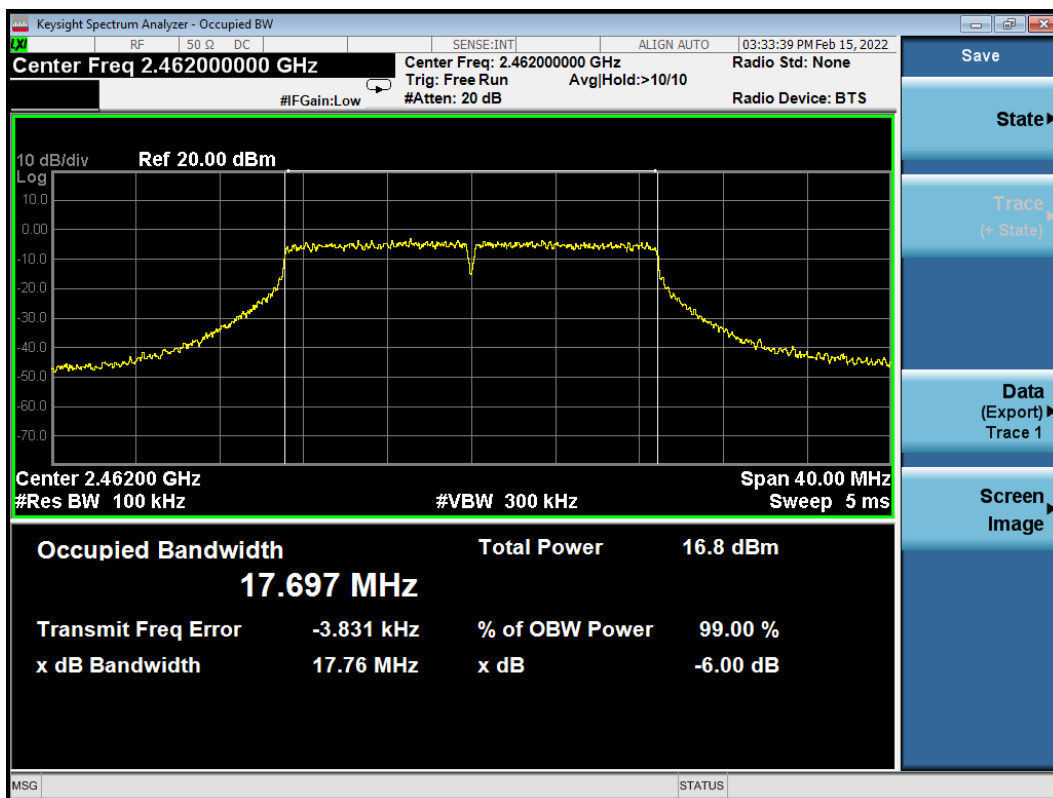

7 MAXIMUM PEAK OUTPUT POWER MEASUREMENT

7.1 Test Equipment

The following test equipment was used during the maximum peak output power measurement:

Item	Type	Manufacturer	Model No.	Serial No.	Cal. Date	Cal. Interval
1.	Spectrum Analyzer	Agilent	N9010A	MY52221182	2021.09.15	1 Year
2.	Coaxial Cable	WOKEN	SFL402-105F LEX	F02-150819-0 45	2021.03.08	1 Year
3.	20 dB Attenuator	Mini-Circuits	VAT-20+	001	2021.08.06	1 Year

7.2 Block Diagram of Test Setup

The Same as Section. 5.2.

7.3 Specification Limits ((§15.247(b)(3))

The Limits of maximum Peak Output Power for digital modulation in 2400-2483.5 MHz is: 1 Watt. (30 dBm)

7.4 Operating Condition of EUT

The switch ON/OFF was used to enable the EUT to change the channel one by one.

7.5 Test Procedure

The transmitter output was connected to the spectrum analyzer.

Method AVGSA-1 uses trace averaging with the EUT transmitting at full power throughout each sweep.

The procedure for this method is as follows:

- a) Set span to at least 1.5 times the OBW.
- b) Set RBW = 1% to 5% of the OBW, not to exceed 1 MHz.
- c) Set VBW $\geq [3 \times \text{RBW}]$.
- d) Number of points in sweep $\geq [2 \times \text{span} / \text{RBW}]$. (This gives bin-to-bin spacing $\leq \text{RBW} / 2$, so that narrowband signals are not lost between frequency bins.)
- e) Sweep time = auto.
- f) Detector = RMS (i.e., power averaging), if available. Otherwise, use sample detector mode.
- g) If transmit duty cycle $< 98\%$, use a sweep trigger with the level set to enable triggering only on full power pulses. The transmitter shall operate at the maximum power control level for the entire duration of every sweep. If the EUT transmits continuously (i.e., with no OFF intervals) or at duty cycle $\geq 98\%$, and if each transmission is entirely at the maximum power control level, then the trigger shall be set to “free run.”
- h) Trace average at least 100 traces in power averaging (rms) mode.
- i) Compute power by integrating the spectrum across the OBW of the signal using the instrument’s band power measurement function, with band limits set equal to the OBW band edges. If the instrument does not have a band power

function, sum the spectrum levels (in power units) at intervals equal to the RBW extending across the entire OBW of the spectrum.

The test procedure is defined in ANSI C63.10-2013 (11.9.2.2.2 Measurement Procedure “ Method AVGSA-1” was used).

7.6 Test Results

PASSED.

All the test results are listed below.

(Test Date: 2022.02.15 Temperature: 23°C Humidity: 51 %)

Modulation	Channel	Frequency (MHz)	Peak Output Power (dBm)	Limit
802.11b	1	2412	15.91	30 dBm
	6	2437	15.59	30 dBm
	11	2462	15.45	30 dBm
802.11g	1	2412	15.45	30 dBm
	6	2437	15.23	30 dBm
	11	2462	12.57	30 dBm
802.11n20	1	2412	14.54	30 dBm
	6	2437	14.29	30 dBm
	11	2462	11.63	30 dBm

802.11b CH2412MHz

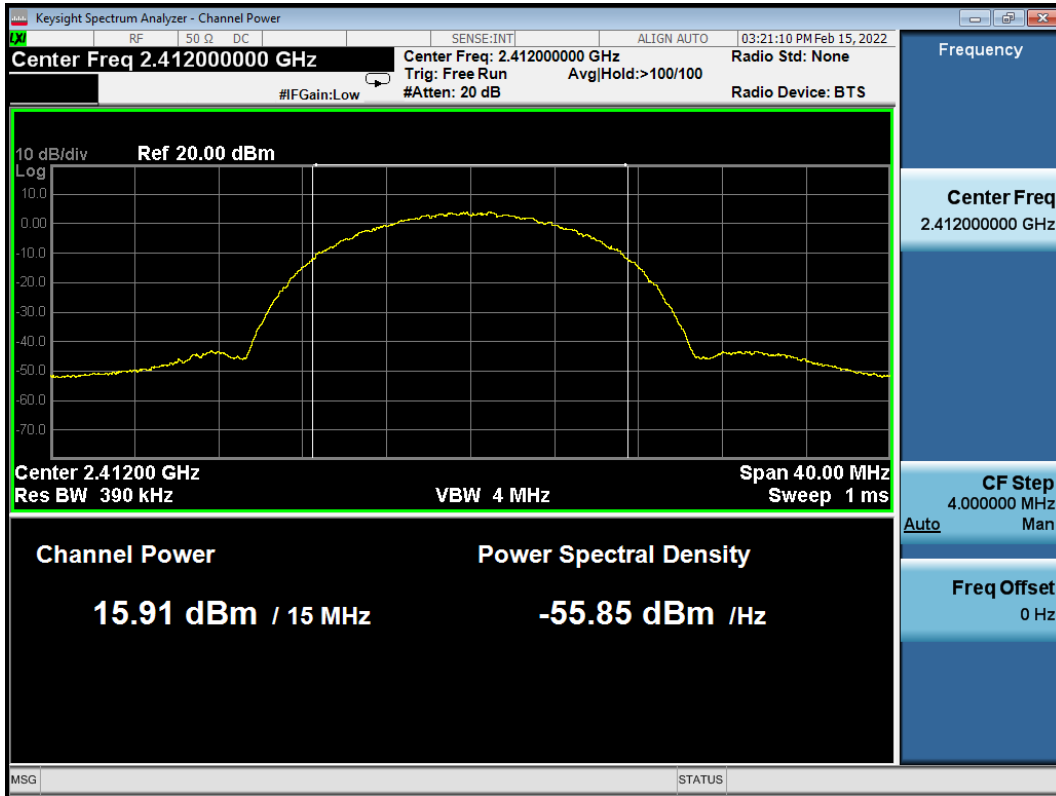

802.11b CH2437MHz

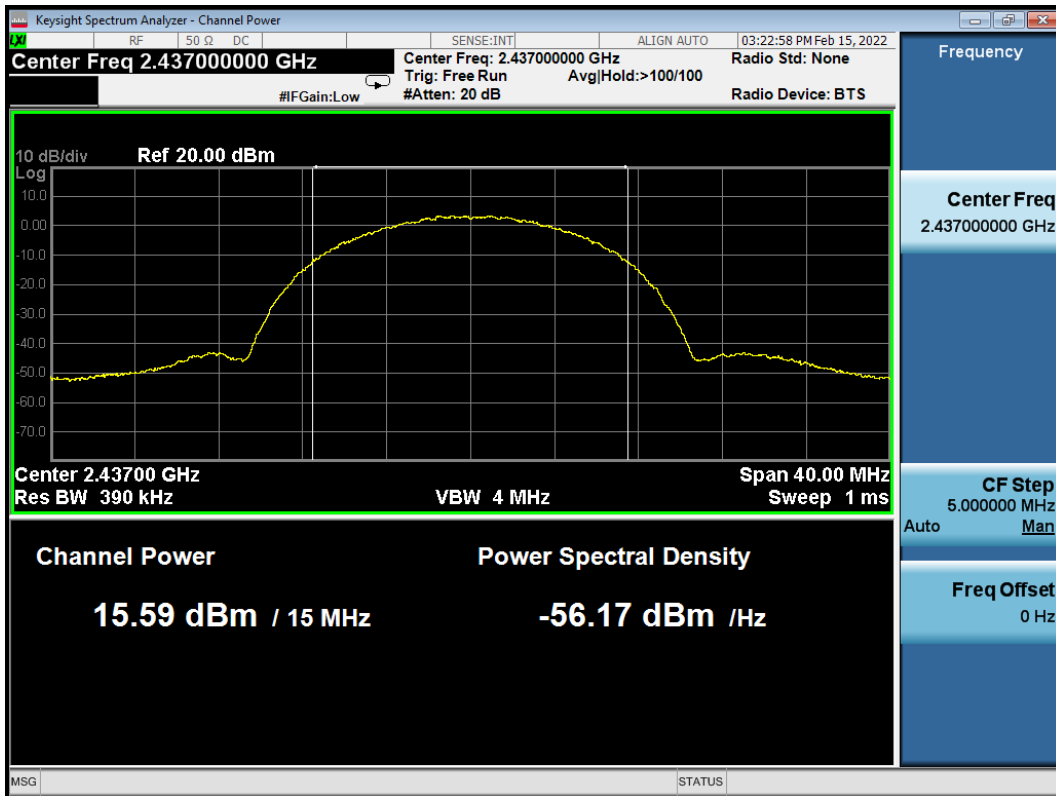

802.11b CH2462MHz

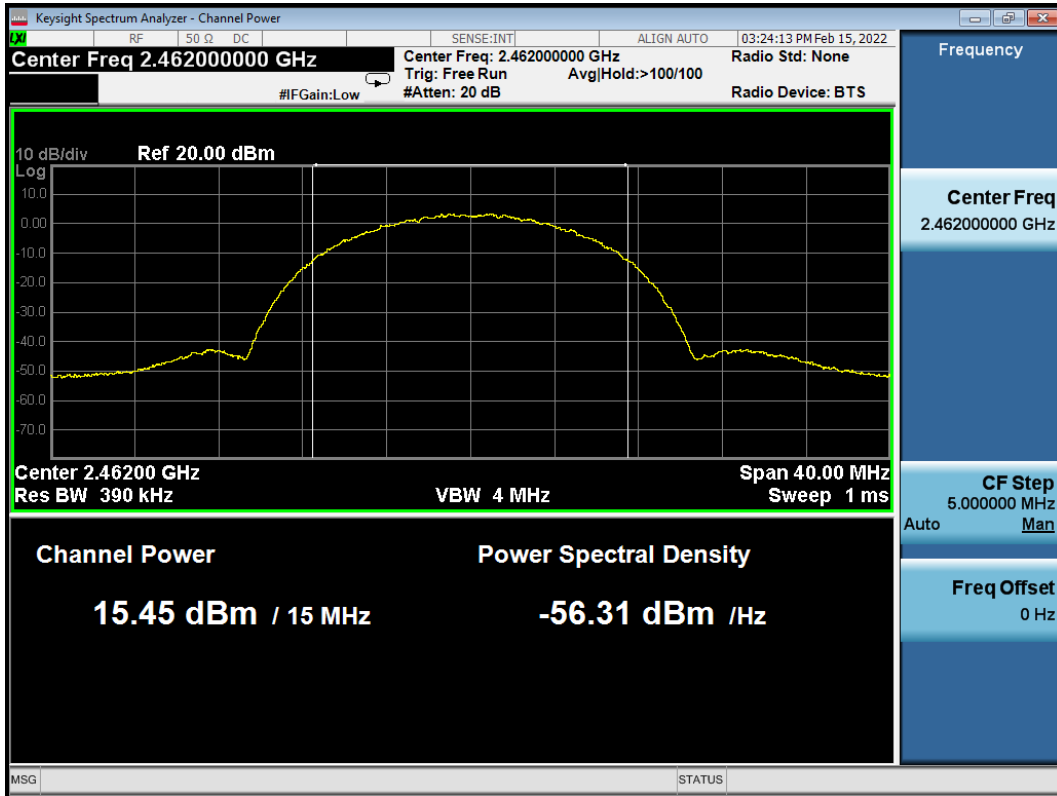

802.11g CH2412MHz

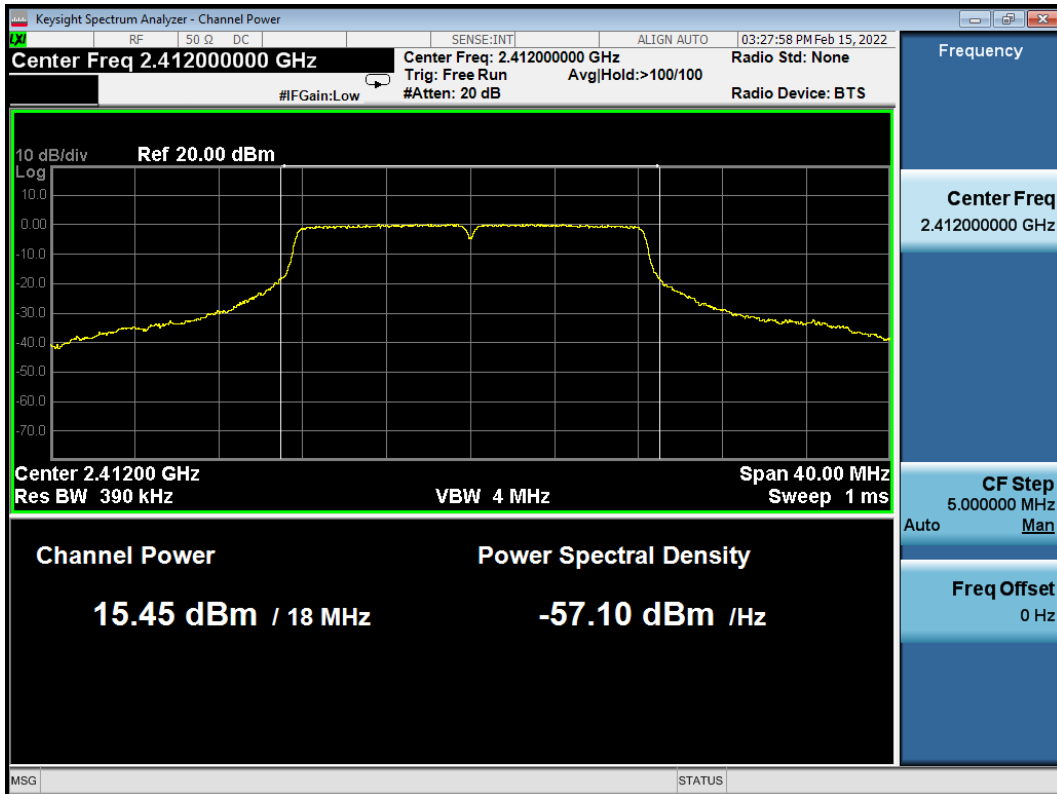

802.11g CH2437MHz

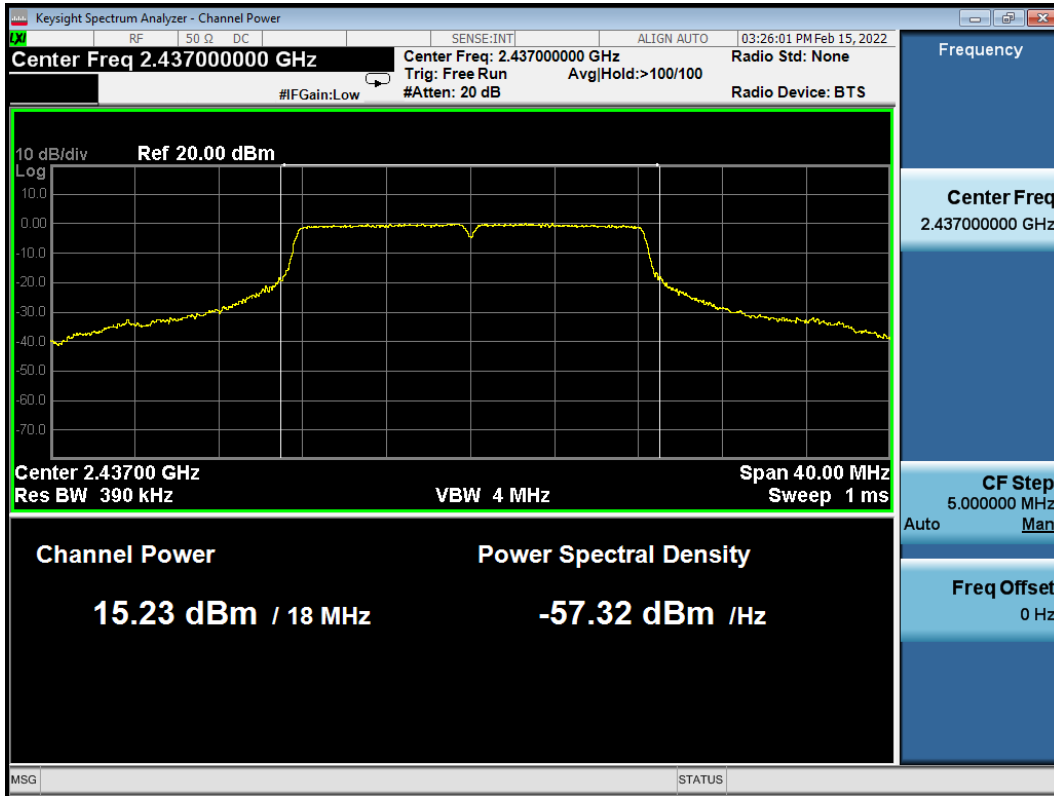

802.11g CH2462MHz

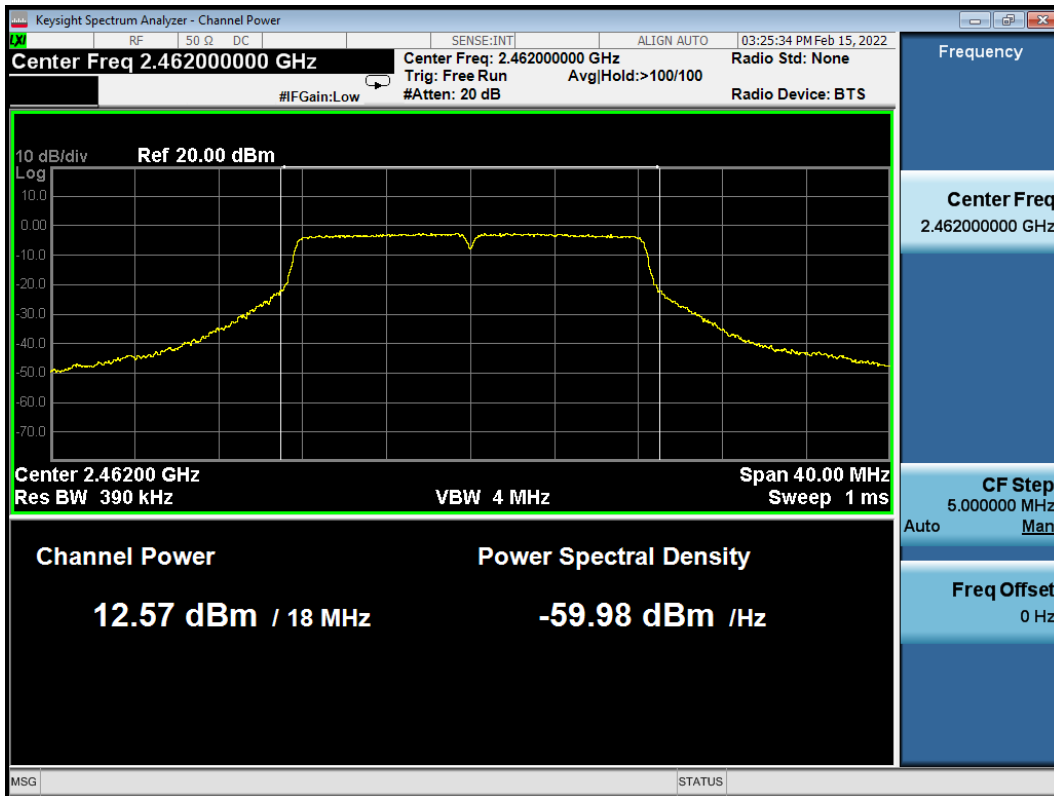

802.11n20 CH2412MHz

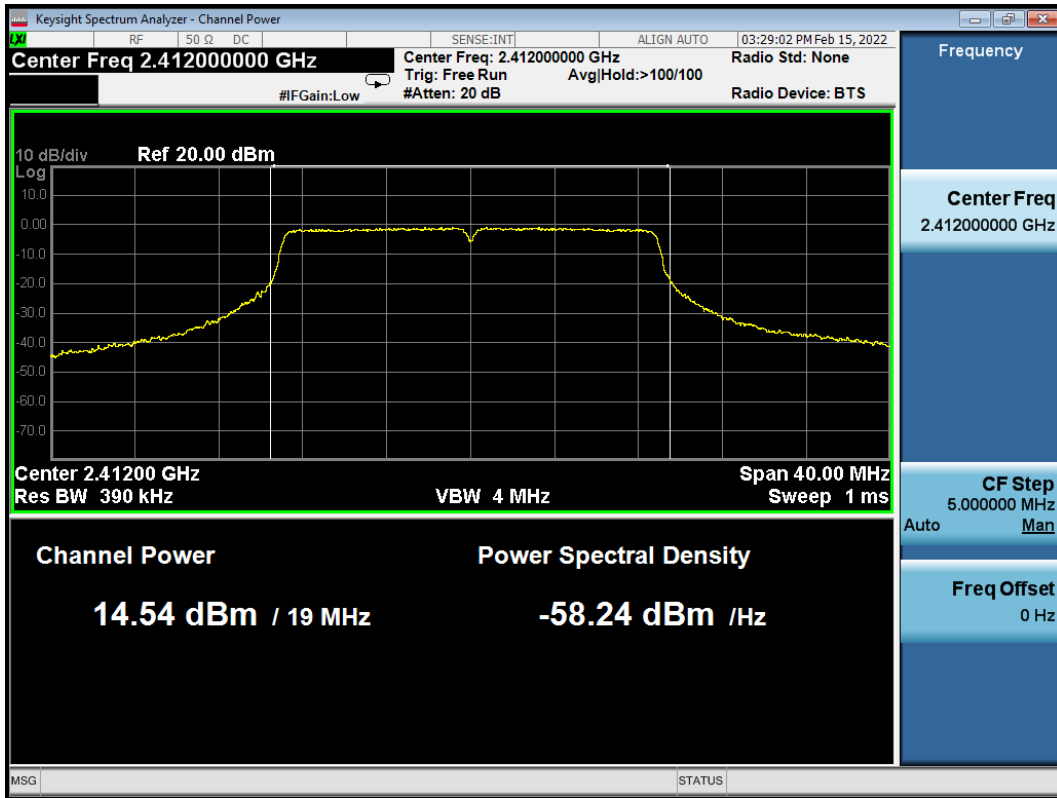

802.11n20 CH2437MHz

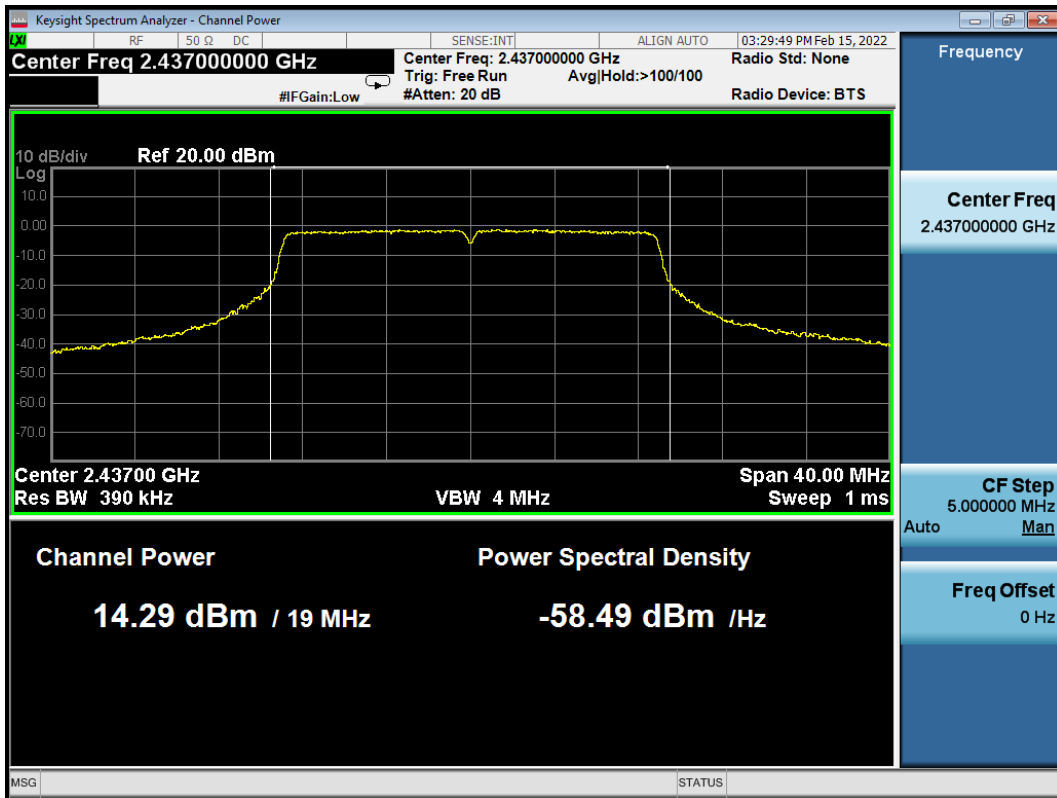

802.11n20 CH2462MHz

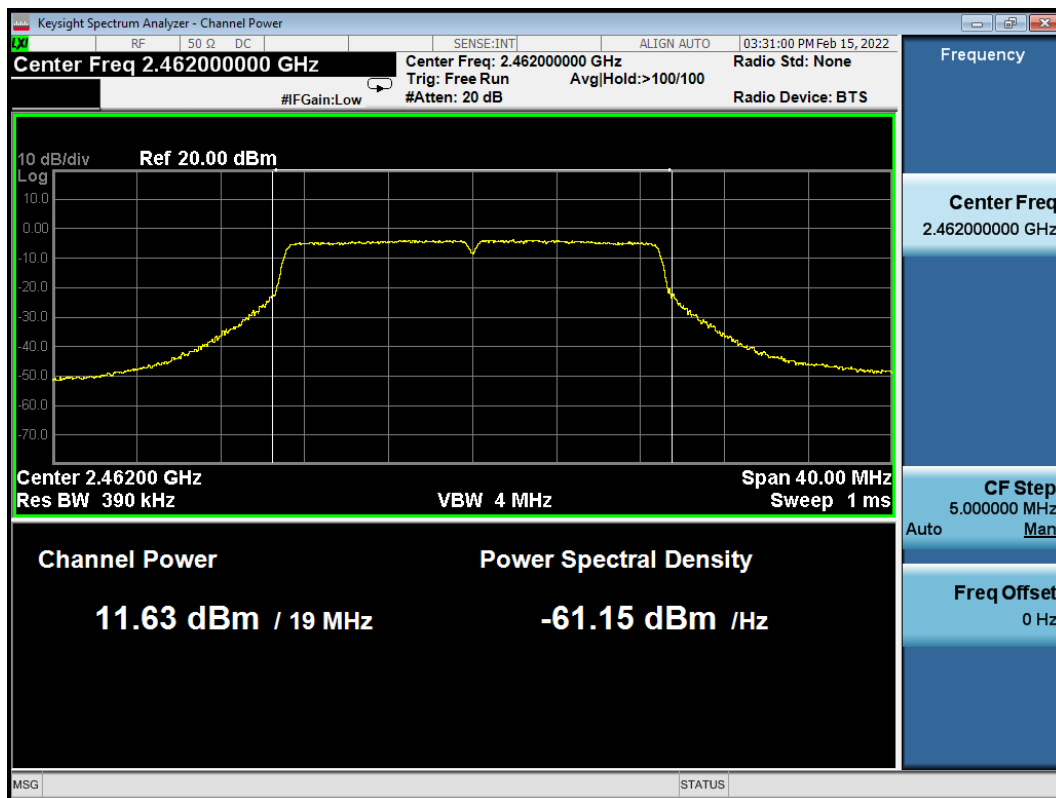

8 EMISSION LIMITATIONS MEASUREMENT

8.1 Test Equipment

The following test equipment was used during the emission limitations test:

Item	Type	Manufacturer	Model No.	Serial No.	Cal. Date	Cal. Interval
1.	Spectrum Analyzer	Agilent	N9010A	MY52221182	2021.09.15	1 Year
2.	Coaxial Cable	WOKEN	SFL402-105F LEX	F02-150819-045	2021.03.08	1 Year
3.	20 dB Attenuator	Mini-Circuits	VAT-20+	001	2021.08.06	1 Year

8.2 Block Diagram of Test Setup

The Same as Section. 5.2.

8.3 Specification Limits (§15.247(d))

In any 100 kHz bandwidth outside the frequency band in which the spread spectrum or digitally modulated intentional radiator is operating, the radio frequency power that is produced by the intentional radiator shall be at least 20 dB below that in the 100 kHz bandwidth within the band that contains the highest level of the desired power, based on either an RF conducted or a radiated measurement, provided the transmitter demonstrates compliance with the peak conducted power limits. If the transmitter complies with the conducted power limits based on the use of RMS averaging over a time interval, as permitted under paragraph (b)(3) of this section, the attenuation required under this paragraph shall be 30 dB instead of 20 dB. Attenuation below the general limits specified in §15.209(a) is not required.

In addition, radiated emissions which fall in the restricted bands, as defined in §15.205(a), must also comply with the radiated emission limits specified in §15.209(a) (see §15.205(c)). (※This test result attaching to Section. 3.7)

8.4 Operating Condition of EUT

The switch ON/OFF was used to enable the EUT to change the channel one by one.

8.5 Test Procedure

The transmitter output was connected to the spectrum analyzer.

Establish a reference level by using the following procedure:

- a) Set instrument center frequency to DTS channel center frequency.
- b) Set the span to ≥ 1.5 times the DTS bandwidth.
- c) Set the RBW = 100 kHz.
- d) Set the VBW $\geq [3 \times \text{RBW}]$.
- e) Detector = peak.
- f) Sweep time = auto couple.
- g) Trace mode = max hold.
- h) Allow trace to fully stabilize.
- i) Use the peak marker function to determine the maximum PSD level.

Note that the channel found to contain the maximum PSD level can be used to

establish the reference level.

Establish an emission level by using the following procedure:

- a) Set the center frequency and span to encompass frequency range to be measured.
- b) Set the RBW = 100 kHz.
- c) Set the VBW $\geq [3 \times \text{RBW}]$.
- d) Detector = peak.
- e) Sweep time = auto couple.
- f) Trace mode = max hold.
- g) Allow trace to fully stabilize.
- h) Use the peak marker function to determine the maximum amplitude level.

Ensure that the amplitude of all unwanted emissions outside of the authorized frequency band (excluding restricted frequency bands) is attenuated by at least the minimum requirements specified in 11.11. Report the three highest emissions relative to the limit.

Scan up through 10th harmonic.

The test procedure is defined in ANSI C63.10-2013 (11.11.2 Reference level measurement and 11.11.3 Emission level measurement was used).

8.6 Test Results

PASSED.

The test data was attached in the next pages.

(Test Date: 2022.02.15 Temperature: 23°C Humidity: 51 %)

Modulation	Channel	Frequency (MHz)	Data Page
802.11b	1	2412 MHz	P56-58
	6	2437 MHz	P59-60
	11	2462 MHz	P61-63
802.11g	1	2412 MHz	P64-66
	6	2437 MHz	P67-68
	11	2462 MHz	P69-71
802.11n20	1	2412 MHz	P72-74
	6	2437 MHz	P75-76
	11	2462 MHz	P77-79

802.11b CH2412MHz

Reference level

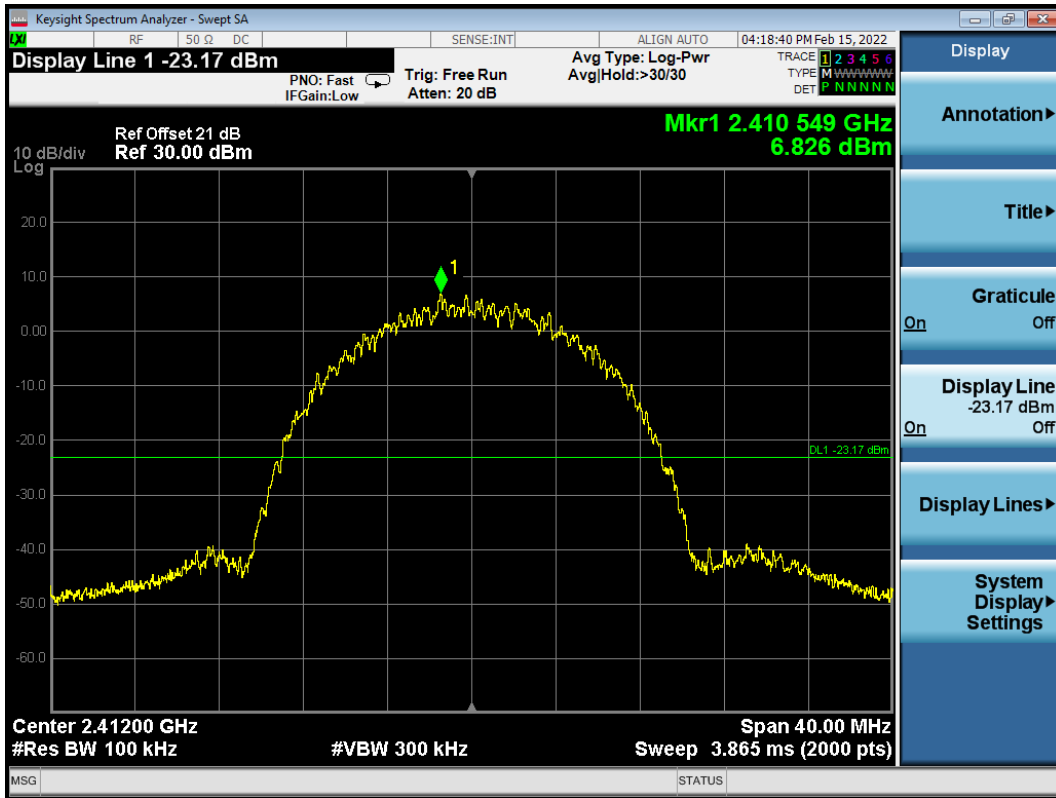

Emission level

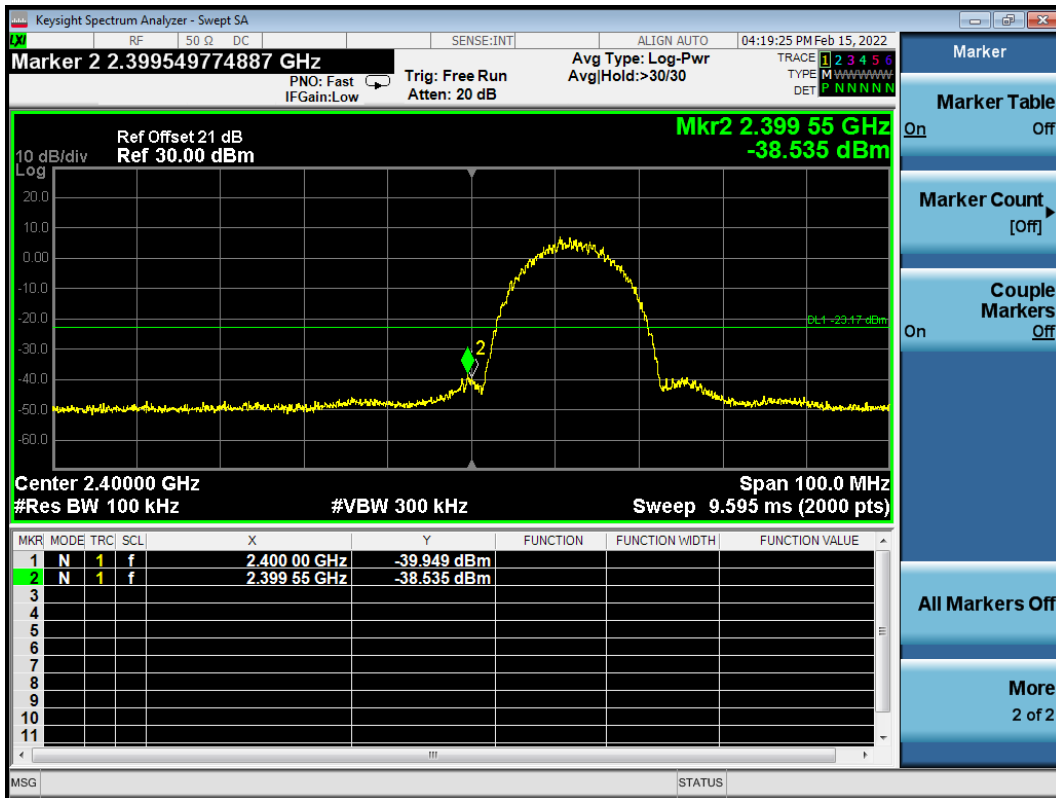

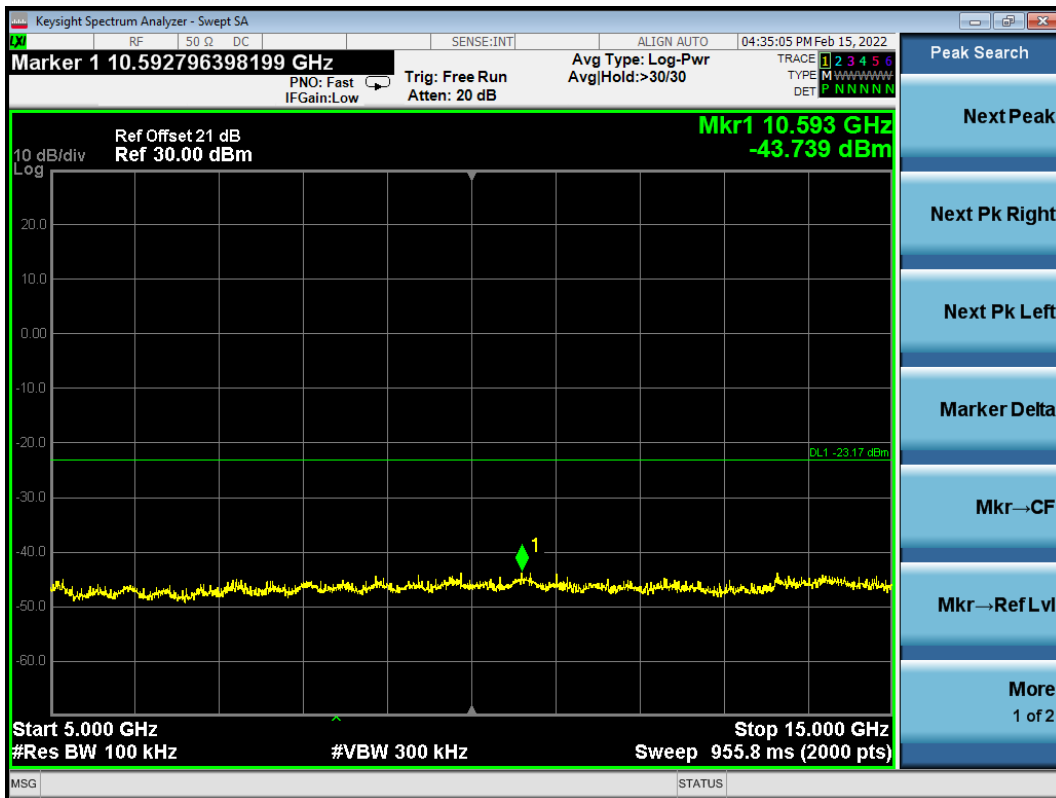
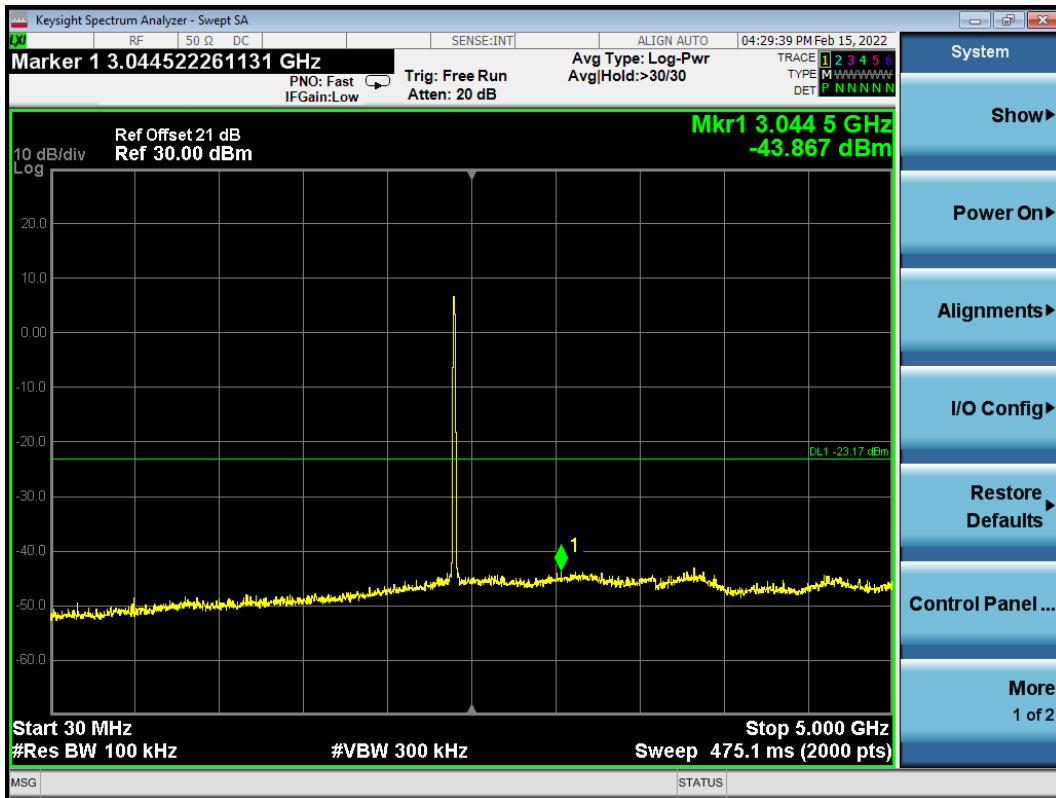



802.11b CH2437MHz

Reference level

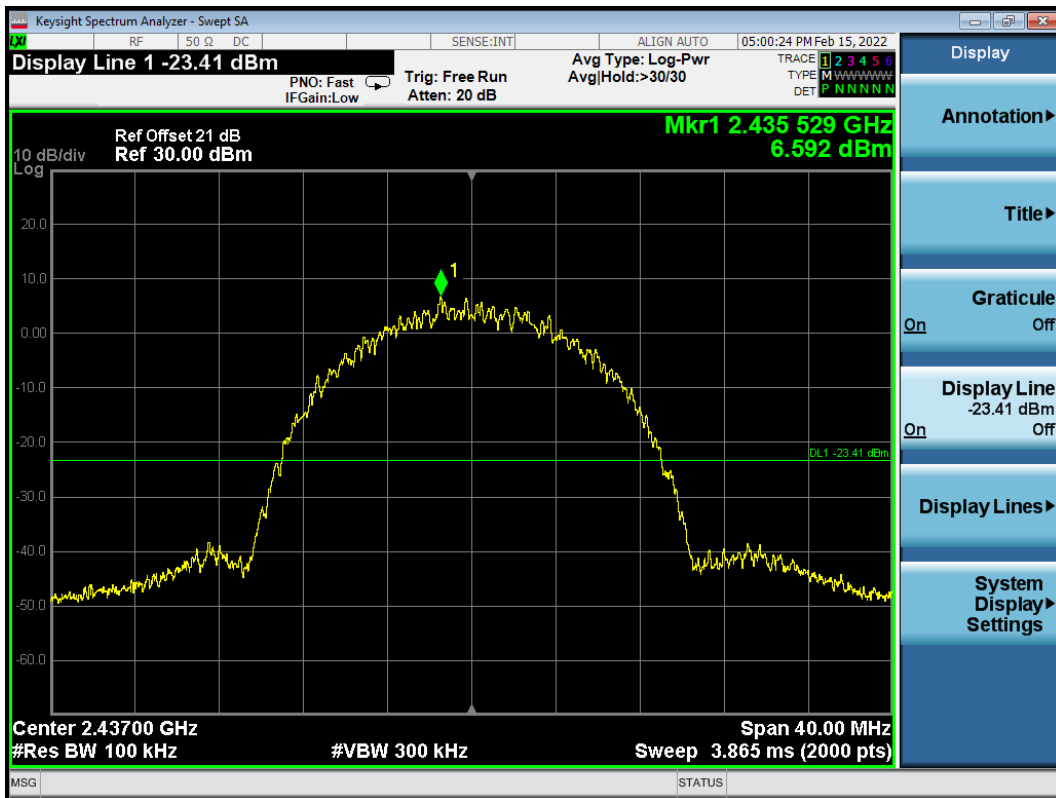

Emission level



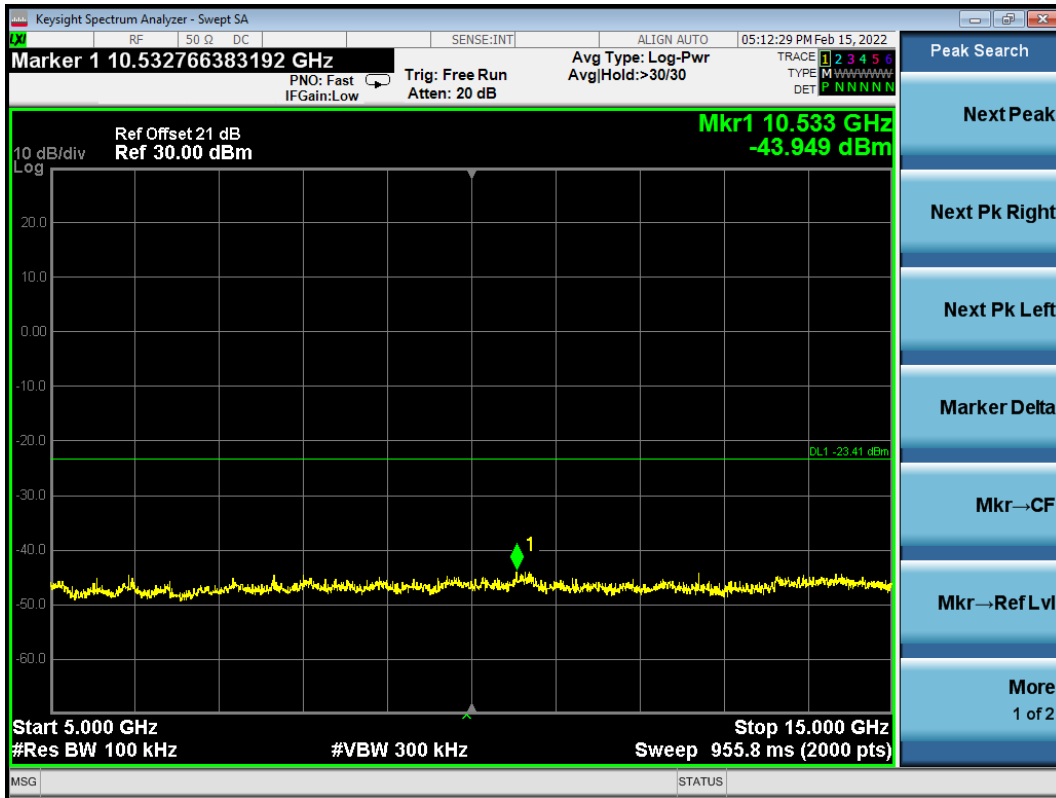

802.11b CH2462MHz

Reference level

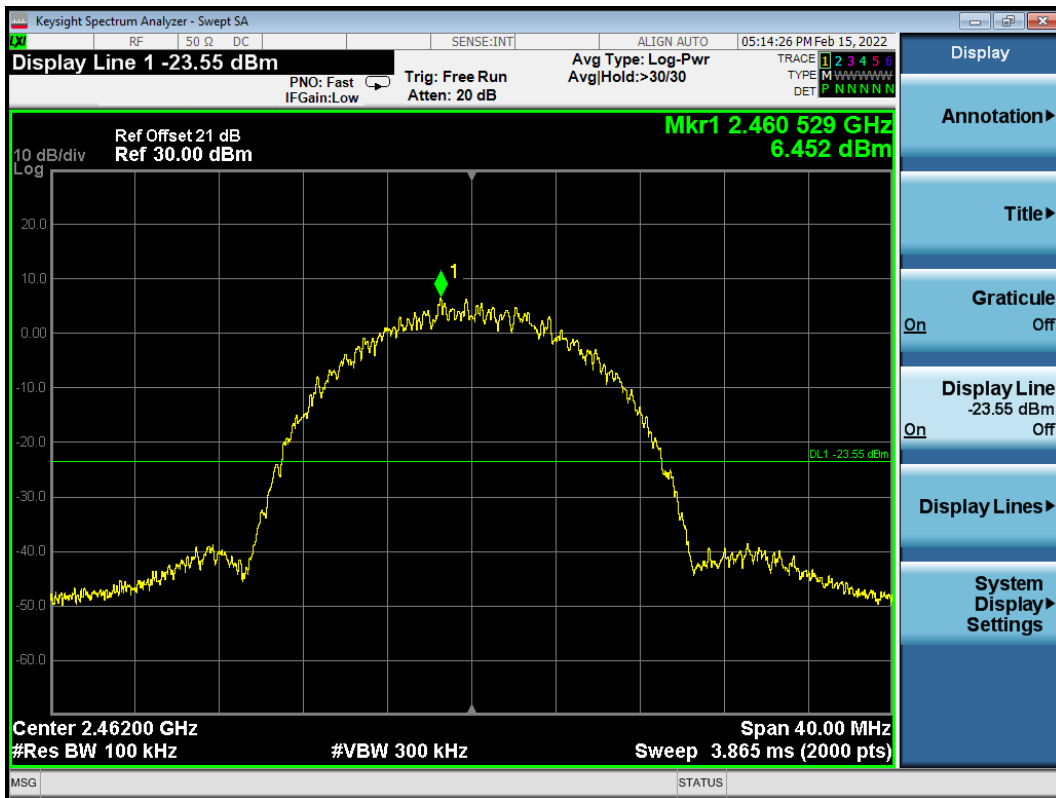

Emission level

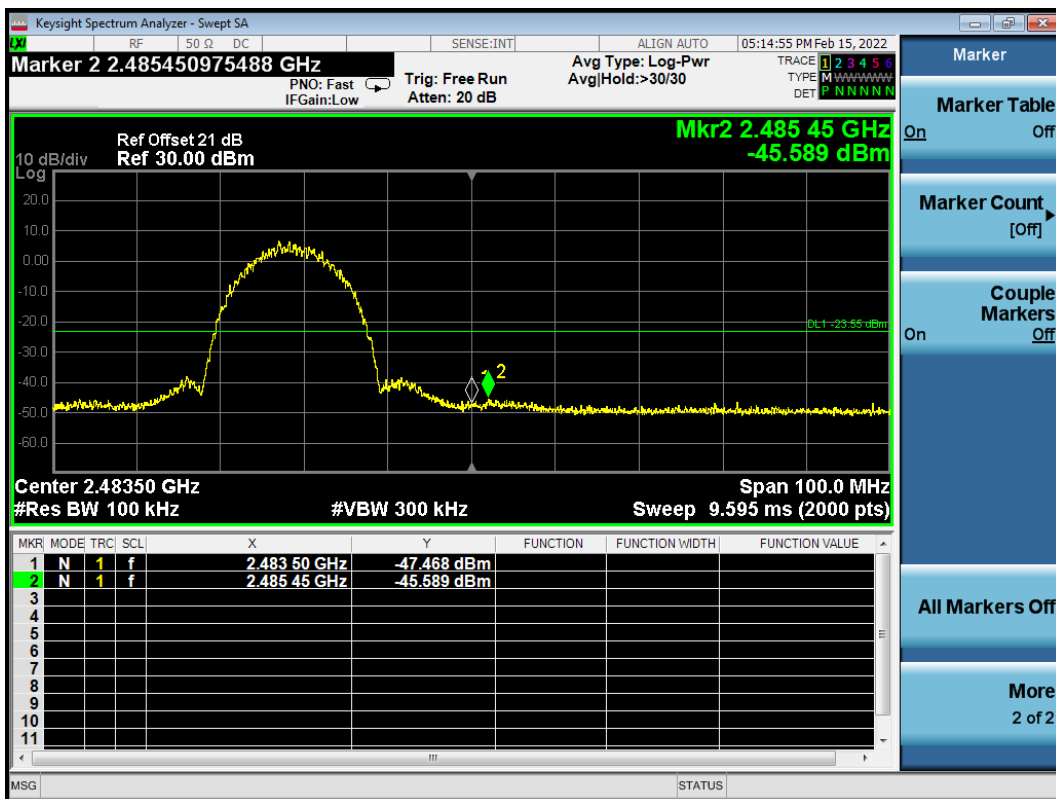

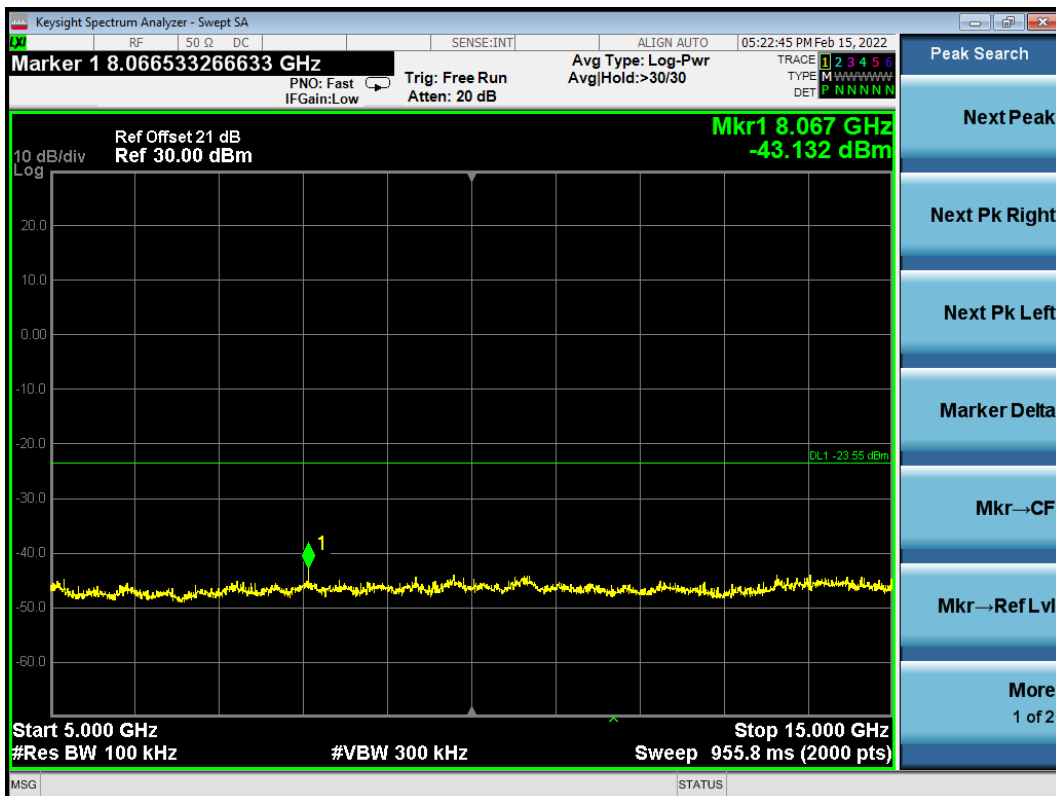



802.11g CH2412MHz

Reference level

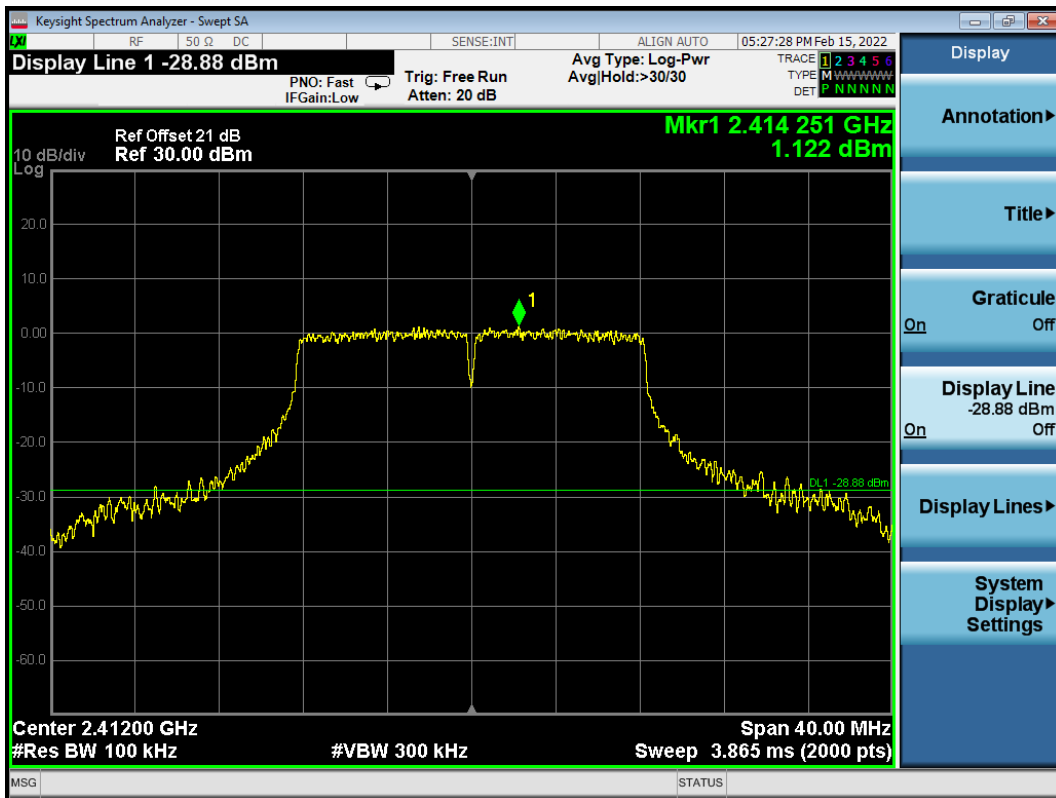

Emission level

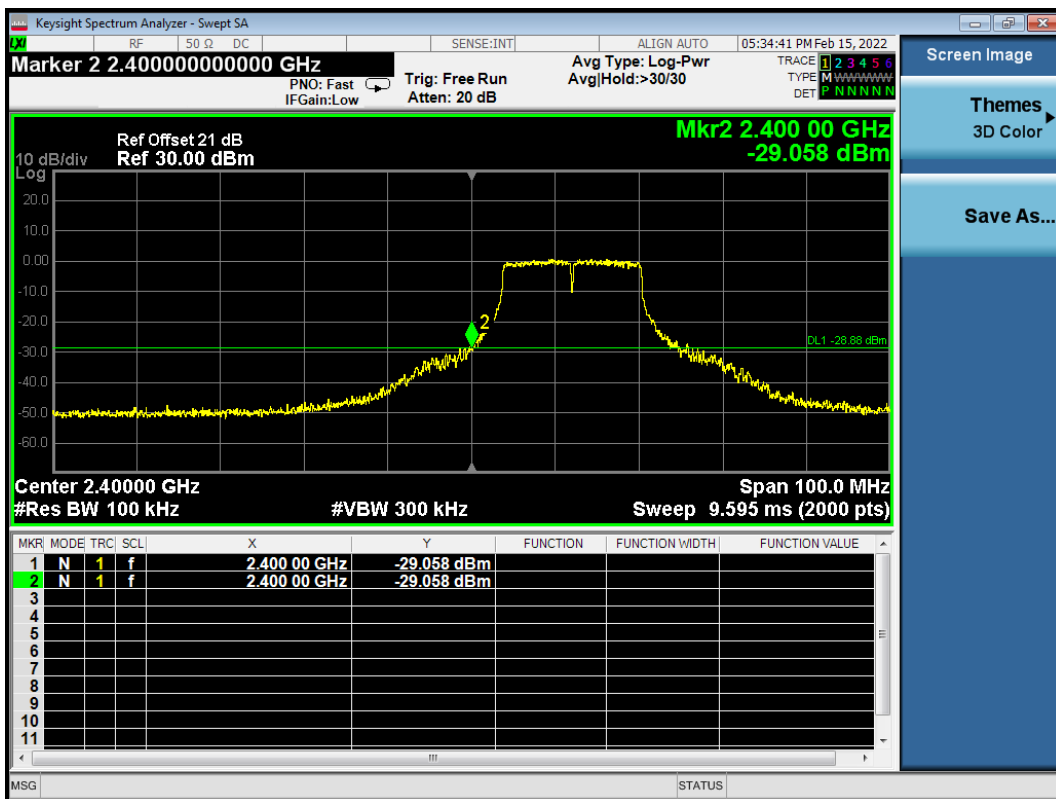

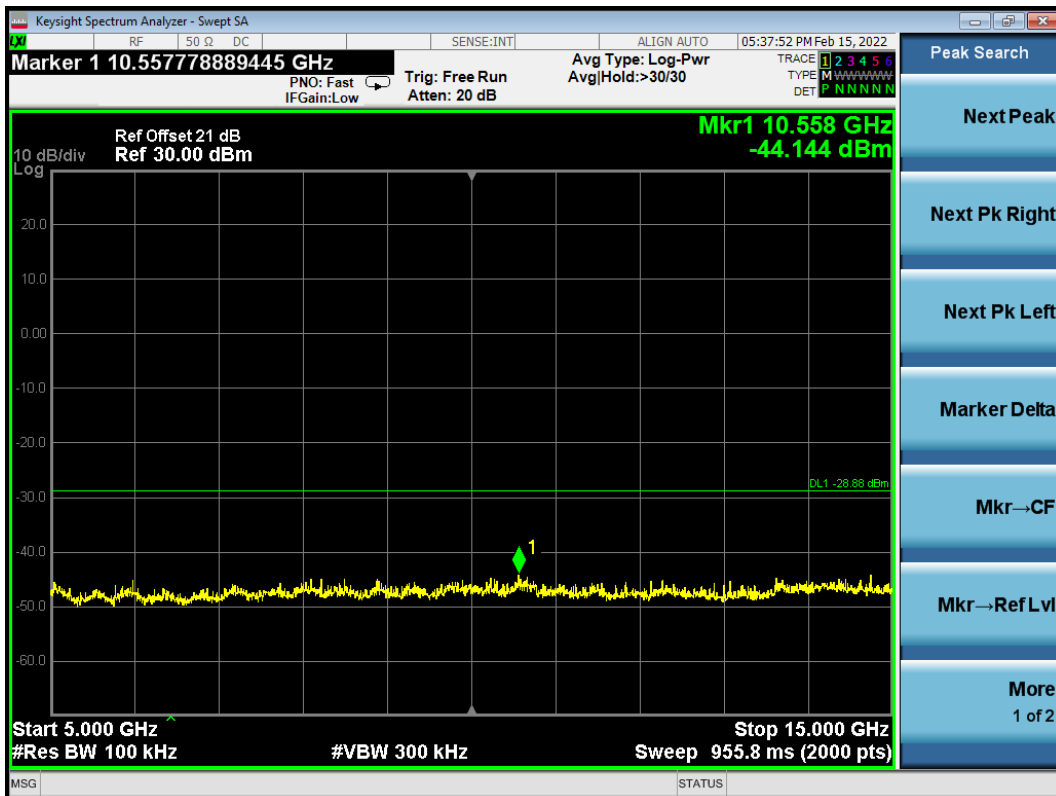
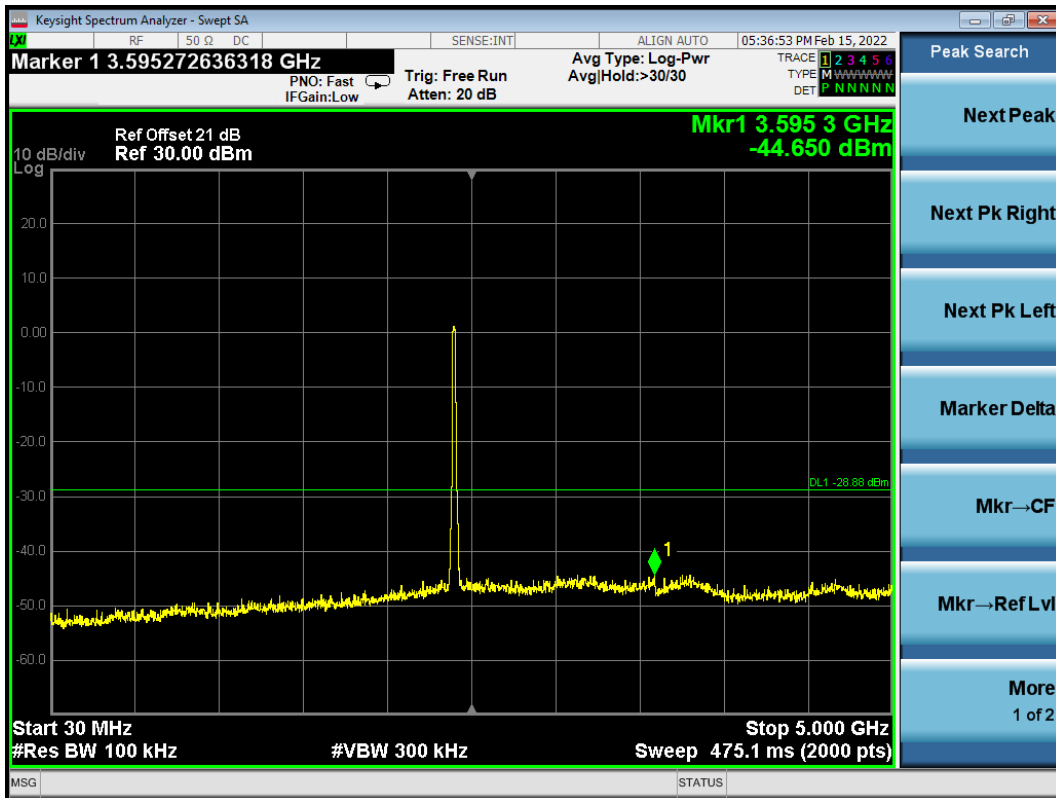

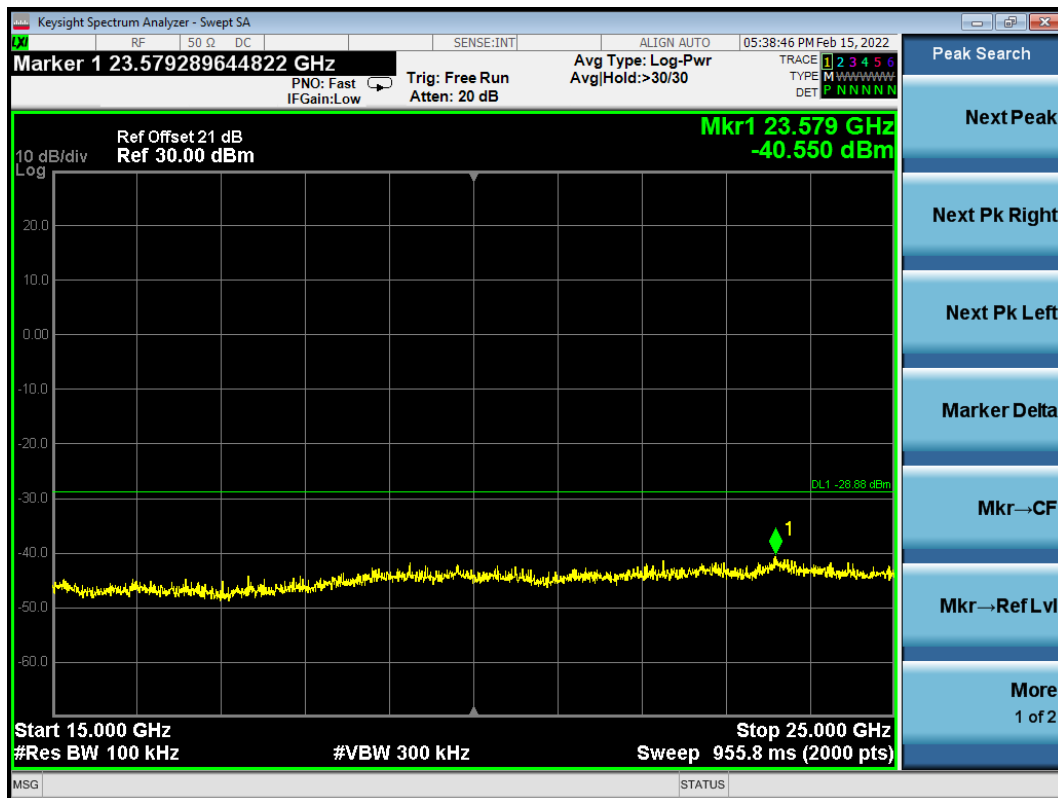

802.11g CH2437MHz

Reference level

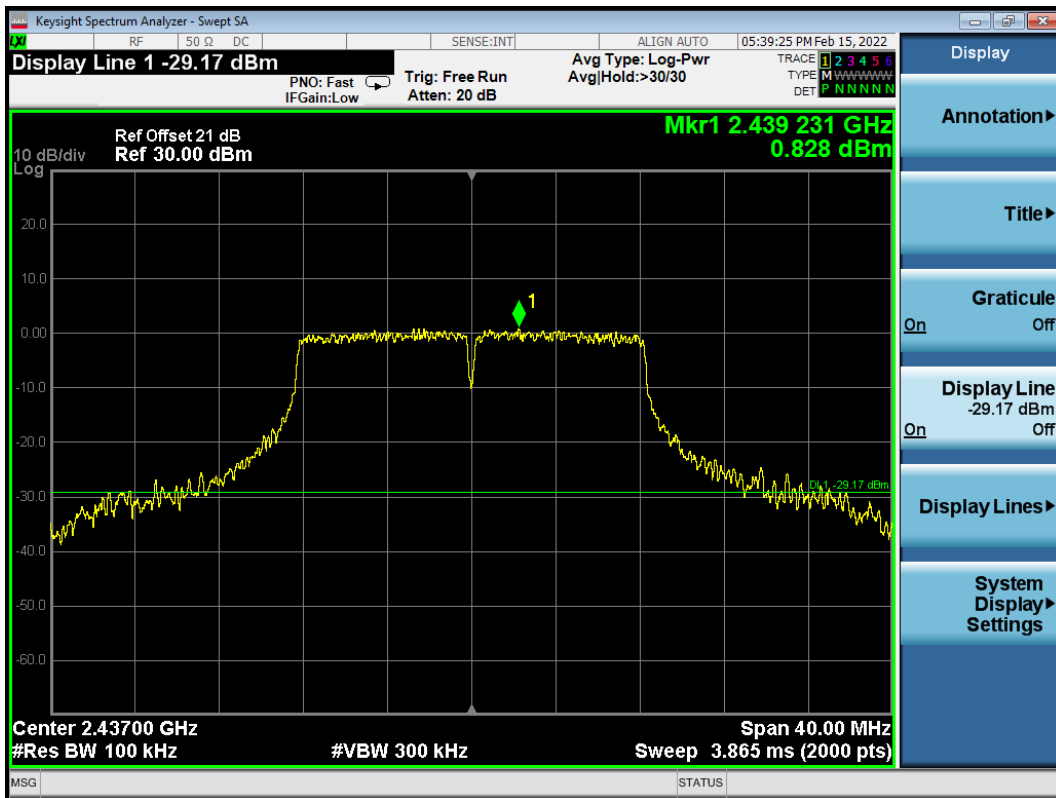

Emission level

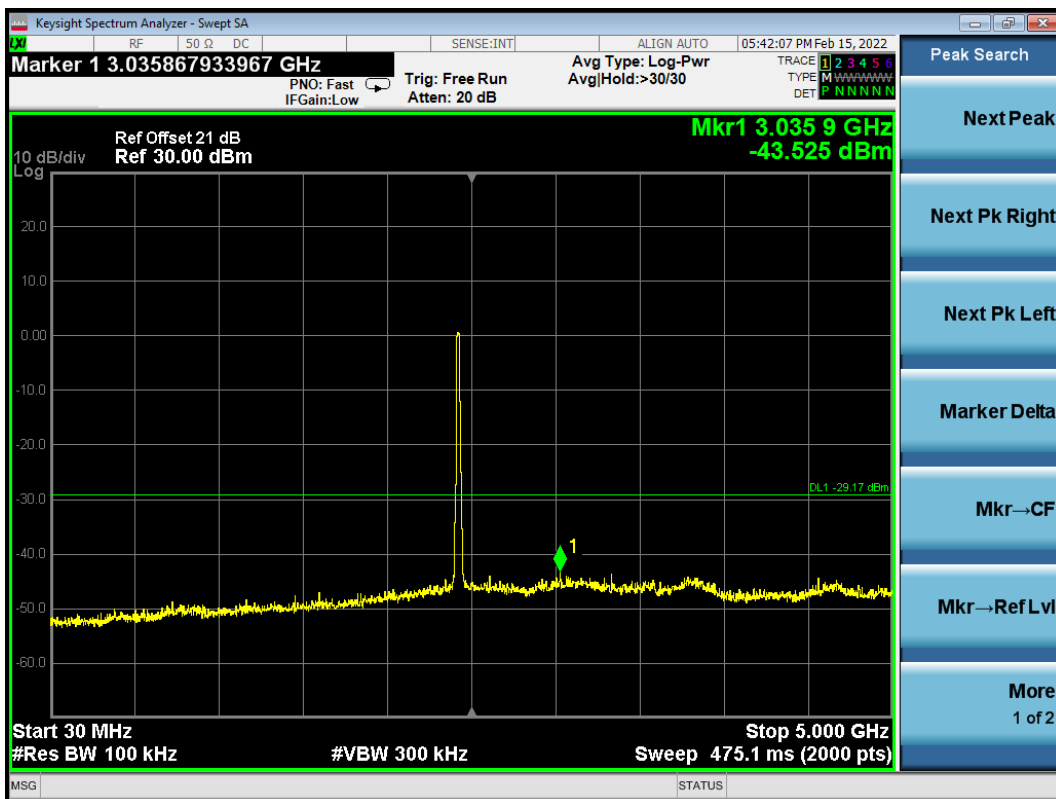

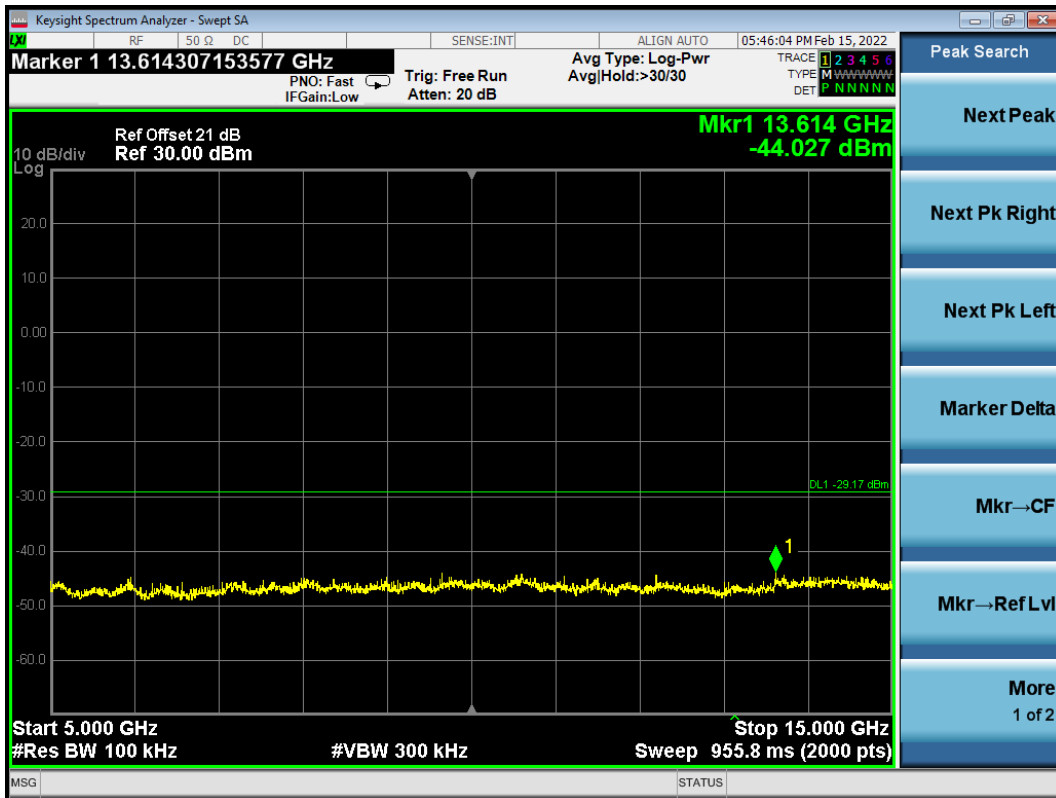

802.11g CH2462MHz

Reference level

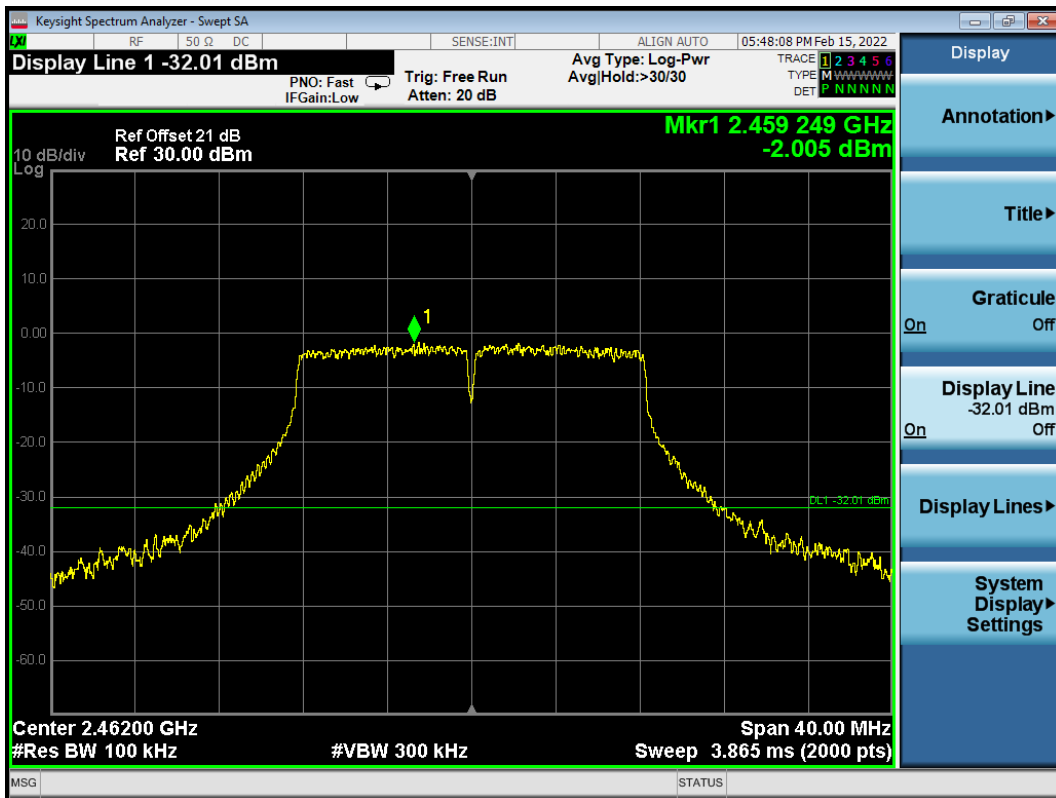

Emission level

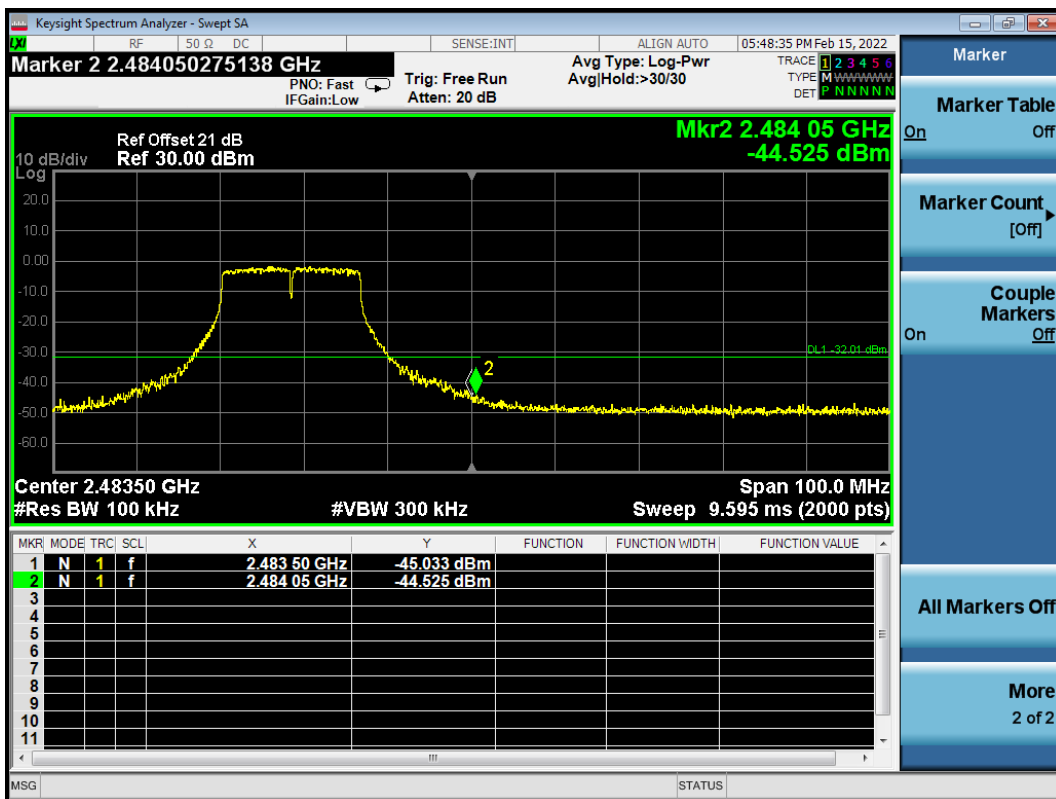

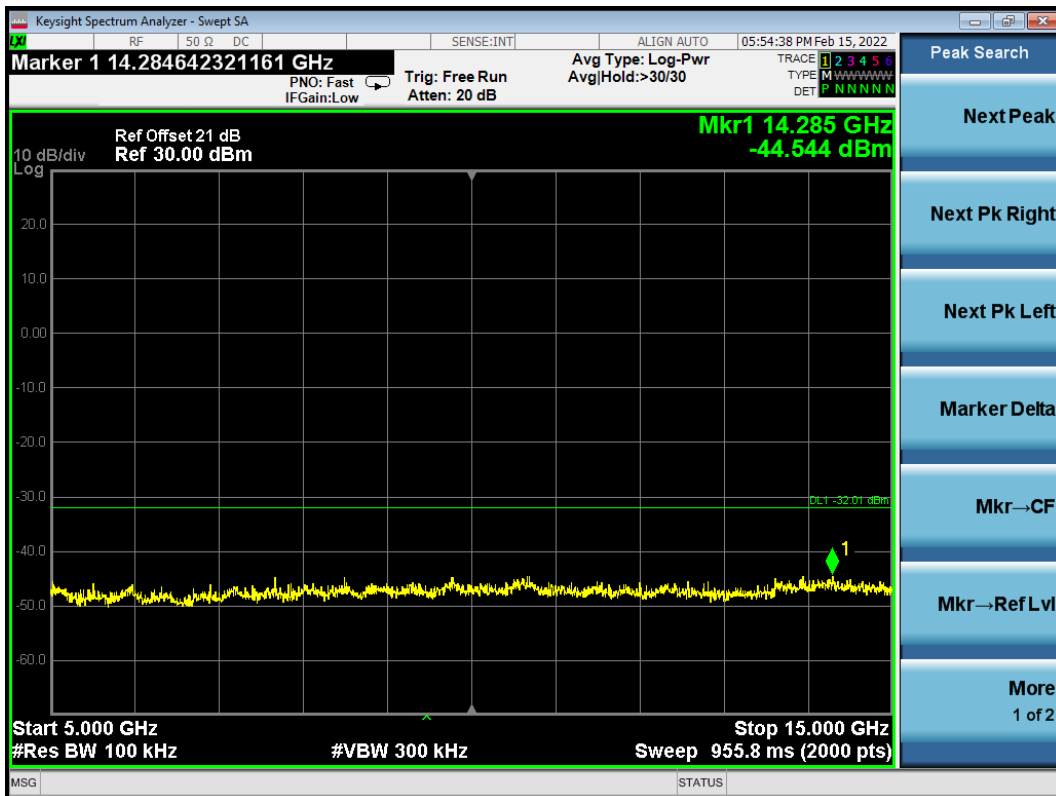
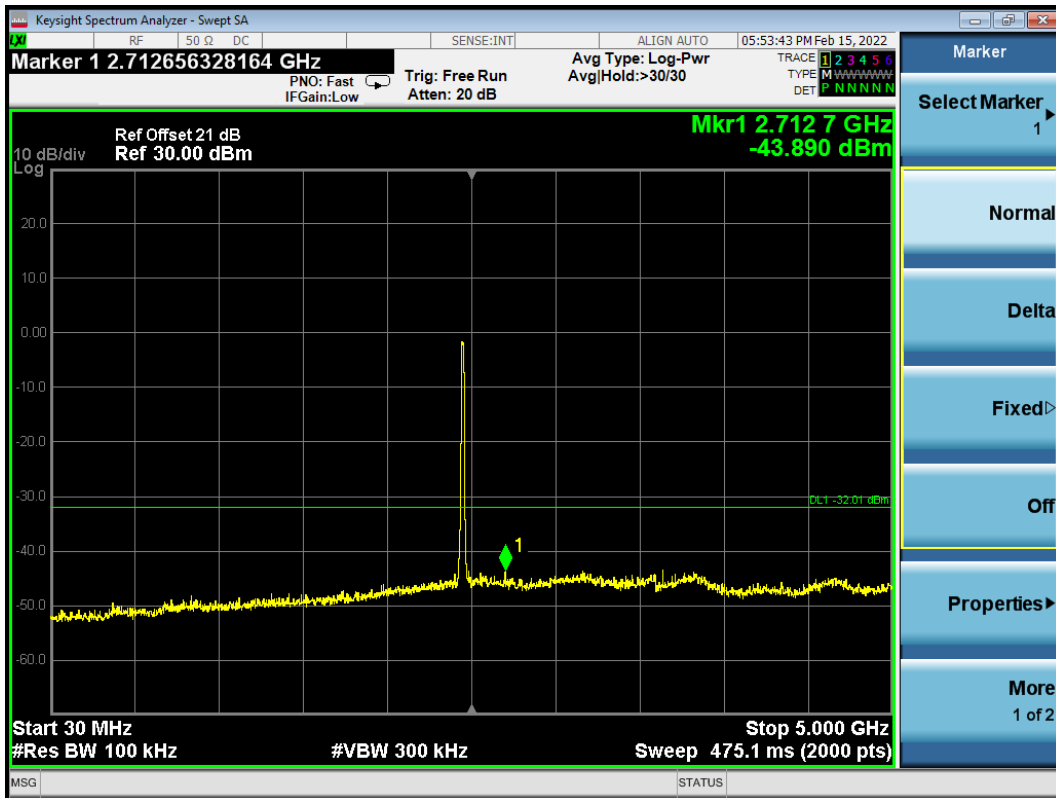



802.11n20 CH2412MHz

Reference level

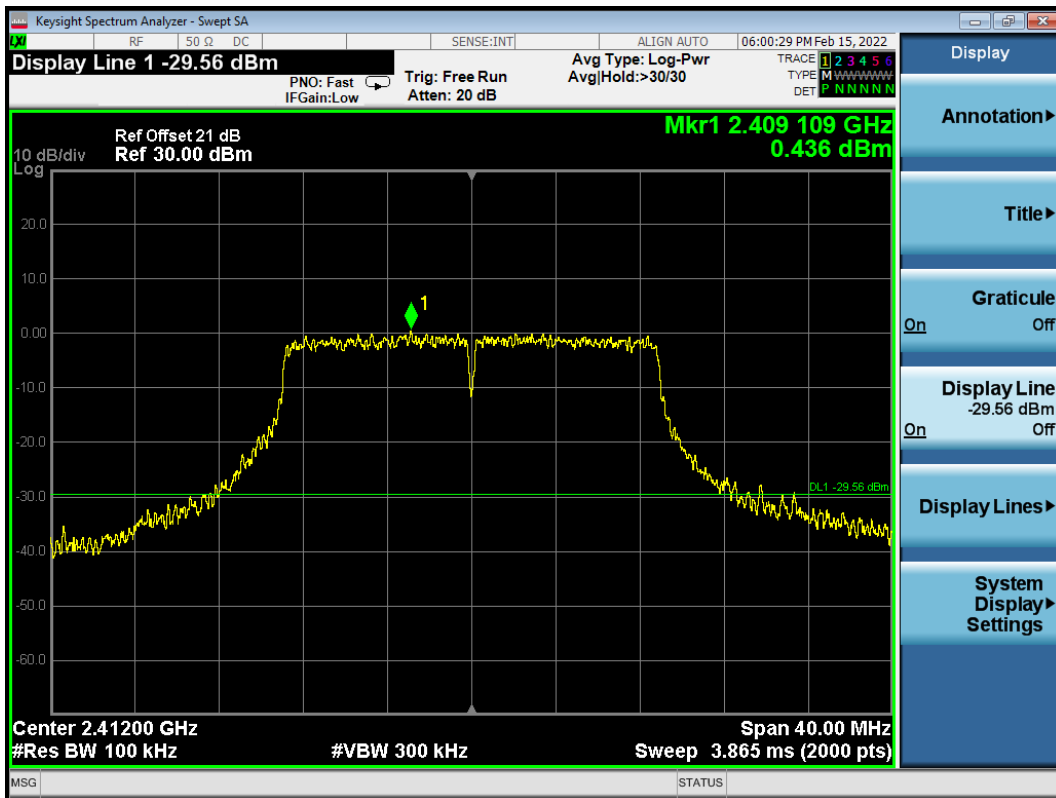

Emission level

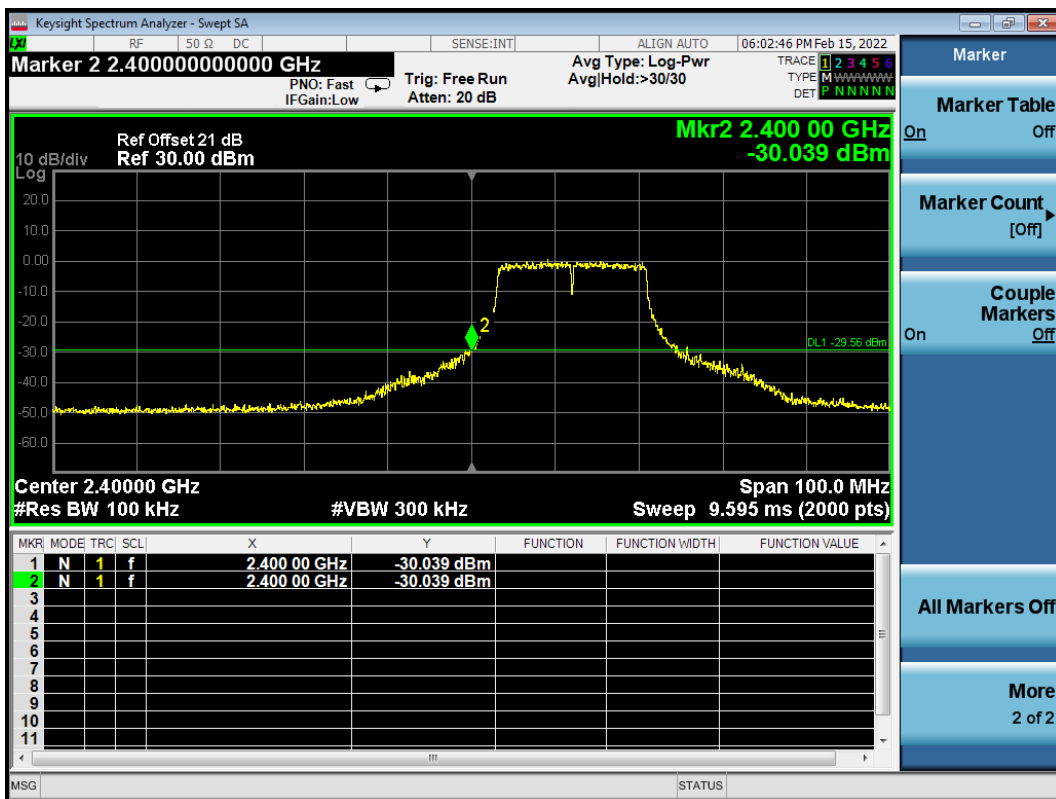

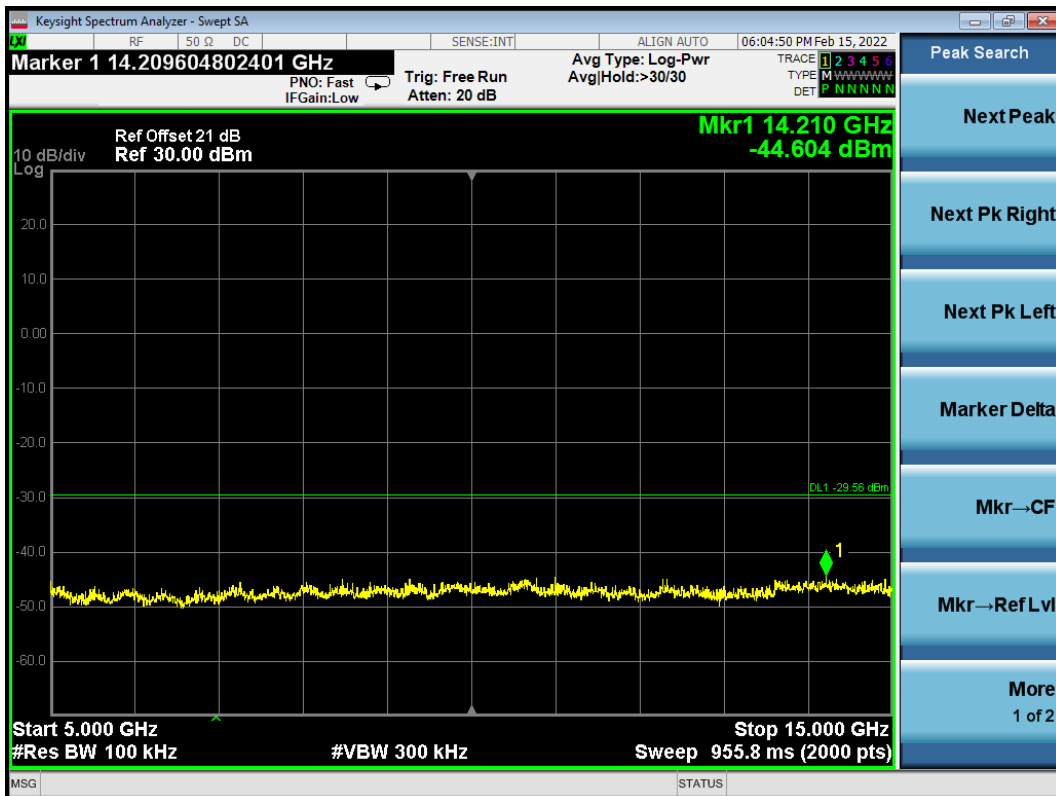
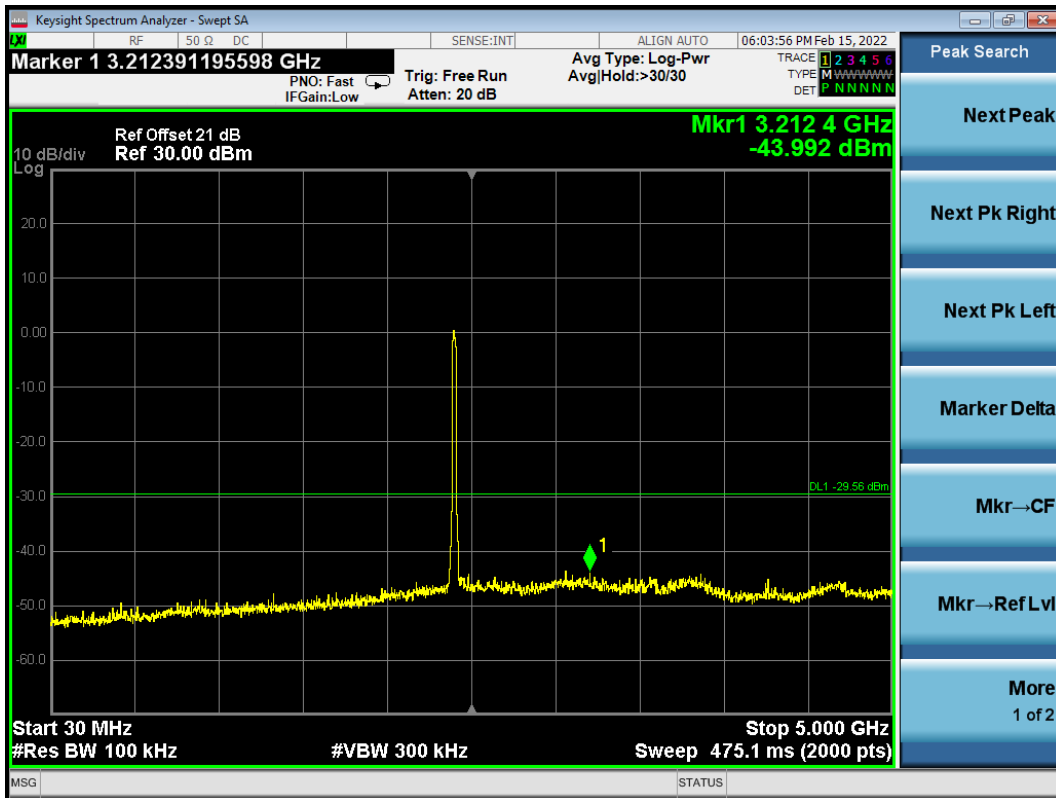



802.11n20 CH2437MHz

Reference level

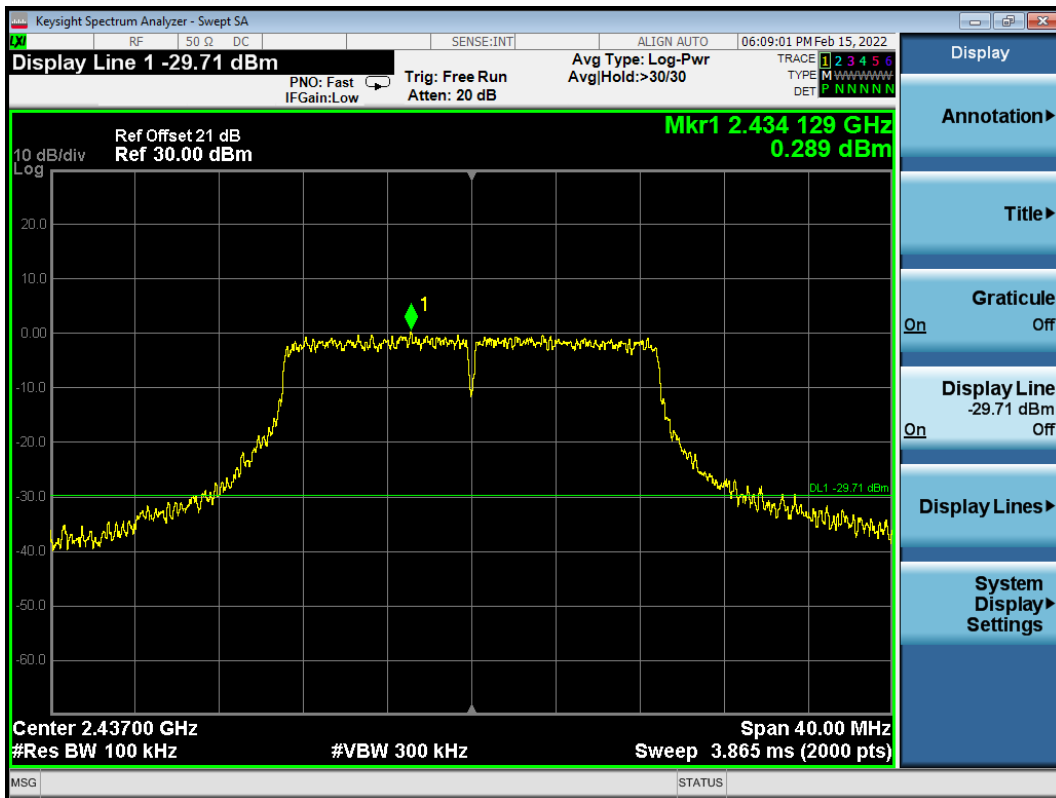

Emission level

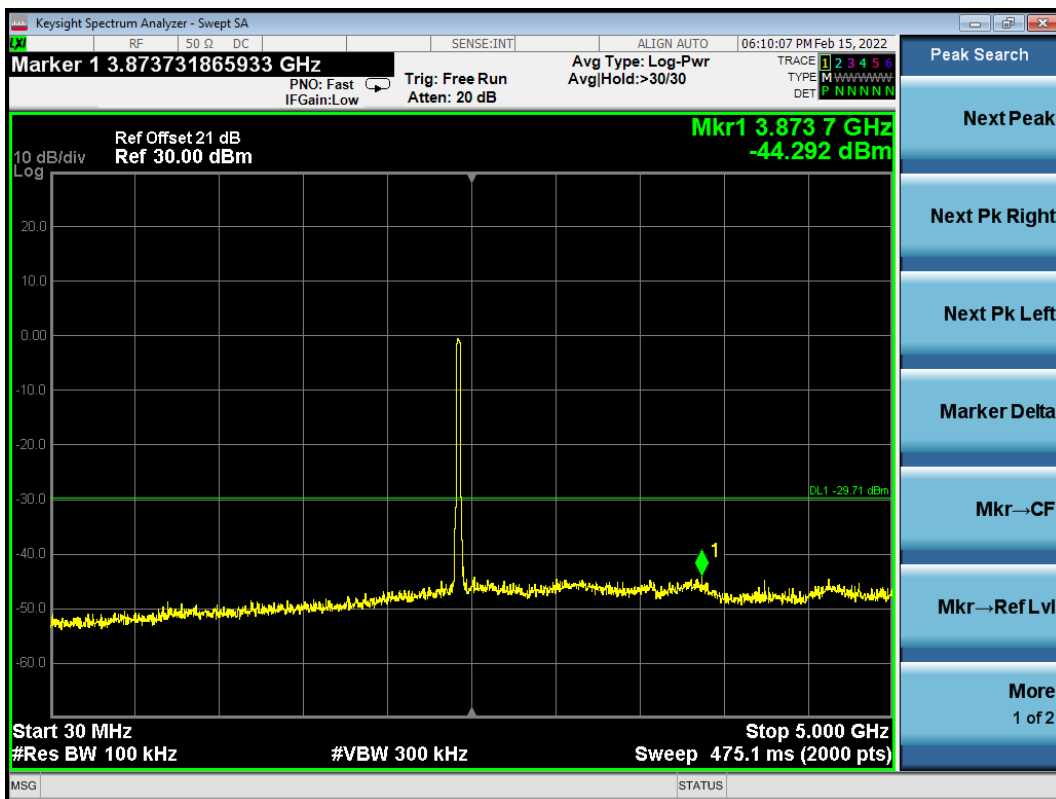

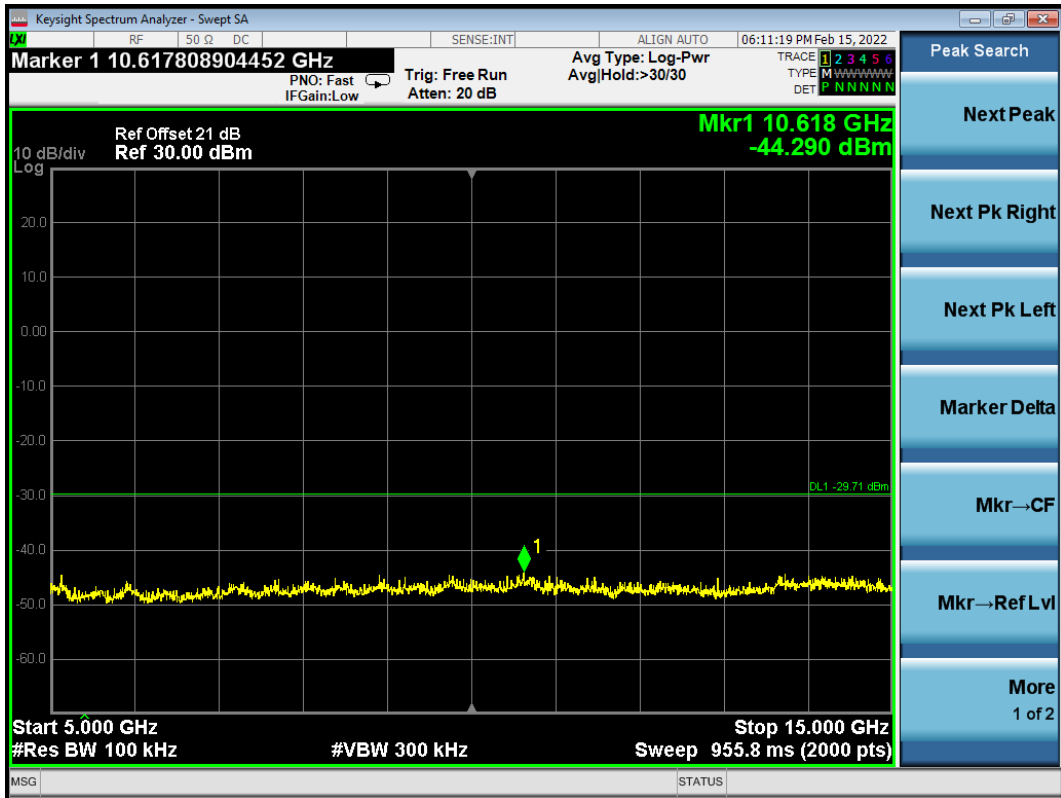

802.11n20 CH2462MHz

Reference level

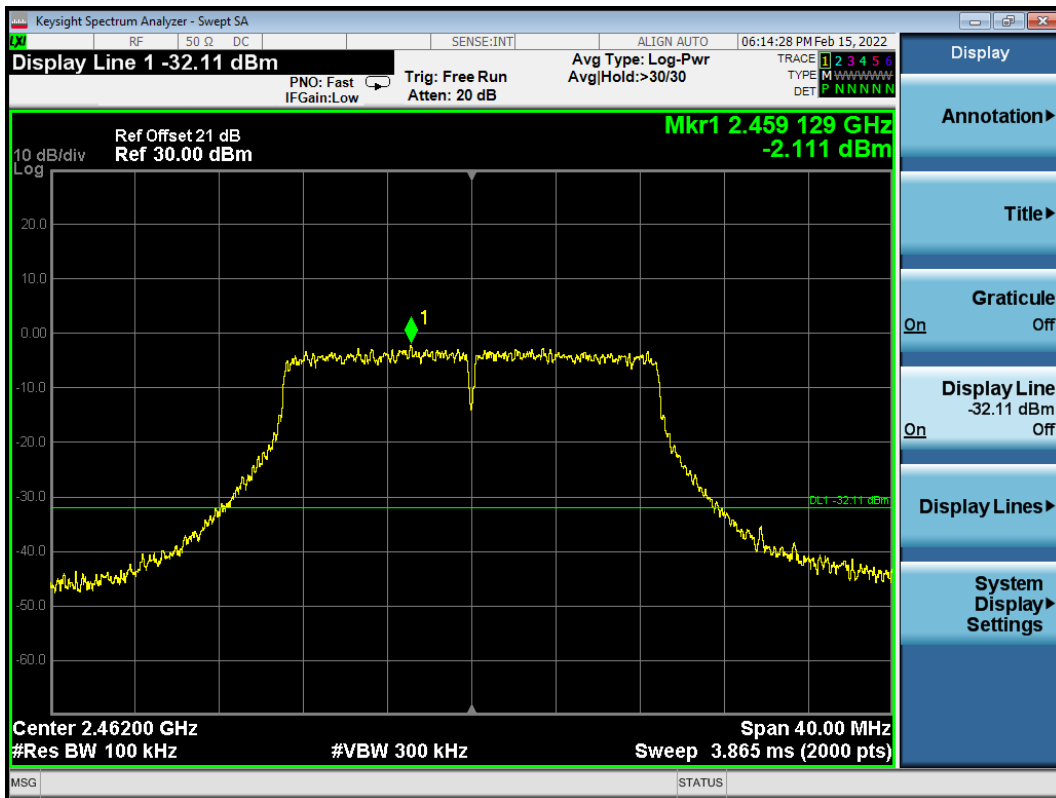

Emission level

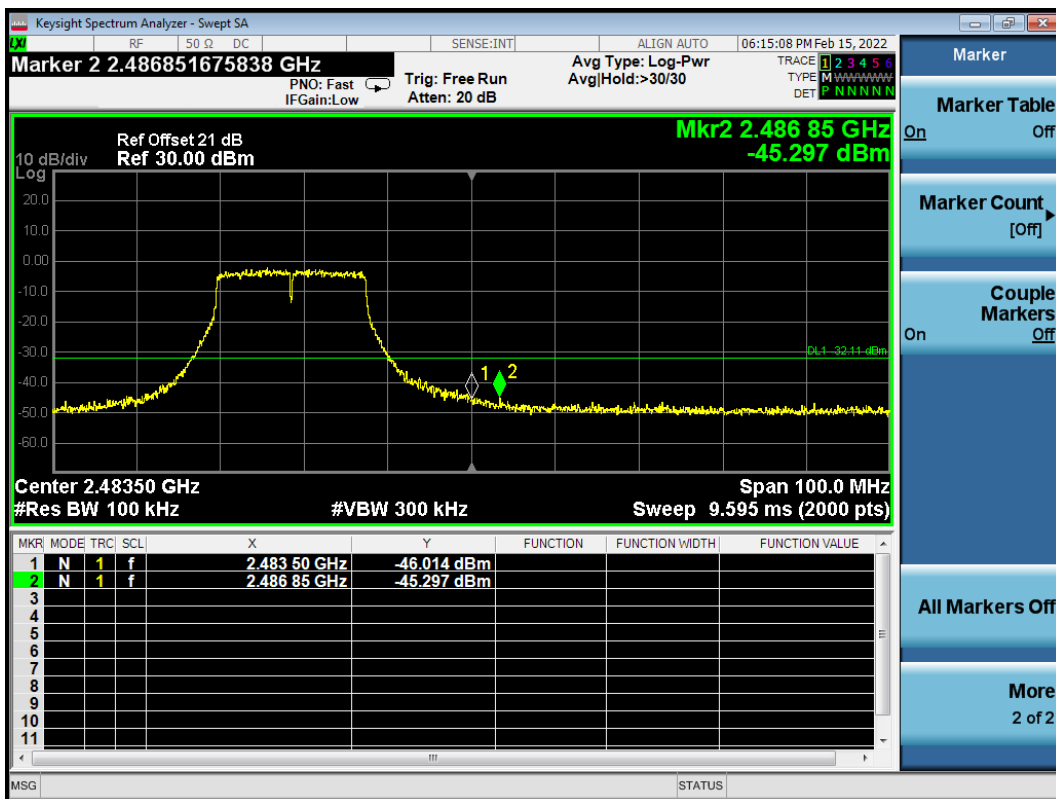

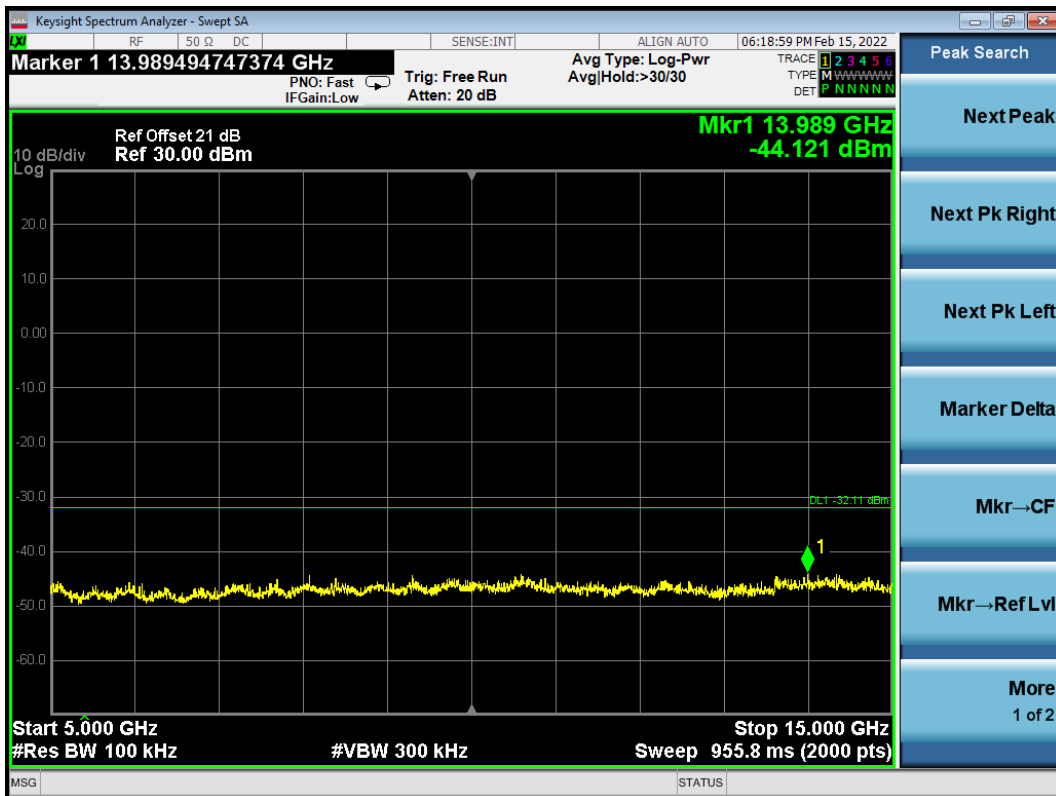
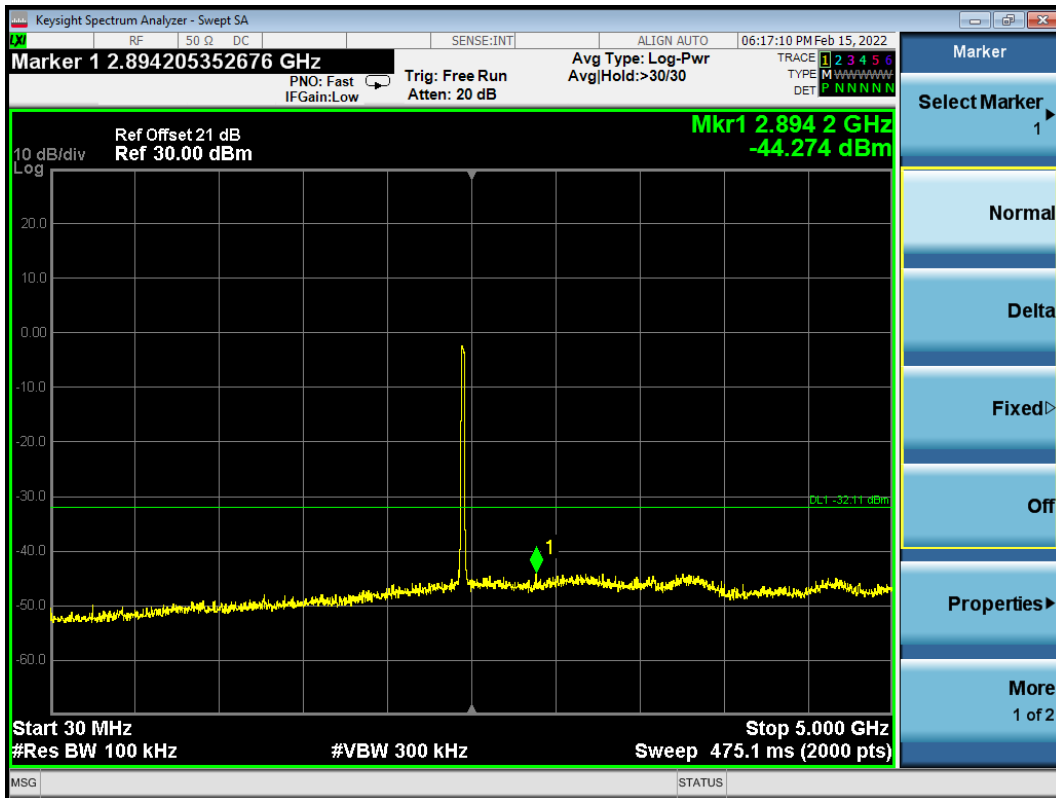



9 POWER SPECTRAL DENSITY MEASUREMENT

9.1 Test Equipment

The following test equipment was used during the power spectral density measurement:

Item	Type	Manufacturer	Model No.	Serial No.	Cal. Date	Cal. Interval
1.	Spectrum Analyzer	Agilent	N9010A	MY52221182	2021.09.15	1 Year
2.	Coaxial Cable	WOKEN	SFL402-105F LEX	F02-150819-045	2021.03.08	1 Year
3.	20 dB Attenuator	Mini-Circuits	VAT-20+	001	2021.08.06	1 Year

9.2 Block Diagram of Test Setup

The Same as section 5.2.

9.3 Specification Limits (§15.247(e))

The peak power spectral density conducted from the intentional radiator to the antenna shall not be greater than 8 dBm in any 3 kHz band.

9.4 Operating Condition of EUT

The switch ON/OFF was used to enable the EUT to change the channel one by one.

9.5 Test Procedure

The transmitter output was connected to the spectrum analyzer.

- a) Set analyzer center frequency to DTS channel center frequency.
- b) Set the span to 1.5 times the DTS bandwidth.
- c) Set the RBW to $3 \text{ kHz} \leq \text{RBW} \leq 100 \text{ kHz}$.
- d) Set the VBW $\geq [3 \times \text{RBW}]$.
- e) Detector = peak.
- f) Sweep time = auto couple.
- g) Trace mode = max hold.
- h) Allow trace to fully stabilize.
- i) Use the peak marker function to determine the maximum amplitude level within the RBW.
- j) If measured value exceeds requirement, then reduce RBW (but no less than 3 kHz) and repeat.

The test procedure is defined in ANSI C63.10-2013 (11.10.2 Measurement Procedure “Method PKPSD (peak PSD)” was used).

9.6 Test Results

PASSED.

All the test results are attached in next pages.

(Test Date: 2022.02.15 Temperature: 23°C Humidity: 51 %)

Modulation	Channel	Frequency (MHz)	Power Spectral Density (dBm)	Limit
802.11b	1	2412	-7.284	8 dBm
	6	2437	-7.478	8 dBm
	11	2462	-7.671	8 dBm
802.11g	1	2412	-12.979	8 dBm
	6	2437	-13.229	8 dBm
	11	2462	-15.763	8 dBm
802.11n20	1	2412	-13.837	8 dBm
	6	2437	-13.902	8 dBm
	11	2462	-16.527	8 dBm

802.11b CH2412 MHz

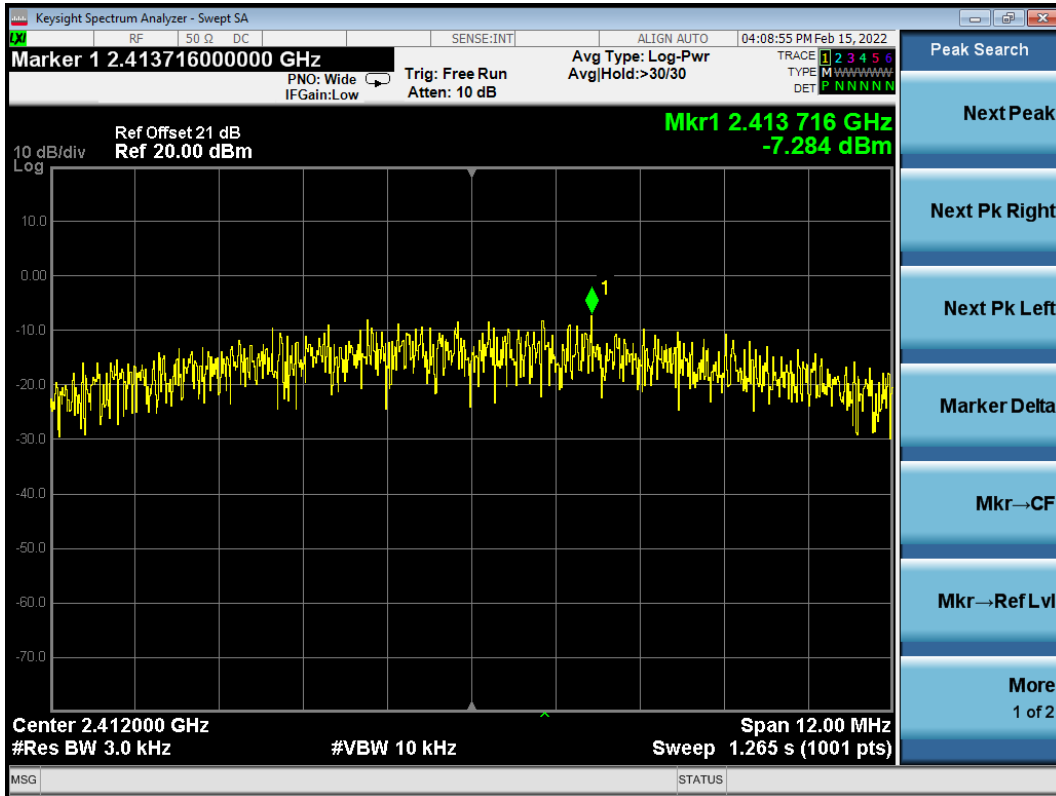

802.11b CH2437 MHz

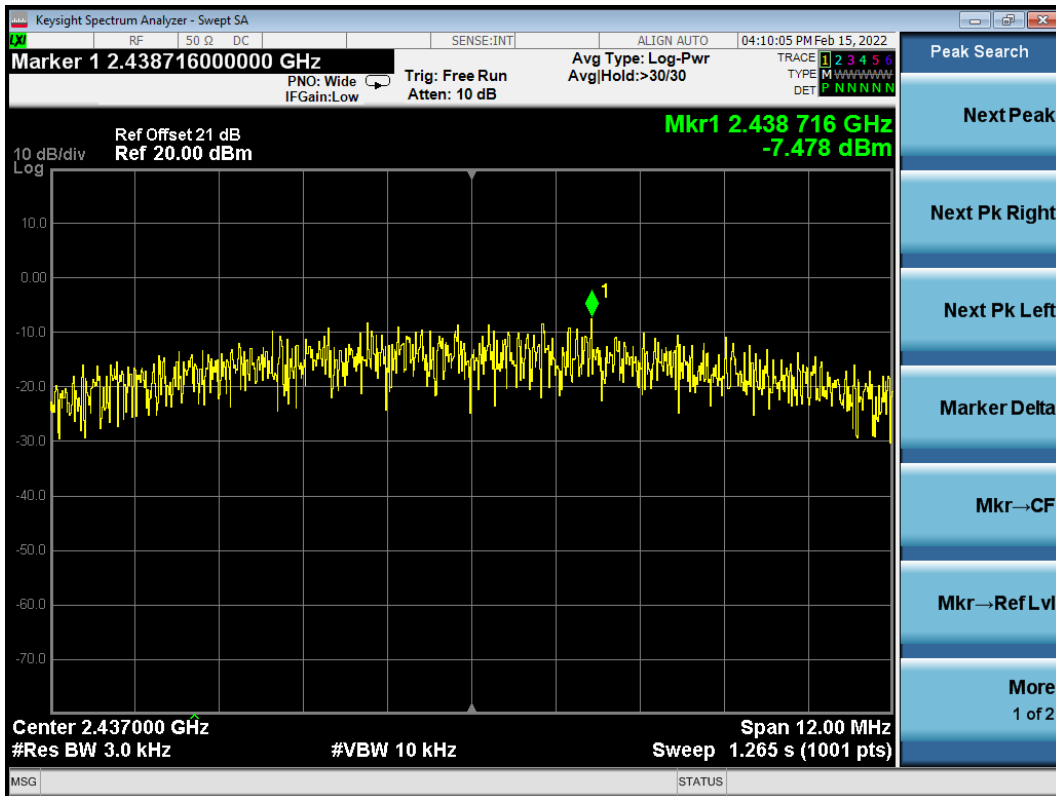

802.11b CH2462 MHz

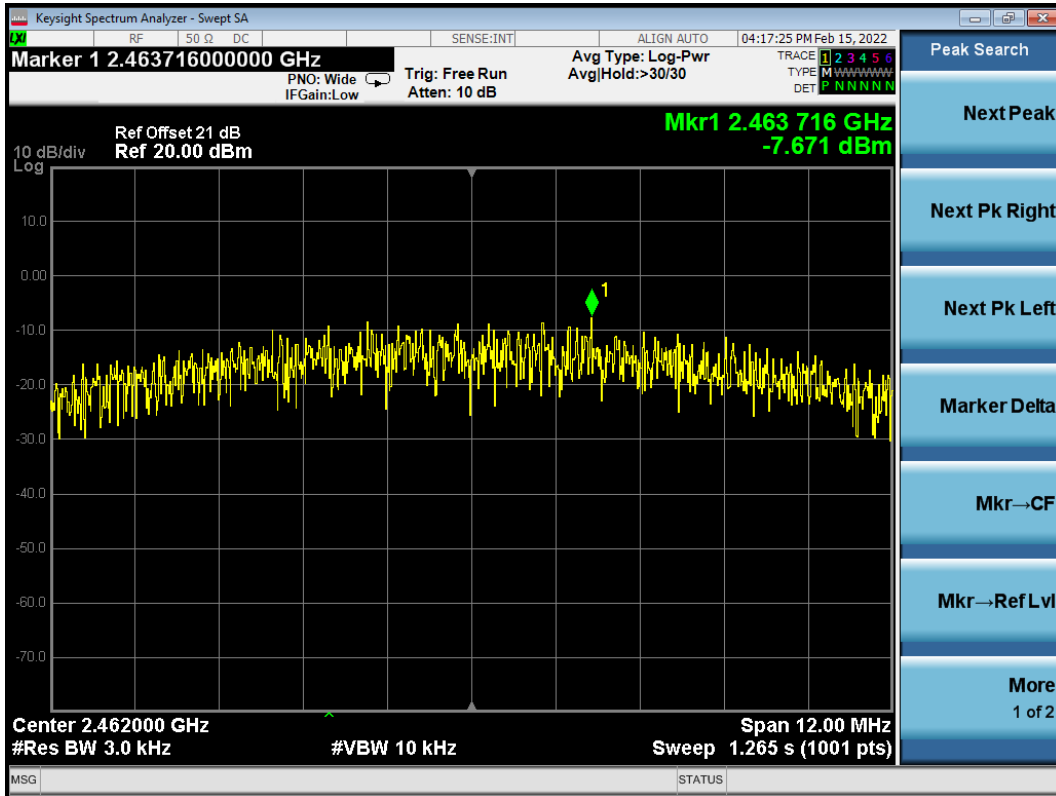

802.11g CH2412 MHz

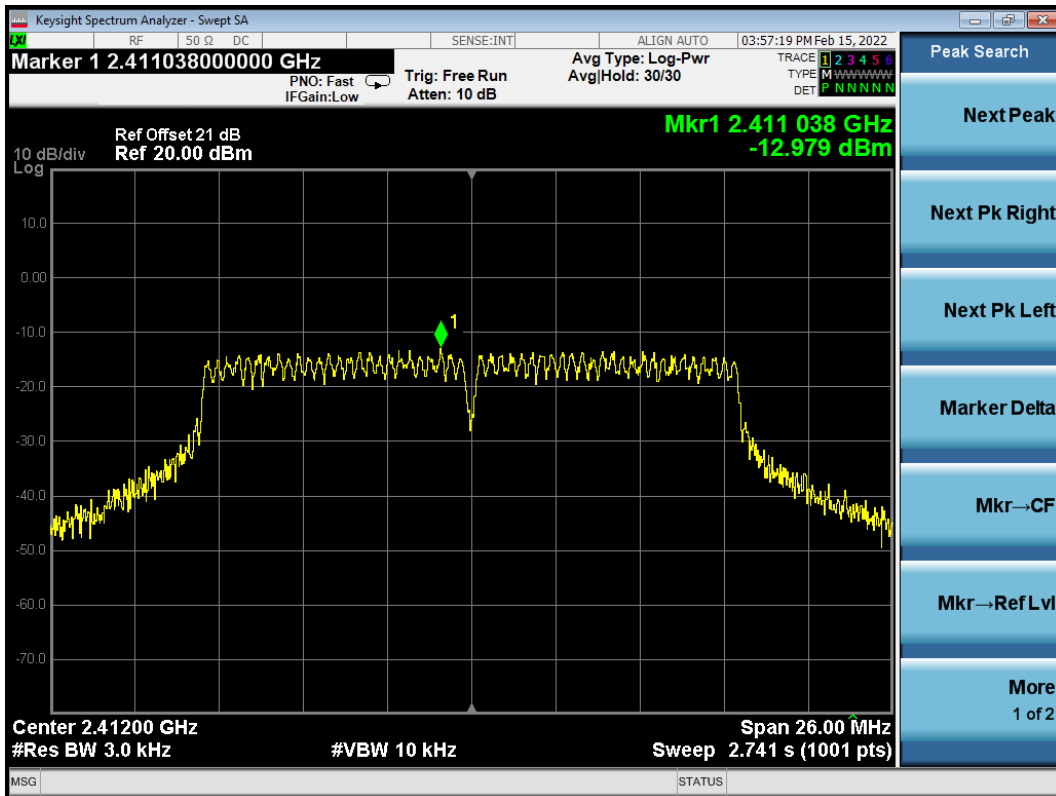

802.11g CH2437 MHz

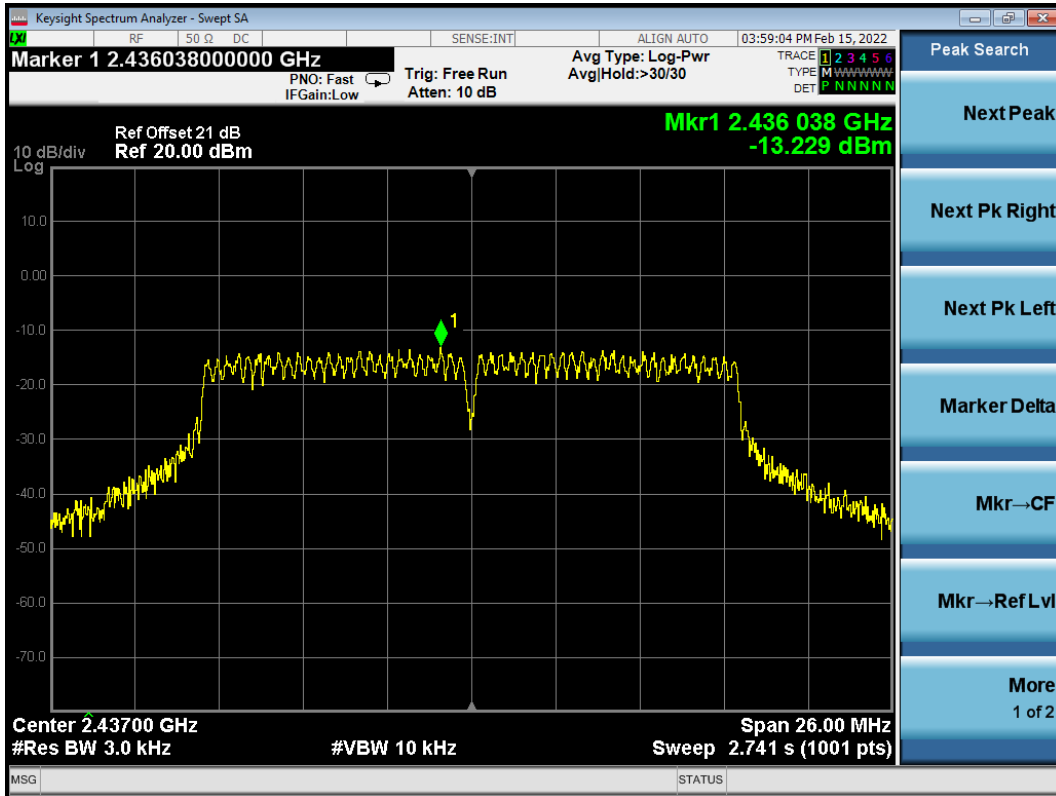

802.11g CH2462 MHz

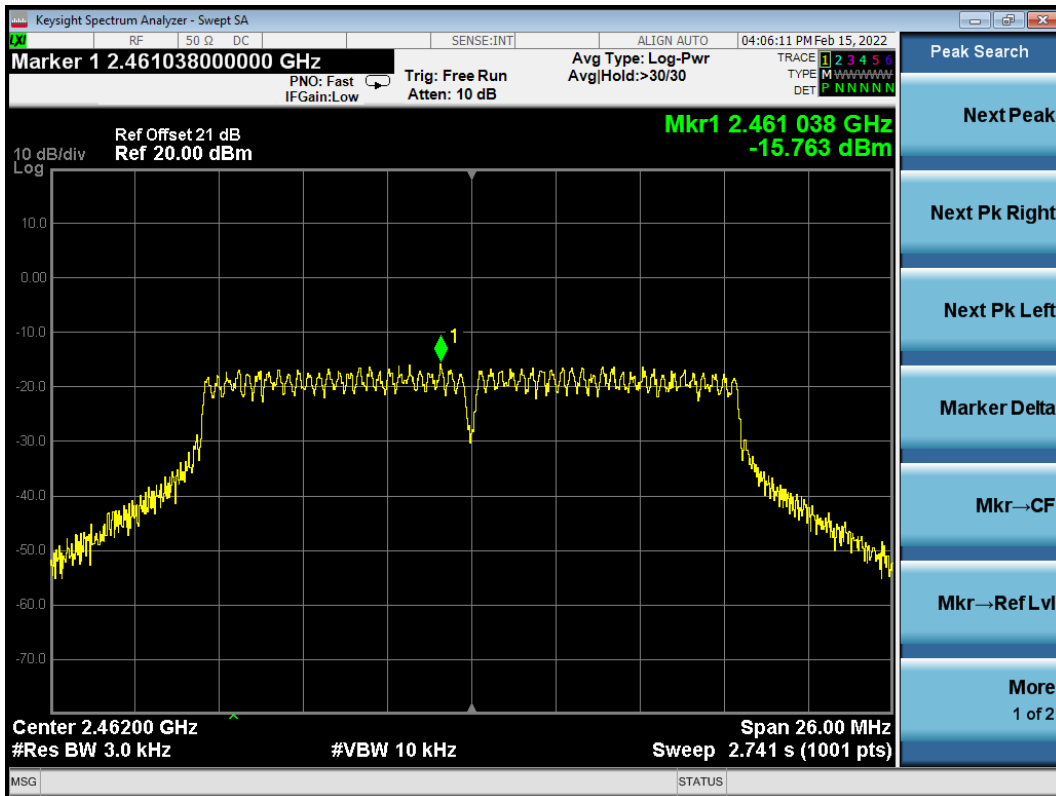

802.11n20 CH2412 MHz

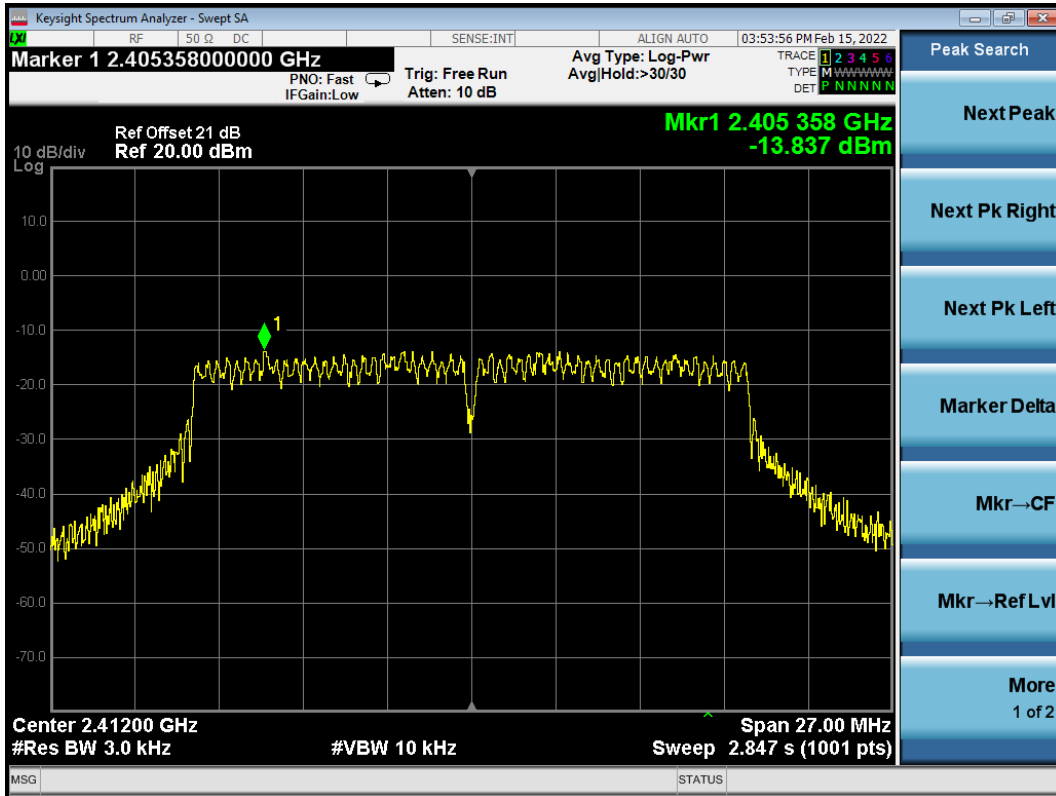

802.11n20 CH2437 MHz

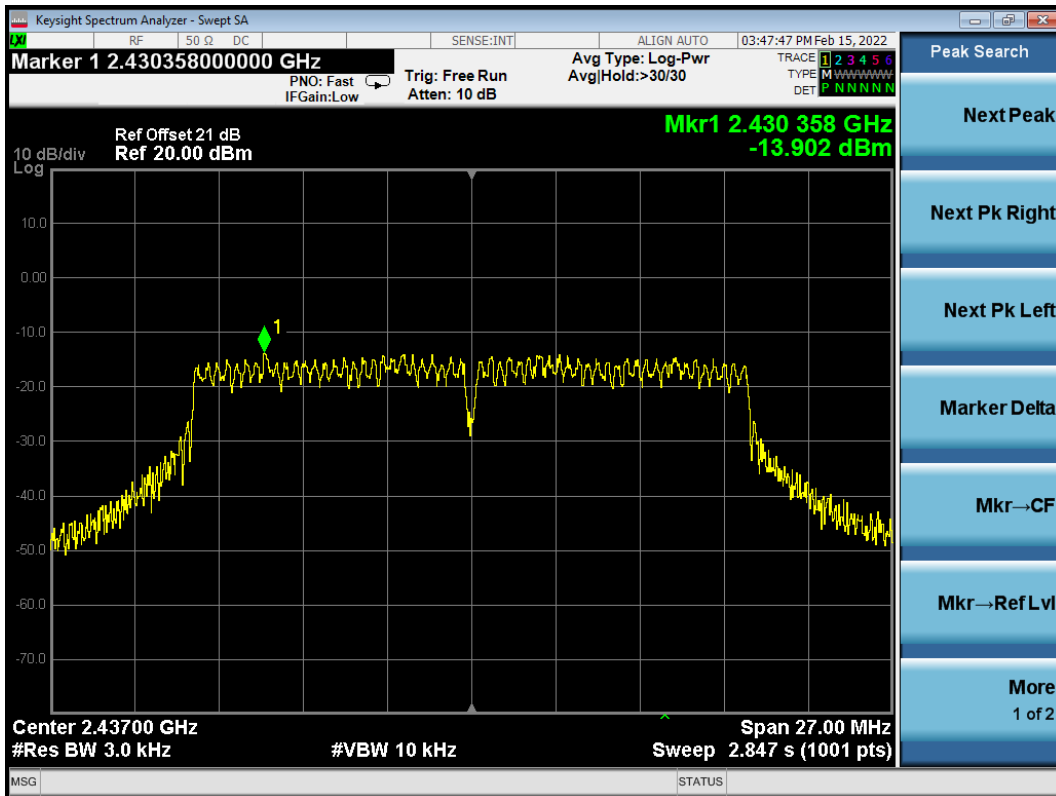

802.11n20 CH2462 MHz

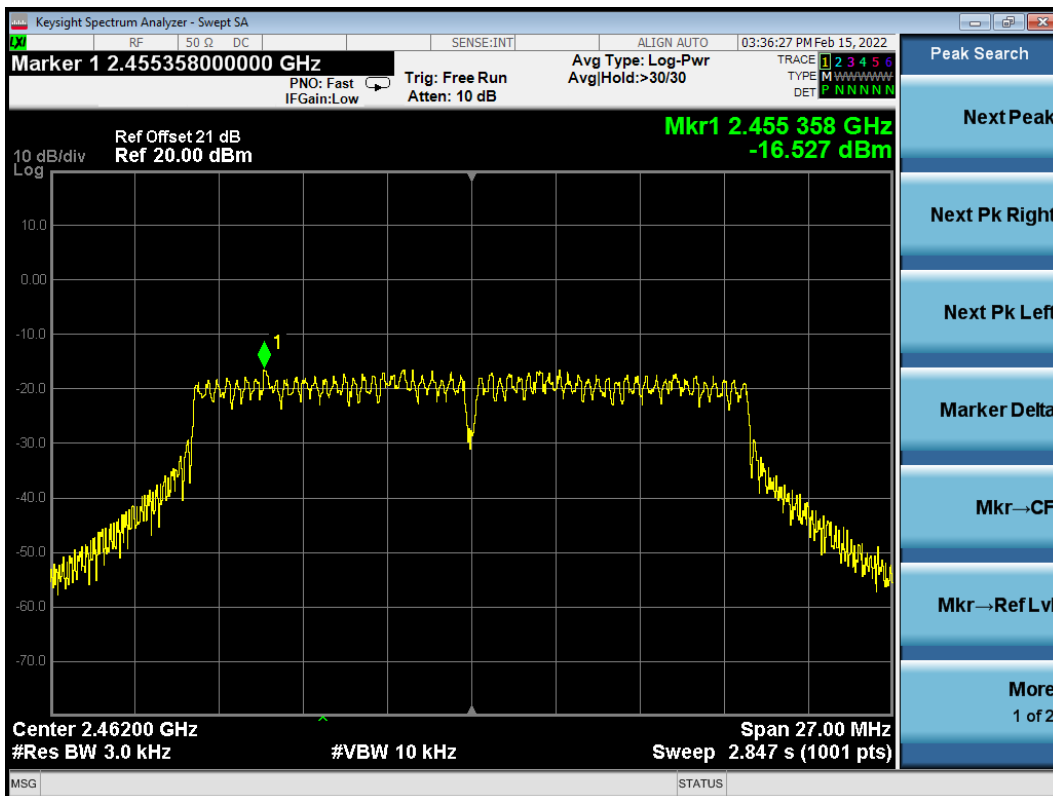

10 DEVIATION TO TEST SPECIFICATIONS

None.

11 MEASUREMENT UNCERTAINTY LIST

The measurement uncertainty was estimated for test on the EUT according to CISPR 16-4-2. This uncertainty represents an expanded uncertainty expressed at approximately the 95% confidence level using a coverage of K=2.

The uncertainties value is not used in determining the PASS/FAIL results.

Test Items/Facilities	Frequency/Equipment/Unit	Uncertainty
Conducted Emission No.1 Shielded Room	9kHz~150kHz	±3.1 dB
	150kHz~30MHz	±2.6 dB
Conducted Emission No.3 Shielded Room	9kHz~150kHz	±3.1 dB
	150kHz~30MHz	±2.6 dB
Radiated Emission	30MHz~200MHz, Horizontal	±3.8 dB
	30MHz~200MHz, Vertical	±4.1 dB
	200MHz~1000MHz, Horizontal	±3.6 dB
	200MHz~1000MHz, Vertical	±5.1 dB
	1GHz~6GHz	±5.3 dB
	6GHz~18GHz	±5.3 dB
	18GHz~40GHz	±3.5 dB
Output Power Test	50MHz~18GHz	0.77 dB
Power Density Test	9kHz~6GHz	1.08 dB
RF Frequency Test	9kHz~40GHz	6×10^{-4}
Bandwidth Test	9kHz~6GHz	1.5×10^{-3}
RF Radiated Power Test	30MHz~1000MHz	3.06 dB
Conducted Output Power Test	50MHz~18GHz	0.83 dB
AC Voltage(<10kHz) Test	120V~230V	0.04 %
DC Power Test	0V~30V	0.4 %
Temperature	-40°C~+100°C	0.52 °C
Humidity	30%~95%	2.6 %