

TEST REPORT
On behalf of

Savant Technologies LLC, dba GE Lighting, a Savant company

Product Name: 120 Vac Dual 20 A Wiser Control Relay

Model No.: QO200PWX120

FCC ID: PUU-QOPWX20120

Prepared For: Savant Technologies LLC, dba GE Lighting, a Savant company
1975 Noble Road, Cleveland, OH 44112

Prepared By: Audix Technology (Shanghai) Co., Ltd.
3F, Building 34, No. 680 Guiping Rd.,
Caohejing, Hi-Tech Park,
Shanghai 200233, China

Tel: +86-21-64955500



File No. : C1D2401011
Report No. : ACI-F24022
Date of Test : 2024.01.15-26
Date of Report : 2024.01.31

The statement is based on a single evaluation of one sample of the above-mentioned products. It does not imply an assessment of the whole production and does not permit the use of the test lab logo. The report must not be used by the client to claim product certification, approval, or endorsement by NVLAP, NIST, or any agency of the U.S. government.

TABLE OF CONTENTS

	Page
1 SUMMARY OF STANDARDS AND RESULTS.....	5
1.1 Description of Standards and Results.....	5
2 GENERAL INFORMATION.....	6
2.1 Description of Equipment Under Test.....	6
2.2 EUT Specifications Assessed in Current Report.....	7
2.3 Test Information	7
2.4 Duty Cycle Check	7
2.5 Sample Description	8
2.6 Supported equipment.....	8
2.7 Description of Test Facility	8
3 CONDUCTED EMISSION TEST	9
3.1 Test Equipment.....	9
3.2 Block Diagram of Test Setup	9
3.3 Conducted Emission Limits (§15.207).....	10
3.4 Test Configuration.....	10
3.5 Operating Condition of EUT	10
3.6 Test Procedures	10
3.7 Test Results	11
4 RADIATED EMISSION TEST.....	14
4.1 Test Equipment.....	14
4.2 Block Diagram of Test Setup	15
4.3 Radiated Emission Limit (§15.209)	16
4.4 Test Configuration.....	16
4.5 Operating Condition of EUT	16
4.6 Test Procedures	16
4.7 Test Results	18
5 6 DB BANDWIDTH MEASUREMENT	31
5.1 Test Equipment.....	31
5.2 Block Diagram of Test Setup	31
5.3 Specification Limits (§15.247(a)(2)).....	31
5.4 Operating Condition of EUT	31
5.5 Test Procedure	31
5.6 Test Results	32
6 MAXIMUM PEAK OUTPUT POWER MEASUREMENT.....	34
6.1 Test Equipment.....	34
6.2 Block Diagram of Test Setup	34
6.3 Specification Limits ((§15.247(b)(3))	34
6.4 Operating Condition of EUT	34
6.5 Test Procedure	34
6.6 Test Results	35
7 EMISSION LIMITATIONS MEASUREMENT.....	37
7.1 Test Equipment.....	37
7.2 Block Diagram of Test Setup	37

7.3 Specification Limits (§15.247(d)) 37

7.4 Operating Condition of EUT 37

7.5 Test Procedure 37

7.6 Test Results 39

8 POWER SPECTRAL DENSITY MEASUREMENT 43

8.1 Test Equipment..... 43

8.2 Block Diagram of Test Setup 43

8.3 Specification Limits (§15.247(e)) 43

8.4 Operating Condition of EUT 43

8.5 Test Procedure 43

8.6 Test Results 44

9 ANTENNA REQUIREMENT 46

9.1 Specification Limits (§15.203)..... 46

9.2 Result..... 46

10 DEVIATION TO TEST SPECIFICATIONS 47

11 MEASUREMENT UNCERTAINTY LIST 48

APPENDIX I PHOTOGRAPHS OF TEST

APPENDIX II PHOTOGRAPHS OF EUT

TEST REPORT

Applicant : Savant Technologies LLC, dba GE Lighting, a Savant company
 EUT Description : 120 Vac Dual 20 A Wiser Control Relay
 (A) Model No. : Refer to Sec.2.1
 (B) Power Supply : 120V AC 60Hz
 (C) Test Voltage : 120V/60Hz

Test Procedure Used:

FCC RULES AND REGULATIONS PART 15 SUBPART C
 AND ANSI C63.10-2013

The device described above is tested by Audix Technology (Shanghai) Co., Ltd. to determine the maximum emission levels emanating from the device. The maximum emission levels are compared to the FCC Part 15 Subpart C limits.

The test results are contained in this test report and Audix Technology (Shanghai) Co., Ltd. is assumed full responsibility for the accuracy and completeness of these measurements. This report also shows that the EUT (M/N: Refer to Sec2.1), which was tested is technically compliance with the FCC limits.

This report applies to above tested Sample only. This report shall not be reproduced in part without written approval of Audix Technology (Shanghai) Co., Ltd.

Date of Test : 2024.01.15-26 Date of Report : 2024.01.31

Producer : Mindy Wang
 MINDY WANG / Assistant

Review : Lvy - W
 Lvy_Lv / Deputy Assistant Manager

 For and on behalf of
 Audix Technology (Shanghai) Co., Ltd.

Signatory : Kamp Chen
 Authorized Signature(s) KAMP CHEN / Manager

1 SUMMARY OF STANDARDS AND RESULTS

1.1 Description of Standards and Results

The EUT have been tested according to the applicable standards as referenced below:

Description / Test Item	Test Standard	Results	Meets Limit
EMISSION			
Conducted Emission	FCC RULES AND REGULATIONS PART 15 SUBPART C AND ANSI C63.10:2013	Pass	15.207
Radiated Emission	FCC RULES AND REGULATIONS PART 15 SUBPART C AND ANSI C63.10:2013	Pass	15.209(a) 15.205(a)(c)
6 dB Bandwidth Measurement	FCC RULES AND REGULATIONS PART 15 SUBPART C AND ANSI C63.10:2013	Pass	15.247(a)(2)
Maximum Peak Output Power Measurement	FCC RULES AND REGULATIONS PART 15 SUBPART C AND ANSI C63.10:2013	Pass	15.247(b)(3)
Emission Limitations Measurement	FCC RULES AND REGULATIONS PART 15 SUBPART C AND ANSI C63.10:2013	Pass	15.247(d)
Band Edge Measurement	FCC RULES AND REGULATIONS PART 15 SUBPART C AND ANSI C63.10:2013	Pass	15.247(d)
Power Spectral Density Measurement	FCC RULES AND REGULATIONS PART 15 SUBPART C AND ANSI C63.10:2013	Pass	15.247(e)
Antenna Requirement	FCC RULES AND REGULATIONS PART 15 SUBPART C AND ANSI C63.10:2013	Pass	15.203
N/A is an abbreviation for Not Applicable.			

2 GENERAL INFORMATION

2.1 Description of Equipment Under Test

Description : 120 Vac Dual 20 A Wiser Control Relay

Type of EUT : Production Pre-product Pro-type

Model Number : QO200PWX120

Radio Tech : ZigBee;

Channel Freq. : ZigBee: 2405MHz-2480MHz;

Modulation : ZigBee: QOPSK;

Antenna Info. : Antenna Type: PCB Antenna
Antenna Gain: 1.49 dBi

Applicant : Savant Technologies LLC, dba GE Lighting, a Savant company
1975 Noble Road, Cleveland, OH 44112

Manufacturer : same as Applicant

Factory : LEEDARSON LIGHTING CO., LTD
Xingtai Industrial Zone, Economic Development Zone,
Changtai County Zhangzhou

2.2 EUT Specifications Assessed in Current Report

Mode	Modulation	Data Rate(kbps)
ZigBee	QOPSK	250

Channel List			
Channel No.	Frequency (MHz)	Channel No.	Frequency (MHz)
11	2405	19	2445
12	2410	20	2450
13	2415	21	2455
14	2420	22	2460
15	2425	23	2465
16	2430	24	2470
17	2435	25	2475
18	2440	26	2480

2.3 Test Information

The test software “sscom5.13.1.exe” was used to control EUT work in TX mode, Power Setting and select test channel.

Mode	data rate (kbps)	Power Setting	Test Channel		Frequency (MHz)
ZigBee	250	0	Low:	11	2405
		0	Middle:	19	2445
		0	High:	26	2480

2.4 Duty Cycle Check

Mode	Transmission Duration (ms)	Transmission Period (ms)	Duty Cycle (%)
ZigBee	4.296	16.76	25.63

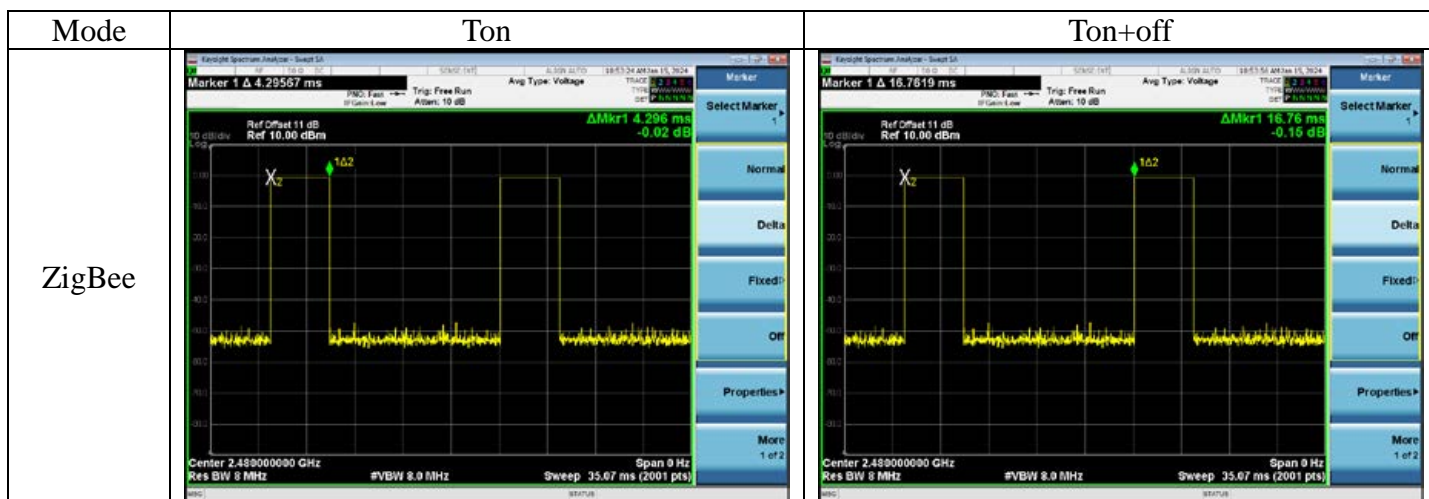

2.5 Sample Description

Test Item	Model Number	Sample Number	Date of receipted
Conducted Emission	QO200PWX120	E20240109030-02/03	2024.01.09
Radiated Emission	QO200PWX120	E20240109030-02/03	2024.01.09
Conducted RF Test	QO200PWX120	E20240109030-03/03	2024.01.09

2.6 Supported equipment

Brand : Acer
Product Name: : Notebook PC
Model Name : TravelMate P238 series
Model Number : N15W8

Product Name : Test Fixture
Mode Number : J-OB V2
Product Function : USB to TTL

2.7 Description of Test Facility

Name of Firm : Audix Technology (Shanghai) Co., Ltd.
Site Location : 3F, Building 34, No. 680 Guiping Rd.,
Caohejing, Hi-Tech Park,
Shanghai 200233, China
Accredited by NVLAP, Lab Code : 200371-0
FCC Designation Number : CN5027
Test Firm Registration Number : 954668

3 CONDUCTED EMISSION TEST

3.1 Test Equipment

The following test equipments are used during the conducted emission test in a shielded room:

Item	Type	Manufacturer	Model No.	Serial No.	Cal. Date	Cal. Interval
1.	Test Receiver	R&S	ESCI	101302	2023.02.22	1 Year
2.	Artificial Mains Network (AMN)	R&S	ESH2-Z5	843890/011	2023.02.22	1 Year
3.	Fixed Attenuator	SHYL	TTS-1	001	2023.02.22	1 Year
4.	50Ω Coaxial Switch	ANRITSU	MP59B	6200655086	2023.02.22	1 Year
5.	Coaxial Cable	HANWEI	RG223/U	KJ09052	2023.02.22	1 Year
6.	Software	Audix	e3	210616	--	--

3.2 Block Diagram of Test Setup

3.2.1 Conducted Disturbance Test Setup

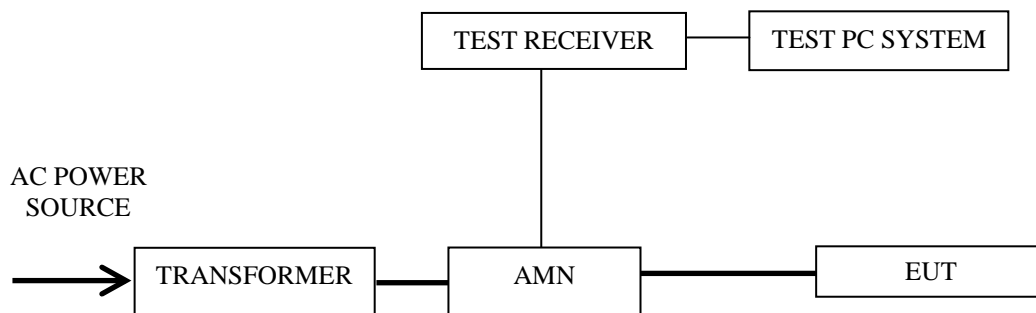

— : Signal Line
 — : Power Line

3.3 Conducted Emission Limits (§15.207)

Frequency Range (MHz)	Limits dB(µV)	
	Quasi-peak	Average
0.15 ~ 0.5	66~56	56~46
0.5 ~ 5	56	46
5 ~ 30	60	50

NOTE 1 – The lower limit shall apply at the transition frequencies.
 NOTE 2 – The limit decreases linearly with the logarithm of the frequency in the range 0.15 MHz~0.50 MHz

3.4 Test Configuration

The EUT (listed in Sec.2.1) was installed as shown on Sec.3.2 to meet FCC requirement and operating in a manner which tends to maximize its emission level in a normal application.

3.5 Operating Condition of EUT

- 3.5.1 Setup the EUT as shown in Sec. 3.2.
- 3.5.2 Turn on the power of all equipment.
- 3.5.3 Turn the EUT on the test mode, and then test.

3.6 Test Procedures

The EUT was placed upon a non-metallic table, which is 0.8 m above the horizontal conducting ground plane and 0.4 m from a vertical reference plane. The EUT was connected to the power mains through an Artificial Mains Network (AMN) to provide a 50 Ω coupling impedance for the measuring equipment. Both sides of AC line (Line & Neutral) were checked to find out the maximum conducted emission according to FCC Part 15 Subpart C and ANSI C63.10: 2013 requirements during conducted disturbance test.

The I.F. bandwidth of Test Receiver ESCI was set at 9 kHz.

The frequency range from 150 kHz to 30 MHz was checked.

Test with a dummy load in lieu of the antenna to determine compliance with Section 15.207 limits within the transmitter's fundamental emission band. (According to KDB 174176 D01 Line Conducted FAQ)

The test modes were done on conducted disturbance test and all the test results are listed in Sec. 3.7

3.7 Test Results

< **PASS** >

The frequency and amplitude of the highest conducted emission relative the limit is reported. All the emissions not reported below are too low against the FCC limit.

Worst case emission:

No.	Operation	Mode	Channel	Frequency (MHz)	Data Page
1.	Transmitting	ZigBee	11	2405	P12-13

NOTE 1 – Emission Level = Read Level + AMN Factor + Aux Factor + Cable Loss
Margin = Limits - Emission Level

NOTE 2 – “QP” means “Quasi-Peak” values

NOTE 3 – The emission levels which not reported are too low against the official limit.

Worst case emission

Test Date:	2024.01.26	Temp./Hum.:	22°C/51%RH	Test By:	Jarey
------------	------------	-------------	------------	----------	-------

Mode: Zigbee CH2405MHz

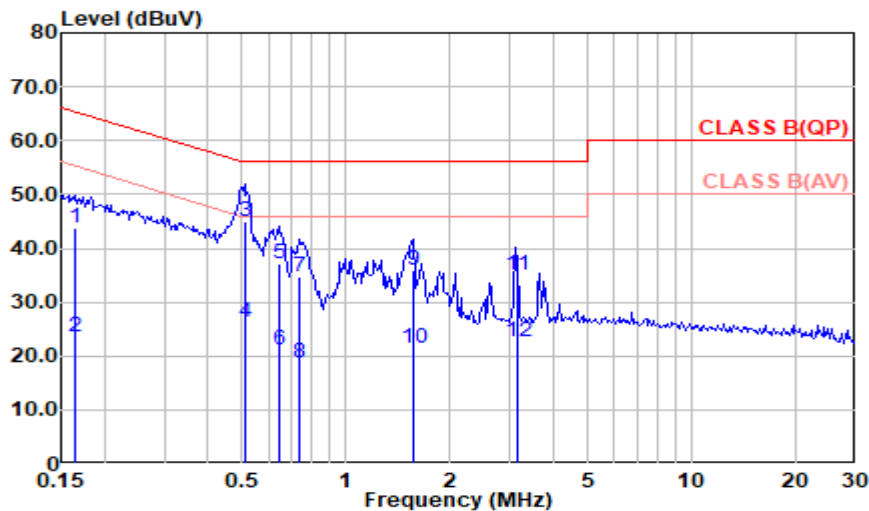

Polarization at Line

Frequency (MHz)	Meter Reading dB (mV)	AMN Factor (dB)	Aux Factor (dB)	Cable Loss (dB)	Emission Level dB (mV)	Limits dB (mV)	Margin (dB)	Remark
0.166	34.00	0.20	9.49	0.10	43.79	65.17	21.38	QP
0.166	13.75	0.20	9.49	0.10	23.54	55.17	31.63	Average
0.509	35.34	0.20	9.49	0.10	45.13	56.00	10.87	QP
0.509	16.37	0.20	9.49	0.10	26.16	46.00	19.84	Average
0.640	27.31	0.20	9.49	0.10	37.10	56.00	18.90	QP
0.640	11.20	0.20	9.49	0.10	20.99	46.00	25.01	Average
0.736	25.06	0.20	9.49	0.10	34.85	56.00	21.15	QP
0.736	9.05	0.20	9.49	0.10	18.84	46.00	27.16	Average
1.567	26.17	0.20	9.49	0.10	35.96	56.00	20.04	QP
1.567	11.70	0.20	9.49	0.10	21.49	46.00	24.51	Average
3.140	25.32	0.20	9.49	0.10	35.11	56.00	20.89	QP
3.140	12.93	0.20	9.49	0.10	22.72	46.00	23.28	Average

Mode: Zigbee CH2405MHz

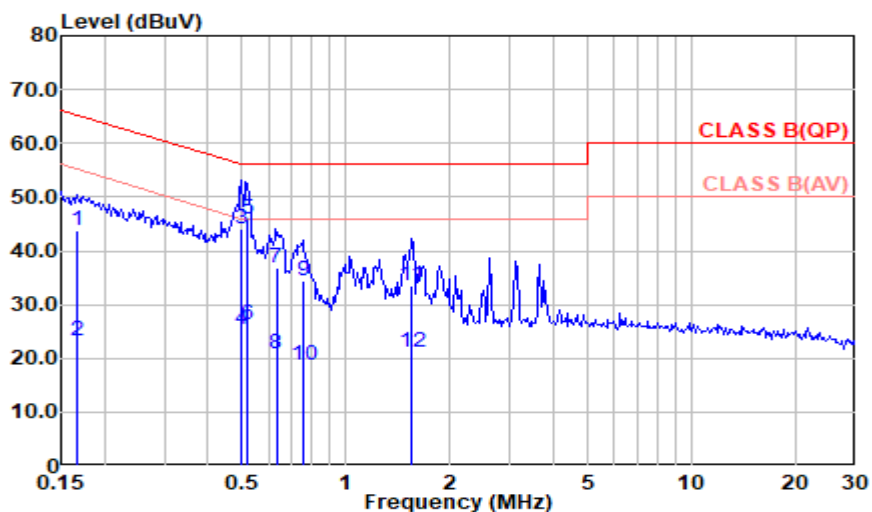

Polarization at Neutral

Frequency (MHz)	Meter Reading dB (mV)	AMN Factor (dB)	Aux Factor (dB)	Cable Loss (dB)	Emission Level dB (mV)	Limits dB (mV)	Margin (dB)	Remark
0.167	33.94	0.20	9.49	0.10	43.73	65.09	21.36	QP
0.167	13.46	0.20	9.49	0.10	23.25	55.09	31.84	Average
0.499	34.42	0.20	9.49	0.10	44.21	56.02	11.81	QP
0.499	15.57	0.20	9.49	0.10	25.36	46.02	20.66	Average
0.516	36.13	0.20	9.49	0.10	45.92	56.00	10.08	QP
0.516	16.41	0.20	9.49	0.10	26.20	46.00	19.80	Average
0.630	26.90	0.20	9.49	0.10	36.69	56.00	19.31	QP
0.630	11.13	0.20	9.49	0.10	20.92	46.00	25.08	Average
0.751	24.53	0.20	9.49	0.10	34.32	56.00	21.68	QP
0.751	8.92	0.20	9.49	0.10	18.71	46.00	27.29	Average
1.551	23.61	0.30	9.49	0.10	33.50	56.00	22.50	QP
1.551	11.16	0.30	9.49	0.10	21.05	46.00	24.95	Average

4 RADIATED EMISSION TEST

4.1 Test Equipment

The following test equipment are used during the radiated emission test in a semi-anechoic chamber:

Item	Type	Manufacturer	Model No.	Serial No.	Cal. Date	Cal. Interval
1.	Preamplifier	Agilent	8447D	2944A10548	2023.02.22	1 Year
2.	Preamplifier	HP	8449B	3008A00864	2023.02.22	1 Year
3.	Spectrum Analyzer	Agilent	N9010A	MY52221182	2023.08.09	1 Year
4.	Test Receiver	R&S	ESCI	101303	2023.02.22	1 Year
5.	Bilog Antenna+6dB Attenuator	Schwarz beck	VULB 9168+EMCI-N-6-06	708+AT-N0638	2023.02.07	1 Year
6.	Horn Antenna	EMCO	3115	00062593	2023.08.02	1 Year
7.	Horn Antenna	EMCO	3116	00062643	2023.01.30	2 Year
8.	Cavity Band Rejection Filter	Microwave	WT-A3882-R10	WT200312-1-1	2023.02.22	1 Year
9.	Coaxial Switch	Anritsu	MP59B	6200655086	2023.02.22	1 Year
10.	Coaxial Cable	SCHAFFNER	RG 212U-MIL C 17 +N1K50-EW0630- N1K50-15m-1	RE-10m-001/ RE-15m-002	2023.02.22	1 Year
11.	Software	Audix	e3	e3.v9.210616	--	--

4.2 Block Diagram of Test Setup

4.2.1 EUT & Peripherals



4.2.2 Below 1GHz

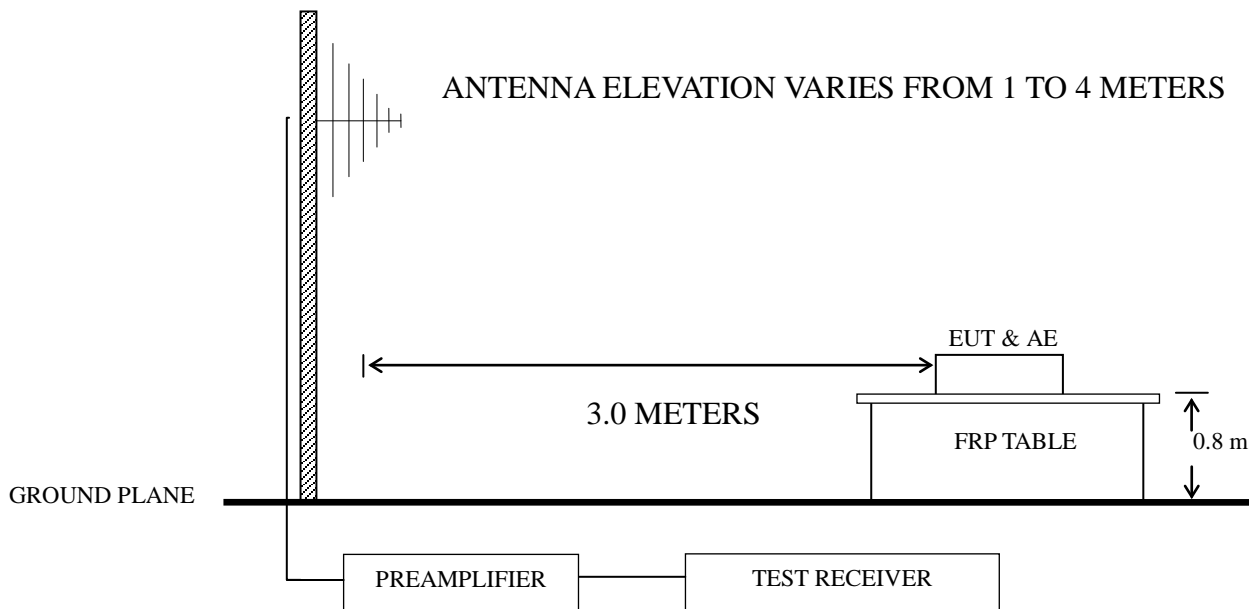

4.2.3 Above 1GHz

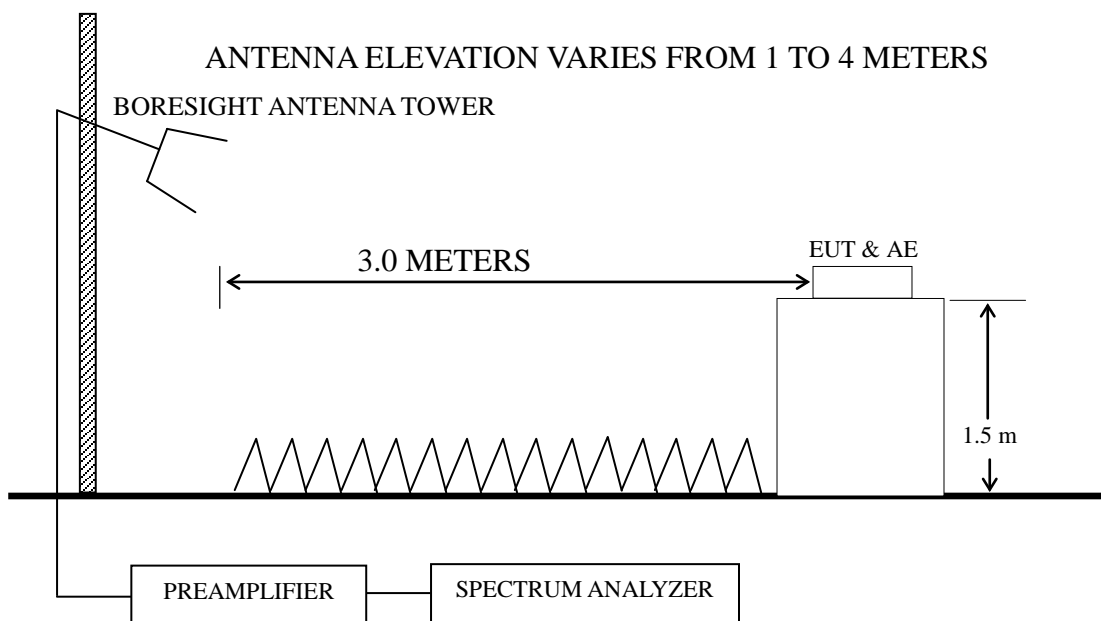

4.3 Radiated Emission Limit (§15.209)

Frequency (MHz)	Distance (m)	Field strength limits (nV/m)	
		(nV/m)	dB(nV/m)
30 ~ 88	3	100	40.0
88 ~ 216	3	150	43.5
216 ~ 960	3	200	46.0
Above 960	3	500	54.0

NOTE 1 - Emission Level dB (nV/m) = 20 log Emission Level (nV/m)
 NOTE 2 - The tighter limit applies at the band edges.
 NOTE 3 - Distance refers to the distance in meters between the measuring instrument antenna and the closed point of any part of the device or system.
 NOTE 4 - The limits shown are based on Quasi-peak value detector below or equal to 1GHz and Average value detector above 1GHz.
 NOTE 5 - Above 1 GHz, the limit on peak emission is 20 dB above the maximum permitted average emission limit applicable to the EUT

4.4 Test Configuration

The EUT (listed in Sec.2.1) and the simulators (listed in Sec.2.2) were installed as shown on Sec.4.2 to meet FCC requirements and operating in a manner that tends to maximize its emission level in a normal application.

4.5 Operating Condition of EUT

4.5.1 Setup the EUT as shown in Sec. 4.2.

4.5.2 Turn the EUT on.

4.5.3 Connect the EUT and the TTL terminal of Test Fixture through three HCI cables of EUT, as follows (TX to RXD, RX to TXD, GND to GND). Plug the USB terminal of Test Fixture to the USB port of Notebook PC.

4.5.4 Use the software as section 2.3 to select the test mode, then disconnect the Test Fixture from EUT, remove the Test Fixture and Notebook PC, then test.

4.5.5 Repeat step 4.5.3 and 4.5.4, until the test of all modes finished.

4.6 Test Procedures

Radiated emission test applies to harmonics/spurs that fall in the restricted bands listed in Section 15.205. The maximum permitted average field strength is listed in Section 15.209. A pre-amp is necessary for this measurement. For measurement above 1 GHz, set RBW = 1MHz, VBW = 10 Hz, Sweep: Auto. If the emission is pulsed, modify the unit for continuous operation; use the settings shown above, then correct the reading by subtracting the peak-average correction factor, derived from the appropriate duty cycle calculation.

The EUT was placed on a turntable. Below 1 GHz, the table height is 80 cm above the reference ground plane. Above 1 GHz, the table height is 1.5 m. The turntable rotated 360 degrees to determine the position of the maximum emission level. The EUT was set 3 meters away from the receiving antenna, which was mounted on an antenna tower. The antenna moved up and down

between 1 meter and 4 meters to find out the maximum emission level. Broadband antenna (Calibrated Bilog Antenna) or Horn antenna was used as receiving antenna. Both horizontal and vertical polarizations of the antenna were set on measurement. In order to find the maximum emission, all of the interference cables were manipulated according to ANSI C63.10: 2013 requirements during radiated emission test.

The bandwidth of Test Receiver R&S ESCI was set at 120 kHz from 30MHz to 1000MHz.

The bandwidth of Agilent N9010A was set at 1MHz for above 1GHz.

The frequency range from 30 MHz to 25 GHz (Up to 10th harmonics from fundamental frequency) was checked.

All the test results are listed in Sec.4.7.

4.7 Test Results

<PASS>

The frequency and amplitude of the highest radiated emission relative the limit is reported. All the emissions not reported below are too low against the FCC limit.

Frequency range: below 1GHz (Worst case emission)

No.	Operation	Mode	Channel	Frequency	Data Page
1.	Transmitting	ZigBee	11	2405 MHz	P19-20

Frequency range: above 1GHz

No.	Operation	Mode	Channel	Frequency	Data Page
1.	Transmitting	ZigBee	11	2405 MHz	P21-22
2.			19	2445 MHz	P23-24
3.			26	2480 MHz	P25-26

Band-Edge and Restricted bands:

No.	Operation	Mode	Channel	Frequency	Data Page
1.	Transmitting	ZigBee	11	2405 MHz	P27-28
2.			26	2480 MHz	P29-30

NOTE 1 – Emission Level = Read Level + Antenna Factor + Cable Loss - Preamp Factor
Margin = Limits - Emission Level.

NOTE 2 – “QP” means “Quasi-Peak” values.

NOTE 3 – 0° was the table front facing the antenna. Degree is calculated from 0° clockwise facing the antenna.

NOTE 4 – The emission levels which not reported are too low against the official limit.

NOTE 5 – The emission levels recorded below is data of EUT configured in Side direction, for this direction was the maximum emission direction during the test. The data of Standing & Lying direction are too low against the official limit to be reported.

NOTE 6 – All reading are Quasi-Peak values below or equal to 1GHz, Peak and Average values above 1GHz.

For above 1GHz test, if the peak measured value complies with the average limit, it is unnecessary to perform an average measurement.

NOTE 7 – The frequency range 2310-2390MHz & 2483.5-2500MHz were tested for Restricted bands.

Radiated emission < 1GHz

Test Date:	2024.01.21	Temp./Hum.:	22°C/51%RH	Test By:	Jarey
------------	------------	-------------	------------	----------	-------

Mode: ZigBee CH2405MHz

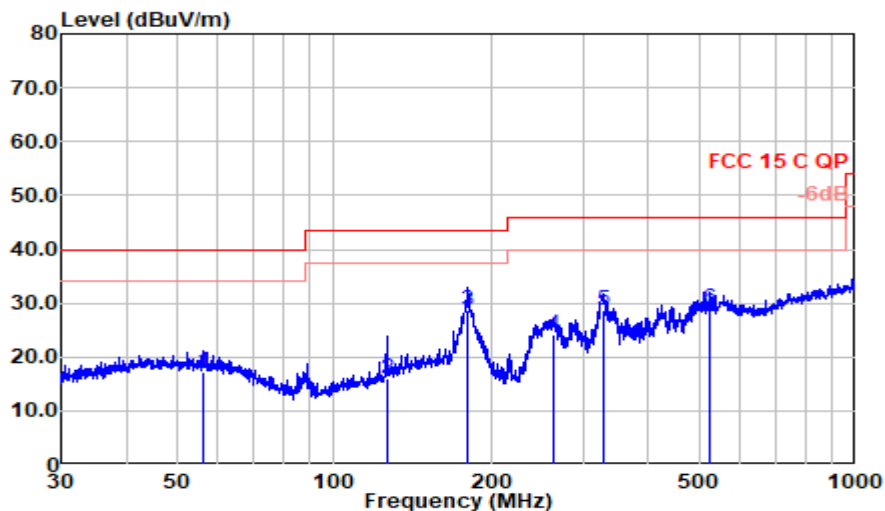

Polarization at Horizontal

Frequency (MHz)	Meter Reading dB (µV)	Antenna Factor (dB/m)	Cable Loss (dB)	Preamp Factor (dB)	Emission Level dB (µV/m)	Limits dB (µV/m)	Margin (dB)	Remark
56.001	26.70	19.60	0.82	29.88	17.24	40.00	22.76	QP
126.107	27.11	17.11	1.24	29.56	15.91	43.50	27.59	QP
180.966	39.11	17.50	1.51	29.30	28.82	43.50	14.68	QP
262.435	33.52	18.05	1.77	29.06	24.28	46.00	21.72	QP
329.039	35.36	20.20	1.97	28.82	28.71	46.00	17.29	QP
522.718	32.02	23.90	2.55	29.36	29.11	46.00	16.89	QP

Mode: ZigBee CH2405MHz

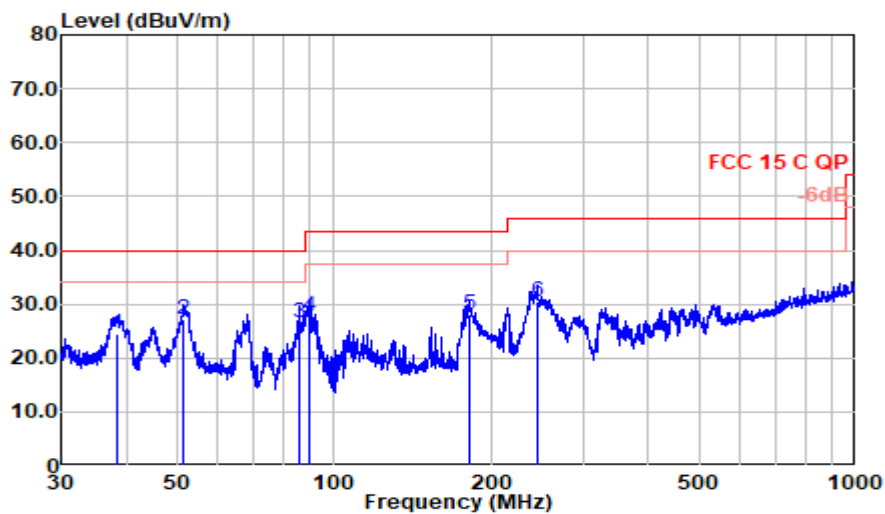

Polarization at Vertical

Frequency (MHz)	Meter Reading dB (mV)	Antenna Factor (dB/m)	Cable Loss (dB)	Preamp Factor (dB)	Emission Level dB (mV/m)	Limits dB (mV/m)	Margin (dB)	Remark
38.279	34.38	19.33	0.68	29.90	24.48	40.00	15.52	QP
51.301	36.34	19.80	0.78	29.89	27.03	40.00	12.97	QP
85.748	41.26	14.03	1.03	29.77	26.54	40.00	13.46	QP
90.062	42.63	13.91	1.07	29.75	27.86	43.50	15.64	QP
181.920	38.40	17.32	1.51	29.30	27.93	43.50	15.57	QP
245.090	40.21	17.60	1.72	29.17	30.36	46.00	15.64	QP

Radiated Emission > 1GHz

Test Date:	2024.01.25	Temp./Hum.:	22°C/51%RH	Test By:	Jarey
------------	------------	-------------	------------	----------	-------

Mode: ZigBee CH2405MHz

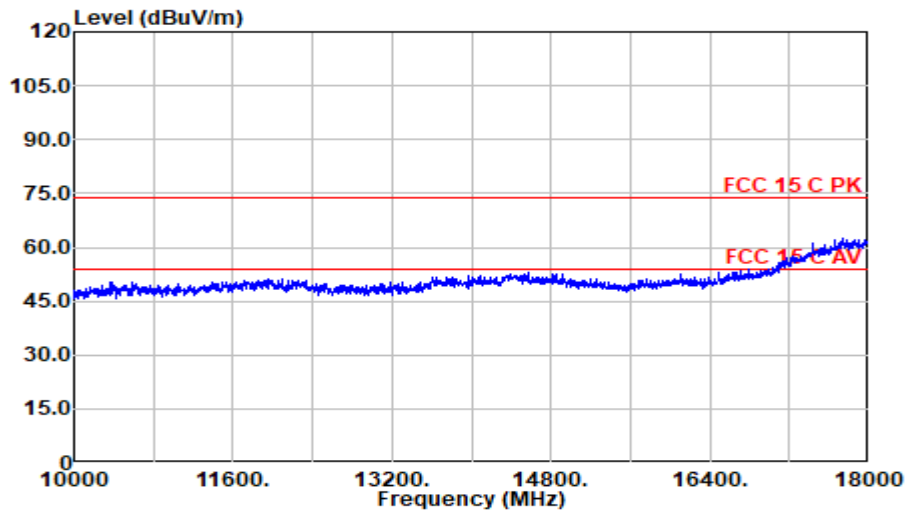
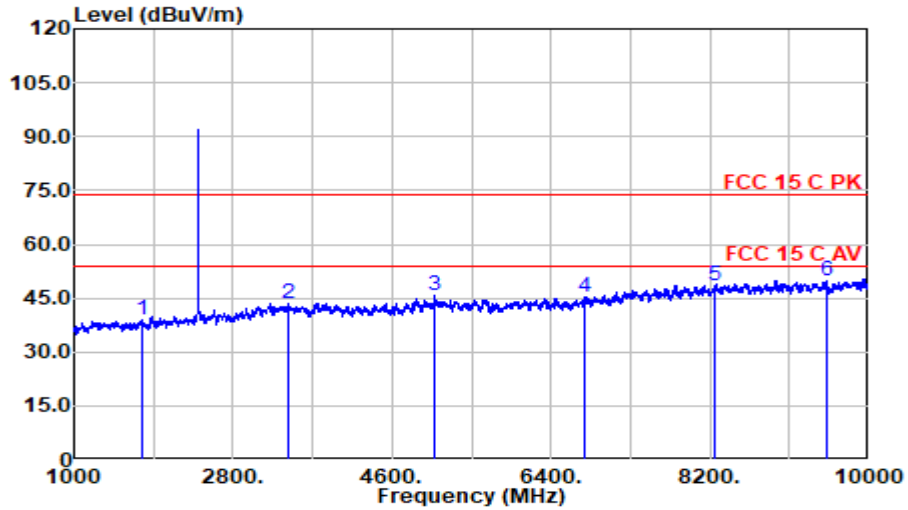

Polarization at Horizontal

Frequency (MHz)	Meter Reading dB (mV)	Antenna Factor (dB/m)	Cable Loss (dB)	Preamp Factor (dB)	Emission Level dB (mV/m)	Limits dB (mV/m)	Margin (dB)	Remark
1765.000	43.91	26.78	4.74	36.50	38.92	74.00	35.08	Peak
3425.500	41.01	31.45	6.28	35.22	43.52	74.00	30.48	Peak
5090.500	38.90	33.58	7.87	34.60	45.75	74.00	28.25	Peak
6787.000	35.54	35.33	9.08	34.60	45.35	74.00	28.65	Peak
8249.500	35.05	37.80	10.39	34.85	48.39	74.00	25.61	Peak
9514.000	34.85	38.34	11.06	34.65	49.61	74.00	24.39	Peak

Mode: ZigBee CH2405MHz

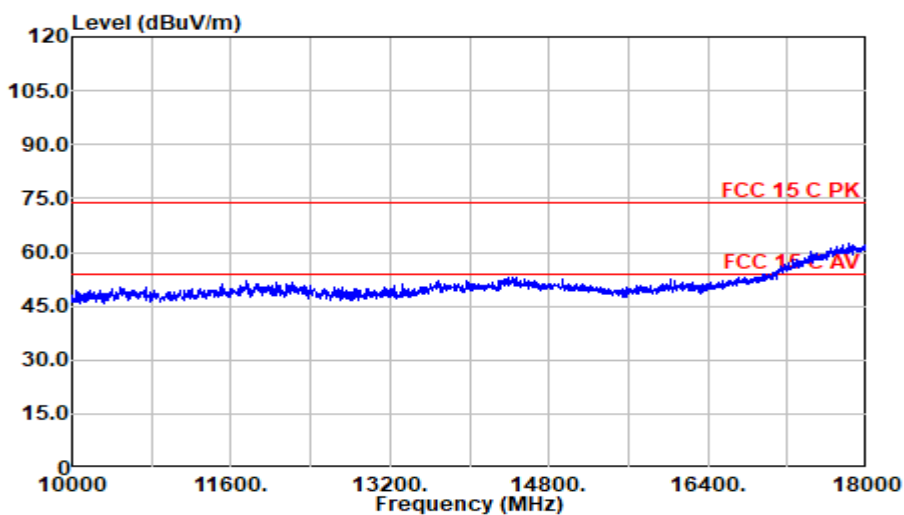
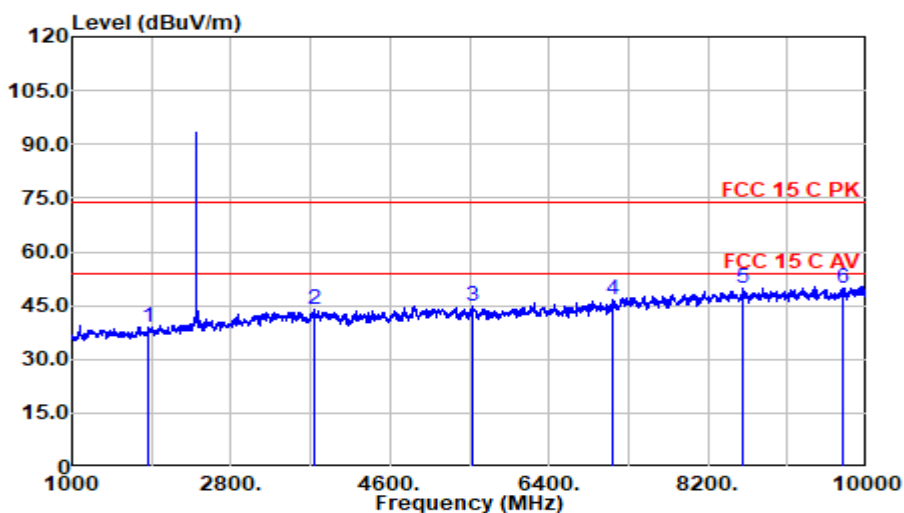

Polarization at Vertical

Frequency (MHz)	Meter Reading dB (mV)	Antenna Factor (dB/m)	Cable Loss (dB)	Preamplifier Factor (dB)	Emission Level dB (mV/m)	Limits dB (mV/m)	Margin (dB)	Remark
1864.000	43.72	27.01	4.86	36.50	39.09	74.00	34.91	Peak
3740.500	40.33	32.14	6.54	35.09	43.93	74.00	30.07	Peak
5540.500	37.21	34.12	8.15	34.60	44.88	74.00	29.12	Peak
7129.000	35.90	35.92	9.39	34.64	46.57	74.00	27.43	Peak
8596.000	35.97	38.11	10.51	34.78	49.80	74.00	24.20	Peak
9721.000	35.12	38.10	11.23	34.63	49.82	74.00	24.18	Peak

Mode: ZigBee CH2445MHz

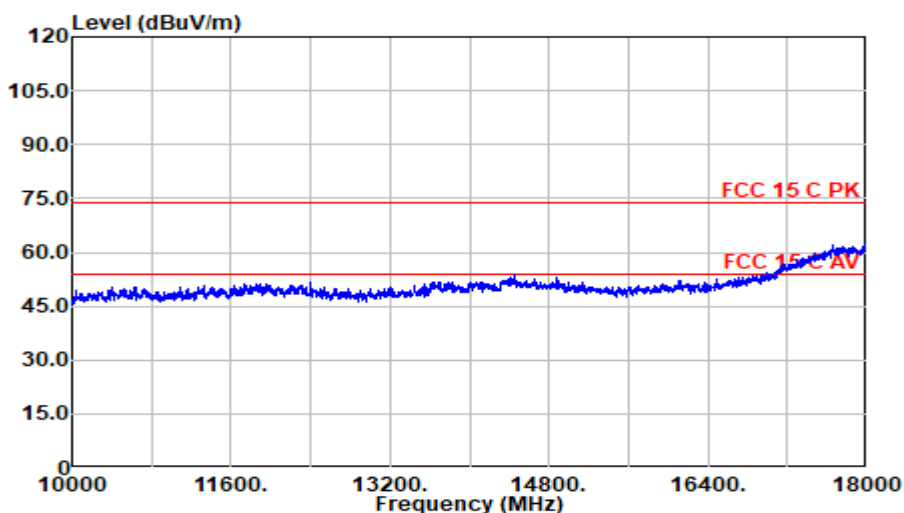
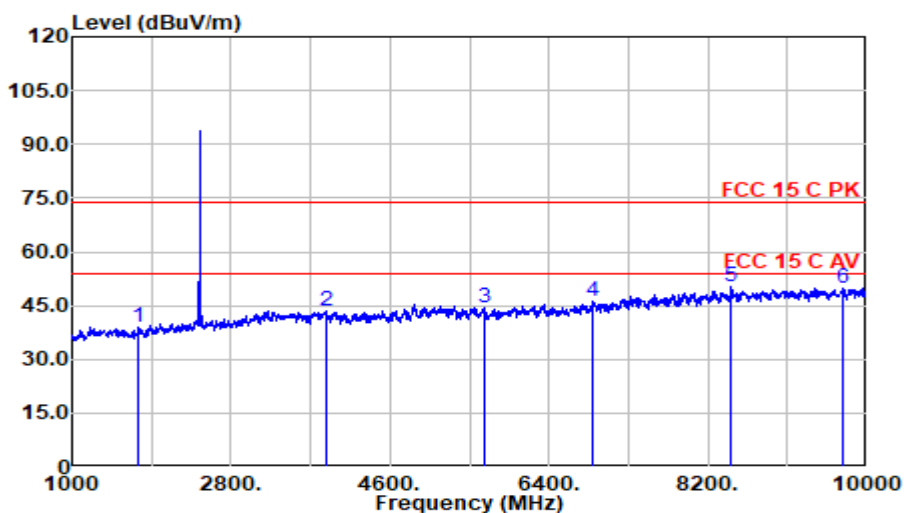

Polarization at Horizontal

Frequency (MHz)	Meter Reading dB (mV)	Antenna Factor (dB/m)	Cable Loss (dB)	Preamplifier Factor (dB)	Emission Level dB (mV/m)	Limits dB (mV/m)	Margin (dB)	Remark
1756.000	43.95	26.85	4.73	36.50	39.03	74.00	34.97	Peak
3871.000	39.38	32.58	6.65	35.05	43.57	74.00	30.43	Peak
5662.000	37.01	33.88	8.23	34.60	44.51	74.00	29.49	Peak
6904.000	36.27	35.51	9.18	34.60	46.36	74.00	27.64	Peak
8465.500	36.34	38.20	10.46	34.80	50.20	74.00	23.80	Peak
9721.000	35.19	38.10	11.23	34.63	49.89	74.00	24.11	Peak

Mode: ZigBee CH2445MHz

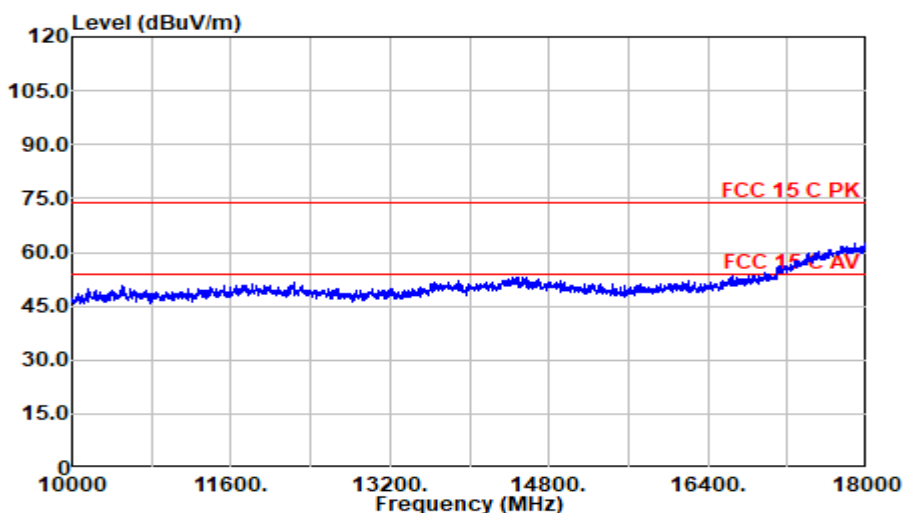
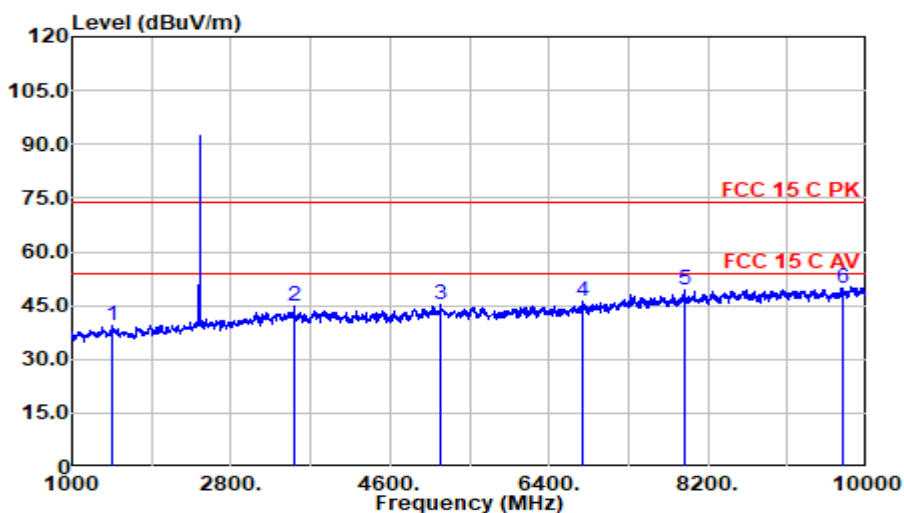

Polarization at Vertical

Frequency (MHz)	Meter Reading dB (mV)	Antenna Factor (dB/m)	Cable Loss (dB)	Preamplifier Factor (dB)	Emission Level dB (mV/m)	Limits dB (mV/m)	Margin (dB)	Remark
1463.500	45.37	26.03	4.33	36.50	39.22	74.00	34.78	Peak
3511.000	42.13	31.58	6.35	35.18	44.88	74.00	29.12	Peak
5167.000	37.91	33.97	7.92	34.60	45.20	74.00	28.80	Peak
6787.000	36.56	35.33	9.08	34.60	46.37	74.00	27.63	Peak
7939.000	36.67	37.32	10.25	34.88	49.35	74.00	24.65	Peak
9734.500	35.29	38.10	11.24	34.63	50.00	74.00	24.00	Peak

Mode: ZigBee CH2480MHz

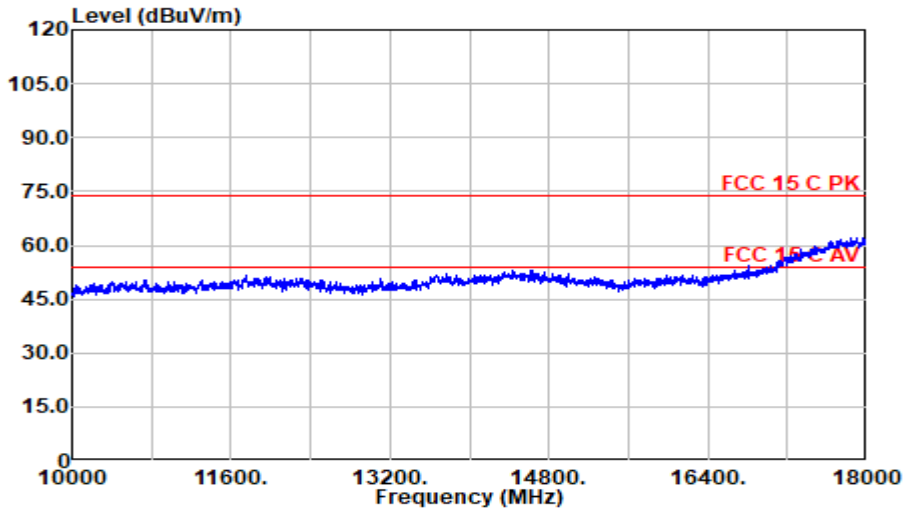
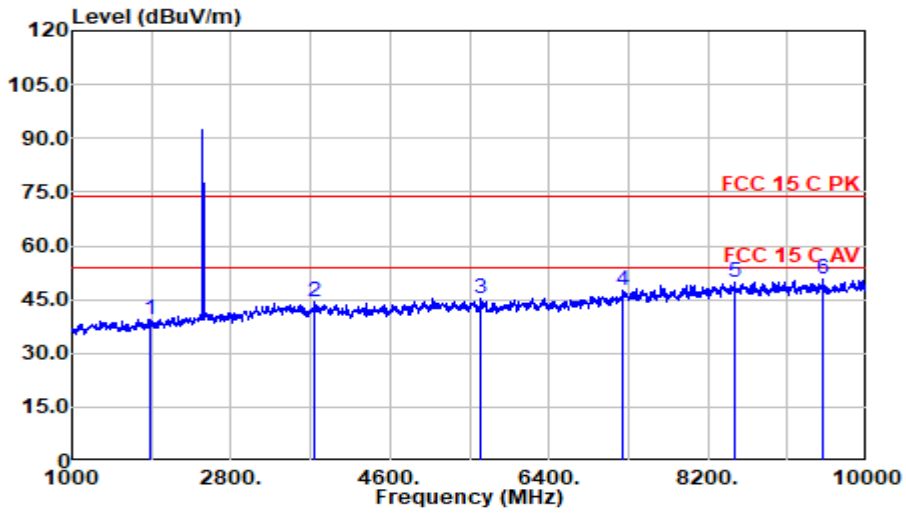

Polarization at Horizontal

Frequency (MHz)	Meter Reading dB (mV)	Antenna Factor (dB/m)	Cable Loss (dB)	Preamplifier Factor (dB)	Emission Level dB (mV/m)	Limits dB (mV/m)	Margin (dB)	Remark
1886.500	43.92	27.19	4.88	36.50	39.49	74.00	34.51	Peak
3740.500	40.57	32.14	6.54	35.09	44.16	74.00	29.84	Peak
5635.000	37.58	33.93	8.21	34.60	45.12	74.00	28.88	Peak
7237.000	36.36	36.47	9.51	34.67	47.67	74.00	26.33	Peak
8510.500	35.96	38.20	10.48	34.79	49.85	74.00	24.15	Peak
9496.000	35.95	38.38	11.05	34.65	50.73	74.00	23.27	Peak

Mode: ZigBee CH2480MHz

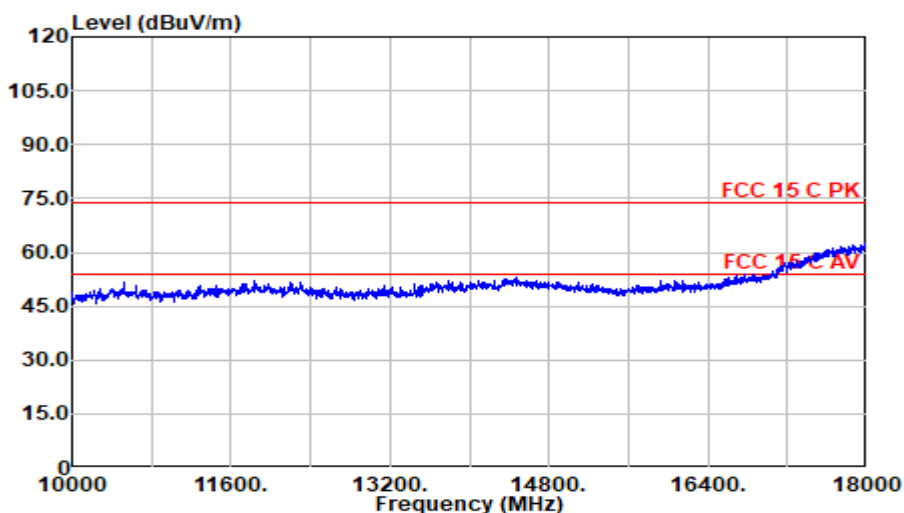
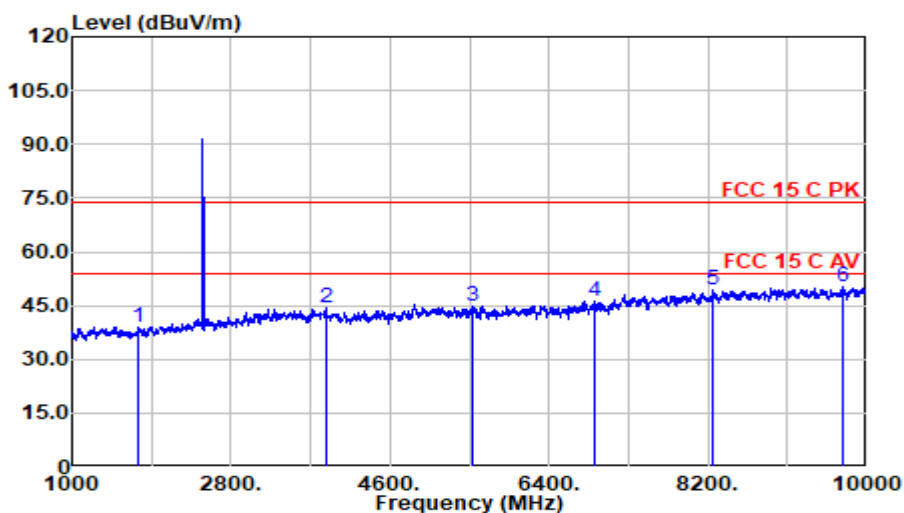

Polarization at Vertical

Frequency (MHz)	Meter Reading dB (mV)	Antenna Factor (dB/m)	Cable Loss (dB)	Preamplifier Factor (dB)	Emission Level dB (mV/m)	Limits dB (mV/m)	Margin (dB)	Remark
1747.000	43.92	26.85	4.72	36.50	38.99	74.00	35.01	Peak
3875.500	40.06	32.60	6.65	35.04	44.27	74.00	29.73	Peak
5545.000	37.29	34.11	8.16	34.60	44.95	74.00	29.05	Peak
6926.500	35.95	35.55	9.19	34.60	46.09	74.00	27.91	Peak
8254.000	36.13	37.81	10.39	34.85	49.48	74.00	24.52	Peak
9730.000	35.41	38.10	11.24	34.63	50.12	74.00	23.88	Peak

Band-Edge and Restricted bands:

Test Date:	2024.01.25	Temp./Hum.:	22°C/51%RH	Test By:	Jarey
------------	------------	-------------	------------	----------	-------

Mode: ZigBee CH2405MHz

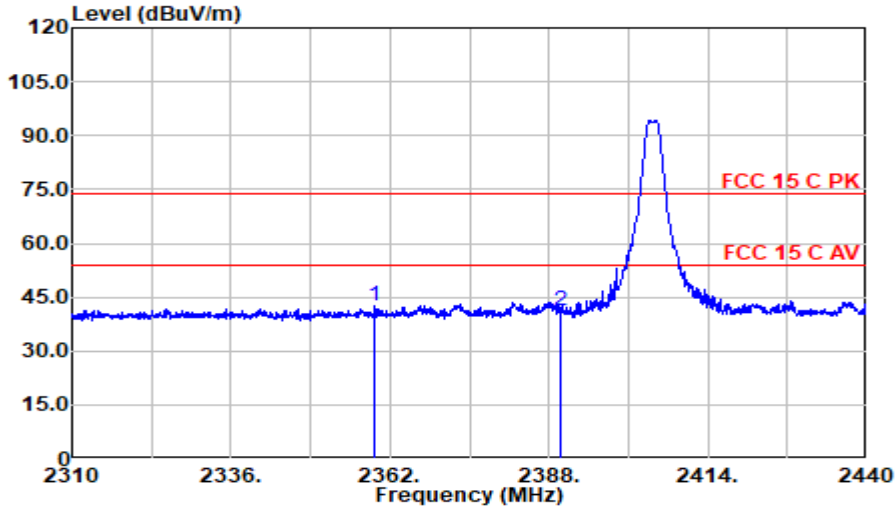

Polarization at Horizontal

Frequency (MHz)	Meter Reading dB (mV)	Antenna Factor (dB/m)	Cable Loss (dB)	Preamp Factor (dB)	Emission Level dB (mV/m)	Limits dB (mV/m)	Margin (dB)	Remark
2359.530	45.03	28.44	5.36	36.05	42.77	74.00	31.23	Peak
2390.000	43.31	28.56	5.39	36.02	41.24	74.00	32.76	Peak

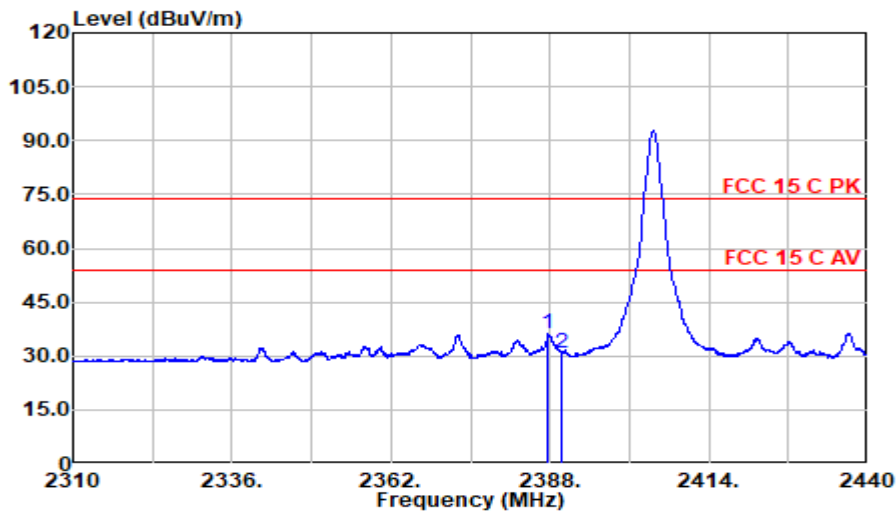

Polarization at Horizontal

Frequency (MHz)	Meter Reading dB (mV)	Antenna Factor (dB/m)	Cable Loss (dB)	Preamp Factor (dB)	Emission Level dB (mV/m)	Limits dB (mV/m)	Margin (dB)	Remark
2387.740	38.10	28.55	5.39	36.02	36.02	54.00	17.98	Average
2390.000	32.95	28.56	5.39	36.02	30.88	54.00	23.12	Average

Mode: ZigBee CH2405MHz

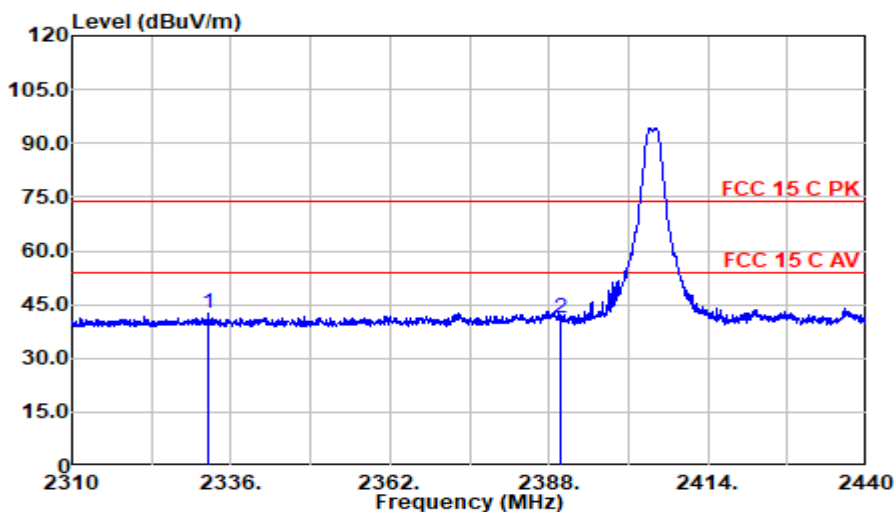

Polarization at Vertical

Frequency (MHz)	Meter Reading dB (mV)	Antenna Factor (dB/m)	Cable Loss (dB)	Preamp Factor (dB)	Emission Level dB (mV/m)	Limits dB (mV/m)	Margin (dB)	Remark
2332.360	45.11	28.26	5.34	36.08	42.62	74.00	31.38	Peak
2390.000	43.19	28.56	5.39	36.02	41.12	74.00	32.88	Peak

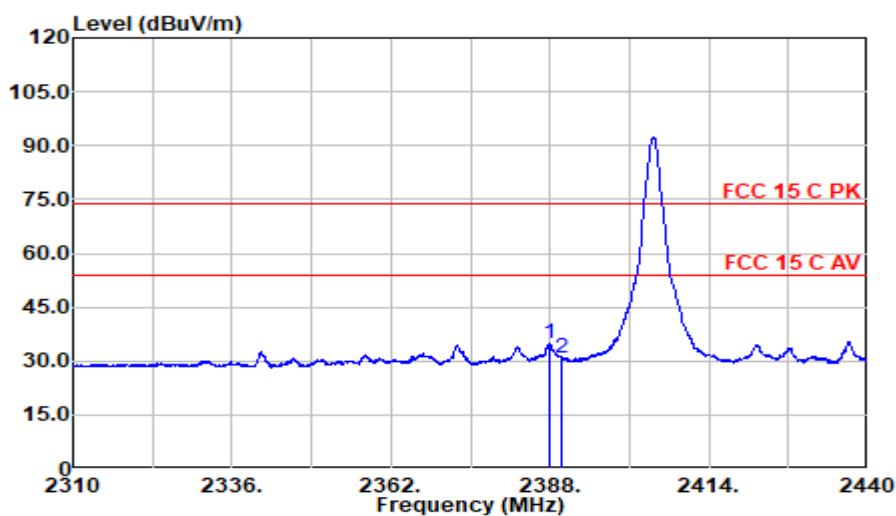

Polarization at Vertical

Frequency (MHz)	Meter Reading dB (mV)	Antenna Factor (dB/m)	Cable Loss (dB)	Preamp Factor (dB)	Emission Level dB (mV/m)	Limits dB (mV/m)	Margin (dB)	Remark
2387.935	36.97	28.55	5.39	36.02	34.89	54.00	19.11	Average
2390.000	32.86	28.56	5.39	36.02	30.80	54.00	23.20	Average

Mode: ZigBee CH2480MHz

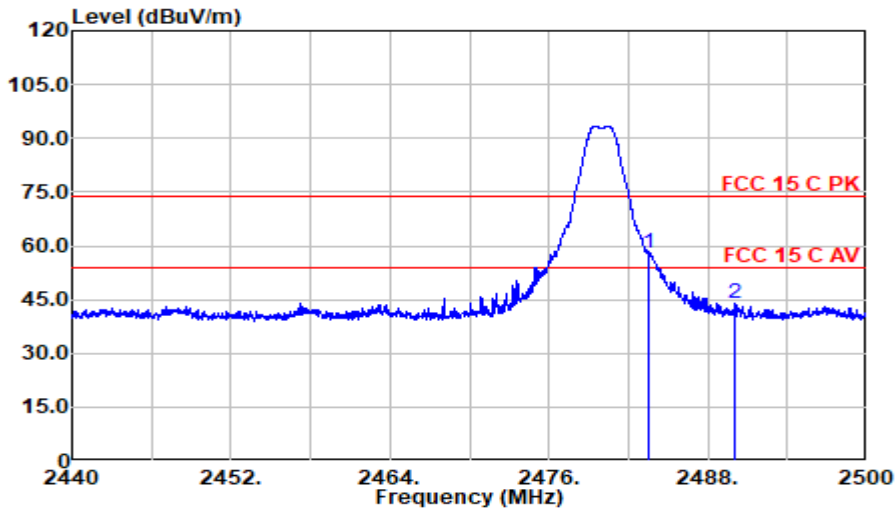

Polarization at Horizontal

Frequency (MHz)	Meter Reading dB (mV)	Antenna Factor (dB/m)	Cable Loss (dB)	Preamp Factor (dB)	Emission Level dB (mV/m)	Limits dB (mV/m)	Margin (dB)	Remark
2483.500	59.84	28.63	5.47	35.91	58.03	74.00	15.97	Peak
2490.040	45.83	28.66	5.47	35.91	44.06	74.00	29.94	Peak

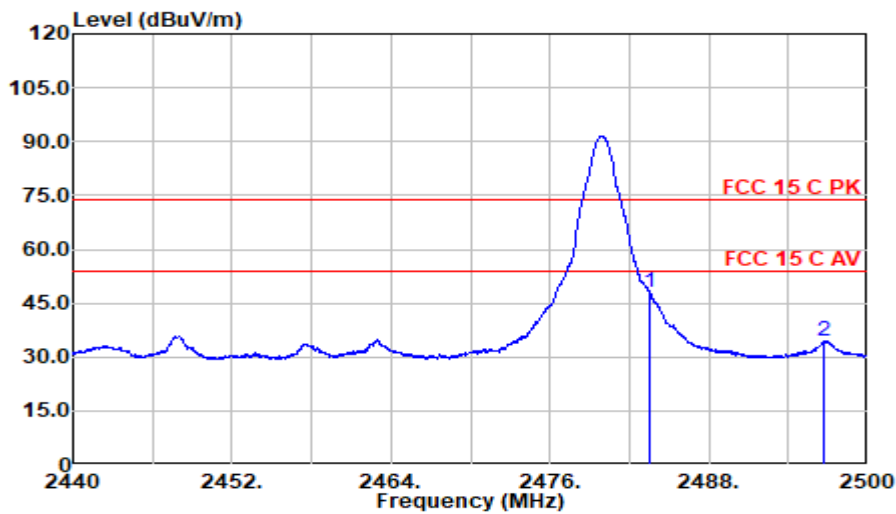

Polarization at Horizontal

Frequency (MHz)	Meter Reading dB (mV)	Antenna Factor (dB/m)	Cable Loss (dB)	Preamp Factor (dB)	Emission Level dB (mV/m)	Limits dB (mV/m)	Margin (dB)	Remark
2483.500	49.98	28.63	5.47	35.91	48.17	54.00	5.83	Average
2496.670	36.08	28.69	5.48	35.90	34.35	54.00	19.65	Average

Mode: ZigBee CH2480MHz

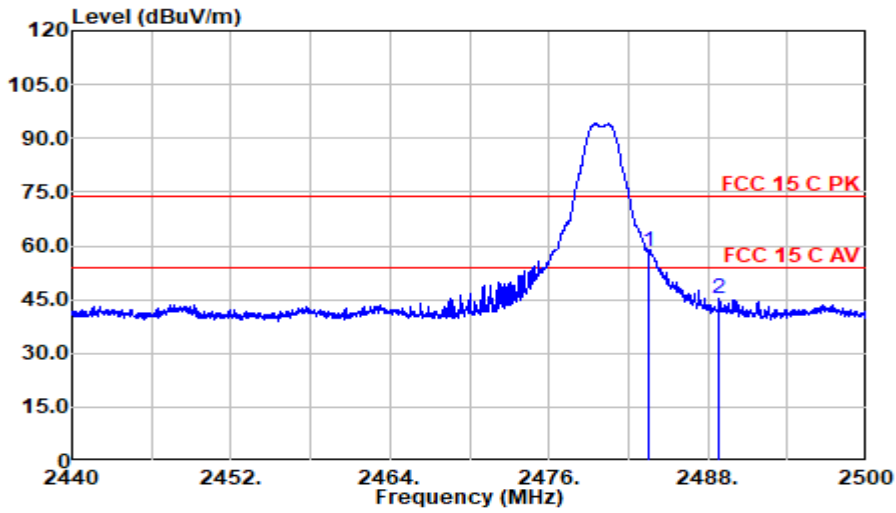

Polarization at Vertical

Frequency (MHz)	Meter Reading dB (mV)	Antenna Factor (dB/m)	Cable Loss (dB)	Preamp Factor (dB)	Emission Level dB (mV/m)	Limits dB (mV/m)	Margin (dB)	Remark
2483.500	60.39	28.63	5.47	35.91	58.58	74.00	15.42	Peak
2488.780	46.92	28.66	5.47	35.91	45.14	74.00	28.86	Peak

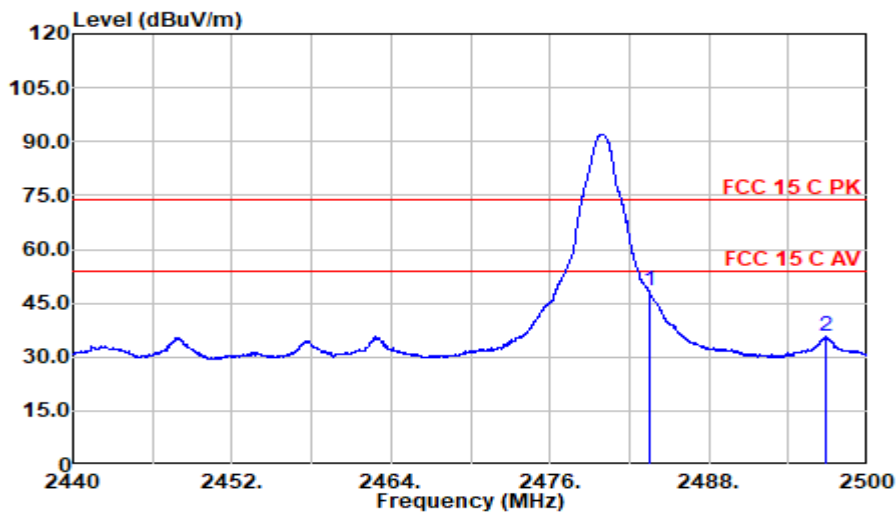

Polarization at Vertical

Frequency (MHz)	Meter Reading dB (mV)	Antenna Factor (dB/m)	Cable Loss (dB)	Preamp Factor (dB)	Emission Level dB (mV/m)	Limits dB (mV/m)	Margin (dB)	Remark
2483.500	50.06	28.63	5.47	35.91	48.25	54.00	5.75	Average
2496.850	37.33	28.69	5.48	35.90	35.60	54.00	18.40	Average

5 6 dB BANDWIDTH MEASUREMENT

5.1 Test Equipment

The following test equipment was used during the Emission Bandwidth measurement:

Item	Type	Manufacturer	Model No.	Serial No.	Cal. Date	Cal. Interval
1.	Spectrum Analyzer	Agilent	N9010A	MY52221182	2023.08.09	1 Year
2.	RF Cable	Mini-Circuits	FLC-3FT-SM SM+	22022838	2023.08.09	1 Year
3.	10 dB Attenuator	Mini-Circuits	BW-S10W2+	001	2023.08.09	1 Year

5.2 Block Diagram of Test Setup



5.3 Specification Limits (§15.247(a)(2))

The minimum 6 dB bandwidth shall be at least 500 kHz.

5.4 Operating Condition of EUT

The software as section 2.3 was used to enable the EUT to change the test mode one by one.

5.5 Test Procedure

The transmitter output was connected to the spectrum analyzer. The bandwidth of the fundamental frequency was measure by spectrum analyzer with settings: RBW = 100kHz, VBW $\geq 3 \times$ RBW.

The 6 dB bandwidth is defined as the total spectrum the power of which is lower than peak power minus 6 dB .

The test procedure is defined in ANSI C63.10-2013 (the 11.8.2 Measurement Procedure “Option 2” was used).

5.6 Test Results

PASSED.

All the test results are attached in next pages.

(Test Date: 2024.01.15 Temperature: 23°C Humidity: 51 %)

Mode	Channel	Frequency (MHz)	6dB Bandwidth (kHz)	Limit
ZigBee	11	2405	817.3	500 kHz
	19	2445	817.7	500 kHz
	26	2480	816.3	500 kHz

ZigBee

CH2405

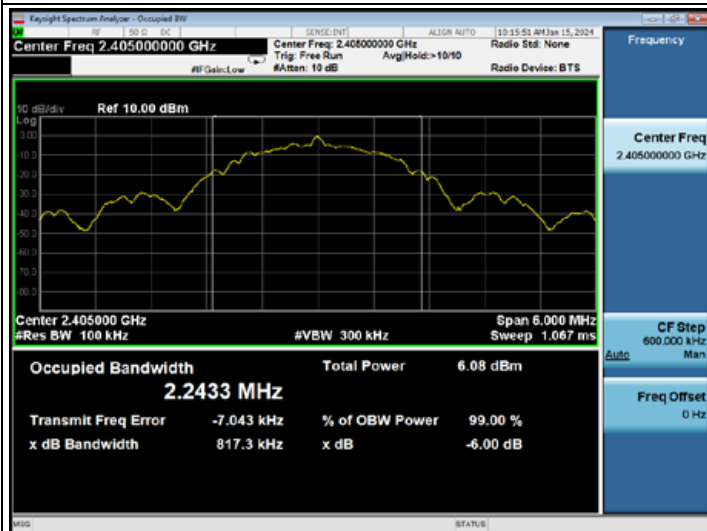

CH2445

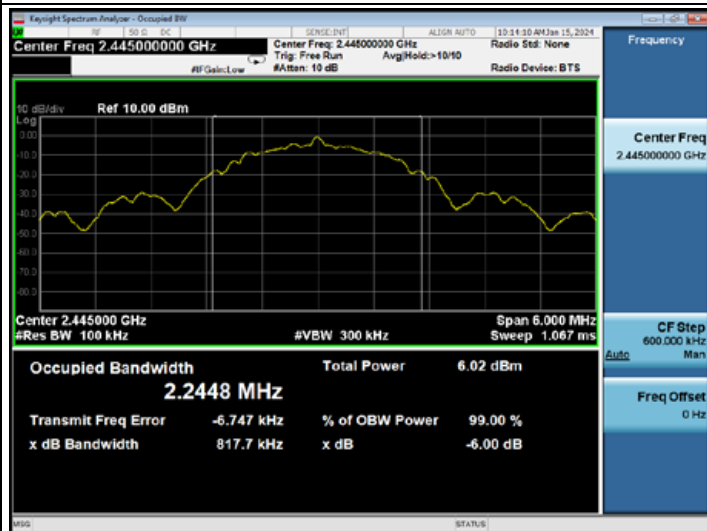

CH2480

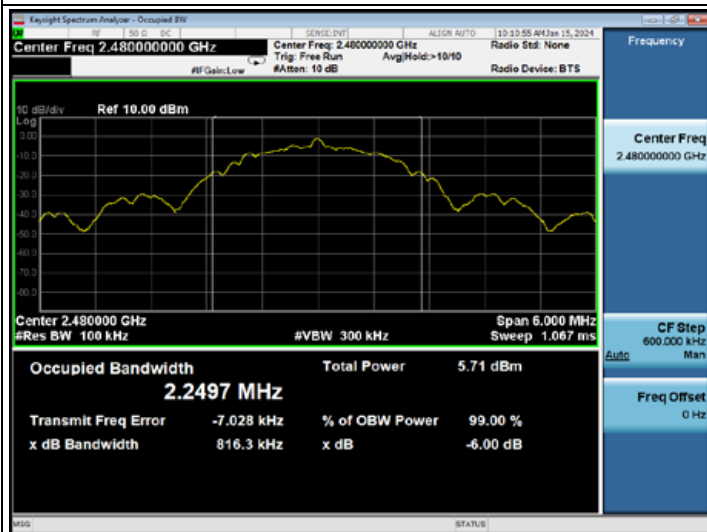

6 MAXIMUM PEAK OUTPUT POWER MEASUREMENT

6.1 Test Equipment

The following test equipment was used during the maximum peak output power measurement:

Item	Type	Manufacturer	Model No.	Serial No.	Cal. Date	Cal. Interval
1.	Spectrum Analyzer	Agilent	N9010A	MY52221182	2023.08.09	1 Year
2.	RF Cable	Mini-Circuits	FLC-3FT-SM SM+	22022838	2023.08.09	1 Year
3.	10 dB Attenuator	Mini-Circuits	BW-S10W2+	001	2023.08.09	1 Year

6.2 Block Diagram of Test Setup

The Same as Section. 5.2.

6.3 Specification Limits ((§15.247(b)(3))

The Limits of maximum Peak Output Power for digital modulation in 2400-2483.5 MHz is: 1 Watt. (30 dBm)

6.4 Operating Condition of EUT

The software as section 2.3 was used to enable the EUT to change the test mode one by one.

6.5 Test Procedure

The transmitter output was connected to the spectrum analyzer.

The following procedure shall be used when an instrument with a resolution bandwidth that is greater than the DTS bandwidth is available to perform the measurement:

- a) $RBW \geq DTS$ Bandwidth.
- b) $VBW \geq [3 \times RBW]$.
- c) $Span \geq [3 \times RBW]$.
- d) Sweep time = auto.
- e) Detector = peak.
- f) Trace mode = max hold.
- g) Allow trace to fully stabilize.
- h) Use peak marker function to determine the peak amplitude level.

The test procedure is defined in ANSI C63.10-2013 (11.9.1.1 Measurement Procedure “ $RBW \geq DTS$ bandwidth” was used).

6.6 Test Results

PASSED.

All the test results are listed below.

(Test Date: 2024.01.15 Temperature: 23°C Humidity: 51 %)

Mode	Channel	Frequency (MHz)	Peak Output Power (dBm)	Limit
ZigBee	11	2405	-0.427	30 dBm
	19	2445	-0.534	30 dBm
	26	2480	-0.867	30 dBm

ZigBee

CH2405



CH2445



CH2480



7 EMISSION LIMITATIONS MEASUREMENT

7.1 Test Equipment

The following test equipment was used during the emission limitations test:

Item	Type	Manufacturer	Model No.	Serial No.	Cal. Date	Cal. Interval
1.	Spectrum Analyzer	Agilent	N9010A	MY52221182	2023.08.09	1 Year
2.	RF Cable	Mini-Circuits	FLC-3FT-SM SM+	22022838	2023.08.09	1 Year
3.	10 dB Attenuator	Mini-Circuits	BW-S10W2+	001	2023.08.09	1 Year

7.2 Block Diagram of Test Setup

The Same as Section. 5.2.

7.3 Specification Limits (§15.247(d))

In any 100 kHz bandwidth outside the frequency band in which the spread spectrum or digitally modulated intentional radiator is operating, the radio frequency power that is produced by the intentional radiator shall be at least 20 dB below that in the 100 kHz bandwidth within the band that contains the highest level of the desired power, based on either an RF conducted or a radiated measurement, provided the transmitter demonstrates compliance with the peak conducted power limits. If the transmitter complies with the conducted power limits based on the use of RMS averaging over a time interval, as permitted under paragraph (b)(3) of this section, the attenuation required under this paragraph shall be 30 dB instead of 20 dB. Attenuation below the general limits specified in §15.209(a) is not required.

In addition, radiated emissions which fall in the restricted bands, as defined in §15.205(a), must also comply with the radiated emission limits specified in §15.209(a) (see §15.205(c)). (※This test result attaching to Section. 4.7)

7.4 Operating Condition of EUT

The software as section 2.3 was used to enable the EUT to change the test mode one by one.

7.5 Test Procedure

The transmitter output was connected to the spectrum analyzer.

Establish a reference level by using the following procedure:

- a) Set instrument center frequency to DTS channel center frequency.
- b) Set the span to ≥ 1.5 times the DTS bandwidth.
- c) Set the RBW = 100 kHz.
- d) Set the VBW $\geq [3 \times \text{RBW}]$.
- e) Detector = peak.
- f) Sweep time = auto couple.
- g) Trace mode = max hold.
- h) Allow trace to fully stabilize.
- i) Use the peak marker function to determine the maximum PSD level.

Note that the channel found to contain the maximum PSD level can be used to

establish the reference level.

Establish an emission level by using the following procedure:

- a) Set the center frequency and span to encompass frequency range to be measured.
- b) Set the RBW = 100 kHz.
- c) Set the VBW $\geq [3 \times \text{RBW}]$.
- d) Detector = peak.
- e) Sweep time = auto couple.
- f) Trace mode = max hold.
- g) Allow trace to fully stabilize.
- h) Use the peak marker function to determine the maximum amplitude level.

Ensure that the amplitude of all unwanted emissions outside of the authorized frequency band (excluding restricted frequency bands) is attenuated by at least the minimum requirements specified in 11.11. Report the three highest emissions relative to the limit.

Scan up through 10th harmonic.

The test procedure is defined in ANSI C63.10-2013 (11.11.2 Reference level measurement and 11.11.3 Emission level measurement was used).

7.6 Test Results

PASSED.

The test data was attached in the next pages.

(Test Date: 2024.01.15 Temperature: 23°C Humidity: 51 %)

Mode	Channel	Frequency (MHz)	Data Page
ZigBee	11	2405	P40
	19	2445	P41
	26	2480	P42

ZigBee

CH2405

Reference Level



Lower Edge

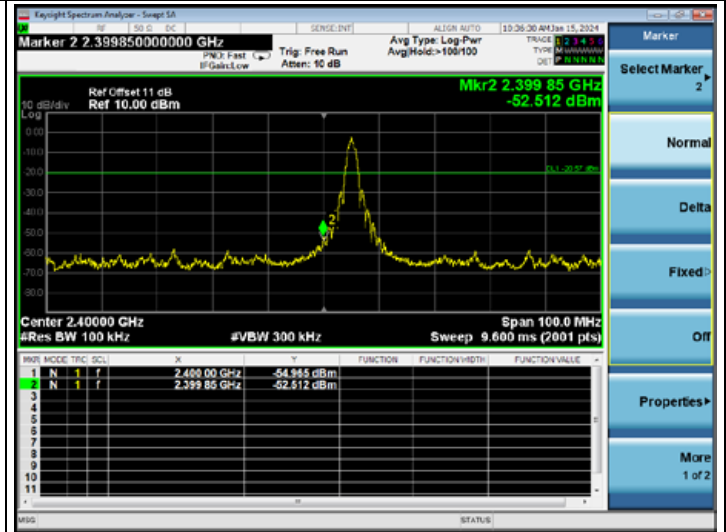

Emission Level

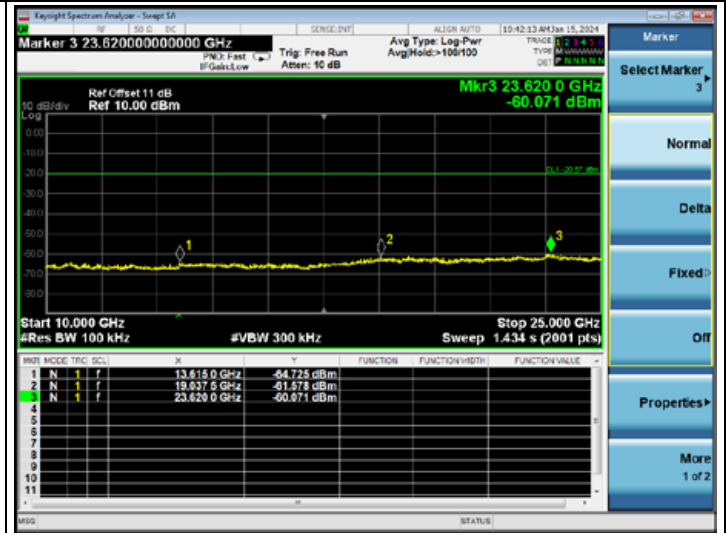
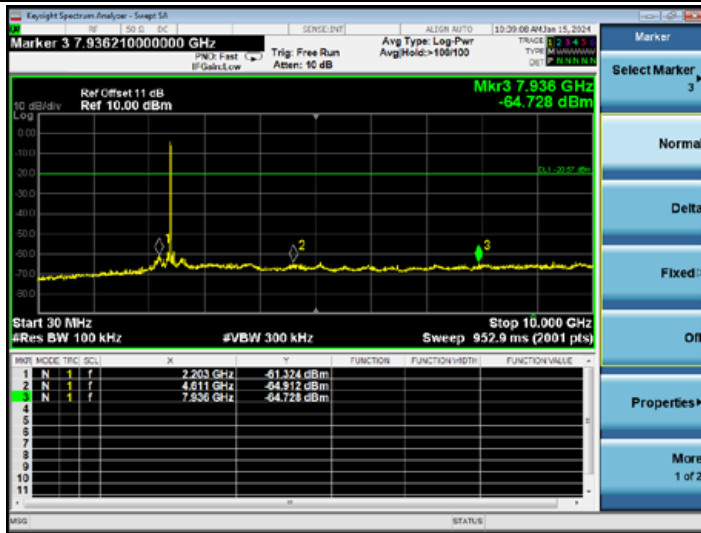

ZigBee

CH2445

Reference Level



Emission Level

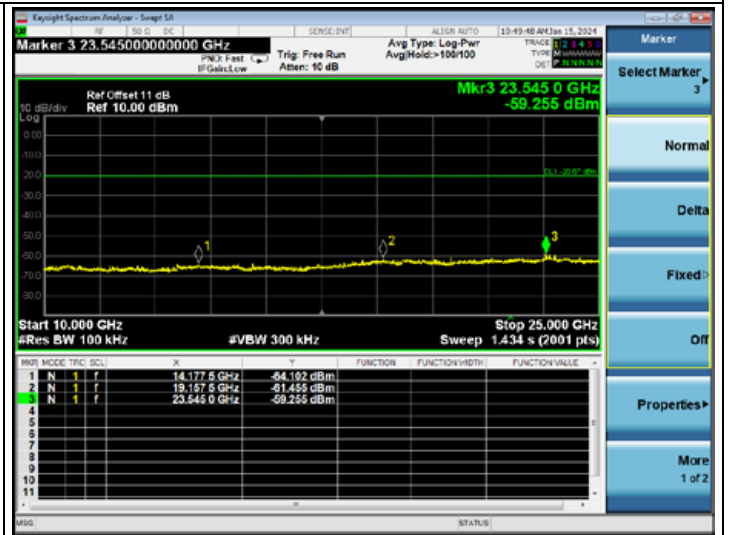
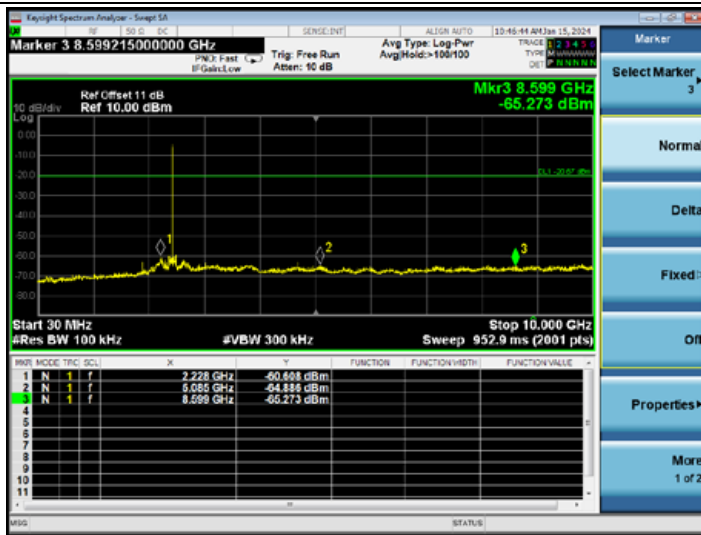

ZigBee

CH2480

Reference Level



Higher Edge

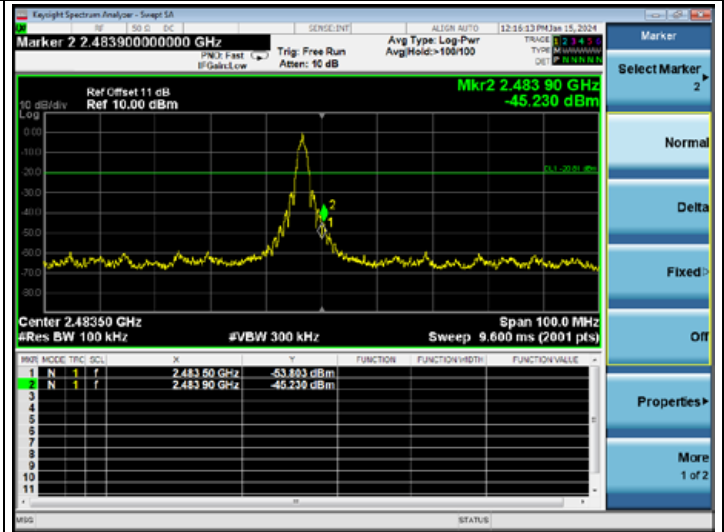

Emission Level

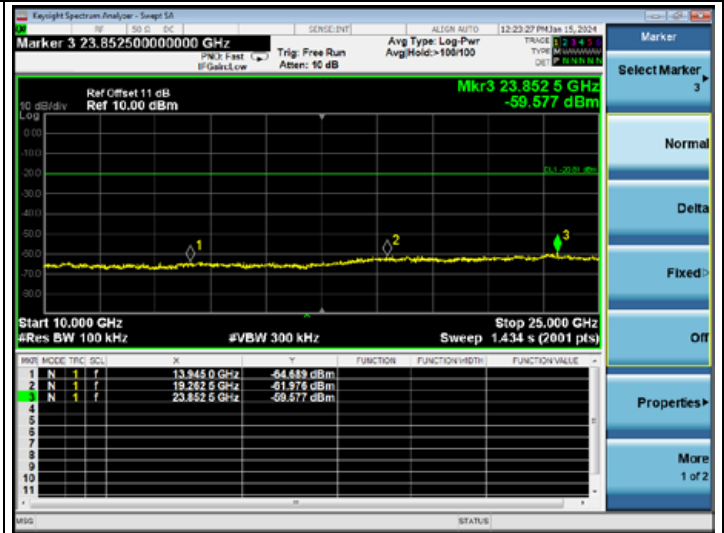
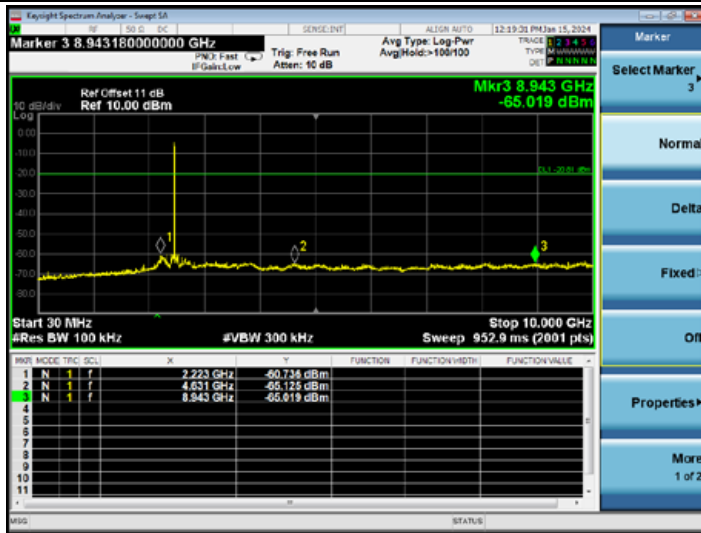

8 POWER SPECTRAL DENSITY MEASUREMENT

8.1 Test Equipment

The following test equipment was used during the power spectral density measurement:

Item	Type	Manufacturer	Model No.	Serial No.	Cal. Date	Cal. Interval
1.	Spectrum Analyzer	Agilent	N9010A	MY52221182	2023.08.09	1 Year
2.	RF Cable	Mini-Circuits	FLC-3FT-SM SM+	22022838	2023.08.09	1 Year
3.	10 dB Attenuator	Mini-Circuits	BW-S10W2+	001	2023.08.09	1 Year

8.2 Block Diagram of Test Setup

The Same as section 5.2.

8.3 Specification Limits (§15.247(e))

The power spectral density conducted from the intentional radiator to the antenna shall not be greater than 8 dBm in any 3 kHz band.

8.4 Operating Condition of EUT

The software as section 2.3 was used to enable the EUT to change the test mode one by one.

8.5 Test Procedure

The transmitter output was connected to the spectrum analyzer.

- a) Set analyzer center frequency to DTS channel center frequency.
- b) Set the span to 1.5 times the DTS bandwidth.
- c) Set the RBW to $3 \text{ kHz} \leq \text{RBW} \leq 100 \text{ kHz}$.
- d) Set the VBW $\geq [3 \times \text{RBW}]$.
- e) Detector = peak.
- f) Sweep time = auto couple.
- g) Trace mode = max hold.
- h) Allow trace to fully stabilize.
- i) Use the peak marker function to determine the maximum amplitude level within the RBW.
- j) If measured value exceeds requirement, then reduce RBW (but no less than 3 kHz) and repeat.

The test procedure is defined in ANSI C63.10-2013 (11.10.2 Measurement Procedure “Method PKPSD (peak PSD)” was used).

8.6 Test Results

PASSED.

All the test results are attached in next pages.

(Test Date: 2024.01.15 Temperature: 23°C Humidity: 51 %)

Mode	Channel	Frequency (MHz)	Power Spectral Density (dBm)	Limit
BLE	11	2405	-9.762	8 dBm
	19	2445	-9.913	8 dBm
	26	2480	-10.277	8 dBm

ZigBee

CH2405

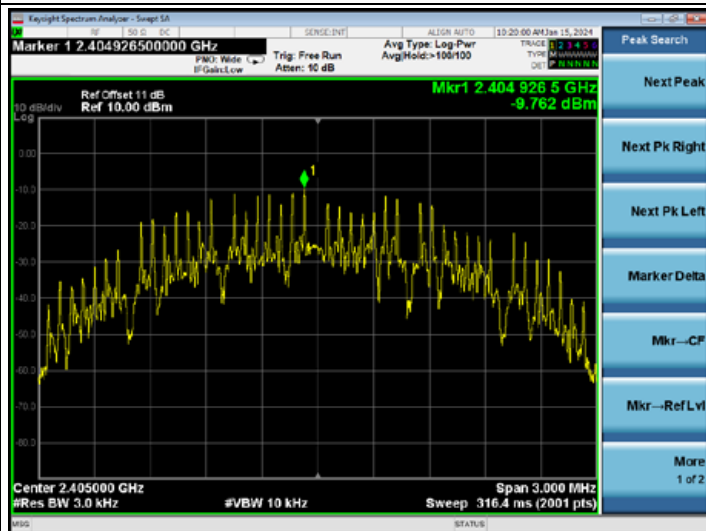

CH2445

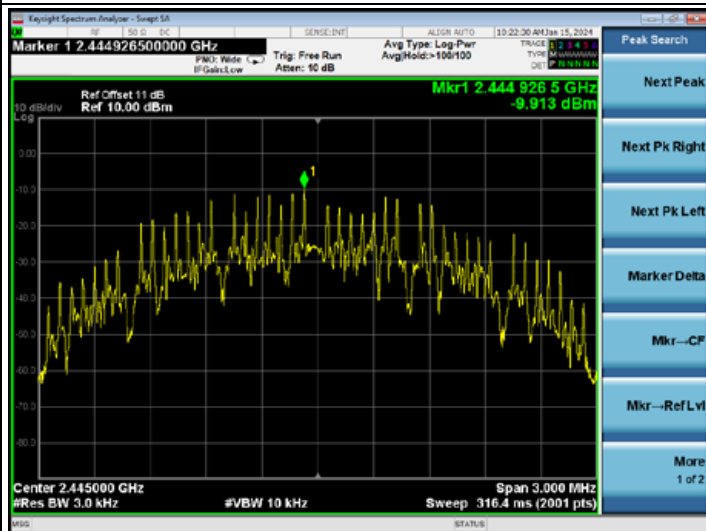

CH2480



9 ANTENNA REQUIREMENT

9.1 Specification Limits (§15.203)

An intentional radiator shall be designed to ensure that no antenna other than that furnished by the responsible party shall be used with the device.

9.2 Result

According to KDB 353028 D1, the following describes the three ways that can be used to demonstrate compliance to Section 15.203:

- a) Antenna permanently attached.
- b) Unique (non-standard) antenna connector.
- c) Professional installation.

For this product, the antenna is:

- Antenna permanently attached
- Unique (non-standard) antenna connector
- Professional installation
- not meet any of ways list above

that

- compliant
- not compliant

with the requirement of Section 15.203.

10 DEVIATION TO TEST SPECIFICATIONS

None.

11 MEASUREMENT UNCERTAINTY LIST

The measurement uncertainty was estimated for test on the EUT according to CISPR 16-4-2. This uncertainty represents an expanded uncertainty expressed at approximately the 95% confidence level using a coverage of K=2.

The uncertainties value is not used in determining the PASS/FAIL results.

Test Items/Facilities	Frequency/Equipment/Unit	Uncertainty
Estimation of Uncertainty for Conduction Emission (Shielded Room-1)	9kHz~150kHz(50Ω/50μH -AMN)	3.74 dB
	150kHz~30MHz(50Ω/50μH -AMN)	3.34 dB
	150kHz~30MHz(50Ω/50μH -AMN-CAT 3)	3.46 dB
	150kHz~30MHz(50Ω/50μH -AMN-CAT 5)	3.48 dB
	150kHz~30MHz(50Ω/50μH -AMN-CAT 6)	3.60 dB
	9kHz~30MHz(VP, considering the effect of mains impedance when compared with AMN)	24.64 dB
	9kHz~30MHz(VP)	2.76 dB
	9kHz~30MHz(CP, considering the effect of AE impedance when compared with AMN)	24.64 dB
	9kHz~30MHz(CP)	2.82 dB
Estimation of Uncertainty for Conduction Emission (Shielded Room-3)	9kHz~150kHz(50Ω/50μH -AMN)	3.74 dB
	150kHz~30MHz(50Ω/50μH -AMN)	3.34 dB
Estimation of Uncertainty for Power Clamp	30MHz~300MHz (Absorbing Clamp)	3.68 dB
Estimation of Uncertainty for CDNE	30MHz~300MHz (CDNE-M210)	3.68 dB
	30MHz~300MHz (CDNE-M310)	3.68 dB
Estimation of Uncertainty for EMF	20kHz~10MHz	1.54 dB
Estimation of Uncertainty for Radiated Emission	30M~200MHz (Vertical)	4.56dB
	30M~200MHz (Horizontal)	4.44dB
	200M~1000MHz (Vertical)	5.28dB
	200M~1000MHz (Horizontal)	3.88dB
	1G~6GHz	4.34dB
	6G~18G Hz	4.40dB
	18G~40G Hz	4.04dB