

## TEST REPORT

On behalf of

Savant Technologies LLC, dba GE Lighting, a Savant company

Product Name: Cync Fixture Canless

Model No.: CFIXCNLR6S1

FCC ID: PUU-CFIXCNLR6S1

Prepared For: Savant Technologies LLC, dba GE Lighting, a Savant company  
1975 Noble Road, Cleveland, OH 44112

Prepared By: Audix Technology (Shanghai) Co., Ltd.  
3F and 4F, 34Bldg, 680 Guiping Rd.,  
Caohejing Hi-Tech Park,  
Shanghai 200233, China

Tel: +86-21-64955500



File No. : C1D2111085  
Report No. : ACI-F21281  
Date of Test : 2021.11.29-2022.01.15  
Date of Report : 2022.01.15

The statement is based on a single evaluation of one sample of the above-mentioned products. It does not imply an assessment of the whole production and does not permit the use of the test lab logo. The report must not be used by the client to claim product certification, approval, or endorsement by NVLAP, NIST, or any agency of the Federal Government.

## TABLE OF CONTENTS

	Page
<b>1 SUMMARY OF STANDARDS AND RESULTS</b> .....	<b>5</b>
1.1 Description of Standards and Results.....	5
<b>2 GENERAL INFORMATION</b> .....	<b>6</b>
2.1 Description of Equipment Under Test.....	6
2.2 EUT Specifications Assessed in Current Report.....	7
2.3 Test Information.....	7
2.4 Sample Description.....	7
2.5 Supported equipment.....	8
2.6 Description of Test Facility.....	8
<b>3 CONDUCTED EMISSION TEST</b> .....	<b>9</b>
3.1 Test Equipment.....	9
3.2 Block Diagram of Test Setup.....	9
3.3 Conducted Emission Limits (§15.207).....	10
3.4 Test Configuration.....	10
3.5 Operating Condition of EUT.....	10
3.6 Test Procedures.....	10
3.7 Test Results.....	11
<b>4 RADIATED EMISSION TEST</b> .....	<b>13</b>
4.1 Test Equipment.....	13
4.2 Block Diagram of Test Setup.....	13
4.3 Radiated Emission Limit (§15.209).....	14
4.4 Test Configuration.....	14
4.5 Operating Condition of EUT.....	15
4.6 Test Procedures.....	15
4.7 Test Results.....	16
<b>5 6 DB BANDWIDTH MEASUREMENT</b> .....	<b>32</b>
5.1 Test Equipment.....	32
5.2 Block Diagram of Test Setup.....	32
5.3 Specification Limits (§15.247(a)(2)).....	32
5.4 Operating Condition of EUT.....	32
5.5 Test Procedure.....	32
5.6 Test Results.....	33
<b>6 MAXIMUM PEAK OUTPUT POWER MEASUREMENT</b> .....	<b>39</b>
6.1 Test Equipment.....	39
6.2 Block Diagram of Test Setup.....	39
6.3 Specification Limits ((§15.247(b)(3)).....	39
6.4 Operating Condition of EUT.....	39
6.5 Test Procedure.....	39
6.6 Test Results.....	40
<b>7 EMISSION LIMITATIONS MEASUREMENT</b> .....	<b>46</b>
7.1 Test Equipment.....	46
7.2 Block Diagram of Test Setup.....	46
7.3 Specification Limits (§15.247(d)).....	46

---

7.4	Operating Condition of EUT .....	46
7.5	Test Procedure .....	46
7.6	Test Results .....	48
<b>8</b>	<b>POWER SPECTRAL DENSITY MEASUREMENT .....</b>	<b>73</b>
8.1	Test Equipment.....	73
8.2	Block Diagram of Test Setup .....	73
8.3	Specification Limits (§15.247(e)) .....	73
8.4	Operating Condition of EUT .....	73
8.5	Test Procedure.....	73
8.6	Test Results .....	74
<b>9</b>	<b>DEVIATION TO TEST SPECIFICATIONS.....</b>	<b>80</b>
<b>10</b>	<b>MEASUREMENT UNCERTAINTY LIST .....</b>	<b>81</b>

# TEST REPORT

Applicant : Savant Technologies LLC, dba GE Lighting, a Savant company  
 EUT Description : Cync Fixture Canless  
 (A) Model No. : CFIXCNLR6S1  
 (B) Power Supply : 120V AC 60Hz  
 (C) Test Voltage : 120V/60Hz

### Test Procedure Used:

*FCC RULES AND REGULATIONS PART 15 SUBPART C  
 AND ANSI C63.10-2013*

The device described above is tested by Audix Technology (Shanghai) Co., Ltd. to determine the maximum emission levels emanating from the device. The maximum emission levels are compared to the FCC Part 15 Subpart C limits.

The test results are contained in this test report and Audix Technology (Shanghai) Co., Ltd. is assumed full responsibility for the accuracy and completeness of these measurements. This report also shows that the EUT (M/N: Refer to Sec2.1), which was tested is technically compliance with the FCC limits.

This report applies to above tested Sample only. This report shall not be reproduced in part without written approval of Audix Technology (Shanghai) Co., Ltd.

*The test results for EUT's BLE function are contained in No.ACI-F21280 report.*

Date of Test : 2021.11.29-2022.01.15 Date of Report : 2022.01.15

Producer : Alan He  
 ALAN HE / Assistant

Reviewer : Byron Wu  
 BYRON WU/ Deputy Assistant Manager

**AUDIX**<sup>®</sup> For and on behalf of  
 Audix Technology (Shanghai) Co., Ltd.

Signatory : Byron Kwo  
 Authorized Signature(s) BYRON KWO/Assistant General Manager

# 1 SUMMARY OF STANDARDS AND RESULTS

## 1.1 Description of Standards and Results

The EUT have been tested according to the applicable standards as referenced below:

Description / Test Item	Test Standard	Results	Meets Limit
<b>EMISSION</b>			
Conducted Emission	FCC RULES AND REGULATIONS PART 15 SUBPART C AND ANSI C63.10:2013	Pass	15.207
Radiated Emission	FCC RULES AND REGULATIONS PART 15 SUBPART C AND ANSI C63.10:2013	Pass	15.209(a) 15.205(a)(c)
6 dB Bandwidth Measurement	FCC RULES AND REGULATIONS PART 15 SUBPART C AND ANSI C63.10:2013	Pass	15.247(a)(2)
Maximum Peak Output Power Measurement	FCC RULES AND REGULATIONS PART 15 SUBPART C AND ANSI C63.10:2013	Pass	15.247(b)(3)
Emission Limitations Measurement	FCC RULES AND REGULATIONS PART 15 SUBPART C AND ANSI C63.10:2013	Pass	15.247(d)
Band Edge Measurement	FCC RULES AND REGULATIONS PART 15 SUBPART C AND ANSI C63.10:2013	Pass	15.247(d)
Power Spectral Density Measurement	FCC RULES AND REGULATIONS PART 15 SUBPART C AND ANSI C63.10:2013	Pass	15.247(e)
N/A is an abbreviation for Not Applicable.			

## 2 GENERAL INFORMATION

### 2.1 Description of Equipment Under Test

Description : Cync Fixture Canless

Type of EUT :  Production  Pre-product  Pro-type

Model Number : CFIXCNLR6S1

Radio Tech : BLE 4.2;  
IEEE 802.11 b/g/n.

Note: : 802.11n-HT40 not support.

Channel Freq. : BLE: 2402MHz-2480MHz;  
802.11b/g/n: 2412MHz-2462MHz.

Modulation : BLE: GFSK;  
802.11b: DSSS (CCK, DQPSK, DBPSK);  
802.11g/n: OFDM (64QAM, 16QAM, QPSK, BPSK).

Antenna Info. : Antenna Type: PCB Antenna  
Antenna Gain: 0.5 dBi  
The Antenna was a permanently attached antenna that is comply with 15.203 requirement.

Test Mode : The EUT was set at continuous TX during all the test in the report.

Applicant : Savant Technologies LLC, dba GE Lighting, a Savant company  
1975 Noble Road, Cleveland, OH 44112

Manufacturer : same as Applicant

Factory : Foshan Electrical and Lighting Co., Ltd. Gaoming Branch  
Hecheng Street, Cangjiang Industrial Park, Gaoming District Foshan Guangdong 528000 CHINA

## 2.2 EUT Specifications Assessed in Current Report

Mode	Modulation	Data Rate(Mbps)
802.11b	DS (DQPSK, DBPSK, CCK)	Up to 11
802.11g	OFDM (64-QAM, 16-QAM, QPSK, BPSK)	Up to 54
802.11n-HT 20	OFDM (64-QAM, 16-QAM, QPSK, BPSK)	Up to 72.2

Channel List			
Channel No.	Frequency (MHz)	Channel No.	Frequency (MHz)
1	2412	7	2442
2	2417	8	2447
3	2422	9	2452
4	2427	10	2457
5	2432	11	2462
6	2437		

## 2.3 Test Information

The test software “UI\_mptool.exe” was used to control EUT work in TX mode, Power Index and select test channel.

Modulation	data rate (Mbps)	Test Channel		Frequency (MHz)
802.11b	11	Low:	1	2412
		Middle:	6	2437
		High:	11	2462
802.11g	6	Low:	1	2412
			2	2417
		Middle:	6	2437
			10	2457
802.11n20	MCS0	High:	11	2462
		Low:	1	2412
			2	2417
		Middle:	6	2437
			10	2457
	High:	11	2462	

## 2.4 Sample Description

Test Item	Model Number	Sample Number	Date of received
Conducted Emission	CFIXCNLR6S1	E21111796-01/01	2021.11.23
Radiated Emission	CFIXCNLR6S1	E21111796a-01/01	2021.11.23
Conducted RF Test	CFIXCNLR6S1	E21111798a-01/01	2021.11.23

## 2.5 Supported equipment

Brand : Acer  
Product Name: : Notebook PC  
Model Name : TravelMate P238 series  
Model Number : N15W8

## 2.6 Description of Test Facility

Name of Firm : Audix Technology (Shanghai) Co., Ltd.  
Site Location : 3F and 4F, 34Bldg, 680 Guiping Rd.,  
Caohejing Hi-Tech Park,  
Shanghai 200233, China.  
Accredited by NVLAP, Lab Code : 200371-0  
FCC Designation Number : CN5027  
Test Firm Registration Number : 954668



### 3 CONDUCTED EMISSION TEST

#### 3.1 Test Equipment

The following test equipments are used during the conducted emission test in a shielded room:

Item	Type	Manufacturer	Model No.	Serial No.	Cal. Date	Cal. Interval
1.	Test Receiver	R&S	ESCI	101302	2021.04.26	1 Year
2.	Artificial Mains Network (AMN)	R&S	ENV4200	100125	2021.06.24	1 Year
3.	Software	Audix	e3	6.2009-1-15	--	--

#### 3.2 Block Diagram of Test Setup

##### 3.2.1 Conducted Disturbance Test Setup

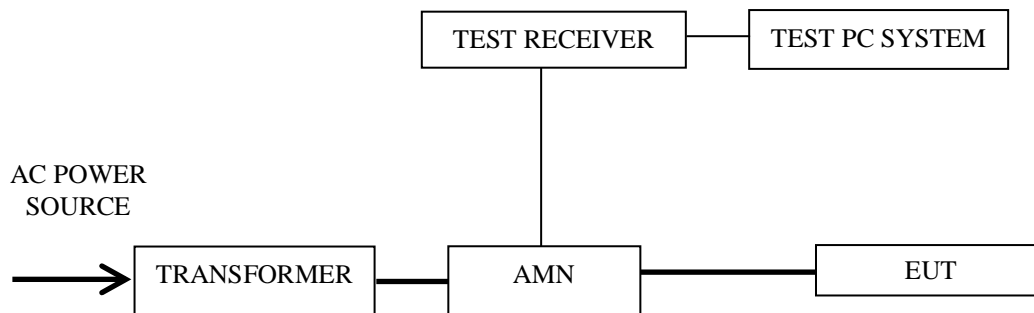

— : Signal Line  
 — : Power Line

### 3.3 Conducted Emission Limits (§15.207)

Frequency Range (MHz)	Limits dB(μV)	
	Quasi-peak	Average
0.15 ~ 0.5	66~56	56~46
0.5 ~ 5	56	46
5 ~ 30	60	50
NOTE 1 – The lower limit shall apply at the transition frequencies. NOTE 2 – The limit decreases linearly with the logarithm of the frequency in the range 0.15 MHz~0.50 MHz		

### 3.4 Test Configuration

The EUT (listed in Sec.2.1) was installed as shown on Sec.3.2 to meet FCC requirement and operating in a manner which tends to maximize its emission level in a normal application.

### 3.5 Operating Condition of EUT

- 3.5.1 Setup the EUT as shown in Sec. 3.2.
- 3.5.2 Turn on the power of all equipment.
- 3.5.3 Turn the EUT on the test mode, and then test.

### 3.6 Test Procedures

The EUT was placed upon a non-metallic table, which is 0.8 m above the horizontal conducting ground plane and 0.4 m from a vertical reference plane. The EUT was connected to the power mains through an Artificial Mains Network (AMN) to provide a 50 Ω coupling impedance for the measuring equipment. Both sides of AC line (Line & Neutral) were checked to find out the maximum conducted emission according to FCC Part 15 Subpart C and ANSI C63.10: 2013 requirements during conducted disturbance test.

The I.F. bandwidth of Test Receiver ESCI was set at 9 kHz.

The frequency range from 150 kHz to 30 MHz was checked.

Test with a dummy load in lieu of the antenna to determine compliance with Section 15.207 limits within the transmitter's fundamental emission band. (According to KDB 174176 D01 Line Conducted FAQ)

The test modes were done on conducted disturbance test and all the test results are listed in Sec. 3.7

### 3.7 Test Results

< **PASS** >

The frequency and amplitude of the highest conducted emission relative the limit is reported. All the emissions not reported below are too low against the FCC limit.

Worst case emission:

No.	Operation	Modulation	Channel	Frequency (MHz)	Data Page
1.	Transmitting	--	--	--	P12

NOTE 1 – Level = Read Level + AMN Factor + Cable Loss

NOTE 2 – “QP” means “Quasi-Peak” values

NOTE 3 – The emission levels which not reported are too low against the official limit.

**Worst case emission**

EUT : Cync Fixture Canless Temperature : 22°C  
 Model No. : CFIXCNLR6S1 Humidity : 51%RH  
 Test Mode : Transmitting Date of Test : 2021.12.10

Polarization	Frequency (MHz)	Meter Reading dB (µV)	AMN Factor (dB)	Cable Loss (dB)	Emission Level dB (µV)	Limits dB (µV)	Margin (dB)	Remark
Line	0.31	46.1	0.2	0.03	46.33	59.97	13.64	QP
	0.31	34.11	0.2	0.03	34.34	49.97	15.63	Average
	0.3596	50.57	0.2	0.03	50.8	58.74	7.94	QP
	0.3596	38	0.2	0.03	38.23	48.74	10.51	Average
	0.4019	46.45	0.2	0.04	46.69	57.81	11.12	QP
	0.4019	29.46	0.2	0.04	29.7	47.81	18.11	Average
	0.7198	43.24	0.2	0.05	43.49	56	12.51	QP
	0.7198	28.21	0.2	0.05	28.46	46	17.54	Average
	1.01	46.29	0.2	0.06	46.55	56	9.45	QP
	1.01	31.43	0.2	0.06	31.69	46	14.31	Average
	1.054	45.89	0.2	0.06	46.15	56	9.85	QP
1.054	30.29	0.2	0.06	30.55	46	15.45	Average	
Neutral	0.31	46.3	0.2	0.03	46.53	59.97	13.44	QP
	0.31	34.43	0.2	0.03	34.66	49.97	15.31	Average
	<b>0.3596</b>	<b>50.61</b>	<b>0.2</b>	<b>0.03</b>	<b>50.84</b>	<b>58.74</b>	<b>7.9</b>	<b>QP</b>
	0.3596	38	0.2	0.03	38.23	48.74	10.51	Average
	0.4019	46.65	0.2	0.04	46.89	57.81	10.92	QP
	0.4019	27.66	0.2	0.04	27.9	47.81	19.91	Average
	0.7198	44.13	0.2	0.05	44.38	56	11.62	QP
	0.7198	28.31	0.2	0.05	28.56	46	17.44	Average
	0.9839	46.88	0.2	0.06	47.14	56	8.86	QP
	0.9839	29.29	0.2	0.06	29.55	46	16.45	Average
	1.054	45.83	0.2	0.06	46.09	56	9.91	QP
1.054	29.59	0.2	0.06	29.85	46	16.15	Average	

TEST ENGINEER: Jarey

## 4 RADIATED EMISSION TEST

### 4.1 Test Equipment

The following test equipment are used during the radiated emission test in a semi-anechoic chamber:

Item	Type	Manufacturer	Model No.	Serial No.	Cal. Date	Cal. Interval
1.	Preamplifier	Agilent	8447D	2944A10548	2021.03.08	1 Year
2.	Preamplifier	HP	8449B	3008A00864	2021.03.08	1 Year
3.	Spectrum Analyzer	Agilent	N9010A	MY52221182	2021.09.16	1 Year
4.	Test Receiver	R&S	ESCI	101303	2021.03.08	1 Year
5.	Bilog Antenna+6dB Attenuator	Schwarz beck	VULB 9168+EMCI-N-6-06	707+AT-N06 37	2021.03.30	1 Year
6.	Horn Antenna	EMCO	3115	9607-4878	2021.07.27	1 Year
7.	Horn Antenna	EMCO	3116	00062643	2020.10.10	1 Year
8.	Cavity Band Rejection Filter	Microwave	WT-A3882-R-10	WT200312-1-1	2021.09.15	1 Year
9.	Software	Audix	e3	SET00200 9912M295-2	--	--

### 4.2 Block Diagram of Test Setup

#### 4.2.1 EUT & Peripherals

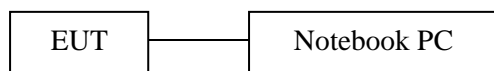

#### 4.2.2 Below 1GHz

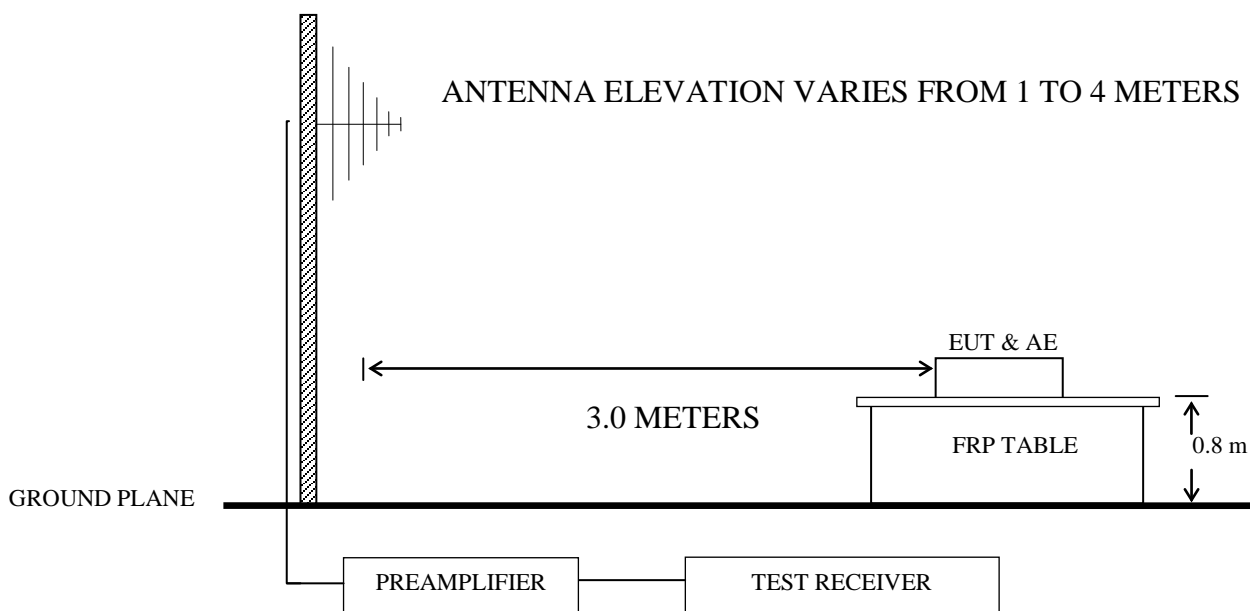

### 4.2.3 Above 1GHz

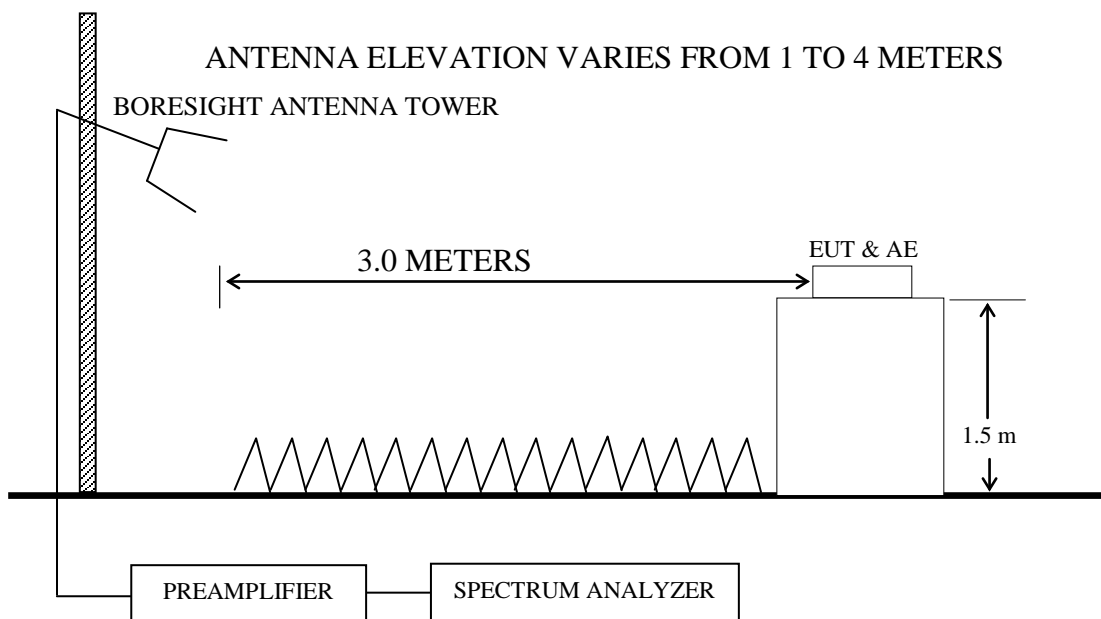

### 4.3 Radiated Emission Limit (§15.209)

Frequency (MHz)	Distance (m)	Field strength limits ( $\mu\text{V/m}$ )	
		( $\mu\text{V/m}$ )	( $\mu\text{V/m}$ )
30 ~ 88	3	100	40.0
88 ~ 216	3	150	43.5
216 ~ 960	3	200	46.0
Above 960	3	500	54.0

NOTE 1 - Emission Level dB ( $\square\text{V/m}$ ) = 20 log Emission Level ( $\square\text{V/m}$ )

NOTE 2 - The tighter limit applies at the band edges.

NOTE 3 - Distance refers to the distance in meters between the measuring instrument antenna and the closed point of any part of the device or system.

NOTE 4 - The limits shown are based on Quasi-peak value detector below or equal to 1GHz and Average value detector above 1GHz.

NOTE 5 - Above 1 GHz, the limit on peak emission is 20 dB above the maximum permitted average emission limit applicable to the EUT

### 4.4 Test Configuration

The EUT (listed in Sec.2.1) and the simulators (listed in Sec.2.2) were installed as shown on Sec.4.2 to meet FCC requirements and operating in a manner that tends to maximize its emission level in a normal application.

#### 4.5 Operating Condition of EUT

4.5.1 Setup the EUT as shown in Sec. 4.2.

4.5.2 Turn on the power of all equipment.

4.5.3 Turn the EUT on the test mode, and then test.

#### 4.6 Test Procedures

Radiated emission test applies to harmonics/spurs that fall in the restricted bands listed in Section 15.205. The maximum permitted average field strength is listed in Section 15.209. A pre-amp is necessary for this measurement. For measurement above 1 GHz, set RBW = 1MHz, VBW = 10 Hz, Sweep: Auto. If the emission is pulsed, modify the unit for continuous operation; use the settings shown above, then correct the reading by subtracting the peak-average correction factor, derived from the appropriate duty cycle calculation.

The EUT was placed on a turntable. Below 1 GHz, the table height is 80 cm above the reference ground plane. Above 1 GHz, the table height is 1.5 m. The turntable rotated 360 degrees to determine the position of the maximum emission level. The EUT was set 3 meters away from the receiving antenna, which was mounted on an antenna tower. The antenna moved up and down between 1 meter and 4 meters to find out the maximum emission level. Broadband antenna (Calibrated Bilog Antenna) or Horn antenna was used as receiving antenna. Both horizontal and vertical polarizations of the antenna were set on measurement. In order to find the maximum emission, all of the interference cables were manipulated according to ANSI C63.10: 2013 requirements during radiated emission test.

The bandwidth of Test Receiver R&S ESCI was set at 120 kHz from 30MHz to 1000MHz.

The bandwidth of Agilent N9010A was set at 1MHz for above 1GHz.

The frequency range from 30 MHz to 25 GHz (Up to 10<sup>th</sup> harmonics from fundamental frequency) was checked.

All the test results are listed in Sec.4.7.

### 4.7 Test Results

<PASS>

The frequency and amplitude of the highest radiated emission relative the limit is reported. All the emissions not reported below are too low against the FCC limit.

Frequency range: below 1GHz (Worst case emission)

No.	Operation	Modulation	Channel	Frequency	Data Page
1.	Transmitting	802.11b	1	2412 MHz	P18
2.			6	2437 MHz	P18
3.			11	2462 MHz	P19
4.		802.11g	1	2412 MHz	P19
5.		802.11n20	1	2412 MHz	P20

Frequency range: above 1GHz

No.	Operation	Modulation	Channel	Frequency	Data Page
1.	Transmitting	802.11b	1	2412 MHz	P21
2.			6	2437 MHz	P21
3.			11	2462 MHz	P22
4.	Transmitting	802.11g	1	2412 MHz	P22
5.	Transmitting	802.11n20	1	2412 MHz	P23

Restricted bands:

No.	Operation	Modulation	Channel	Frequency	Data Page
1.	Transmitting	802.11b	1	2412 MHz	P24
2.			8	2447 MHz	P24
3.			10	2457 MHz	P25
4.			11	2462 MHz	P25
5.		802.11g	1	2412 MHz	P26
6.			2	2417 MHz	P26
7.			3	2422 MHz	P27
8.			8	2447 MHz	P27
9.			10	2457 MHz	P28
10.			11	2462 MHz	P28
11.			802.11n20	1	2412 MHz
12.		2		2417 MHz	P29
13.		3		2422 MHz	P30
14.		8		2447 MHz	P30
15.		10		2457 MHz	P31
16.		11	2462 MHz	P31	

NOTE 1 – Level = Read Level + Antenna Factor + Cable Loss - Preamp Factor

NOTE 2 – “QP” means “Quasi-Peak” values

NOTE 3 – 0° was the table front facing the antenna. Degree is calculated from 0° clockwise facing the antenna.

NOTE 4 – The emission levels which not reported are too low against the official limit.



NOTE 5 – The emission levels recorded below is data of EUT configured in Standing direction, for Standing direction was the maximum emission direction during the test. The data of Side & Lying direction are too low against the official limit to be reported.

NOTE 6 – All reading are Quasi-Peak values below or equal to 1GHz, Peak and Average values above 1GHz.

For above 1GHz test, if the peak measured value complies with the average limit, it is unnecessary to perform an average measurement.

NOTE 7 – The frequency range 2310-2390MHz & 2483.5-2500MHz were tested for Restricted bands.

**Worst case emission < 1GHz**

EUT : Cync Fixture Canless Temperature : 22°C  
 Model No. : CFIXCNLR6S1 Humidity : 51%RH  
 Test Mode : Transmitting Date of Test : 2021.11.30

**802.11b CH2412MHz**

Polarization	Frequency (MHz)	Meter Reading dB (µV)	Antenna Factor (dB/m)	Cable Loss (dB)	Preamp Factor (dB)	Emission Level dB (µV/m)	Limits dB (µV/m)	Margin (dB)	Remark
Horizontal	58.613	25.3	19.4	0.82	28.17	17.35	40	22.65	QP
	108.65	29.77	16.1	1.14	27.95	19.06	43.5	24.44	QP
	156.46	30.84	18.95	1.34	27.76	23.37	43.5	20.13	QP
	240.83	30.98	17.23	1.66	27.2	22.67	46	23.33	QP
	473.84	27.64	22.73	2.37	27.85	24.89	46	21.11	QP
	<b>798.98</b>	<b>25.02</b>	<b>27.8</b>	<b>3.06</b>	<b>26.9</b>	<b>28.98</b>	<b>46</b>	<b>17.02</b>	<b>QP</b>
Vertical	50.942	23.75	19.6	0.76	28.2	15.91	40	24.09	QP
	120.28	25.72	16.6	1.19	27.9	15.61	43.5	27.89	QP
	169.01	25.63	18.7	1.39	27.66	18.06	43.5	25.44	QP
	325.6	23.03	19.82	1.96	27.17	17.64	46	28.36	QP
	499.43	25.44	23.2	2.48	27.9	23.22	46	22.78	QP
	815.97	23.59	28.2	3.12	26.8	28.11	46	17.89	QP

**802.11b CH2437MHz**

Polarization	Frequency (MHz)	Meter Reading dB (µV)	Antenna Factor (dB/m)	Cable Loss (dB)	Preamp Factor (dB)	Emission Level dB (µV/m)	Limits dB (µV/m)	Margin (dB)	Remark
Horizontal	48.843	23.88	19.5	0.74	28.2	15.92	40	24.08	QP
	108.65	27.82	16.1	1.14	27.95	17.11	43.5	26.39	QP
	156.46	30.38	18.95	1.34	27.76	22.91	43.5	20.59	QP
	240.83	29.62	17.23	1.66	27.2	21.31	46	24.69	QP
	499.43	25.56	23.2	2.48	27.9	23.34	46	22.66	QP
	881.41	23.24	28.3	3.28	26.4	28.42	46	17.58	QP
Vertical	62.431	23.92	19.06	0.86	28.15	15.69	40	24.31	QP
	99.878	25.05	15	1.1	28	13.15	43.5	30.35	QP
	159.78	24	19	1.35	27.73	16.62	43.5	26.88	QP
	333.69	22.25	19.9	1.98	27.21	16.92	46	29.08	QP
	550.95	24.94	24	2.53	27.9	23.57	46	22.43	QP
	836.24	23.27	27.9	3.14	26.7	27.61	46	18.39	QP

**802.11b CH2462MHz**

Polarization	Frequency (MHz)	Meter Reading dB (μV)	Antenna Factor (dB/m)	Cable Loss (dB)	Preamp Factor (dB)	Emission Level dB (μV/m)	Limits dB (μV/m)	Margin (dB)	Remark
Horizontal	52.391	25.42	19.5	0.78	28.19	17.51	40	22.49	QP
	108.27	28.67	16.1	1.14	27.95	17.96	43.5	25.54	QP
	156.46	30.62	18.95	1.34	27.76	23.15	43.5	20.35	QP
	240.83	30.44	17.23	1.66	27.2	22.13	46	23.87	QP
	419.11	26.71	21.65	2.22	27.67	22.91	46	23.09	QP
	818.83	24.23	28	3.12	26.8	28.55	46	17.45	QP
Vertical	60.069	24.59	19.2	0.84	28.16	16.47	40	23.53	QP
	99.878	25.71	15	1.1	28	13.81	43.5	29.69	QP
	159.78	24.68	19	1.35	27.73	17.3	43.5	26.2	QP
	263.82	24.32	17.84	1.74	27.1	16.8	46	29.2	QP
	499.43	25.15	23.2	2.48	27.9	22.93	46	23.07	QP
	827.49	23.68	27.95	3.14	26.75	28.02	46	17.98	QP

**802.11g CH2412MHz**

Polarization	Frequency (MHz)	Meter Reading dB (μV)	Antenna Factor (dB/m)	Cable Loss (dB)	Preamp Factor (dB)	Emission Level dB (μV/m)	Limits dB (μV/m)	Margin (dB)	Remark
Horizontal	60.069	23.63	19.2	0.84	28.16	15.51	40	24.49	QP
	108.27	28.11	16.1	1.14	27.95	17.4	43.5	26.1	QP
	156.46	30.17	18.95	1.34	27.76	22.7	43.5	20.8	QP
	240.83	29.37	17.23	1.66	27.2	21.06	46	24.94	QP
	452.72	26.68	22.77	2.29	27.81	23.93	46	22.07	QP
	798.98	24.26	27.8	3.06	26.9	28.22	46	17.78	QP
Vertical	54.261	23.98	19.62	0.79	28.18	16.21	40	23.79	QP
	99.878	25.78	15	1.1	28	13.88	43.5	29.62	QP
	159.78	21.93	19	1.35	27.73	14.55	43.5	28.95	QP
	302.48	21.51	19.1	1.92	27.02	15.51	46	30.49	QP
	504.71	24.55	23.3	2.49	27.9	22.44	46	23.56	QP
	818.83	22.79	28	3.12	26.8	27.11	46	18.89	QP

**802.11n20 CH2412MHz**

Polarization	Frequency (MHz)	Meter Reading dB (μV)	Antenna Factor (dB/m)	Cable Loss (dB)	Preamplifier Factor (dB)	Emission Level dB (μV/m)	Limits dB (μV/m)	Margin (dB)	Remark
Horizontal	54.643	24.52	19.66	0.79	28.18	16.79	40	23.21	QP
	108.27	28.29	16.1	1.14	27.95	17.58	43.5	25.92	QP
	156.46	29.7	18.95	1.34	27.76	22.23	43.5	21.27	QP
	240.83	29.87	17.23	1.66	27.2	21.56	46	24.44	QP
	480.53	26.24	22.9	2.4	27.86	23.68	46	22.32	QP
	821.71	24.74	28	3.12	26.75	29.11	46	16.89	QP
Vertical	54.643	22.86	19.66	0.79	28.18	15.13	40	24.87	QP
	118.6	22.69	16.55	1.18	27.91	12.51	43.5	30.99	QP
	159.78	24.09	19	1.35	27.73	16.71	43.5	26.79	QP
	263.82	24.36	17.84	1.74	27.1	16.84	46	29.16	QP
	426.52	25.95	21.93	2.23	27.7	22.41	46	23.59	QP
	785.09	23.31	27.9	3.02	26.99	27.24	46	18.76	QP

TEST ENGINEER: Jarey

### Radiated Emission > 1GHz

EUT : Cync Fixture Canless Temperature : 22°C  
 Model No. : CFIXCNLR6S1 Humidity : 51%RH  
 Test Mode : Transmitting Date of Test : 2021.11.30

#### 802.11b CH2412MHz

Polarization	Frequency (MHz)	Meter Reading dB (μV)	Antenna Factor (dB/m)	Cable Loss (dB)	Preamp Factor (dB)	Emission Level dB (μV/m)	Limits dB (μV/m)	Margin (dB)	Remark
Horizontal	3184	43.83	30.58	6.09	35.24	45.26	74	28.74	Peak
	4824	48.6	33.26	7.55	34.75	54.66	74	19.34	Peak
	<b>4824</b>	<b>39.64</b>	<b>33.26</b>	<b>7.55</b>	<b>34.75</b>	<b>45.7</b>	<b>54</b>	<b>8.3</b>	<b>Average</b>
	7720	36.76	37.21	10.01	34.8	49.18	74	24.82	Peak
	9832	36.6	38.37	11.24	34.62	51.59	74	22.41	Peak
	11824	35.95	38.93	12.22	34.23	52.87	74	21.13	Peak
Vertical	2740	44.31	29.31	5.68	35.52	43.78	74	30.22	Peak
	4816	39.47	33.26	7.55	34.75	45.53	74	28.47	Peak
	7036	36.94	35.7	9.26	34.8	47.1	74	26.9	Peak
	8560	36.66	38.54	10.52	34.74	50.98	74	23.02	Peak
	10444	36.45	38.31	11.46	34.51	51.71	74	22.29	Peak
	11548	35.43	38.81	11.99	34.28	51.95	74	22.05	Peak

#### 802.11b CH2437MHz

Polarization	Frequency (MHz)	Meter Reading dB (μV)	Antenna Factor (dB/m)	Cable Loss (dB)	Preamp Factor (dB)	Emission Level dB (μV/m)	Limits dB (μV/m)	Margin (dB)	Remark
Horizontal	3364	41.97	31.01	6.23	35.18	44.03	74	29.97	Peak
	4874	45.44	33.49	7.61	34.74	51.8	74	22.2	Peak
	4874	36.81	33.49	7.61	34.74	43.17	54	10.83	Average
	6808	38.23	35.17	9.09	34.78	47.71	74	26.29	Peak
	9448	36.86	38.29	11.06	34.65	51.56	74	22.44	Peak
	11440	36.22	38.8	11.99	34.31	52.7	74	21.3	Peak
Vertical	3244	42.03	30.71	6.14	35.22	43.66	74	30.34	Peak
	5212	37.99	34.04	7.89	34.7	45.22	74	28.78	Peak
	7144	36.56	35.95	9.37	34.8	47.08	74	26.92	Peak
	9172	35.57	38.24	10.88	34.68	50.01	74	23.99	Peak
	10960	35.59	38.74	11.64	34.41	51.56	74	22.44	Peak
	12256	35.48	38.8	12.56	34.12	52.72	74	21.28	Peak

**802.11b CH2462MHz**

Polarization	Frequency (MHz)	Meter Reading dB ( $\mu$ V)	Antenna Factor (dB/m)	Cable Loss (dB)	Preamplifier Factor (dB)	Emission Level dB ( $\mu$ V/m)	Limits dB ( $\mu$ V/m)	Margin (dB)	Remark
Horizontal	3292	42.71	30.82	6.18	35.2	44.51	74	29.49	Peak
	4924	44.39	33.72	7.67	34.72	51.06	74	22.94	Peak
	4924	34.21	33.72	7.67	34.72	40.88	54	13.12	Average
	7120	36.92	35.9	9.37	34.8	47.39	74	26.61	Peak
	9292	36.76	38.26	10.88	34.67	51.23	74	22.77	Peak
	11956	36.22	38.97	12.33	34.21	53.31	74	20.69	Peak
Vertical	3472	40.89	31.25	6.36	35.15	43.35	74	30.65	Peak
	5212	37.59	34.04	7.89	34.7	44.82	74	29.18	Peak
	6832	37.31	35.22	9.09	34.78	46.84	74	27.16	Peak
	8464	35.83	38.56	10.46	34.75	50.1	74	23.9	Peak
	10456	35.76	38.31	11.51	34.51	51.07	74	22.93	Peak
	11980	34.03	38.99	12.33	34.2	51.15	74	22.85	Peak

**802.11g CH2412MHz**

Polarization	Frequency (MHz)	Meter Reading dB ( $\mu$ V)	Antenna Factor (dB/m)	Cable Loss (dB)	Preamplifier Factor (dB)	Emission Level dB ( $\mu$ V/m)	Limits dB ( $\mu$ V/m)	Margin (dB)	Remark
Horizontal	3388	42.45	31.05	6.27	35.17	44.6	74	29.4	Peak
	4824	45.58	33.26	7.55	34.75	51.64	74	22.36	Peak
	4824	36.51	33.26	7.55	34.75	42.57	54	11.43	Average
	6784	37.26	35.07	9.09	34.78	46.64	74	27.36	Peak
	9064	36.76	38.22	10.79	34.69	51.08	74	22.92	Peak
	12244	35.58	38.8	12.45	34.13	52.7	74	21.3	Peak
Vertical	3340	41.5	30.94	6.23	35.19	43.48	74	30.52	Peak
	4948	39.02	33.77	7.67	34.71	45.75	74	28.25	Peak
	7168	36.6	36	9.47	34.8	47.27	74	26.73	Peak
	8440	36.12	38.51	10.46	34.75	50.34	74	23.66	Peak
	10480	35.97	38.31	11.51	34.5	51.29	74	22.71	Peak
	12184	34.93	38.86	12.45	34.14	52.1	74	21.9	Peak

**802.11n20 CH2412MHz**

Polarization	Frequency (MHz)	Meter Reading dB (µV)	Antenna Factor (dB/m)	Cable Loss (dB)	Preamplifier Factor (dB)	Emission Level dB (µV/m)	Limits dB (µV/m)	Margin (dB)	Remark
Horizontal	3484	42.09	31.28	6.36	35.14	44.59	74	29.41	Peak
	4824	42.97	33.26	7.55	34.75	49.03	74	24.97	Peak
	4824	34.86	33.26	7.55	34.75	40.92	54	13.08	Average
	7096	38.09	35.85	9.37	34.8	48.51	74	25.49	Peak
	10372	35.76	38.33	11.46	34.52	51.03	74	22.97	Peak
	12256	35.23	38.8	12.56	34.12	52.47	74	21.53	Peak
Vertical	3112	41.28	30.39	6.01	35.26	42.42	74	31.58	Peak
	5440	37.74	34.09	8.04	34.7	45.17	74	28.83	Peak
	7108	37.44	35.9	9.37	34.8	47.91	74	26.09	Peak
	8812	35.93	38.34	10.64	34.72	50.19	74	23.81	Peak
	10504	34.93	38.3	11.51	34.5	50.24	74	23.76	Peak
	11452	35.23	38.8	11.99	34.31	51.71	74	22.29	Peak

TEST ENGINEER: Jarey

**Emissions in restricted frequency bands:**

EUT : Cync Fixture Canless Temperature : 22°C  
 Model No. : CFIXCNLR6S1 Humidity : 51%RH  
 Test Mode : Transmitting Date of Test : 2021.11.30-2022.01.15

**802.11b CH2412MHz**

Polarization	Frequency (MHz)	Meter Reading dB (µV)	Antenna Factor (dB/m)	Cable Loss (dB)	Preamp Factor (dB)	Emission Level dB (µV/m)	Limits dB (µV/m)	Margin (dB)	Remark
Horizontal	2341.5	58.17	28.08	5.29	35.91	55.63	74	18.37	Peak
	2341.5	46.42	28.08	5.29	35.91	43.88	54	10.12	Average
	2363.5	57.9	28.15	5.32	35.89	55.48	74	18.52	Peak
	2363.5	46.3	28.15	5.32	35.89	43.88	54	10.12	Average
	2389.2	59.92	28.21	5.36	35.86	57.63	74	16.37	Peak
	2389.2	47.29	28.21	5.36	35.86	45	54	9	Average
	2390	57.74	28.21	5.36	35.86	55.45	74	18.55	Peak
Vertical	2390	47.03	28.21	5.36	35.86	44.74	54	9.26	Average
	2338.6	50	28.08	5.29	35.92	47.45	74	26.55	Peak
	2338.6	37.6	28.08	5.29	35.92	35.05	54	18.95	Average
	2362.4	49.43	28.14	5.32	35.89	47	74	27	Peak
	2362.4	38.24	28.14	5.32	35.89	35.81	54	18.19	Average
	2388.7	58.96	28.21	5.36	35.86	56.67	74	17.33	Peak
	2388.7	39.59	28.21	5.36	35.86	37.3	54	16.7	Average
Vertical	2390	58.42	28.21	5.36	35.86	56.13	74	17.87	Peak
	2390	39.65	28.21	5.36	35.86	37.36	54	16.64	Average

**802.11b CH2447MHz**

Polarization	Frequency (MHz)	Meter Reading dB (µV)	Antenna Factor (dB/m)	Cable Loss (dB)	Preamp Factor (dB)	Emission Level dB (µV/m)	Limits dB (µV/m)	Margin (dB)	Remark
Horizontal	2483.5	60.05	28.46	5.43	35.76	58.18	74	15.82	Peak
	2483.5	47.11	28.46	5.43	35.76	45.24	54	8.76	Average
	2489.4	59.12	28.48	5.47	35.76	57.31	74	16.69	Peak
	2489.4	47.31	28.48	5.47	35.76	45.5	54	8.5	Average
	2494.4	58.26	28.48	5.47	35.76	56.45	74	17.55	Peak
Vertical	2494.4	46.26	28.48	5.47	35.76	44.45	54	9.55	Average
	2483.5	50.57	28.46	5.43	35.76	48.7	74	25.3	Peak
	2483.5	38.56	28.46	5.43	35.76	36.69	54	17.31	Average
	2489.8	50.91	28.48	5.47	35.76	49.1	74	24.9	Peak
	2489.8	38.39	28.48	5.47	35.76	36.58	54	17.42	Average
Vertical	2497.6	50.44	28.5	5.47	35.76	48.65	74	25.35	Peak
	2497.6	38.74	28.5	5.47	35.76	36.95	54	17.05	Average



**802.11b CH2457MHz**

Polarization	Frequency (MHz)	Meter Reading dB ( $\mu$ V)	Antenna Factor (dB/m)	Cable Loss (dB)	Preamplifier Factor (dB)	Emission Level dB ( $\mu$ V/m)	Limits dB ( $\mu$ V/m)	Margin (dB)	Remark
Horizontal	2483.5	58.74	28.46	5.43	35.76	56.87	74	17.13	Peak
	2483.5	46.87	28.46	5.43	35.76	45	54	9	Average
	2484.2	59.22	28.46	5.43	35.76	57.35	74	16.65	Peak
	2484.2	47.32	28.46	5.43	35.76	45.45	54	8.55	Average
	2487.4	60.33	28.46	5.47	35.76	58.5	74	15.5	Peak
	2487.4	46.63	28.46	5.47	35.76	44.8	54	9.2	Average
	2494.4	58.61	28.48	5.47	35.76	56.8	74	17.2	Peak
	2494.4	47.16	28.48	5.47	35.76	45.35	54	8.65	Average
Vertical	2483.5	49.65	28.46	5.43	35.76	47.78	74	26.22	Peak
	2483.5	39.76	28.46	5.43	35.76	37.89	54	16.11	Average
	2484	50.48	28.46	5.43	35.76	48.61	74	25.39	Peak
	2484	39.45	28.46	5.43	35.76	37.58	54	16.42	Average
	2490.9	50.71	28.48	5.47	35.76	48.9	74	25.1	Peak
	2490.9	39.27	28.48	5.47	35.76	37.46	54	16.54	Average
	2494.8	49.93	28.48	5.47	35.76	48.12	74	25.88	Peak
	2494.8	39.39	28.48	5.47	35.76	37.58	54	16.42	Average

**802.11b CH2462MHz**

Polarization	Frequency (MHz)	Meter Reading dB ( $\mu$ V)	Antenna Factor (dB/m)	Cable Loss (dB)	Preamplifier Factor (dB)	Emission Level dB ( $\mu$ V/m)	Limits dB ( $\mu$ V/m)	Margin (dB)	Remark
Horizontal	2483.5	58.35	28.46	5.43	35.76	56.48	74	17.52	Peak
	2483.5	46.94	28.46	5.43	35.76	45.07	54	8.93	Average
	2483.9	60.37	28.46	5.43	35.76	58.5	74	15.5	Peak
	2483.9	47.44	28.46	5.43	35.76	45.57	54	8.43	Average
	2490.6	59.68	28.48	5.47	35.76	57.87	74	16.13	Peak
	2490.6	47.26	28.48	5.47	35.76	45.45	54	8.55	Average
	2497.6	58.78	28.5	5.47	35.76	56.99	74	17.01	Peak
	2497.6	47.28	28.5	5.47	35.76	45.49	54	8.51	Average
Vertical	2483.5	50.24	28.46	5.43	35.76	48.37	74	25.63	Peak
	2483.5	39.42	28.46	5.43	35.76	37.55	54	16.45	Average
	2489.2	51.2	28.48	5.47	35.76	49.39	74	24.61	Peak
	2489.2	39.61	28.48	5.47	35.76	37.8	54	16.2	Average
	2495.6	50.76	28.48	5.47	35.76	48.95	74	25.05	Peak
	2495.6	38.48	28.48	5.47	35.76	36.67	54	17.33	Average

**802.11g CH2412MHz**

Polarization	Frequency (MHz)	Meter Reading dB (μV)	Antenna Factor (dB/m)	Cable Loss (dB)	Preamp Factor (dB)	Emission Level dB (μV/m)	Limits dB (μV/m)	Margin (dB)	Remark
Horizontal	2327.1	58.23	28.05	5.29	35.93	55.64	74	18.36	Peak
	2327.1	46.52	28.05	5.29	35.93	43.93	54	10.07	Average
	2353.3	58.11	28.12	5.32	35.9	55.65	74	18.35	Peak
	2353.3	46.21	28.12	5.32	35.9	43.75	54	10.25	Average
	2390	65.2	28.21	5.36	35.86	62.91	74	11.09	Peak
	2390	50.42	28.21	5.36	35.86	48.13	54	5.87	Average
Vertical	2333.5	49.81	28.06	5.29	35.92	47.24	74	26.76	Peak
	2333.5	36.49	28.06	5.29	35.92	33.92	54	20.08	Average
	2361.6	48.72	28.14	5.32	35.89	46.29	74	27.71	Peak
	2361.6	36.77	28.14	5.32	35.89	34.34	54	19.66	Average
	2390	56.36	28.21	5.36	35.86	54.07	74	19.93	Peak
	2390	42.43	28.21	5.36	35.86	40.14	54	13.86	Average

**802.11g CH2417MHz**

Polarization	Frequency (MHz)	Meter Reading dB (μV)	Antenna Factor (dB/m)	Cable Loss (dB)	Preamp Factor (dB)	Emission Level dB (μV/m)	Limits dB (μV/m)	Margin (dB)	Remark
Horizontal	2331.3	58.17	28.06	5.29	35.93	55.59	74	18.41	Peak
	2331.3	46.32	28.06	5.29	35.93	43.74	54	10.26	Average
	2364.8	58.78	28.15	5.32	35.89	56.36	74	17.64	Peak
	2364.8	46.49	28.15	5.32	35.89	44.07	54	9.93	Average
	2389.9	61.21	28.21	5.36	35.86	58.92	74	15.08	Peak
	2389.9	48.42	28.21	5.36	35.86	46.13	54	7.87	Average
	2390	61.03	28.21	5.36	35.86	58.74	74	15.26	Peak
	2390	48.66	28.21	5.36	35.86	46.37	54	7.63	Average
Vertical	2334.3	49.22	28.06	5.29	35.92	46.65	74	27.35	Peak
	2334.3	36.43	28.06	5.29	35.92	33.86	54	20.14	Average
	2361.2	48.82	28.14	5.32	35.89	46.39	74	27.61	Peak
	2361.2	36.68	28.14	5.32	35.89	34.25	54	19.75	Average
	2389.9	53.54	28.21	5.36	35.86	51.25	74	22.75	Peak
	2389.9	40.25	28.21	5.36	35.86	37.96	54	16.04	Average
	2390	52.03	28.21	5.36	35.86	49.74	74	24.26	Peak
2390	39.96	28.21	5.36	35.86	37.67	54	16.33	Average	

**802.11g CH2422MHz**

Polarization	Frequency (MHz)	Meter Reading dB ( $\mu$ V)	Antenna Factor (dB/m)	Cable Loss (dB)	Preamp Factor (dB)	Emission Level dB ( $\mu$ V/m)	Limits dB ( $\mu$ V/m)	Margin (dB)	Remark
Horizontal	2326.1	57.5	28.05	5.29	35.93	54.91	74	19.09	Peak
	2326.1	46.45	28.05	5.29	35.93	43.86	54	10.14	Average
	2361.1	58.61	28.14	5.32	35.89	56.18	74	17.82	Peak
	2361.1	46.36	28.14	5.32	35.89	43.93	54	10.07	Average
	2390	61.68	28.21	5.36	35.86	59.39	74	14.61	Peak
	2390	46.57	28.21	5.36	35.86	44.28	54	9.72	Average
Vertical	2330.7	48.71	28.06	5.29	35.93	46.13	74	27.87	Peak
	2330.7	36.48	28.06	5.29	35.93	33.9	54	20.1	Average
	2369.8	50.34	28.17	5.32	35.89	47.94	74	26.06	Peak
	2369.8	37.64	28.17	5.32	35.89	35.24	54	18.76	Average
	2389.9	53.71	28.21	5.36	35.86	51.42	74	22.58	Peak
	2389.9	38.47	28.21	5.36	35.86	36.18	54	17.82	Average
	2390	52.43	28.21	5.36	35.86	50.14	74	23.86	Peak
	2390	37.67	28.21	5.36	35.86	35.38	54	18.62	Average

**802.11g CH2447MHz**

Polarization	Frequency (MHz)	Meter Reading dB ( $\mu$ V)	Antenna Factor (dB/m)	Cable Loss (dB)	Preamp Factor (dB)	Emission Level dB ( $\mu$ V/m)	Limits dB ( $\mu$ V/m)	Margin (dB)	Remark
Horizontal	2483.5	57.95	28.46	5.43	35.76	56.08	74	17.92	Peak
	2483.5	45.78	28.46	5.43	35.76	43.91	54	10.09	Average
	2483.6	60.47	28.46	5.43	35.76	58.6	74	15.4	Peak
	2483.6	46.45	28.46	5.43	35.76	44.58	54	9.42	Average
	2489.5	59.27	28.48	5.47	35.76	57.46	74	16.54	Peak
	2489.5	46.62	28.48	5.47	35.76	44.81	54	9.19	Average
	2496.1	57.98	28.48	5.47	35.76	56.17	74	17.83	Peak
	2496.1	45.9	28.48	5.47	35.76	44.09	54	9.91	Average
Vertical	2483.5	53.43	28.46	5.43	35.76	51.56	74	22.44	Peak
	2483.5	38.54	28.46	5.43	35.76	36.67	54	17.33	Average
	2489.8	51.01	28.48	5.47	35.76	49.2	74	24.8	Peak
	2489.8	38.4	28.48	5.47	35.76	36.59	54	17.41	Average
	2498.2	49.35	28.5	5.47	35.76	47.56	74	26.44	Peak
	2498.2	38.23	28.5	5.47	35.76	36.44	54	17.56	Average

**802.11g CH2457MHz**

Polarization	Frequency (MHz)	Meter Reading dB ( $\mu$ V)	Antenna Factor (dB/m)	Cable Loss (dB)	Preamp Factor (dB)	Emission Level dB ( $\mu$ V/m)	Limits dB ( $\mu$ V/m)	Margin (dB)	Remark
Horizontal	2483.5	58.73	28.46	5.43	35.76	56.86	74	17.14	Peak
	2483.5	47.16	28.46	5.43	35.76	45.29	54	8.71	Average
	2483.9	60.51	28.46	5.43	35.76	58.64	74	15.36	Peak
	2483.9	48.45	28.46	5.43	35.76	46.58	54	7.42	Average
	2492.4	59.27	28.48	5.47	35.76	57.46	74	16.54	Peak
	2492.4	47.33	28.48	5.47	35.76	45.52	54	8.48	Average
	2498.9	58.37	28.5	5.47	35.76	56.58	74	17.42	Peak
	2498.9	47.54	28.5	5.47	35.76	45.75	54	8.25	Average
Vertical	2483.5	52.85	28.46	5.43	35.76	50.98	74	23.02	Peak
	2483.5	39.62	28.46	5.43	35.76	37.75	54	16.25	Average
	2483.6	53.25	28.46	5.43	35.76	51.38	74	22.62	Peak
	2483.6	39.33	28.46	5.43	35.76	37.46	54	16.54	Average
	2490.2	51.09	28.48	5.47	35.76	49.28	74	24.72	Peak
	2490.2	39.2	28.48	5.47	35.76	37.39	54	16.61	Average
	2497.2	50.14	28.5	5.47	35.76	48.35	74	25.65	Peak
	2497.2	38.51	28.5	5.47	35.76	36.72	54	17.28	Average

**802.11g CH2462MHz**

Polarization	Frequency (MHz)	Meter Reading dB ( $\mu$ V)	Antenna Factor (dB/m)	Cable Loss (dB)	Preamp Factor (dB)	Emission Level dB ( $\mu$ V/m)	Limits dB ( $\mu$ V/m)	Margin (dB)	Remark
Horizontal	2483.5	62.79	28.46	5.43	35.76	60.92	74	13.08	Peak
	2483.5	48.12	28.46	5.43	35.76	46.25	54	7.75	Average
	2483.7	63.38	28.46	5.43	35.76	61.51	74	12.49	Peak
	2483.7	48.44	28.46	5.43	35.76	46.57	54	7.43	Average
	2489.7	59.25	28.48	5.47	35.76	57.44	74	16.56	Peak
	2489.7	47.42	28.48	5.47	35.76	45.61	54	8.39	Average
	2494.8	59.97	28.48	5.47	35.76	58.16	74	15.84	Peak
	2494.8	47.7	28.48	5.47	35.76	45.89	54	8.11	Average
Vertical	2483.5	53.94	28.46	5.43	35.76	52.07	74	21.93	Peak
	2483.5	41.07	28.46	5.43	35.76	39.2	54	14.8	Average
	2483.6	54.76	28.46	5.43	35.76	52.89	74	21.11	Peak
	2483.6	41.58	28.46	5.43	35.76	39.71	54	14.29	Average
	2487.8	54.35	28.46	5.47	35.76	52.52	74	21.48	Peak
	2487.8	39.23	28.46	5.47	35.76	37.4	54	16.6	Average
	2496.8	50.43	28.5	5.47	35.76	48.64	74	25.36	Peak
	2496.8	38.74	28.5	5.47	35.76	36.95	54	17.05	Average

**802.11n20 CH2412MHz**

Polarization	Frequency (MHz)	Meter Reading dB (μV)	Antenna Factor (dB/m)	Cable Loss (dB)	Preamp Factor (dB)	Emission Level dB (μV/m)	Limits dB (μV/m)	Margin (dB)	Remark
Horizontal	2330.6	57.85	28.06	5.29	35.93	55.27	74	18.73	Peak
	2330.6	46.49	28.06	5.29	35.93	43.91	54	10.09	Average
	2359.6	57.68	28.14	5.32	35.89	55.25	74	18.75	Peak
	2359.6	46.67	28.14	5.32	35.89	44.24	54	9.76	Average
	2390	67.53	28.21	5.36	35.86	65.24	74	8.76	Peak
	2390	50.25	28.21	5.36	35.86	47.96	54	6.04	Average
Vertical	2330	48.9	28.06	5.29	35.93	46.32	74	27.68	Peak
	2330	36.3	28.06	5.29	35.93	33.72	54	20.28	Average
	2352.7	49.86	28.12	5.32	35.9	47.4	74	26.6	Peak
	2352.7	36.59	28.12	5.32	35.9	34.13	54	19.87	Average
	2390	58.06	28.21	5.36	35.86	55.77	74	18.23	Peak
	2390	41.3	28.21	5.36	35.86	39.01	54	14.99	Average

**802.11n20 CH2417MHz**

Polarization	Frequency (MHz)	Meter Reading dB (μV)	Antenna Factor (dB/m)	Cable Loss (dB)	Preamp Factor (dB)	Emission Level dB (μV/m)	Limits dB (μV/m)	Margin (dB)	Remark
Horizontal	2337.1	57.39	28.08	5.29	35.92	54.84	74	19.16	Peak
	2337.1	46.24	28.08	5.29	35.92	43.69	54	10.31	Average
	2359.1	58.05	28.14	5.32	35.89	55.62	74	18.38	Peak
	2359.1	46.4	28.14	5.32	35.89	43.97	54	10.03	Average
	2388.5	61.47	28.21	5.36	35.86	59.18	74	14.82	Peak
	2388.5	47.64	28.21	5.36	35.86	45.35	54	8.65	Average
	2390	59.23	28.21	5.36	35.86	56.94	74	17.06	Peak
	2390	47.85	28.21	5.36	35.86	45.56	54	8.44	Average
Vertical	2334.8	49.08	28.06	5.29	35.92	46.51	74	27.49	Peak
	2334.8	37.11	28.06	5.29	35.92	34.54	54	19.46	Average
	2368	49.14	28.15	5.32	35.89	46.72	74	27.28	Peak
	2368	37.43	28.15	5.32	35.89	35.01	54	18.99	Average
	2390	54.22	28.21	5.36	35.86	51.93	74	22.07	Peak
	2390	39.62	28.21	5.36	35.86	37.33	54	16.67	Average

**802.11n20 CH2422MHz**

Polarization	Frequency (MHz)	Meter Reading dB ( $\mu$ V)	Antenna Factor (dB/m)	Cable Loss (dB)	Preamp Factor (dB)	Emission Level dB ( $\mu$ V/m)	Limits dB ( $\mu$ V/m)	Margin (dB)	Remark
Horizontal	2329.2	57.85	28.06	5.29	35.93	55.27	74	18.73	Peak
	2329.2	45.39	28.06	5.29	35.93	42.81	54	11.19	Average
	2361.3	57.63	28.14	5.32	35.89	55.2	74	18.8	Peak
	2361.3	45.56	28.14	5.32	35.89	43.13	54	10.87	Average
	2389.1	60.52	28.21	5.36	35.86	58.23	74	15.77	Peak
	2389.1	46.35	28.21	5.36	35.86	44.06	54	9.94	Average
	2390	59.27	28.21	5.36	35.86	56.98	74	17.02	Peak
Vertical	2390	45.88	28.21	5.36	35.86	43.59	54	10.41	Average
	2330.9	48.97	28.06	5.29	35.93	46.39	74	27.61	Peak
	2330.9	36.4	28.06	5.29	35.93	33.82	54	20.18	Average
	2371.6	49.86	28.17	5.32	35.88	47.47	74	26.53	Peak
	2371.6	36.7	28.17	5.32	35.88	34.31	54	19.69	Average
	2390	54.52	28.21	5.36	35.86	52.23	74	21.77	Peak
2390	38.35	28.21	5.36	35.86	36.06	54	17.94	Average	

**802.11n20 CH2447MHz**

Polarization	Frequency (MHz)	Meter Reading dB ( $\mu$ V)	Antenna Factor (dB/m)	Cable Loss (dB)	Preamp Factor (dB)	Emission Level dB ( $\mu$ V/m)	Limits dB ( $\mu$ V/m)	Margin (dB)	Remark
Horizontal	2483.5	60.76	28.46	5.43	35.76	58.89	74	15.11	Peak
	2483.5	46.36	28.46	5.43	35.76	44.49	54	9.51	Average
	2484.2	62.37	28.46	5.43	35.76	60.5	74	13.5	Peak
	2484.2	47.54	28.46	5.43	35.76	45.67	54	8.33	Average
	2492.1	58.95	28.48	5.47	35.76	57.14	74	16.86	Peak
	2492.1	46.5	28.48	5.47	35.76	44.69	54	9.31	Average
	2495.5	58.12	28.48	5.47	35.76	56.31	74	17.69	Peak
Vertical	2495.5	47.21	28.48	5.47	35.76	45.4	54	8.6	Average
	2483.5	54.6	28.46	5.43	35.76	52.73	74	21.27	Peak
	2483.5	38.46	28.46	5.43	35.76	36.59	54	17.41	Average
	2488.3	52.54	28.46	5.47	35.76	50.71	74	23.29	Peak
	2488.3	39.25	28.46	5.47	35.76	37.42	54	16.58	Average
	2495.9	50.86	28.48	5.47	35.76	49.05	74	24.95	Peak
2495.9	38.69	28.48	5.47	35.76	36.88	54	17.12	Average	

**802.11n20 CH2457MHz**

Polarization	Frequency (MHz)	Meter Reading dB ( $\mu$ V)	Antenna Factor (dB/m)	Cable Loss (dB)	Preamp Factor (dB)	Emission Level dB ( $\mu$ V/m)	Limits dB ( $\mu$ V/m)	Margin (dB)	Remark
Horizontal	2483.5	63.95	28.46	5.43	35.76	62.08	74	11.92	Peak
	2483.5	48.49	28.46	5.43	35.76	46.62	54	7.38	Average
	2490.1	59.79	28.48	5.47	35.76	57.98	74	16.02	Peak
	2490.1	47.47	28.48	5.47	35.76	45.66	54	8.34	Average
	2495.8	58.26	28.48	5.47	35.76	56.45	74	17.55	Peak
	2495.8	47.23	28.48	5.47	35.76	45.42	54	8.58	Average
Vertical	2483.5	53.13	28.46	5.43	35.76	51.26	74	22.74	Peak
	2483.5	40.01	28.46	5.43	35.76	38.14	54	15.86	Average
	2483.7	53.95	28.46	5.43	35.76	52.08	74	21.92	Peak
	2483.7	39.6	28.46	5.43	35.76	37.73	54	16.27	Average
	2490.4	52.2	28.48	5.47	35.76	50.39	74	23.61	Peak
	2490.4	39.71	28.48	5.47	35.76	37.9	54	16.1	Average
	2496.7	50.86	28.5	5.47	35.76	49.07	74	24.93	Peak
	2496.7	38.89	28.5	5.47	35.76	37.1	54	16.9	Average

**802.11n20 CH2462MHz**

Polarization	Frequency (MHz)	Meter Reading dB ( $\mu$ V)	Antenna Factor (dB/m)	Cable Loss (dB)	Preamp Factor (dB)	Emission Level dB ( $\mu$ V/m)	Limits dB ( $\mu$ V/m)	Margin (dB)	Remark
Horizontal	2483.5	65.23	28.46	5.43	35.76	63.36	74	10.64	Peak
	2483.5	47.98	28.46	5.43	35.76	46.11	54	7.89	Average
	2484.1	66.7	28.46	5.43	35.76	64.83	74	9.17	Peak
	2484.1	48.47	28.46	5.43	35.76	46.6	54	7.4	Average
	2492.3	61.65	28.48	5.47	35.76	59.84	74	14.16	Peak
	2492.3	48.27	28.48	5.47	35.76	46.46	54	7.54	Average
	2498.7	58.87	28.5	5.47	35.76	57.08	74	16.92	Peak
	2498.7	47.49	28.5	5.47	35.76	45.7	54	8.3	Average
Vertical	2483.5	53.93	28.46	5.43	35.76	52.06	74	21.94	Peak
	2483.5	41.73	28.46	5.43	35.76	39.86	54	14.14	Average
	2483.6	55.6	28.46	5.43	35.76	53.73	74	20.27	Peak
	2483.6	41.36	28.46	5.43	35.76	39.49	54	14.51	Average
	2489.1	53.95	28.48	5.47	35.76	52.14	74	21.86	Peak
	2489.1	39.29	28.48	5.47	35.76	37.48	54	16.52	Average
	2494.8	51.19	28.48	5.47	35.76	49.38	74	24.62	Peak
	2494.8	38.52	28.48	5.47	35.76	36.71	54	17.29	Average

TEST ENGINEER: Jarey

## 5 6 dB BANDWIDTH MEASUREMENT

### 5.1 Test Equipment

The following test equipment was used during the Emission Bandwidth measurement:

Item	Type	Manufacturer	Model No.	Serial No.	Cal. Date	Cal. Interval
4.	Spectrum Analyzer	Agilent	N9010A	MY52221182	2021.09.15	1 Year
5.	Coaxial Cable	WOKEN	SFL402-105F LEX	F02-150819-045	2021.03.08	1 Year
6.	20 dB Attenuator	Mini-Circuits	VAT-20+	001	2021.08.06	1 Year

### 5.2 Block Diagram of Test Setup

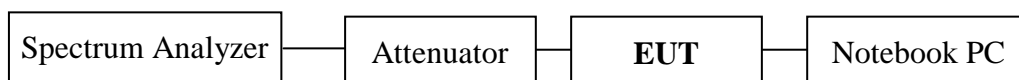

### 5.3 Specification Limits (§15.247(a)(2))

The minimum 6 dB bandwidth shall be at least 500 kHz.

### 5.4 Operating Condition of EUT

The switch ON/OFF was used to enable the EUT to change the channel one by one.

### 5.5 Test Procedure

The transmitter output was connected to the spectrum analyzer. The bandwidth of the fundamental frequency was measure by spectrum analyzer with settings: RBW = 100kHz, VBW  $\geq 3 \times$  RBW.

The 6 dB bandwidth is defined as the total spectrum the power of which is lower than peak power minus 6 dB .

The test procedure is defined in ANSI C63.10-2013 (the 11.8.2 Measurement Procedure “Option 2” was used).



### 5.6 Test Results

**PASSED.**

All the test results are attached in next pages.

(Test Date: 2021.11.30 Temperature: 23°C Humidity: 51 %)

Modulation	Channel	Frequency (MHz)	6dB Bandwidth (MHz)	Limit
802.11b	1	2412	<b>8.449</b>	500 kHz
	6	2437	<b>8.453</b>	500 kHz
	11	2462	<b>8.447</b>	500 kHz
802.11g	1	2412	<b>16.57</b>	500 kHz
	6	2437	<b>16.55</b>	500 kHz
	11	2462	<b>16.57</b>	500 kHz
802.11n20	1	2412	<b>17.77</b>	500 kHz
	6	2437	<b>17.78</b>	500 kHz
	11	2462	<b>17.76</b>	500 kHz

802.11b CH2412MHz

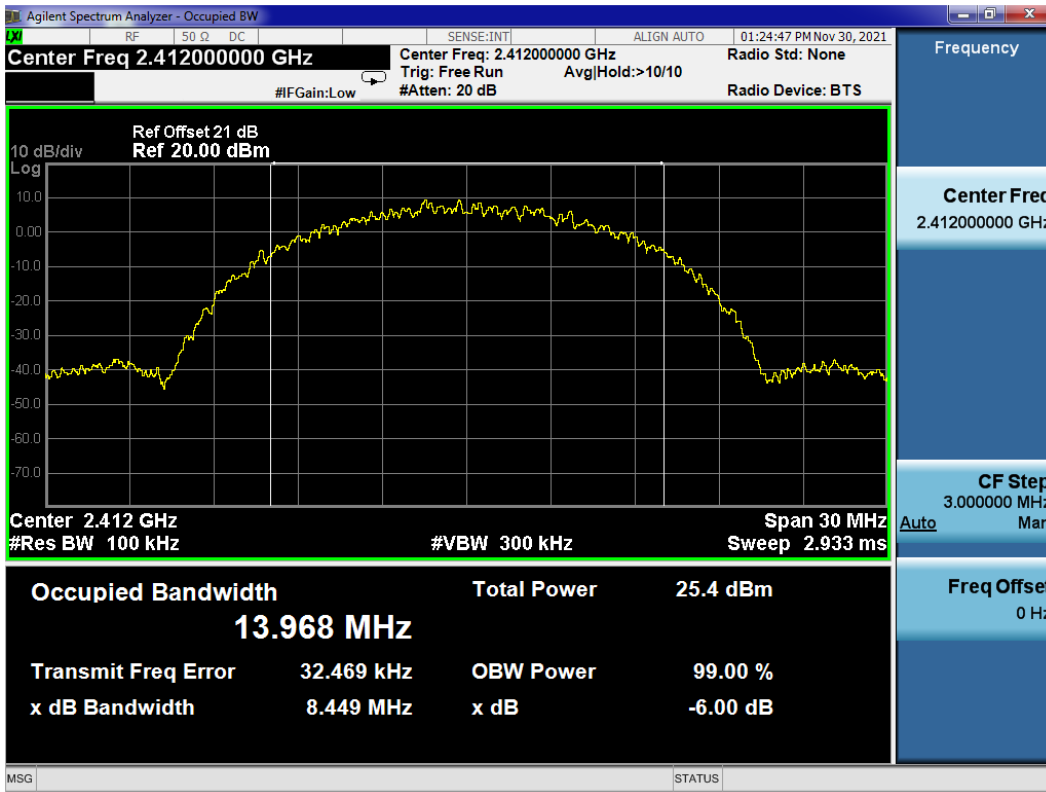

802.11b CH2437MHz

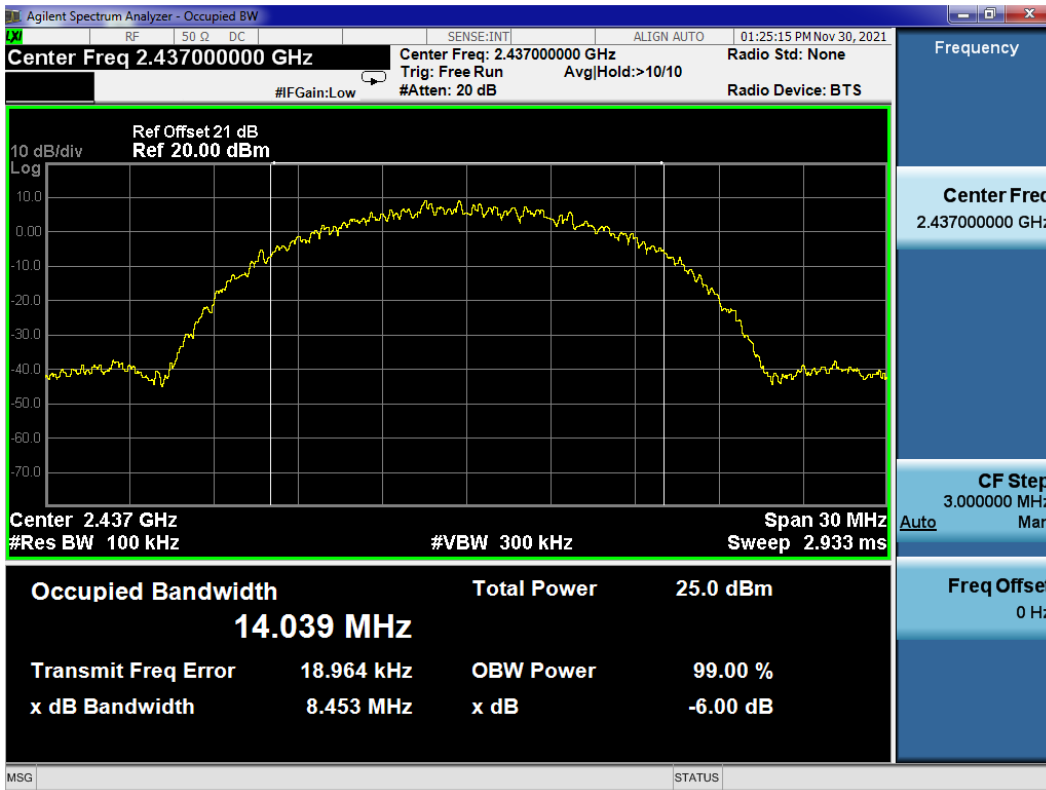

802.11b CH2462MHz

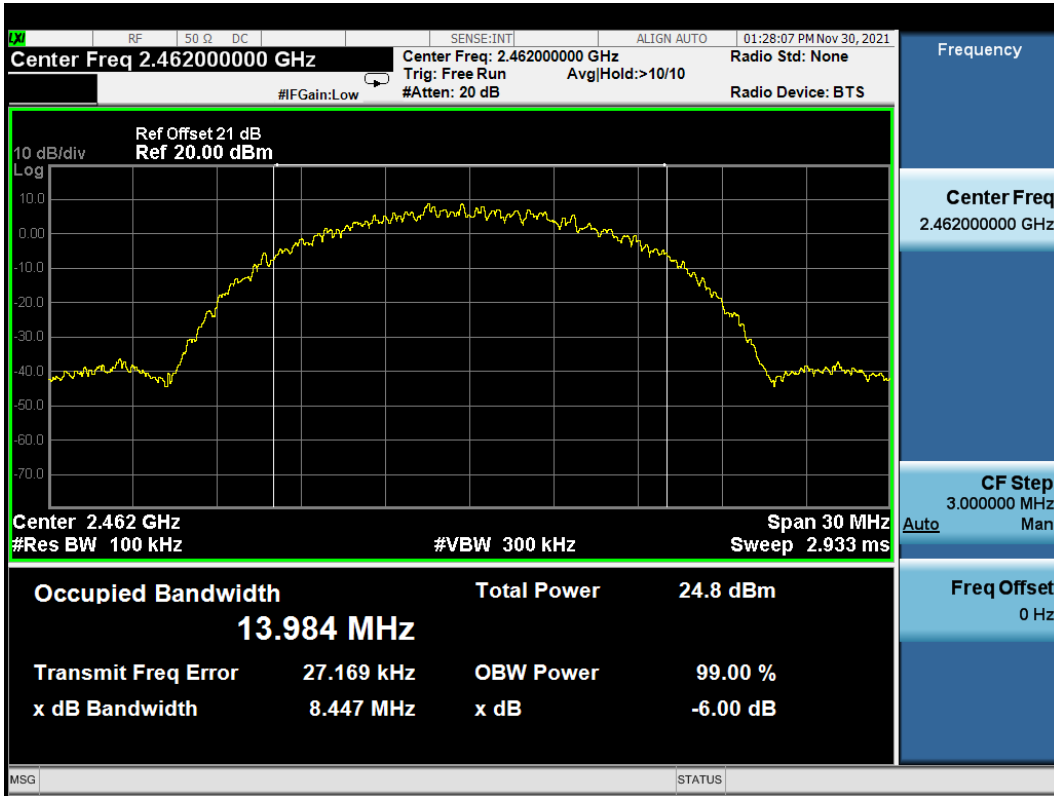

802.11g CH2412MHz

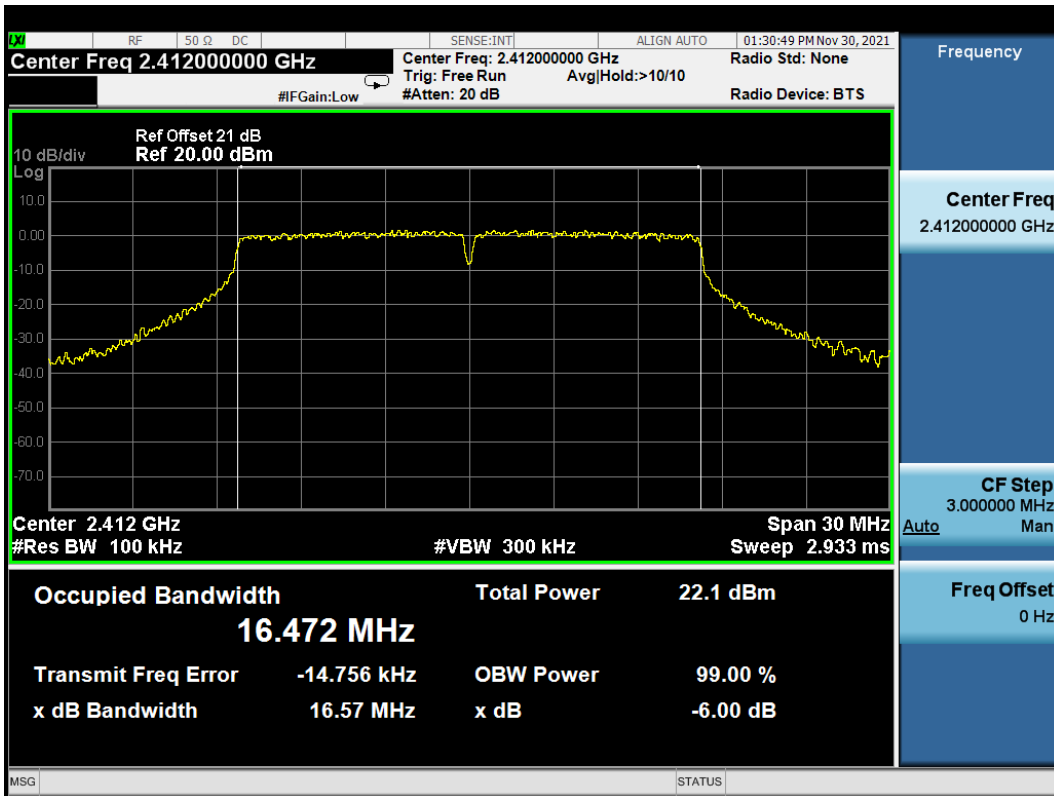

802.11g CH2437MHz

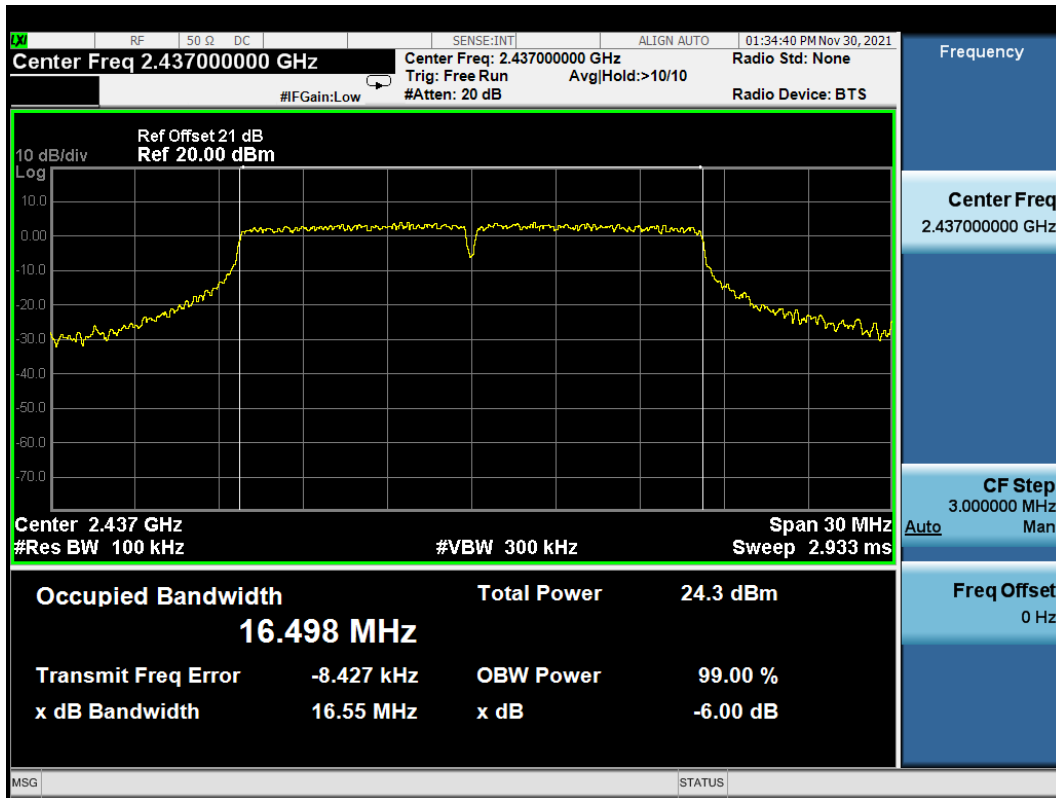

802.11g CH2462MHz

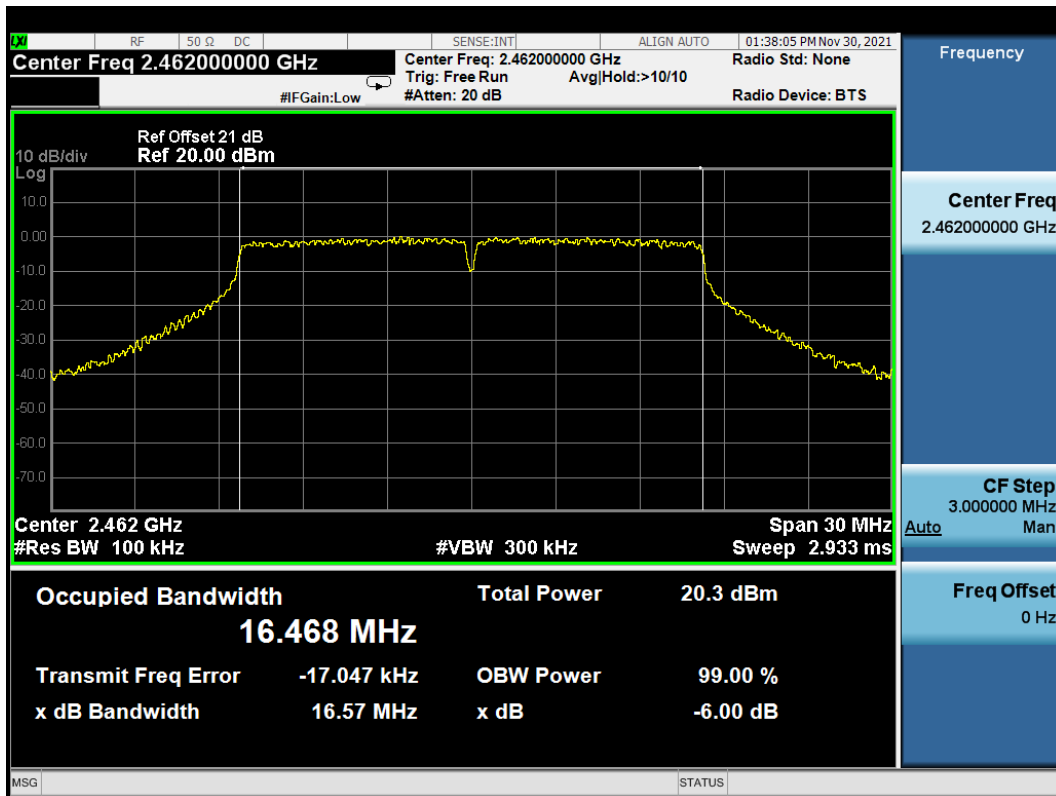

802.11n20 CH2412MHz

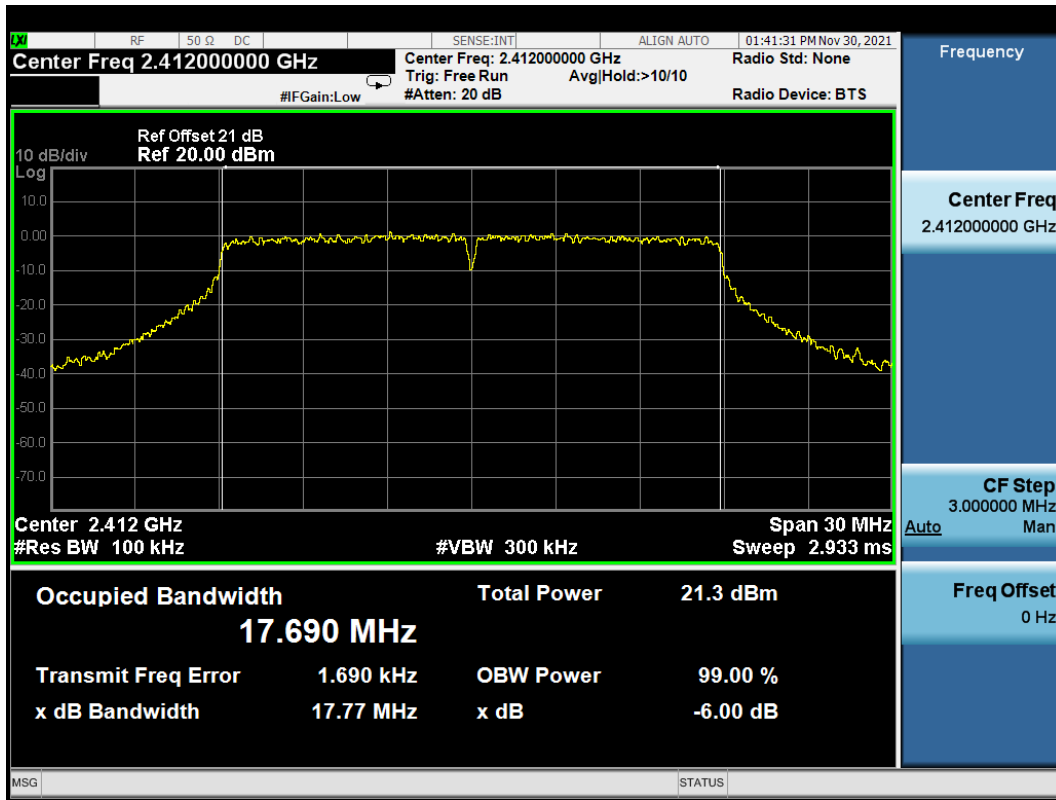

802.11n20 CH2437MHz

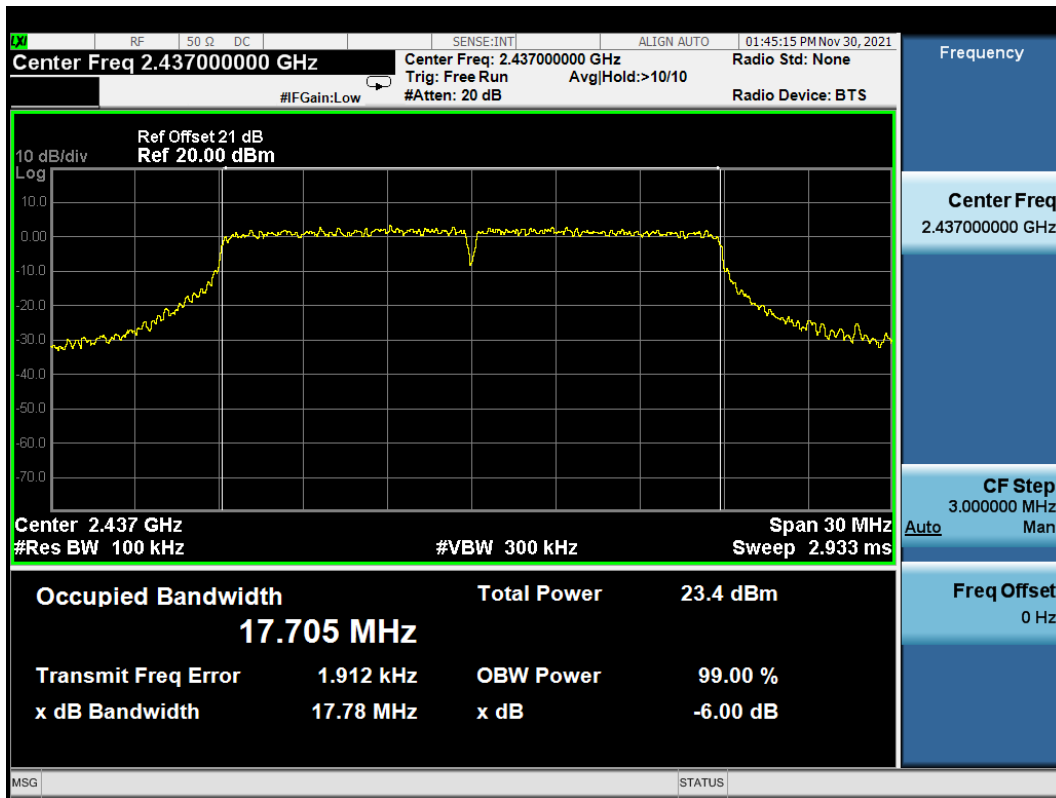

802.11n20 CH2462MHz

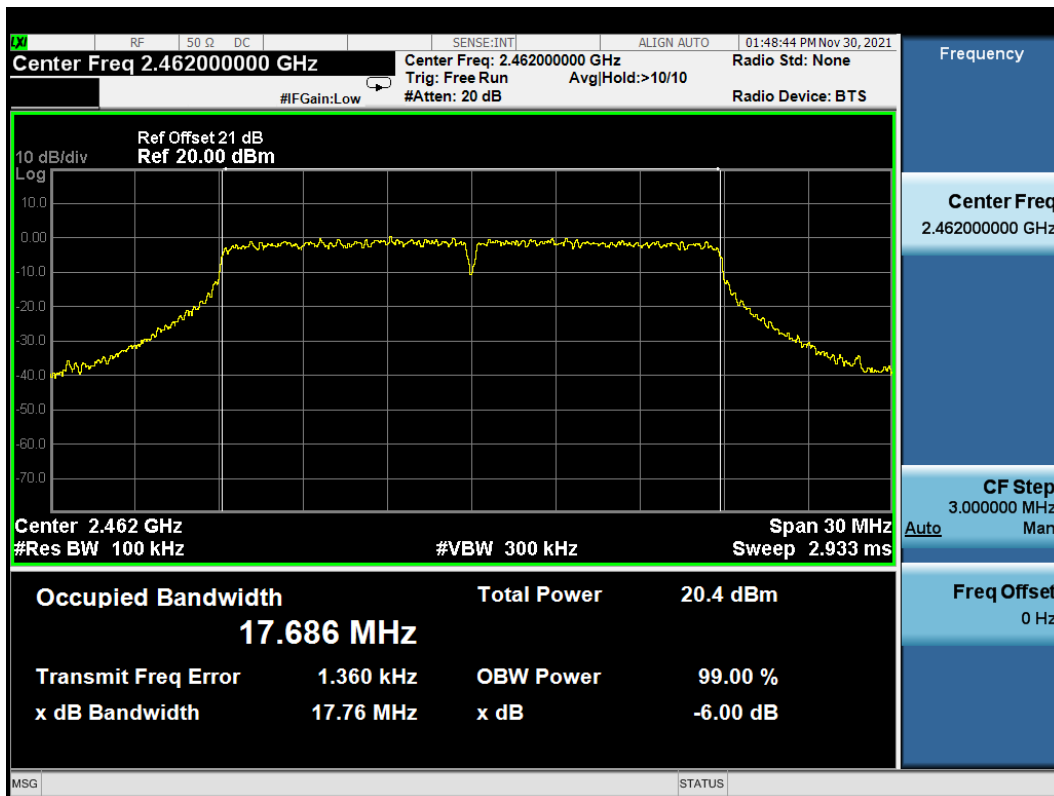

## 6 MAXIMUM PEAK OUTPUT POWER MEASUREMENT

### 6.1 Test Equipment

The following test equipment was used during the maximum peak output power measurement:

Item	Type	Manufacturer	Model No.	Serial No.	Cal. Date	Cal. Interval
1.	Spectrum Analyzer	Agilent	N9010A	MY52221182	2021.09.15	1 Year
2.	Coaxial Cable	WOKEN	SFL402-105F LEX	F02-150819-045	2021.03.08	1 Year
3.	20 dB Attenuator	Mini-Circuits	VAT-20+	001	2021.08.06	1 Year

### 6.2 Block Diagram of Test Setup

The Same as Section. 5.2.

### 6.3 Specification Limits ((§15.247(b)(3))

The Limits of maximum Peak Output Power for digital modulation in 2400-2483.5 MHz is: 1 Watt. (30 dBm)

### 6.4 Operating Condition of EUT

The switch ON/OFF was used to enable the EUT to change the channel one by one.

### 6.5 Test Procedure

The transmitter output was connected to the spectrum analyzer.

The following procedure can be used when the maximum available RBW of the instrument is less than the DTS bandwidth:

- a) Set the RBW = 1 MHz.
- b) Set the VBW  $\geq$  [3 RBW].
- c) Set the span  $\geq$  [1.5 DTS bandwidth].
- d) Detector = peak.
- e) Sweep time = auto couple.
- f) Trace mode = max hold.
- g) Allow trace to fully stabilize.
- h) Use the instrument's band/channel power measurement function with the band limits set equal to the DTS bandwidth edges (for some instruments, this may require a manual override to select the peak detector). If the instrument does not have a band power function, then sum the spectrum levels (in linear power units) at intervals equal to the RBW extending across the DTS channel bandwidth

The test procedure is defined in ANSI C63.10-2013 ( 11.9.1.2 Measurement Procedure “ Integrated band power method” was used).

## 6.6 Test Results

**PASSED.**

All the test results are listed below.

(Test Date: 2022.01.07 Temperature: 23°C Humidity: 51 %)

Modulation	Channel	Frequency (MHz)	Peak Output Power (dBm)	Limit
802.11b	1	2412	<b>23.83</b>	30 dBm
	6	2437	<b>23.38</b>	30 dBm
	11	2462	<b>23.31</b>	30 dBm
802.11g	1	2412	<b>23.44</b>	30 dBm
	6	2437	<b>25.37</b>	30 dBm
	11	2462	<b>21.68</b>	30 dBm
802.11n20	1	2412	<b>22.62</b>	30 dBm
	6	2437	<b>24.73</b>	30 dBm
	11	2462	<b>21.88</b>	30 dBm



### 802.11b CH2412MHz

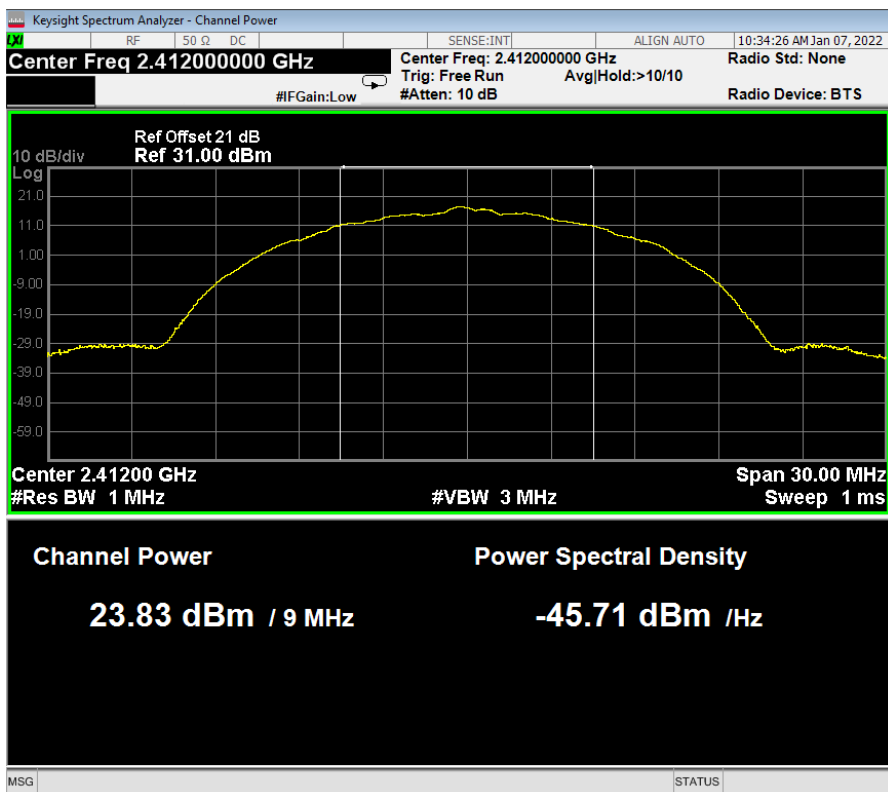

### 802.11b CH2437MHz

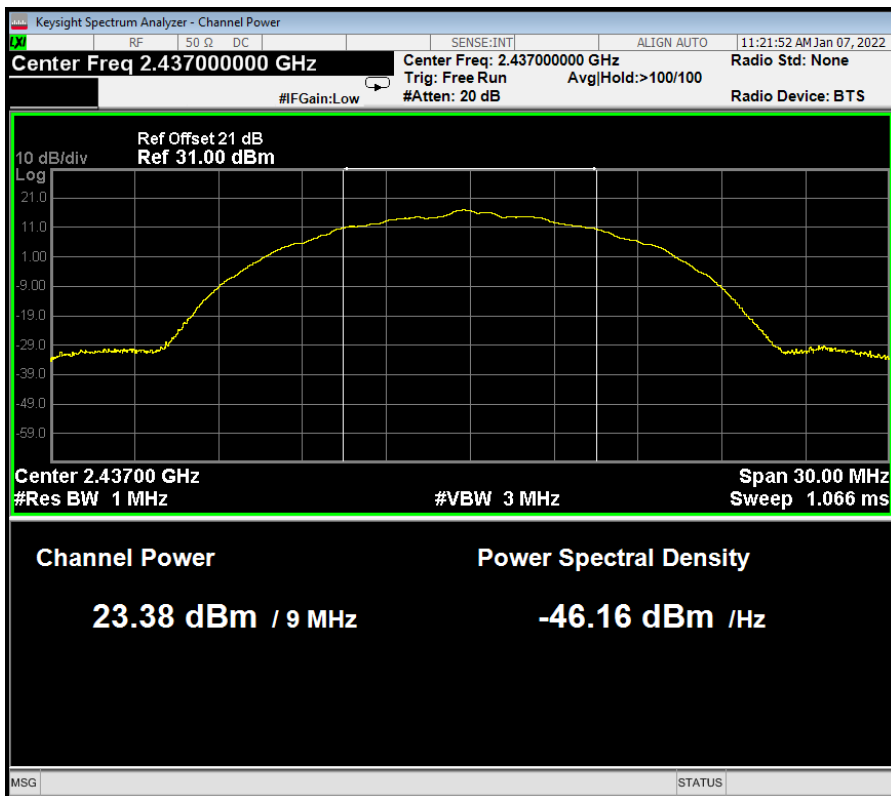

### 802.11b CH2462MHz

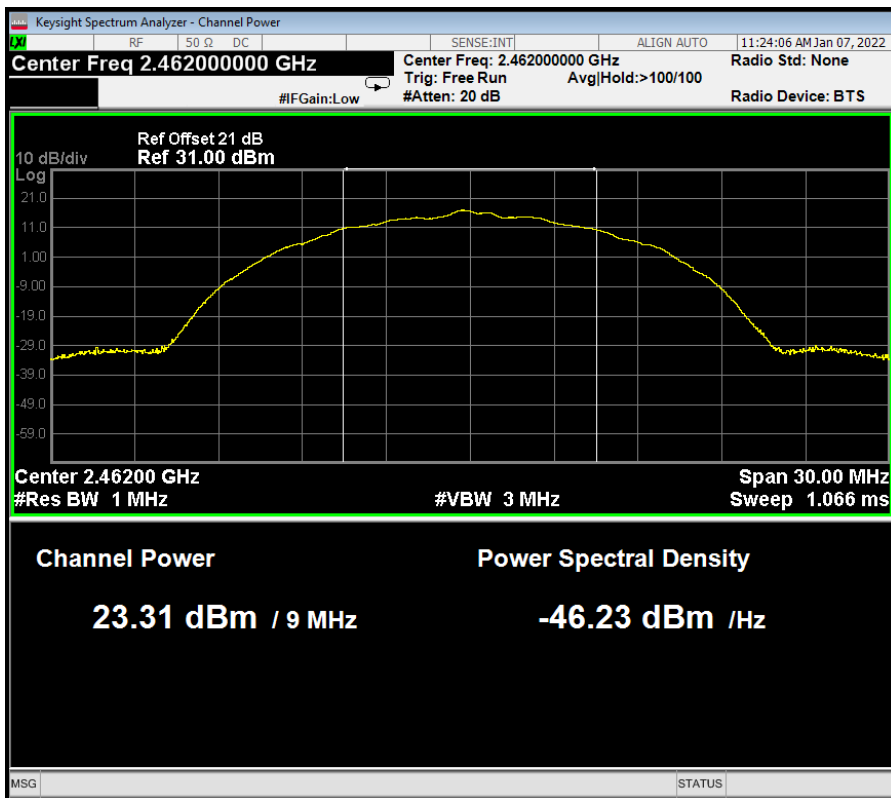

### 802.11g CH2412MHz

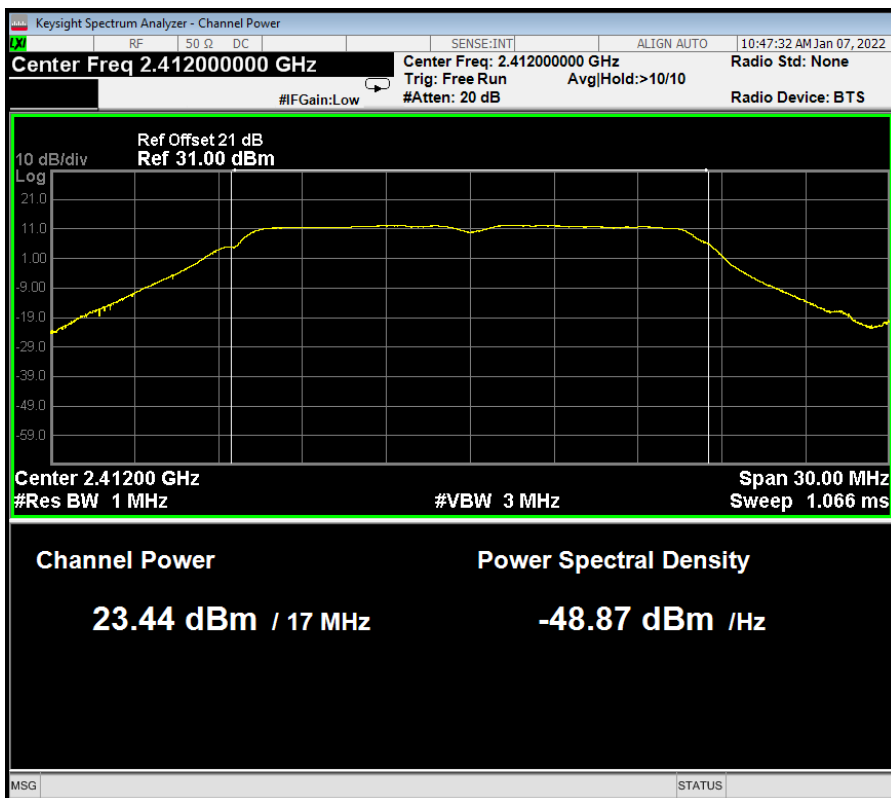

### 802.11g CH2437MHz

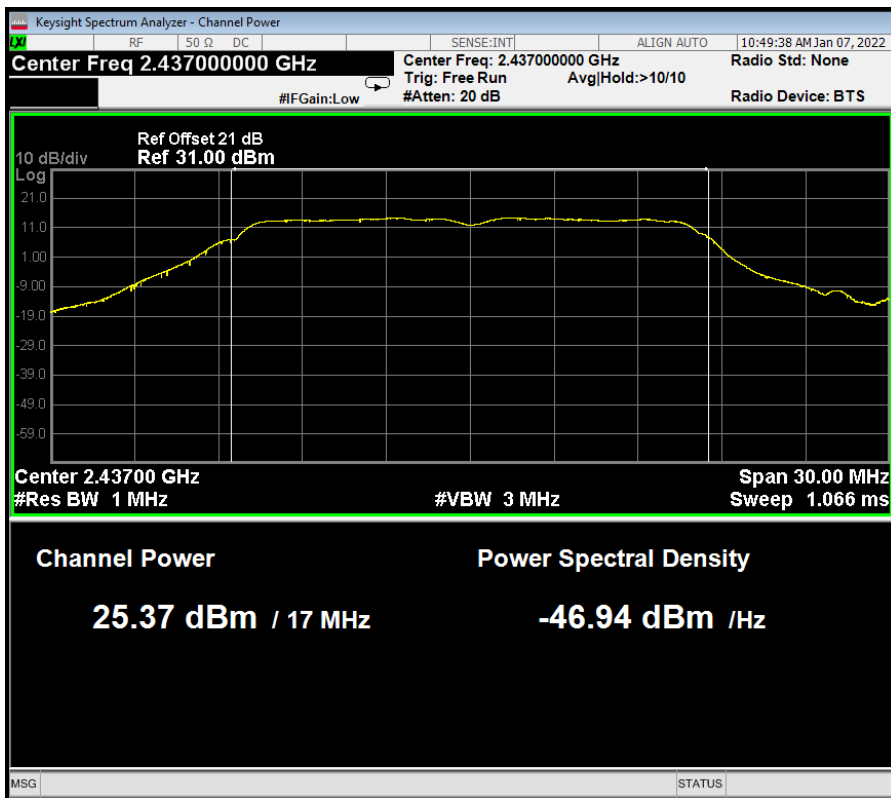

### 802.11g CH2462MHz

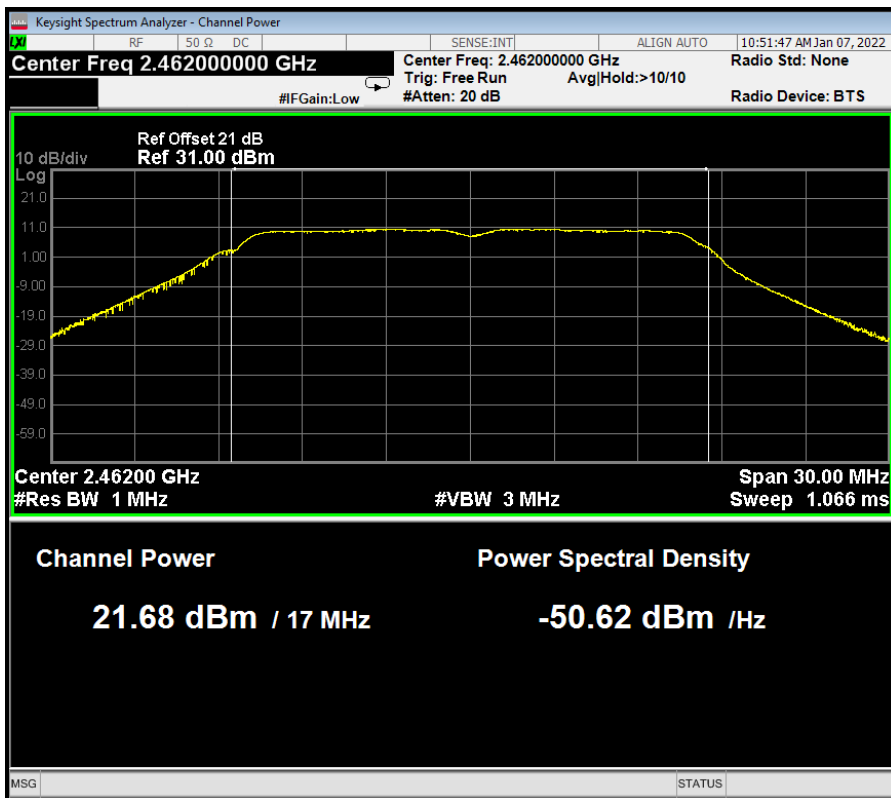

### 802.11n20 CH2412MHz

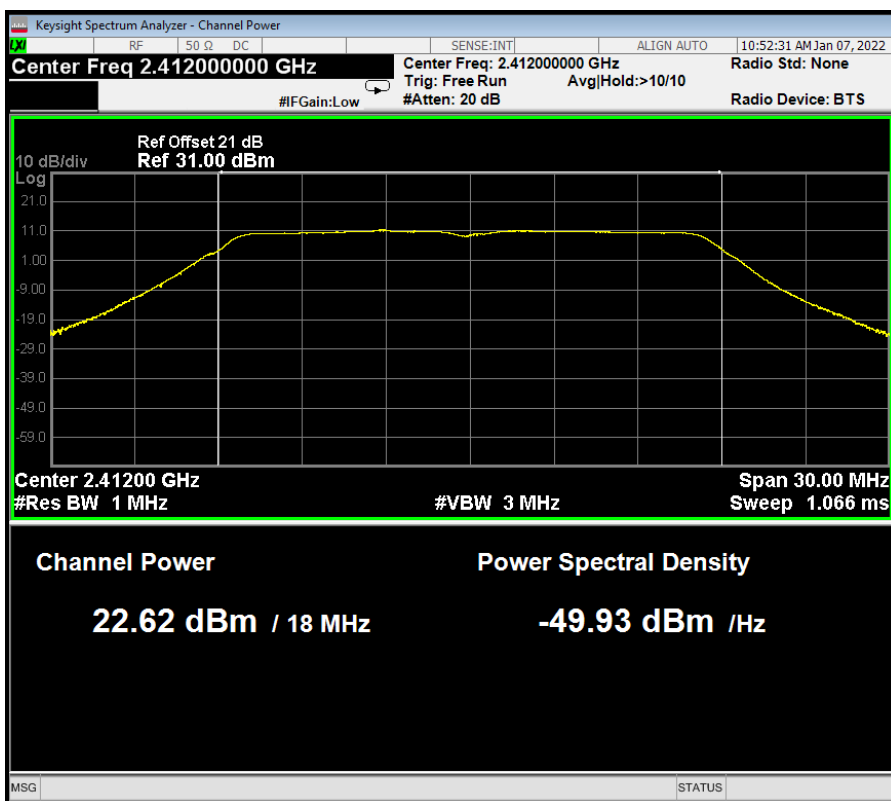

### 802.11n20 CH2437MHz

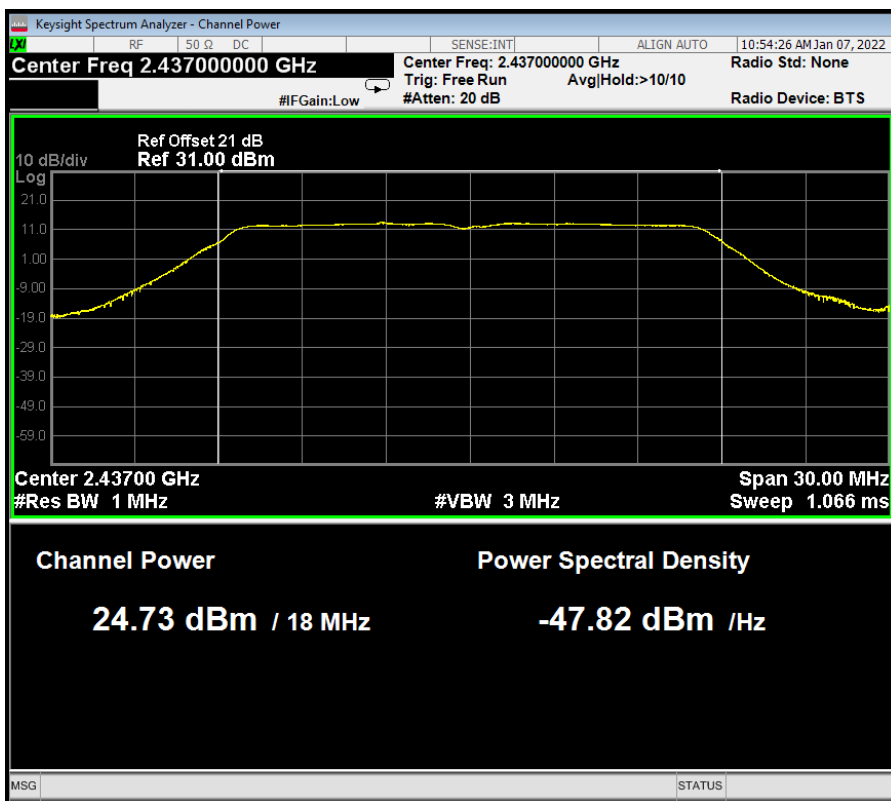

### 802.11n20 CH2462MHz

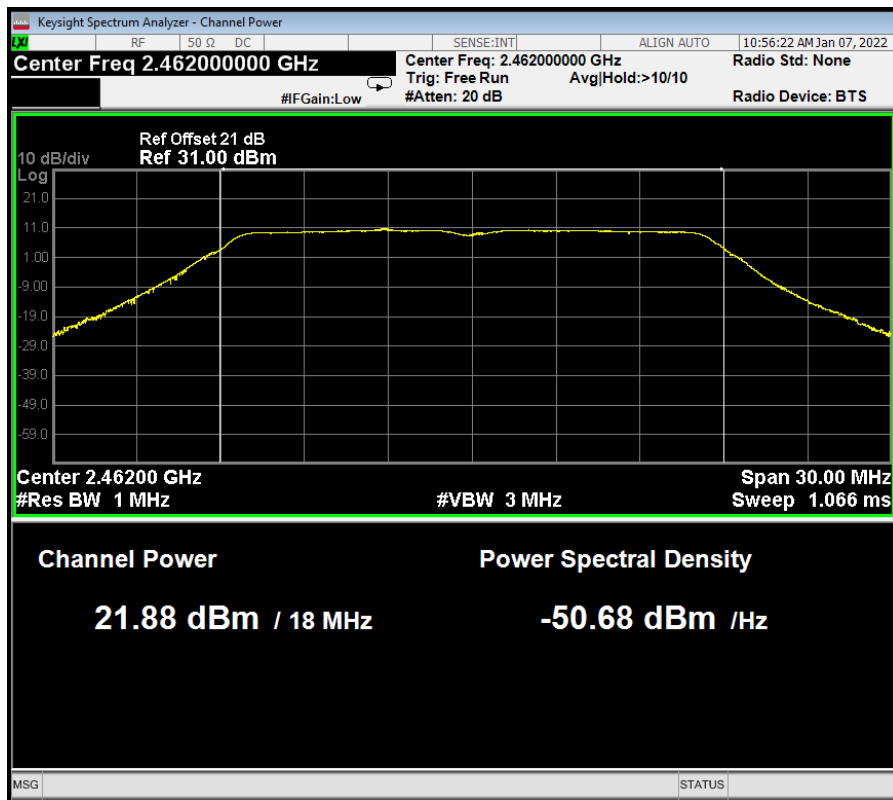

## 7 EMISSION LIMITATIONS MEASUREMENT

### 7.1 Test Equipment

The following test equipment was used during the emission limitations test:

Item	Type	Manufacturer	Model No.	Serial No.	Cal. Date	Cal. Interval
1.	Spectrum Analyzer	Agilent	N9010A	MY52221182	2021.09.15	1 Year
2.	Coaxial Cable	WOKEN	SFL402-105F LEX	F02-150819-045	2021.03.08	1 Year
3.	20 dB Attenuator	Mini-Circuits	VAT-20+	001	2021.08.06	1 Year

### 7.2 Block Diagram of Test Setup

The Same as Section. 5.2.

### 7.3 Specification Limits (§15.247(d))

In any 100 kHz bandwidth outside the frequency band in which the spread spectrum or digitally modulated intentional radiator is operating, the radio frequency power that is produced by the intentional radiator shall be at least 20 dB below that in the 100 kHz bandwidth within the band that contains the highest level of the desired power, based on either an RF conducted or a radiated measurement, provided the transmitter demonstrates compliance with the peak conducted power limits. If the transmitter complies with the conducted power limits based on the use of RMS averaging over a time interval, as permitted under paragraph (b)(3) of this section, the attenuation required under this paragraph shall be 30 dB instead of 20 dB. Attenuation below the general limits specified in §15.209(a) is not required.

In addition, radiated emissions which fall in the restricted bands, as defined in §15.205(a), must also comply with the radiated emission limits specified in §15.209(a) (see §15.205(c)). (※This test result attaching to Section. 3.7)

### 7.4 Operating Condition of EUT

The switch ON/OFF was used to enable the EUT to change the channel one by one.

### 7.5 Test Procedure

The transmitter output was connected to the spectrum analyzer.

Establish a reference level by using the following procedure:

- a) Set instrument center frequency to DTS channel center frequency.
- b) Set the span to  $\geq 1.5$  times the DTS bandwidth.
- c) Set the RBW = 100 kHz.
- d) Set the VBW  $\geq [3 \times \text{RBW}]$ .
- e) Detector = peak.
- f) Sweep time = auto couple.
- g) Trace mode = max hold.
- h) Allow trace to fully stabilize.
- i) Use the peak marker function to determine the maximum PSD level.

Note that the channel found to contain the maximum PSD level can be used to

establish the reference level.

Establish an emission level by using the following procedure:

- a) Set the center frequency and span to encompass frequency range to be measured.
- b) Set the RBW = 100 kHz.
- c) Set the VBW  $\geq [3 \times \text{RBW}]$ .
- d) Detector = peak.
- e) Sweep time = auto couple.
- f) Trace mode = max hold.
- g) Allow trace to fully stabilize.
- h) Use the peak marker function to determine the maximum amplitude level.

Ensure that the amplitude of all unwanted emissions outside of the authorized frequency band (excluding restricted frequency bands) is attenuated by at least the minimum requirements specified in 11.11. Report the three highest emissions relative to the limit.

Scan up through 10<sup>th</sup> harmonic.

The test procedure is defined in ANSI C63.10-2013 (11.11.2 Reference level measurement and 11.11.3 Emission level measurement was used).

## 7.6 Test Results

### **PASSED.**

The test data was attached in the next pages.

(Test Date: 2021.11.30-2022.01.15 Temperature: 23°C Humidity: 51 %)

Modulation	Channel	Frequency (MHz)	Data Page
802.11b	1	2412 MHz	P49-51
	6	2437 MHz	P52-53
	11	2462 MHz	P54-56
802.11g	1	2412 MHz	P57-59
	6	2437 MHz	P60-61
	11	2462 MHz	P62-64
802.11n20	1	2412 MHz	P65-67
	6	2437 MHz	P68-69
	11	2462 MHz	P70-72



802.11b CH2412MHz

Reference level

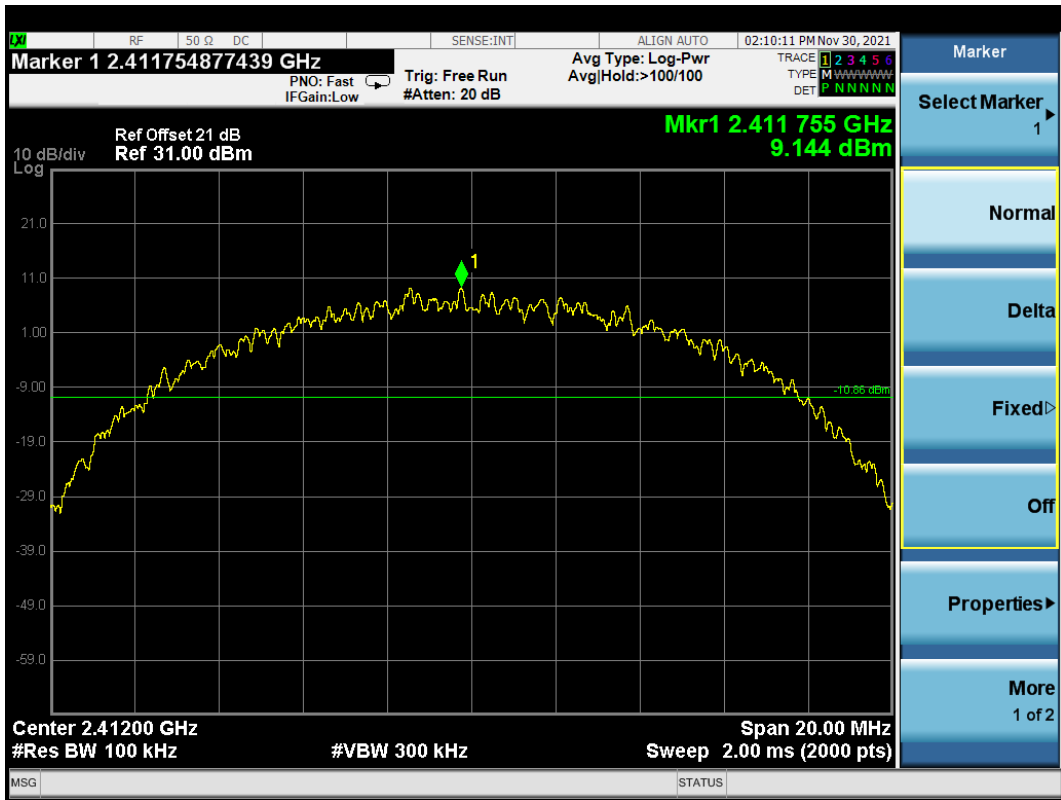

Emission level

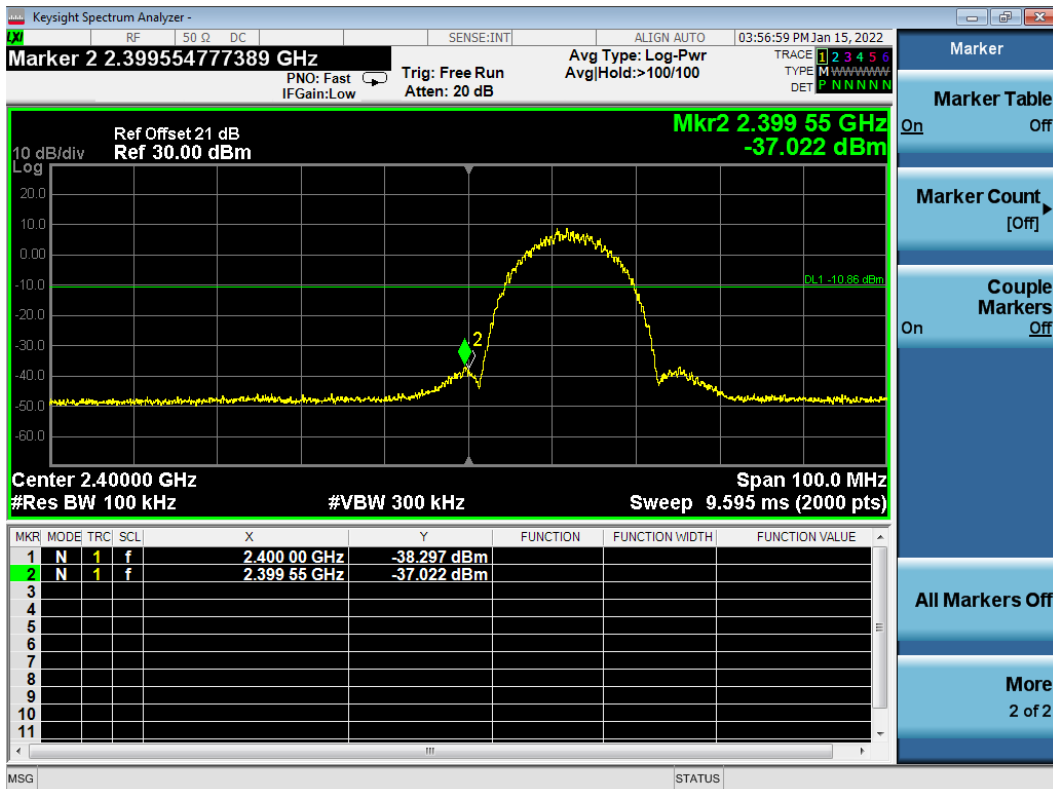

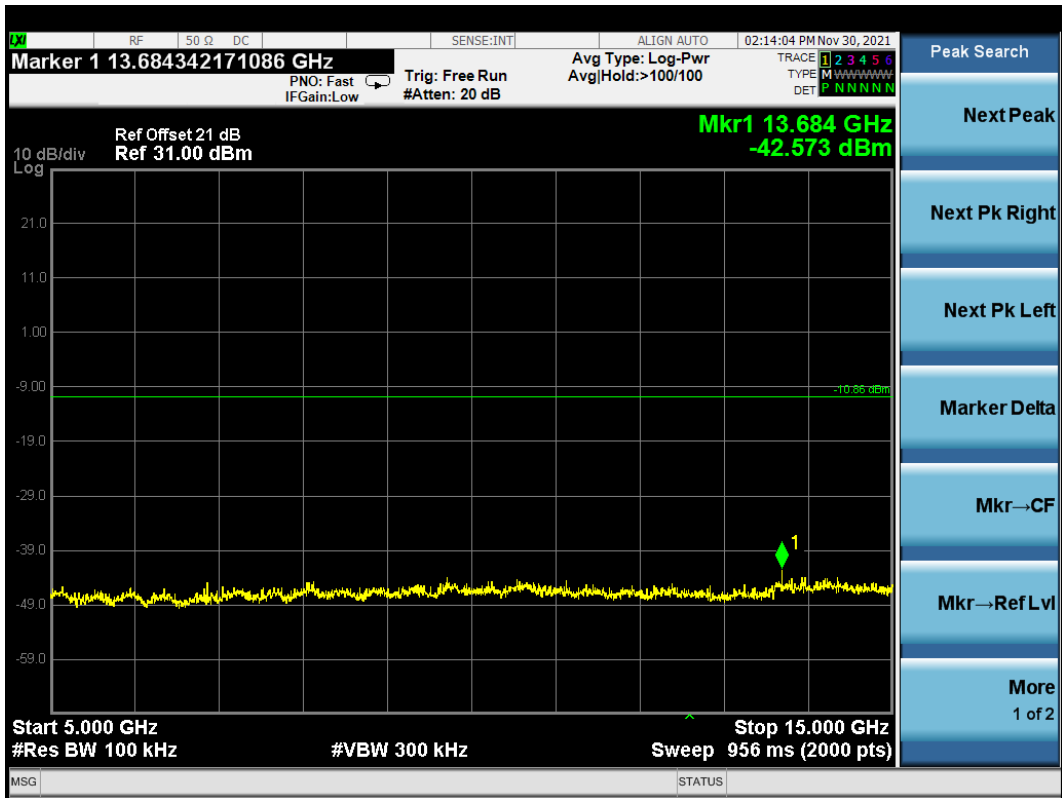
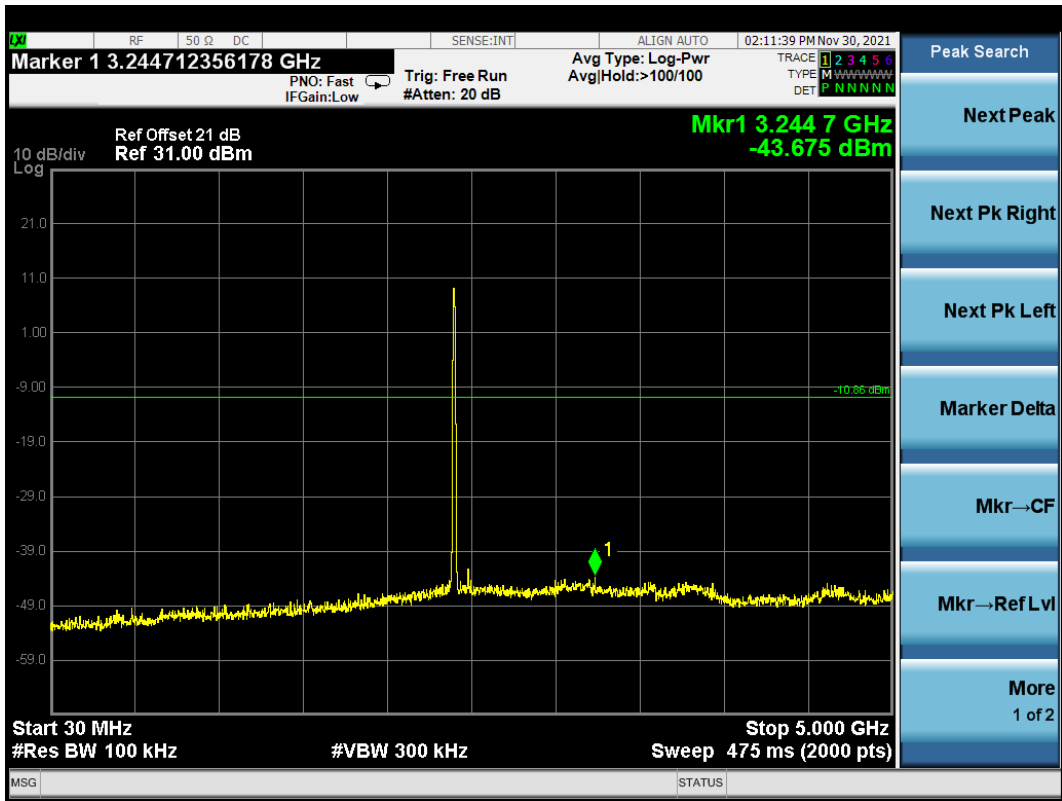

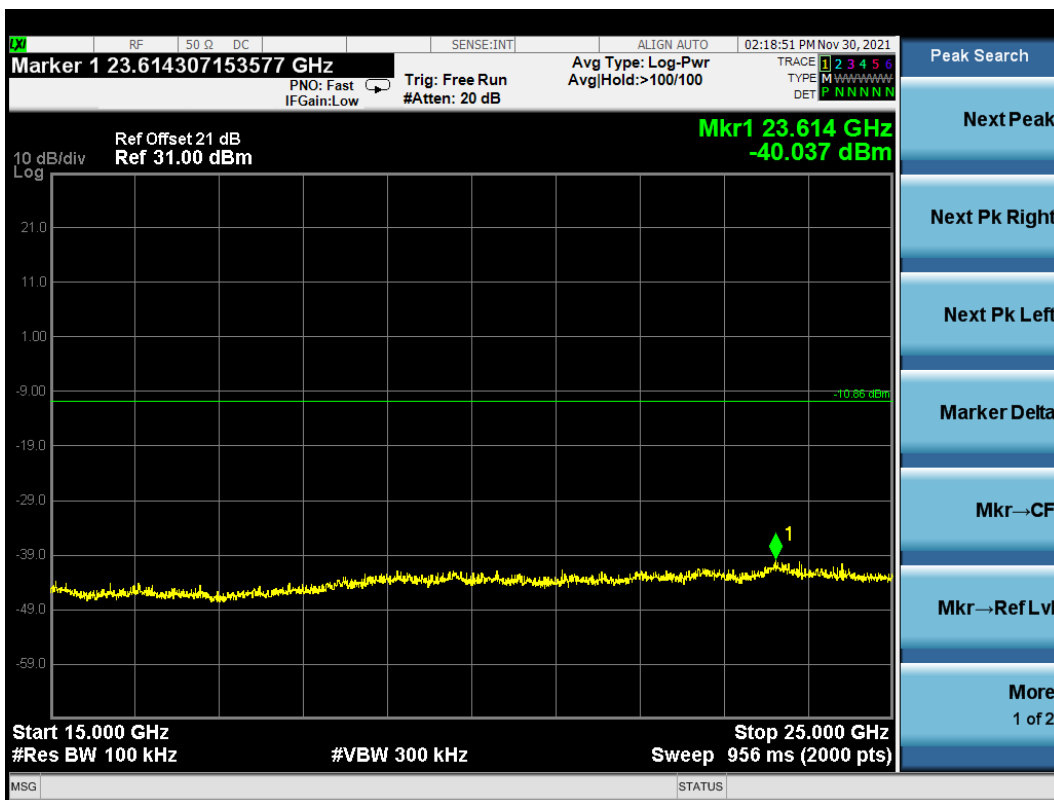

### 802.11b CH2437MHz

#### Reference level

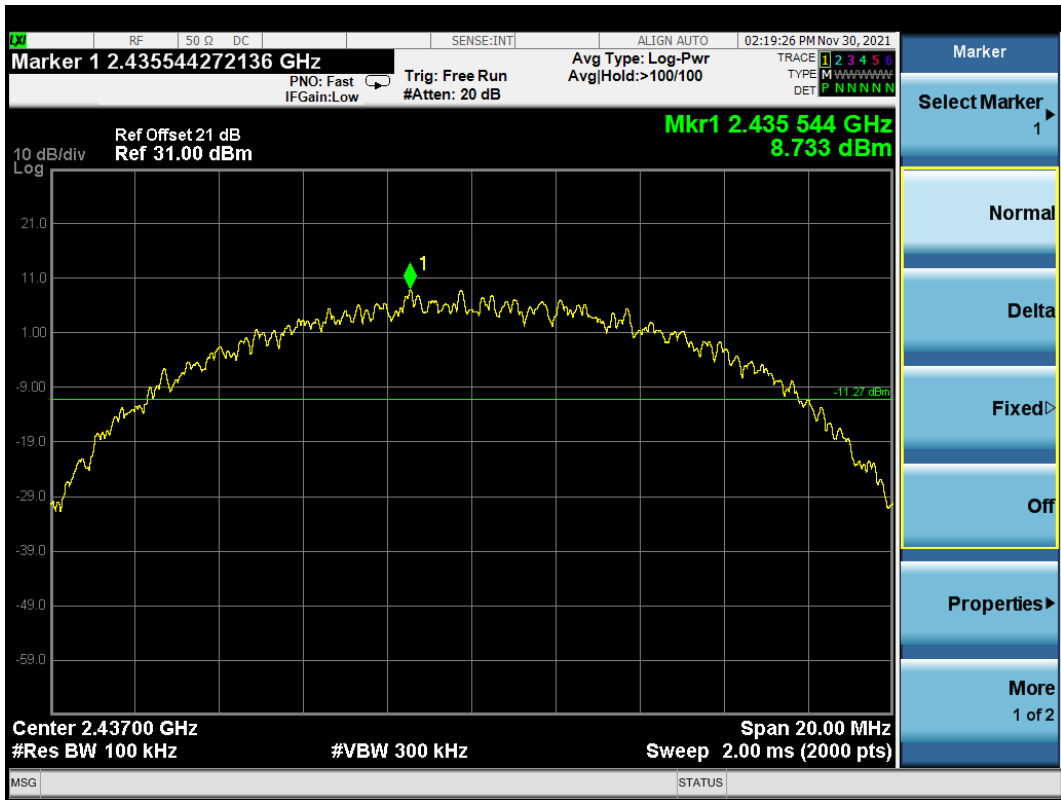

#### Emission level

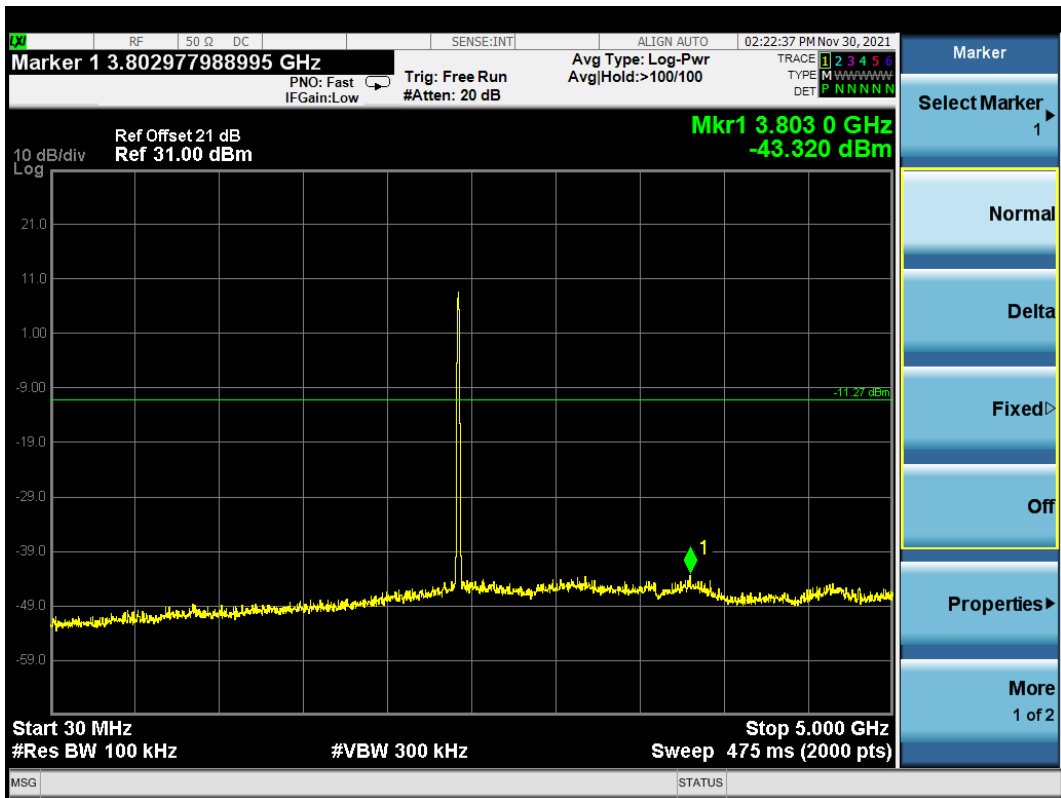



802.11b CH2462MHz

Reference level

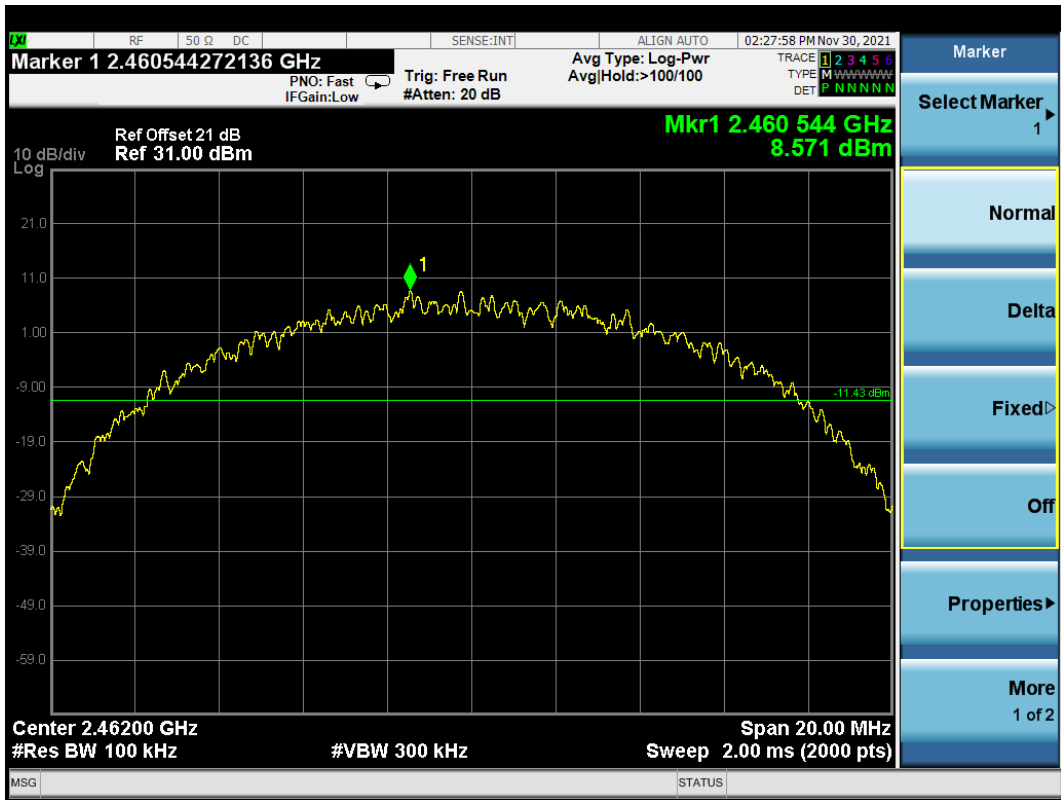

Emission level

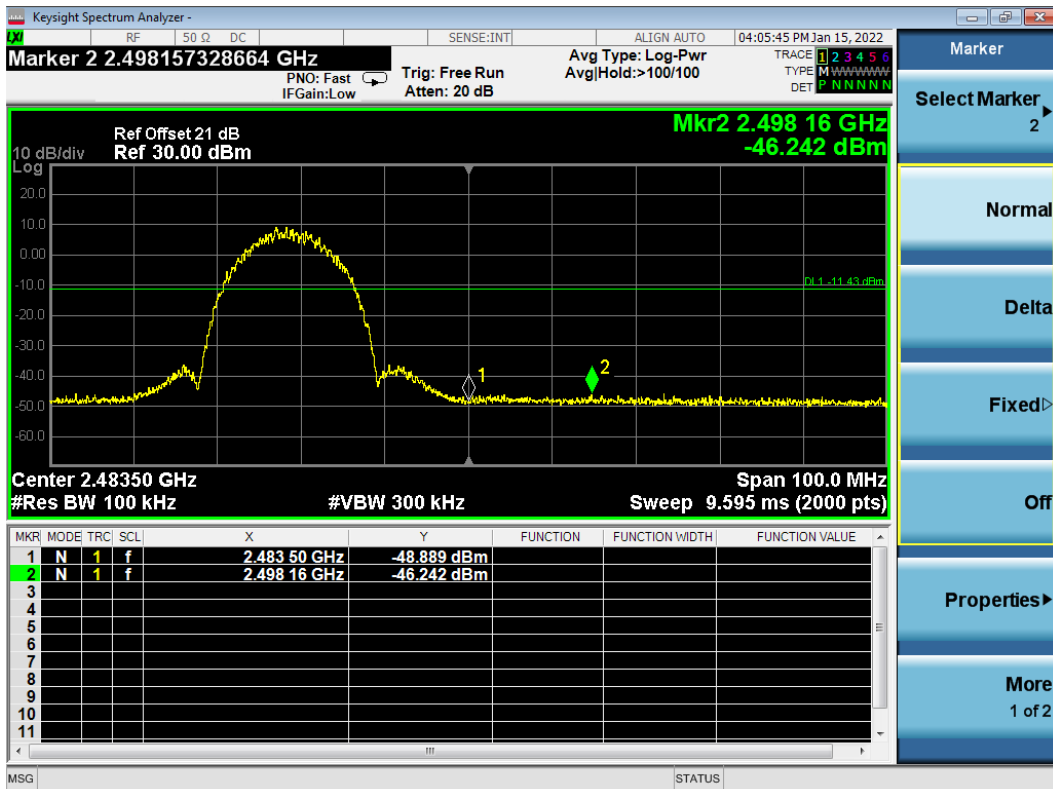

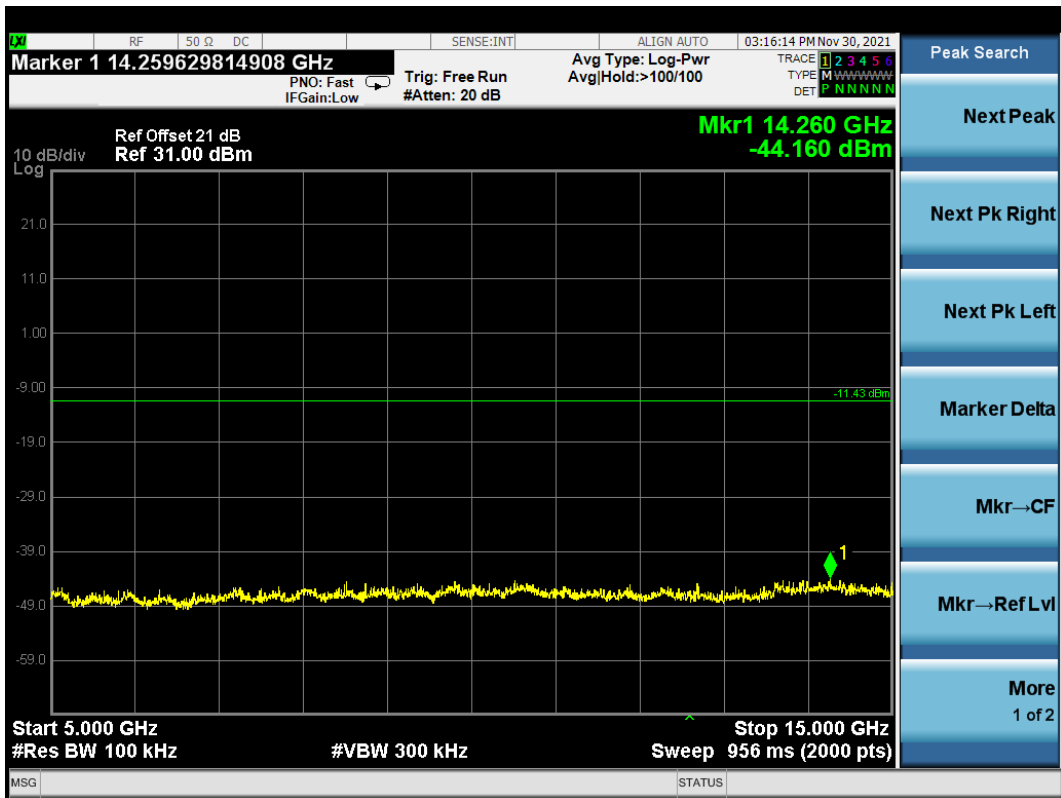
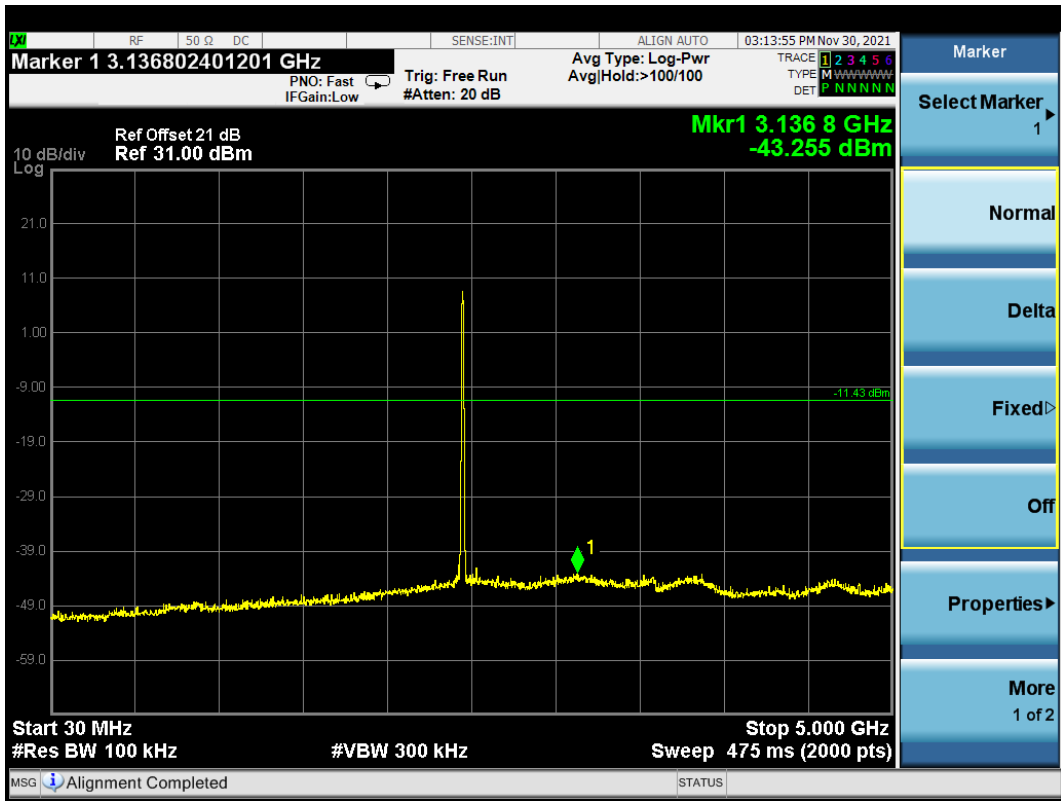

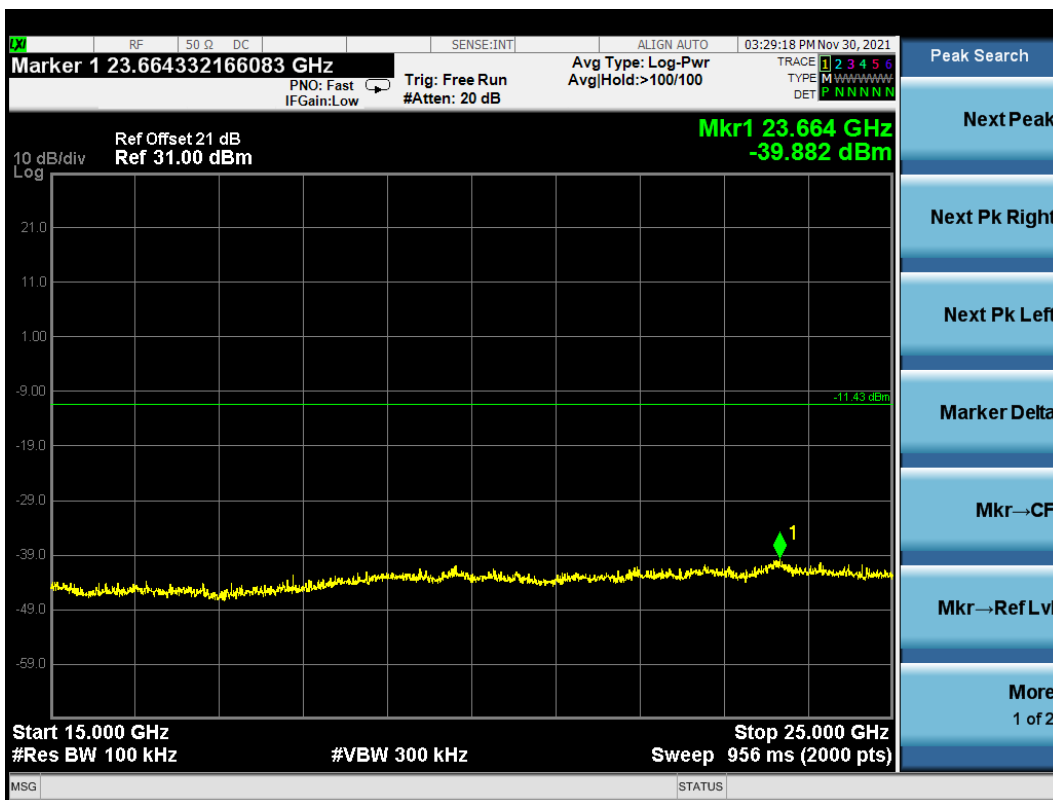



802.11g CH2412MHz

Reference level

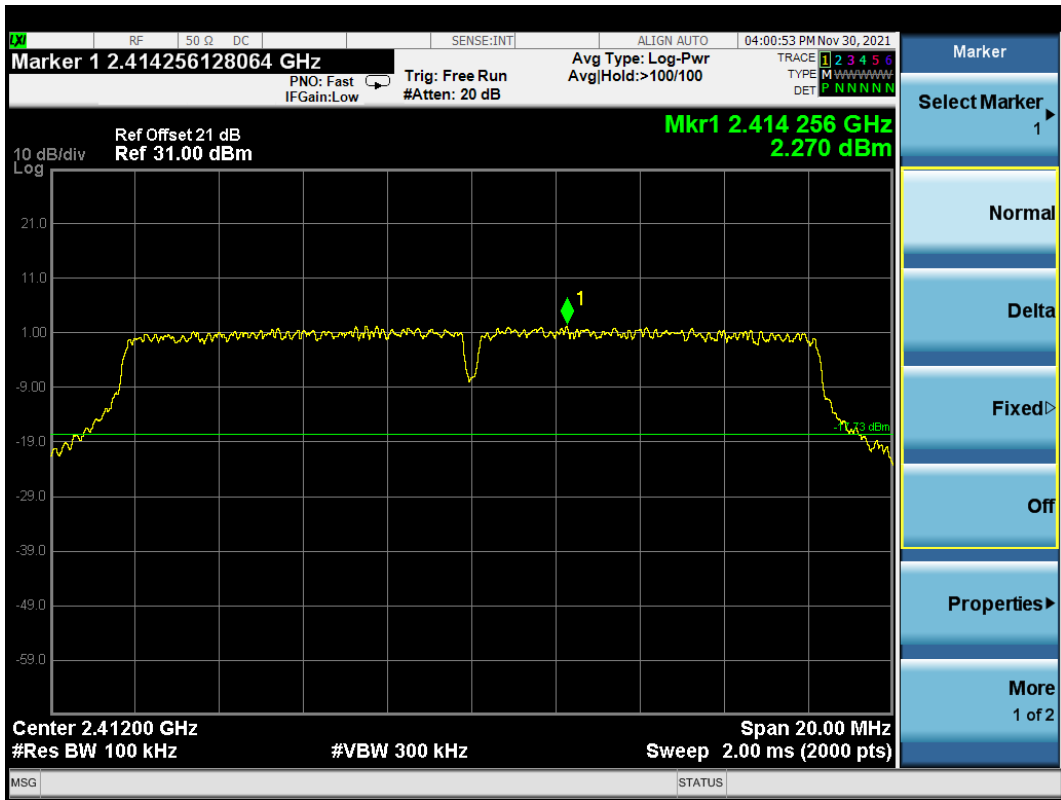

Emission level

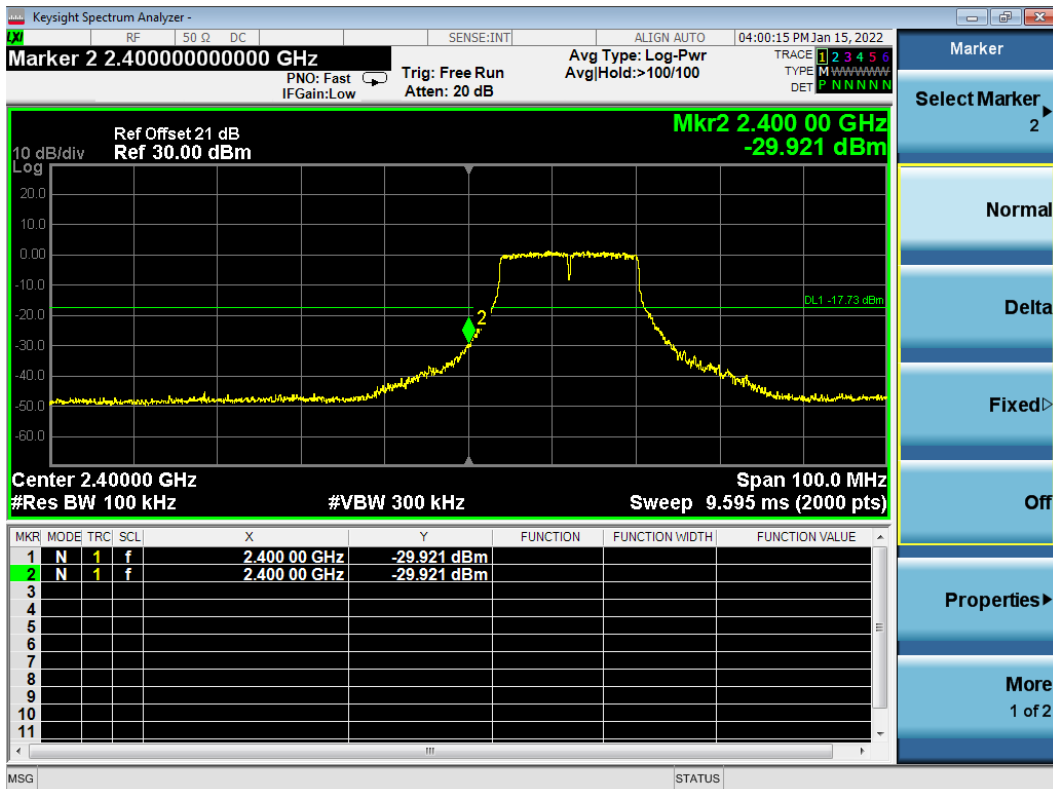

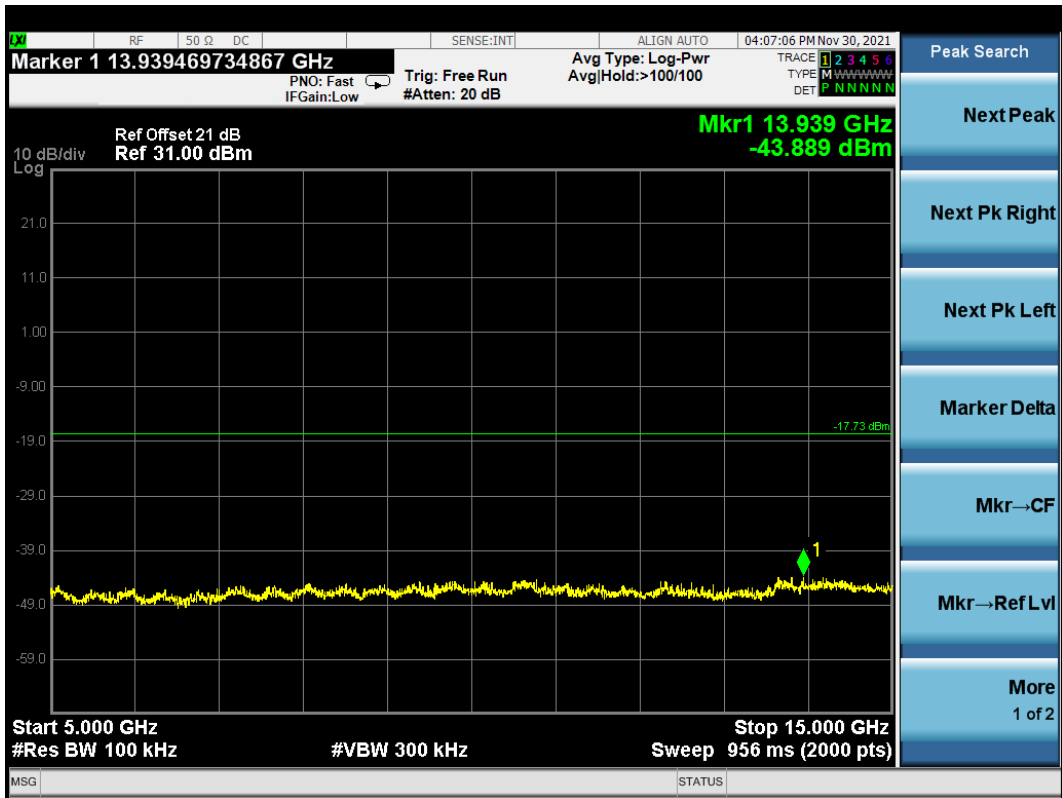
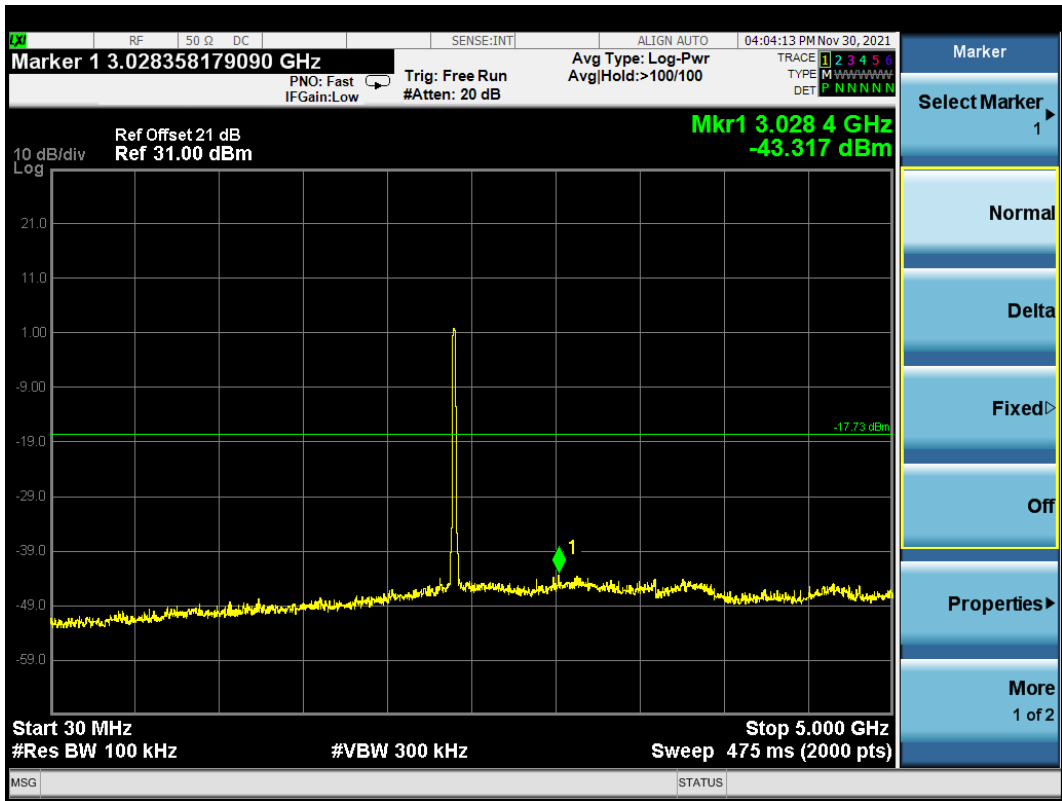



### 802.11g CH2437MHz

#### Reference level

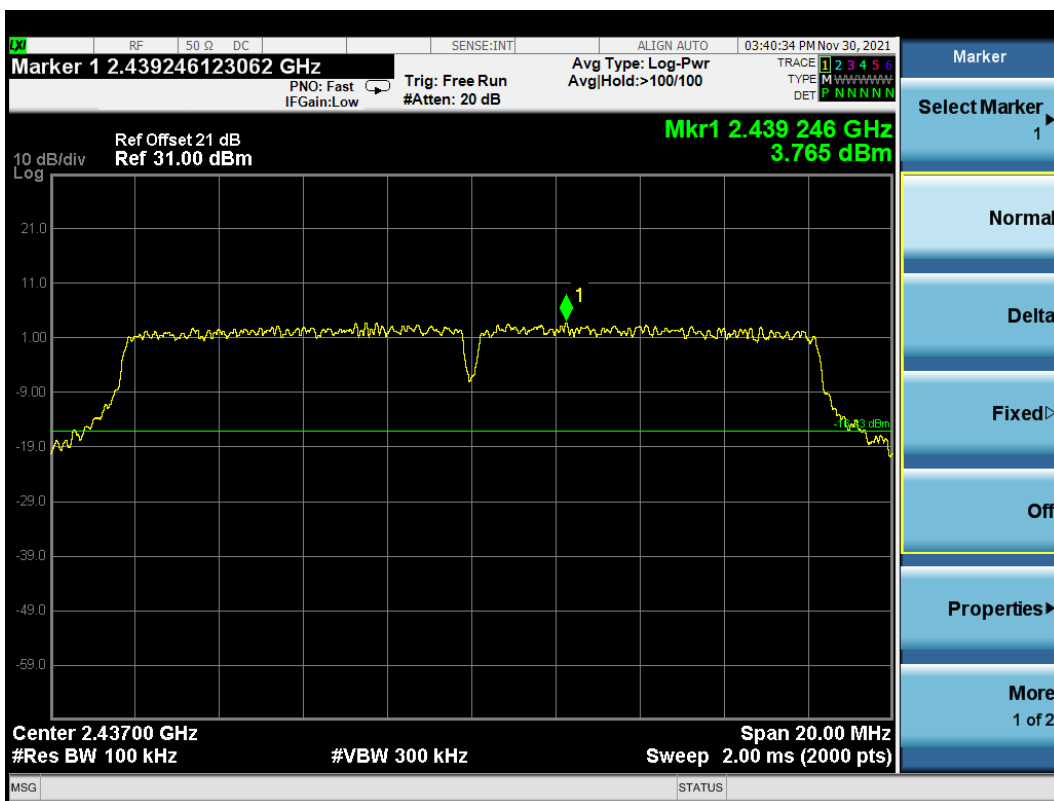

#### Emission level

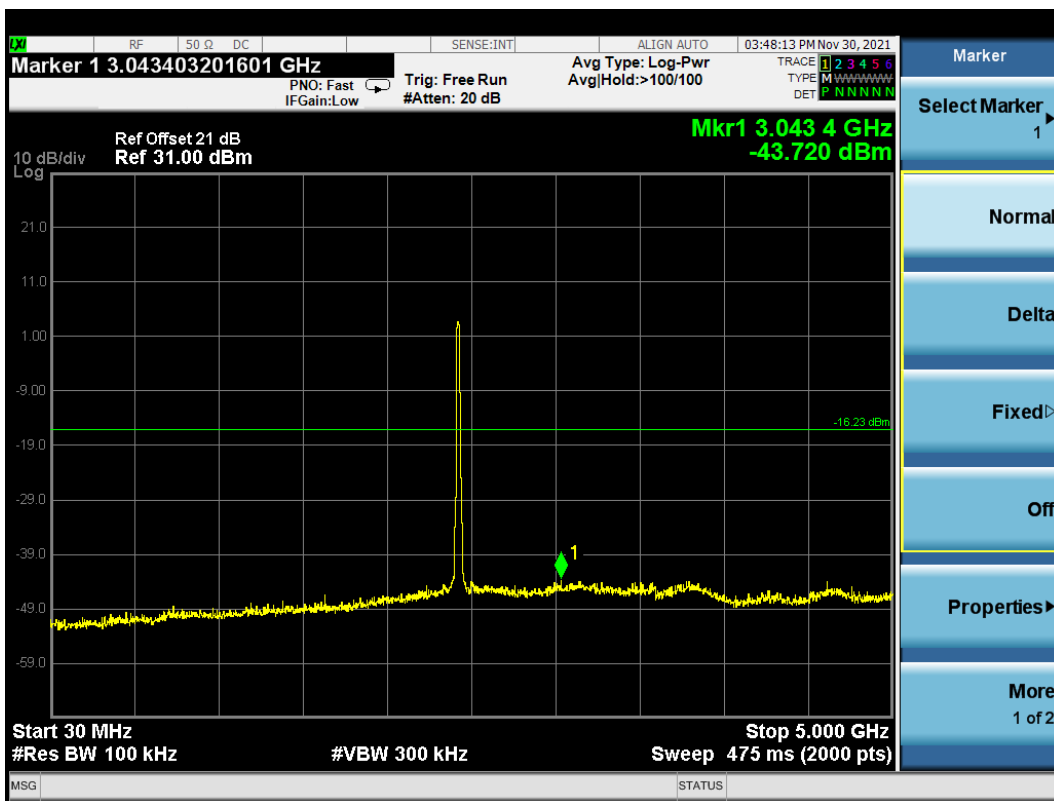

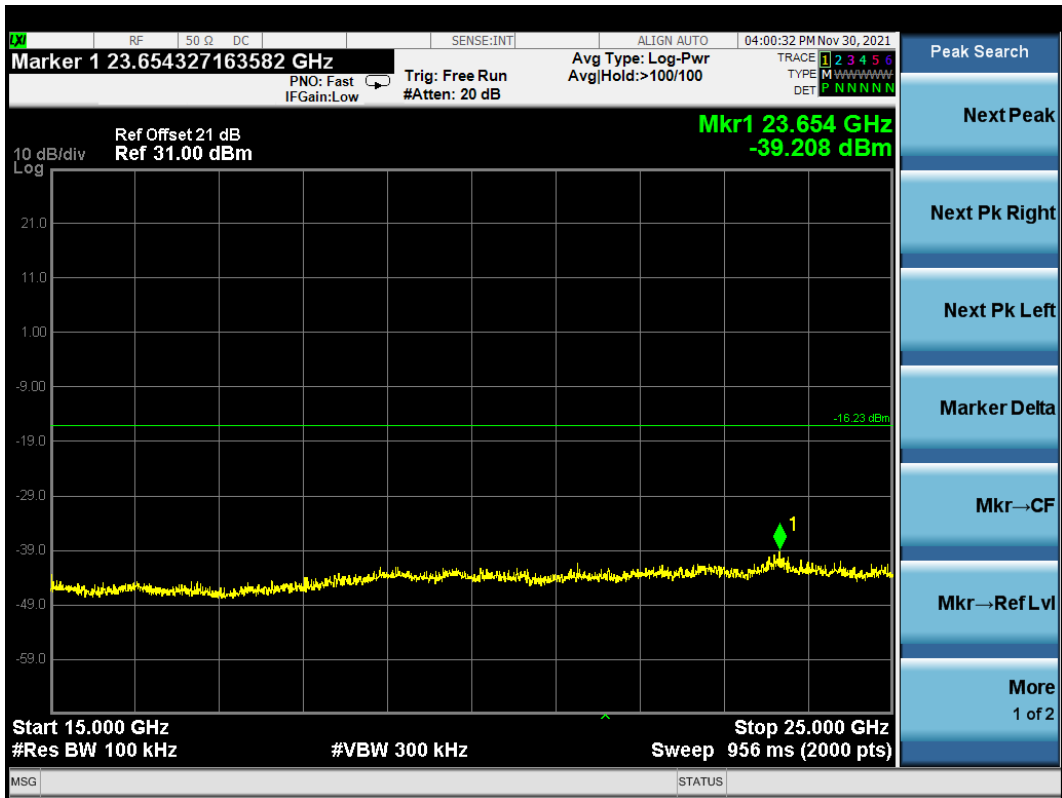
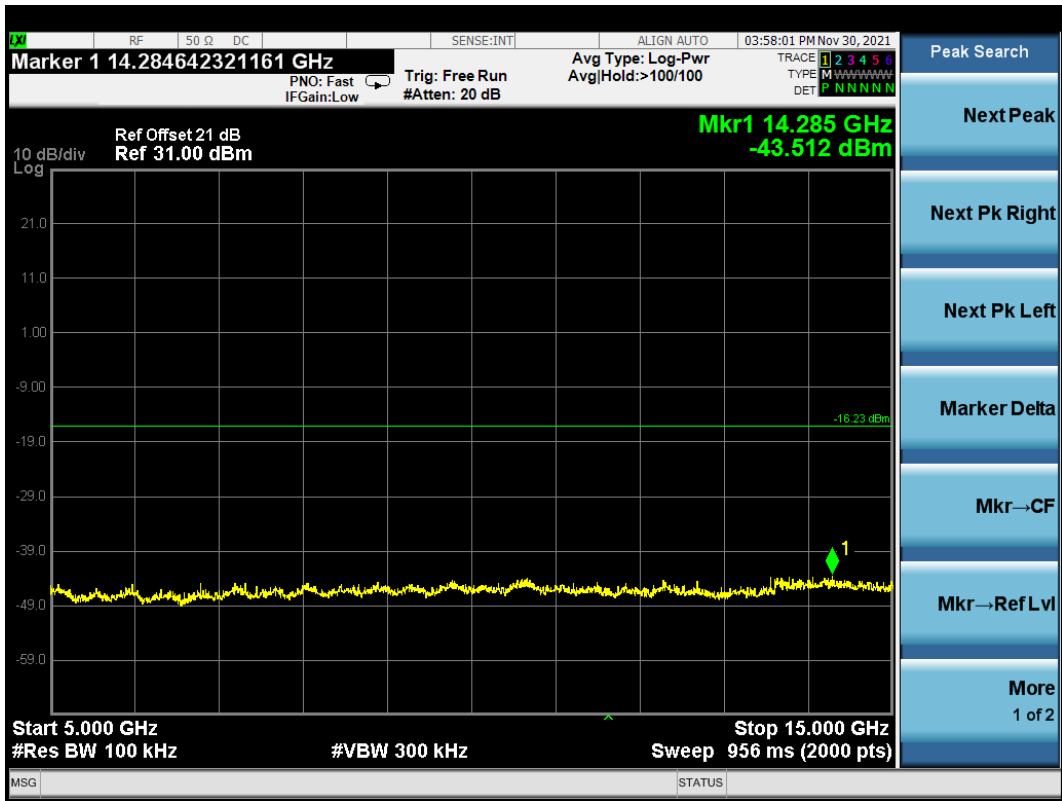

802.11g CH2462MHz

Reference level

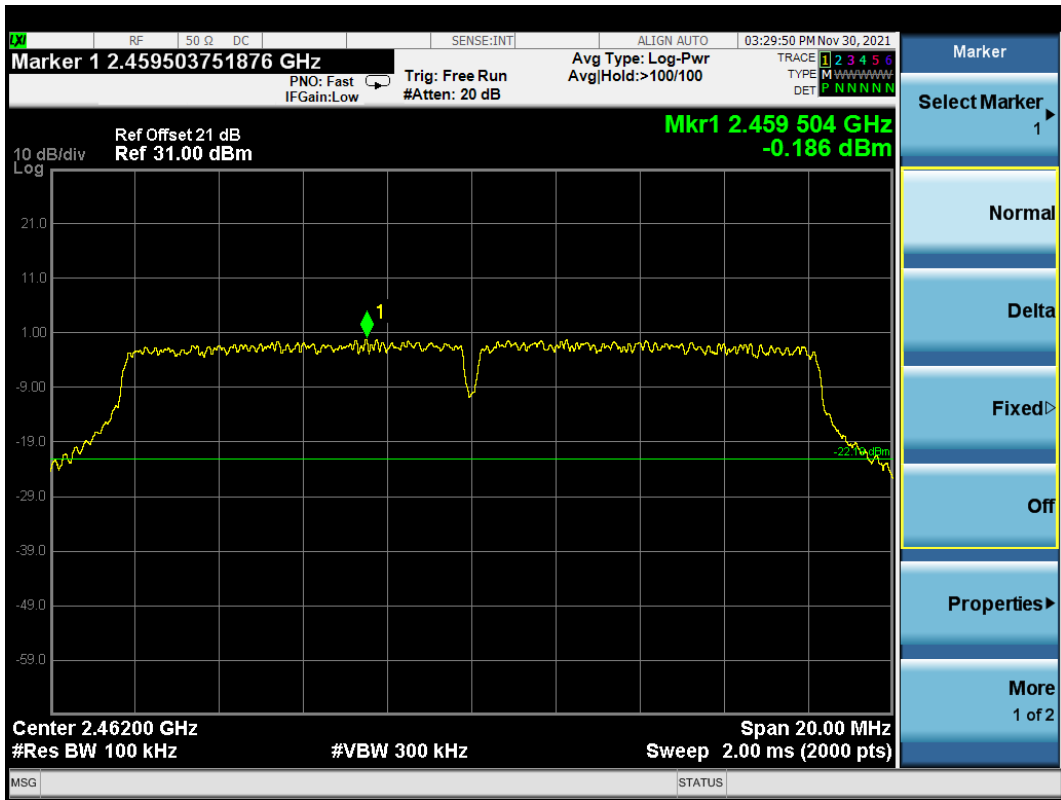

Emission level

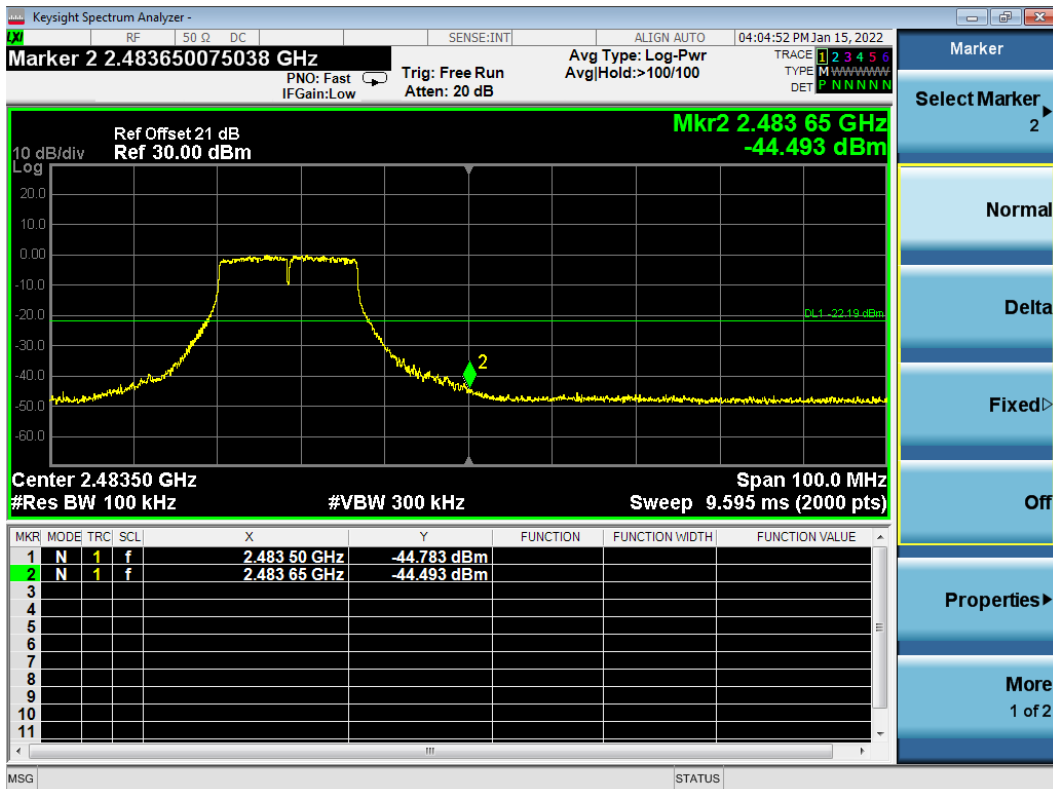

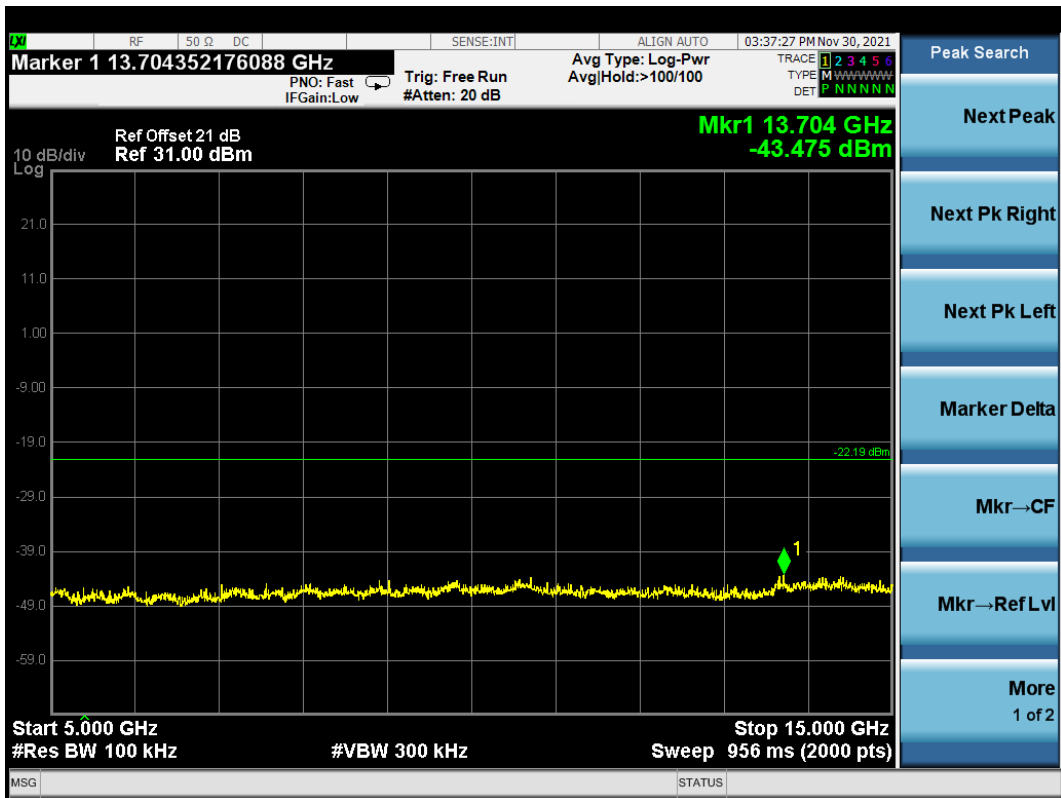
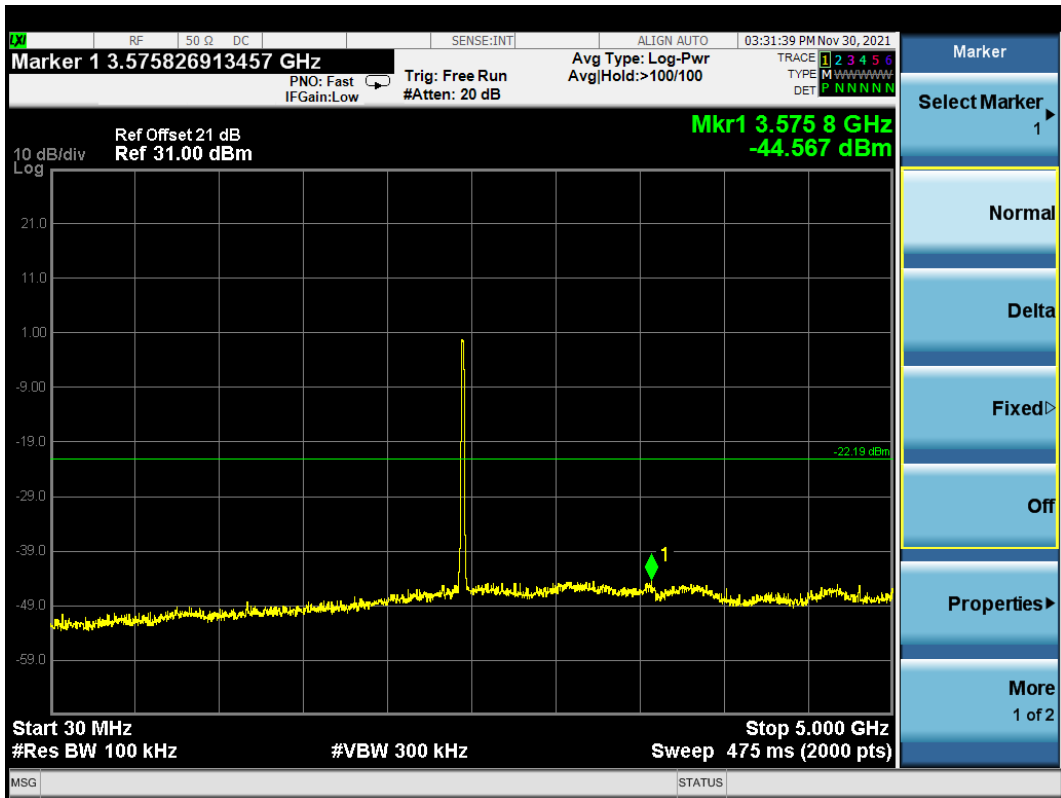

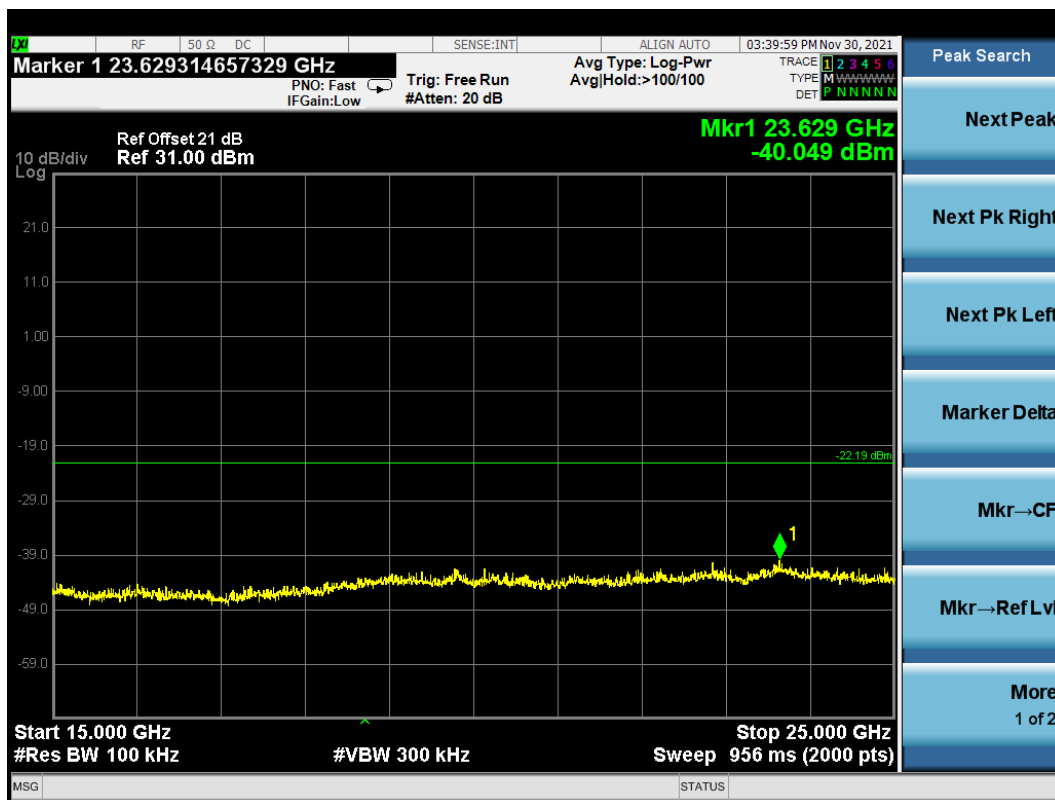



802.11n20 CH2412MHz

Reference level

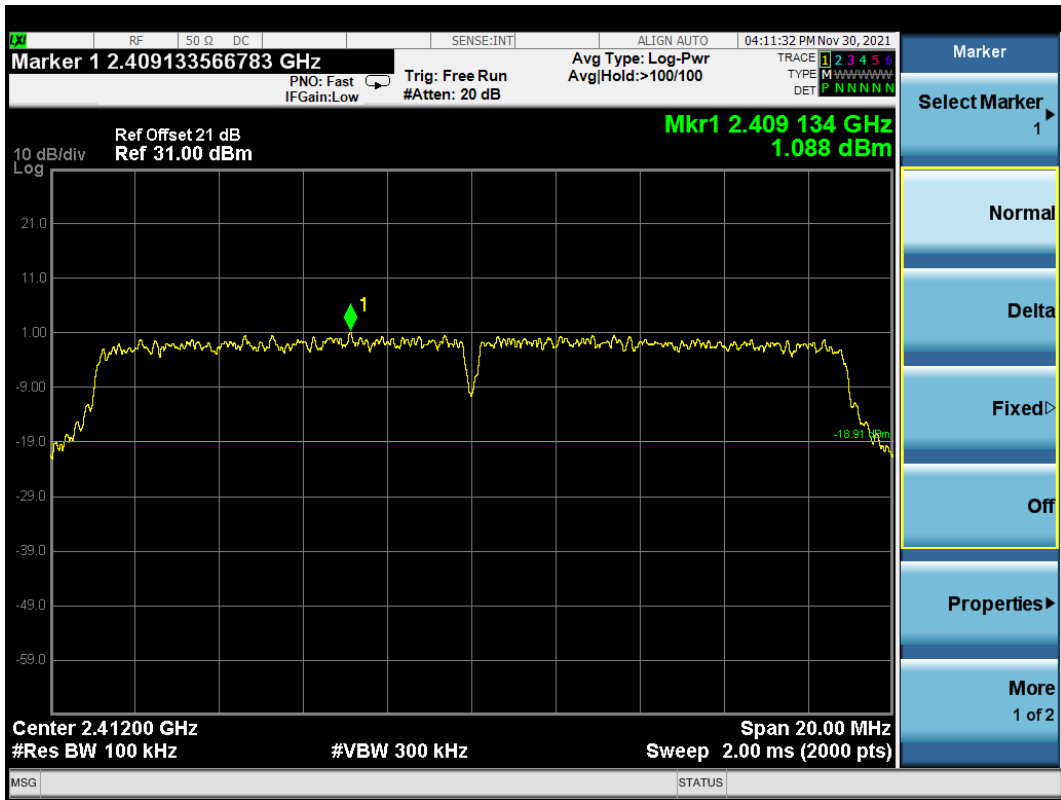

Emission level

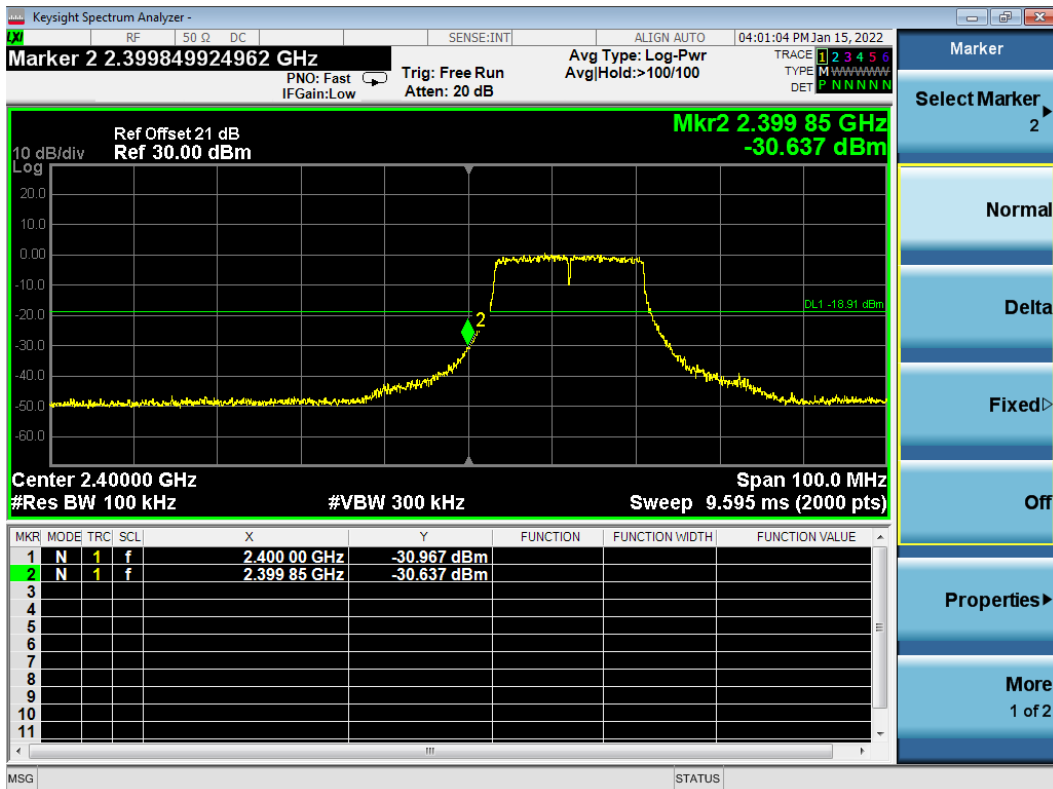

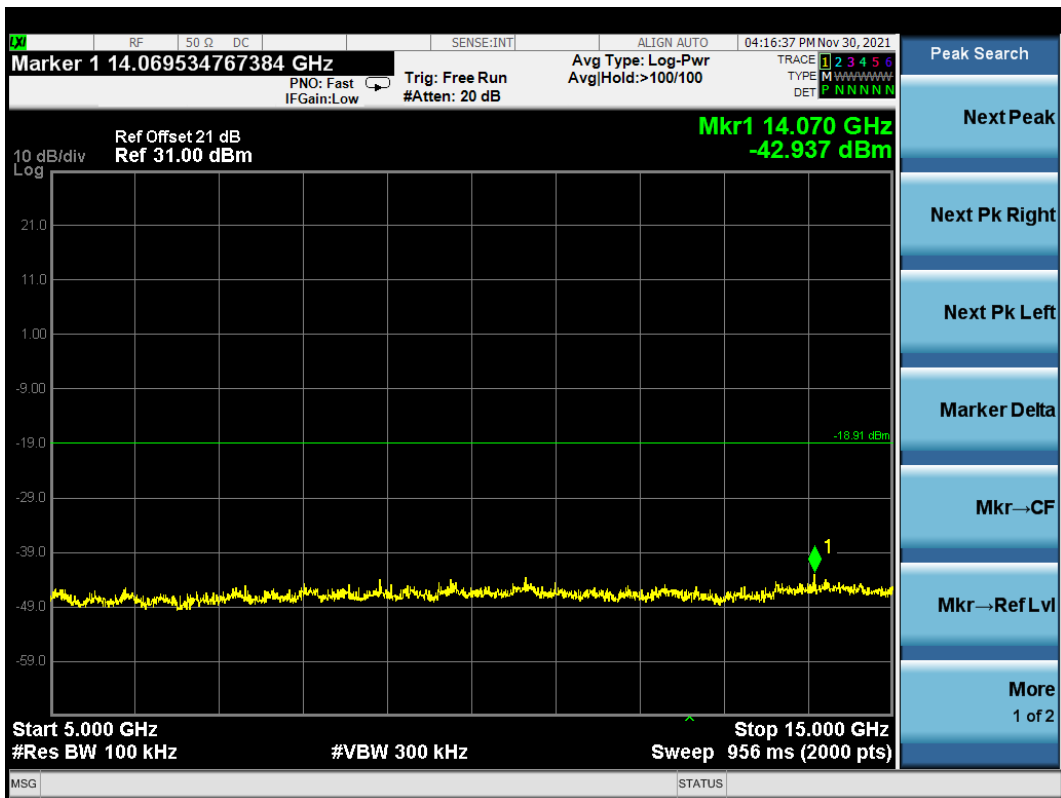
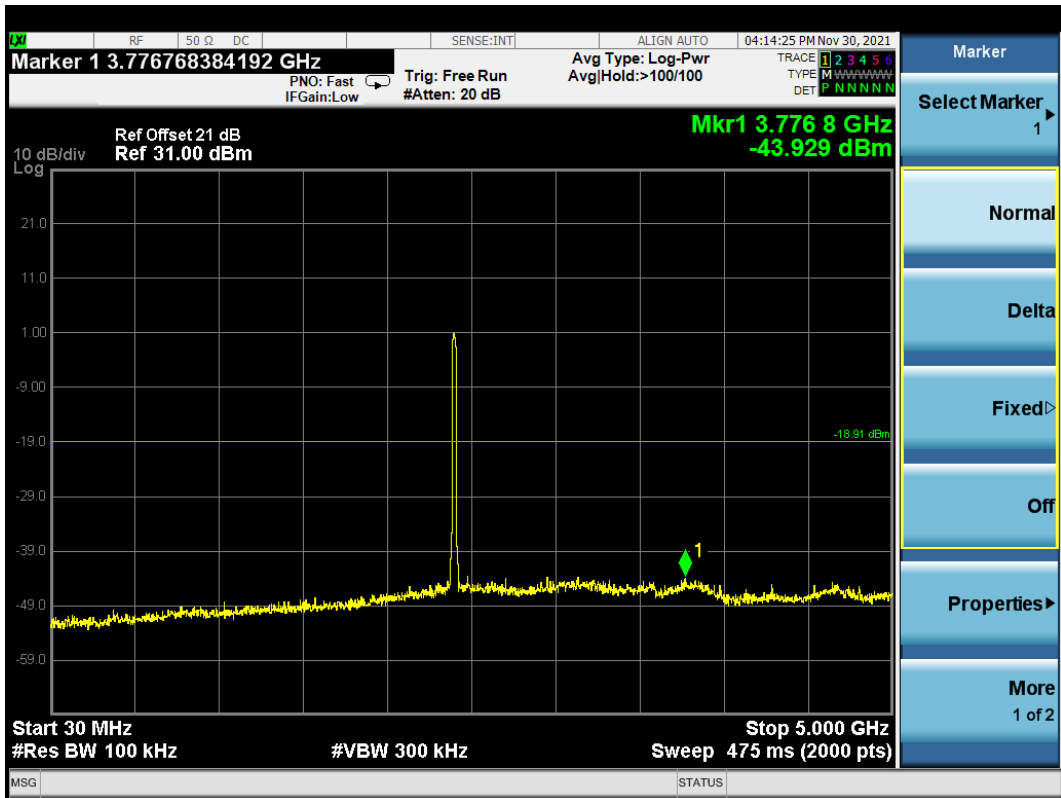

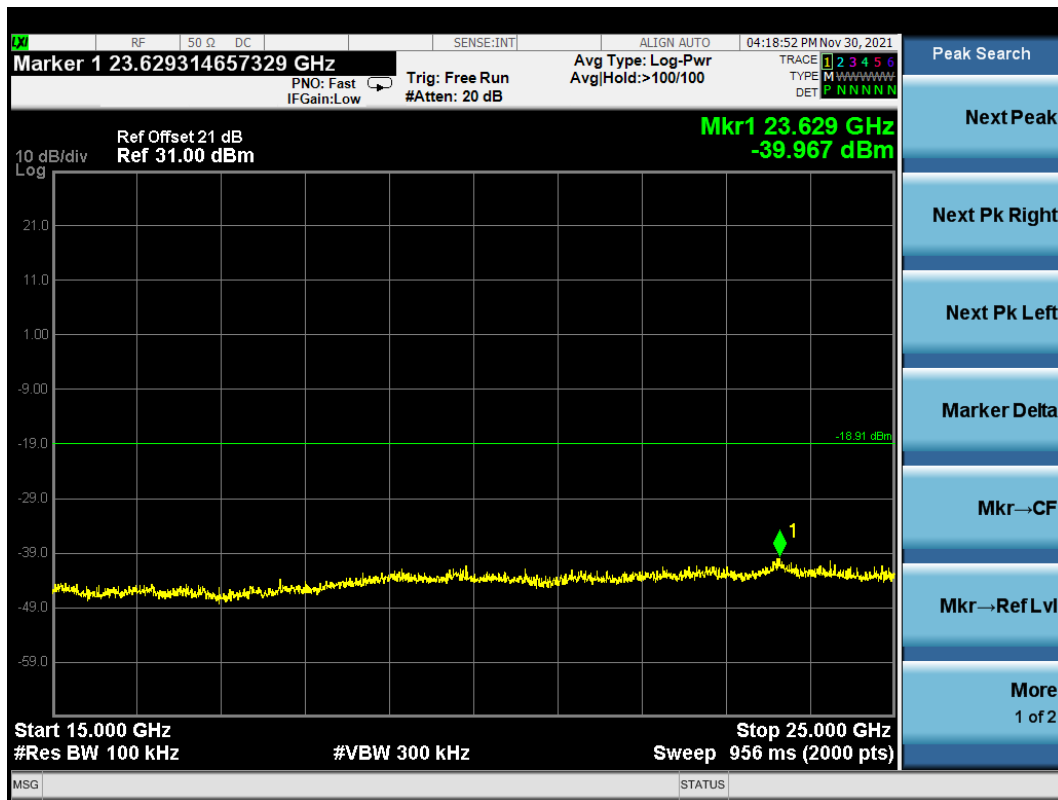

802.11n20 CH2437MHz

Reference level

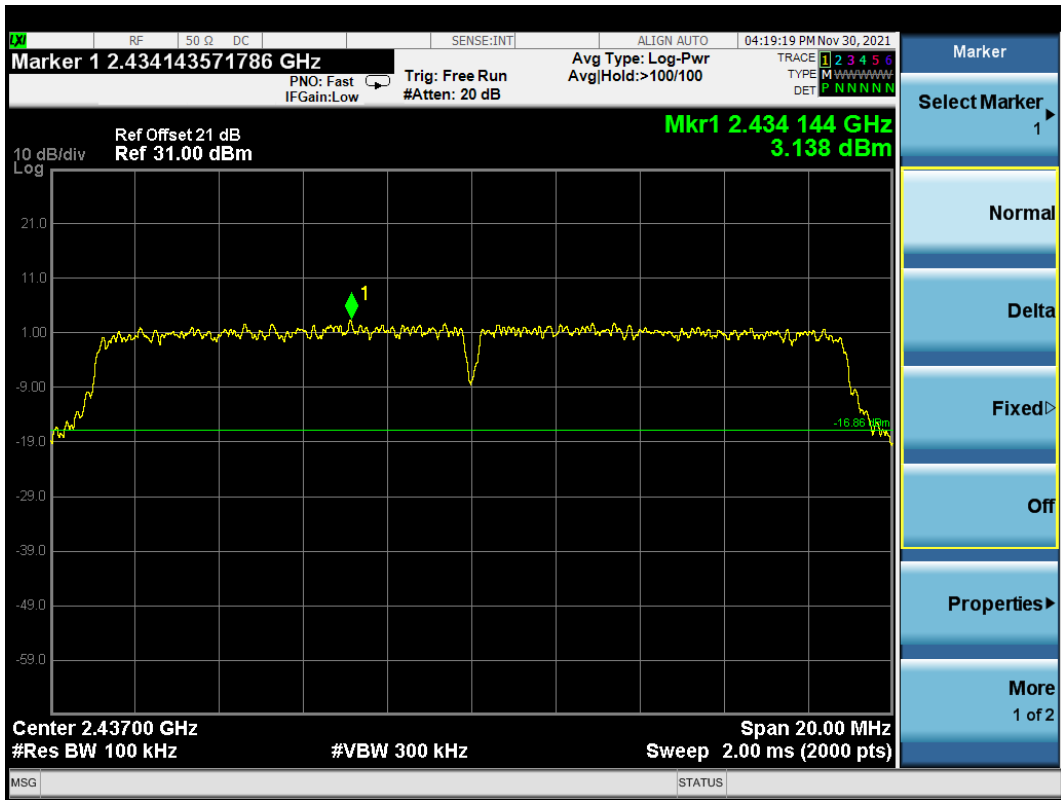

Emission level

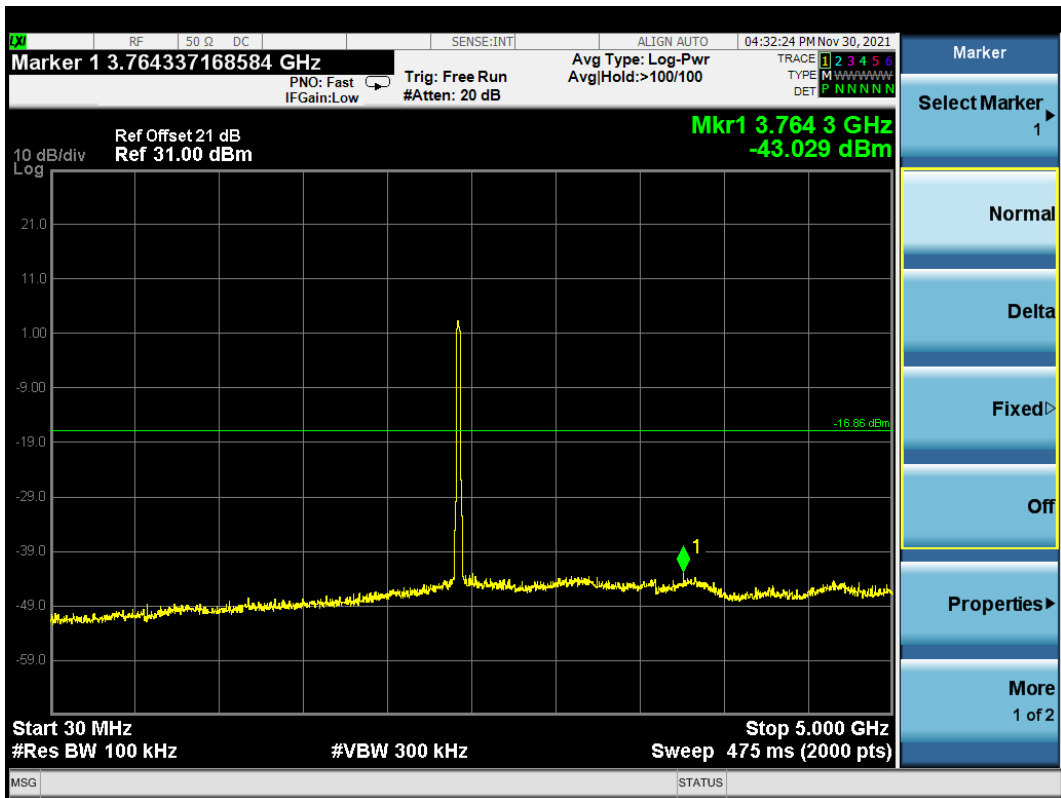



802.11n20 CH2462MHz

Reference level

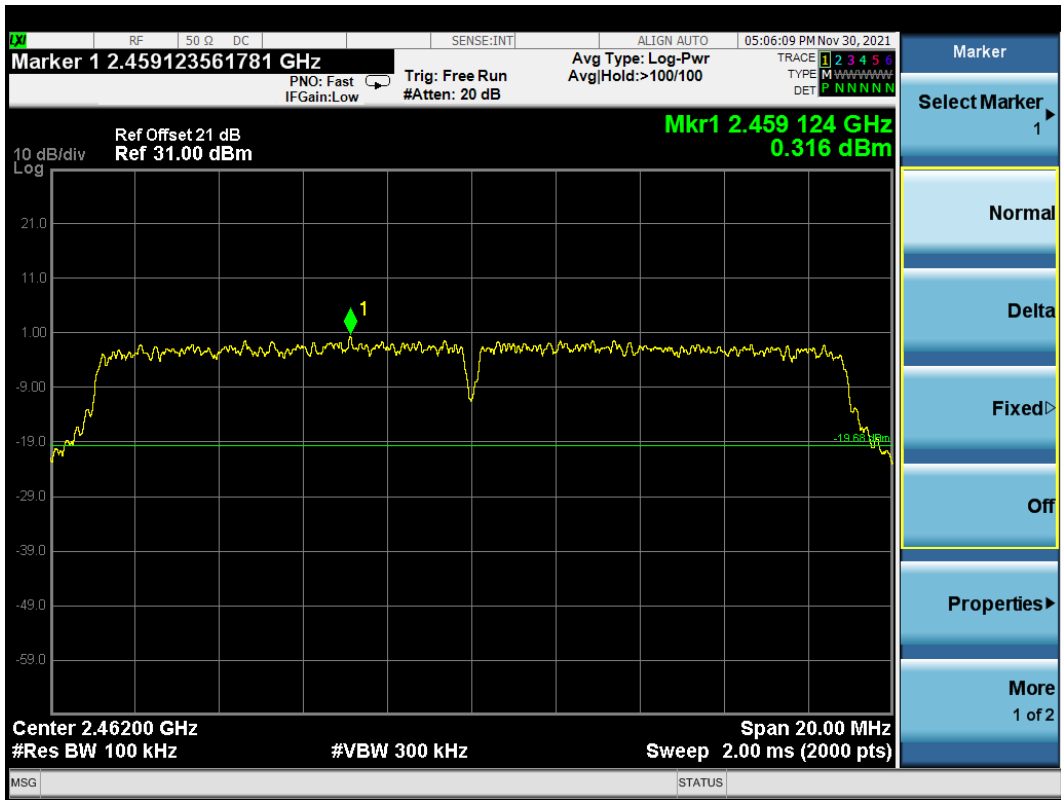

Emission level

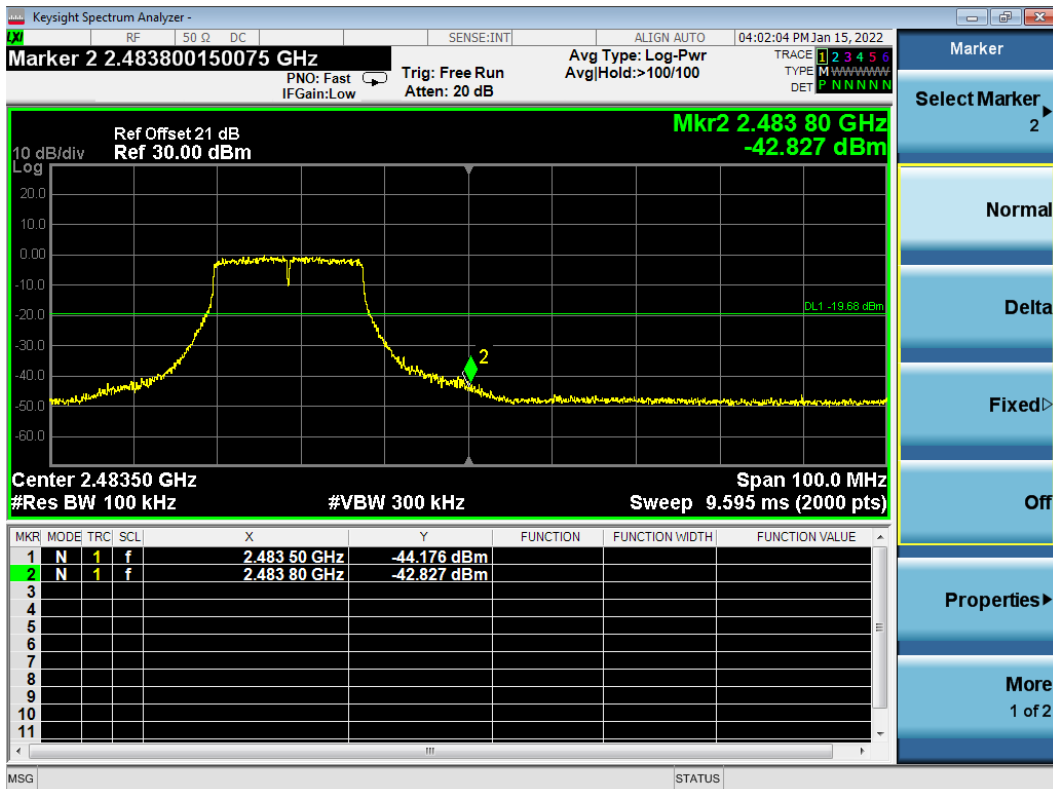

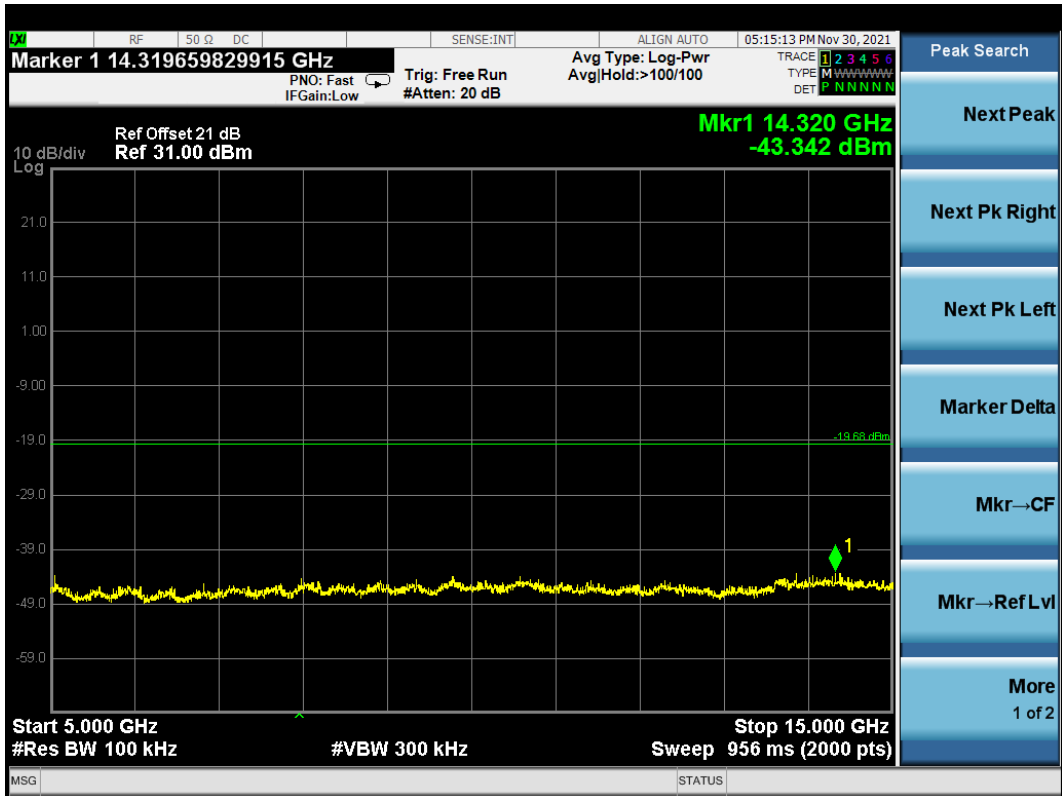
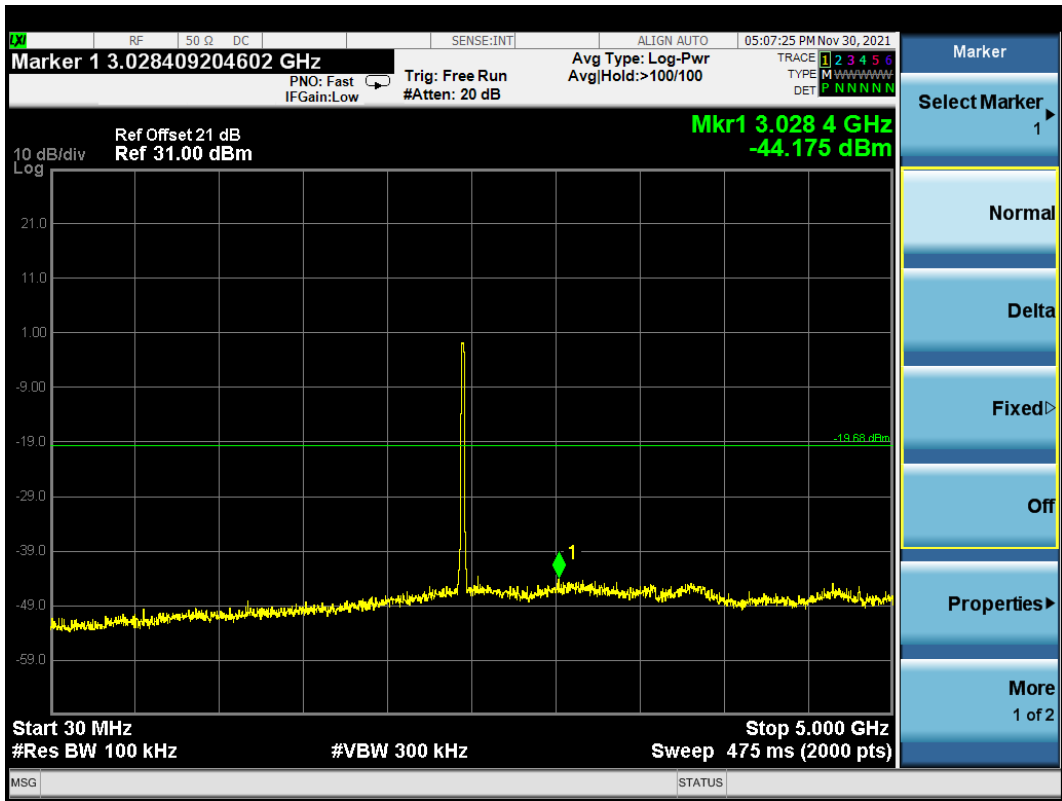





## 8 POWER SPECTRAL DENSITY MEASUREMENT

### 8.1 Test Equipment

The following test equipment was used during the power spectral density measurement:

Item	Type	Manufacturer	Model No.	Serial No.	Cal. Date	Cal. Interval
1.	Spectrum Analyzer	Agilent	N9010A	MY52221182	2021.09.15	1 Year
2.	Coaxial Cable	WOKEN	SFL402-105F LEX	F02-150819-045	2021.03.08	1 Year
3.	20 dB Attenuator	Mini-Circuits	VAT-20+	001	2021.08.06	1 Year

### 8.2 Block Diagram of Test Setup

The Same as section 5.2.

### 8.3 Specification Limits (§15.247(e))

The peak power spectral density conducted from the intentional radiator to the antenna shall not be greater than 8 dBm in any 3 kHz band.

### 8.4 Operating Condition of EUT

The switch ON/OFF was used to enable the EUT to change the channel one by one.

### 8.5 Test Procedure

The transmitter output was connected to the spectrum analyzer.

- a) Set analyzer center frequency to DTS channel center frequency.
- b) Set the span to 1.5 times the DTS bandwidth.
- c) Set the RBW to  $3 \text{ kHz} \leq \text{RBW} \leq 100 \text{ kHz}$ .
- d) Set the VBW  $\geq [3 \times \text{RBW}]$ .
- e) Detector = peak.
- f) Sweep time = auto couple.
- g) Trace mode = max hold.
- h) Allow trace to fully stabilize.
- i) Use the peak marker function to determine the maximum amplitude level within the RBW.
- j) If measured value exceeds requirement, then reduce RBW (but no less than 3 kHz) and repeat.

The test procedure is defined in ANSI C63.10-2013 ( 11.10.2 Measurement Procedure “Method PKPSD (peak PSD)” was used).

## 8.6 Test Results

### **PASSED.**

All the test results are attached in next pages.

(Test Date: 2021.11.30 Temperature: 23°C Humidity: 51 %)

Modulation	Channel	Frequency (MHz)	Power Spectral Density (dBm)	Limit
802.11b	1	2412	<b>-4.908</b>	8 dBm
	6	2437	<b>-5.324</b>	8 dBm
	11	2462	<b>-5.477</b>	8 dBm
802.11g	1	2412	<b>-12.39</b>	8 dBm
	6	2437	<b>-10.28</b>	8 dBm
	11	2462	<b>-14.05</b>	8 dBm
802.11n20	1	2412	<b>-13.285</b>	8 dBm
	6	2437	<b>-11.247</b>	8 dBm
	11	2462	<b>-14.1</b>	8 dBm

### 802.11b CH2412 MHz

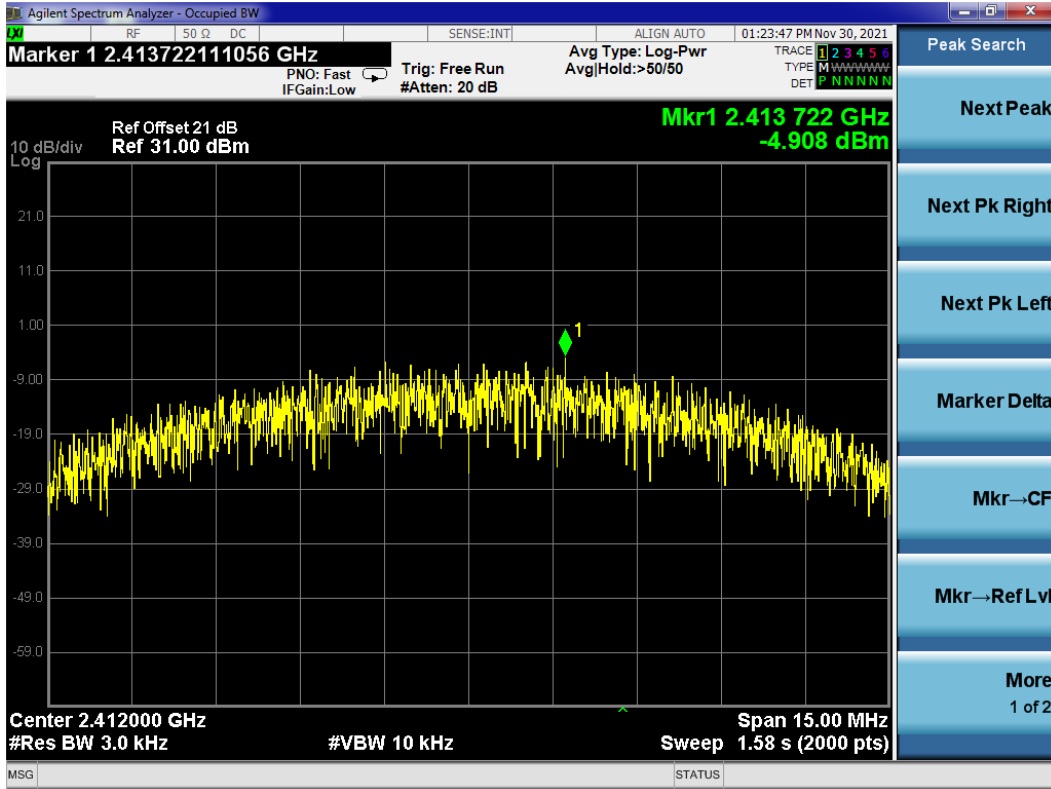

### 802.11b CH2437 MHz

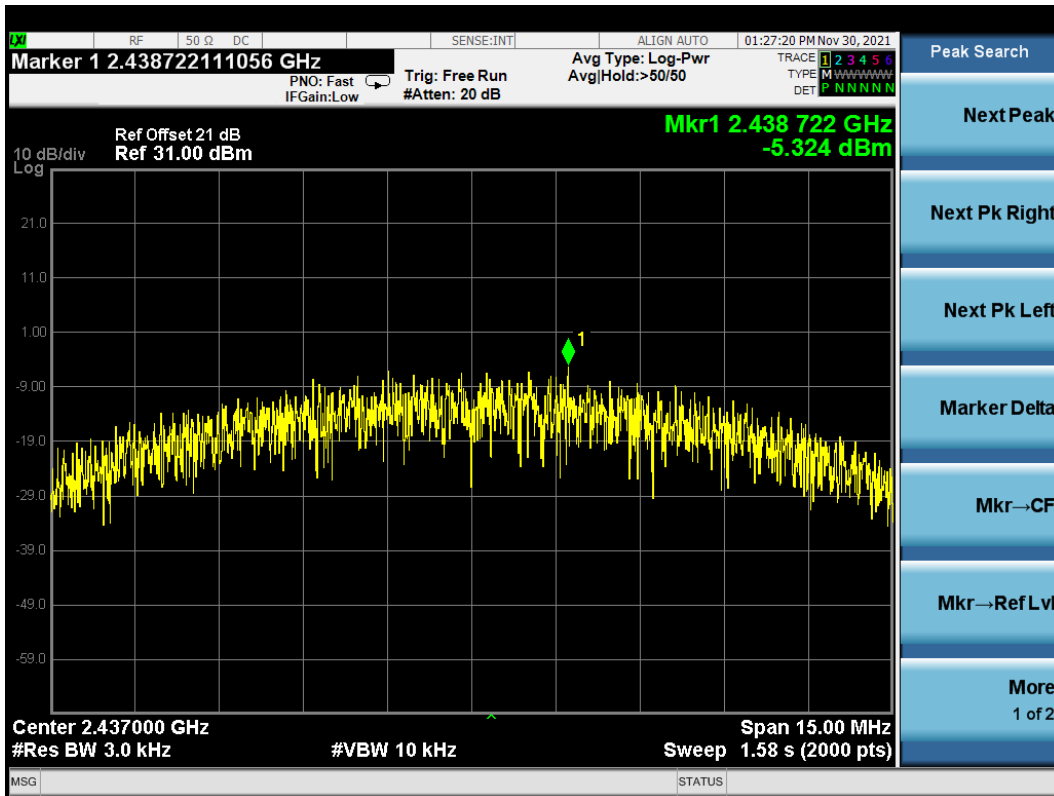

### 802.11b CH2462 MHz

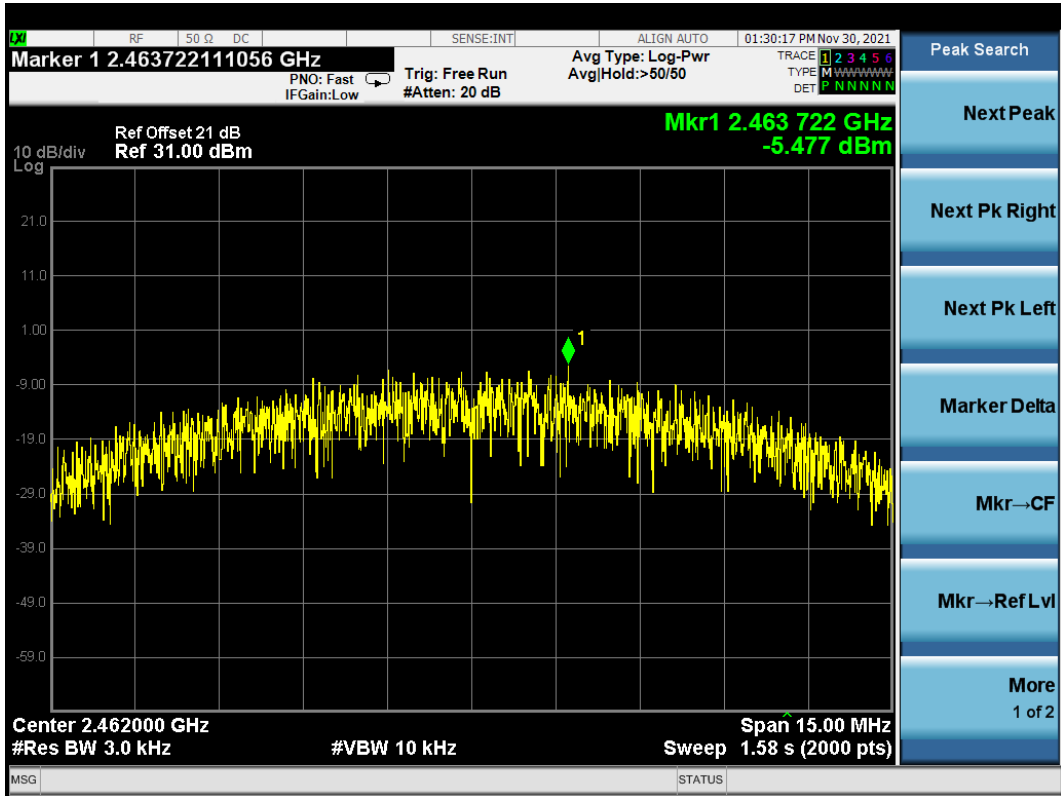

### 802.11g CH2412 MHz

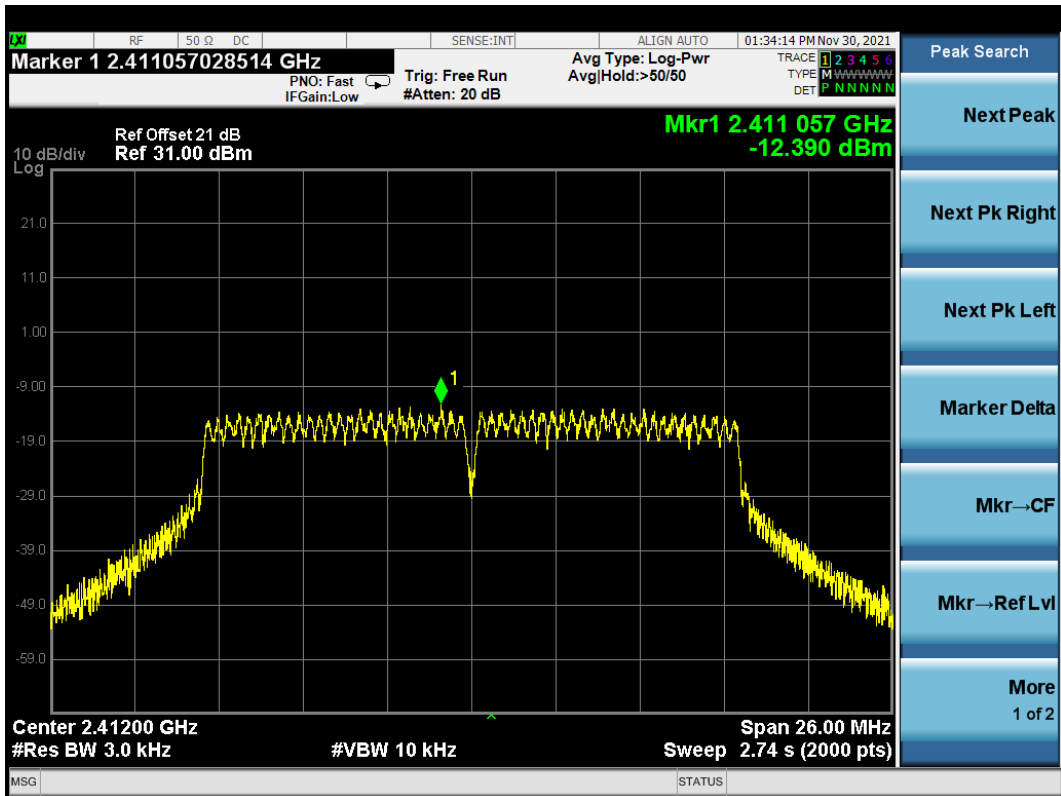

### 802.11g CH2437 MHz

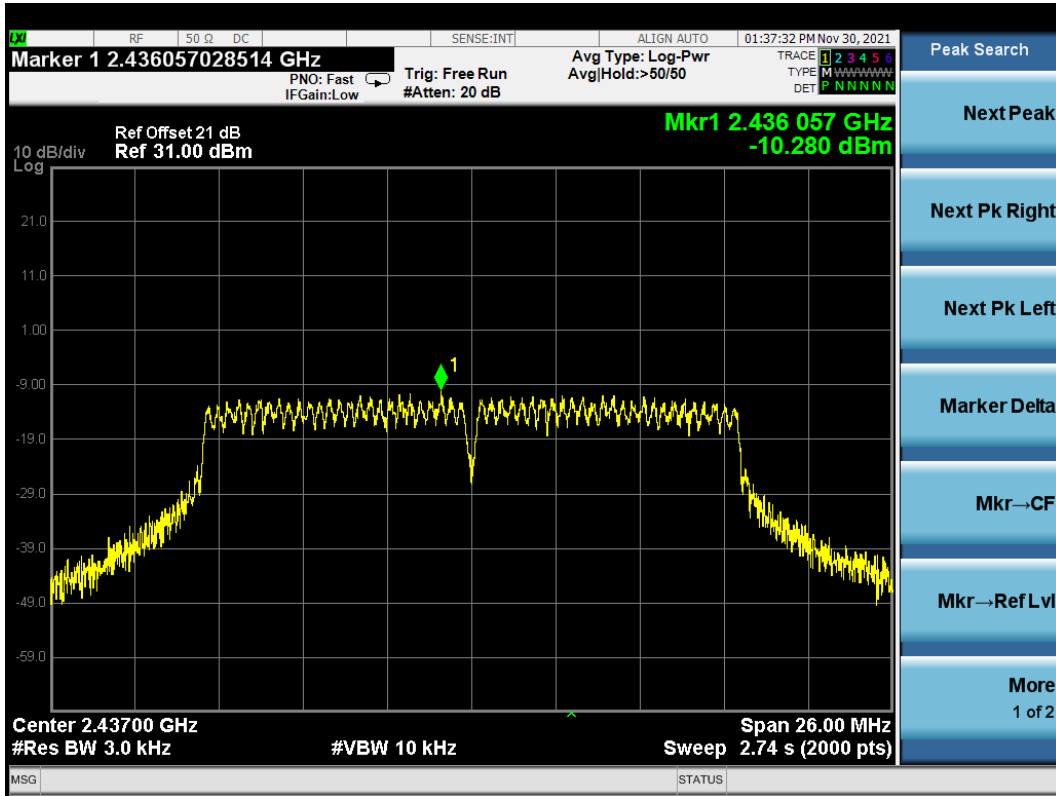

### 802.11g CH2462 MHz

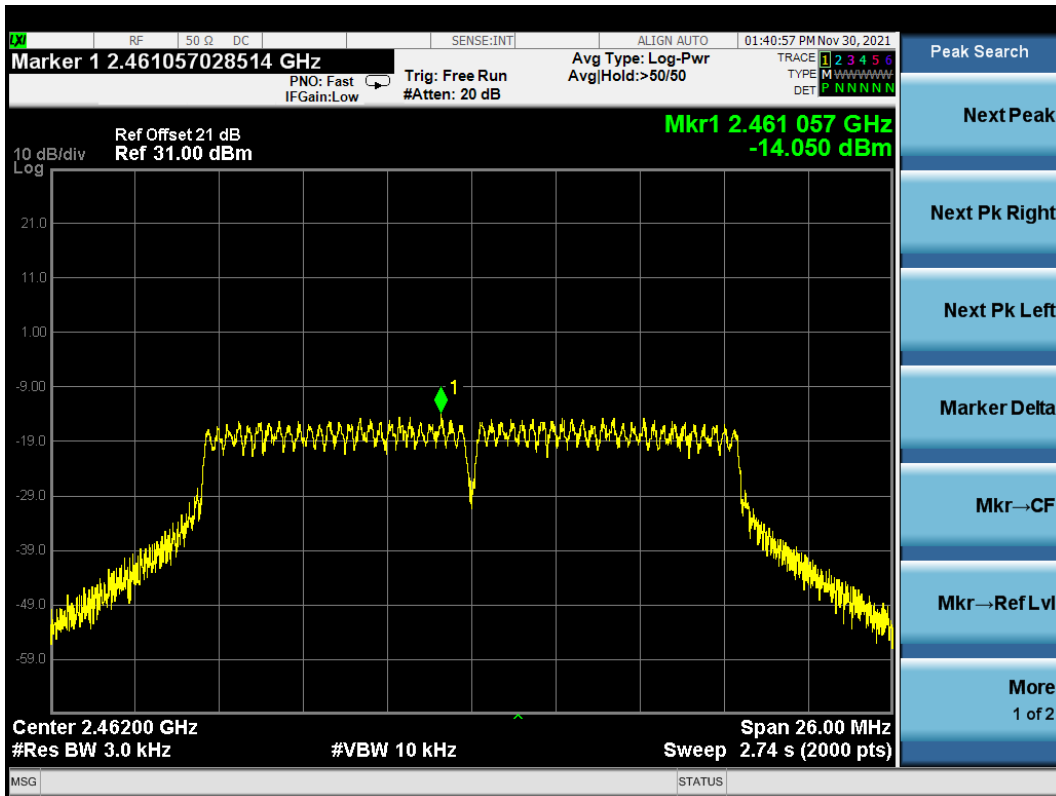

### 802.11n20 CH2412 MHz

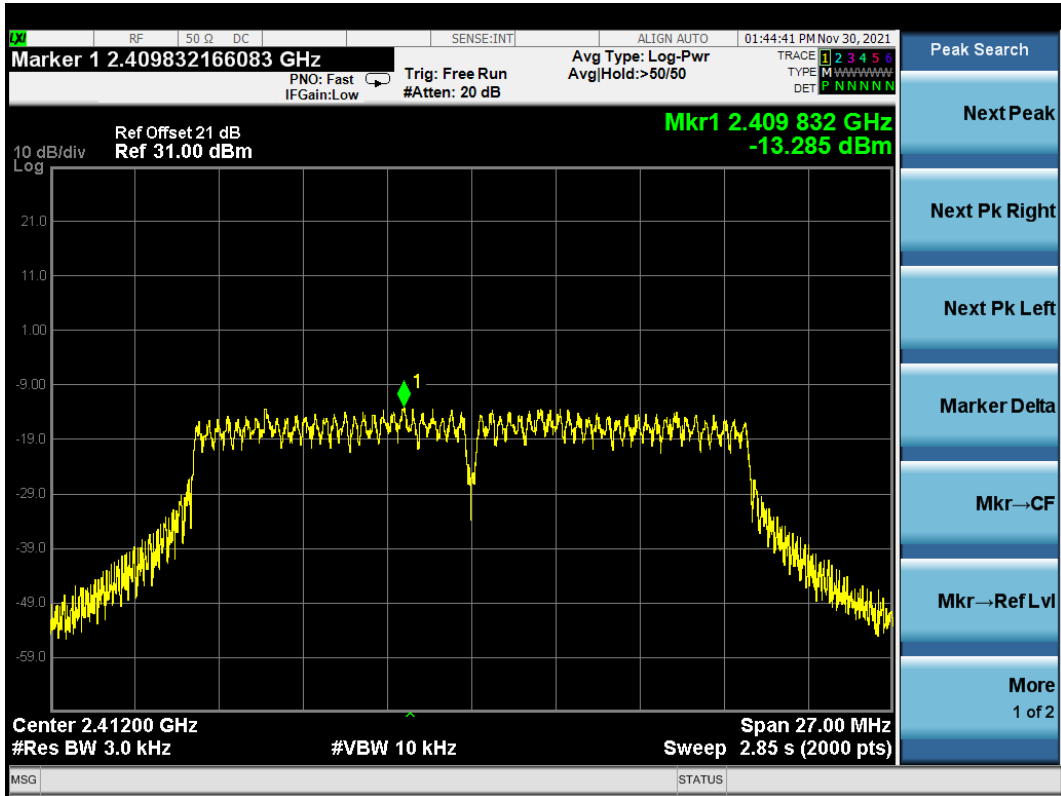

### 802.11n20 CH2437 MHz

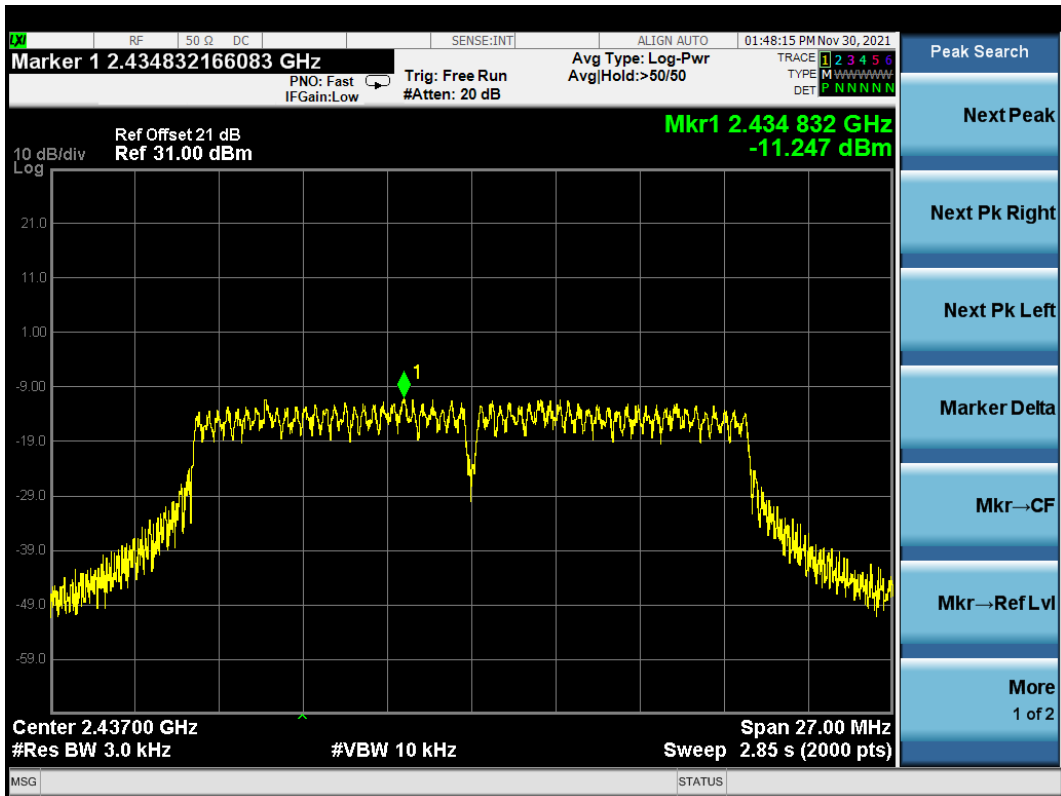

### 802.11n20 CH2462 MHz

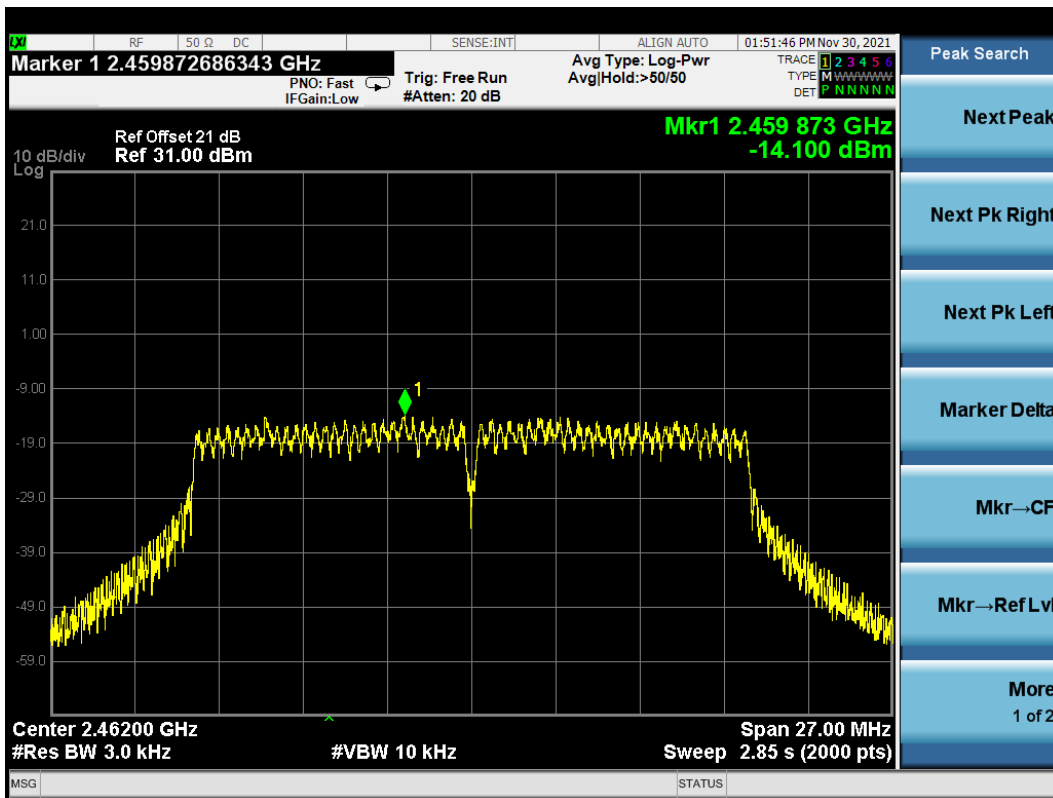

## **9 DEVIATION TO TEST SPECIFICATIONS**

None.



## 10 MEASUREMENT UNCERTAINTY LIST

The measurement uncertainty was estimated for test on the EUT according to CISPR 16-4-2. This uncertainty represents an expanded uncertainty expressed at approximately the 95% confidence level using a coverage of K=2.

The uncertainties value is not used in determining the PASS/FAIL results.

Test Items/Facilities	Frequency/Equipment/Unit	Uncertainty
Conducted Emission No.1 Shielded Room	9kHz~150kHz	±3.1 dB
	150kHz~30MHz	±2.6 dB
Conducted Emission No.3 Shielded Room	9kHz~150kHz	±3.1 dB
	150kHz~30MHz	±2.6 dB
Radiated Emission	30MHz~200MHz, Horizontal	±3.8 dB
	30MHz~200MHz, Vertical	±4.1 dB
	200MHz~1000MHz, Horizontal	±3.6 dB
	200MHz~1000MHz, Vertical	±5.1 dB
	1GHz~6GHz	±5.3 dB
	6GHz~18GHz	±5.3 dB
	18GHz~40GHz	±3.5 dB
Output Power Test	50MHz~18GHz	0.77 dB
Power Density Test	9kHz~6GHz	1.08 dB
RF Frequency Test	9kHz~40GHz	$6 \times 10^{-4}$
Bandwidth Test	9kHz~6GHz	$1.5 \times 10^{-3}$
RF Radiated Power Test	30MHz~1000MHz	3.06 dB
Conducted Output Power Test	50MHz~18GHz	0.83 dB
AC Voltage(<10kHz) Test	120V~230V	0.04 %
DC Power Test	0V~30V	0.4 %
Temperature	-40°C~+100°C	0.52 °C
Humidity	30%~95%	2.6 %