

## TEST REPORT

On behalf of

Savant Technologies LLC, dba GE Lighting, a Savant company

Product Name: Downlight

Refer to Sec.2.1

FCC ID: PUU-CFIXCNLR6C1

Prepared For: Savant Technologies LLC, dba GE Lighting, a Savant company  
1975 Noble Road, Cleveland, OH 44112

Prepared By: Audix Technology (Shanghai) Co., Ltd.  
3F, 34Bldg, 680 Guiping Rd.,  
Caohejing Hi-Tech Park,  
Shanghai 200233, China

Tel: +86-21-64955500



File No. : C1D2303019  
Report No. : ACI-F21279A2  
Date of Test : 2023.03.16-29  
Date of Report : 2023.04.17

The statement is based on a single evaluation of one sample of the above-mentioned products. It does not imply an assessment of the whole production and does not permit the use of the test lab logo. The report must not be used by the client to claim product certification, approval, or endorsement by NVLAP, NIST, or any agency of the Federal Government.

## TABLE OF CONTENTS

	Page
<b>1 SUMMARY OF STANDARDS AND RESULTS</b> .....	<b>4</b>
1.1 Description of Standards and Results.....	4
<b>2 GENERAL INFORMATION</b> .....	<b>5</b>
2.1 Description of Equipment Under Test.....	5
2.2 EUT Specifications Assessed in Current Report.....	7
2.3 Test Information .....	7
2.4 Duty Cycle Check .....	8
2.5 Sample Description .....	9
2.6 Supported equipment.....	9
2.7 Description of Test Facility .....	9
<b>3 CONDUCTED EMISSION TEST</b> .....	<b>10</b>
3.1 Test Equipment.....	10
3.2 Block Diagram of Test Setup .....	10
3.3 Conducted Emission Limits (§15.207).....	11
3.4 Test Configuration.....	11
3.5 Operating Condition of EUT.....	11
3.6 Test Procedures .....	11
3.7 Test Results .....	12
<b>4 RADIATED EMISSION TEST</b> .....	<b>14</b>
4.1 Test Equipment.....	14
4.2 Block Diagram of Test Setup .....	14
4.3 Radiated Emission Limit (§15.209) .....	15
4.4 Test Configuration.....	15
4.5 Operating Condition of EUT.....	16
4.6 Test Procedures .....	16
4.7 Test Results .....	17
<b>5 MAXIMUM PEAK OUTPUT POWER MEASUREMENT</b> .....	<b>23</b>
5.1 Test Equipment.....	23
5.2 Block Diagram of Test Setup .....	23
5.3 Specification Limits ((§15.247(b)(3)) .....	23
5.4 Operating Condition of EUT .....	23
5.5 Test Procedure .....	23
5.6 Test Results .....	24
<b>6 BANDEDGE MEASUREMENT</b> .....	<b>30</b>
6.1 Test Equipment.....	30
6.2 Block Diagram of Test Setup .....	30
6.3 Specification Limits (§15.247(d)) .....	30
6.4 Operating Condition of EUT .....	30
6.5 Test Procedure.....	30
6.6 Test Results .....	32
<b>7 MEASUREMENT UNCERTAINTY LIST</b> .....	<b>39</b>
APPENDIX I PHOTOGRAPHS OF TEST	
APPENDIX II PHOTOGRAPHS OF EUT	

# TEST REPORT

Applicant : Savant Technologies LLC, dba GE Lighting, a Savant company  
 EUT Description : Downlight  
 (A) Model No. : Refer to Sec.2.1  
 (B) Power Supply : 120V AC 60Hz  
 (C) Test Voltage : 120V/60Hz

### Test Procedure Used:

*FCC RULES AND REGULATIONS PART 15 SUBPART C  
 AND ANSI C63.10-2013*

The device described above is tested by Audix Technology (Shanghai) Co., Ltd. to determine the maximum emission levels emanating from the device. The maximum emission levels are compared to the FCC Part 15 Subpart C limits.

The test results are contained in this test report and Audix Technology (Shanghai) Co., Ltd. is assumed full responsibility for the accuracy and completeness of these measurements. This report also shows that the EUT (M/N: Refer to Sec2.1), which was tested is technically compliance with the FCC limits.

This report applies to above tested Sample only. This report shall not be reproduced in part without written approval of Audix Technology (Shanghai) Co., Ltd.

***The test results for EUT's BLE function are contained in No.ACI-F21278A2 report.***

Date of Test : 2023.03.16-29 Date of Report : 2023.04.17

Producer :   
 JAREY LU / Deputy Assistant Manager

Reviewer :   
 BYRON WU / Deputy Assistant Manager

 For and on behalf of  
 Audix Technology (Shanghai) Co., Ltd.

Signatory :   
 Authorized Signature(s) KAMP CHEN / Manager

# 1 SUMMARY OF STANDARDS AND RESULTS

## 1.1 Description of Standards and Results

The EUT have been tested according to the applicable standards as referenced below:

Description / Test Item	Test Standard	Results	Meets Limit
<b>EMISSION</b>			
Conducted Emission	FCC RULES AND REGULATIONS PART 15 SUBPART C AND ANSI C63.10:2013	Pass	15.207
Radiated Emission	FCC RULES AND REGULATIONS PART 15 SUBPART C AND ANSI C63.10:2013	Pass	15.209(a) 15.205(a)(c)
6 dB Bandwidth Measurement	FCC RULES AND REGULATIONS PART 15 SUBPART C AND ANSI C63.10:2013	Pass	15.247(a)(2)
Maximum Peak Output Power Measurement	FCC RULES AND REGULATIONS PART 15 SUBPART C AND ANSI C63.10:2013	Pass	15.247(b)(3)
Emission Limitations Measurement	FCC RULES AND REGULATIONS PART 15 SUBPART C AND ANSI C63.10:2013	Pass	15.247(d)
Band Edge Measurement	FCC RULES AND REGULATIONS PART 15 SUBPART C AND ANSI C63.10:2013	Pass	15.247(d)
Power Spectral Density Measurement	FCC RULES AND REGULATIONS PART 15 SUBPART C AND ANSI C63.10:2013	Pass	15.247(e)
N/A is an abbreviation for Not Applicable.			

## 2 GENERAL INFORMATION

### 2.1 Description of Equipment Under Test

- Description : Downlight
- Type of EUT :  Production  Pre-product  Pro-type
- Model Number : CFIXCNLR6C1, CFIXCNLR6CRVD, CFIXCNLR6C1@, CFIXCNLR6CRVD@
- Note#1 : @ Can be represented by any letters, numbers, or symbols, which means CRI, CCT, product color, packaging, or internal identification.
- Note#2 : The difference between the models as follows:

Model	Difference description 1
CFIXCNLR6C1	All the same except for CRI, CCT, product color, packaging, or internal identification
CFIXCNLR6C1@	
CFIXCNLR6CRVD	All the same except for CRI, CCT, product color, packaging, or internal identification
CFIXCNLR6CRVD@	

Model	Difference description 2
CFIXCNLR6C1, CFIXCNLR6C1@	The mechanistic housing is different.
CFIXCNLR6CRVD, CFIXCNLR6CRVD@	

- Note#3 : The modified histories of report are as follows:

Report No.	Model No.	Rev. Summary	Edition No.	Data of Rev.
ACI-F21279	CFIXCNLR6C1	Original Report	0	2021.12.29
ACI-F21279A1	CFIXCNLR6CRVD	Add the one model	Rev. A1	2022.08.23
ACI-F21279A2	CFIXCNLR6C1, CFIXCNLR6CRVD, CFIXCNLR6C1@, CFIXCNLR6CRVD@	1. Add the two models 2. Add new power driver 3. Change the product name	Rev. A2	2023.04.17

- Note#4 : According to the modification, we take a re-tested in the test item as following: Conducted Emissions, Radiated Emissions, Maximum Output Power, Band Edge Measurement. According to the re-tested result, we demonstrate that the EUT could be full compliance with the requirement of standards.

- Test model : CFIXCNLR6CRVD

Radio Tech : BLE 4.2;  
IEEE 802.11 b/g/n.

Note: : 802.11n-HT40 not support.

Channel Freq. : BLE: 2402MHz-2480MHz;  
802.11b/g/n: 2412MHz-2462MHz.

Modulation : BLE: GFSK;  
802.11b: DSSS (CCK, DQPSK, DBPSK);  
802.11g/n: OFDM (64QAM, 16QAM, QPSK, BPSK).

Antenna Info. : Antenna Type: PCB Antenna  
Antenna Gain: 0.5 dBi  
The Antenna was a permanently attached antenna  
that is comply with 15.203 requirement.

Applicant : Savant Technologies LLC, dba GE Lighting, a Savant company  
1975 Noble Road, Cleveland, OH 44112

Manufacturer : same as Applicant

Factory : Foshan Electrical and Lighting Co., Ltd. Gaoming  
Branch  
Hecheng Street, Cangjiang Industrial Park, Gaoming  
District Foshan Guangdong 528000 CHINA

## 2.2 EUT Specifications Assessed in Current Report

Mode	Modulation	Data Rate(Mbps)
802.11b	DS (DQPSK, DBPSK, CCK)	Up to 11
802.11g	OFDM (64-QAM, 16-QAM, QPSK, BPSK)	Up to 54
802.11n-HT 20	OFDM (64-QAM, 16-QAM, QPSK, BPSK)	Up to 72.2

Channel List			
Channel No.	Frequency (MHz)	Channel No.	Frequency (MHz)
1	2412	7	2442
2	2417	8	2447
3	2422	9	2452
4	2427	10	2457
5	2432	11	2462
6	2437		

## 2.3 Test Information

The test software “UI\_mptool.exe” was used to control EUT work in TX mode, Power Index and select test channel.

Modulation	data rate (Mbps)	Power Index	Test Channel		Frequency (MHz)
802.11b	11	92	Low:	1	2412
		90	Middle:	6	2437
		89	High:	11	2462
802.11g	6	95	Low:	1	2412
		105		3	2422
		104	Middle:	6	2437
		104		9	2452
		87	High:	11	2462
802.11n20	MCS0	91	Low:	1	2412
		101		3	2422
		100	Middle:	6	2437
		100		9	2452
		87	High:	11	2462

## 2.4 Duty Cycle Check

Mode	Transmission Duration (ms)	Transmission Period (ms)	Duty Cycle (%)
802.11b	10	10	100
802.11g	10	10	100
802.11n20	10	10	100





## 2.5 Sample Description

Test Item	Model Number	Sample Number	Date of received
Conducted Emission	CFIXCNLR6CRVD	E2303210-01/03	2023.03.10
Radiated Emission	CFIXCNLR6CRVD	E2303214a1-02/02	2023.03.10
Conducted RF Test	CFIXCNLR6CRVD	E2303214a2-02/02	2023.03.10

## 2.6 Supported equipment

Brand : Acer  
Product Name: : Notebook PC  
Model Name : TravelMate P238 series  
Model Number : N15W8

Product Name : Test Fixture  
Product Function : USB to TTL

## 2.7 Description of Test Facility

Name of Firm : Audix Technology (Shanghai) Co., Ltd.

Site Location : 3F, 34Bldg, 680 Guiping Rd., Caohejing Hi-Tech Park, Shanghai 200233, China.

Accredited by NVLAP, Lab Code : 200371-0

FCC Designation Number : CN5027

Test Firm Registration Number : 954668

### 3 CONDUCTED EMISSION TEST

#### 3.1 Test Equipment

The following test equipments are used during the conducted emission test in a shielded room:

Item	Type	Manufacturer	Model No.	Serial No.	Cal. Date	Cal. Interval
1.	Test Receiver	R&S	ESCI	101302	2023.02.22	1 Year
2.	Artificial Mains Network (AMN)	R&S	ESH2-Z5	843890/011	2023.02.22	1 Year
3.	CE Cable	Audix+ANRIT SU	CE Cable+MP59 B	CE-SH1-001+6200655086	2023.02.22	1 Year
4.	Software	Audix	e3	6.2009-1-15	--	--

#### 3.2 Block Diagram of Test Setup

##### 3.2.1 Conducted Disturbance Test Setup

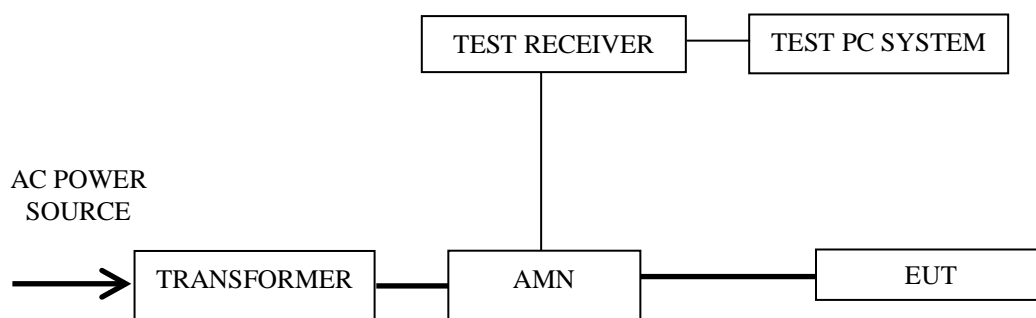

— : Signal Line  
 — : Power Line

### 3.3 Conducted Emission Limits (§15.207)

Frequency Range (MHz)	Limits dB(μV)	
	Quasi-peak	Average
0.15 ~ 0.5	66~56	56~46
0.5 ~ 5	56	46
5 ~ 30	60	50
NOTE 1 – The lower limit shall apply at the transition frequencies. NOTE 2 – The limit decreases linearly with the logarithm of the frequency in the range 0.15 MHz~0.50 MHz		

### 3.4 Test Configuration

The EUT (listed in Sec.2.1) was installed as shown on Sec.3.2 to meet FCC requirement and operating in a manner which tends to maximize its emission level in a normal application.

### 3.5 Operating Condition of EUT

3.5.1 Setup the EUT as shown in Sec. 3.2.

3.5.2 Turn on the power of all equipment.

3.5.3 Turn the EUT on the test mode, and then test.

### 3.6 Test Procedures

The EUT was placed upon a non-metallic table, which is 0.8 m above the horizontal conducting ground plane and 0.4 m from a vertical reference plane. The EUT was connected to the power mains through an Artificial Mains Network (AMN) to provide a 50 Ω coupling impedance for the measuring equipment. Both sides of AC line (Line & Neutral) were checked to find out the maximum conducted emission according to FCC Part 15 Subpart C and ANSI C63.10: 2013 requirements during conducted disturbance test.

The I.F. bandwidth of Test Receiver ESCI was set at 9 kHz.

The frequency range from 150 kHz to 30 MHz was checked.

Test with a dummy load in lieu of the antenna to determine compliance with Section 15.207 limits within the transmitter's fundamental emission band. (According to KDB 174176 D01 Line Conducted FAQ)

The test modes were done on conducted disturbance test and all the test results are listed in Sec. 3.7

### 3.7 Test Results

< **PASS** >

The frequency and amplitude of the highest conducted emission relative the limit is reported. All the emissions not reported below are too low against the FCC limit.

Worst case emission:

No.	Operation	Mode	Channel	Frequency (MHz)	Data Page
1.	Transmitting	802.11b	1	2412	P13

NOTE 1 – Emission Level = Read Level + AMN Factor + Cable Loss,  
Margin = Limits - Emission Level

NOTE 2 – “QP” means “Quasi-Peak” values

NOTE 3 – The emission levels which not reported are too low against the official limit.

**Worst case emission**

EUT : Downlight Temperature 22°C

Model No. : CFIXCNLR6CRVD Humidity 51%RH

Test Mode : Transmitting Date of Test 2023.03.16

Polarization	Frequency (MHz)	Meter Reading dB (µV)	AMN Factor (dB)	Cable Loss (dB)	Emission Level dB (µV)	Limits dB (µV)	Margin (dB)	Remark
Line	0.15	53.17	0.1	0.03	53.3	66	12.7	QP
	0.15	38.35	0.1	0.03	38.48	56	17.52	Average
	0.2083	40.98	0.1	0.03	41.11	63.27	22.16	QP
	0.2083	28.8	0.1	0.03	28.93	53.27	24.34	Average
	0.2744	35.45	0.1	0.03	35.58	60.98	25.4	QP
	0.2744	19.8	0.1	0.03	19.93	50.98	31.05	Average
	0.6648	24.81	0.2	0.05	25.06	56	30.94	QP
	0.6648	14.9	0.2	0.05	15.15	46	30.85	Average
	1.858	25.37	0.2	0.09	25.66	56	30.34	QP
	1.858	11.09	0.2	0.09	11.38	46	34.62	Average
	17.018	28.2	0.6	0.26	29.06	60	30.94	QP
17.018	18.67	0.6	0.26	19.53	50	30.47	Average	
Neutral	0.15	53.5	0.1	0.03	53.63	66	12.37	QP
	0.15	38.4	0.1	0.03	38.53	56	17.47	Average
	0.2083	41.7	0.1	0.03	41.83	63.27	21.44	QP
	0.2083	29.2	0.1	0.03	29.33	53.27	23.94	Average
	0.2773	34.04	0.1	0.03	34.17	60.9	26.73	QP
	0.2773	21	0.1	0.03	21.13	50.9	29.77	Average
	0.6543	25	0.1	0.05	25.15	56	30.85	QP
	0.6543	16.7	0.1	0.05	16.85	46	29.15	Average
	2.678	22.62	0.2	0.1	22.92	56	33.08	QP
	2.678	9.4	0.2	0.1	9.7	46	36.3	Average
	11.438	22.58	0.33	0.21	23.12	60	36.88	QP
11.438	14.4	0.33	0.21	14.94	50	35.06	Average	

TEST ENGINEER: Jarey

## 4 RADIATED EMISSION TEST

### 4.1 Test Equipment

The following test equipment are used during the radiated emission test in a semi-anechoic chamber:

Item	Type	Manufacturer	Model No.	Serial No.	Cal. Date	Cal. Interval
1.	Preamplifier	Agilent	8447D	2944A10548	2022.06.06	1 Year
2.	Preamplifier	HP	8449B	3008A00864	2022.06.06	1 Year
3.	Spectrum Analyzer	Agilent	N9010A	MY52221182	2022.09.15	1 Year
4.	Test Receiver	R&S	ESCI	101303	2022.06.07	1 Year
5.	Bilog Antenna+6dB Attenuator	Schwarz beck	VULB 9168+EMCI-N-6-06	707+AT-N0637	2022.07.25	1 Year
6.	Horn Antenna	EMCO	3115	9607-4878	2022.07.21	1 Year
7.	Horn Antenna	EMCO	3116	00062643	2022.12.12	1 Year
8.	Coaxial Cable	SCHAFFNER	RG 212U-MIL C 17+N1K50-EW 0630-N1K50-1 5m-1	RE-10m-001/R E-15m-002	2023.02.22	1 Year
9.	Cavity Band Rejection Filter	Microwave	WT-A3882-R 10	WT200312-1-1	2022.06.06	1 Year
10.	Software	Audix	e3	6.111206	--	--

### 4.2 Block Diagram of Test Setup

#### 4.2.1 EUT & Peripherals



#### 4.2.2 Below 1GHz

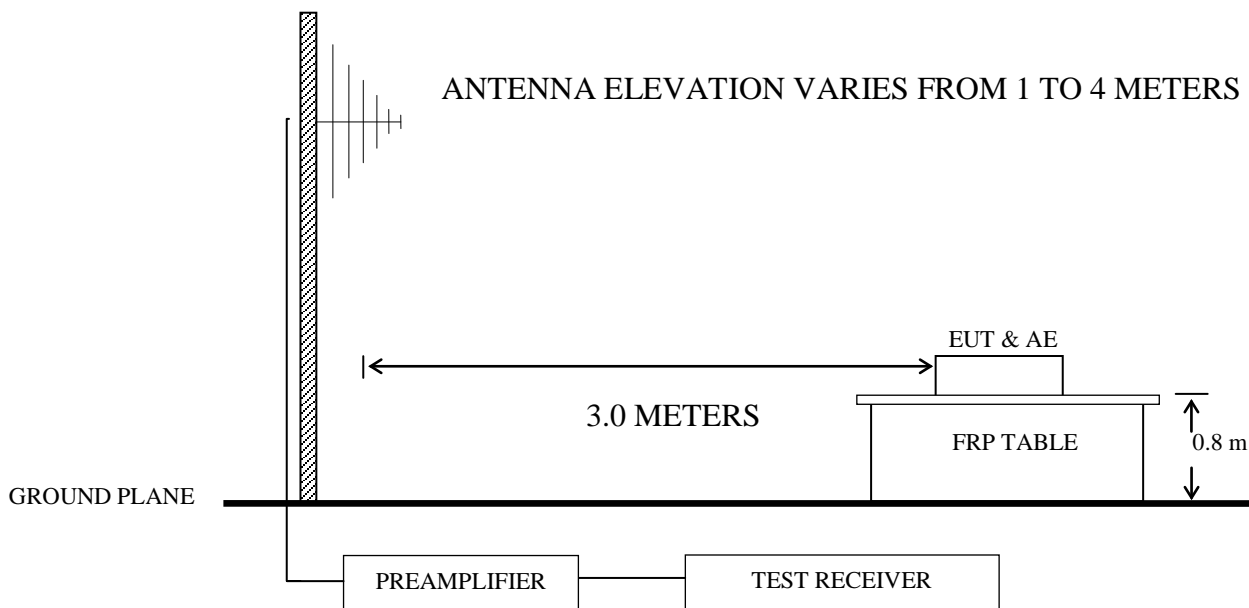

4.2.3 Above 1GHz

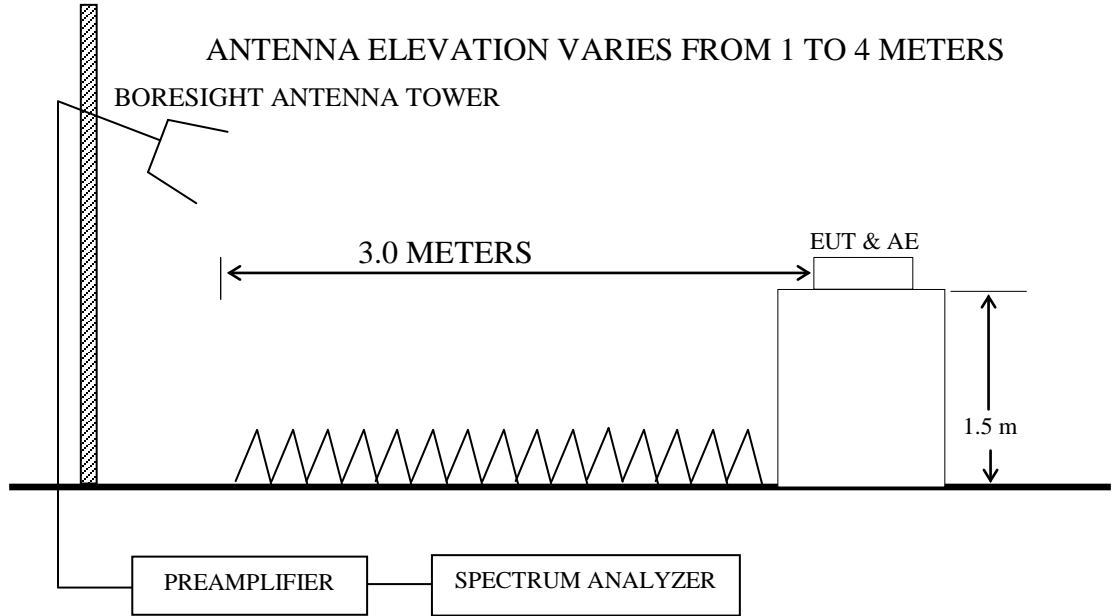

4.3 Radiated Emission Limit (§15.209)

Frequency (MHz)	Distance (m)	Field strength limits (µV/m)	
		(µV/m)	dB(µV/m)
30 ~ 88	3	100	40.0
88 ~ 216	3	150	43.5
216 ~ 960	3	200	46.0
Above 960	3	500	54.0

NOTE 1 - Emission Level dB (µV/m) = 20 log Emission Level (µV/m)

NOTE 2 - The tighter limit applies at the band edges.

NOTE 3 - Distance refers to the distance in meters between the measuring instrument antenna and the closed point of any part of the device or system.

NOTE 4 - The limits shown are based on Quasi-peak value detector below or equal to 1GHz and Average value detector above 1GHz.

NOTE 5 - Above 1 GHz, the limit on peak emission is 20 dB above the maximum permitted average emission limit applicable to the EUT

4.4 Test Configuration

The EUT (listed in Sec.2.1) and the simulators (listed in Sec.2.2) were installed as shown on Sec.4.2 to meet FCC requirements and operating in a manner that tends to maximize its emission level in a normal application.

## 4.5 Operating Condition of EUT

4.5.1 Setup the EUT as shown in Sec. 4.2.

4.5.2 Turn the EUT on.

4.5.3 Connect the EUT and the TTL terminal of Test Fixture through three HCI cables of EUT, as follows (TX to RXD, RX to TXD, GND to GND). Plug the USB terminal of Test Fixture to the USB port of Notebook PC.

4.5.4 Use the software as section 2.3 to select the test mode, then disconnect the Test Fixture from EUT, remove the Test Fixture and Notebook PC, then test.

4.5.5 Repeat step 4.5.3 and 4.5.4, until the test of all modes finished.

## 4.6 Test Procedures

Radiated emission test applies to harmonics/spurs that fall in the restricted bands listed in Section 15.205. The maximum permitted average field strength is listed in Section 15.209. A pre-amp is necessary for this measurement. For measurement above 1 GHz, set RBW = 1MHz, VBW = 10 Hz, Sweep: Auto. If the emission is pulsed, modify the unit for continuous operation; use the settings shown above, then correct the reading by subtracting the peak-average correction factor, derived from the appropriate duty cycle calculation.

The EUT was placed on a turntable. Below 1 GHz, the table height is 80 cm above the reference ground plane. Above 1 GHz, the table height is 1.5 m. The turntable rotated 360 degrees to determine the position of the maximum emission level. The EUT was set 3 meters away from the receiving antenna, which was mounted on an antenna tower. The antenna moved up and down between 1 meter and 4 meters to find out the maximum emission level. Broadband antenna (Calibrated Bilog Antenna) or Horn antenna was used as receiving antenna. Both horizontal and vertical polarizations of the antenna were set on measurement. In order to find the maximum emission, all of the interference cables were manipulated according to ANSI C63.10: 2013 requirements during radiated emission test.

The bandwidth of Test Receiver R&S ESCI was set at 120 kHz from 30MHz to 1000MHz.

The bandwidth of Agilent N9010A was set at 1MHz for above 1GHz.

The frequency range from 30 MHz to 25 GHz (Up to 10<sup>th</sup> harmonics from fundamental frequency) was checked.

All the test results are listed in Sec.4.7.



## 4.7 Test Results

<PASS>

The frequency and amplitude of the highest radiated emission relative the limit is reported. All the emissions not reported below are too low against the FCC limit.

Frequency range: below 1GHz (Worst case emission)

No.	Operation	Mode	Channel	Frequency	Data Page
1.	Transmitting	802.11b	1	2412 MHz	P18

Frequency range: above 1GHz (Worst case emission)

No.	Operation	Mode	Channel	Frequency	Data Page
1.	Transmitting	802.11b	11	2462 MHz	P19
2.		802.11g	6	2437 MHz	P19
3.		802.11n20	6	2437 MHz	P20

Band-Edge:

No.	Operation	Mode	Channel	Frequency	Data Page
1.	Transmitting	802.11b	1	2412 MHz	P21
2.			11	2462 MHz	P21
3.		802.11g	1	2412 MHz	P21
4.			11	2462 MHz	P21
5.		802.11n20	1	2412 MHz	P22
6.			11	2462 MHz	P22

NOTE 1 – Emission Level = Read Level + Antenna Factor + Cable Loss - Preamp Factor  
Margin = Limits - Emission Level.

NOTE 2 – “QP” means “Quasi-Peak” values.

NOTE 3 – 0° was the table front facing the antenna. Degree is calculated from 0° clockwise facing the antenna.

NOTE 4 – The emission levels which not reported are too low against the official limit.

NOTE 5 – The emission levels recorded below is data of EUT configured in Lying direction, for this direction was the maximum emission direction during the test. The data of Side & Standing direction are too low against the official limit to be reported.

NOTE 6 – All reading are Quasi-Peak values below or equal to 1GHz, Peak and Average values above 1GHz.

For above 1GHz test, if the peak measured value complies with the average limit, it is unnecessary to perform an average measurement.

NOTE 7 – The frequency range 2310-2390MHz & 2483.5-2500MHz were tested for Restricted bands.

**Worst case emission < 1GHz**

EUT : Downlight Temperature : 22°C  
 Model No. : CFIXCNLR6CRVD Humidity : 51%RH  
 Test Mode : Transmitting Date of Test : 2023.03.26

**802.11b CH2412MHz**

Polarization	Frequency (MHz)	Meter Reading dB (µV)	Antenna Factor (dB/m)	Cable Loss (dB)	Preamp Factor (dB)	Emission Level dB (µV/m)	Limits dB (µV/m)	Margin (dB)	Remark
Horizontal	57.594	25.22	19.34	0.82	28.2	17.18	40	22.82	QP
	107.89	35.31	16.3	1.13	28.06	24.68	43.5	18.82	QP
	131.3	32.24	18.1	1.23	27.96	23.61	43.5	19.89	QP
	286.98	33.31	19.04	1.86	26.96	27.25	46	18.75	QP
	332.52	31.36	20.2	1.97	27.24	26.29	46	19.71	QP
	504.71	31.96	23.5	2.47	27.8	30.13	46	15.87	QP
Vertical	31.51	36.25	18.93	0.58	28.29	27.47	40	12.53	QP
	43.05	36.51	19.1	0.7	28.23	28.08	40	11.92	QP
	49.359	35.5	19.47	0.75	28.2	27.52	40	12.48	QP
	102.72	34.49	15.5	1.11	28.08	23.02	43.5	20.48	QP
	131.3	36.8	18.1	1.23	27.96	28.17	43.5	15.33	QP
	346.81	34.59	20.12	2	27.4	29.31	46	16.69	QP

TEST ENGINEER: Jarey

**Radiated Emission > 1GHz**

EUT : Downlight Temperature : 22°C  
 Model No. : CFIXCNLR6CRVD Humidity : 51%RH  
 Test Mode : Transmitting Date of Test : 2022.03.26

**802.11b CH2462MHz**

Polarization	Frequency (MHz)	Meter Reading dB (μV)	Antenna Factor (dB/m)	Cable Loss (dB)	Preamp Factor (dB)	Emission Level dB (μV/m)	Limits dB (μV/m)	Margin (dB)	Remark
Horizontal	3736	38.99	32.35	6.51	35.17	42.68	74	31.32	Peak
	4924	40.52	33.27	7.66	34.73	46.72	74	27.28	Peak
	4924	30.45	33.27	7.66	34.73	36.65	54	17.35	Average
	6130	37.37	34.4	8.5	34.79	45.48	74	28.52	Peak
	7795	35.22	37.17	9.99	34.7	47.68	74	26.32	Peak
	9442	34.48	38.5	11.08	34.65	49.41	74	24.59	Peak
Vertical	3268	41.43	31.08	6.08	35.31	43.28	74	30.72	Peak
	4924	46.22	33.27	7.66	34.73	52.42	74	21.58	Peak
	4924	34.32	33.27	7.66	34.73	40.52	54	13.48	Average
	6661	36.87	35.07	8.87	34.73	46.08	74	27.92	Peak
	8272	36.26	38	10.31	34.7	49.87	74	24.13	Peak
	9532	37.03	38.45	11.08	34.65	51.91	74	22.09	Peak

**802.11g CH2437MHz**

Polarization	Frequency (MHz)	Meter Reading dB (μV)	Antenna Factor (dB/m)	Cable Loss (dB)	Preamp Factor (dB)	Emission Level dB (μV/m)	Limits dB (μV/m)	Margin (dB)	Remark
Horizontal	3430	40.27	31.14	6.25	35.26	42.4	74	31.6	Peak
	4870	39.61	33.1	7.6	34.75	45.56	74	28.44	Peak
	4870	28.36	33.1	7.6	34.75	34.31	54	19.69	Average
	6211	36.64	34.6	8.57	34.78	45.03	74	28.97	Peak
	7921	36.55	37.6	10.1	34.7	49.55	74	24.45	Peak
	9586	35.56	38.4	11.2	34.64	50.52	74	23.48	Peak
Vertical	3691	39.97	32.12	6.46	35.19	43.36	74	30.64	Peak
	4870	41.94	33.1	7.6	34.75	47.89	74	26.11	Peak
	4870	32.5	33.1	7.6	34.75	38.45	54	15.55	Average
	6697	36.62	35.2	8.95	34.73	46.04	74	27.96	Peak
	8461	35.67	38.35	10.41	34.7	49.73	74	24.27	Peak
	9613	35.87	38.4	11.2	34.64	50.83	74	23.17	Peak

**802.11n20 CH2437MHz**

Polarization	Frequency (MHz)	Meter Reading dB (μV)	Antenna Factor (dB/m)	Cable Loss (dB)	Preamp Factor (dB)	Emission Level dB (μV/m)	Limits dB (μV/m)	Margin (dB)	Remark
Horizontal	3016	41.03	30.2	5.86	35.39	41.7	74	32.3	Peak
	4870	38.43	33.1	7.6	34.75	44.38	74	29.62	Peak
	4870	29.34	33.1	7.6	34.75	35.29	54	18.71	Average
	6778	36.32	35.4	9.02	34.72	46.02	74	27.98	Peak
	8398	36.49	38.3	10.36	34.7	50.45	74	23.55	Peak
	9766	36.1	38.2	11.32	34.62	51	74	23	Peak
Vertical	3106	40.8	30.62	5.95	35.36	42.01	74	31.99	Peak
	4870	38.68	33.1	7.6	34.75	44.63	74	29.37	Peak
	4870	30.37	33.1	7.6	34.75	36.32	54	17.68	Average
	6823	36.2	35.53	9.02	34.72	46.03	74	27.97	Peak
	8551	35.9	38.4	10.45	34.7	50.05	74	23.95	Peak
	9847	36.56	38.3	11.32	34.62	51.56	74	22.44	Peak

TEST ENGINEER: Jarey

**Band-Edge:**

EUT : Downlight Temperature : 22°C  
 Model No. : CFIXCNLR6CRVD Humidity : 51%RH  
 Test Mode : Transmitting Date of Test : 2023.03.26

**802.11b CH2412MHz**

Polarization	Frequency (MHz)	Meter Reading dB (μV)	Antenna Factor (dB/m)	Cable Loss (dB)	Preamp Factor (dB)	Emission Level dB (μV/m)	Limits dB (μV/m)	Margin (dB)	Remark
Horizontal	2390	55.5	28.4	5.33	35.9	53.33	74	20.67	Peak
	2390	46.65	28.4	5.33	35.9	44.48	54	9.52	Average
Vertical	2390	54.53	28.4	5.33	35.9	52.36	74	21.64	Peak
	2390	43.25	28.4	5.33	35.9	41.08	54	12.92	Average

**802.11b CH2462MHz**

Polarization	Frequency (MHz)	Meter Reading dB (μV)	Antenna Factor (dB/m)	Cable Loss (dB)	Preamp Factor (dB)	Emission Level dB (μV/m)	Limits dB (μV/m)	Margin (dB)	Remark
Horizontal	2483.5	53.36	28.44	5.4	35.82	51.38	74	22.62	Peak
	2483.5	44.24	28.44	5.4	35.82	42.26	54	11.74	Average
Vertical	2483.5	50.12	28.44	5.4	35.82	48.14	74	25.86	Peak
	2483.5	42.42	28.44	5.4	35.82	40.44	54	13.56	Average

**802.11g CH2412MHz**

Polarization	Frequency (MHz)	Meter Reading dB (μV)	Antenna Factor (dB/m)	Cable Loss (dB)	Preamp Factor (dB)	Emission Level dB (μV/m)	Limits dB (μV/m)	Margin (dB)	Remark
Horizontal	2390	62.51	28.4	5.33	35.9	60.34	74	13.66	Peak
	2390	48.14	28.4	5.33	35.9	45.97	54	8.03	Average
Vertical	2390	58.8	28.4	5.33	35.9	56.63	74	17.37	Peak
	2390	46.18	28.4	5.33	35.9	44.01	54	9.99	Average

**802.11g CH2462MHz**

Polarization	Frequency (MHz)	Meter Reading dB (μV)	Antenna Factor (dB/m)	Cable Loss (dB)	Preamp Factor (dB)	Emission Level dB (μV/m)	Limits dB (μV/m)	Margin (dB)	Remark
Horizontal	2483.5	58.98	28.44	5.4	35.82	57	74	17	Peak
	2483.5	44.6	28.44	5.4	35.82	42.62	54	11.38	Average
Vertical	2483.5	57.53	28.44	5.4	35.82	55.55	74	18.45	Peak
	2483.5	43.26	28.44	5.4	35.82	41.28	54	12.72	Average

**802.11n20 CH2412MHz**

Polarization	Frequency (MHz)	Meter Reading dB (µV)	Antenna Factor (dB/m)	Cable Loss (dB)	Preamp Factor (dB)	Emission Level dB (µV/m)	Limits dB (µV/m)	Margin (dB)	Remark
Horizontal	2390	63.99	28.4	5.33	35.9	61.82	74	12.18	Peak
	2390	46.9	28.4	5.33	35.9	44.73	54	9.27	Average
Vertical	2390	59.63	28.4	5.33	35.9	57.46	74	16.54	Peak
	2390	44.26	28.4	5.33	35.9	42.09	54	11.91	Average

**802.11n20 CH2462MHz**

Polarization	Frequency (MHz)	Meter Reading dB (µV)	Antenna Factor (dB/m)	Cable Loss (dB)	Preamp Factor (dB)	Emission Level dB (µV/m)	Limits dB (µV/m)	Margin (dB)	Remark
Horizontal	2483.5	57.78	28.44	5.4	35.82	55.8	74	18.2	Peak
	2483.5	45.38	28.44	5.4	35.82	43.4	54	10.6	Average
Vertical	2483.5	52.65	28.44	5.4	35.82	50.67	74	23.33	Peak
	2483.5	42.37	28.44	5.4	35.82	40.39	54	13.61	Average

TEST ENGINEER: Jarey

## 5 MAXIMUM PEAK OUTPUT POWER MEASUREMENT

### 5.1 Test Equipment

The following test equipment was used during the maximum peak output power measurement:

Item	Type	Manufacturer	Model No.	Serial No.	Cal. Date	Cal. Interval
1.	Spectrum Analyzer	Agilent	N9010A	MY52221182	2022.09.15	1 Year
2.	Coaxial Cable	WOKEN	SFL402-105F LEX	F02-150819-045	2023.02.22	1 Year
3.	20 dB Attenuator	Mini-Circuits	BW-S20W2+	001	2022.08.06	1 Year

### 5.2 Block Diagram of Test Setup

The Same as Section. 5.2.

### 5.3 Specification Limits ((§15.247(b)(3))

The Limits of maximum Peak Output Power for digital modulation in 2400-2483.5 MHz is: 1 Watt. (30 dBm)

### 5.4 Operating Condition of EUT

The software as section 2.3 was used to enable the EUT to change the test mode one by one.

### 5.5 Test Procedure

The transmitter output was connected to the spectrum analyzer.

The following procedure can be used when the maximum available RBW of the instrument is less than the DTS bandwidth:

- a) Set the RBW = 1 MHz.
- b) Set the VBW  $\geq$  [3 RBW].
- c) Set the span  $\geq$  [1.5 DTS bandwidth].
- d) Detector = peak.
- e) Sweep time = auto couple.
- f) Trace mode = max hold.
- g) Allow trace to fully stabilize.
- h) Use the instrument's band/channel power measurement function with the band limits set equal to the DTS bandwidth edges (for some instruments, this may require a manual override to select the peak detector). If the instrument does not have a band power function, then sum the spectrum levels (in linear power units) at intervals equal to the RBW extending across the DTS channel bandwidth

The test procedure is defined in ANSI C63.10-2013 ( 11.9.1.2 Measurement Procedure “ Integrated band power method” was used)

## 5.6 Test Results

**PASSED.**

All the test results are listed below.

(Test Date: 2023.03.29 Temperature: 23°C Humidity: 51 %)

Mode	Channel	Frequency (MHz)	Maximum conducted Peak Output Power (dBm)	Limit
802.11b	1	2412	<b>23.49</b>	30 dBm
	6	2437	<b>23.12</b>	30 dBm
	11	2462	<b>22.95</b>	30 dBm
802.11g	1	2412	<b>23.24</b>	30 dBm
	6	2437	<b>25.1</b>	30 dBm
	11	2462	<b>21.53</b>	30 dBm
802.11n20	1	2412	<b>22.4</b>	30 dBm
	6	2437	<b>24.37</b>	30 dBm
	11	2462	<b>21.67</b>	30 dBm



### 802.11b CH2412MHz



### 802.11b CH2437MHz



### 802.11b CH2462MHz



### 802.11g CH2412MHz

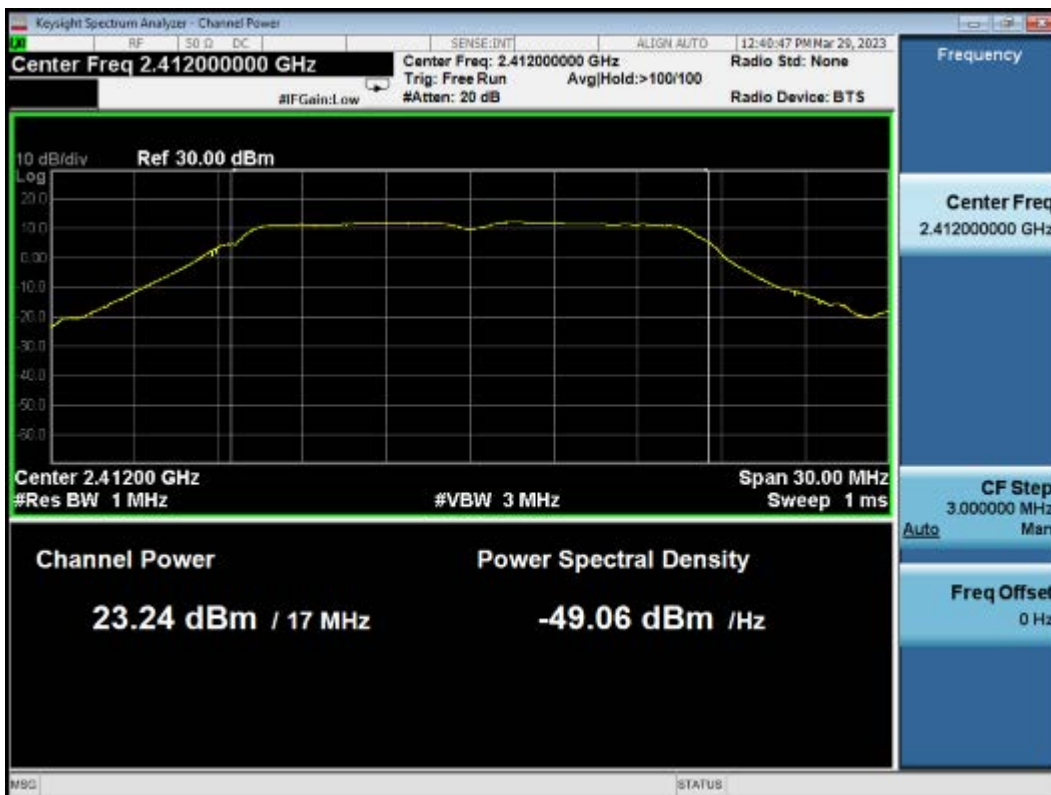

### 802.11g CH2437MHz

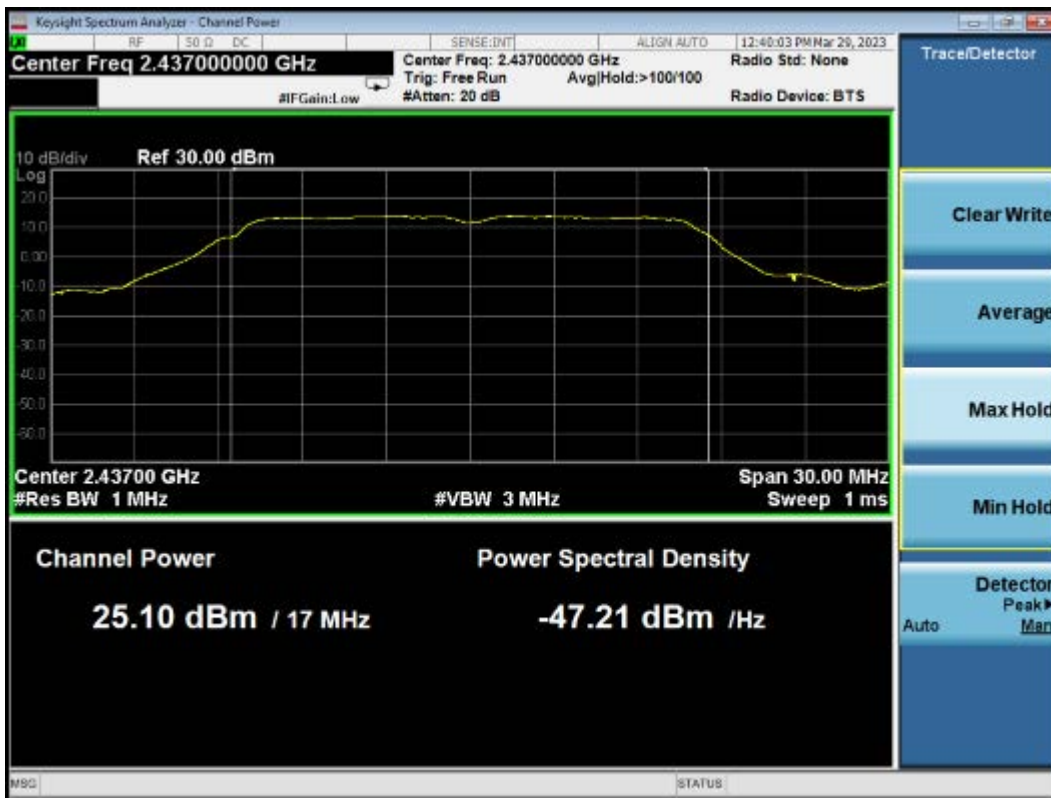

### 802.11g CH2462MHz

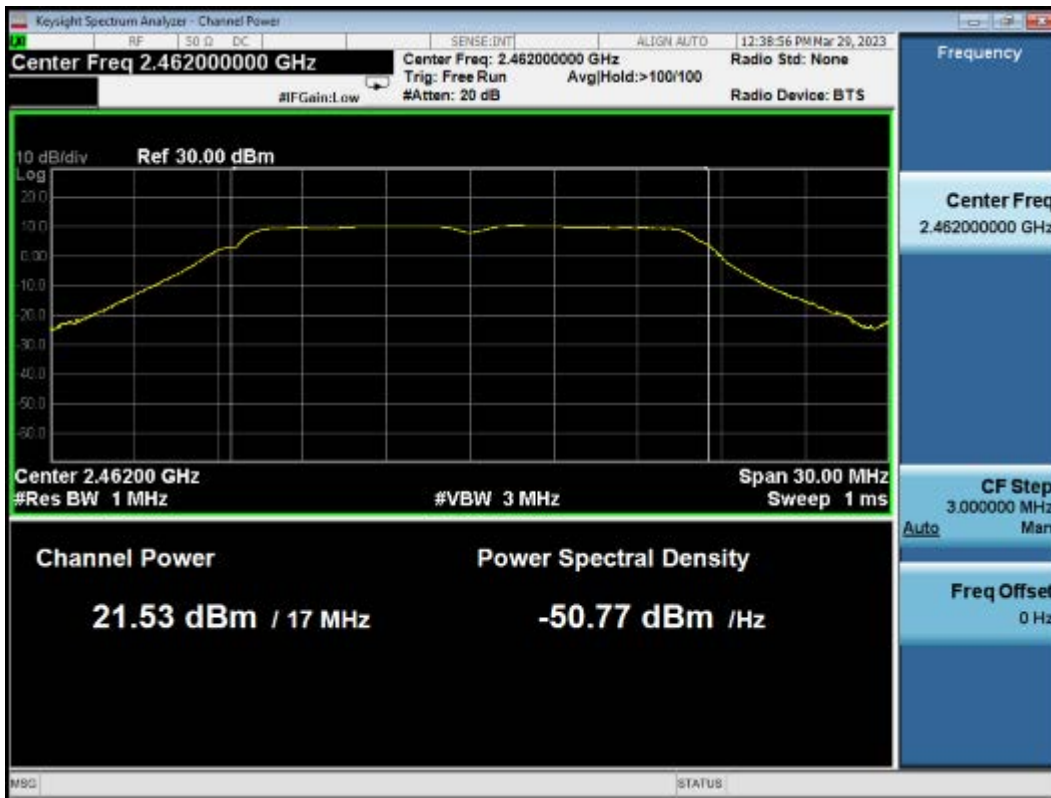

### 802.11n20 CH2412MHz

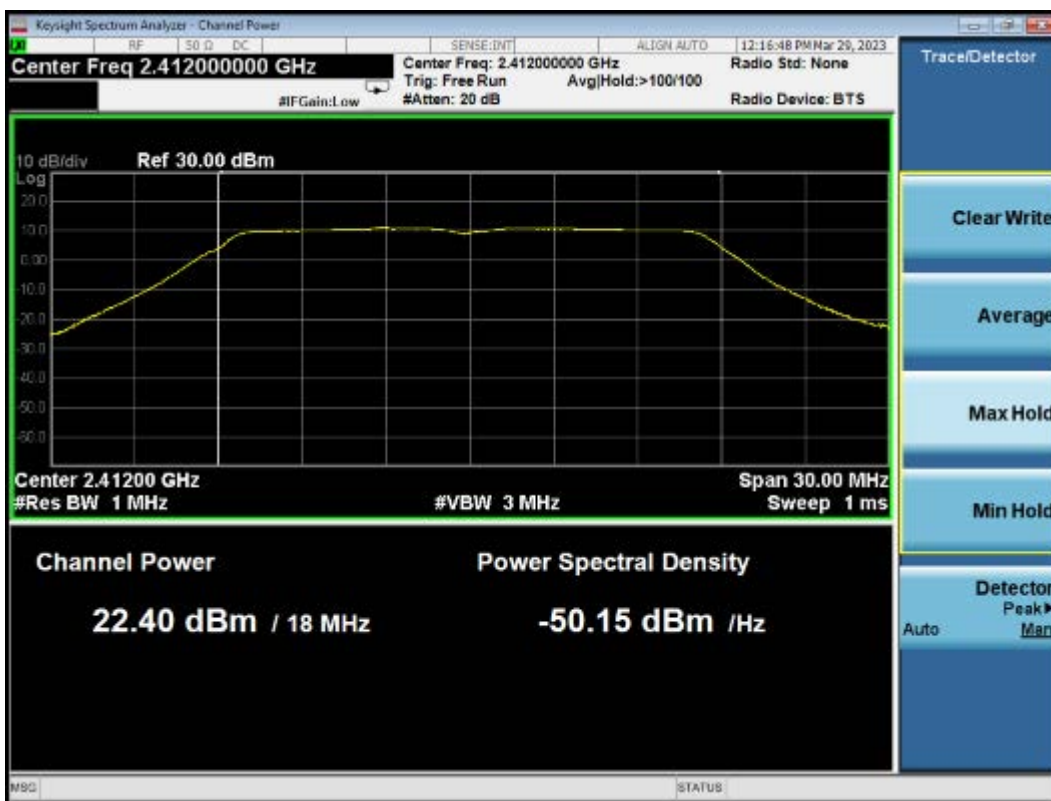

### 802.11n20 CH2437MHz

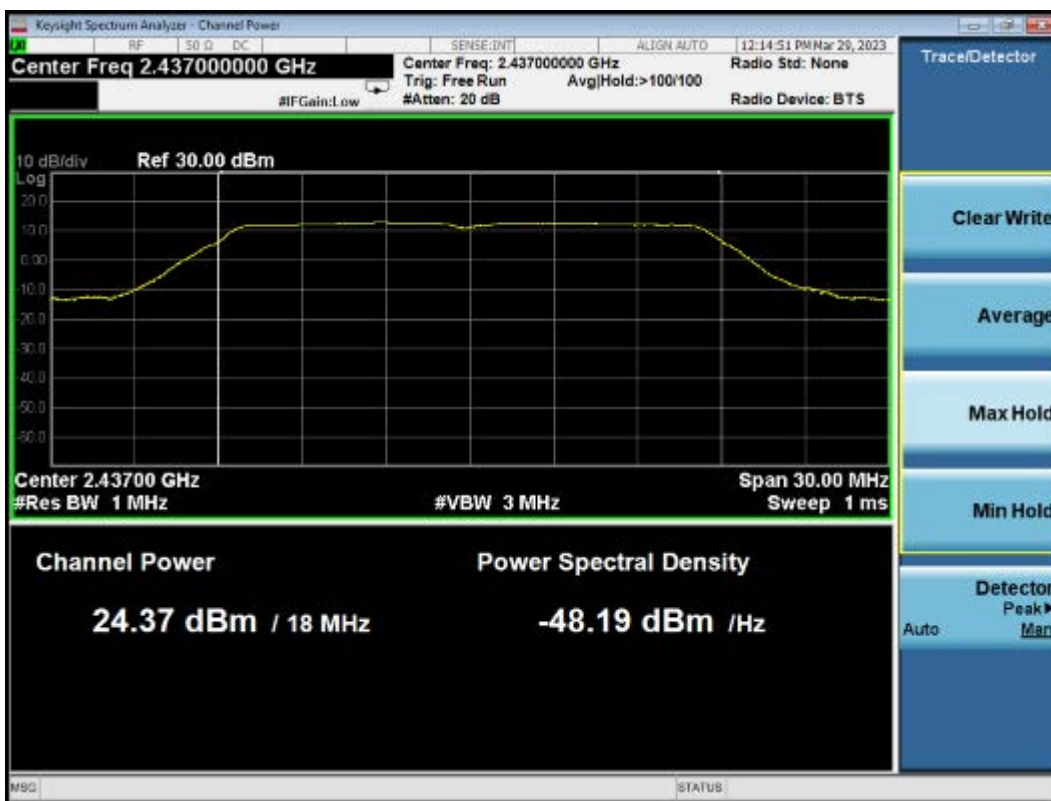

### 802.11n20 CH2462MHz





## 6 BANDEDGE MEASUREMENT

### 6.1 Test Equipment

The following test equipment was used during the emission limitations test:

Item	Type	Manufacturer	Model No.	Serial No.	Cal. Date	Cal. Interval
1.	Spectrum Analyzer	Agilent	N9010A	MY52221182	2022.09.15	1 Year
2.	Coaxial Cable	WOKEN	SFL402-105F LEX	F02-150819-045	2023.02.22	1 Year
3.	20 dB Attenuator	Mini-Circuits	BW-S20W2+	001	2022.08.06	1 Year

### 6.2 Block Diagram of Test Setup

The Same as Section. 5.2.

### 6.3 Specification Limits (§15.247(d))

In any 100 kHz bandwidth outside the frequency band in which the spread spectrum or digitally modulated intentional radiator is operating, the radio frequency power that is produced by the intentional radiator shall be at least 20 dB below that in the 100 kHz bandwidth within the band that contains the highest level of the desired power, based on either an RF conducted or a radiated measurement, provided the transmitter demonstrates compliance with the peak conducted power limits. If the transmitter complies with the conducted power limits based on the use of RMS averaging over a time interval, as permitted under paragraph (b)(3) of this section, the attenuation required under this paragraph shall be 30 dB instead of 20 dB. Attenuation below the general limits specified in §15.209(a) is not required.

In addition, radiated emissions which fall in the restricted bands, as defined in §15.205(a), must also comply with the radiated emission limits specified in §15.209(a) (see §15.205(c)). (※This test result attaching to Section. 3.7)

### 6.4 Operating Condition of EUT

The software as section 2.3 was used to enable the EUT to change the test mode one by one.

### 6.5 Test Procedure

The transmitter output was connected to the spectrum analyzer.

Establish a reference level by using the following procedure:

- a) Set instrument center frequency to DTS channel center frequency.
- b) Set the span to  $\geq 1.5$  times the DTS bandwidth.
- c) Set the RBW = 100 kHz.
- d) Set the VBW  $\geq [3 \times \text{RBW}]$ .
- e) Detector = peak.
- f) Sweep time = auto couple.
- g) Trace mode = max hold.
- h) Allow trace to fully stabilize.
- i) Use the peak marker function to determine the maximum PSD level.

Note that the channel found to contain the maximum PSD level can be used to

establish the reference level.

Establish an emission level by using the following procedure:

- a) Set the center frequency and span to encompass frequency range to be measured.
- b) Set the RBW = 100 kHz.
- c) Set the VBW  $\geq [3 \times \text{RBW}]$ .
- d) Detector = peak.
- e) Sweep time = auto couple.
- f) Trace mode = max hold.
- g) Allow trace to fully stabilize.
- h) Use the peak marker function to determine the maximum amplitude level.

Ensure that the amplitude of all unwanted emissions outside of the authorized frequency band (excluding restricted frequency bands) is attenuated by at least the minimum requirements specified in 11.11. Report the three highest emissions relative to the limit.

Scan up through 10<sup>th</sup> harmonic.

The test procedure is defined in ANSI C63.10-2013 (11.11.2 Reference level measurement and 11.11.3 Emission level measurement was used).

## 6.6 Test Results

**PASSED.**

The test data was attached in the next pages.

(Test Date: 2023.03.29 Temperature: 23°C Humidity: 51 %)



802.11b CH2412MHz

Reference level



Band edge Emission

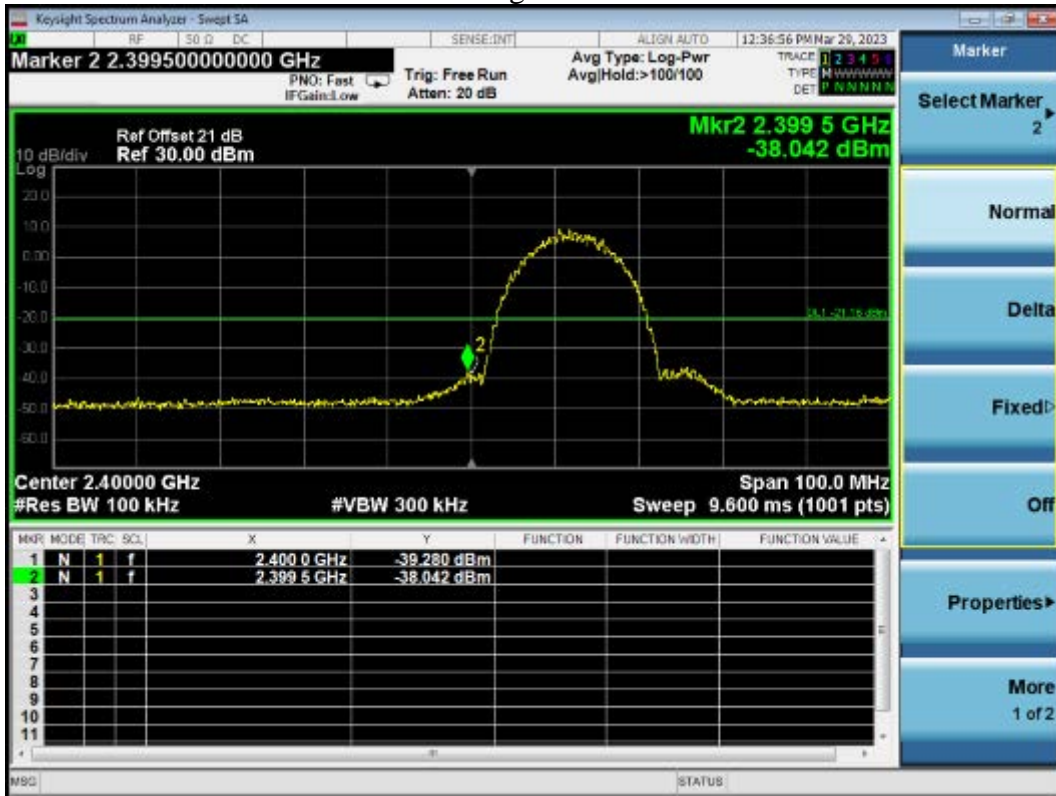

802.11b CH2462MHz

Reference level



Band edge Emission

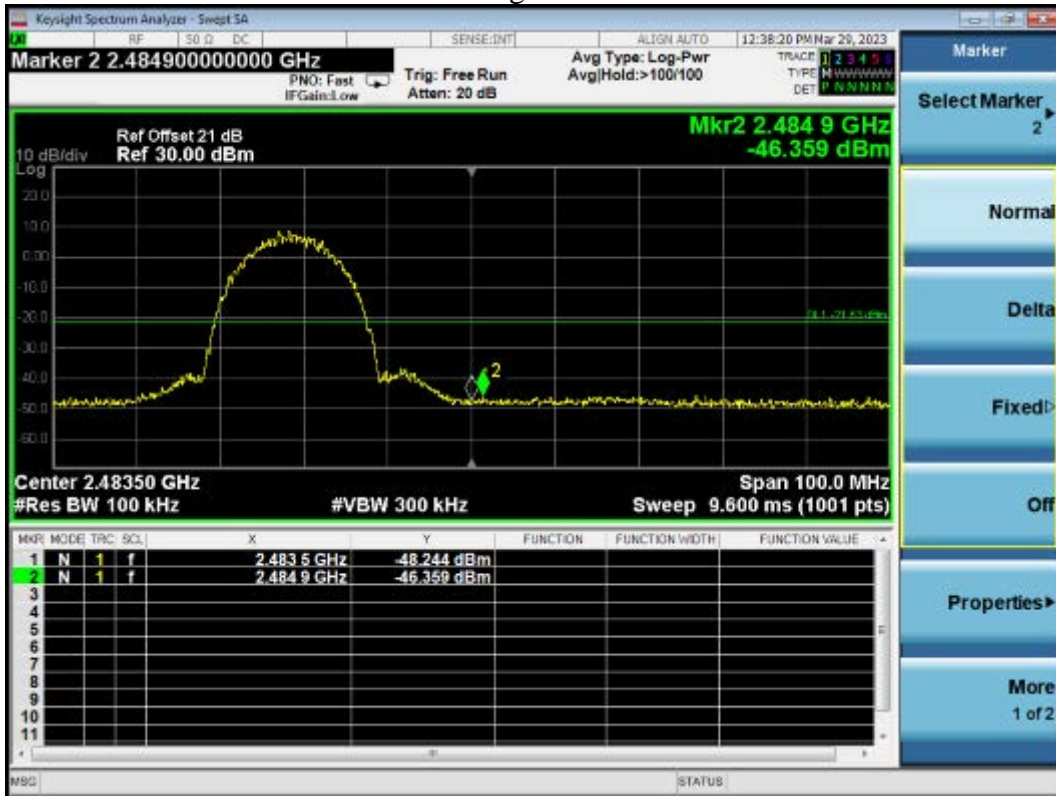

802.11g CH2412MHz

Reference level



Band edge Emission

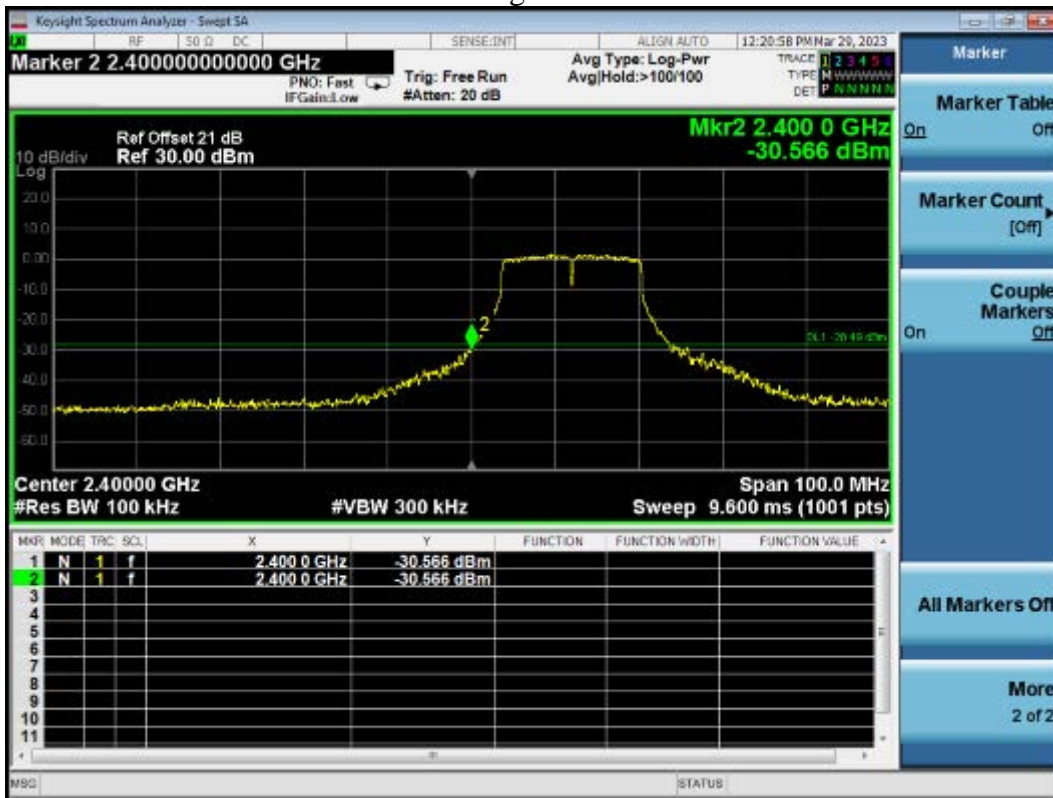

802.11g CH2462MHz

Reference level

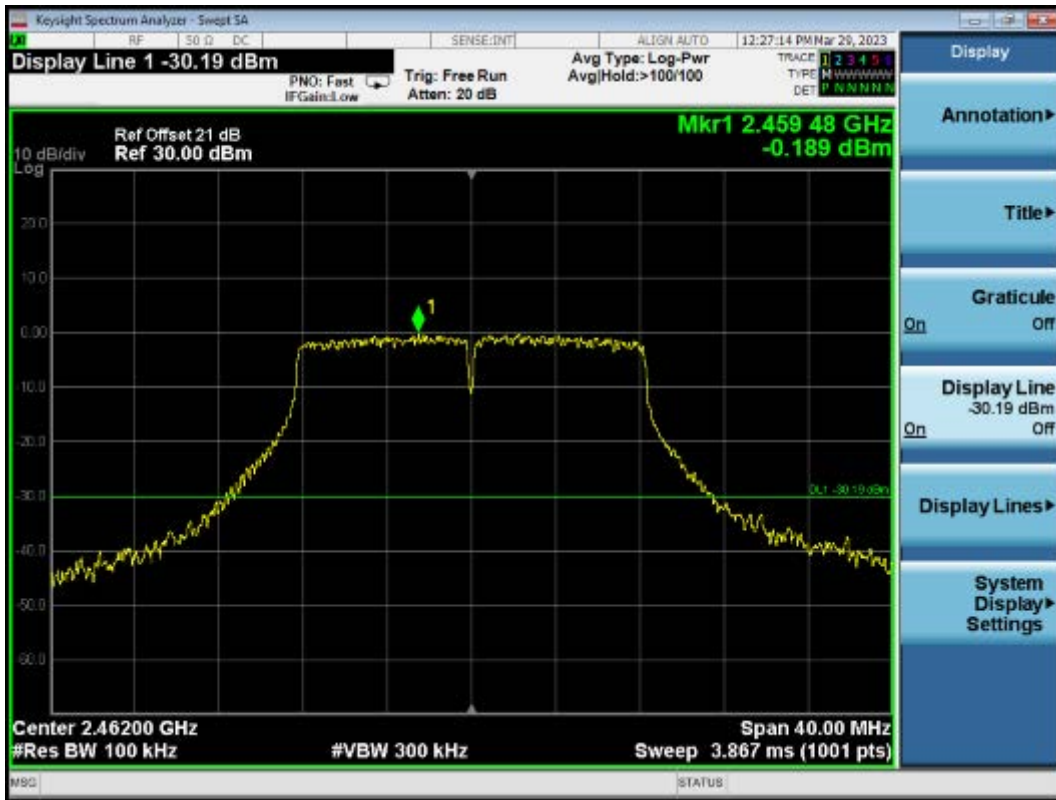

Band edge Emission

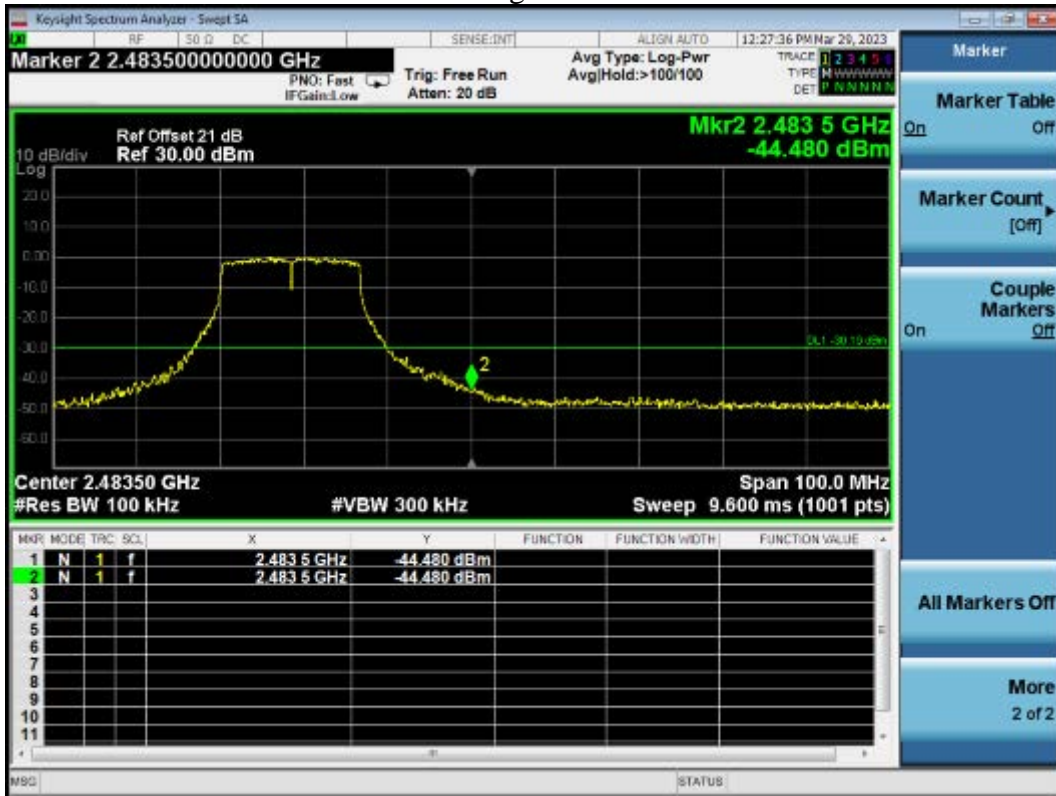



802.11n20 CH2412MHz

Reference level



Band edge Emission

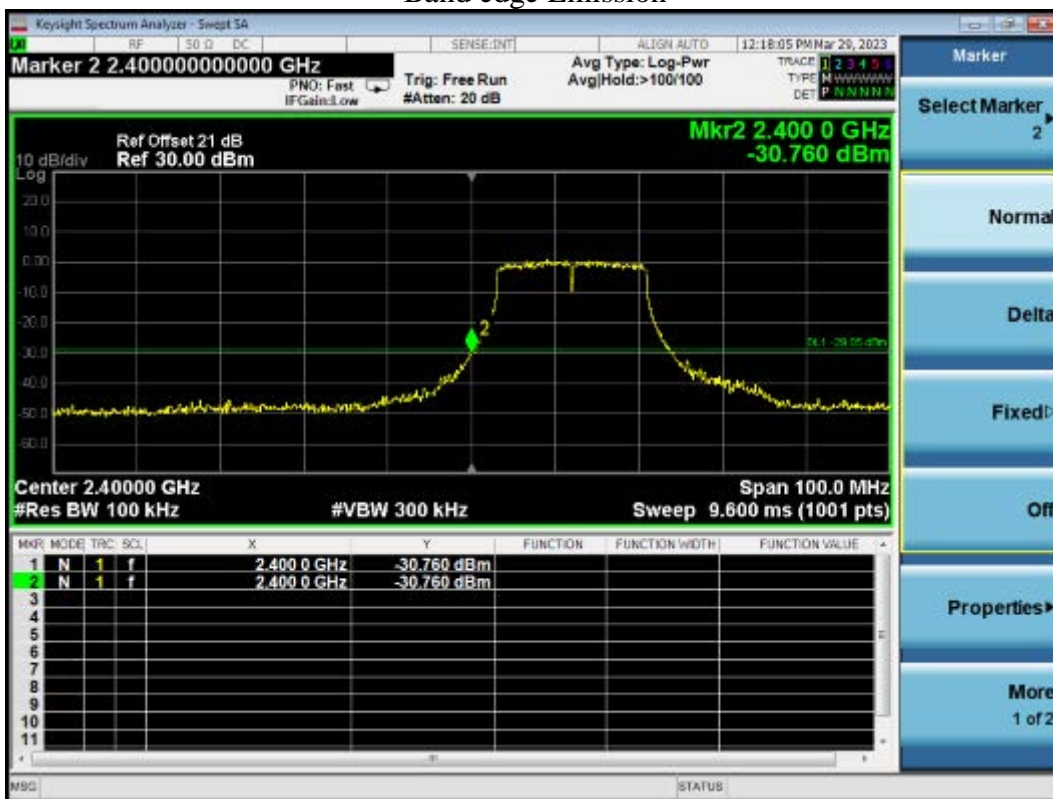

802.11n20 CH2462MHz

Reference level

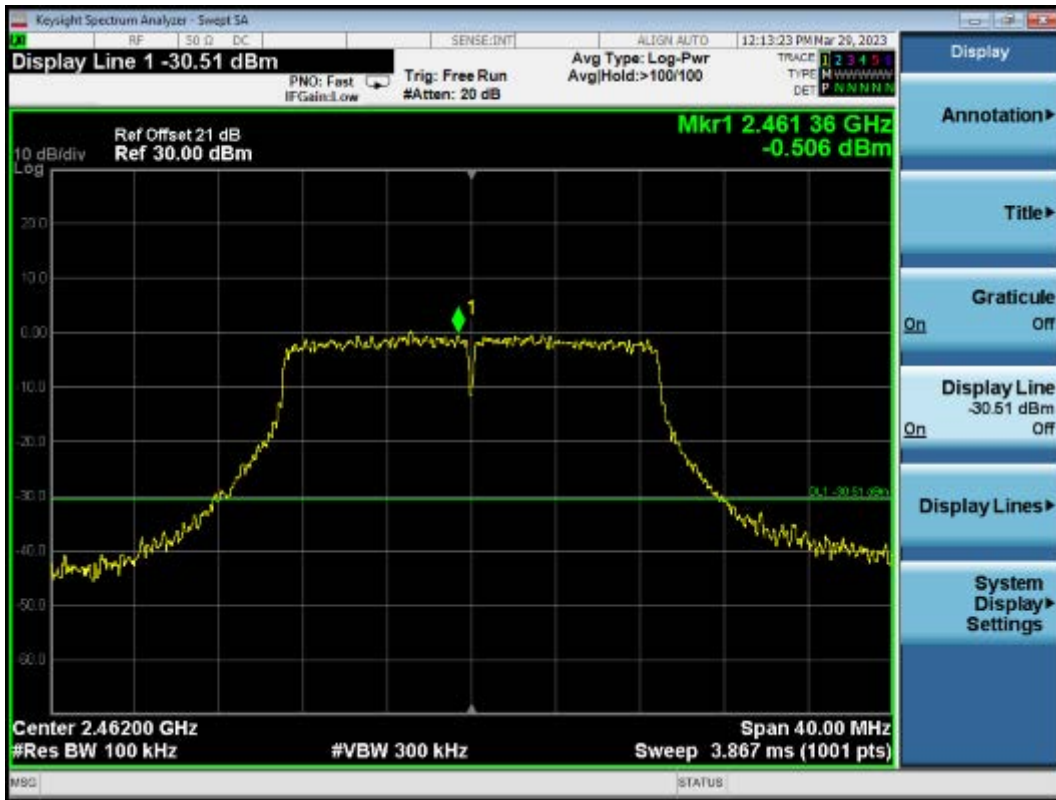

Band edge Emission

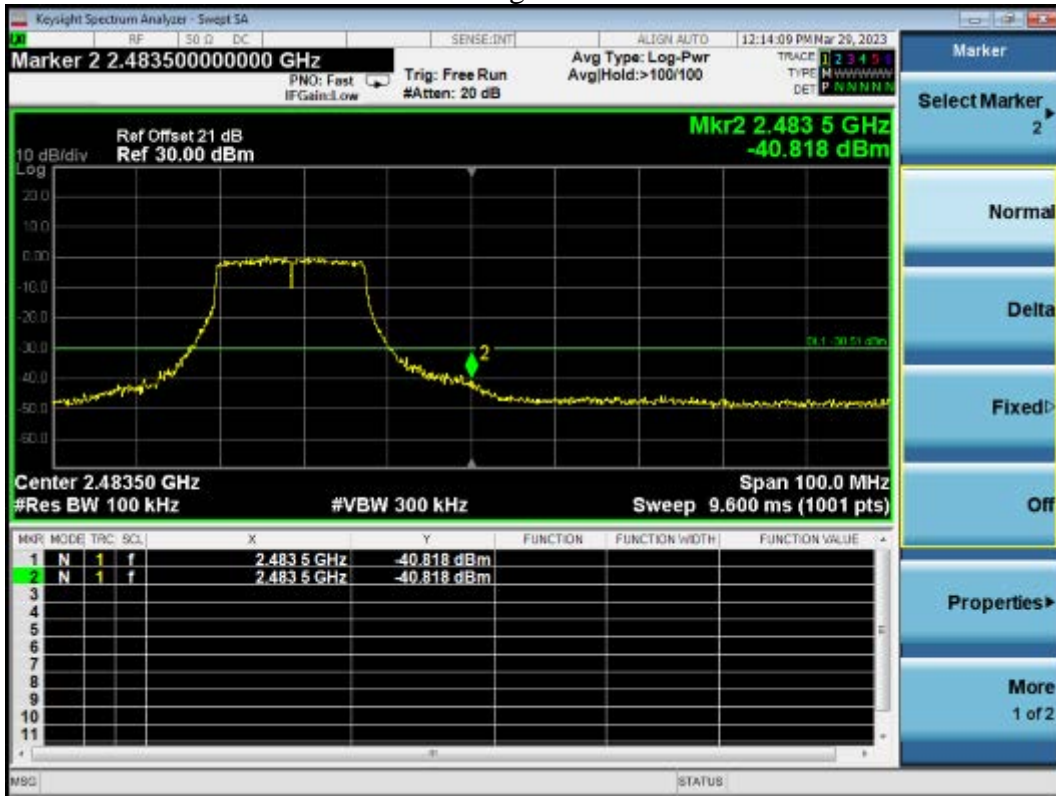

## 7 MEASUREMENT UNCERTAINTY LIST

The measurement uncertainty was estimated for test on the EUT according to CISPR 16-4-2. This uncertainty represents an expanded uncertainty expressed at approximately the 95% confidence level using a coverage of K=2.

The uncertainties value is not used in determining the PASS/FAIL results.

Test Items/Facilities	Frequency/Equipment/Unit	Uncertainty
Conducted Emission No.1 Shielded Room	9kHz~150kHz	±3.1 dB
	150kHz~30MHz	±2.6 dB
Conducted Emission No.3 Shielded Room	9kHz~150kHz	±3.1 dB
	150kHz~30MHz	±2.6 dB
Radiated Emission	30MHz~200MHz, Horizontal	±3.8 dB
	30MHz~200MHz, Vertical	±4.1 dB
	200MHz~1000MHz, Horizontal	±3.6 dB
	200MHz~1000MHz, Vertical	±5.1 dB
	1GHz~6GHz	±5.3 dB
	6GHz~18GHz	±5.3 dB
	18GHz~40GHz	±3.5 dB
Output Power Test	50MHz~18GHz	0.77 dB
Power Density Test	9kHz~6GHz	1.08 dB
RF Frequency Test	9kHz~40GHz	$6 \times 10^{-4}$
Bandwidth Test	9kHz~6GHz	$1.5 \times 10^{-3}$
RF Radiated Power Test	30MHz~1000MHz	3.06 dB
Conducted Output Power Test	50MHz~18GHz	0.83 dB
AC Voltage(<10kHz) Test	120V~230V	0.04 %
DC Power Test	0V~30V	0.4 %
Temperature	-40°C~+100°C	0.52 °C
Humidity	30%~95%	2.6 %