

TEST REPORT

On behalf of

Savant Technologies LLC, dba GE Lighting, a Savant company

Product Name: Downlight

Refer to Sec.2.1

FCC ID: PUU-CFIXCNLR6C1

Prepared For: Savant Technologies LLC, dba GE Lighting, a Savant company
1975 Noble Road, Cleveland, OH 44112

Prepared By: Audix Technology (Shanghai) Co., Ltd.
3F, 34Bldg, 680 Guiping Rd.,
Caohejing Hi-Tech Park,
Shanghai 200233, China

Tel: +86-21-64955500



File No. : C1D2303019
Report No. : ACI-F21278A2
Date of Test : 2023.03.16-29
Date of Report : 2023.04.17

The statement is based on a single evaluation of one sample of the above-mentioned products. It does not imply an assessment of the whole production and does not permit the use of the test lab logo. The report must not be used by the client to claim product certification, approval, or endorsement by NVLAP, NIST, or any agency of the Federal Government.

TABLE OF CONTENTS

	Page
1 SUMMARY OF STANDARDS AND RESULTS	4
1.1 Description of Standards and Results.....	4
2 GENERAL INFORMATION	5
2.1 Description of Equipment Under Test.....	5
2.2 EUT Specifications Assessed in Current Report.....	7
2.3 Test Information.....	7
2.4 Sample Description.....	7
2.5 Supported equipment.....	7
2.6 Description of Test Facility.....	8
3 CONDUCTED EMISSION TEST	9
3.1 Test Equipment.....	9
3.2 Block Diagram of Test Setup.....	9
3.3 Conducted Emission Limits (§15.207).....	10
3.4 Test Configuration.....	10
3.5 Operating Condition of EUT.....	10
3.6 Test Procedures.....	10
3.7 Test Results.....	11
4 RADIATED EMISSION TEST	13
4.1 Test Equipment.....	13
4.2 Block Diagram of Test Setup.....	13
4.3 Radiated Emission Limit (§15.209).....	14
4.4 Test Configuration.....	14
4.5 Operating Condition of EUT.....	15
4.6 Test Procedures.....	15
4.7 Test Results.....	16
5 MAXIMUM PEAK OUTPUT POWER MEASUREMENT	20
5.1 Test Equipment.....	20
5.2 Block Diagram of Test Setup.....	20
5.3 Specification Limits ((§15.247(b)(3)).....	20
5.4 Operating Condition of EUT.....	20
5.5 Test Procedure.....	20
5.6 Test Results.....	21
6 MEASUREMENT UNCERTAINTY LIST	24
APPENDIX I PHOTOGRAPHS OF TEST	
APPENDIX II PHOTOGRAPHS OF EUT	

TEST REPORT

Applicant : Savant Technologies LLC, dba GE Lighting, a Savant company
 EUT Description : Downlight
 (A) Model No. : Refer to Sec.2.1
 (B) Power Supply : 120V AC 60Hz
 (C) Test Voltage : 120V/60Hz

Test Procedure Used:

*FCC RULES AND REGULATIONS PART 15 SUBPART C
 AND ANSI C63.10-2013*

The device described above is tested by Audix Technology (Shanghai) Co., Ltd. to determine the maximum emission levels emanating from the device. The maximum emission levels are compared to the FCC Part 15 Subpart C limits.

The test results are contained in this test report and Audix Technology (Shanghai) Co., Ltd. is assumed full responsibility for the accuracy and completeness of these measurements. This report also shows that the EUT (M/N: Refer to Sec2.1), which was tested is technically compliance with the FCC limits.

This report applies to above tested Sample only. This report shall not be reproduced in part without written approval of Audix Technology (Shanghai) Co., Ltd.

The test results for EUT's WIFI function are contained in No.ACI-F21279A2 report.

Date of Test : 2023.03.16-29 Date of Report : 2023.04.17

Producer : 
 JAREY LU / Deputy Assistant Manager

Reviewer : 
 BYRON WU / Deputy Assistant Manager

 For and on behalf of
 Audix Technology (Shanghai) Co., Ltd.

Signatory : 
 Authorized Signature(s) KAMP CHEN / Manager

1 SUMMARY OF STANDARDS AND RESULTS

1.1 Description of Standards and Results

The EUT have been tested according to the applicable standards as referenced below:

Description / Test Item	Test Standard	Results	Meets Limit
EMISSION			
Conducted Emission	FCC RULES AND REGULATIONS PART 15 SUBPART C AND ANSI C63.10:2013	Pass	15.207
Radiated Emission	FCC RULES AND REGULATIONS PART 15 SUBPART C AND ANSI C63.10:2013	Pass	15.209(a) 15.205(a)(c)
6 dB Bandwidth Measurement	FCC RULES AND REGULATIONS PART 15 SUBPART C AND ANSI C63.10:2013	Pass	15.247(a)(2)
Maximum Peak Output Power Measurement	FCC RULES AND REGULATIONS PART 15 SUBPART C AND ANSI C63.10:2013	Pass	15.247(b)(3)
Emission Limitations Measurement	FCC RULES AND REGULATIONS PART 15 SUBPART C AND ANSI C63.10:2013	Pass	15.247(d)
Band Edge Measurement	FCC RULES AND REGULATIONS PART 15 SUBPART C AND ANSI C63.10:2013	Pass	15.247(d)
Power Spectral Density Measurement	FCC RULES AND REGULATIONS PART 15 SUBPART C AND ANSI C63.10:2013	Pass	15.247(e)
N/A is an abbreviation for Not Applicable.			

2 GENERAL INFORMATION

2.1 Description of Equipment Under Test

- Description : Downlight
- Type of EUT : Production Pre-product Pro-type
- Model Number : CFIXCNLR6C1, CFIXCNLR6CRVD, CFIXCNLR6C1@, CFIXCNLR6CRVD@
- Note#1 : @ Can be represented by any letters, numbers, or symbols, which means CRI, CCT, product color, packaging, or internal identification.
- Note#2 : The difference between the models as follows:

Model	Difference description 1
CFIXCNLR6C1	All the same except for CRI, CCT, product color, packaging, or internal identification
CFIXCNLR6C1@	
CFIXCNLR6CRVD	All the same except for CRI, CCT, product color, packaging, or internal identification
CFIXCNLR6CRVD@	

Model	Difference description 2
CFIXCNLR6C1, CFIXCNLR6C1@	The mechanistic housing is different.
CFIXCNLR6CRVD, CFIXCNLR6CRVD@	

- Note#3 : The modified histories of report are as follows:

Report No.	Model No.	Rev. Summary	Edition No.	Data of Rev.
ACI-F21278	CFIXCNLR6C1	Original Report	0	2021.12.29
ACI-F21278A1	CFIXCNLR6CRVD	Add the one model	Rev. A1	2022.08.23
ACI-F21278A2	CFIXCNLR6C1, CFIXCNLR6CRVD, CFIXCNLR6C1@, CFIXCNLR6CRVD@	1. Add the two models 2. Add new power driver 3. Change the product name	Rev. A2	2023.04.17

- Note#4 : According to the modification, we take a re-tested in the test item as following: Conducted Emissions, Radiated Emissions, Maximum Output Power, Band Edge Measurement. According to the re-tested result, we demonstrate that the EUT could be full compliance with the requirement of standards.

- Test model : CFIXCNLR6CRVD

Radio Tech : BLE 4.2;
IEEE 802.11 b/g/n.

Note: : 802.11n-HT40 not support.

Channel Freq. : BLE: 2402MHz-2480MHz;
802.11b/g/n: 2412MHz-2462MHz.

Modulation : BLE: GFSK;
802.11b: DSSS (CCK, DQPSK, DBPSK);
802.11g/n: OFDM (64QAM, 16QAM, QPSK, BPSK).

Antenna Info. : Antenna Type: PCB Antenna
Antenna Gain: 0.5 dBi
The Antenna was a permanently attached antenna
that is comply with 15.203 requirement.

Applicant : Savant Technologies LLC, dba GE Lighting, a Savant company
1975 Noble Road, Cleveland, OH 44112

Manufacturer : same as Applicant

Factory : Foshan Electrical and Lighting Co., Ltd. Gaoming
Branch
Hecheng Street, Cangjiang Industrial Park, Gaoming
District Foshan Guangdong 528000 CHINA

2.2 EUT Specifications Assessed in Current Report

Mode	Modulation	Data Rate(Mbps)
BLE	GFSK	1

Channel List			
Channel No.	Frequency (MHz)	Channel No.	Frequency (MHz)
00	2402	20	2442
01	2404	21	2444
02	2406	22	2446
...
...
...
17	2436	37	2476
18	2438	38	2478
19	2440	39	2480

2.3 Test Information

The test software “RTLBTAPP.exe” was used to control EUT work in TX mode, Power Setting and select test channel.

Modulation	data rate (Mbps)	Power Setting	Test Channel		Frequency (MHz)
BLE	1	Default	Low:	00	2402
		Default	Middle:	20	2442
		Default	High:	39	2480

2.4 Sample Description

Test Item	Model Number	Sample Number	Date of receipted
Conducted Emission	CFIXCNLR6CRVD	E2303210-01/03	2023.03.10
Radiated Emission	CFIXCNLR6CRVD	E2303214a1-02/02	2023.03.10
Conducted RF Test	CFIXCNLR6CRVD	E2303214a2-02/02	2023.03.10

2.5 Supported equipment

Brand : Acer
 Product Name: : Notebook PC
 Model Name : TravelMate P238 series
 Model Number : N15W8

Product Name : Test Fixture
 Product Function : USB to TTL

2.6 Description of Test Facility

Name of Firm : Audix Technology (Shanghai) Co., Ltd.

Site Location : 3F, 34Bldg, 680 Guiping Rd., Caohejing
Hi-Tech Park,
Shanghai 200233, China.

Accredited by NVLAP, Lab Code : 200371-0

FCC Designation Number : CN5027

Test Firm Registration Number : 954668

3 CONDUCTED EMISSION TEST

3.1 Test Equipment

The following test equipments are used during the conducted emission test in a shielded room:

Item	Type	Manufacturer	Model No.	Serial No.	Cal. Date	Cal. Interval
1.	Test Receiver	R&S	ESCI	101302	2023.02.22	1 Year
2.	Artificial Mains Network (AMN)	R&S	ESH2-Z5	843890/011	2023.02.22	1 Year
3.	CE Cable	Audix+ANRIT SU	CE Cable+MP59 B	CE-SH1-001+6200655086	2023.02.22	1 Year
4.	Software	Audix	e3	6.2009-1-15	--	--

3.2 Block Diagram of Test Setup

3.2.1 Conducted Disturbance Test Setup

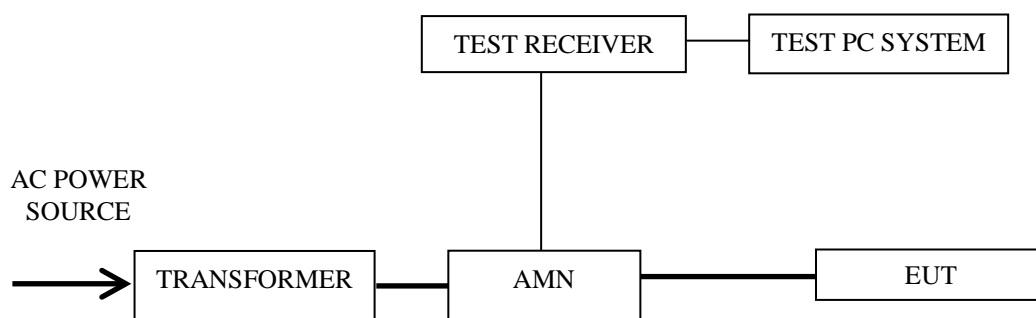

— : Signal Line
 — : Power Line

3.3 Conducted Emission Limits (§15.207)

Frequency Range (MHz)	Limits dB(μV)	
	Quasi-peak	Average
0.15 ~ 0.5	66~56	56~46
0.5 ~ 5	56	46
5 ~ 30	60	50
NOTE 1 – The lower limit shall apply at the transition frequencies. NOTE 2 – The limit decreases linearly with the logarithm of the frequency in the range 0.15 MHz~0.50 MHz		

3.4 Test Configuration

The EUT (listed in Sec.2.1) was installed as shown on Sec.3.2 to meet FCC requirement and operating in a manner which tends to maximize its emission level in a normal application.

3.5 Operating Condition of EUT

- 3.5.1 Setup the EUT as shown in Sec. 3.2.
- 3.5.2 Turn on the power of all equipment.
- 3.5.3 Turn the EUT on the test mode, and then test.

3.6 Test Procedures

The EUT was placed upon a non-metallic table, which is 0.8 m above the horizontal conducting ground plane and 0.4 m from a vertical reference plane. The EUT was connected to the power mains through an Artificial Mains Network (AMN) to provide a 50 Ω coupling impedance for the measuring equipment. Both sides of AC line (Line & Neutral) were checked to find out the maximum conducted emission according to FCC Part 15 Subpart C and ANSI C63.10: 2013 requirements during conducted disturbance test.

The I.F. bandwidth of Test Receiver ESCI was set at 9 kHz.

The frequency range from 150 kHz to 30 MHz was checked.

Test with a dummy load in lieu of the antenna to determine compliance with Section 15.207 limits within the transmitter's fundamental emission band. (According to KDB 174176 D01 Line Conducted FAQ)

The test modes were done on conducted disturbance test and all the test results are listed in Sec. 3.7

3.7 Test Results

< **PASS** >

The frequency and amplitude of the highest conducted emission relative the limit is reported. All the emissions not reported below are too low against the FCC limit.

Worst case emission:

No.	Operation	Mode	Channel	Frequency (MHz)	Data Page
1.	Transmitting	BLE	00	2402	P12

NOTE 1 – Emission Level = Read Level + AMN Factor + Cable Loss,
Margin = Limits - Emission Level

NOTE 2 – “QP” means “Quasi-Peak” values

NOTE 3 – The emission levels which not reported are too low against the official limit.

Worst case emission

EUT : Downlight Temperature 22°C

Model No. : CFIXCNLR6CRVD Humidity 51%RH

Test Mode : Transmitting Date of Test 2023.03.16

Polarization	Frequency (MHz)	Meter Reading dB (µV)	AMN Factor (dB)	Cable Loss (dB)	Emission Level dB (µV)	Limits dB (µV)	Margin (dB)	Remark
Line	0.15	53.5	0.1	0.03	53.63	66	12.37	QP
	0.15	38.3	0.1	0.03	38.43	56	17.57	Average
	0.2094	39.87	0.1	0.03	40	63.23	23.23	QP
	0.2094	29.43	0.1	0.03	29.56	53.23	23.67	Average
	0.2773	37.26	0.1	0.03	37.39	60.9	23.51	QP
	0.2773	21.3	0.1	0.03	21.43	50.9	29.47	Average
	0.6613	32.39	0.2	0.05	32.64	56	23.36	QP
	0.6613	19.32	0.2	0.05	19.57	46	26.43	Average
	3.901	23.36	0.3	0.12	23.78	56	32.22	QP
	3.901	12.42	0.3	0.12	12.84	46	33.16	Average
	15.885	34.77	0.6	0.25	35.62	60	24.38	QP
	15.885	19.28	0.6	0.25	20.13	50	29.87	Average
Neutral	0.15	53.8	0.1	0.03	53.93	66	12.07	QP
	0.15	40.7	0.1	0.03	40.83	56	15.17	Average
	0.2094	40.53	0.1	0.03	40.66	63.23	22.57	QP
	0.2094	29.35	0.1	0.03	29.48	53.23	23.75	Average
	0.2788	36.86	0.1	0.03	36.99	60.85	23.86	QP
	0.2788	21.49	0.1	0.03	21.62	50.85	29.23	Average
	0.6613	31.98	0.1	0.05	32.13	56	23.87	QP
	0.6613	19.44	0.1	0.05	19.59	46	26.41	Average
	3.901	24.07	0.29	0.12	24.48	56	31.52	QP
	3.901	11.31	0.29	0.12	11.72	46	34.28	Average
	13.695	31.67	0.38	0.23	32.28	60	27.72	QP
	13.695	18.37	0.38	0.23	18.98	50	31.02	Average

TEST ENGINEER: Jarey

4 RADIATED EMISSION TEST

4.1 Test Equipment

The following test equipment are used during the radiated emission test in a semi-anechoic chamber:

Item	Type	Manufacturer	Model No.	Serial No.	Cal. Date	Cal. Interval
1.	Preamplifier	Agilent	8447D	2944A10548	2022.06.06	1 Year
2.	Preamplifier	HP	8449B	3008A00864	2022.06.06	1 Year
3.	Spectrum Analyzer	Agilent	N9010A	MY52221182	2022.09.15	1 Year
4.	Test Receiver	R&S	ESCI	101303	2022.06.07	1 Year
5.	Bilog Antenna+6dB Attenuator	Schwarz beck	VULB 9168+EMCI-N-6-06	707+AT-N0637	2022.07.25	1 Year
6.	Horn Antenna	EMCO	3115	9607-4878	2022.07.21	1 Year
7.	Horn Antenna	EMCO	3116	00062643	2022.12.12	1 Year
8.	Coaxial Cable	SCHAFFNER	RG 212U-MIL C 17+N1K50-EW 0630-N1K50-1 5m-1	RE-10m-001/R E-15m-002	2023.02.22	1 Year
9.	Cavity Band Rejection Filter	Microwave	WT-A3882-R 10	WT200312-1-1	2022.06.06	1 Year
10.	Software	Audix	e3	6.111206	--	--

4.2 Block Diagram of Test Setup

4.2.1 EUT & Peripherals



4.2.2 Below 1GHz

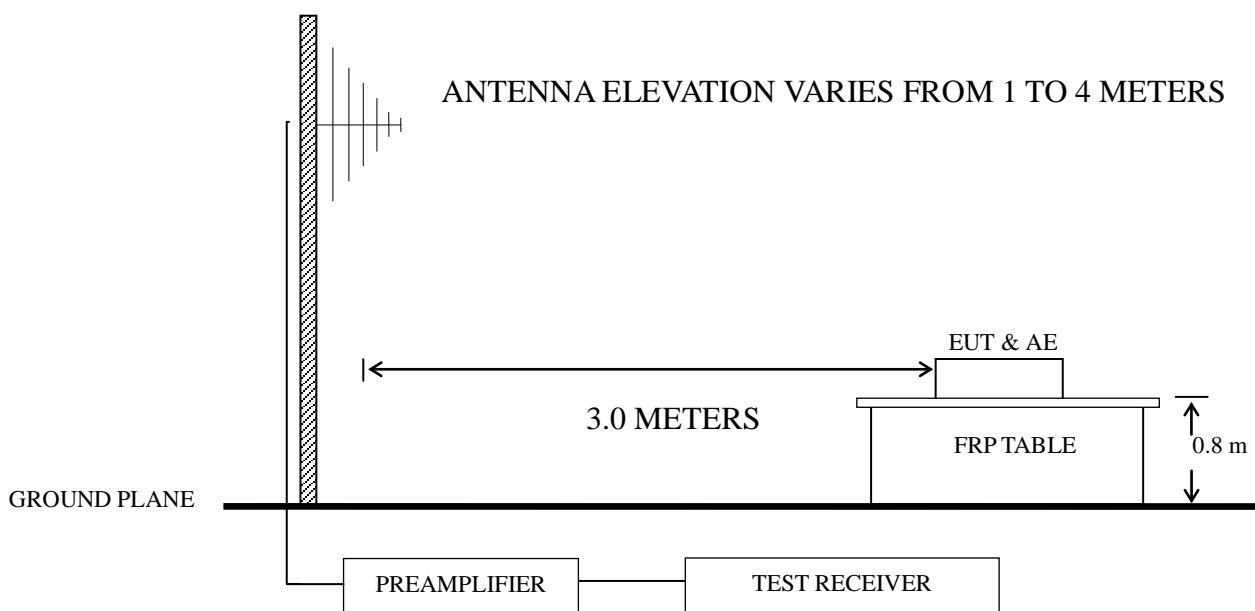

4.2.3 Above 1GHz

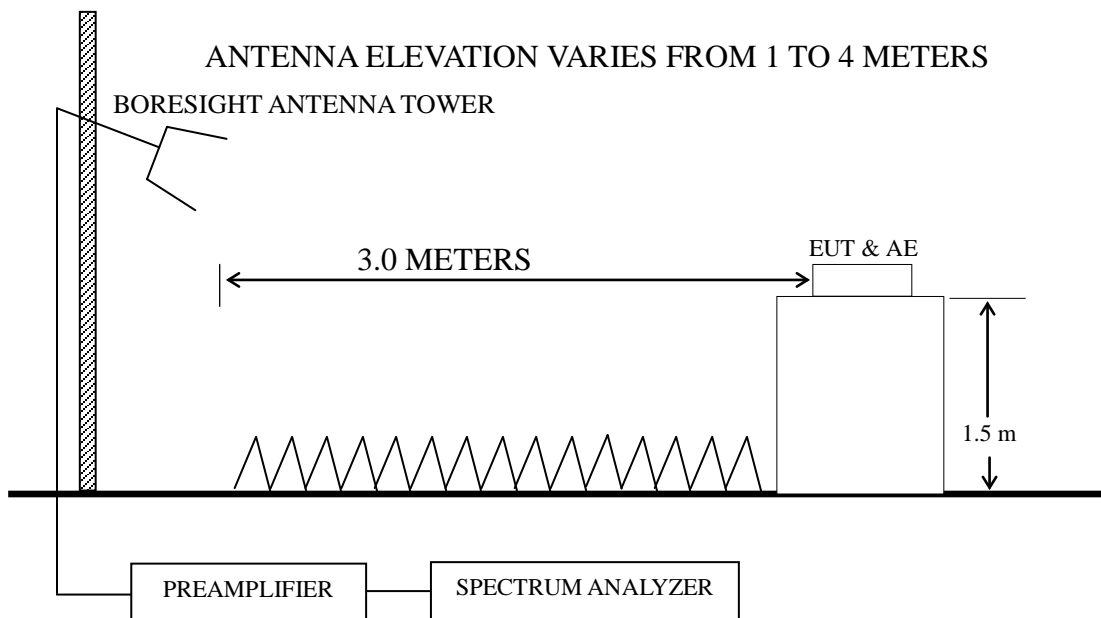

4.3 Radiated Emission Limit (§15.209)

Frequency (MHz)	Distance (m)	Field strength limits (µV/m)	
		(µV/m)	dB(µV/m)
30 ~ 88	3	100	40.0
88 ~ 216	3	150	43.5
216 ~ 960	3	200	46.0
Above 960	3	500	54.0

NOTE 1 - Emission Level dB (µV/m) = 20 log Emission Level (µV/m)

NOTE 2 - The tighter limit applies at the band edges.

NOTE 3 - Distance refers to the distance in meters between the measuring instrument antenna and the closed point of any part of the device or system.

NOTE 4 - The limits shown are based on Quasi-peak value detector below or equal to 1GHz and Average value detector above 1GHz.

NOTE 5 - Above 1 GHz, the limit on peak emission is 20 dB above the maximum permitted average emission limit applicable to the EUT

4.4 Test Configuration

The EUT (listed in Sec.2.1) and the simulators (listed in Sec.2.2) were installed as shown on Sec.4.2 to meet FCC requirements and operating in a manner that tends to maximize its emission level in a normal application.

4.5 Operating Condition of EUT

4.5.1 Setup the EUT as shown in Sec. 4.2.

4.5.2 Turn the EUT on.

4.5.3 Connect the EUT and the TTL terminal of Test Fixture through three HCI cables of EUT, as follows (TX to RXD, RX to TXD, GND to GND). Plug the USB terminal of Test Fixture to the USB port of Notebook PC.

4.5.4 Use the software as section 2.3 to select the test mode, then disconnect the Test Fixture from EUT, remove the Test Fixture and Notebook PC, then test.

4.5.5 Repeat step 4.5.3 and 4.5.4, until the test of all modes finished.

4.6 Test Procedures

Radiated emission test applies to harmonics/spurs that fall in the restricted bands listed in Section 15.205. The maximum permitted average field strength is listed in Section 15.209. A pre-amp is necessary for this measurement. For measurement above 1 GHz, set RBW = 1MHz, VBW = 10 Hz, Sweep: Auto. If the emission is pulsed, modify the unit for continuous operation; use the settings shown above, then correct the reading by subtracting the peak-average correction factor, derived from the appropriate duty cycle calculation.

The EUT was placed on a turntable. Below 1 GHz, the table height is 80 cm above the reference ground plane. Above 1 GHz, the table height is 1.5 m. The turntable rotated 360 degrees to determine the position of the maximum emission level. The EUT was set 3 meters away from the receiving antenna, which was mounted on an antenna tower. The antenna moved up and down between 1 meter and 4 meters to find out the maximum emission level. Broadband antenna (Calibrated Bilog Antenna) or Horn antenna was used as receiving antenna. Both horizontal and vertical polarizations of the antenna were set on measurement. In order to find the maximum emission, all of the interference cables were manipulated according to ANSI C63.10: 2013 requirements during radiated emission test.

The bandwidth of Test Receiver R&S ESCI was set at 120 kHz from 30MHz to 1000MHz.

The bandwidth of Agilent N9010A was set at 1MHz for above 1GHz.

The frequency range from 30 MHz to 25 GHz (Up to 10th harmonics from fundamental frequency) was checked.

All the test results are listed in Sec.4.7.

4.7 Test Results

<PASS>

The frequency and amplitude of the highest radiated emission relative the limit is reported. All the emissions not reported below are too low against the FCC limit.

Frequency range: below 1GHz (Worst case emission)

No.	Operation	Mode	Channel	Frequency	Data Page
1.	Transmitting	BLE	00	2402 MHz	P17

Frequency range: above 1GHz (Worst case emission)

No.	Operation	Mode	Channel	Frequency	Data Page
1.	Transmitting	BLE	00	2402 MHz	P18

Band-Edge:

No.	Operation	Mode	Channel	Frequency	Data Page
1.	Transmitting	BLE	00	2402 MHz	P19
2.			39	2480 MHz	P19

NOTE 1 – Emission Level = Read Level + Antenna Factor + Cable Loss - Preamp Factor
Margin = Limits - Emission Level.

NOTE 2 – “QP” means “Quasi-Peak” values.

NOTE 3 – 0° was the table front facing the antenna. Degree is calculated from 0° clockwise facing the antenna.

NOTE 4 – The emission levels which not reported are too low against the official limit.

NOTE 5 – The emission levels recorded below is data of EUT configured in Lying direction, for this direction was the maximum emission direction during the test. The data of Side & Standing direction are too low against the official limit to be reported.

NOTE 6 – All reading are Quasi-Peak values below or equal to 1GHz, Peak and Average values above 1GHz.

For above 1GHz test, if the peak measured value complies with the average limit, it is unnecessary to perform an average measurement.

NOTE 7 – The frequency range 2310-2390MHz & 2483.5-2500MHz were tested for Restricted bands.

Worst case emission < 1GHz

EUT : Downlight Temperature : 22°C
 Model No. : CFIXCNLR6CRVD Humidity : 51%RH
 Test Mode : Transmitting Date of Test : 2023.03.26

BLE CH2402MHz

Polarization	Frequency (MHz)	Meter Reading dB (μV)	Antenna Factor (dB/m)	Cable Loss (dB)	Preamp Factor (dB)	Emission Level dB (μV/m)	Limits dB (μV/m)	Margin (dB)	Remark
Horizontal	50.409	25.66	19.6	0.77	28.2	17.83	40	22.17	QP
	108.27	36.89	16.3	1.14	28.05	26.28	43.5	17.22	QP
	130.38	32.52	18	1.23	27.96	23.79	43.5	19.71	QP
	289	32.65	19.08	1.86	26.96	26.63	46	19.37	QP
	343.18	32.89	20.14	1.99	27.34	27.68	46	18.32	QP
	499.43	31.77	23.5	2.46	27.8	29.93	46	16.07	QP
Vertical	31.51	36.77	18.93	0.58	28.29	27.99	40	12.01	QP
	43.05	36.63	19.1	0.7	28.23	28.2	40	11.8	QP
	50.409	34.81	19.6	0.77	28.2	26.98	40	13.02	QP
	101.64	35.49	15.23	1.11	28.09	23.74	43.5	19.76	QP
	129.92	36.33	17.9	1.23	27.96	27.5	43.5	16	QP
	343.18	34.67	20.14	1.99	27.34	29.46	46	16.54	QP

TEST ENGINEER: Jarey

Radiated Emission > 1GHz

EUT : Downlight Temperature : 22°C
 Model No. : CFIXCNLR6CRVD Humidity : 51%RH
 Test Mode : Transmitting Date of Test : 2022.03.26

BLE CH2402MHz

Polarization	Frequency (MHz)	Meter Reading dB (µV)	Antenna Factor (dB/m)	Cable Loss (dB)	Preamplifier Factor (dB)	Emission Level dB (µV/m)	Limits dB (µV/m)	Margin (dB)	Remark
Horizontal	3124	42.74	30.65	5.95	35.36	43.98	74	30.02	Peak
	4807	40.55	32.9	7.53	34.77	46.21	74	27.79	Peak
	4807	27.46	32.9	7.53	34.77	33.12	54	20.88	Average
	6391	40.35	34.5	8.72	34.76	48.81	74	25.19	Peak
	8092	38.59	37.55	10.27	34.7	51.71	74	22.29	Peak
	9181	37.47	38.25	10.83	34.68	51.87	74	22.13	Peak
Vertical	3565	40.48	31.42	6.33	35.22	43.01	74	30.99	Peak
	4825	42.47	32.97	7.53	34.76	48.21	74	25.79	Peak
	4825	30.24	32.97	7.53	34.76	35.98	54	18.02	Average
	6247	37.12	34.6	8.57	34.77	45.52	74	28.48	Peak
	7417	36.85	37	9.64	34.7	48.79	74	25.21	Peak
	9361	35.88	38.2	10.95	34.66	50.37	74	23.63	Peak

TEST ENGINEER: Jarey

Band-Edge:

EUT : Downlight Temperature : 22°C
 Model No. : CFIXCNLR6CRVD Humidity : 51%RH
 Test Mode : Transmitting Date of Test : 2023.03.26

BLE CH2402MHz

Polarization	Frequency (MHz)	Meter Reading dB (μV)	Antenna Factor (dB/m)	Cable Loss (dB)	Preamp Factor (dB)	Emission Level dB (μV/m)	Limits dB (μV/m)	Margin (dB)	Remark
Horizontal	2390	48.19	28.4	5.33	35.9	46.02	74	27.98	Peak
	2390	37.42	28.4	5.33	35.9	35.25	54	18.75	Average
Vertical	2390	47.25	28.4	5.33	35.9	45.08	74	28.92	Peak
	2390	36.32	28.4	5.33	35.9	34.15	54	19.85	Average

BLE CH2480MHz

Polarization	Frequency (MHz)	Meter Reading dB (μV)	Antenna Factor (dB/m)	Cable Loss (dB)	Preamp Factor (dB)	Emission Level dB (μV/m)	Limits dB (μV/m)	Margin (dB)	Remark
Horizontal	2483.5	49.76	28.44	5.43	35.82	47.81	74	26.19	Peak
	2483.5	38.38	28.44	5.43	35.82	36.43	54	17.57	Average
Vertical	2483.5	49.99	28.44	5.43	35.82	48.04	74	25.96	Peak
	2483.5	38.5	28.44	5.43	35.82	36.55	54	17.45	Average

TEST ENGINEER: Jarey

5 MAXIMUM PEAK OUTPUT POWER MEASUREMENT

5.1 Test Equipment

The following test equipment was used during the maximum peak output power measurement:

Item	Type	Manufacturer	Model No.	Serial No.	Cal. Date	Cal. Interval
1.	Spectrum Analyzer	Agilent	N9010A	MY52221182	2022.09.15	1 Year
2.	Coaxial Cable	WOKEN	SFL402-105F LEX	F02-150819-045	2023.02.22	1 Year
3.	10 dB Attenuator	Mini-Circuits	BW-S10W2+	001	2022.08.06	1 Year

5.2 Block Diagram of Test Setup

The Same as Section. 5.2.

5.3 Specification Limits ((§15.247(b)(3))

The Limits of maximum Peak Output Power for digital modulation in 2400-2483.5 MHz is: 1 Watt. (30 dBm)

5.4 Operating Condition of EUT

The software as section 2.3 was used to enable the EUT to change the test mode one by one.

5.5 Test Procedure

The transmitter output was connected to the spectrum analyzer.

The following procedure shall be used when an instrument with a resolution bandwidth that is greater than the DTS bandwidth is available to perform the measurement:

- a) $RBW \geq DTS$ Bandwidth.
- b) $VBW \geq [3 \times RBW]$.
- c) $Span \geq [3 \times RBW]$.
- d) Sweep time = auto.
- e) Detector = peak.
- f) Trace mode = max hold.
- g) Allow trace to fully stabilize.
- h) Use peak marker function to determine the peak amplitude level.

The test procedure is defined in ANSI C63.10-2013 (11.9.1.1 Measurement Procedure “ $RBW \geq DTS$ bandwidth” was used).

5.6 Test Results

PASSED.

All the test results are listed below.

(Test Date: 2023.03.29 Temperature: 23°C Humidity: 51 %)

Mode	Channel	Frequency (MHz)	Peak Output Power (dBm)	Limit
BLE	00	2402	6.278	30 dBm
	19	2440	5.985	30 dBm
	39	2480	5.883	30 dBm

BLE CH2402MHz

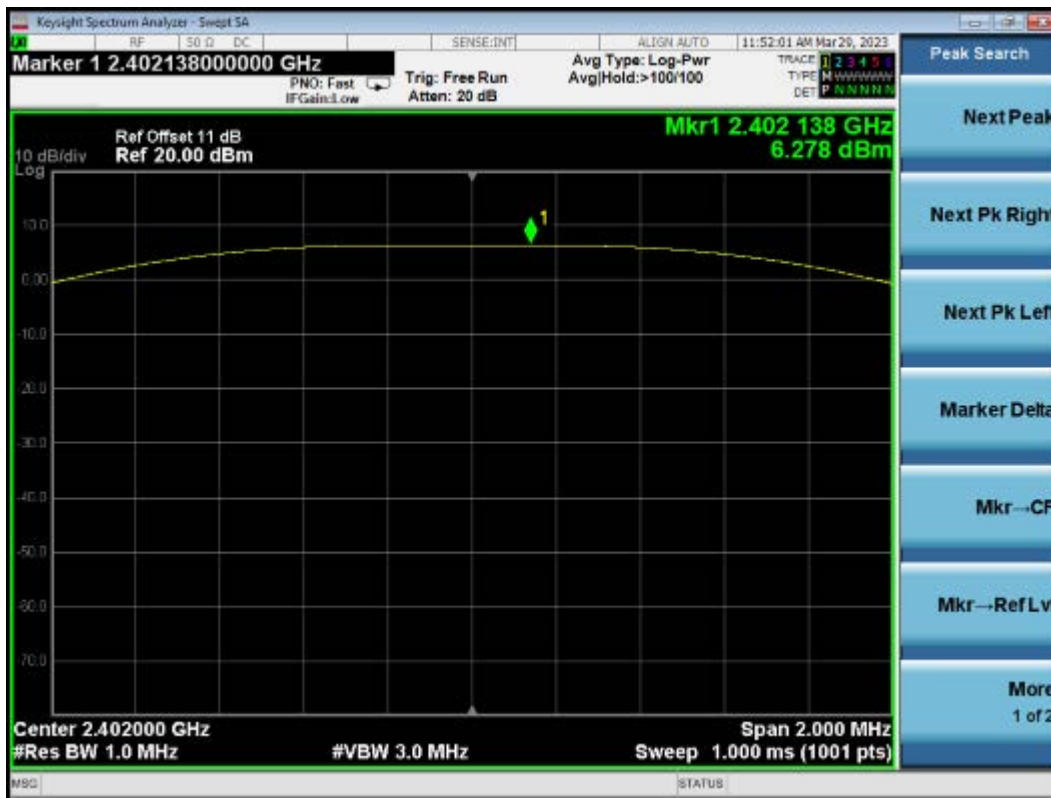

BLE CH2440MHz

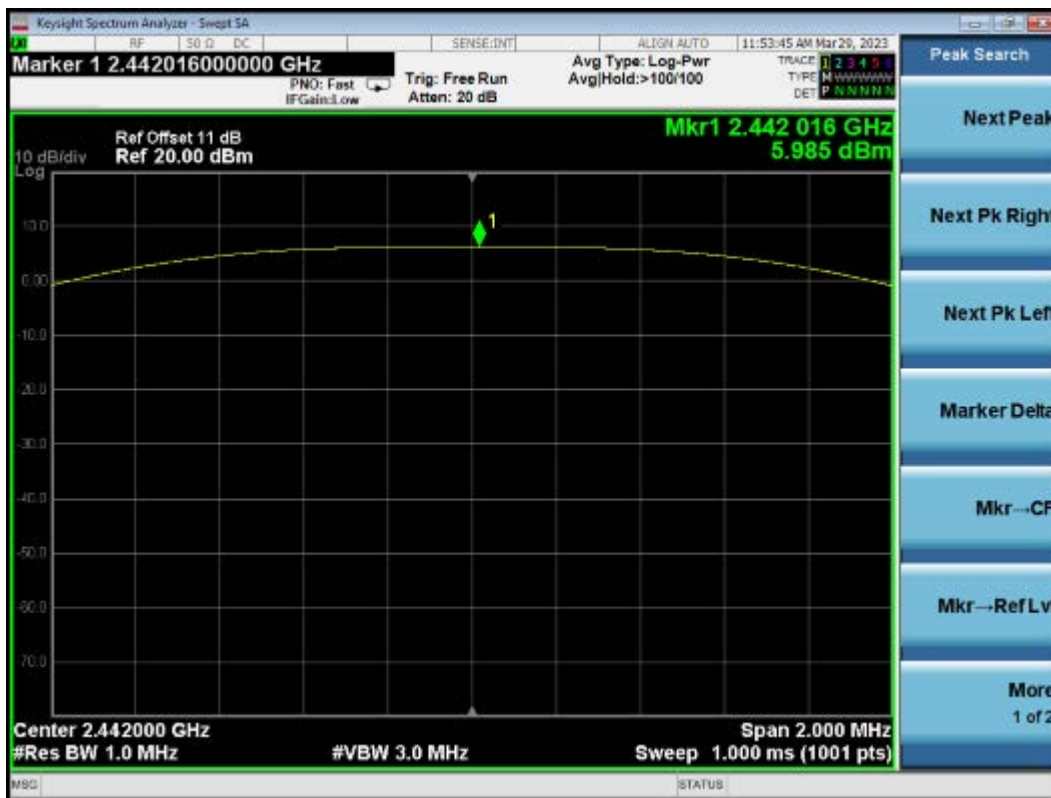

BLE CH2480MHz

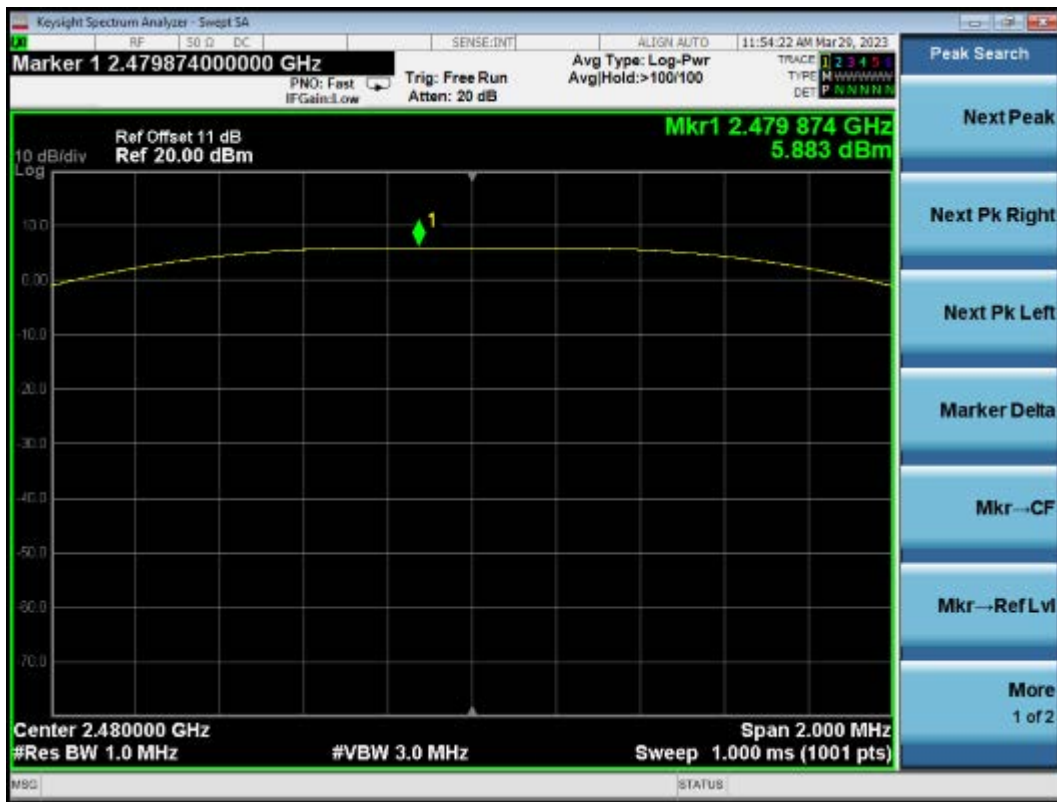

6 MEASUREMENT UNCERTAINTY LIST

The measurement uncertainty was estimated for test on the EUT according to CISPR 16-4-2. This uncertainty represents an expanded uncertainty expressed at approximately the 95% confidence level using a coverage of K=2.

The uncertainties value is not used in determining the PASS/FAIL results.

Test Items/Facilities	Frequency/Equipment/Unit	Uncertainty
Conducted Emission No.1 Shielded Room	9kHz~150kHz	±3.1 dB
	150kHz~30MHz	±2.6 dB
Conducted Emission No.3 Shielded Room	9kHz~150kHz	±3.1 dB
	150kHz~30MHz	±2.6 dB
Radiated Emission	30MHz~200MHz, Horizontal	±3.8 dB
	30MHz~200MHz, Vertical	±4.1 dB
	200MHz~1000MHz, Horizontal	±3.6 dB
	200MHz~1000MHz, Vertical	±5.1 dB
	1GHz~6GHz	±5.3 dB
	6GHz~18GHz	±5.3 dB
	18GHz~40GHz	±3.5 dB
Output Power Test	50MHz~18GHz	0.77 dB
Power Density Test	9kHz~6GHz	1.08 dB
RF Frequency Test	9kHz~40GHz	6×10^{-4}
Bandwidth Test	9kHz~6GHz	1.5×10^{-3}
RF Radiated Power Test	30MHz~1000MHz	3.06 dB
Conducted Output Power Test	50MHz~18GHz	0.83 dB
AC Voltage(<10kHz) Test	120V~230V	0.04 %
DC Power Test	0V~30V	0.4 %
Temperature	-40°C~+100°C	0.52 °C
Humidity	30%~95%	2.6 %