

TEST REPORT

On behalf of

Savant Technologies LLC dba GE Lighting, a Savant company

Product Name: LED Lamp

Model No.: CLEDA2116CD, CLEDA2116CDRV

FCC ID: PUU-A21-DMFC

Prepared For: Savant Technologies LLC dba GE Lighting, a Savant company
1975 Noble Road Cleveland Ohio United States 44112

Prepared By: Audix Technology (Shanghai) Co., Ltd.
3F and 4F, 34Bldg, 680 Guiping Rd.,
Caohejing Hi-Tech Park,
Shanghai 200233, China

Tel: +86-21-64955500



File No. : C1D2202016
Report No. : ACI-F22055
Date of Test : 2022.02.18-27
Date of Report : 2022.03.11

The statement is based on a single evaluation of one sample of the above-mentioned products. It does not imply an assessment of the whole production and does not permit the use of the test lab logo. The report must not be used by the client to claim product certification, approval, or endorsement by NVLAP, NIST, or any agency of the Federal Government.

TABLE OF CONTENTS

	Page
1 SUMMARY OF STANDARDS AND RESULTS	5
1.1 Description of Standards and Results.....	5
2 GENERAL INFORMATION	6
2.1 Description of Equipment Under Test.....	6
2.2 EUT Specifications Assessed in Current Report.....	7
2.3 Test Information	7
2.4 Sample Description	8
2.5 Supported equipment.....	8
2.6 Description of Test Facility	8
3 CONDUCTED EMISSION TEST	9
3.1 Test Equipment.....	9
3.2 Block Diagram of Test Setup	9
3.3 Conducted Emission Limits (§15.207).....	10
3.4 Test Configuration.....	10
3.5 Operating Condition of EUT	10
3.6 Test Procedures	10
3.7 Test Results	11
4 RADIATED EMISSION TEST	13
4.1 Test Equipment.....	13
4.2 Block Diagram of Test Setup	13
4.3 Radiated Emission Limit (§15.209)	14
4.4 Test Configuration.....	14
4.5 Operating Condition of EUT	15
4.6 Test Procedures	15
4.7 Test Results	16
5 99% OCCUPIED BANDWIDTH MEASUREMENT	32
5.1 Test Equipment.....	32
5.2 Block Diagram of Test Setup	32
5.3 Operating Condition of EUT.....	32
5.4 Test Procedure.....	32
5.5 Test Results	33
6 6 DB BANDWIDTH MEASUREMENT	39
6.1 Test Equipment.....	39
6.2 Block Diagram of Test Setup	39
6.3 Specification Limits (§15.247(a)(2)).....	39
6.4 Operating Condition of EUT	39
6.5 Test Procedure.....	39
6.6 Test Results	40
7 MAXIMUM PEAK OUTPUT POWER MEASUREMENT	46
7.1 Test Equipment.....	46
7.2 Block Diagram of Test Setup	46
7.3 Specification Limits ((§15.247(b)(3))	46
7.4 Operating Condition of EUT	46

7.5	Test Procedure.....	46
7.6	Test Results	48
8	EMISSION LIMITATIONS MEASUREMENT.....	54
8.1	Test Equipment.....	54
8.2	Block Diagram of Test Setup	54
8.3	Specification Limits (§15.247(d))	54
8.4	Operating Condition of EUT.....	54
8.5	Test Procedure.....	54
8.6	Test Results	56
9	POWER SPECTRAL DENSITY MEASUREMENT	81
9.1	Test Equipment.....	81
9.2	Block Diagram of Test Setup	81
9.3	Specification Limits (§15.247(e))	81
9.4	Operating Condition of EUT.....	81
9.5	Test Procedure.....	81
9.6	Test Results	82
10	DEVIATION TO TEST SPECIFICATIONS	88
11	MEASUREMENT UNCERTAINTY LIST	89

TEST REPORT

Applicant : Savant Technologies LLC dba GE Lighting, a Savant company
 EUT Description : LED Lamp
 (A) Model No. : Refer to Sec.2.1
 (B) Power Supply : 120V AC 60Hz
 (C) Test Voltage : 120V/60Hz

Test Procedure Used:

*FCC RULES AND REGULATIONS PART 15 SUBPART C
 AND ANSI C63.10-2013*

The device described above is tested by Audix Technology (Shanghai) Co., Ltd. to determine the maximum emission levels emanating from the device. The maximum emission levels are compared to the FCC Part 15 Subpart C limits.

The test results are contained in this test report and Audix Technology (Shanghai) Co., Ltd. is assumed full responsibility for the accuracy and completeness of these measurements. This report also shows that the EUT (M/N: Refer to Sec2.1), which was tested is technically compliance with the FCC limits.

This report applies to above tested Sample only. This report shall not be reproduced in part without written approval of Audix Technology (Shanghai) Co., Ltd.

The test results for EUT's BLE function are contained in No.ACI-F22054 report.

Date of Test : 2022.02.18-27 Date of Report : 2022.03.11

Producer : *Mindy Wang*
 MINDY WANG / Assistant

Review : *Byron Wu*
 BYRON WU/ Deputy Assistant Manager

AUDIX® For and on behalf of
 Audix Technology (Shanghai) Co., Ltd.

Signatory : *Byron Kwo*
 Authorized Signature(s) BYRON KWO/Assistant General Manager

1 SUMMARY OF STANDARDS AND RESULTS

1.1 Description of Standards and Results

The EUT have been tested according to the applicable standards as referenced below:

Description / Test Item	Test Standard	Results	Meets Limit
EMISSION			
Conducted Emission	FCC RULES AND REGULATIONS PART 15 SUBPART C AND ANSI C63.10:2013	Pass	15.207
Radiated Emission	FCC RULES AND REGULATIONS PART 15 SUBPART C AND ANSI C63.10:2013	Pass	15.209(a) 15.205(a)(c)
6 dB Bandwidth Measurement	FCC RULES AND REGULATIONS PART 15 SUBPART C AND ANSI C63.10:2013	Pass	15.247(a)(2)
Maximum Peak Output Power Measurement	FCC RULES AND REGULATIONS PART 15 SUBPART C AND ANSI C63.10:2013	Pass	15.247(b)(3)
Emission Limitations Measurement	FCC RULES AND REGULATIONS PART 15 SUBPART C AND ANSI C63.10:2013	Pass	15.247(d)
Band Edge Measurement	FCC RULES AND REGULATIONS PART 15 SUBPART C AND ANSI C63.10:2013	Pass	15.247(d)
Power Spectral Density Measurement	FCC RULES AND REGULATIONS PART 15 SUBPART C AND ANSI C63.10:2013	Pass	15.247(e)
N/A is an abbreviation for Not Applicable.			

2 GENERAL INFORMATION

2.1 Description of Equipment Under Test

Description : LED Lamp

Type of EUT : Production Pre-product Pro-type

Model Number : CLEDA2116CD, CLEDA2116CDRV

Radio Tech : BLE 4.2;
IEEE 802.11 b/g/n.

Note: : 802.11n-HT40 not support.

Channel Freq. : BLE: 2402MHz-2480MHz;
802.11b/g/n: 2412MHz-2462MHz.

Modulation : BLE: GFSK;
802.11b: DSSS (CCK, DQPSK, DBPSK);
802.11g/n: OFDM (64QAM, 16QAM, QPSK, BPSK).

Antenna Info. : Antenna Type: Microstrip line Antenna
Antenna Gain: 0.5 dBi
The Antenna was a permanently attached antenna that is comply with 15.203 requirement.

Test Mode : The EUT was set at continuous TX during all the test in the report.

Applicant : Savant Technologies LLC dba GE Lighting, a Savant company
1975 Noble Road Cleveland Ohio United States 44112

Manufacturer : same as Applicant

Factory : Foshan Electrical and Lighting Co., Ltd.
64 North of Fenjiang Rd, Foshan, Guangdong, China

2.2 EUT Specifications Assessed in Current Report

Mode	Modulation	Data Rate(Mbps)
802.11b	DS (DQPSK, DBPSK, CCK)	Up to 11
802.11g	OFDM (64-QAM, 16-QAM, QPSK, BPSK)	Up to 54
802.11n-HT 20	OFDM (64-QAM, 16-QAM, QPSK, BPSK)	Up to 72.2

Channel List			
Channel No.	Frequency (MHz)	Channel No.	Frequency (MHz)
1	2412	7	2442
2	2417	8	2447
3	2422	9	2452
4	2427	10	2457
5	2432	11	2462
6	2437		

2.3 Test Information

The test software “UI_mptool.exe” was used to control EUT work in TX mode, Power Index and select test channel.

Modulation	data rate (Mbps)	Test Channel		Frequency (MHz)
802.11b	11	Low:	1	2412
		Middle:	6	2437
			8	2447
		High:	11	2462
802.11g	6	Low:	1	2412
			3	2422
		Middle:	6	2437
			8	2447
		High:	11	2462
802.11n20	MCS0	Low:	1	2412
			3	2422
		Middle:	6	2437
			8	2447
		High:	11	2462

2.4 Sample Description

Test Item	Model Number	Sample Number	Date of received
Conducted Emission	CLEDA2116CD	E2202127-04/06	2022.02.16
Radiated Emission	CLEDA2116CD	E2202127-01/06	2022.02.16
Conducted RF Test	CLEDA2116CD	E2202127-03/06	2022.02.16

2.5 Supported equipment

Brand : Acer
Product Name: : Notebook PC
Model Name : TravelMate P238 series
Model Number : N15W8

2.6 Description of Test Facility

Name of Firm : Audix Technology (Shanghai) Co., Ltd.
Site Location : 3F and 4F, 34Bldg, 680 Guiping Rd.,
Caohejing Hi-Tech Park,
Shanghai 200233, China.
Accredited by NVLAP, Lab Code : 200371-0
FCC Designation Number : CN5027
Test Firm Registration Number : 954668

3 CONDUCTED EMISSION TEST

3.1 Test Equipment

The following test equipments are used during the conducted emission test in a shielded room:

Item	Type	Manufacturer	Model No.	Serial No.	Cal. Date	Cal. Interval
1.	Test Receiver	R&S	ESCI	101302	2021.04.26	1 Year
2.	Artificial Mains Network (AMN)	R&S	ENV4200	100125	2021.06.24	1 Year
3.	Software	Audix	e3	6.2009-1-15	--	--

3.2 Block Diagram of Test Setup

3.2.1 Conducted Disturbance Test Setup

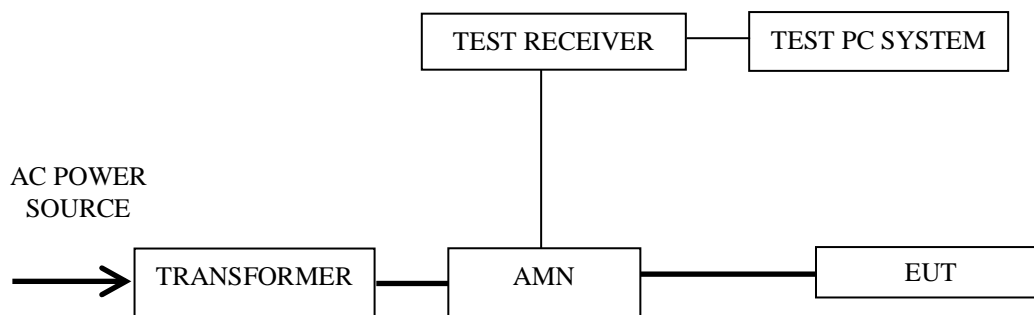

— : Signal Line
 — : Power Line

3.3 Conducted Emission Limits (§15.207)

Frequency Range (MHz)	Limits dB(μV)	
	Quasi-peak	Average
0.15 ~ 0.5	66~56	56~46
0.5 ~ 5	56	46
5 ~ 30	60	50
NOTE 1 – The lower limit shall apply at the transition frequencies. NOTE 2 – The limit decreases linearly with the logarithm of the frequency in the range 0.15 MHz~0.50 MHz		

3.4 Test Configuration

The EUT (listed in Sec.2.1) was installed as shown on Sec.3.2 to meet FCC requirement and operating in a manner which tends to maximize its emission level in a normal application.

3.5 Operating Condition of EUT

- 3.5.1 Setup the EUT as shown in Sec. 3.2.
- 3.5.2 Turn on the power of all equipment.
- 3.5.3 Turn the EUT on the test mode, and then test.

3.6 Test Procedures

The EUT was placed upon a non-metallic table, which is 0.8 m above the horizontal conducting ground plane and 0.4 m from a vertical reference plane. The EUT was connected to the power mains through an Artificial Mains Network (AMN) to provide a 50 Ω coupling impedance for the measuring equipment. Both sides of AC line (Line & Neutral) were checked to find out the maximum conducted emission according to FCC Part 15 Subpart C and ANSI C63.10: 2013 requirements during conducted disturbance test.

The I.F. bandwidth of Test Receiver ESCI was set at 9 kHz.

The frequency range from 150 kHz to 30 MHz was checked.

Test with a dummy load in lieu of the antenna to determine compliance with Section 15.207 limits within the transmitter's fundamental emission band. (According to KDB 174176 D01 Line Conducted FAQ)

The test modes were done on conducted disturbance test and all the test results are listed in Sec. 3.7

3.7 Test Results

< **PASS** >

The frequency and amplitude of the highest conducted emission relative the limit is reported. All the emissions not reported below are too low against the FCC limit.

Worst case emission:

No.	Operation	Modulation	Channel	Frequency (MHz)	Data Page
1.	Transmitting	--	--	--	P12

NOTE 1 – Level = Read Level + AMN Factor + Cable Loss

NOTE 2 – “QP” means “Quasi-Peak” values

NOTE 3 – The emission levels which not reported are too low against the official limit.

Worst case emission

EUT : LED Lamp Temperature : 22°C
 Model No. : CLEDA2116CD Humidity : 51%RH
 Test Mode : Transmitting Date of Test : 2022.02.18

Polarization	Frequency (MHz)	Meter Reading dB (μV)	AMN Factor (dB)	Cable Loss (dB)	Emission Level dB (μV)	Limits dB (μV)	Margin (dB)	Remark
Line	0.1659	45.12	0	0.03	45.15	65.16	20.01	QP
	0.1659	29.4	0.16	0.03	29.59	55.16	25.57	Average
	0.3976	37.27	0	0.04	37.31	57.9	20.59	QP
	0.3976	16.5	0.19	0.04	16.73	47.9	31.17	Average
	0.9431	24.65	0	0.06	24.71	56	31.29	QP
	0.9431	12.4	0.22	0.06	12.68	46	33.32	Average
	1.991	19.81	0	0.09	19.9	56	36.1	QP
	1.991	12.7	0.24	0.09	13.03	46	32.97	Average
	10.905	18.76	0	0.2	18.96	60	41.04	QP
	10.905	10.1	0.35	0.2	10.65	50	39.35	Average
	20.814	19.07	0	0.28	19.35	60	40.65	QP
	20.814	11.4	0.4	0.28	12.08	50	37.92	Average
Neutral	0.1573	45.31	0	0.03	45.34	65.6	20.26	QP
	0.1573	27.6	0.12	0.03	27.75	55.6	27.85	Average
	0.4019	41.11	0	0.04	41.15	57.81	16.66	QP
	0.4019	18.2	0.18	0.04	18.42	47.81	29.39	Average
	0.4994	40.67	0	0.04	40.71	56.01	15.3	QP
	0.4994	16.5	0.2	0.04	16.74	46.01	29.27	Average
	1.054	31.17	0	0.06	31.23	56	24.77	QP
	1.054	10.4	0.36	0.06	10.82	46	35.18	Average
	4.574	20.69	0	0.13	20.82	56	35.18	QP
	4.574	9.5	0.44	0.13	10.07	46	35.93	Average
	11.317	20.19	0	0.21	20.4	60	39.6	QP
11.317	8	0.57	0.21	8.78	50	41.22	Average	

TEST ENGINEER: Jarey

4 RADIATED EMISSION TEST

4.1 Test Equipment

The following test equipment are used during the radiated emission test in a semi-anechoic chamber:

Item	Type	Manufacturer	Model No.	Serial No.	Cal. Date	Cal. Interval
1.	Preamplifier	Agilent	8447D	2944A10548	2021.03.08	1 Year
2.	Preamplifier	HP	8449B	3008A00864	2021.03.08	1 Year
3.	Spectrum Analyzer	Agilent	N9010A	MY52221182	2021.09.16	1 Year
4.	Test Receiver	R&S	ESCI	101303	2021.03.08	1 Year
5.	Bilog Antenna+6dB Attenuator	Schwarz beck	VULB 9168+EMCI-N-6-06	707+AT-N0637	2021.03.30	1 Year
6.	Horn Antenna	EMCO	3115	9607-4878	2021.07.27	1 Year
7.	Horn Antenna	EMCO	3116	00062643	2021.10.10	1 Year
8.	Cavity Band Rejection Filter	Microwave	WT-A3882-R10	WT200312-1-1	2021.09.15	1 Year
9.	Software	Audix	e3	SET00200 9912M295-2	--	--

4.2 Block Diagram of Test Setup

4.2.1 EUT & Peripherals

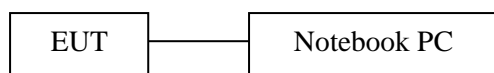

4.2.2 Below 1GHz

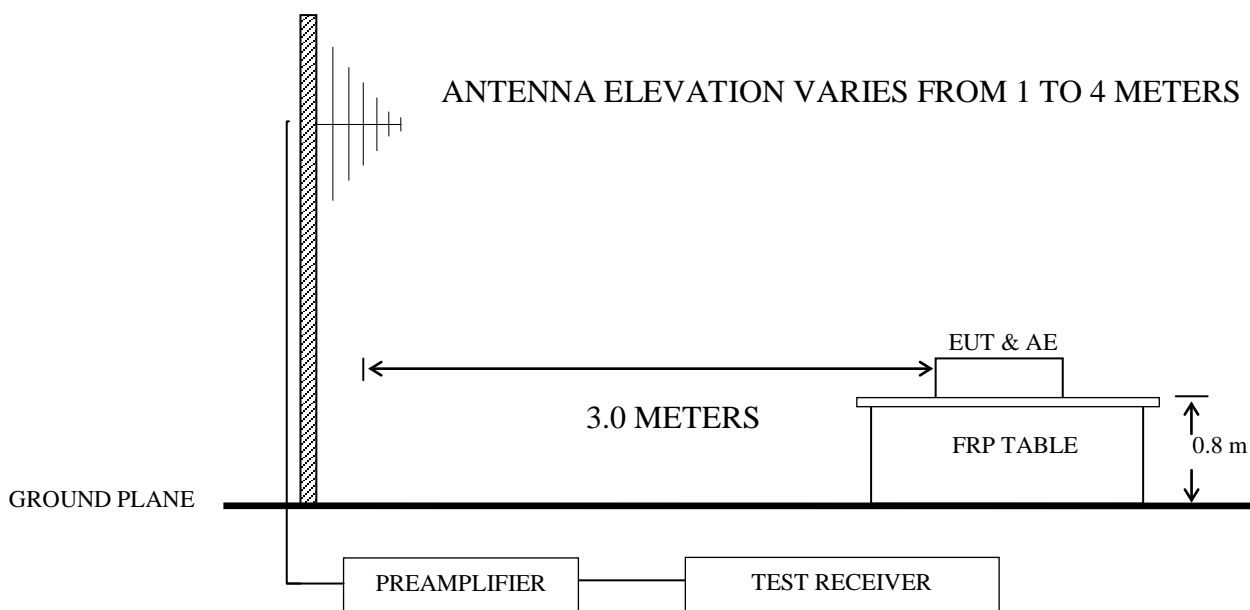

4.2.3 Above 1GHz

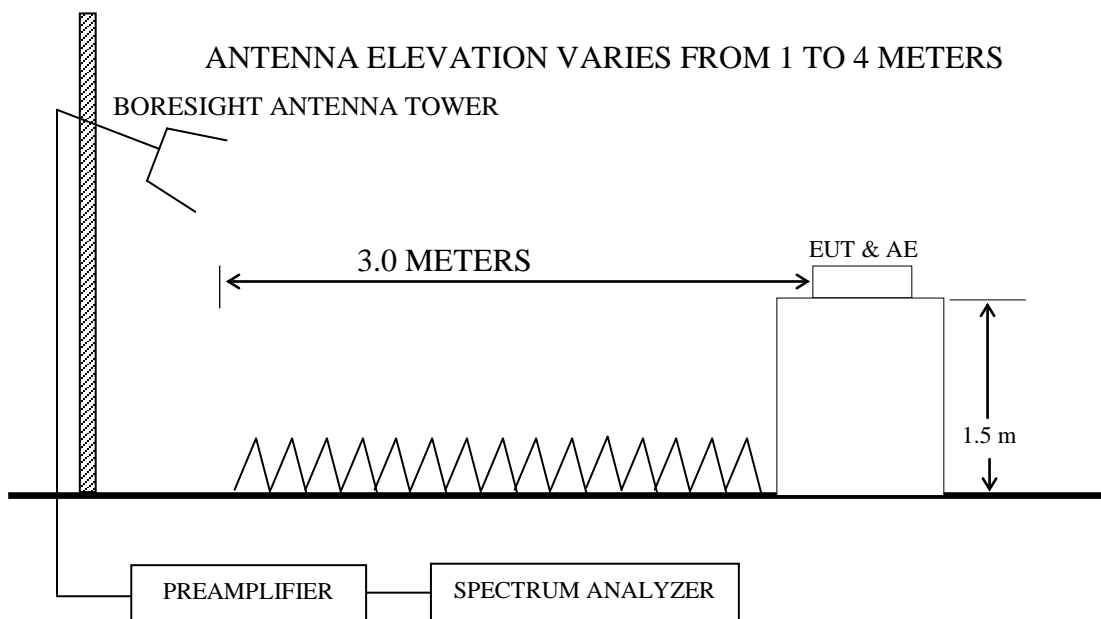

4.3 Radiated Emission Limit (§15.209)

Frequency (MHz)	Distance (m)	Field strength limits (μV/m)	
		(μV/m)	(μV/m)
30 ~ 88	3	100	40.0
88 ~ 216	3	150	43.5
216 ~ 960	3	200	46.0
Above 960	3	500	54.0

NOTE 1 - Emission Level dB (μV/m) = 20 log Emission Level (μV/m)

NOTE 2 - The tighter limit applies at the band edges.

NOTE 3 - Distance refers to the distance in meters between the measuring instrument antenna and the closed point of any part of the device or system.

NOTE 4 - The limits shown are based on Quasi-peak value detector below or equal to 1GHz and Average value detector above 1GHz.

NOTE 5 - Above 1 GHz, the limit on peak emission is 20 dB above the maximum permitted average emission limit applicable to the EUT

4.4 Test Configuration

The EUT (listed in Sec.2.1) and the simulators (listed in Sec.2.2) were installed as shown on Sec.4.2 to meet FCC requirements and operating in a manner that tends to maximize its emission level in a normal application.

4.5 Operating Condition of EUT

4.5.1 Setup the EUT as shown in Sec. 4.2.

4.5.2 Turn on the power of all equipment.

4.5.3 Turn the EUT on the test mode, and then test.

4.6 Test Procedures

Radiated emission test applies to harmonics/spurs that fall in the restricted bands listed in Section 15.205. The maximum permitted average field strength is listed in Section 15.209. A pre-amp is necessary for this measurement. For measurement above 1 GHz, set RBW = 1MHz, VBW = 10 Hz, Sweep: Auto. If the emission is pulsed, modify the unit for continuous operation; use the settings shown above, then correct the reading by subtracting the peak-average correction factor, derived from the appropriate duty cycle calculation.

The EUT was placed on a turntable. Below 1 GHz, the table height is 80 cm above the reference ground plane. Above 1 GHz, the table height is 1.5 m. The turntable rotated 360 degrees to determine the position of the maximum emission level. The EUT was set 3 meters away from the receiving antenna, which was mounted on an antenna tower. The antenna moved up and down between 1 meter and 4 meters to find out the maximum emission level. Broadband antenna (Calibrated Bilog Antenna) or Horn antenna was used as receiving antenna. Both horizontal and vertical polarizations of the antenna were set on measurement. In order to find the maximum emission, all of the interference cables were manipulated according to ANSI C63.10: 2013 requirements during radiated emission test.

The bandwidth of Test Receiver R&S ESCI was set at 120 kHz from 30MHz to 1000MHz.

The bandwidth of Agilent N9010A was set at 1MHz for above 1GHz.

The frequency range from 30 MHz to 25 GHz (Up to 10th harmonics from fundamental frequency) was checked.

All the test results are listed in Sec.4.7.

4.7 Test Results

<PASS>

The frequency and amplitude of the highest radiated emission relative the limit is reported. All the emissions not reported below are too low against the FCC limit.

Frequency range: below 1GHz (Worst case emission)

No.	Operation	Modulation	Channel	Frequency	Data Page
1.	Transmitting	802.11b	1	2412 MHz	P18
2.			6	2437 MHz	P18
3.			11	2462 MHz	P19
4.		802.11g	6	2437 MHz	P19
5.		802.11n20	6	2437 MHz	P20

Frequency range: above 1GHz

No.	Operation	Modulation	Channel	Frequency	Data Page
1.	Transmitting	802.11b	1	2412 MHz	P21
2.			6	2437 MHz	P21
3.			11	2462 MHz	P22
4.	Transmitting	802.11g	6	2437 MHz	P22
5.	Transmitting	802.11n20	6	2437 MHz	P23

Band-Edge:

No.	Operation	Modulation	Channel	Frequency	Data Page
1.	Transmitting	802.11b	1	2412 MHz	P24
2.			11	2462 MHz	P24
3.		802.11g	1	2412 MHz	P24
4.			11	2462 MHz	P25
5.		802.11n20	1	2412 MHz	P25
6.			11	2462 MHz	P25

Restricted bands:

No.	Operation	Modulation	Channel	Frequency	Data Page
1.	Transmitting	802.11b	1	2412 MHz	P26
2.			8	2447 MHz	P26
3.			11	2462 MHz	P27
4.		802.11g	1	2412 MHz	P28
5.			3	2422 MHz	P28
6.			8	2447 MHz	P29
7.			11	2462 MHz	P29
8.		802.11n20	1	2412 MHz	P30
9.			3	2422 MHz	P30
10.			8	2447 MHz	P31
11.			11	2462 MHz	P31

NOTE 1 – Level = Read Level + Antenna Factor + Cable Loss - Preamp Factor

NOTE 2 – “QP” means “Quasi-Peak” values

NOTE 3 – 0° was the table front facing the antenna. Degree is calculated from
0° clockwise facing the antenna.

NOTE 4 – The emission levels which not reported are too low against the official
limit.

NOTE 5 – The emission levels recorded below is data of EUT configured in
Standing direction, for Standing direction was the maximum emission
direction during the test. The data of Side & Lying direction are too
low against the official limit to be reported.

NOTE 6 – All reading are Quasi-Peak values below or equal to 1GHz, Peak and
Average values above 1GHz.

For above 1GHz test, if the peak measured value complies with the
average limit, it is unnecessary to perform an average measurement.

NOTE 7 – The frequency range 2310-2390MHz & 2483.5-2500MHz were tested
for Restricted bands.

Worst case emission < 1GHz

EUT : LED Lamp Temperature : 22°C
 Model No. : CLEDA2116CD Humidity : 51%RH
 Test Mode : Transmitting Date of Test : 2022.02.27

802.11b CH2412MHz

Polarization	Frequency (MHz)	Meter Reading dB (µV)	Antenna Factor (dB/m)	Cable Loss (dB)	Preamp Factor (dB)	Emission Level dB (µV/m)	Limits dB (µV/m)	Margin (dB)	Remark
Horizontal	39.715	24.68	18.91	0.66	28.24	16.01	40	23.99	QP
	56.593	24.63	19.44	0.81	28.17	16.71	40	23.29	QP
	144.34	31.68	18.85	1.29	27.82	24	43.5	19.5	QP
	159.78	29.8	19	1.35	27.73	22.42	43.5	21.08	QP
	480.53	27.01	22.9	2.4	27.86	24.45	46	21.55	QP
	771.45	24.96	27.65	2.98	27.07	28.52	46	17.48	QP
Vertical	46.995	24.27	19.6	0.73	28.21	16.39	40	23.61	QP
	63.983	24.28	18.8	0.86	28.15	15.79	40	24.21	QP
	144.34	33.4	18.85	1.29	27.82	25.72	43.5	17.78	QP
	169.01	32.61	18.7	1.39	27.66	25.04	43.5	18.46	QP
	356.68	26.34	20.05	2.03	27.34	21.08	46	24.92	QP
	771.45	24.37	27.65	2.98	27.07	27.93	46	18.07	QP

802.11b CH2437MHz

Polarization	Frequency (MHz)	Meter Reading dB (µV)	Antenna Factor (dB/m)	Cable Loss (dB)	Preamp Factor (dB)	Emission Level dB (µV/m)	Limits dB (µV/m)	Margin (dB)	Remark
Horizontal	38.212	24.27	18.7	0.65	28.25	15.37	40	24.63	QP
	63.983	24.4	18.8	0.86	28.15	15.91	40	24.09	QP
	144.34	32.26	18.85	1.29	27.82	24.58	43.5	18.92	QP
	159.78	28.81	19	1.35	27.73	21.43	43.5	22.07	QP
	263.82	30.79	17.84	1.74	27.1	23.27	46	22.73	QP
	682.35	24.1	26.15	2.82	27.48	25.59	46	20.41	QP
Vertical	43.05	25.13	19.1	0.7	28.23	16.7	40	23.3	QP
	66.266	25.08	18.5	0.88	28.14	16.32	40	23.68	QP
	144.34	33.49	18.85	1.29	27.82	25.81	43.5	17.69	QP
	169.01	32.14	18.7	1.39	27.66	24.57	43.5	18.93	QP
	378.58	26.39	20.85	2.1	27.48	21.86	46	24.14	QP
	758.04	24.13	27.8	2.94	27.16	27.71	46	18.29	QP

802.11b CH2462MHz

Polarization	Frequency (MHz)	Meter Reading dB (μV)	Antenna Factor (dB/m)	Cable Loss (dB)	Preamp Factor (dB)	Emission Level dB (μV/m)	Limits dB (μV/m)	Margin (dB)	Remark
Horizontal	39.715	24.96	18.91	0.66	28.24	16.29	40	23.71	QP
	64.433	24.65	18.65	0.87	28.15	16.02	40	23.98	QP
	144.34	31.5	18.85	1.29	27.82	23.82	43.5	19.68	QP
	159.78	30.28	19	1.35	27.73	22.9	43.5	20.6	QP
	400.43	27.53	21.1	2.17	27.6	23.2	46	22.8	QP
	821.71	25.38	28	3.12	26.75	29.75	46	16.25	QP
Vertical	43.506	24.31	19.15	0.7	28.23	15.93	40	24.07	QP
	58.203	24.67	19.4	0.82	28.17	16.72	40	23.28	QP
	144.34	33.55	18.85	1.29	27.82	25.87	43.5	17.63	QP
	169.01	33.04	18.7	1.39	27.66	25.47	43.5	18.03	QP
	355.43	25.77	20	2.02	27.34	20.45	46	25.55	QP
	729.36	23.53	27	2.88	27.29	26.12	46	19.88	QP

802.11g CH2437MHz

Polarization	Frequency (MHz)	Meter Reading dB (μV)	Antenna Factor (dB/m)	Cable Loss (dB)	Preamp Factor (dB)	Emission Level dB (μV/m)	Limits dB (μV/m)	Margin (dB)	Remark
Horizontal	40.702	24.57	19	0.67	28.24	16	40	24	QP
	60.069	25.66	19.2	0.84	28.16	17.54	40	22.46	QP
	144.34	31.75	18.85	1.29	27.82	24.07	43.5	19.43	QP
	159.78	28.84	19	1.35	27.73	21.46	43.5	22.04	QP
	389.36	25.86	21	2.14	27.54	21.46	46	24.54	QP
	760.7	24.45	27.8	2.94	27.16	28.03	46	17.97	QP
Vertical	41.713	24.18	19.07	0.68	28.24	15.69	40	24.31	QP
	60.492	25.69	19.15	0.84	28.16	17.52	40	22.48	QP
	144.34	33.33	18.85	1.29	27.82	25.65	43.5	17.85	QP
	169.01	32.63	18.7	1.39	27.66	25.06	43.5	18.44	QP
	382.59	26.17	20.9	2.12	27.5	21.69	46	24.31	QP
	729.36	24.37	27	2.88	27.29	26.96	46	19.04	QP

802.11n20 CH2437MHz

Polarization	Frequency (MHz)	Meter Reading dB (µV)	Antenna Factor (dB/m)	Cable Loss (dB)	Preamp Factor (dB)	Emission Level dB (µV/m)	Limits dB (µV/m)	Margin (dB)	Remark
Horizontal	39.715	24.74	18.91	0.66	28.24	16.07	40	23.93	QP
	58.203	24.56	19.4	0.82	28.17	16.61	40	23.39	QP
	144.34	32.11	18.85	1.29	27.82	24.43	43.5	19.07	QP
	159.78	29.79	19	1.35	27.73	22.41	43.5	21.09	QP
	455.91	26.31	22.8	2.32	27.81	23.62	46	22.38	QP
	785.09	24.48	27.9	3.02	26.99	28.41	46	17.59	QP
Vertical	44.12	24.01	19.21	0.71	28.22	15.71	40	24.29	QP
	60.492	24.98	19.15	0.84	28.16	16.81	40	23.19	QP
	144.34	32.95	18.85	1.29	27.82	25.27	43.5	18.23	QP
	169.01	32.24	18.7	1.39	27.66	24.67	43.5	18.83	QP
	341.98	26.21	19.86	1.99	27.26	20.8	46	25.2	QP
	593.05	29.15	24.95	2.73	27.81	29.02	46	16.98	QP

TEST ENGINEER: Jarey

Radiated Emission > 1GHz

EUT : LED Lamp Temperature : 22°C
 Model No. : CLEDA2116CD Humidity : 51%RH
 Test Mode : Transmitting Date of Test : 2022.02.27

802.11b CH2412MHz

Polarization	Frequency (MHz)	Meter Reading dB (μV)	Antenna Factor (dB/m)	Cable Loss (dB)	Preamp Factor (dB)	Emission Level dB (μV/m)	Limits dB (μV/m)	Margin (dB)	Remark
Horizontal	3400	42.1	31.07	6.27	35.17	44.27	74	29.73	Peak
	4824	45.75	33.26	7.55	34.75	51.81	74	22.19	Peak
	4824	35.79	33.26	7.55	34.75	41.85	54	12.15	Average
	6844	37.93	35.22	9.09	34.79	47.45	74	26.55	Peak
	8920	37.02	38.26	10.7	34.71	51.27	74	22.73	Peak
	11212	35.73	38.8	11.76	34.35	51.94	74	22.06	Peak
Vertical	3436	42.91	31.16	6.31	35.16	45.22	74	28.78	Peak
	4824	46.05	33.26	7.55	34.75	52.11	74	21.89	Peak
	4824	36.31	33.26	7.55	34.75	42.37	54	11.63	Average
	6424	38.75	34.39	8.76	34.74	47.16	74	26.84	Peak
	8452	35.61	38.51	10.46	34.75	49.83	74	24.17	Peak
	10372	36.27	38.33	11.46	34.52	51.54	74	22.46	Peak

802.11b CH2437MHz

Polarization	Frequency (MHz)	Meter Reading dB (μV)	Antenna Factor (dB/m)	Cable Loss (dB)	Preamp Factor (dB)	Emission Level dB (μV/m)	Limits dB (μV/m)	Margin (dB)	Remark
Horizontal	3448	41.94	31.19	6.31	35.15	44.29	74	29.71	Peak
	4874	43.95	33.49	7.61	34.74	50.31	74	23.69	Peak
	4874	34.7	33.49	7.61	34.74	41.06	54	12.94	Average
	6844	37.89	35.22	9.09	34.79	47.41	74	26.59	Peak
	8344	36.75	38.34	10.4	34.77	50.72	74	23.28	Peak
	10552	36.37	38.33	11.51	34.49	51.72	74	22.28	Peak
Vertical	3448	41.65	31.19	6.31	35.15	44	74	30	Peak
	4874	44.46	33.49	7.61	34.74	50.82	74	23.18	Peak
	4874	35.35	33.49	7.61	34.74	41.71	54	12.29	Average
	6028	39.74	34.31	8.43	34.7	47.78	74	26.22	Peak
	8116	36.55	37.91	10.28	34.79	49.95	74	24.05	Peak
	10348	35.47	38.34	11.46	34.53	50.74	74	23.26	Peak

802.11b CH2462MHz

Polarization	Frequency (MHz)	Meter Reading dB (μV)	Antenna Factor (dB/m)	Cable Loss (dB)	Preamplifier Factor (dB)	Emission Level dB (μV/m)	Limits dB (μV/m)	Margin (dB)	Remark
Horizontal	3508	41.91	31.33	6.36	35.14	44.46	74	29.54	Peak
	4924	44.83	33.72	7.67	34.72	51.5	74	22.5	Peak
	4924	34.28	33.72	7.67	34.72	40.95	54	13.05	Average
	6700	37.89	34.88	9.01	34.77	47.01	74	26.99	Peak
	8212	36.95	38.09	10.34	34.78	50.6	74	23.4	Peak
	10300	35.68	38.34	11.46	34.54	50.94	74	23.06	Peak
Vertical	3484	42.31	31.28	6.36	35.14	44.81	74	29.19	Peak
	4924	44.46	33.72	7.67	34.72	51.13	74	22.87	Peak
	4924	34.74	33.72	7.67	34.72	41.41	54	12.59	Average
	6304	37.84	34.36	8.68	34.73	46.15	74	27.85	Peak
	8164	37.85	38	10.34	34.78	51.41	74	22.59	Peak
	10228	35.85	38.36	11.42	34.56	51.07	74	22.93	Peak

802.11g CH2437MHz

Polarization	Frequency (MHz)	Meter Reading dB (μV)	Antenna Factor (dB/m)	Cable Loss (dB)	Preamplifier Factor (dB)	Emission Level dB (μV/m)	Limits dB (μV/m)	Margin (dB)	Remark
Horizontal	3484	42.14	31.28	6.36	35.14	44.64	74	29.36	Peak
	4874	44.42	33.49	7.61	34.74	50.78	74	23.22	Peak
	4874	34.24	33.49	7.61	34.74	40.6	54	13.4	Average
	6712	37.59	34.93	9.01	34.77	46.76	74	27.24	Peak
	8752	36.86	38.38	10.58	34.72	51.1	74	22.9	Peak
	10660	35.33	38.46	11.55	34.47	50.87	74	23.13	Peak
Vertical	3496	42.08	31.3	6.36	35.14	44.6	74	29.4	Peak
	4874	43.86	33.49	7.61	34.74	50.22	74	23.78	Peak
	4874	34.59	33.49	7.61	34.74	40.95	54	13.05	Average
	6292	38.07	34.36	8.68	34.73	46.38	74	27.62	Peak
	8188	36.19	38.04	10.34	34.78	49.79	74	24.21	Peak
	10504	35.91	38.3	11.51	34.5	51.22	74	22.78	Peak

802.11n20 CH2437MHz

Polarization	Frequency (MHz)	Meter Reading dB (μV)	Antenna Factor (dB/m)	Cable Loss (dB)	Preamplifier Factor (dB)	Emission Level dB (μV/m)	Limits dB (μV/m)	Margin (dB)	Remark
Horizontal	3472	41.99	31.25	6.36	35.15	44.45	74	29.55	Peak
	4874	44.37	33.49	7.61	34.74	50.73	74	23.27	Peak
	4874	34.64	33.49	7.61	34.74	41	54	13	Average
	6820	38	35.17	9.09	34.78	47.48	74	26.52	Peak
	8524	36.69	38.58	10.46	34.75	50.98	74	23.02	Peak
	10192	36.62	38.36	11.42	34.57	51.83	74	22.17	Peak
Vertical	3472	42.3	31.25	6.36	35.15	44.76	74	29.24	Peak
	4874	42.96	33.49	7.61	34.74	49.32	74	24.68	Peak
	4874	33.8	33.49	7.61	34.74	40.16	54	13.84	Average
	6256	38.52	34.35	8.6	34.73	46.74	74	27.26	Peak
	8056	37.09	37.83	10.28	34.79	50.41	74	23.59	Peak
	10144	36.26	38.37	11.37	34.57	51.43	74	22.57	Peak

TEST ENGINEER: Jarey

Band-Edge:

EUT : LED Lamp Temperature : 22°C
 Model No. : CLEDA2116CD Humidity : 51%RH
 Test Mode : Transmitting Date of Test : 2022.02.27

802.11b CH2412MHz

Polarization	Frequency (MHz)	Meter Reading dB (μV)	Antenna Factor (dB/m)	Cable Loss (dB)	Preamp Factor (dB)	Emission Level dB (μV/m)	Limits dB (μV/m)	Margin (dB)	Remark
Horizontal	2390	51.68	28.21	5.36	35.86	49.39	74	24.61	Peak
	2390	40.27	28.21	5.36	35.86	37.98	54	16.02	Average
Vertical	2390	53.44	28.21	5.36	35.86	51.15	74	22.85	Peak
	2390	42.34	28.21	5.36	35.86	40.05	54	13.95	Average

802.11b CH2462MHz

Polarization	Frequency (MHz)	Meter Reading dB (μV)	Antenna Factor (dB/m)	Cable Loss (dB)	Preamp Factor (dB)	Emission Level dB (μV/m)	Limits dB (μV/m)	Margin (dB)	Remark
Horizontal	2483.5	49.5	28.46	5.43	35.76	47.63	74	26.37	Peak
	2483.5	38.25	28.46	5.43	35.76	36.38	54	17.62	Average
Vertical	2483.5	53.42	28.46	5.43	35.76	51.55	74	22.45	Peak
	2483.5	41.54	28.46	5.43	35.76	39.67	54	14.33	Average

802.11g CH2412MHz

Polarization	Frequency (MHz)	Meter Reading dB (μV)	Antenna Factor (dB/m)	Cable Loss (dB)	Preamp Factor (dB)	Emission Level dB (μV/m)	Limits dB (μV/m)	Margin (dB)	Remark
Horizontal	2390	62.26	28.21	5.36	35.86	59.97	74	14.03	Peak
	2390	43.42	28.21	5.36	35.86	41.13	54	12.87	Average
Vertical	2390	65.84	28.21	5.36	35.86	63.55	74	10.45	Peak
	2390	45.58	28.21	5.36	35.86	43.29	54	10.71	Average

802.11g CH2462MHz

Polarization	Frequency (MHz)	Meter Reading dB (μV)	Antenna Factor (dB/m)	Cable Loss (dB)	Preamp Factor (dB)	Emission Level dB (μV/m)	Limits dB (μV/m)	Margin (dB)	Remark
Horizontal	2483.5	58.65	28.46	5.43	35.76	56.78	74	17.22	Peak
	2483.5	39.46	28.46	5.43	35.76	37.59	54	16.41	Average
Vertical	2483.5	64.26	28.46	5.43	35.76	62.39	74	11.61	Peak
	2483.5	43.43	28.46	5.43	35.76	41.56	54	12.44	Average

802.11n20 CH2412MHz

Polarization	Frequency (MHz)	Meter Reading dB (μV)	Antenna Factor (dB/m)	Cable Loss (dB)	Preamp Factor (dB)	Emission Level dB (μV/m)	Limits dB (μV/m)	Margin (dB)	Remark
Horizontal	2390	57.22	28.21	5.36	35.86	54.93	74	19.07	Peak
	2390	41.62	28.21	5.36	35.86	39.33	54	14.67	Average
Vertical	2390	61.56	28.21	5.36	35.86	59.27	74	14.73	Peak
	2390	44.35	28.21	5.36	35.86	42.06	54	11.94	Average

802.11n20 CH2462MHz

Polarization	Frequency (MHz)	Meter Reading dB (μV)	Antenna Factor (dB/m)	Cable Loss (dB)	Preamp Factor (dB)	Emission Level dB (μV/m)	Limits dB (μV/m)	Margin (dB)	Remark
Horizontal	2483.5	54.55	28.46	5.43	35.76	52.68	74	21.32	Peak
	2483.5	39.65	28.46	5.43	35.76	37.78	54	16.22	Average
Vertical	2483.5	62.5	28.46	5.43	35.76	60.63	74	13.37	Peak
	2483.5	43.65	28.46	5.43	35.76	41.78	54	12.22	Average

Emissions in restricted frequency bands:

EUT : LED Lamp Temperature : 22°C
 Model No. : CLEDA2116CD Humidity : 51%RH
 Test Mode : Transmitting Date of Test : 2022.02.27

802.11b CH2412MHz

Polarization	Frequency (MHz)	Meter Reading dB (µV)	Antenna Factor (dB/m)	Cable Loss (dB)	Preamp Factor (dB)	Emission Level dB (µV/m)	Limits dB (µV/m)	Margin (dB)	Remark
Horizontal	2314.4	51.54	28.01	5.29	35.94	48.9	74	25.1	Peak
	2314.4	39.35	28.01	5.29	35.94	36.71	54	17.29	Average
	2335.6	51.56	28.06	5.29	35.92	48.99	74	25.01	Peak
	2335.6	40.16	28.06	5.29	35.92	37.59	54	16.41	Average
	2392.8	54.71	28.23	5.36	35.86	52.44	74	21.56	Peak
	2392.8	41.47	28.23	5.36	35.86	39.2	54	14.8	Average
Vertical	2331.7	54.83	28.06	5.29	35.93	52.25	74	21.75	Peak
	2331.7	45.59	28.06	5.29	35.93	43.01	54	10.99	Average
	2359.8	52.05	28.14	5.32	35.89	49.62	74	24.38	Peak
	2359.8	41.2	28.14	5.32	35.89	38.77	54	15.23	Average
	2385.7	55.32	28.21	5.36	35.87	53.02	74	20.98	Peak
	2385.7	42.43	28.21	5.36	35.87	40.13	54	13.87	Average

802.11b CH2447MHz

Polarization	Frequency (MHz)	Meter Reading dB (µV)	Antenna Factor (dB/m)	Cable Loss (dB)	Preamp Factor (dB)	Emission Level dB (µV/m)	Limits dB (µV/m)	Margin (dB)	Remark
Horizontal	2485.2	51.16	28.46	5.47	35.76	49.33	74	24.67	Peak
	2485.2	39.31	28.46	5.47	35.76	37.48	54	16.52	Average
	2492.1	51.93	28.48	5.47	35.76	50.12	74	23.88	Peak
	2492.1	38.56	28.48	5.47	35.76	36.75	54	17.25	Average
	2497.9	51.4	28.5	5.47	35.76	49.61	74	24.39	Peak
	2497.9	39.44	28.5	5.47	35.76	37.65	54	16.35	Average
Vertical	2484.8	53.45	28.46	5.47	35.76	51.62	74	22.38	Peak
	2484.8	41.44	28.46	5.47	35.76	39.61	54	14.39	Average
	2490.5	52.92	28.48	5.47	35.76	51.11	74	22.89	Peak
	2490.5	40.59	28.48	5.47	35.76	38.78	54	15.22	Average
	2496.3	53.17	28.5	5.47	35.76	51.38	74	22.62	Peak
	2496.3	41.32	28.5	5.47	35.76	39.53	54	14.47	Average

802.11b CH2462MHz

Polarization	Frequency (MHz)	Meter Reading dB (μV)	Antenna Factor (dB/m)	Cable Loss (dB)	Preamp Factor (dB)	Emission Level dB (μV/m)	Limits dB (μV/m)	Margin (dB)	Remark
Horizontal	2484.9	50.9	28.46	5.47	35.76	49.07	74	24.93	Peak
	2484.9	39.39	28.46	5.47	35.76	37.56	54	16.44	Average
	2490.3	50.43	28.48	5.47	35.76	48.62	74	25.38	Peak
	2490.3	40.14	28.48	5.47	35.76	38.33	54	15.67	Average
	2495.5	50.99	28.48	5.47	35.76	49.18	74	24.82	Peak
	2495.5	38.7	28.48	5.47	35.76	36.89	54	17.11	Average
Vertical	2490.2	57.03	28.48	5.47	35.76	55.22	74	18.78	Peak
	2490.2	40.4	28.48	5.47	35.76	38.59	54	15.41	Average
	2492.4	56.21	28.48	5.47	35.76	54.4	74	19.6	Peak
	2492.4	40.52	28.48	5.47	35.76	38.71	54	15.29	Average
	2496.1	54.76	28.48	5.47	35.76	52.95	74	21.05	Peak
	2496.1	41.58	28.48	5.47	35.76	39.77	54	14.23	Average

802.11g CH2412MHz

Polarization	Frequency (MHz)	Meter Reading dB (μV)	Antenna Factor (dB/m)	Cable Loss (dB)	Preamp Factor (dB)	Emission Level dB (μV/m)	Limits dB (μV/m)	Margin (dB)	Remark
Horizontal	2327.4	50.73	28.05	5.29	35.93	48.14	74	25.86	Peak
	2327.4	40.27	28.05	5.29	35.93	37.68	54	16.32	Average
	2368.2	52.93	28.15	5.32	35.89	50.51	74	23.49	Peak
	2368.2	40.51	28.15	5.32	35.89	38.09	54	15.91	Average
	2387.1	61.45	28.21	5.36	35.87	59.15	74	14.85	Peak
	2387.1	42.35	28.21	5.36	35.87	40.05	54	13.95	Average
Vertical	2329.9	55.37	28.06	5.29	35.93	52.79	74	21.21	Peak
	2329.9	43.44	28.06	5.29	35.93	40.86	54	13.14	Average
	2378.9	61.46	28.19	5.36	35.88	59.13	74	14.87	Peak
	2378.9	44.25	28.19	5.36	35.88	41.92	54	12.08	Average
	2389.7	66.39	28.21	5.36	35.86	64.1	74	9.9	Peak
	2389.7	45.54	28.21	5.36	35.86	43.25	54	10.75	Average

802.11g CH2422MHz

Polarization	Frequency (MHz)	Meter Reading dB (μV)	Antenna Factor (dB/m)	Cable Loss (dB)	Preamp Factor (dB)	Emission Level dB (μV/m)	Limits dB (μV/m)	Margin (dB)	Remark
Horizontal	2329	51.26	28.06	5.29	35.93	48.68	74	25.32	Peak
	2329	42.23	28.06	5.29	35.93	39.65	54	14.35	Average
	2361.2	53.38	28.14	5.32	35.89	50.95	74	23.05	Peak
	2361.2	40.14	28.14	5.32	35.89	37.71	54	16.29	Average
	2389.1	64.47	28.21	5.36	35.86	62.18	74	11.82	Peak
	2389.1	46.75	28.21	5.36	35.86	44.46	54	9.54	Average
Vertical	2319.4	53.05	28.03	5.29	35.93	50.44	74	23.56	Peak
	2319.4	40.2	28.03	5.29	35.93	37.59	54	16.41	Average
	2349	56.66	28.1	5.32	35.9	54.18	74	19.82	Peak
	2349	44.47	28.1	5.32	35.9	41.99	54	12.01	Average
	2387.3	67.42	28.21	5.36	35.86	65.13	74	8.87	Peak
	2387.3	48.74	28.21	5.36	35.86	46.45	54	7.55	Average

802.11g CH2447MHz

Polarization	Frequency (MHz)	Meter Reading dB (μV)	Antenna Factor (dB/m)	Cable Loss (dB)	Preamp Factor (dB)	Emission Level dB (μV/m)	Limits dB (μV/m)	Margin (dB)	Remark
Horizontal	2484.4	57.29	28.46	5.47	35.76	55.46	74	18.54	Peak
	2484.4	41.42	28.46	5.47	35.76	39.59	54	14.41	Average
	2490.2	52.63	28.48	5.47	35.76	50.82	74	23.18	Peak
	2490.2	40.16	28.48	5.47	35.76	38.35	54	15.65	Average
	2495.7	51.85	28.48	5.47	35.76	50.04	74	23.96	Peak
	2495.7	39.29	28.48	5.47	35.76	37.48	54	16.52	Average
Vertical	2484.3	63.6	28.46	5.47	35.76	61.77	74	12.23	Peak
	2484.3	44.56	28.46	5.47	35.76	42.73	54	11.27	Average
	2490.8	58.14	28.48	5.47	35.76	56.33	74	17.67	Peak
	2490.8	43.31	28.48	5.47	35.76	41.5	54	12.5	Average
	2496.3	56.11	28.5	5.47	35.76	54.32	74	19.68	Peak
	2496.3	41.51	28.5	5.47	35.76	39.72	54	14.28	Average

802.11g CH2462MHz

Polarization	Frequency (MHz)	Meter Reading dB (μV)	Antenna Factor (dB/m)	Cable Loss (dB)	Preamp Factor (dB)	Emission Level dB (μV/m)	Limits dB (μV/m)	Margin (dB)	Remark
Horizontal	2483.6	58.88	28.46	5.43	35.76	57.01	74	16.99	Peak
	2483.6	39.39	28.46	5.43	35.76	37.52	54	16.48	Average
	2485.7	56.67	28.46	5.47	35.76	54.84	74	19.16	Peak
	2485.7	38.66	28.46	5.47	35.76	36.83	54	17.17	Average
	2493.4	51.35	28.48	5.47	35.76	49.54	74	24.46	Peak
	2493.4	38.54	28.48	5.47	35.76	36.73	54	17.27	Average
Vertical	2483.6	64.35	28.46	5.43	35.76	62.48	74	11.52	Peak
	2483.6	43.53	28.46	5.43	35.76	41.66	54	12.34	Average
	2490	55.08	28.48	5.47	35.76	53.27	74	20.73	Peak
	2490	40.5	28.48	5.47	35.76	38.69	54	15.31	Average
	2494	53.75	28.48	5.47	35.76	51.94	74	22.06	Peak
	2494	41.38	28.48	5.47	35.76	39.57	54	14.43	Average

802.11n20 CH2412MHz

Polarization	Frequency (MHz)	Meter Reading dB (μV)	Antenna Factor (dB/m)	Cable Loss (dB)	Preamp Factor (dB)	Emission Level dB (μV/m)	Limits dB (μV/m)	Margin (dB)	Remark
Horizontal	2328.7	52.08	28.05	5.29	35.93	49.49	74	24.51	Peak
	2328.7	40.41	28.05	5.29	35.93	37.82	54	16.18	Average
	2364.4	51.99	28.15	5.32	35.89	49.57	74	24.43	Peak
	2364.4	39.31	28.15	5.32	35.89	36.89	54	17.11	Average
	2389.6	59.33	28.21	5.36	35.86	57.04	74	16.96	Peak
	2389.6	41.13	28.21	5.36	35.86	38.84	54	15.16	Average
Vertical	2329.6	55.18	28.06	5.29	35.93	52.6	74	21.4	Peak
	2329.6	43.33	28.06	5.29	35.93	40.75	54	13.25	Average
	2370	54.16	28.17	5.32	35.89	51.76	74	22.24	Peak
	2370	41.43	28.17	5.32	35.89	39.03	54	14.97	Average
	2384.8	60.63	28.21	5.36	35.87	58.33	74	15.67	Peak
	2384.8	43.46	28.21	5.36	35.87	41.16	54	12.84	Average

802.11n20 CH2422MHz

Polarization	Frequency (MHz)	Meter Reading dB (μV)	Antenna Factor (dB/m)	Cable Loss (dB)	Preamp Factor (dB)	Emission Level dB (μV/m)	Limits dB (μV/m)	Margin (dB)	Remark
Horizontal	2329.4	50.5	28.06	5.29	35.93	47.92	74	26.08	Peak
	2329.4	39.66	28.06	5.29	35.93	37.08	54	16.92	Average
	2369.7	54.73	28.15	5.32	35.89	52.31	74	21.69	Peak
	2369.7	39.49	28.15	5.32	35.89	37.07	54	16.93	Average
	2383.7	62.77	28.21	5.36	35.87	60.47	74	13.53	Peak
	2383.7	43.38	28.21	5.36	35.87	41.08	54	12.92	Average
Vertical	2334.4	56.33	28.06	5.29	35.92	53.76	74	20.24	Peak
	2334.4	44.44	28.06	5.29	35.92	41.87	54	12.13	Average
	2369.3	56.74	28.15	5.32	35.89	54.32	74	19.68	Peak
	2369.3	40.59	28.15	5.32	35.89	38.17	54	15.83	Average
	2383.8	66.95	28.21	5.36	35.87	64.65	74	9.35	Peak
	2383.8	45.8	28.21	5.36	35.87	43.5	54	10.5	Average

802.11n20 CH2447MHz

Polarization	Frequency (MHz)	Meter Reading dB (μV)	Antenna Factor (dB/m)	Cable Loss (dB)	Preamp Factor (dB)	Emission Level dB (μV/m)	Limits dB (μV/m)	Margin (dB)	Remark
Horizontal	2486.2	54.99	28.46	5.47	35.76	53.16	74	20.84	Peak
	2486.2	39.6	28.46	5.47	35.76	37.77	54	16.23	Average
	2490.9	54.39	28.48	5.47	35.76	52.58	74	21.42	Peak
	2490.9	38.73	28.48	5.47	35.76	36.92	54	17.08	Average
	2496.1	51.34	28.48	5.47	35.76	49.53	74	24.47	Peak
	2496.1	38.54	28.48	5.47	35.76	36.73	54	17.27	Average
Vertical	2486.8	62.32	28.46	5.47	35.76	60.49	74	13.51	Peak
	2486.8	42.43	28.46	5.47	35.76	40.6	54	13.4	Average
	2490.8	59.6	28.48	5.47	35.76	57.79	74	16.21	Peak
	2490.8	42.55	28.48	5.47	35.76	40.74	54	13.26	Average
	2496.6	56.35	28.5	5.47	35.76	54.56	74	19.44	Peak
	2496.6	41.73	28.5	5.47	35.76	39.94	54	14.06	Average

802.11n20 CH2462MHz

Polarization	Frequency (MHz)	Meter Reading dB (μV)	Antenna Factor (dB/m)	Cable Loss (dB)	Preamp Factor (dB)	Emission Level dB (μV/m)	Limits dB (μV/m)	Margin (dB)	Remark
Horizontal	2484.6	55.13	28.46	5.47	35.76	53.3	74	20.7	Peak
	2484.6	39.41	28.46	5.47	35.76	37.58	54	16.42	Average
	2491.2	50.72	28.48	5.47	35.76	48.91	74	25.09	Peak
	2491.2	38.27	28.48	5.47	35.76	36.46	54	17.54	Average
	2498.4	50.51	28.5	5.47	35.76	48.72	74	25.28	Peak
	2498.4	38.55	28.5	5.47	35.76	36.76	54	17.24	Average
Vertical	2485.6	61.99	28.46	5.47	35.76	60.16	74	13.84	Peak
	2485.6	42.39	28.46	5.47	35.76	40.56	54	13.44	Average
	2493.1	56.51	28.48	5.47	35.76	54.7	74	19.3	Peak
	2493.1	41.35	28.48	5.47	35.76	39.54	54	14.46	Average
	2499.2	54.84	28.5	5.47	35.75	53.06	74	20.94	Peak
	2499.2	41.58	28.5	5.47	35.75	39.8	54	14.2	Average

TEST ENGINEER: Jarey

5 99% OCCUPIED BANDWIDTH MEASUREMENT

5.1 Test Equipment

The following test equipment was used during the Emission Bandwidth measurement:

Item	Type	Manufacturer	Model No.	Serial No.	Cal. Date	Cal. Interval
1.	Spectrum Analyzer	Agilent	N9010A	MY52221182	2021.09.15	1 Year
2.	Coaxial Cable	WOKEN	SFL402-105F LEX	F02-150819-045	2021.03.08	1 Year
3.	20 dB Attenuator	Mini-Circuits	VAT-20+	001	2021.08.06	1 Year

5.2 Block Diagram of Test Setup

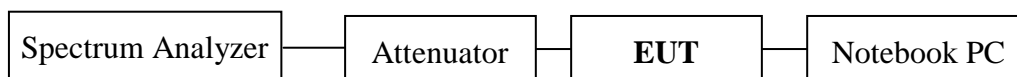

5.3 Operating Condition of EUT

The switch ON/OFF was used to enable the EUT to change the channel one by one.

5.4 Test Procedure

The transmitter output was connected to the spectrum analyzer. The bandwidth of 99% power bandwidth was measure by spectrum analyzer with settings: Span = between 1.5 times and 5.0 times of the OBW, RBW = 1% to 5% of the OBW, VBW $\geq 3 \times$ RBW, Detector = Peak, Trace = Max Hold.

Use the 99% power bandwidth function of the instrument and report the measured bandwidth.

The test procedure is defined in ANSI C63.10-2013 (the 6.9.3 Measurement Procedure “Occupied bandwidth—power bandwidth (99%) measurement procedure” was used).

5.5 Test Results

PASSED.

All the test results are attached in next pages.

(Test Date: 2022.02.22 Temperature: 23°C Humidity: 51 %)

Modulation	Channel	Frequency (MHz)	99% Bandwidth (MHz)
802.11b	1	2412	13.97
	6	2437	13.949
	11	2462	13.991
802.11g	1	2412	17.16
	6	2437	17.377
	11	2462	17.159
802.11n20	1	2412	18.147
	6	2437	18.233
	11	2462	18.155

802.11b CH2412MHz

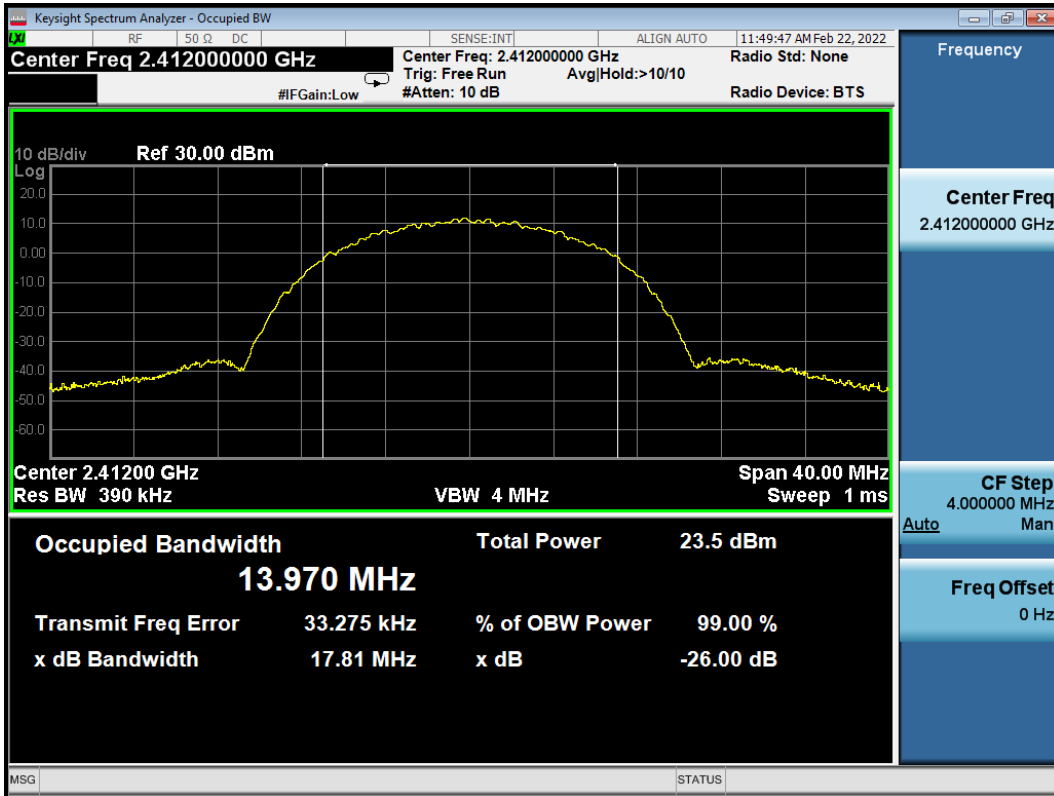

802.11b CH2437MHz

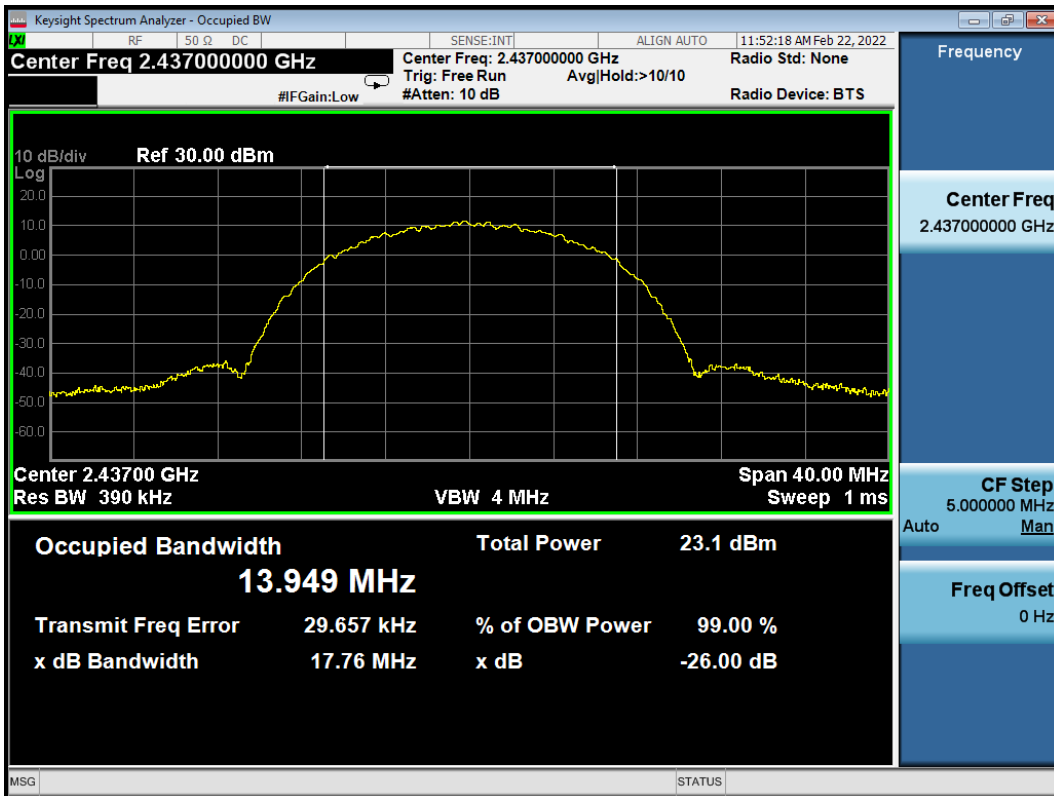

802.11b CH2462MHz

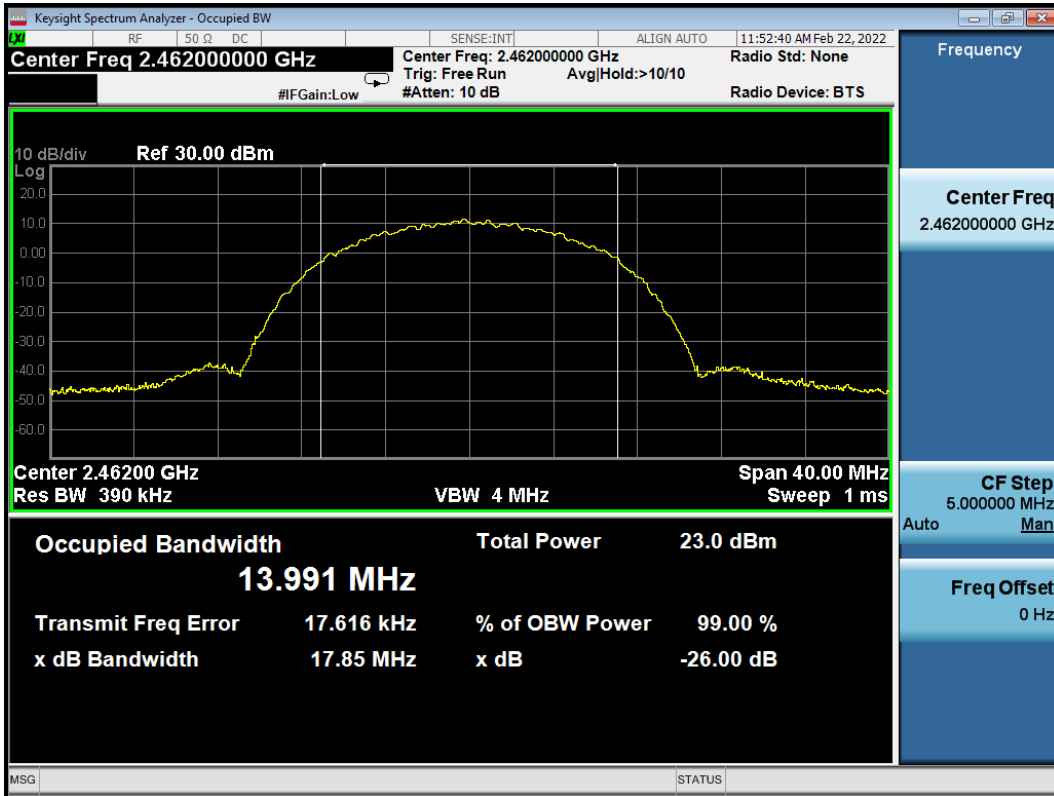

802.11g CH2412MHz

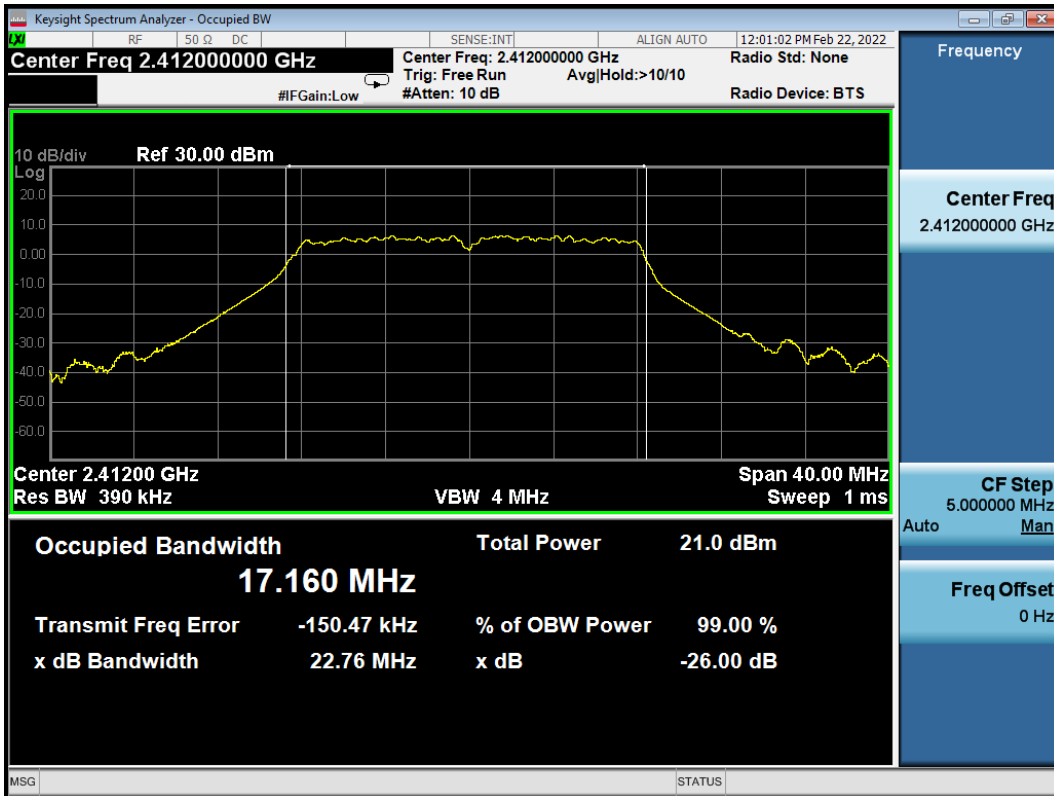

802.11g CH2437MHz

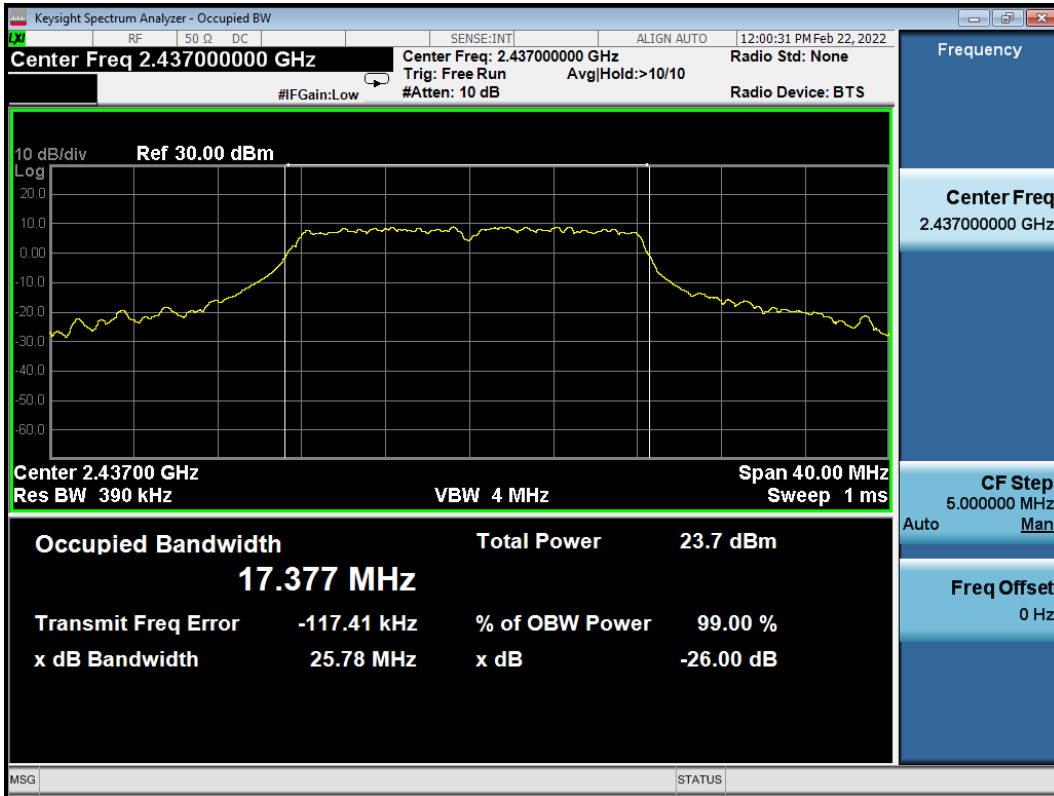

802.11g CH2462MHz

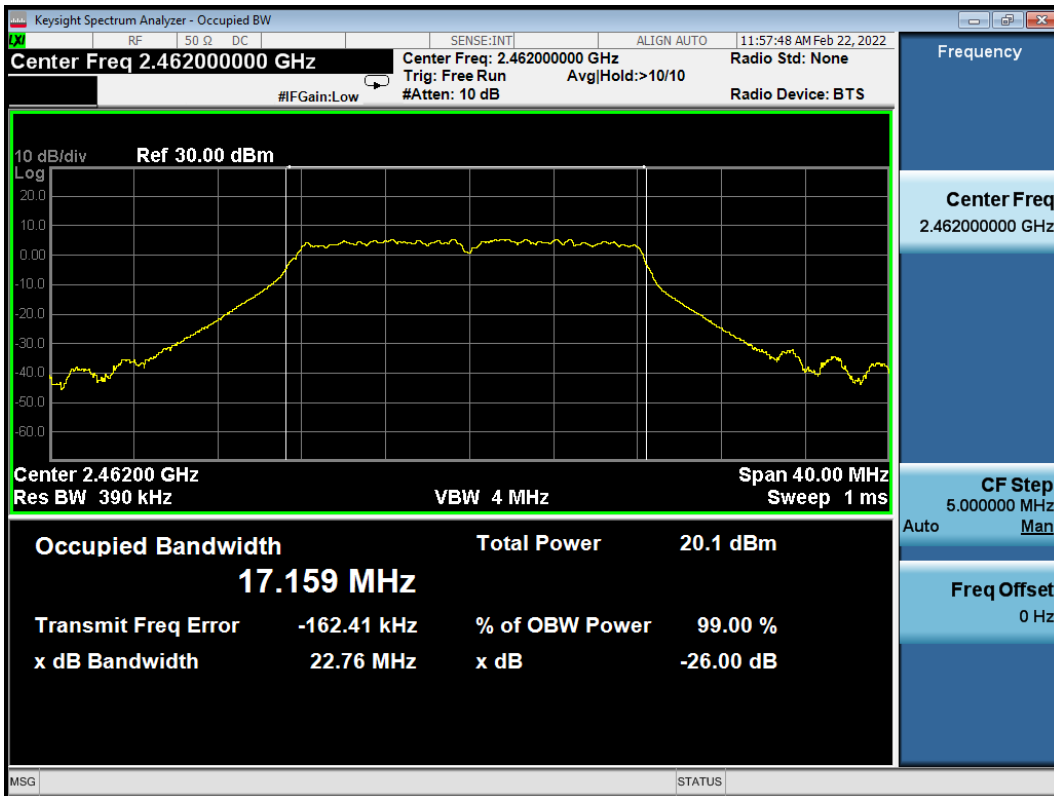

802.11n20 CH2412MHz

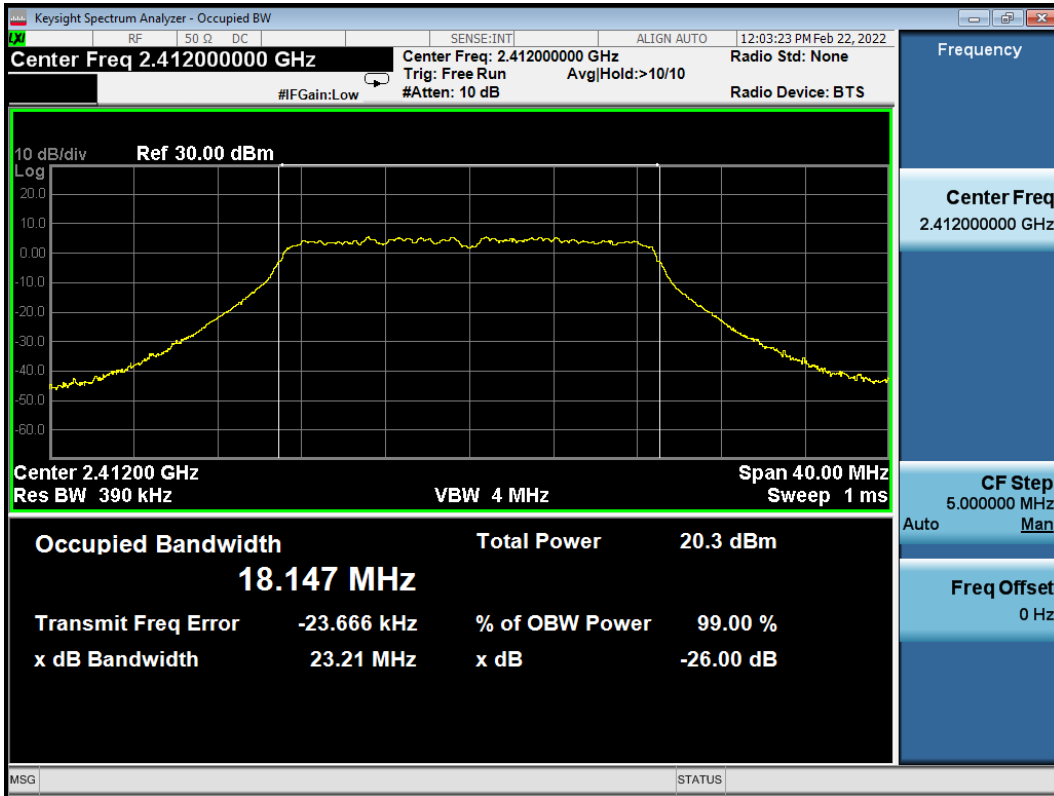

802.11n20 CH2437MHz

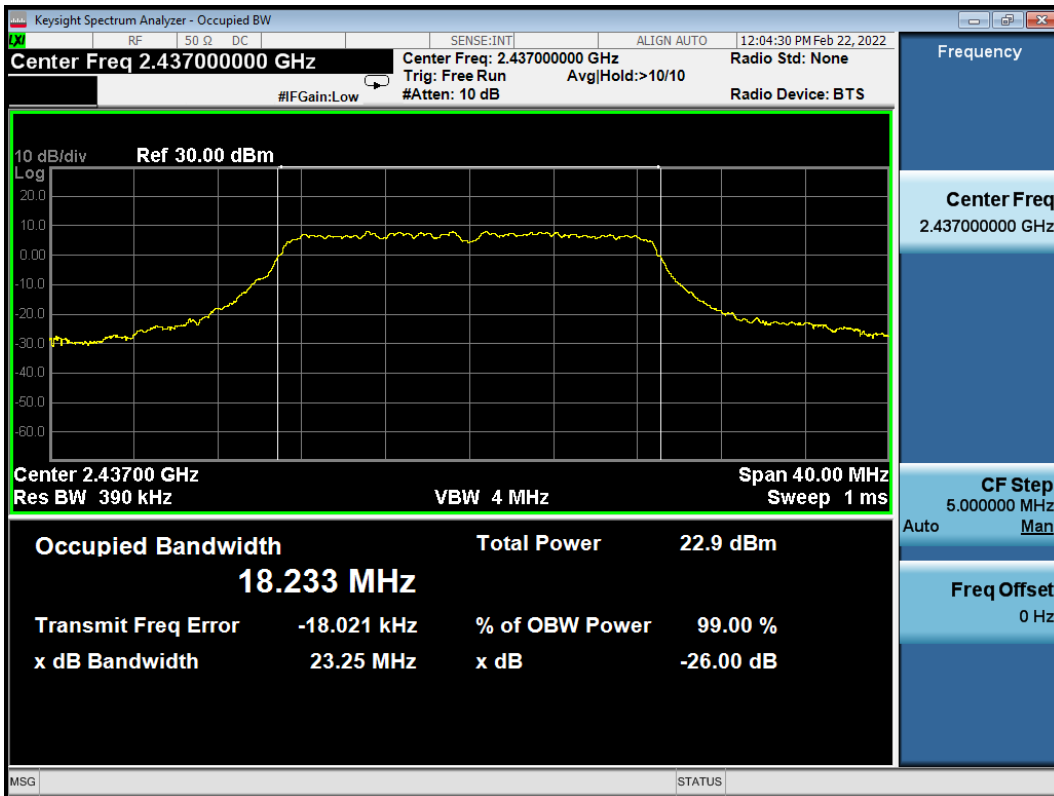

802.11n20 CH2462MHz

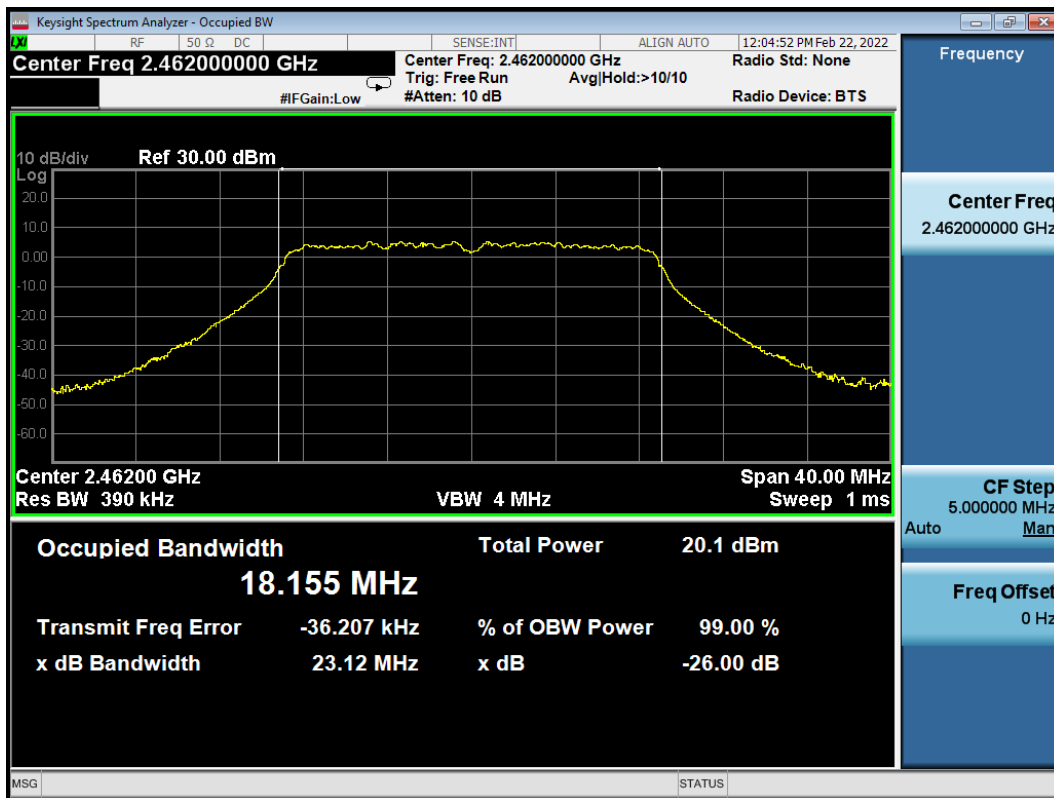

6 6 dB BANDWIDTH MEASUREMENT

6.1 Test Equipment

The following test equipment was used during the Emission Bandwidth measurement:

Item	Type	Manufacturer	Model No.	Serial No.	Cal. Date	Cal. Interval
1.	Spectrum Analyzer	Agilent	N9010A	MY52221182	2021.09.15	1 Year
2.	Coaxial Cable	WOKEN	SFL402-105F LEX	F02-150819-045	2021.03.08	1 Year
3.	20 dB Attenuator	Mini-Circuits	VAT-20+	001	2021.08.06	1 Year

6.2 Block Diagram of Test Setup

The Same as Section. 5.2.

6.3 Specification Limits (§15.247(a)(2))

The minimum 6 dB bandwidth shall be at least 500 kHz.

6.4 Operating Condition of EUT

The switch ON/OFF was used to enable the EUT to change the channel one by one.

6.5 Test Procedure

The transmitter output was connected to the spectrum analyzer. The bandwidth of the fundamental frequency was measure by spectrum analyzer with settings: RBW = 100kHz, VBW $\geq 3 \times$ RBW.

The 6 dB bandwidth is defined as the total spectrum the power of which is lower than peak power minus 6 dB .

The test procedure is defined in ANSI C63.10-2013 (the 11.8.2 Measurement Procedure “Option 2” was used).

6.6 Test Results

PASSED.

All the test results are attached in next pages.

(Test Date: 2022.02.22 Temperature: 23°C Humidity: 51 %)

Modulation	Channel	Frequency (MHz)	6dB Bandwidth (MHz)	Limit
802.11b	1	2412	8.431	500 kHz
	6	2437	8.425	500 kHz
	11	2462	8.431	500 kHz
802.11g	1	2412	16.57	500 kHz
	6	2437	16.57	500 kHz
	11	2462	16.57	500 kHz
802.11n20	1	2412	17.77	500 kHz
	6	2437	17.79	500 kHz
	11	2462	17.76	500 kHz

802.11b CH2412MHz

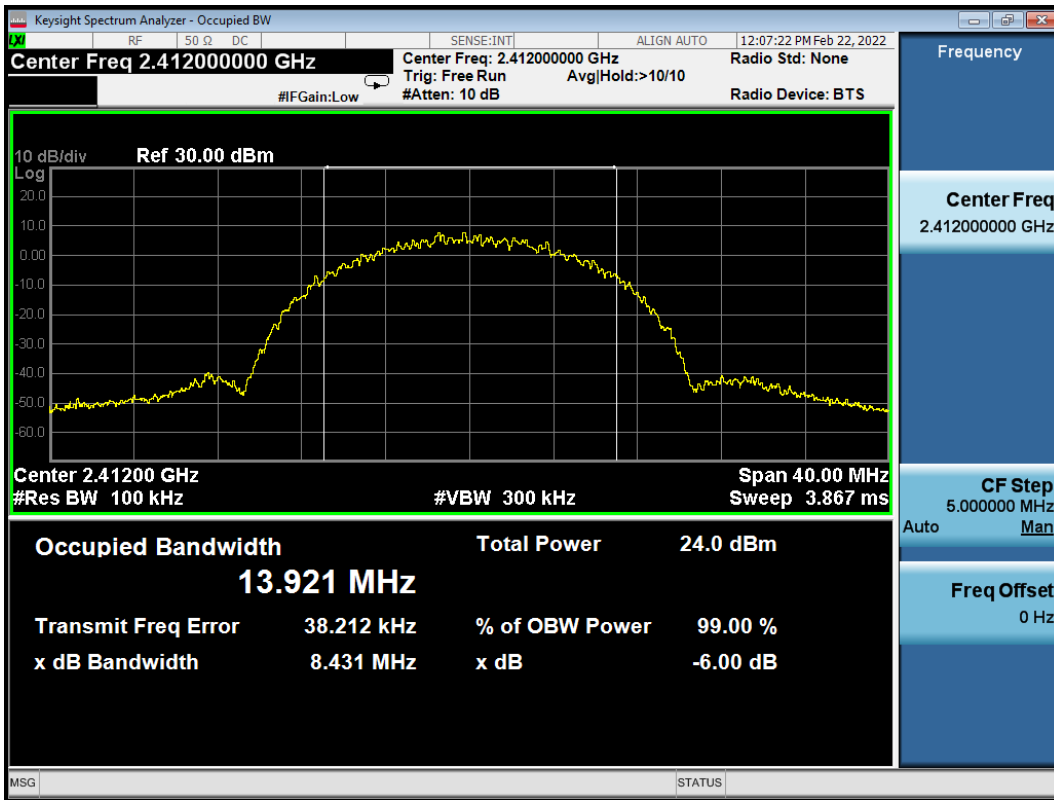

802.11b CH2437MHz

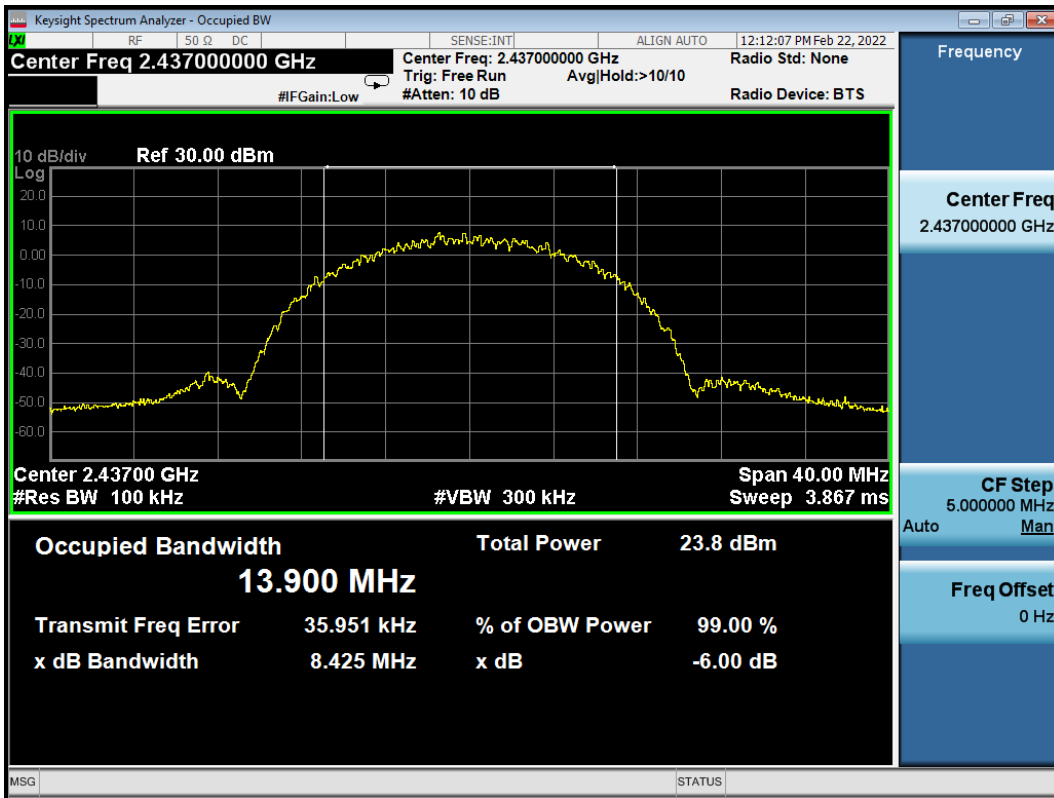

802.11b CH2462MHz

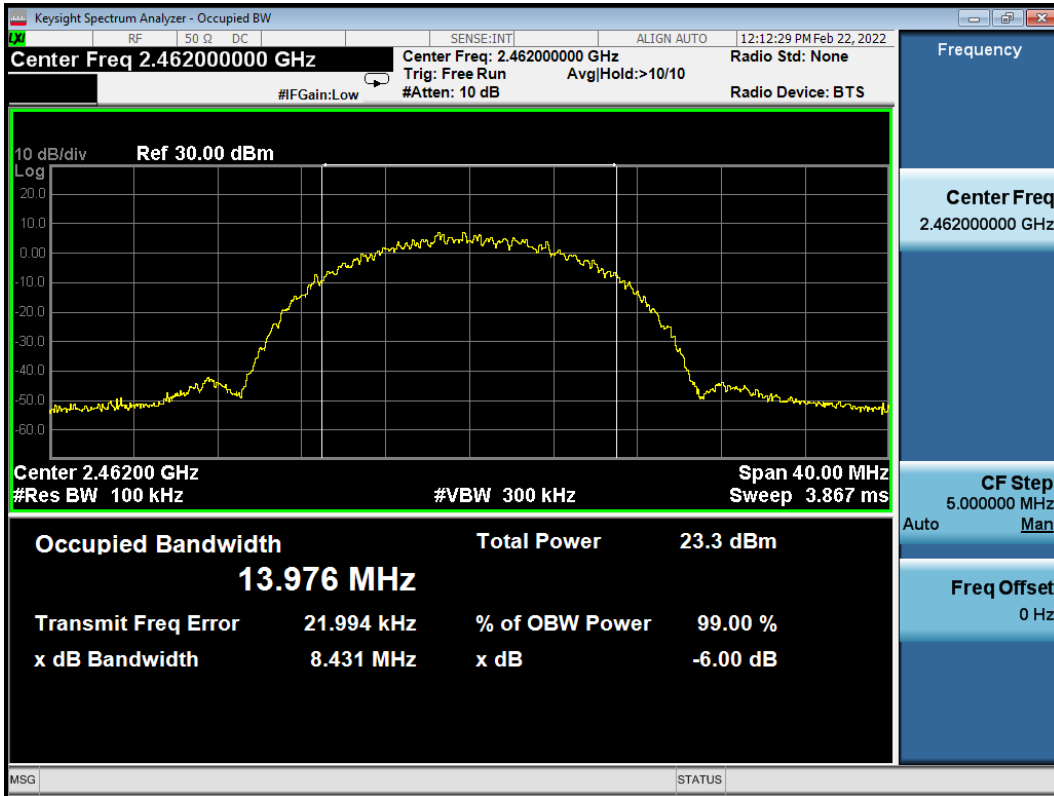

802.11g CH2412MHz

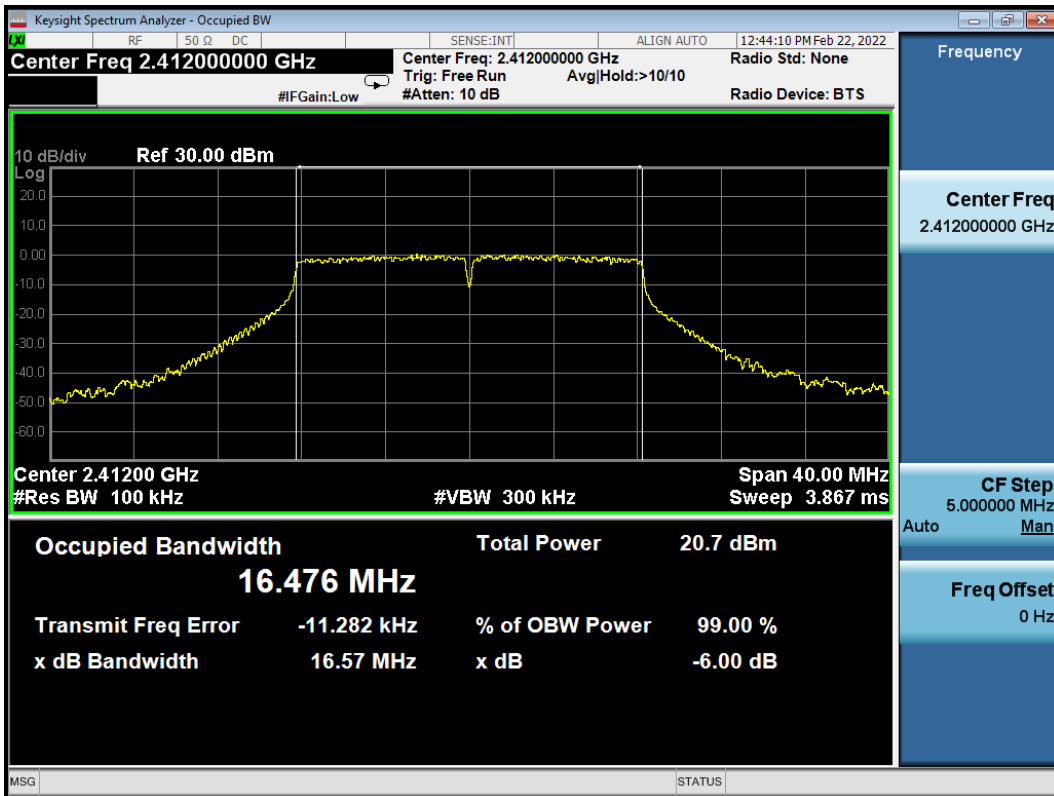

802.11g CH2437MHz

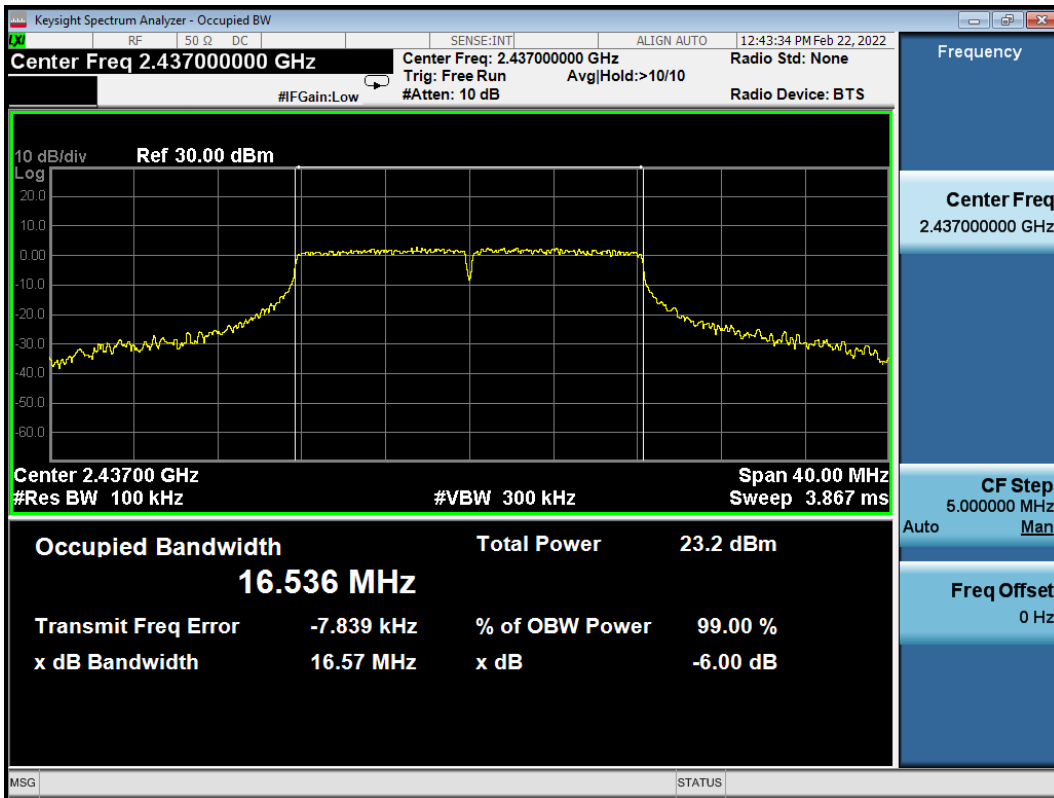

802.11g CH2462MHz

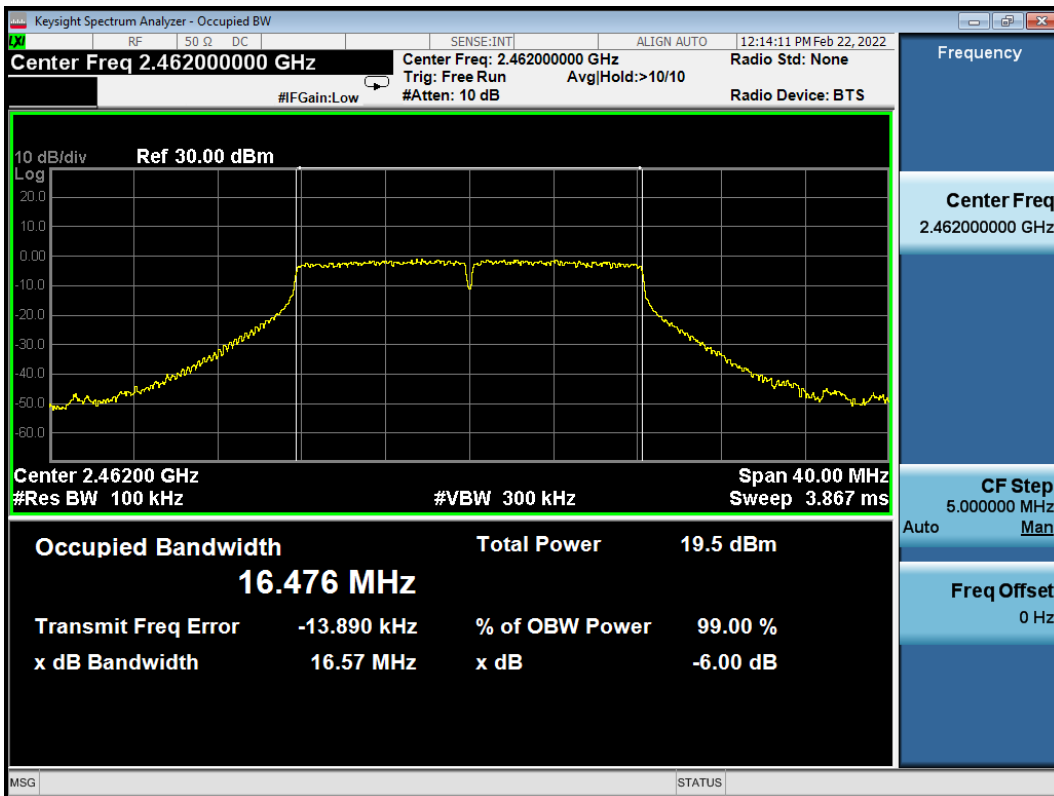

802.11n20 CH2412MHz

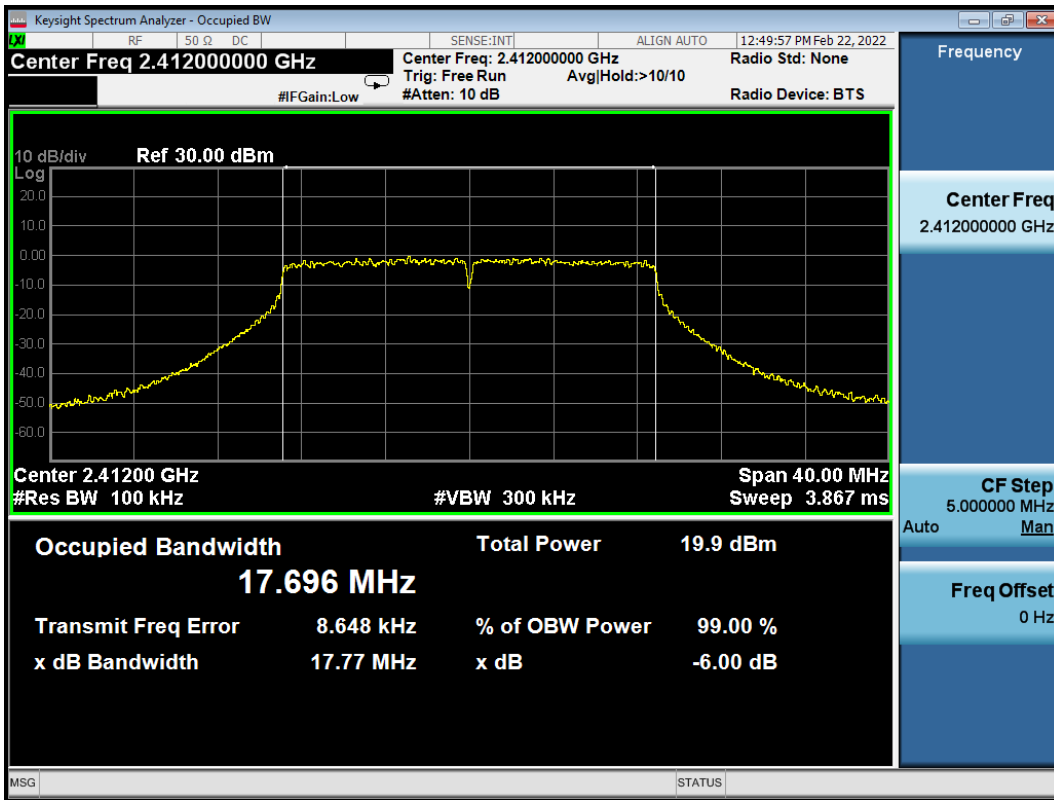

802.11n20 CH2437MHz

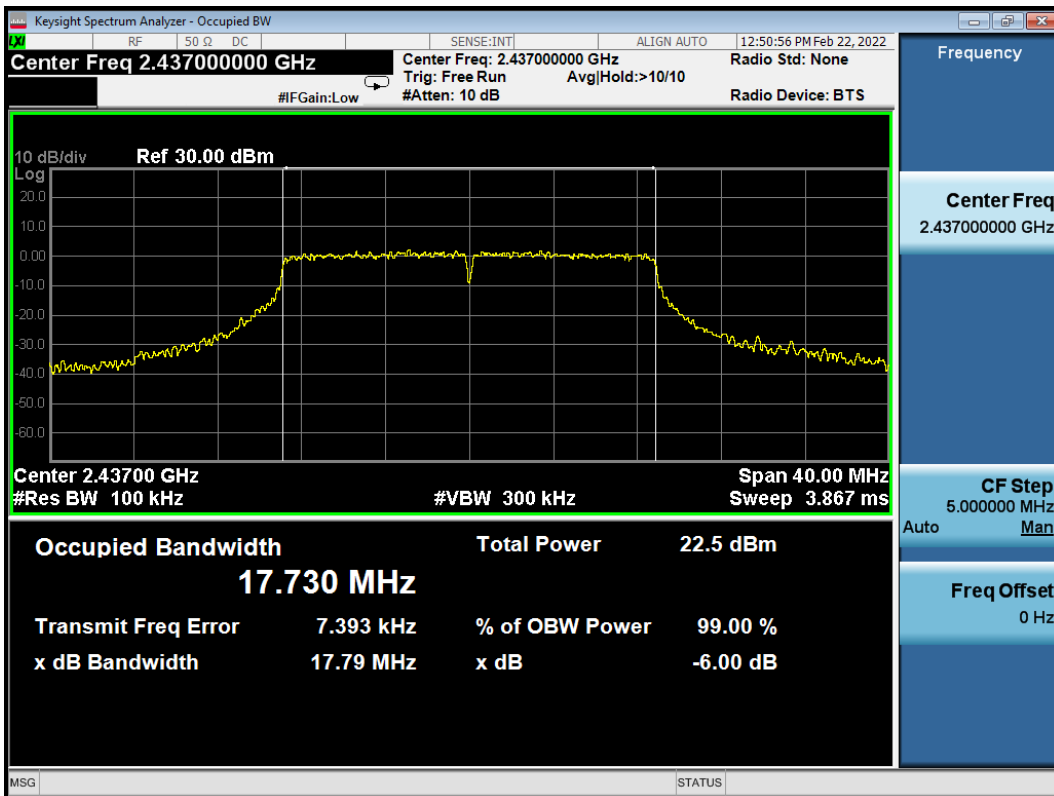

802.11n20 CH2462MHz

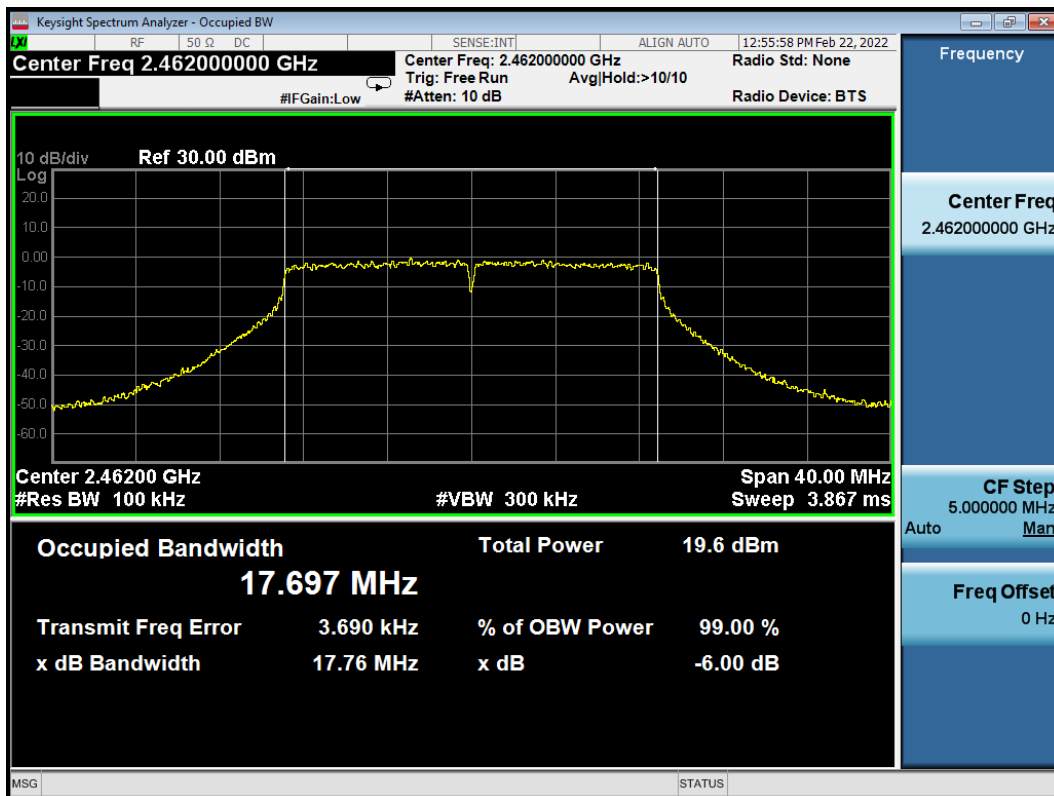

7 MAXIMUM PEAK OUTPUT POWER MEASUREMENT

7.1 Test Equipment

The following test equipment was used during the maximum peak output power measurement:

Item	Type	Manufacturer	Model No.	Serial No.	Cal. Date	Cal. Interval
1.	Spectrum Analyzer	Agilent	N9010A	MY52221182	2021.09.15	1 Year
2.	Coaxial Cable	WOKEN	SFL402-105F LEX	F02-150819-045	2021.03.08	1 Year
3.	20 dB Attenuator	Mini-Circuits	VAT-20+	001	2021.08.06	1 Year

7.2 Block Diagram of Test Setup

The Same as Section. 5.2.

7.3 Specification Limits ((§15.247(b)(3))

The Limits of maximum Peak Output Power for digital modulation in 2400-2483.5 MHz is: 1 Watt. (30 dBm)

7.4 Operating Condition of EUT

The switch ON/OFF was used to enable the EUT to change the channel one by one.

7.5 Test Procedure

The transmitter output was connected to the spectrum analyzer.

Method AVGSA-1 uses trace averaging with the EUT transmitting at full power throughout each sweep.

The procedure for this method is as follows:

- a) Set span to at least 1.5 times the OBW.
- b) Set RBW = 1% to 5% of the OBW, not to exceed 1 MHz.
- c) Set VBW $\geq [3 \times \text{RBW}]$.
- d) Number of points in sweep $\geq [2 \times \text{span} / \text{RBW}]$. (This gives bin-to-bin spacing $\leq \text{RBW} / 2$, so that narrowband signals are not lost between frequency bins.)
- e) Sweep time = auto.
- f) Detector = RMS (i.e., power averaging), if available. Otherwise, use sample detector mode.
- g) If transmit duty cycle $< 98\%$, use a sweep trigger with the level set to enable triggering only on full power pulses. The transmitter shall operate at the maximum power control level for the entire duration of every sweep. If the EUT transmits continuously (i.e., with no OFF intervals) or at duty cycle $\geq 98\%$, and if each transmission is entirely at the maximum power control level, then the trigger shall be set to “free run.”
- h) Trace average at least 100 traces in power averaging (rms) mode.
- i) Compute power by integrating the spectrum across the OBW of the signal using the instrument’s band power measurement function, with band limits set equal to the OBW band edges. If the instrument does not have a band power

function, sum the spectrum levels (in power units) at intervals equal to the RBW extending across the entire OBW of the spectrum.

The test procedure is defined in ANSI C63.10-2013 (11.9.2.2.2 Measurement Procedure “ Method AVGSA-1” was used).

7.6 Test Results

PASSED.

All the test results are listed below.

(Test Date: 2022.02.22 Temperature: 23°C Humidity: 51 %)

Modulation	Channel	Frequency (MHz)	Peak Output Power (dBm)	Limit
802.11b	1	2412	16.68	30 dBm
	6	2437	16.34	30 dBm
	11	2462	16.16	30 dBm
802.11g	1	2412	14.22	30 dBm
	6	2437	16.76	30 dBm
	11	2462	13.19	30 dBm
802.11n20	1	2412	13.27	30 dBm
	6	2437	15.91	30 dBm
	11	2462	13.12	30 dBm

802.11b CH2412MHz

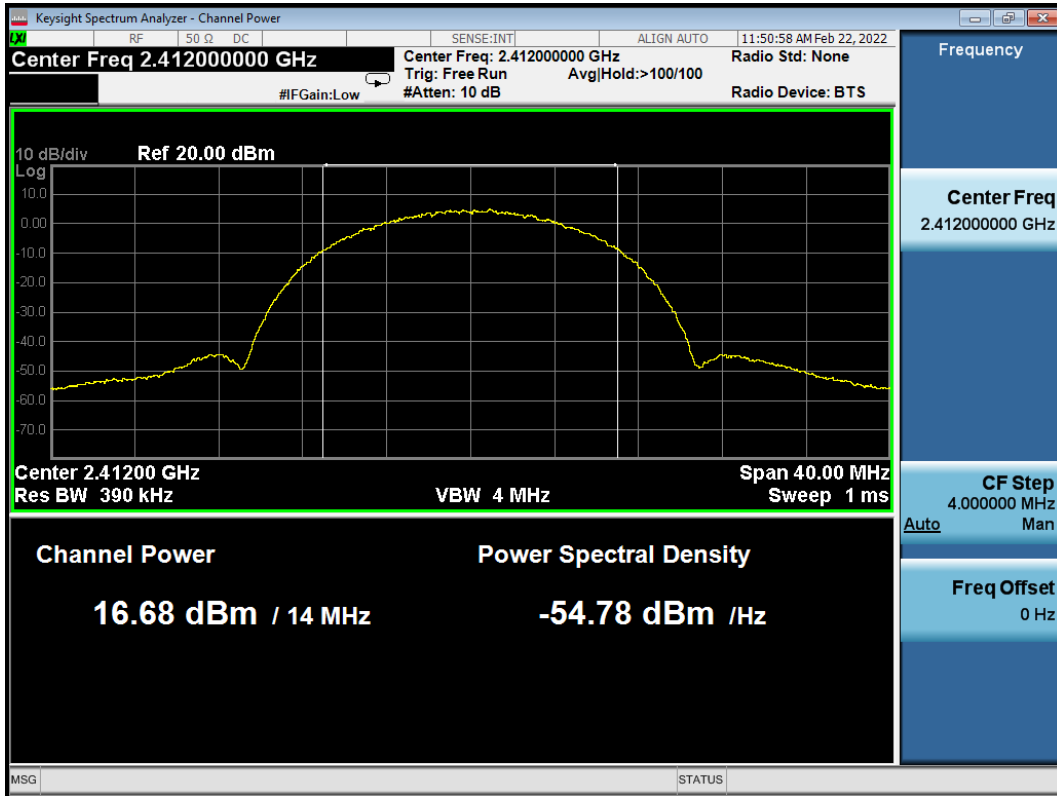

802.11b CH2437MHz

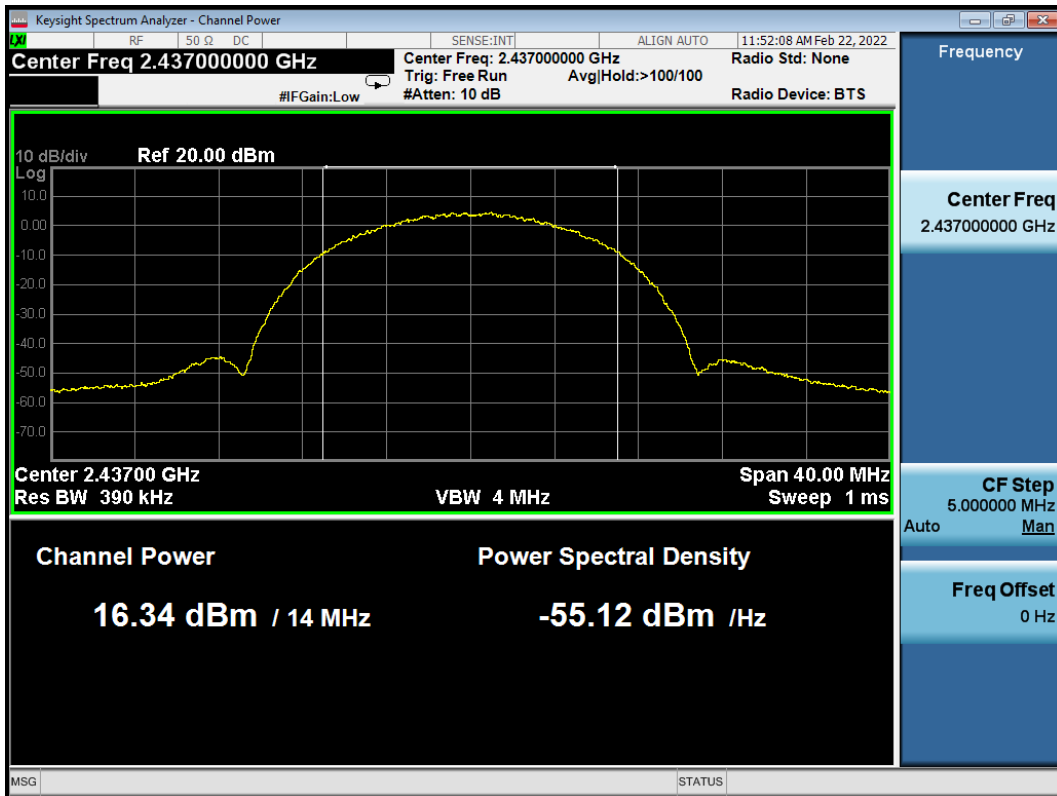

802.11b CH2462MHz

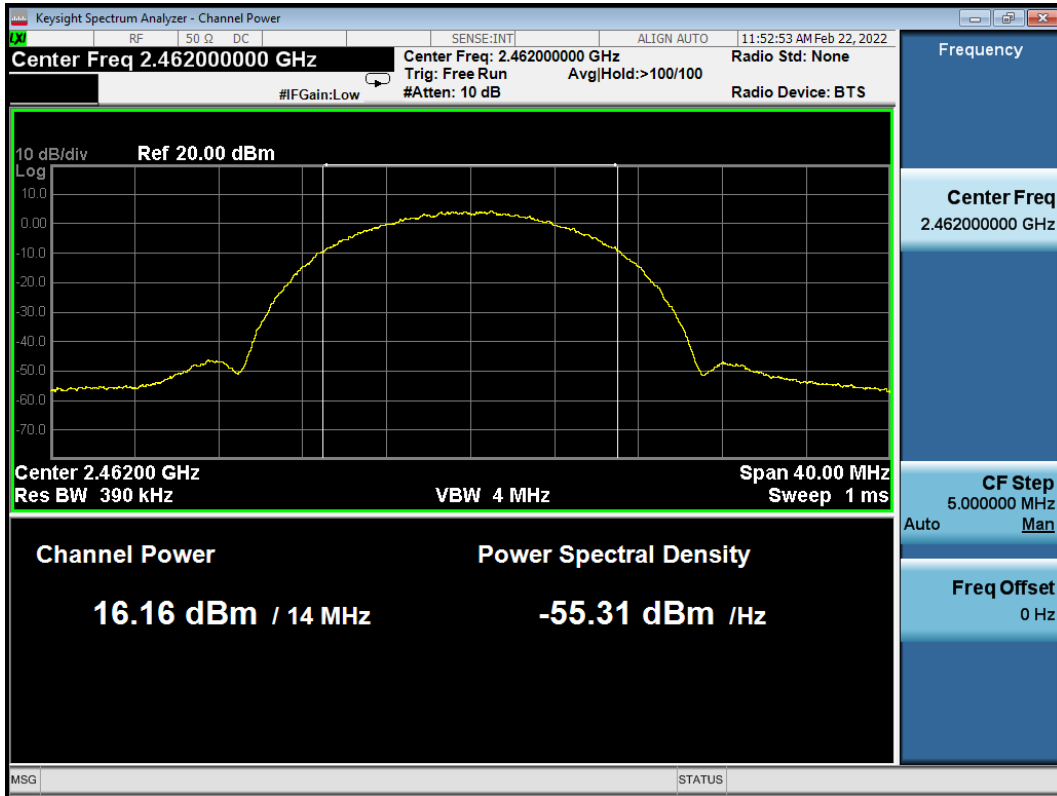

802.11g CH2412MHz

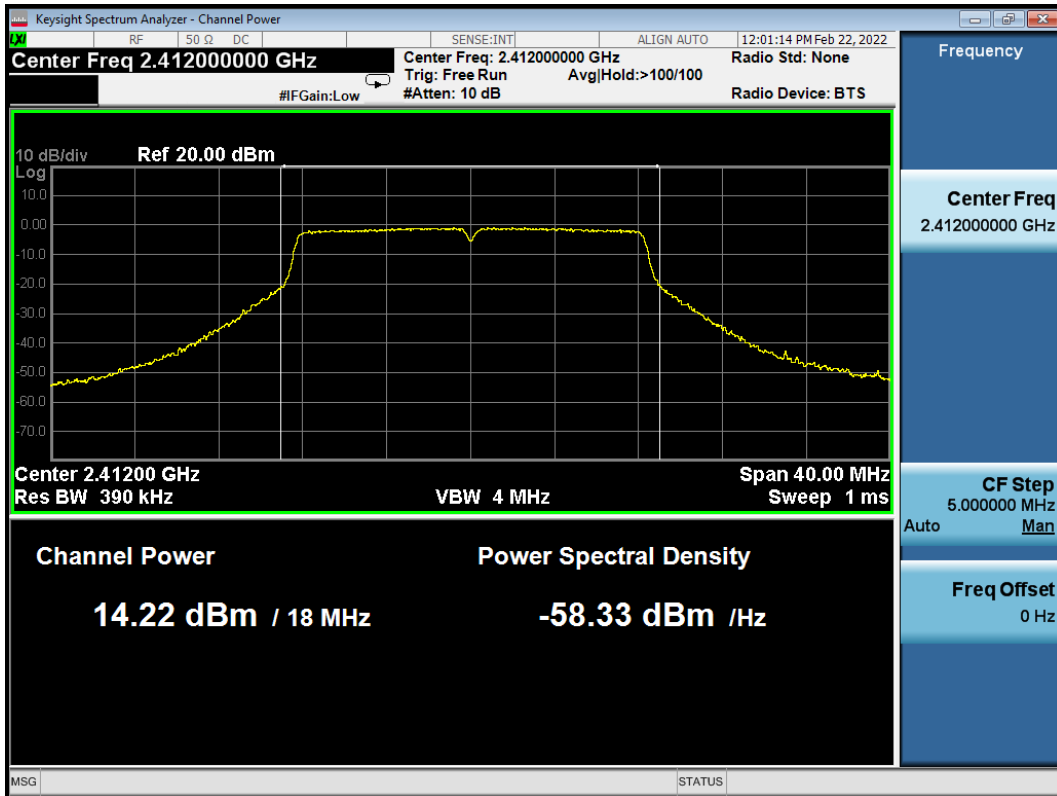

802.11g CH2437MHz

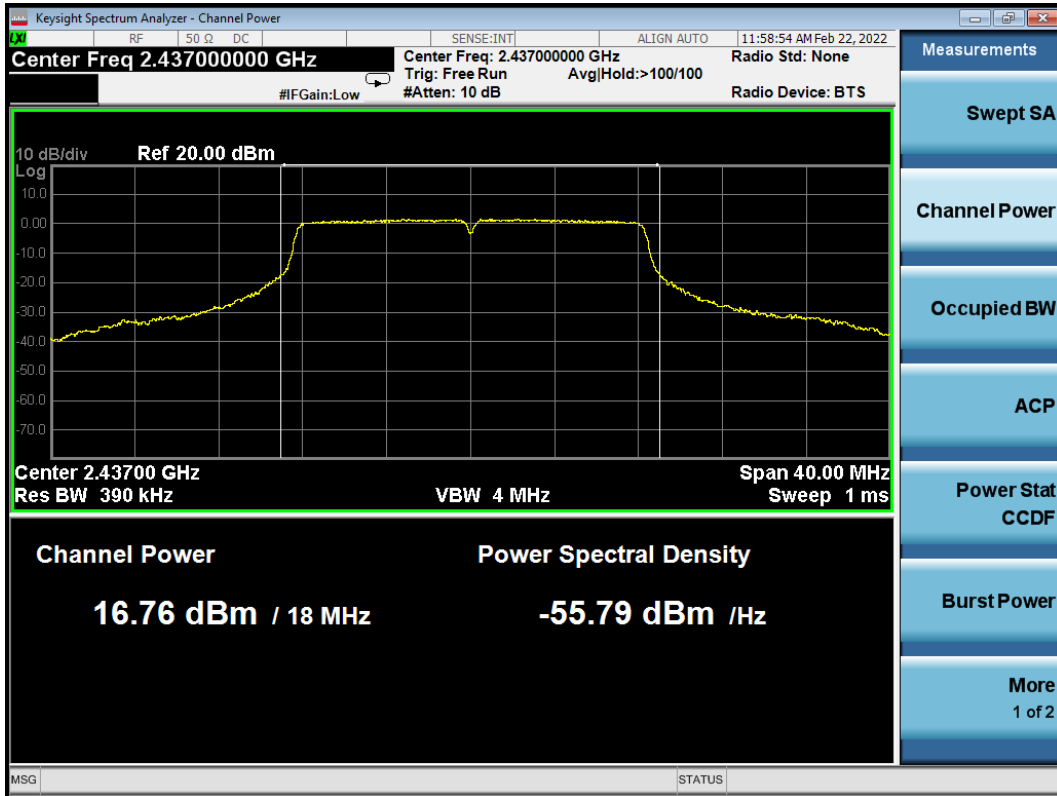

802.11g CH2462MHz

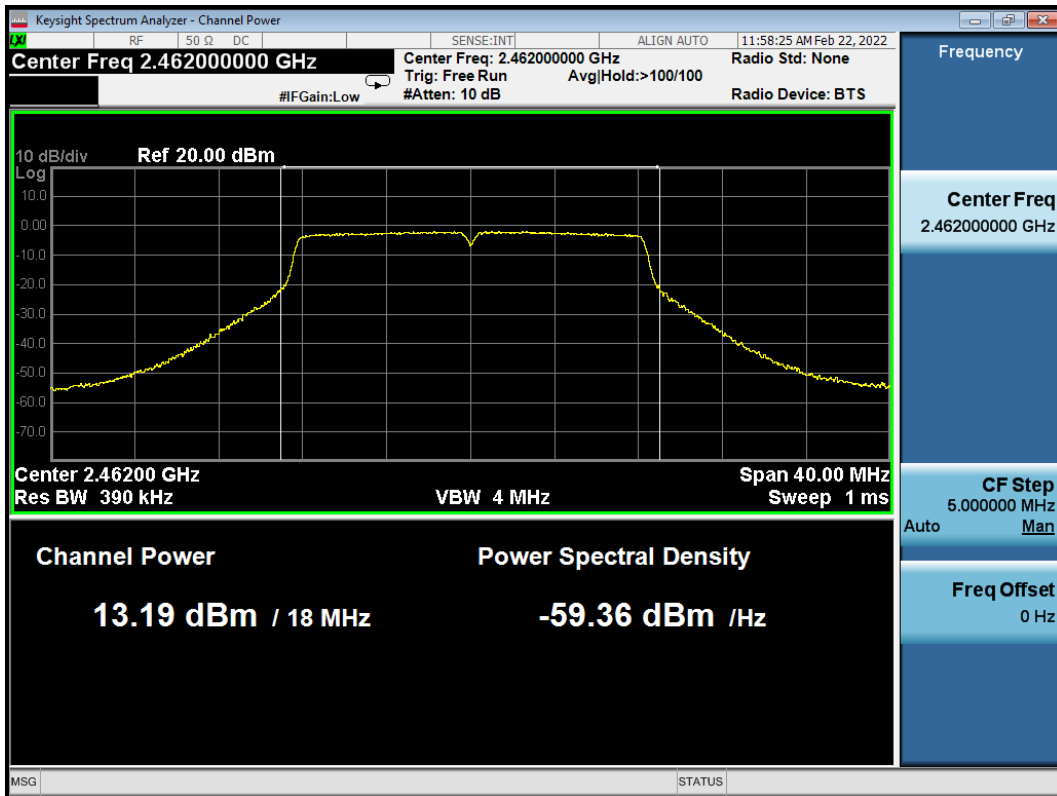

802.11n20 CH2412MHz

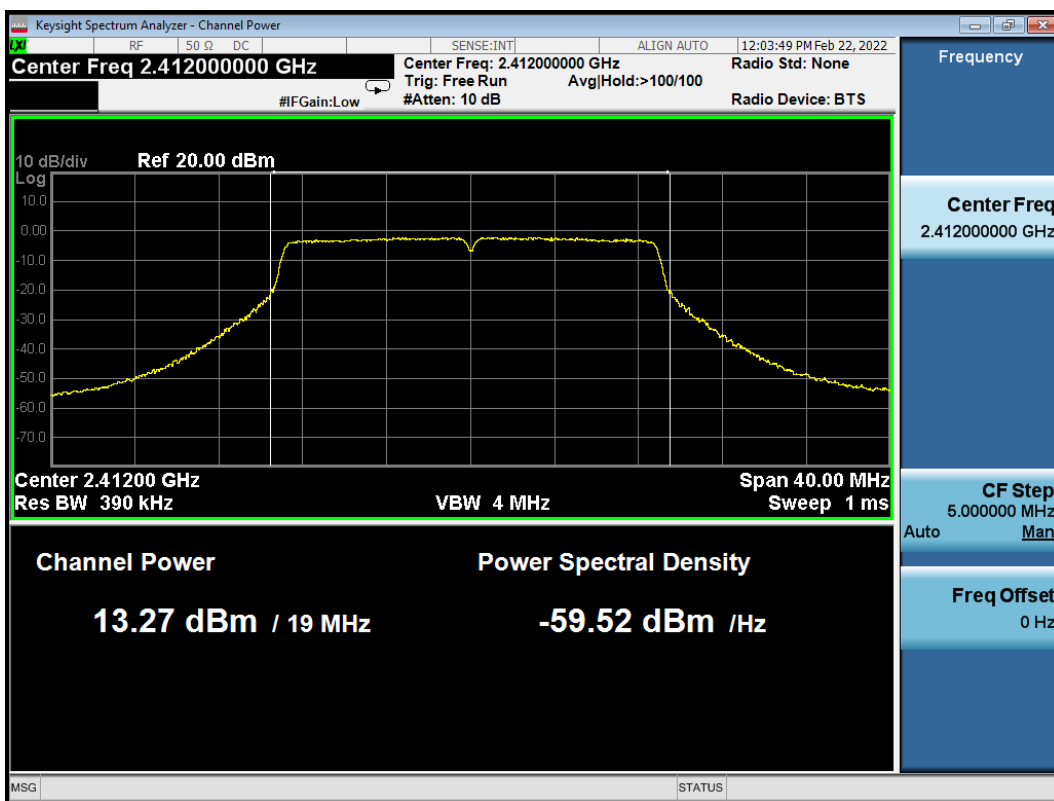

802.11n20 CH2437MHz

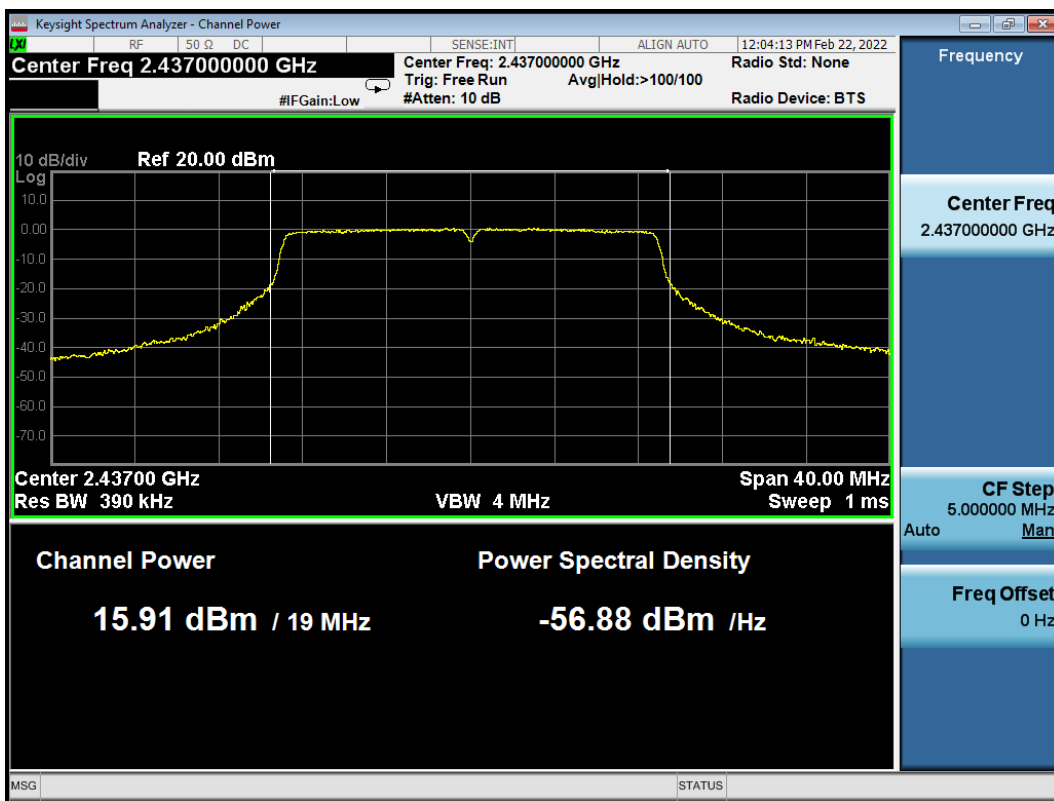

802.11n20 CH2462MHz

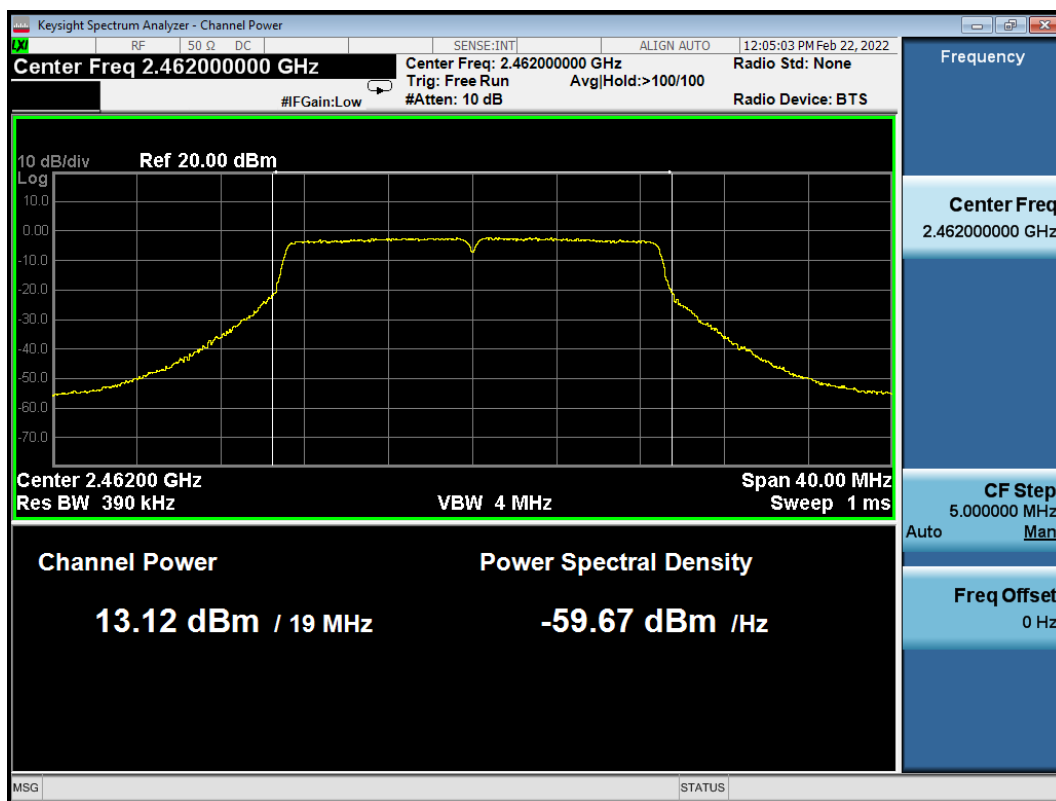

8 EMISSION LIMITATIONS MEASUREMENT

8.1 Test Equipment

The following test equipment was used during the emission limitations test:

Item	Type	Manufacturer	Model No.	Serial No.	Cal. Date	Cal. Interval
1.	Spectrum Analyzer	Agilent	N9010A	MY52221182	2021.09.15	1 Year
2.	Coaxial Cable	WOKEN	SFL402-105F LEX	F02-150819-045	2021.03.08	1 Year
3.	20 dB Attenuator	Mini-Circuits	VAT-20+	001	2021.08.06	1 Year

8.2 Block Diagram of Test Setup

The Same as Section. 5.2.

8.3 Specification Limits (§15.247(d))

In any 100 kHz bandwidth outside the frequency band in which the spread spectrum or digitally modulated intentional radiator is operating, the radio frequency power that is produced by the intentional radiator shall be at least 20 dB below that in the 100 kHz bandwidth within the band that contains the highest level of the desired power, based on either an RF conducted or a radiated measurement, provided the transmitter demonstrates compliance with the peak conducted power limits. If the transmitter complies with the conducted power limits based on the use of RMS averaging over a time interval, as permitted under paragraph (b)(3) of this section, the attenuation required under this paragraph shall be 30 dB instead of 20 dB. Attenuation below the general limits specified in §15.209(a) is not required.

In addition, radiated emissions which fall in the restricted bands, as defined in §15.205(a), must also comply with the radiated emission limits specified in §15.209(a) (see §15.205(c)). (※This test result attaching to Section. 3.7)

8.4 Operating Condition of EUT

The switch ON/OFF was used to enable the EUT to change the channel one by one.

8.5 Test Procedure

The transmitter output was connected to the spectrum analyzer.

Establish a reference level by using the following procedure:

- a) Set instrument center frequency to DTS channel center frequency.
- b) Set the span to ≥ 1.5 times the DTS bandwidth.
- c) Set the RBW = 100 kHz.
- d) Set the VBW $\geq [3 \times \text{RBW}]$.
- e) Detector = peak.
- f) Sweep time = auto couple.
- g) Trace mode = max hold.
- h) Allow trace to fully stabilize.
- i) Use the peak marker function to determine the maximum PSD level.

Note that the channel found to contain the maximum PSD level can be used to

establish the reference level.

Establish an emission level by using the following procedure:

- a) Set the center frequency and span to encompass frequency range to be measured.
- b) Set the RBW = 100 kHz.
- c) Set the VBW $\geq [3 \times \text{RBW}]$.
- d) Detector = peak.
- e) Sweep time = auto couple.
- f) Trace mode = max hold.
- g) Allow trace to fully stabilize.
- h) Use the peak marker function to determine the maximum amplitude level.

Ensure that the amplitude of all unwanted emissions outside of the authorized frequency band (excluding restricted frequency bands) is attenuated by at least the minimum requirements specified in 11.11. Report the three highest emissions relative to the limit.

Scan up through 10th harmonic.

The test procedure is defined in ANSI C63.10-2013 (11.11.2 Reference level measurement and 11.11.3 Emission level measurement was used).

8.6 Test Results

PASSED.

The test data was attached in the next pages.

(Test Date: 2022.02.22-23 Temperature: 23°C Humidity: 51 %)

Modulation	Channel	Frequency (MHz)	Data Page
802.11b	1	2412 MHz	P57-59
	6	2437 MHz	P60-61
	11	2462 MHz	P62-64
802.11g	1	2412 MHz	P65-67
	6	2437 MHz	P68-69
	11	2462 MHz	P70-72
802.11n20	1	2412 MHz	P73-75
	6	2437 MHz	P76-77
	11	2462 MHz	P78-80

802.11b CH2412MHz

Reference level

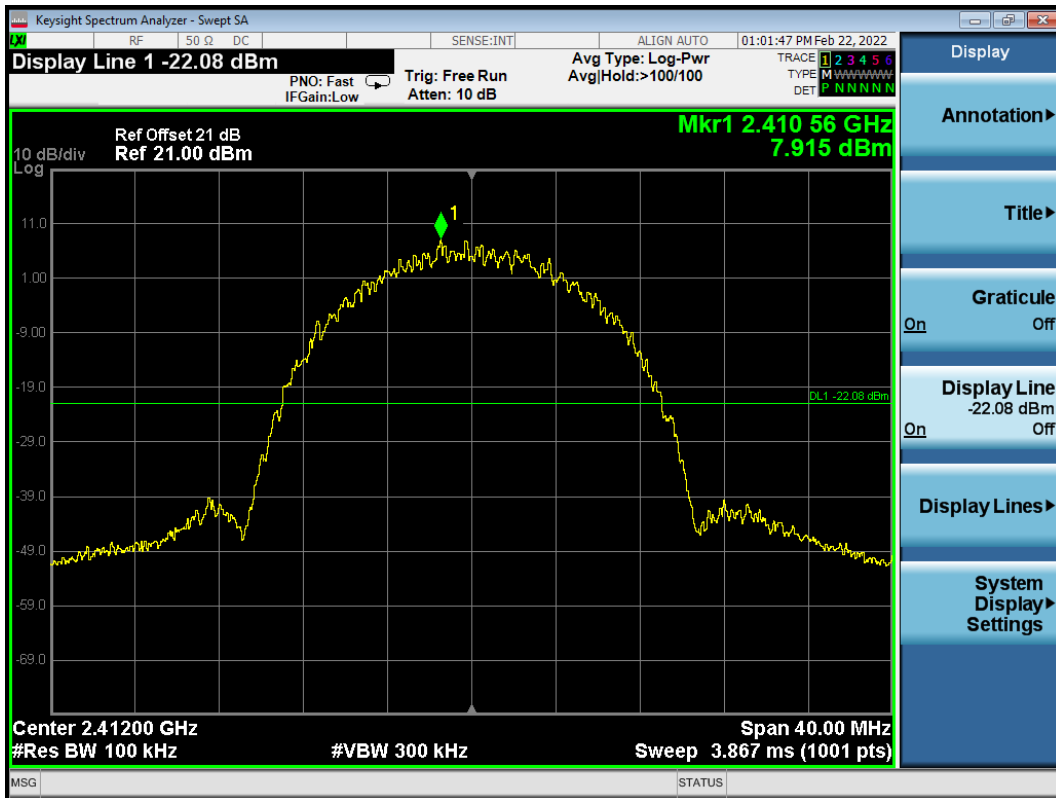

Emission level

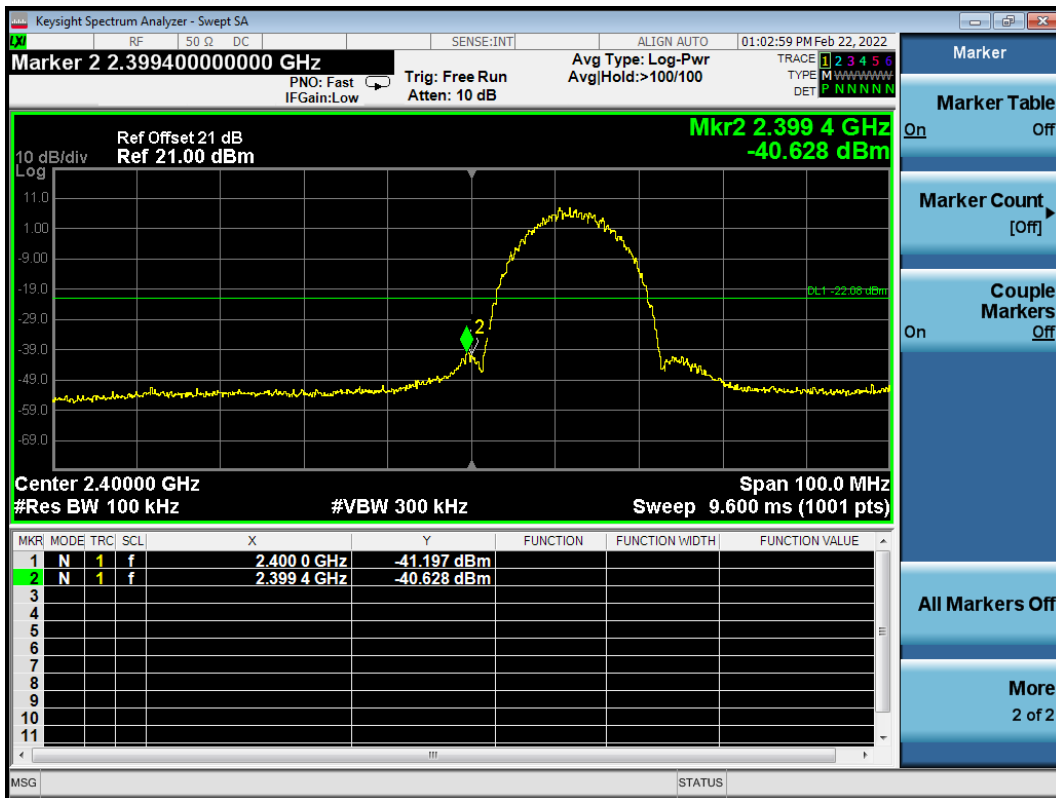

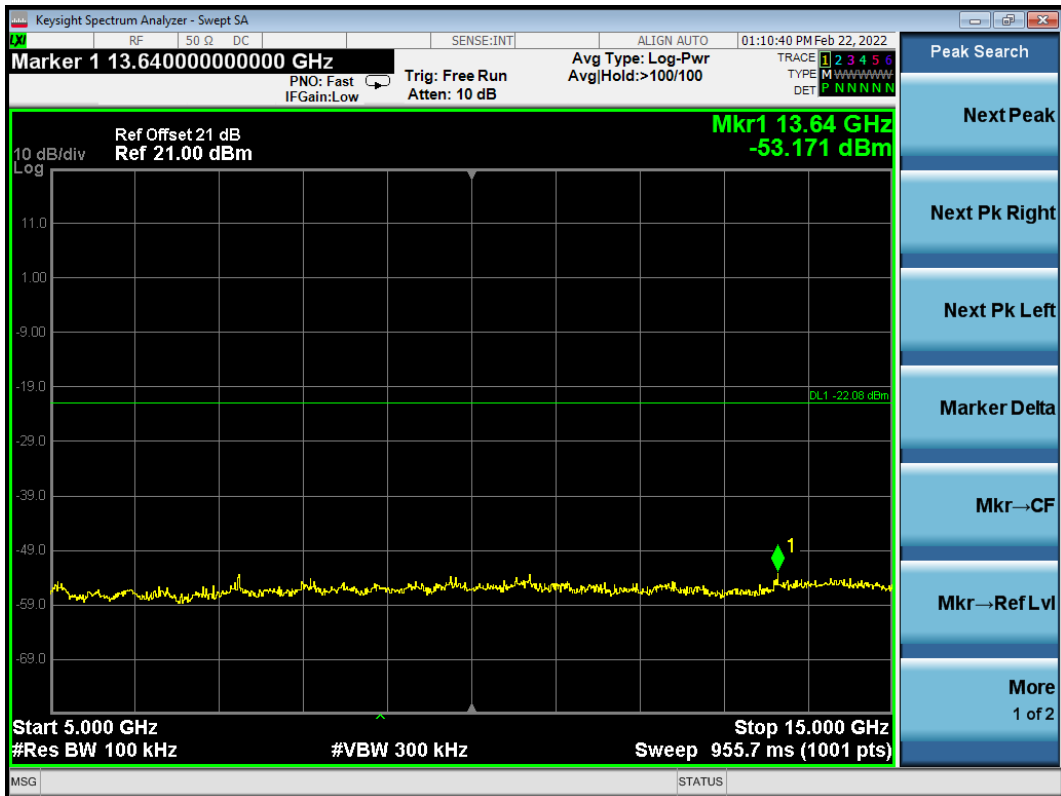
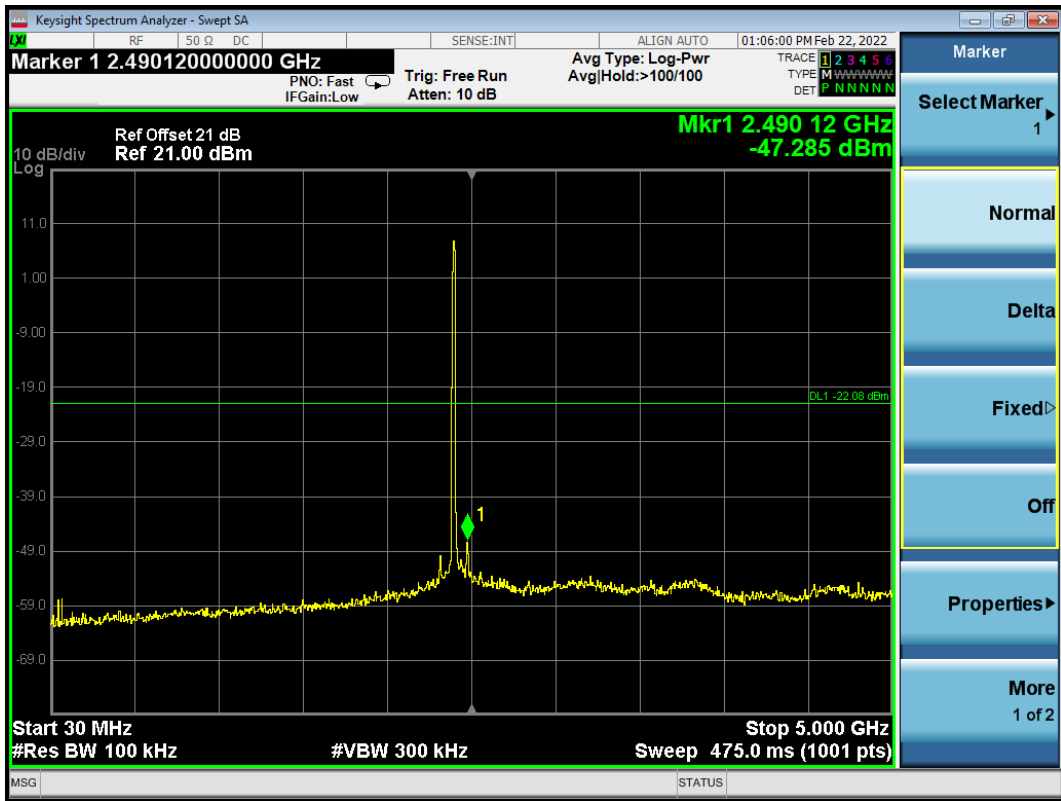



802.11b CH2437MHz

Reference level

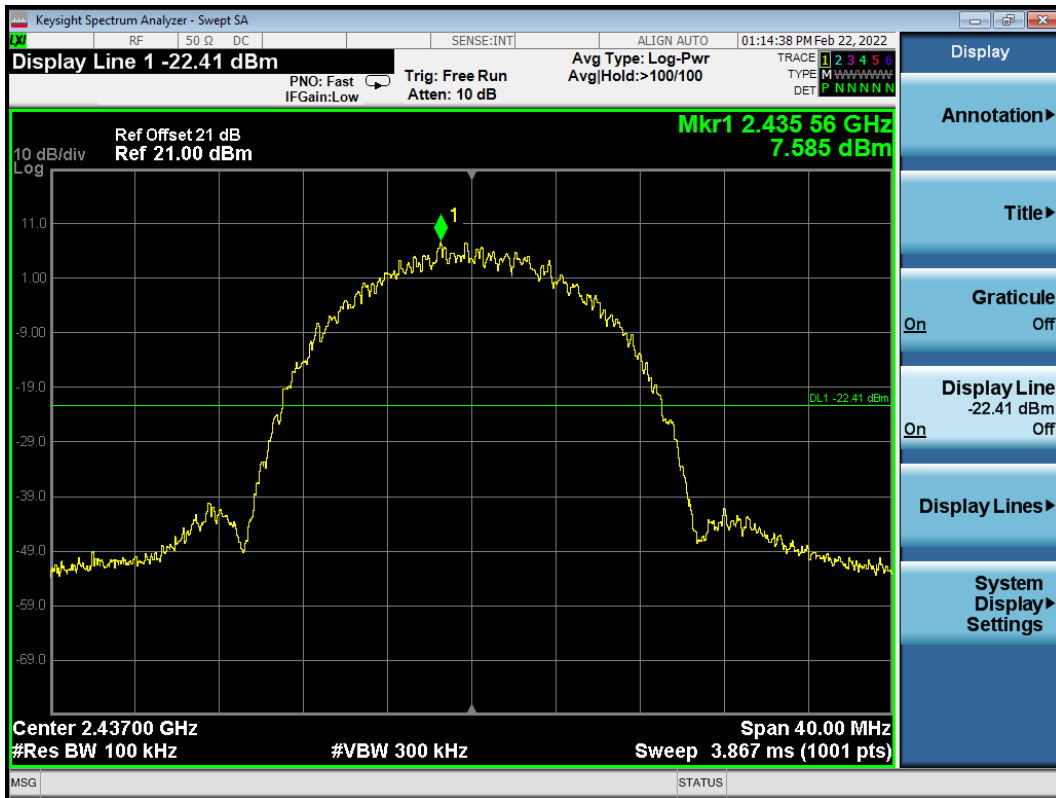

Emission level

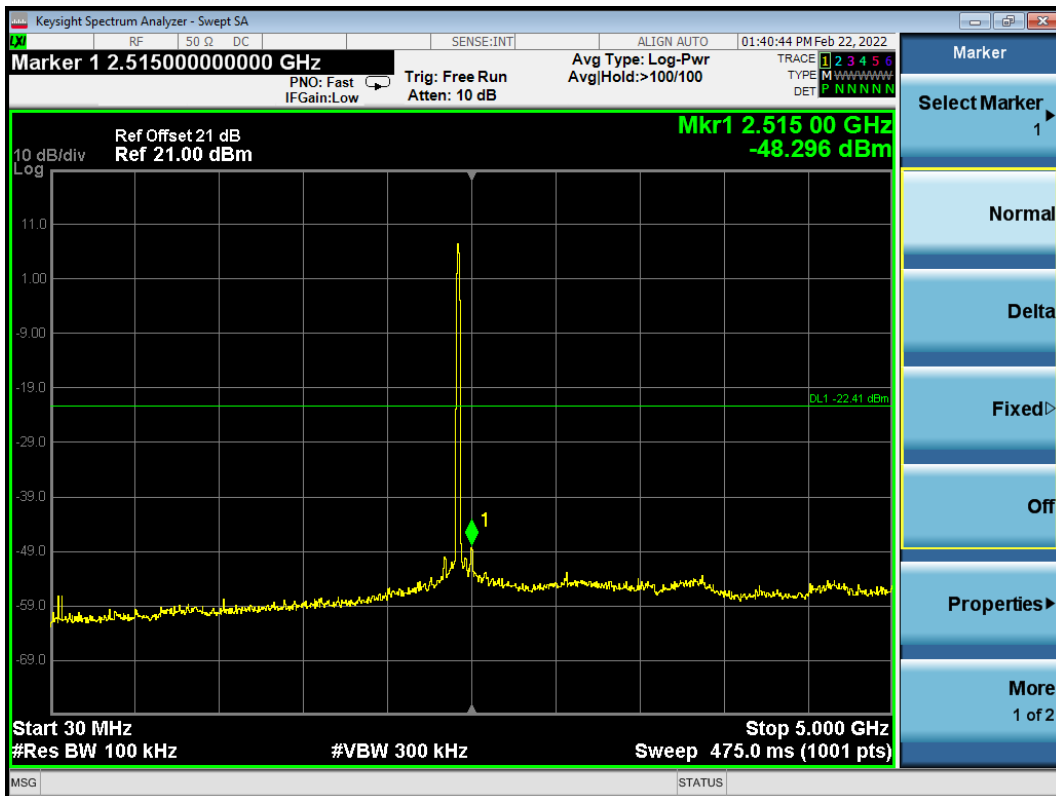

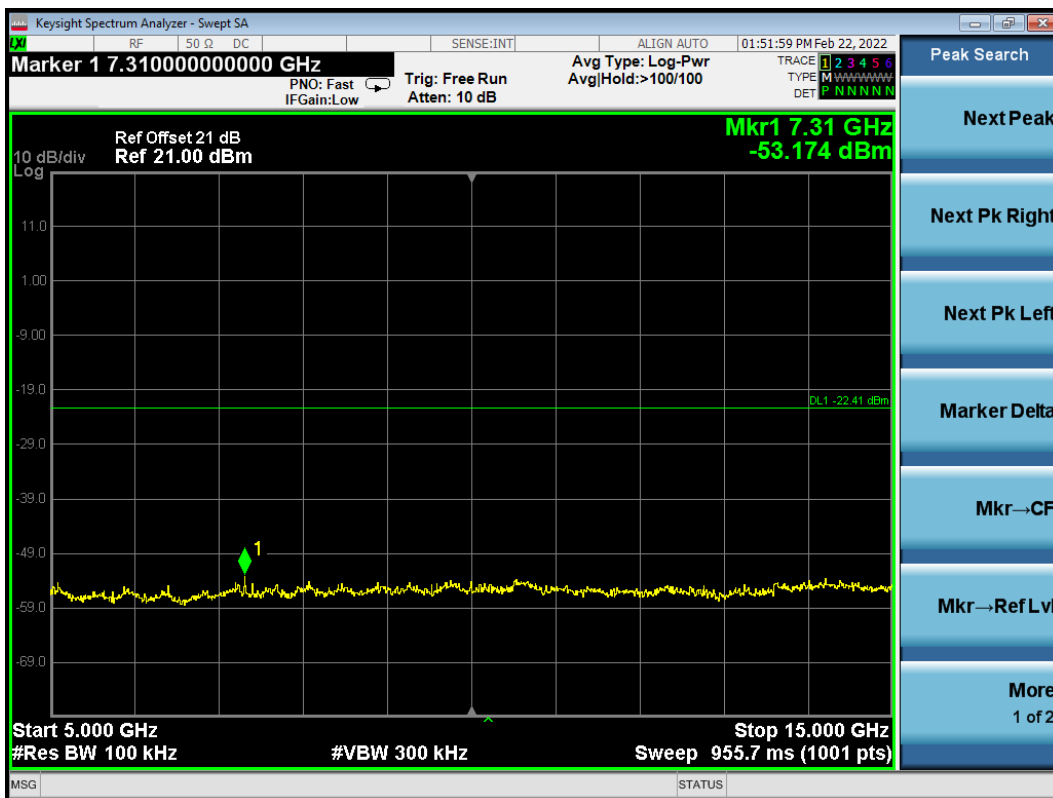

802.11b CH2462MHz

Reference level

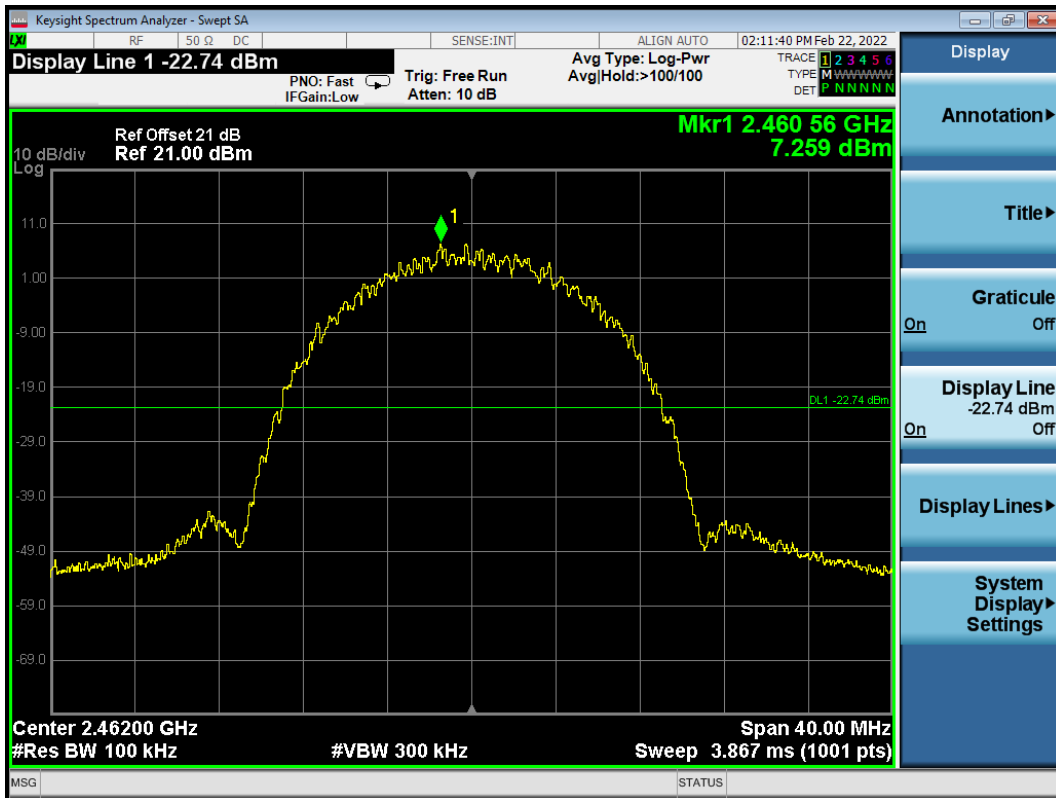

Emission level

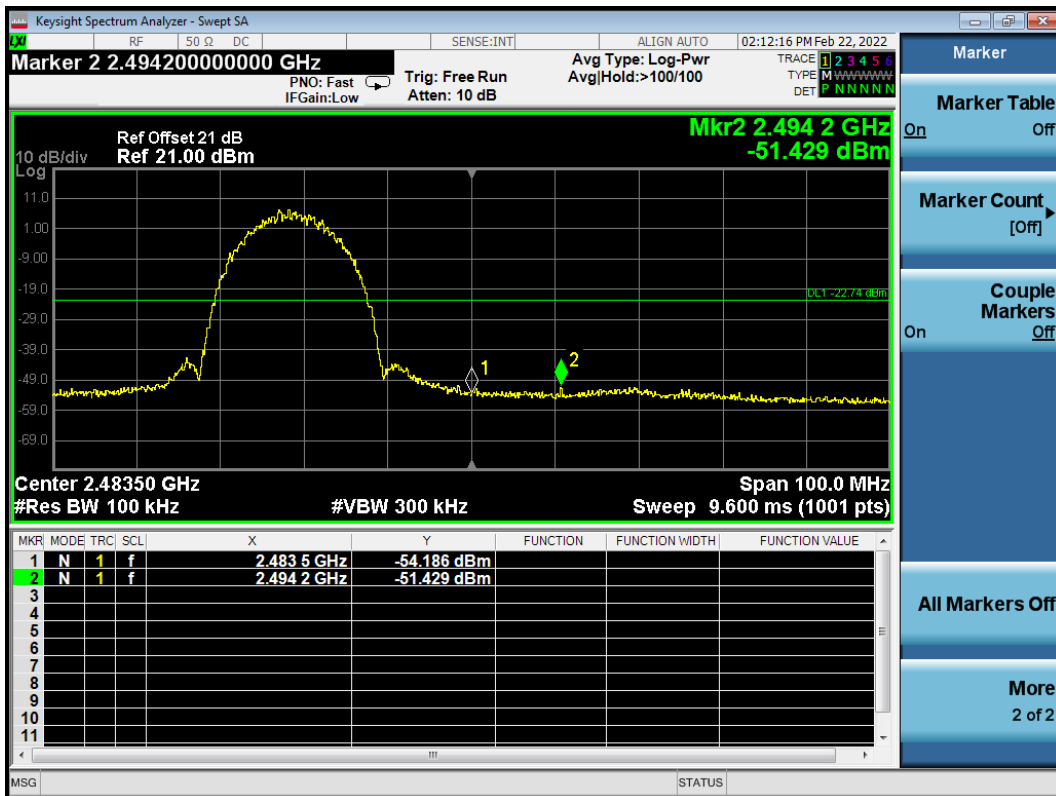

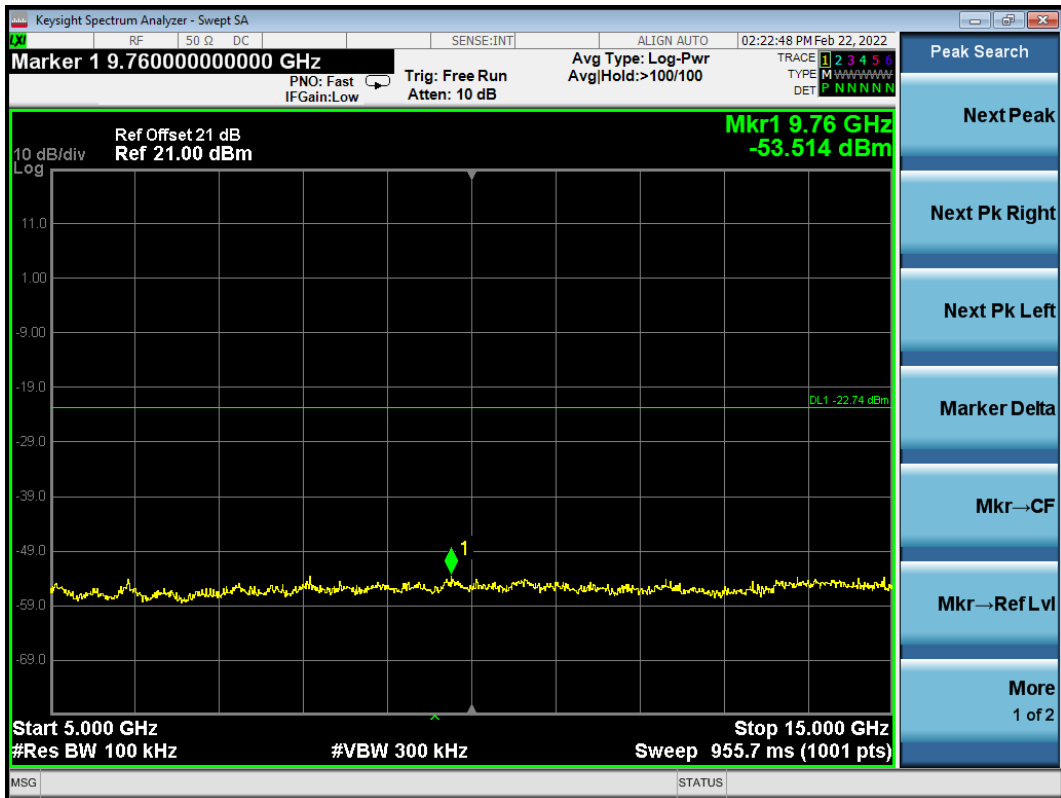



802.11g CH2412MHz

Reference level



Emission level

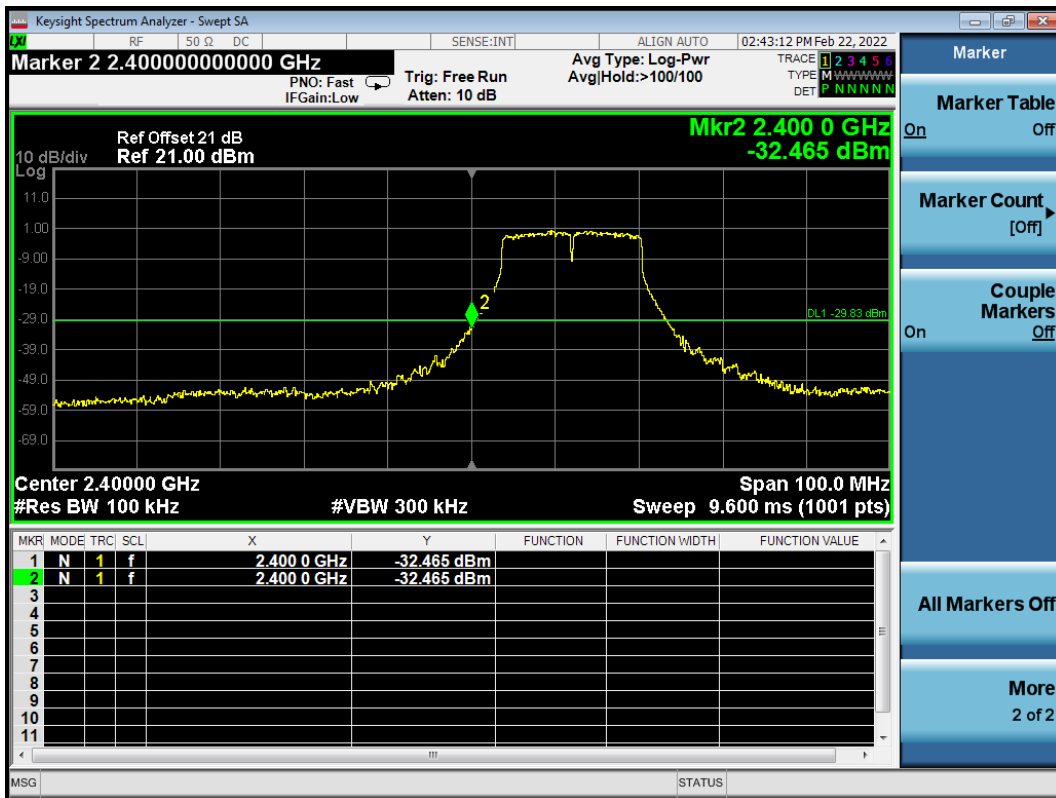

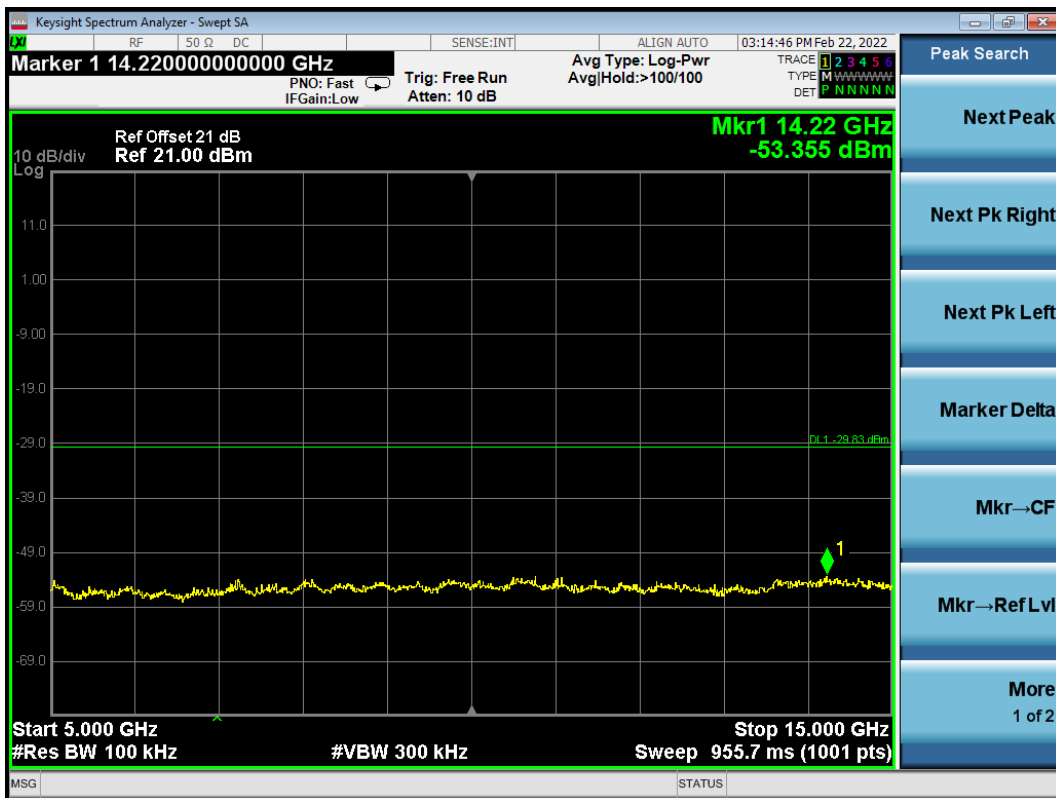



802.11g CH2437MHz

Reference level

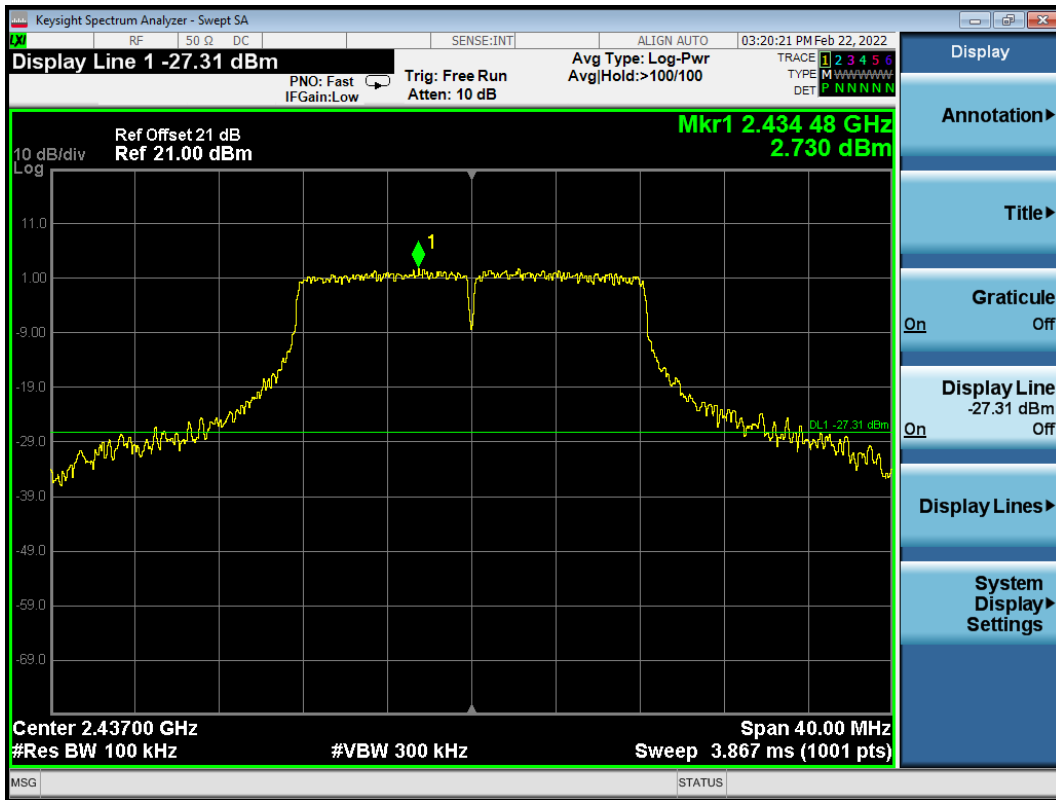

Emission level

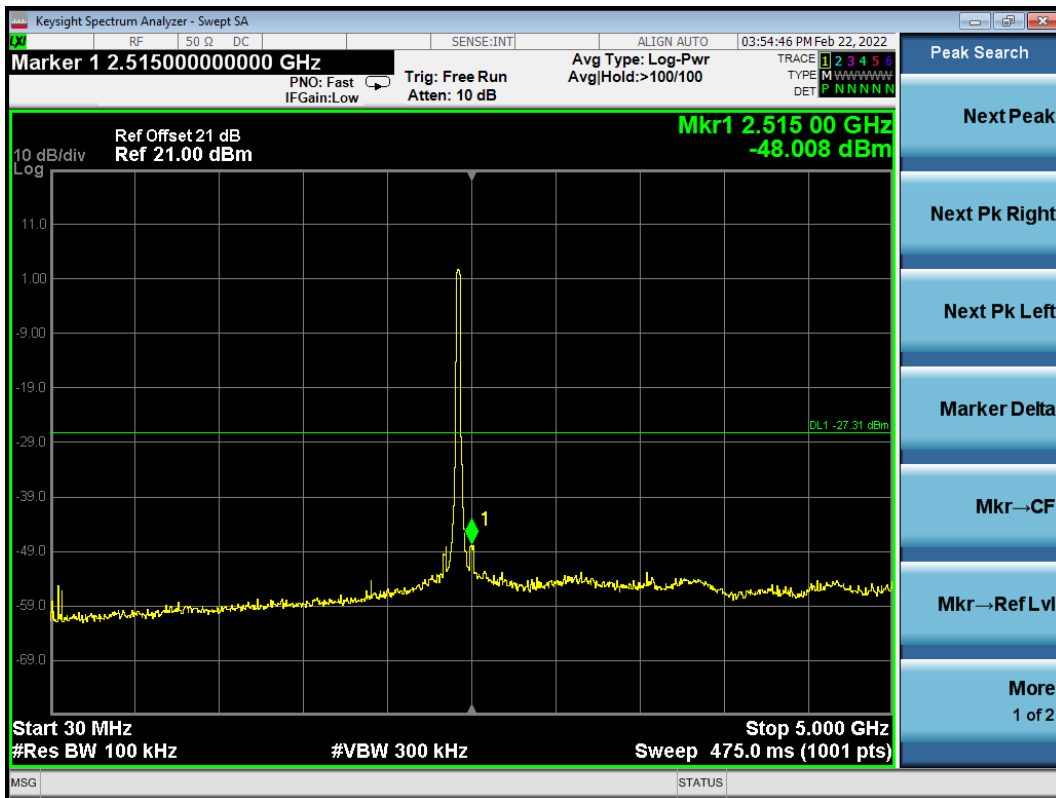

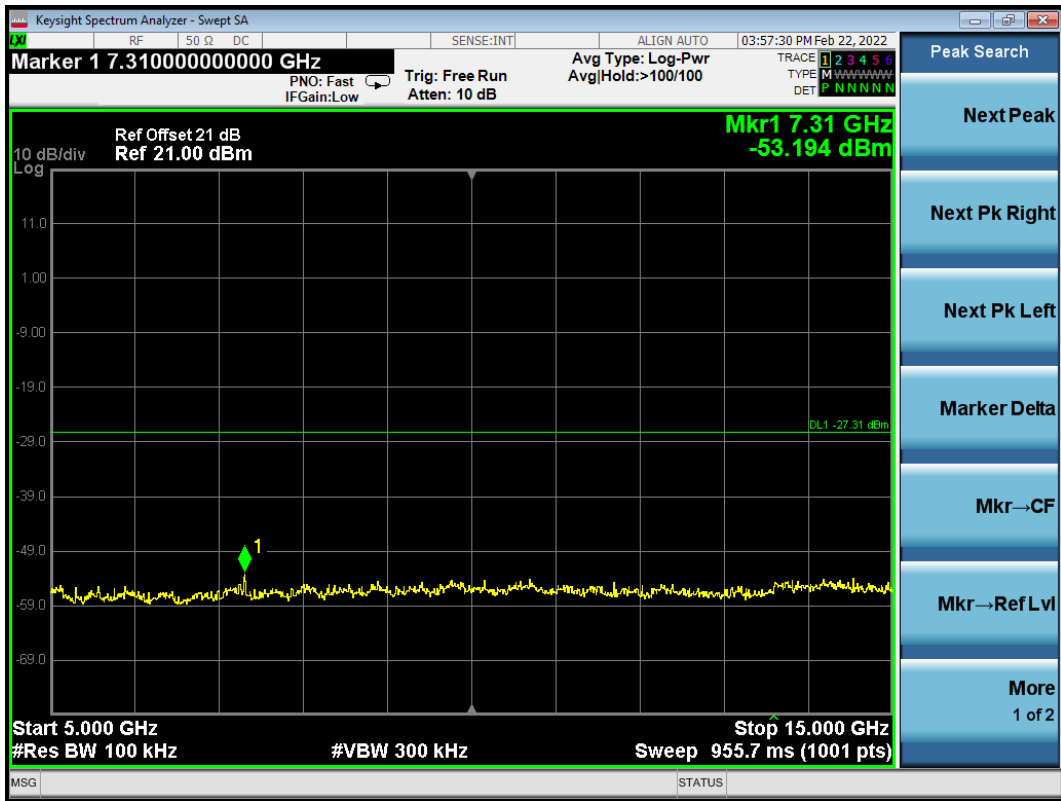

802.11g CH2462MHz

Reference level

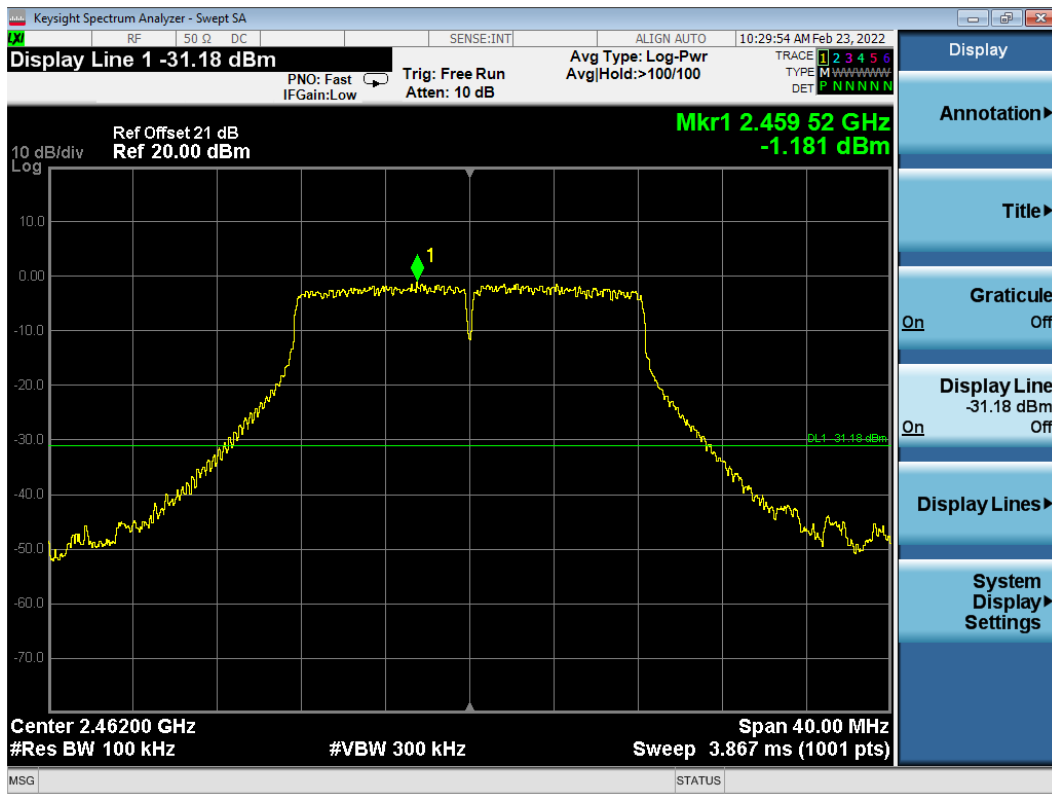

Emission level

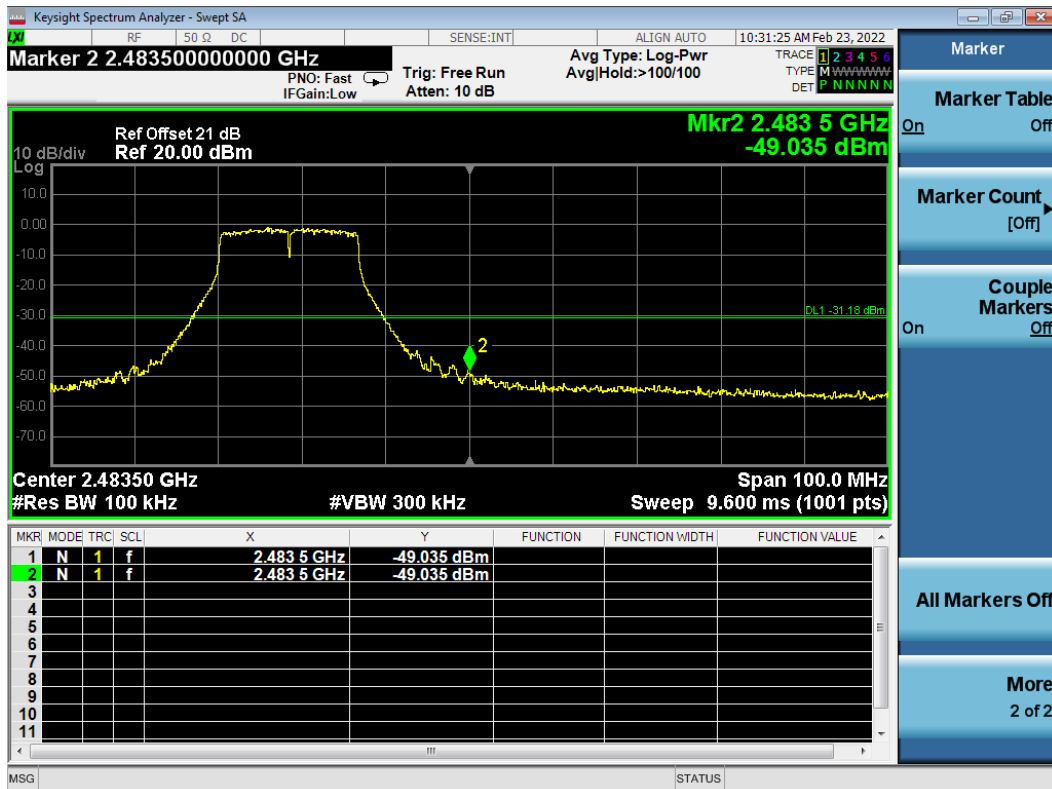

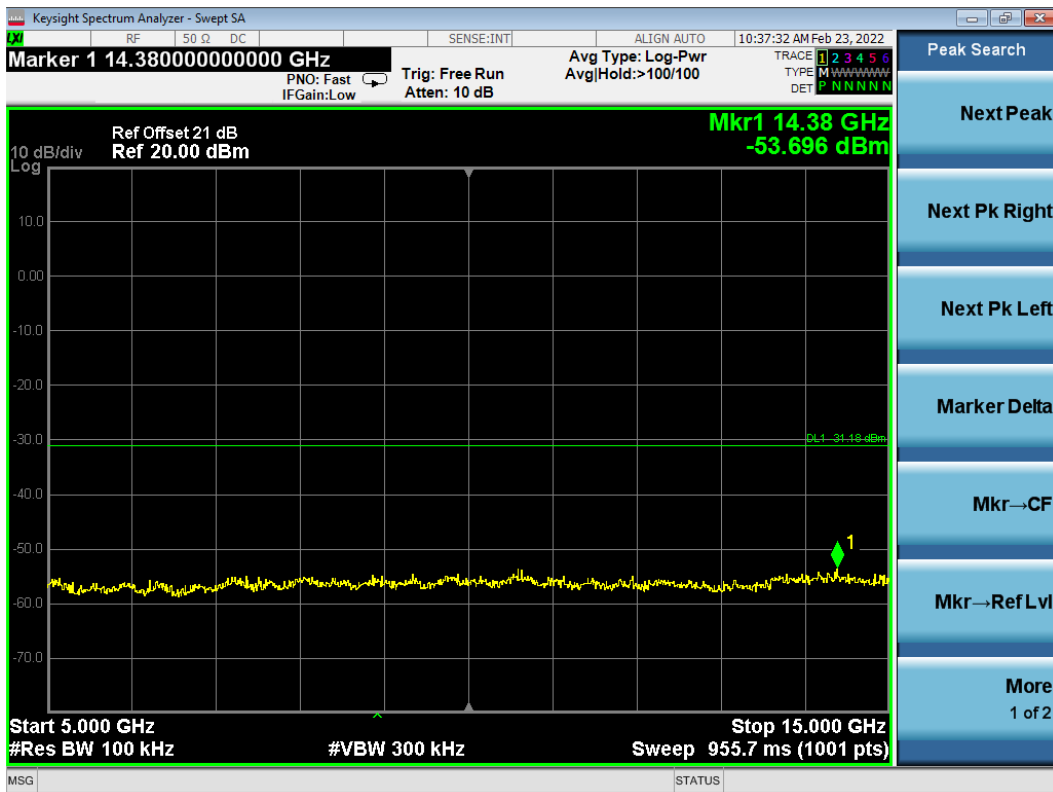



802.11n20 CH2412MHz

Reference level

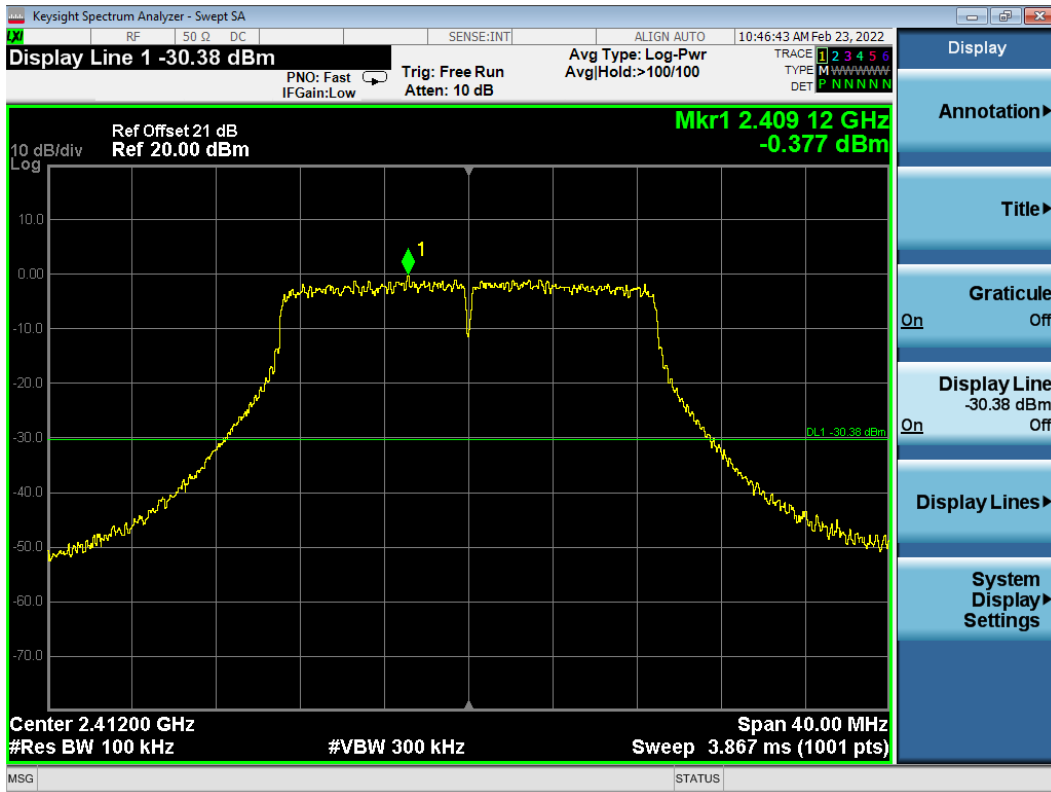

Emission level

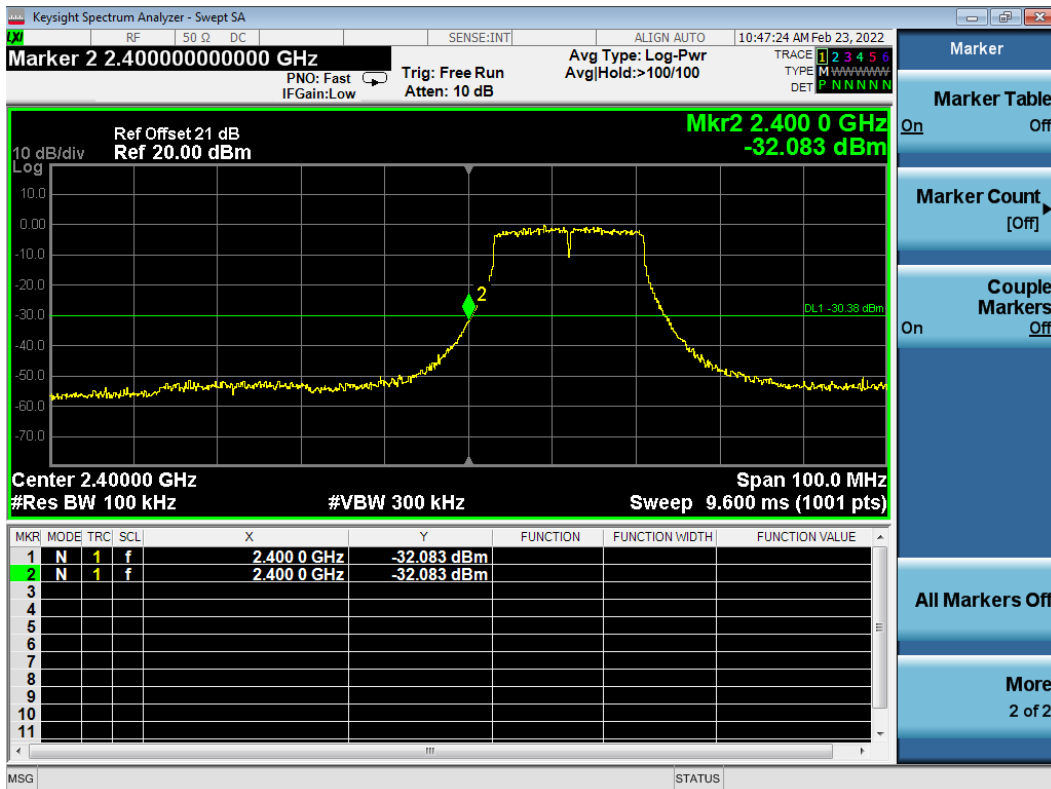

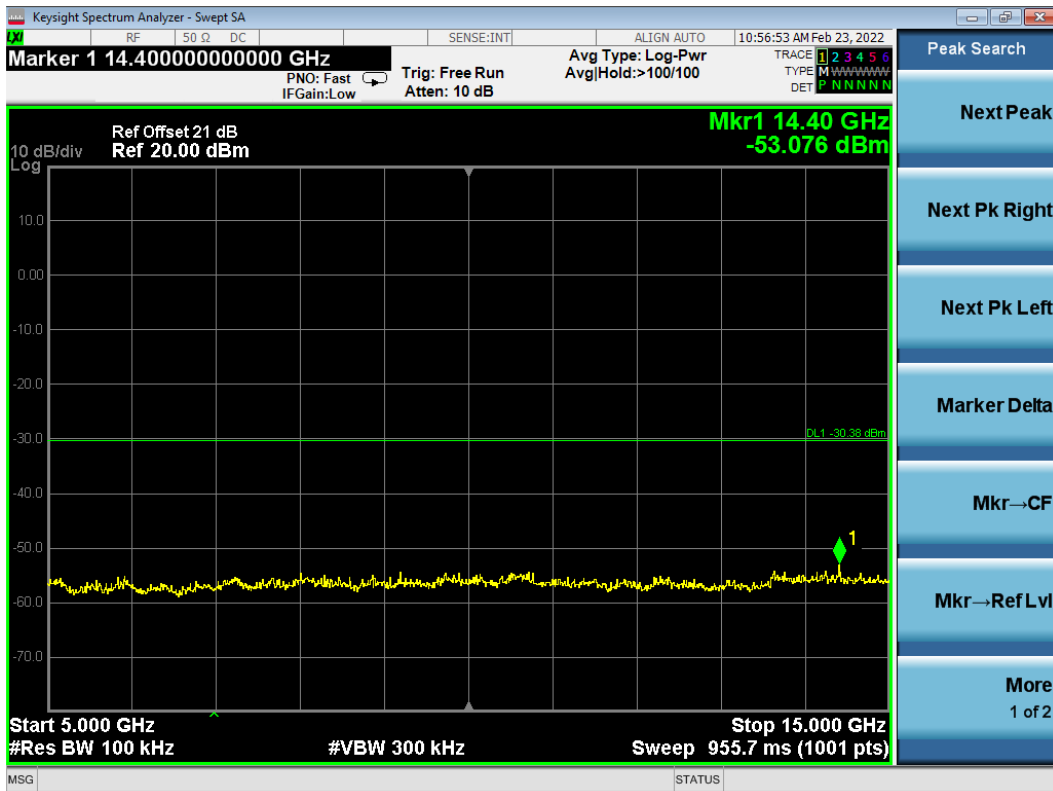
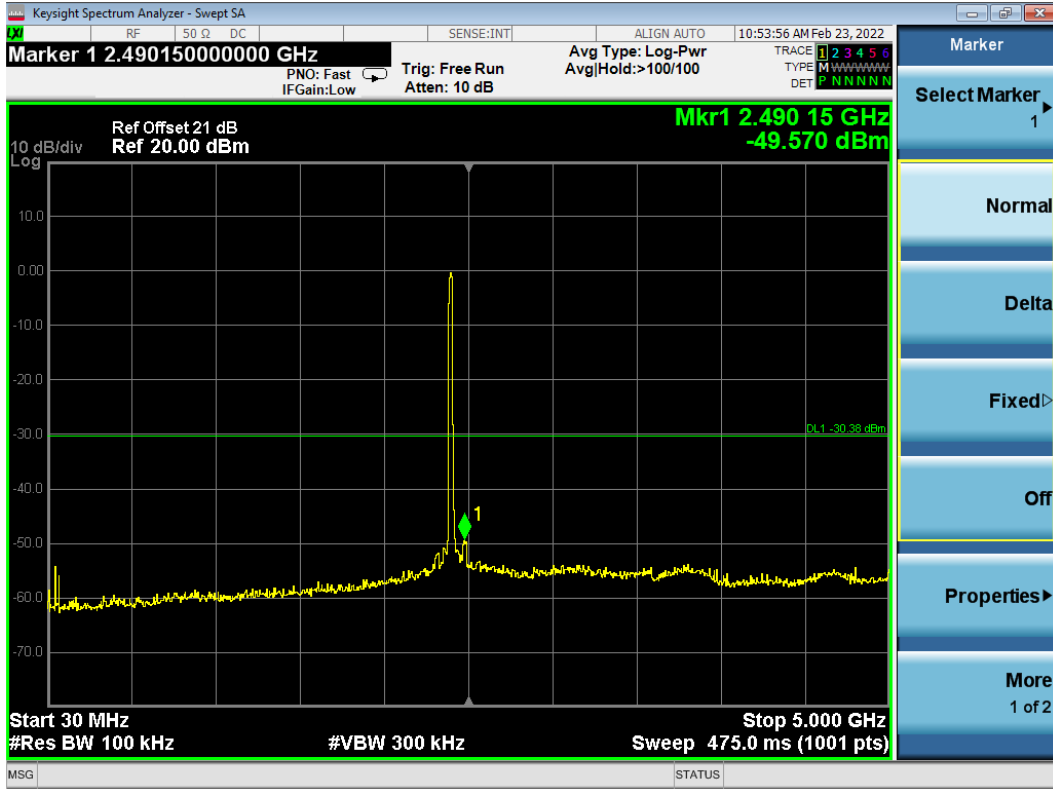



802.11n20 CH2437MHz

Reference level

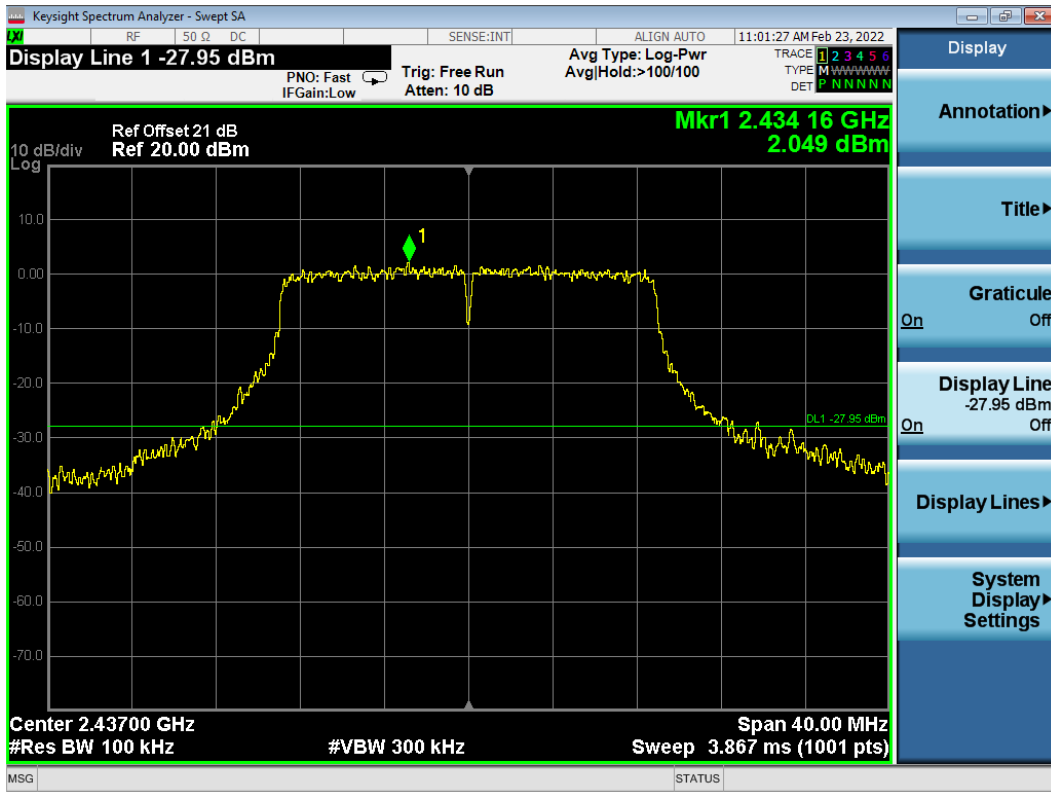

Emission level

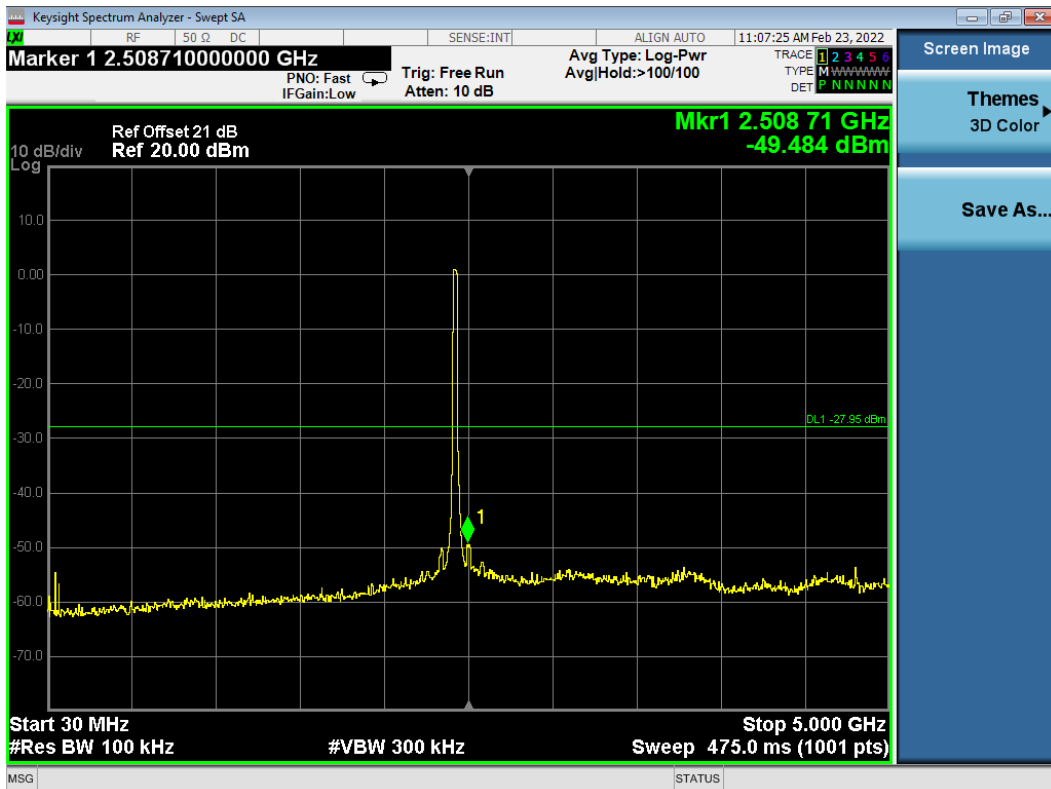

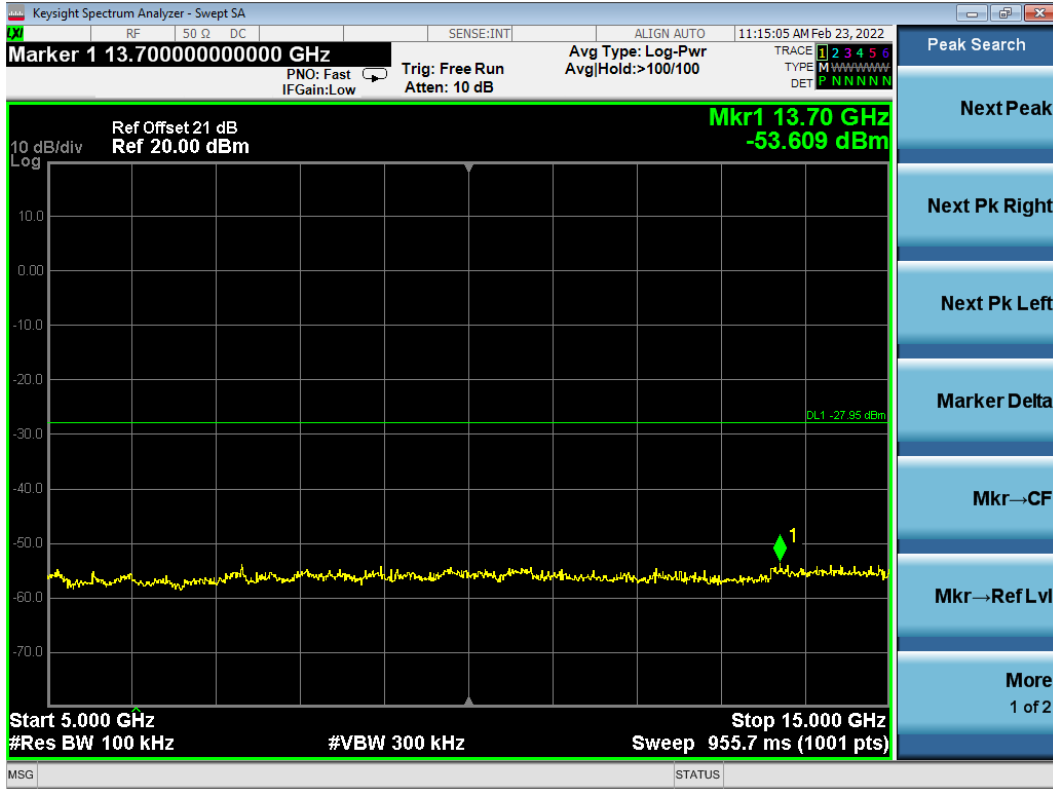

802.11n20 CH2462MHz

Reference level

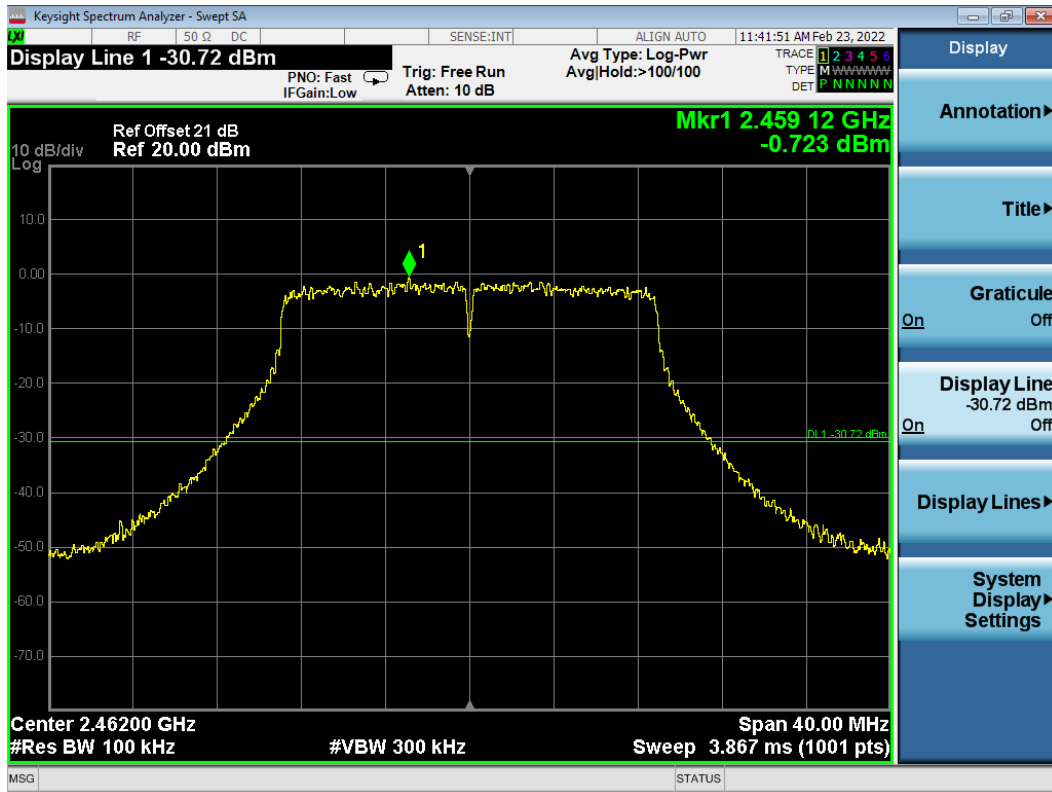

Emission level

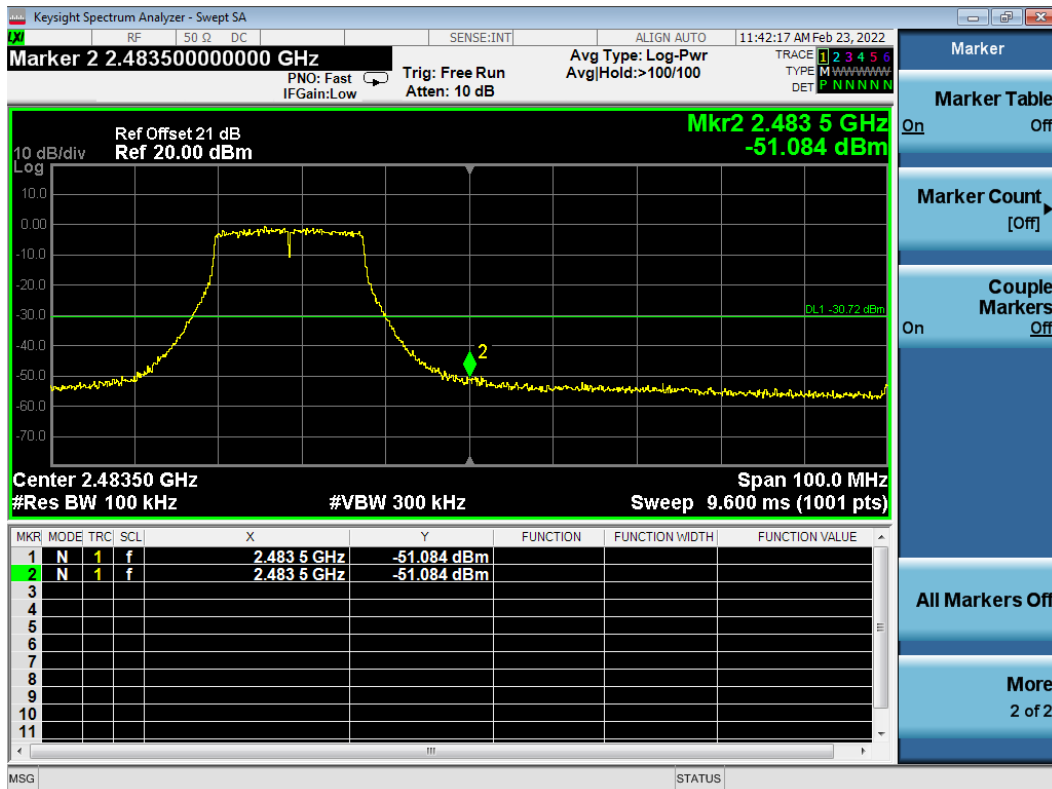

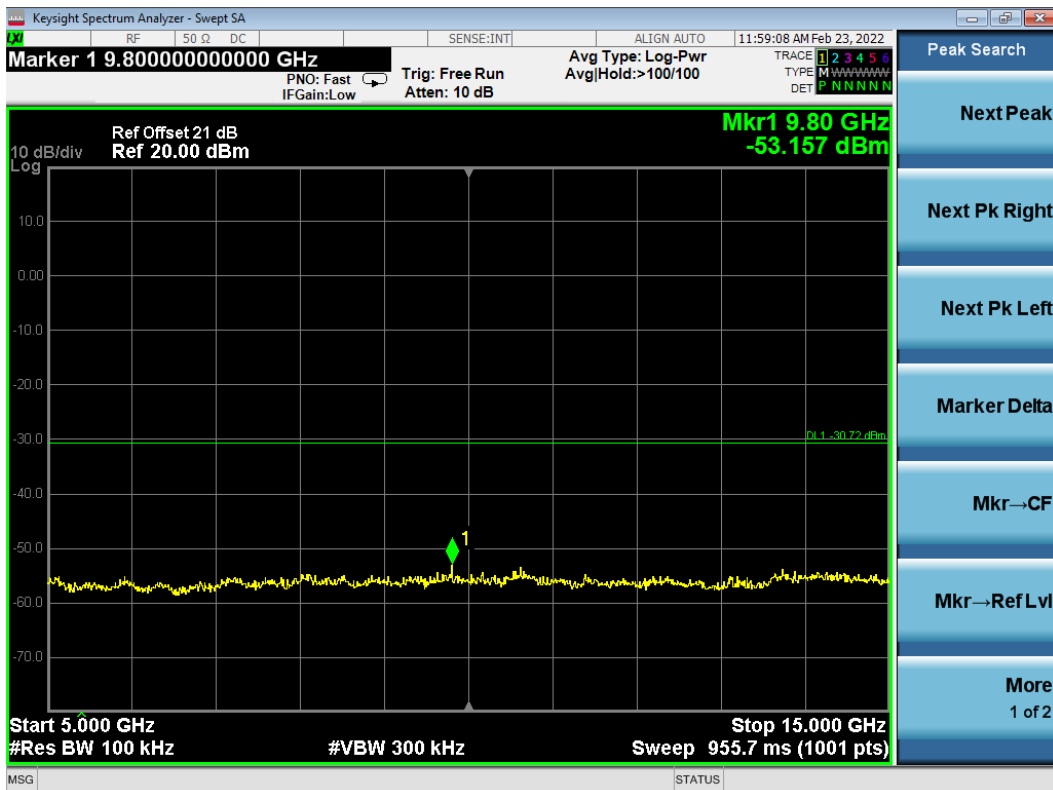
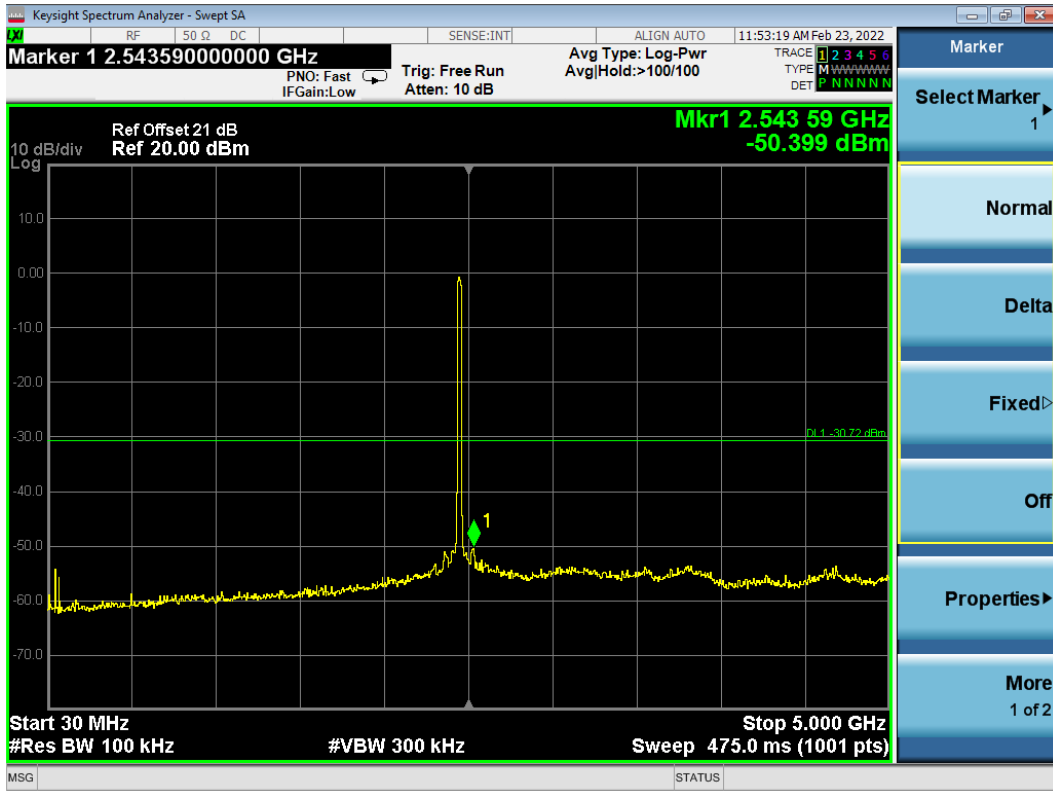



9 POWER SPECTRAL DENSITY MEASUREMENT

9.1 Test Equipment

The following test equipment was used during the power spectral density measurement:

Item	Type	Manufacturer	Model No.	Serial No.	Cal. Date	Cal. Interval
1.	Spectrum Analyzer	Agilent	N9010A	MY52221182	2021.09.15	1 Year
2.	Coaxial Cable	WOKEN	SFL402-105F LEX	F02-150819-045	2021.03.08	1 Year
3.	20 dB Attenuator	Mini-Circuits	VAT-20+	001	2021.08.06	1 Year

9.2 Block Diagram of Test Setup

The Same as section 5.2.

9.3 Specification Limits (§15.247(e))

The peak power spectral density conducted from the intentional radiator to the antenna shall not be greater than 8 dBm in any 3 kHz band.

9.4 Operating Condition of EUT

The switch ON/OFF was used to enable the EUT to change the channel one by one.

9.5 Test Procedure

The transmitter output was connected to the spectrum analyzer.

- a) Set analyzer center frequency to DTS channel center frequency.
- b) Set the span to 1.5 times the DTS bandwidth.
- c) Set the RBW to $3 \text{ kHz} \leq \text{RBW} \leq 100 \text{ kHz}$.
- d) Set the VBW $\geq [3 \times \text{RBW}]$.
- e) Detector = peak.
- f) Sweep time = auto couple.
- g) Trace mode = max hold.
- h) Allow trace to fully stabilize.
- i) Use the peak marker function to determine the maximum amplitude level within the RBW.
- j) If measured value exceeds requirement, then reduce RBW (but no less than 3 kHz) and repeat.

The test procedure is defined in ANSI C63.10-2013 (11.10.2 Measurement Procedure “Method PKPSD (peak PSD)” was used).

9.6 Test Results

PASSED.

All the test results are attached in next pages.

(Test Date: 2022.02.22 Temperature: 23°C Humidity: 51 %)

Modulation	Channel	Frequency (MHz)	Power Spectral Density (dBm)	Limit
802.11b	1	2412	-6.242	8 dBm
	6	2437	-6.556	8 dBm
	11	2462	-6.952	8 dBm
802.11g	1	2412	-13.839	8 dBm
	6	2437	-11.414	8 dBm
	11	2462	-15.107	8 dBm
802.11n20	1	2412	-14.682	8 dBm
	6	2437	-12.197	8 dBm
	11	2462	-14.877	8 dBm

802.11b CH2412 MHz

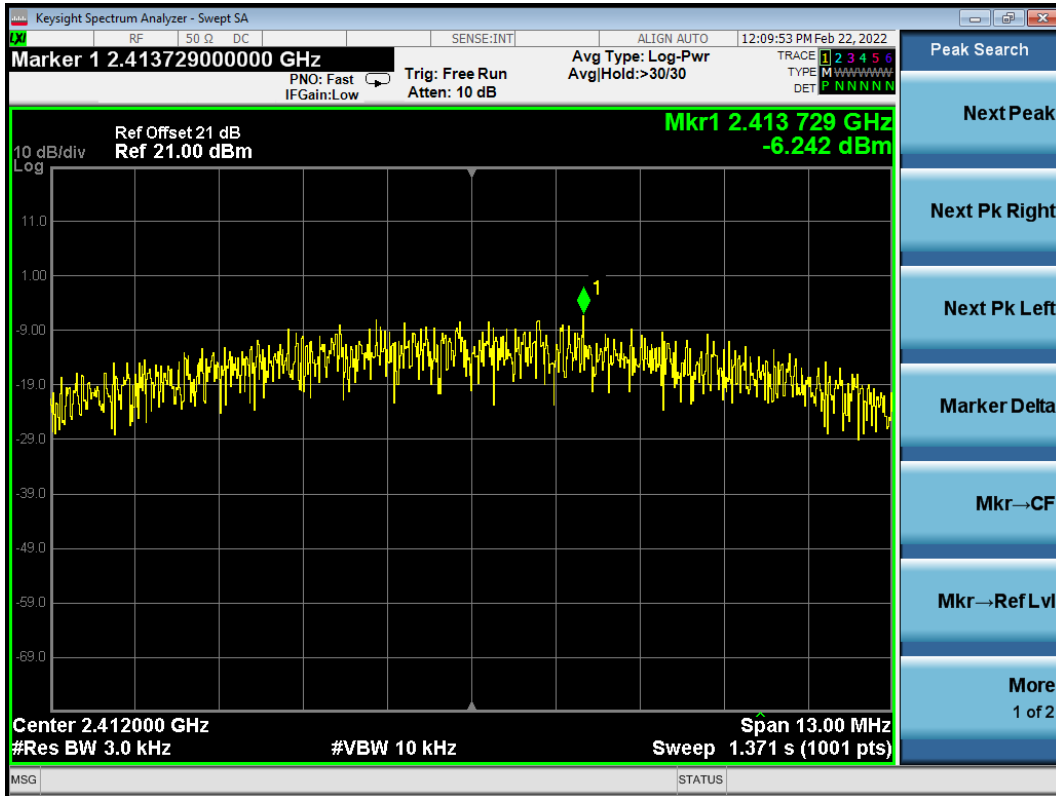

802.11b CH2437 MHz

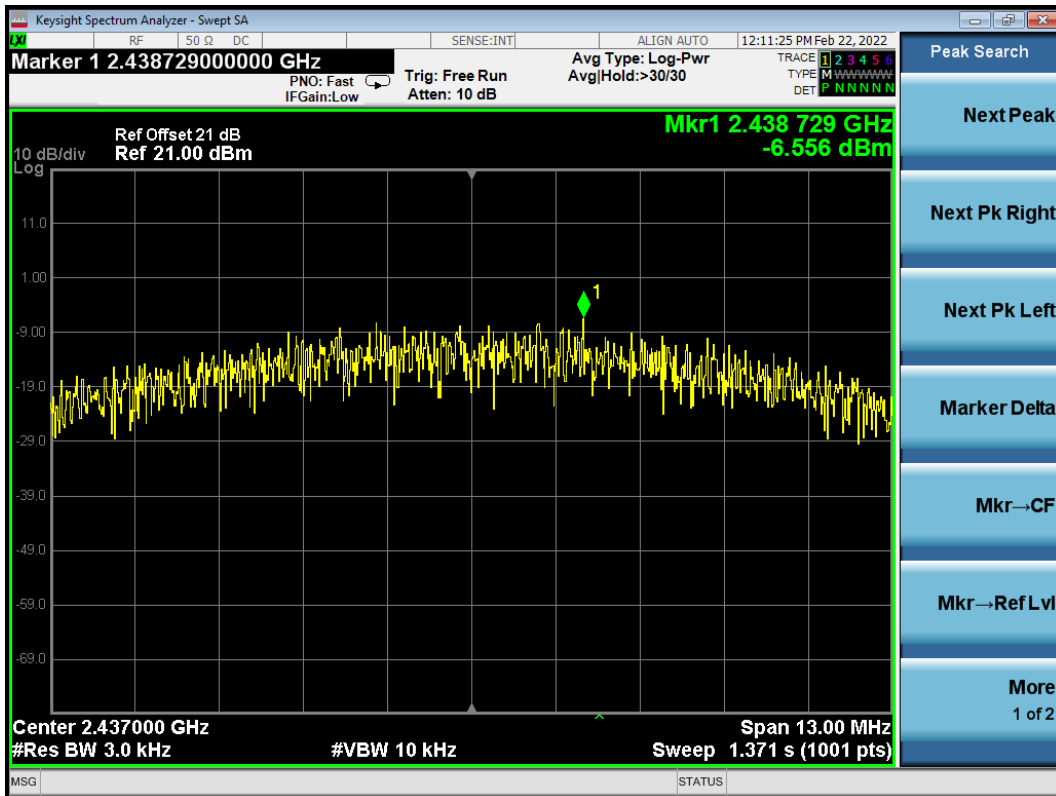

802.11b CH2462 MHz

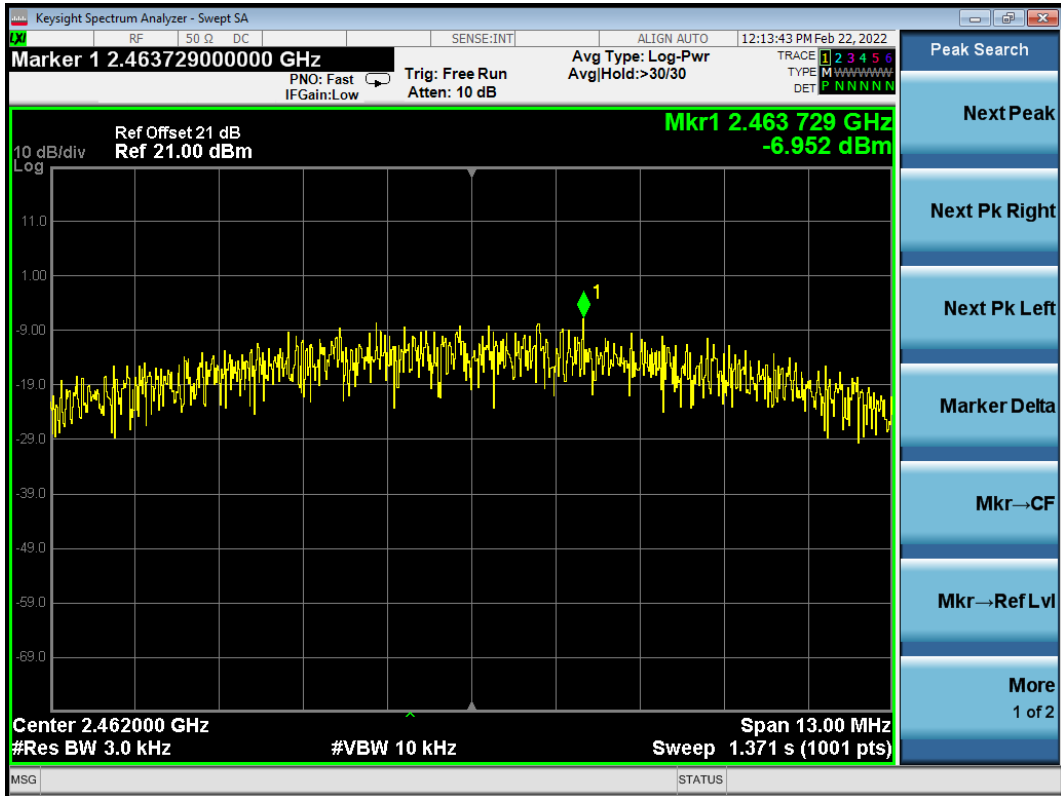

802.11g CH2412 MHz

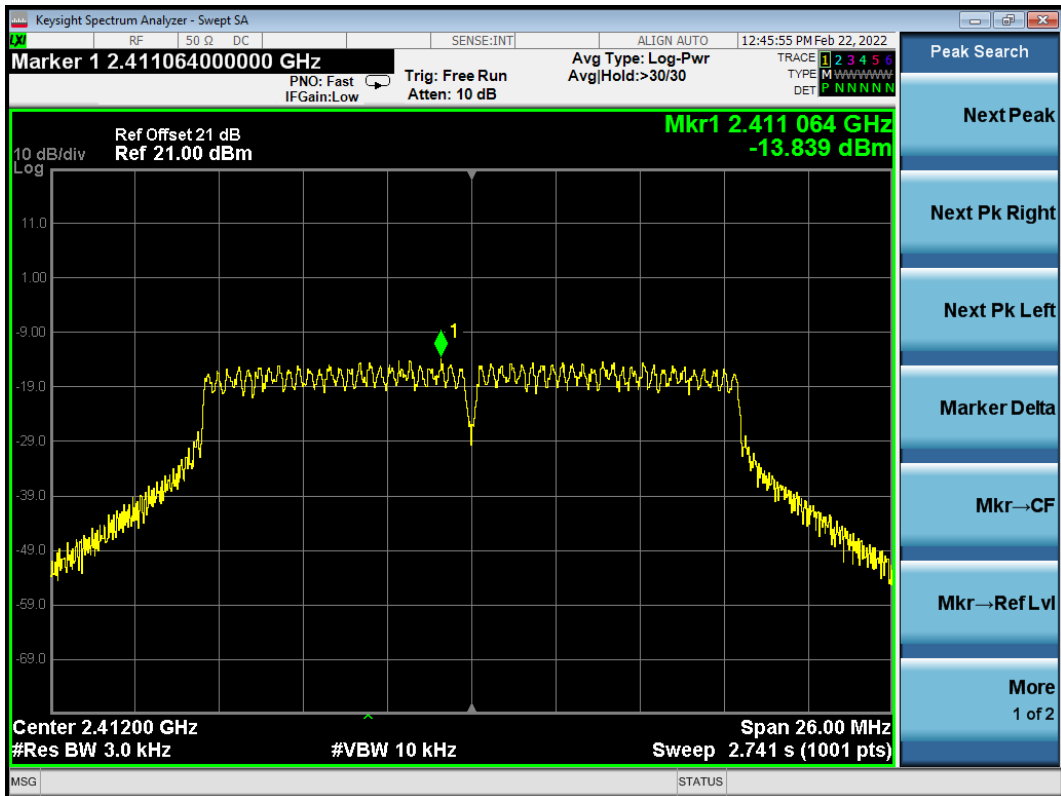

802.11g CH2437 MHz

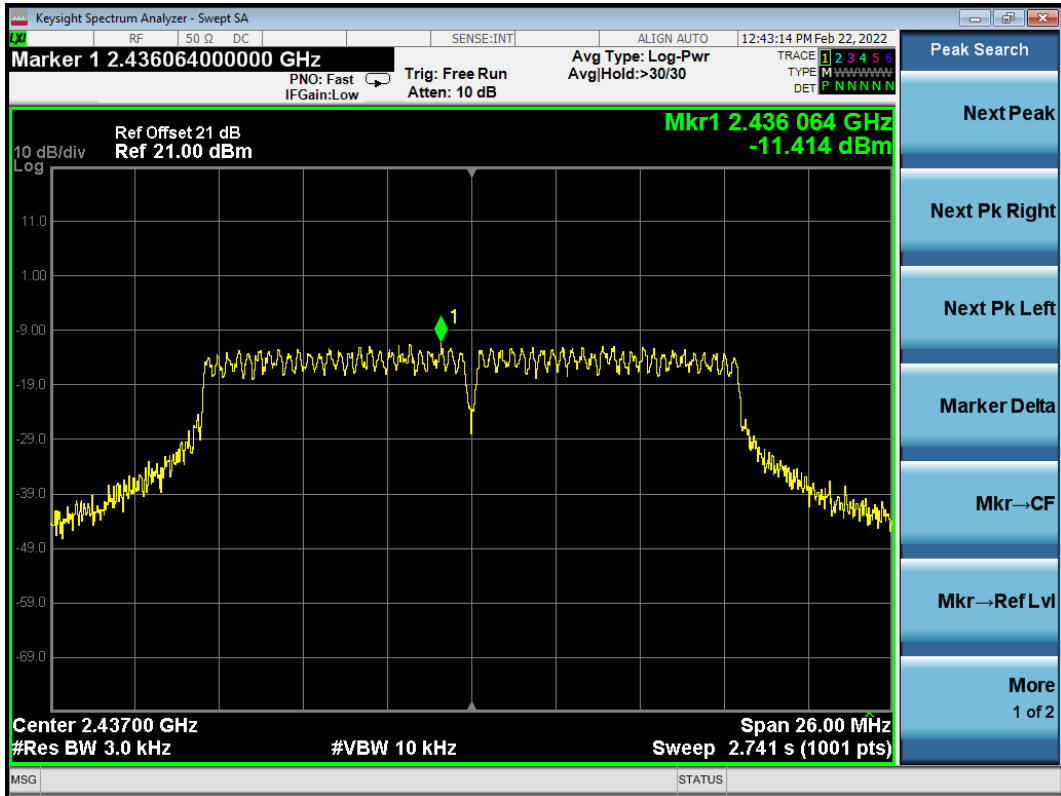

802.11g CH2462 MHz

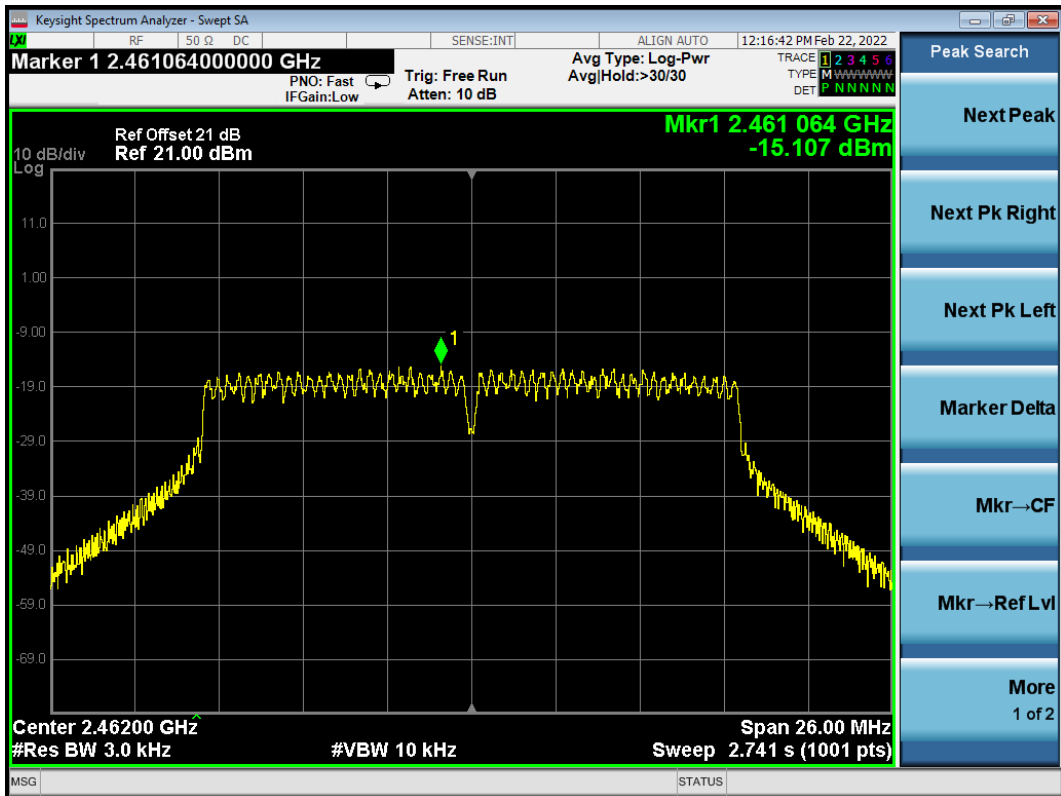

802.11n20 CH2412 MHz

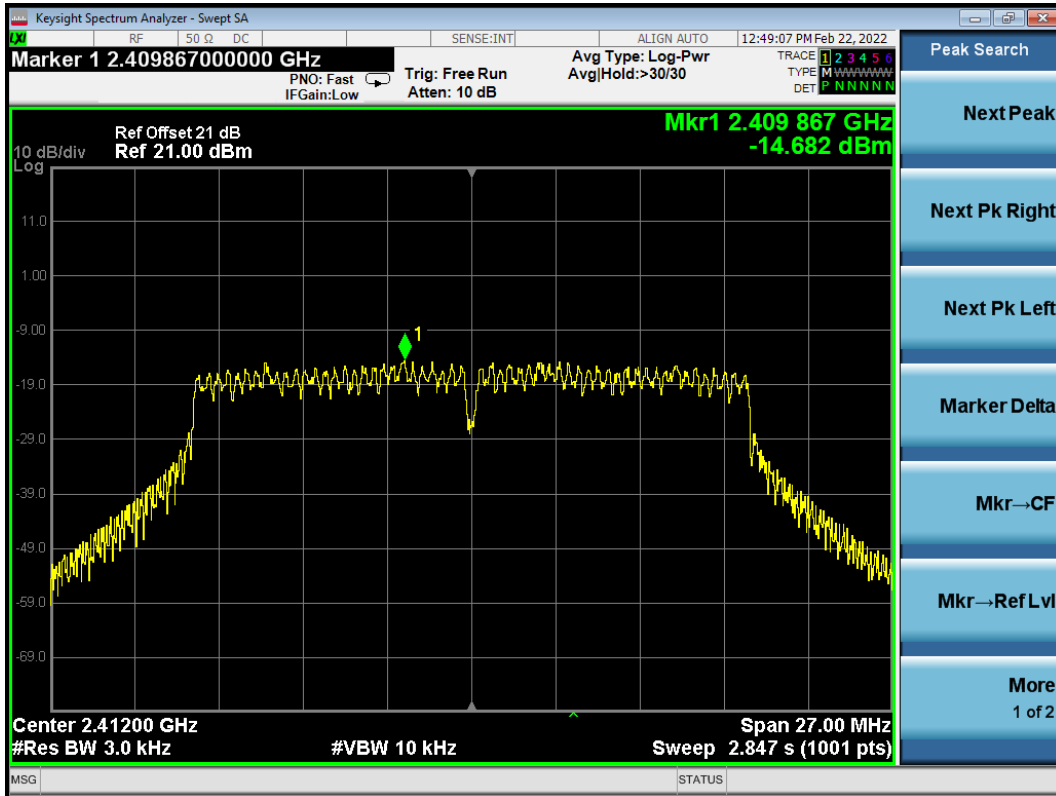

802.11n20 CH2437 MHz

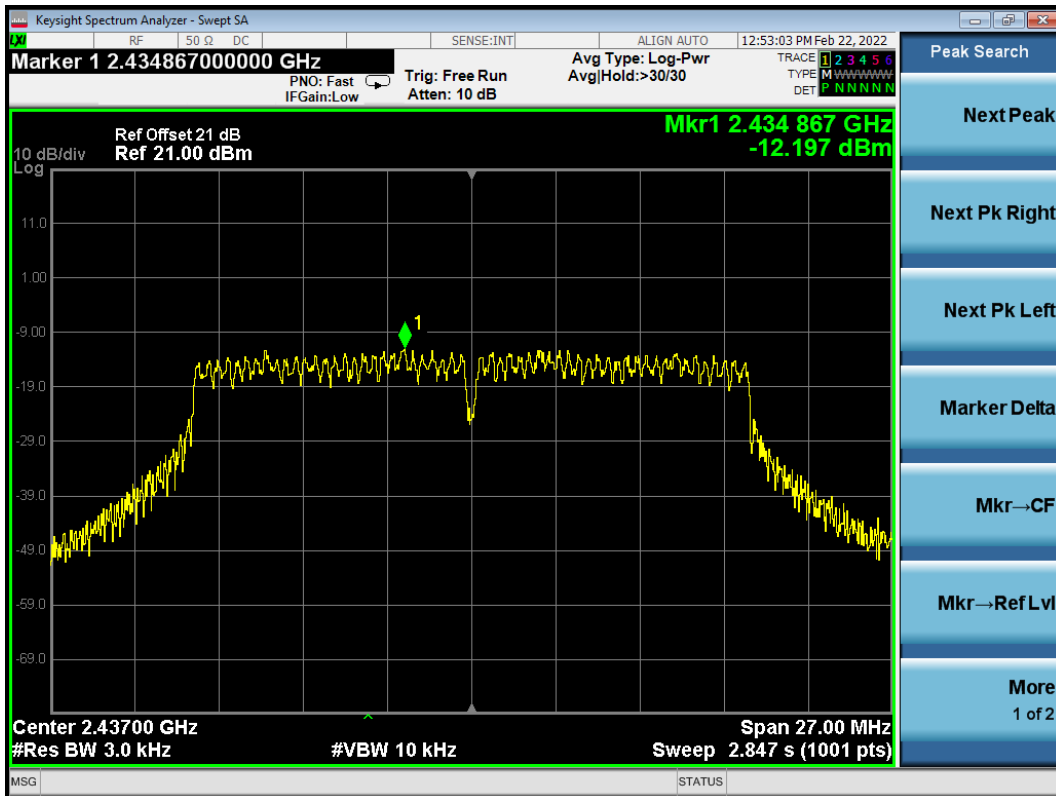

802.11n20 CH2462 MHz

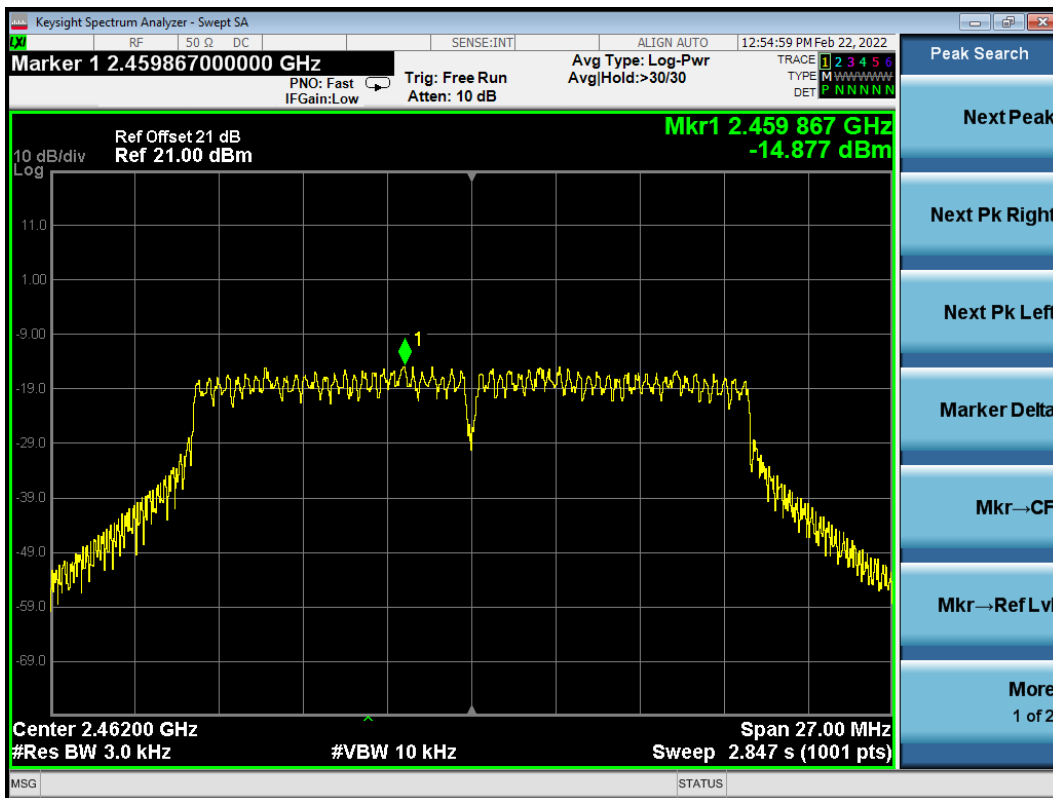

10 DEVIATION TO TEST SPECIFICATIONS

None.

11 MEASUREMENT UNCERTAINTY LIST

The measurement uncertainty was estimated for test on the EUT according to CISPR 16-4-2. This uncertainty represents an expanded uncertainty expressed at approximately the 95% confidence level using a coverage of K=2.

The uncertainties value is not used in determining the PASS/FAIL results.

Test Items/Facilities	Frequency/Equipment/Unit	Uncertainty
Conducted Emission No.1 Shielded Room	9kHz~150kHz	±3.1 dB
	150kHz~30MHz	±2.6 dB
Conducted Emission No.3 Shielded Room	9kHz~150kHz	±3.1 dB
	150kHz~30MHz	±2.6 dB
Radiated Emission	30MHz~200MHz, Horizontal	±3.8 dB
	30MHz~200MHz, Vertical	±4.1 dB
	200MHz~1000MHz, Horizontal	±3.6 dB
	200MHz~1000MHz, Vertical	±5.1 dB
	1GHz~6GHz	±5.3 dB
	6GHz~18GHz	±5.3 dB
	18GHz~40GHz	±3.5 dB
Output Power Test	50MHz~18GHz	0.77 dB
Power Density Test	9kHz~6GHz	1.08 dB
RF Frequency Test	9kHz~40GHz	6×10^{-4}
Bandwidth Test	9kHz~6GHz	1.5×10^{-3}
RF Radiated Power Test	30MHz~1000MHz	3.06 dB
Conducted Output Power Test	50MHz~18GHz	0.83 dB
AC Voltage(<10kHz) Test	120V~230V	0.04 %
DC Power Test	0V~30V	0.4 %
Temperature	-40°C~+100°C	0.52 °C
Humidity	30%~95%	2.6 %