

TEST REPORT

On behalf of

Savant Technologies LLC, dba GE Lighting, a Savant company

Product Name: Direct Connect Full Color A19

Model No.: CLEDA199CD1, CLEDA199CDRV

FCC ID: PUU-A19-DMFCVI

Prepared For: Savant Technologies LLC, dba GE Lighting, a Savant company
1975 Noble Road, Cleveland, OH 44112

Prepared By: Audix Technology (Shanghai) Co., Ltd.
3F and 4F, 34Bldg, 680 Guiping Rd.,
Caohejing Hi-Tech Park,
Shanghai 200233, China

Tel: +86-21-64955500



File No. : C1D2211043
Report No. : ACI-F23004
Date of Test : 2022.12.18-2023.01.08
Date of Report : 2023.01.17

The statement is based on a single evaluation of one sample of the above-mentioned products. It does not imply an assessment of the whole production and does not permit the use of the test lab logo. The report must not be used by the client to claim product certification, approval, or endorsement by NVLAP, NIST, or any agency of the Federal Government.

TABLE OF CONTENTS

	Page
1 SUMMARY OF STANDARDS AND RESULTS	5
1.1 Description of Standards and Results.....	5
2 GENERAL INFORMATION	6
2.1 Description of Equipment Under Test.....	6
2.2 EUT Specifications Assessed in Current Report.....	7
2.3 Test Information	7
2.4 Sample Description	7
2.5 Supported equipment.....	8
2.6 Description of Test Facility	8
3 CONDUCTED EMISSION TEST	9
3.1 Test Equipment.....	9
3.2 Block Diagram of Test Setup	9
3.3 Conducted Emission Limits (§15.207).....	10
3.4 Test Configuration.....	10
3.5 Operating Condition of EUT	10
3.6 Test Procedures	10
3.7 Test Results	11
4 RADIATED EMISSION TEST	13
4.1 Test Equipment.....	13
4.2 Block Diagram of Test Setup	13
4.3 Radiated Emission Limit (§15.209)	14
4.4 Test Configuration.....	14
4.5 Operating Condition of EUT	15
4.6 Test Procedures	15
4.7 Test Results	16
5 99% OCCUPIED BANDWIDTH MEASUREMENT	30
5.1 Test Equipment.....	30
5.2 Block Diagram of Test Setup	30
5.3 Operating Condition of EUT.....	30
5.4 Test Procedure.....	30
5.5 Test Results	31
6 6 DB BANDWIDTH MEASUREMENT	38
6.1 Test Equipment.....	38
6.2 Block Diagram of Test Setup	38
6.3 Specification Limits (§15.247(a)(2)).....	38
6.4 Operating Condition of EUT	38
6.5 Test Procedure.....	38
6.6 Test Results	39
7 MAXIMUM PEAK OUTPUT POWER MEASUREMENT	46
7.1 Test Equipment.....	46
7.2 Block Diagram of Test Setup	46
7.3 Specification Limits ((§15.247(b)(3))	46
7.4 Operating Condition of EUT	46

7.5 Test Procedure..... 46

7.6 Test Results 48

8 EMISSION LIMITATIONS MEASUREMENT..... 55

8.1 Test Equipment..... 55

8.2 Block Diagram of Test Setup 55

8.3 Specification Limits (§15.247(d)) 55

8.4 Operating Condition of EUT 55

8.5 Test Procedure..... 55

8.6 Test Results 57

9 POWER SPECTRAL DENSITY MEASUREMENT 82

9.1 Test Equipment..... 82

9.2 Block Diagram of Test Setup 82

9.3 Specification Limits (§15.247(e)) 82

9.4 Operating Condition of EUT 82

9.5 Test Procedure..... 82

9.6 Test Results 83

10 ANTENNA REQUIREMENT 90

10.1 Specification Limits (§15.203)..... 90

10.2 Result..... 90

11 DEVIATION TO TEST SPECIFICATIONS..... 91

12 MEASUREMENT UNCERTAINTY LIST 92

TEST REPORT

Applicant : Savant Technologies LLC, dba GE Lighting, a Savant company
 EUT Description : Direct Connect Full Color A19
 (A) Model No. : Refer to Sec.2.1
 (B) Power Supply : 120V AC 60Hz
 (C) Test Voltage : 120V/60Hz

Test Procedure Used:

*FCC RULES AND REGULATIONS PART 15 SUBPART C
 AND ANSI C63.10-2013*

The device described above is tested by Audix Technology (Shanghai) Co., Ltd. to determine the maximum emission levels emanating from the device. The maximum emission levels are compared to the FCC Part 15 Subpart C limits.

The test results are contained in this test report and Audix Technology (Shanghai) Co., Ltd. is assumed full responsibility for the accuracy and completeness of these measurements. This report also shows that the EUT (M/N: Refer to Sec2.1), which was tested is technically compliance with the FCC limits.

This report applies to above tested Sample only. This report shall not be reproduced in part without written approval of Audix Technology (Shanghai) Co., Ltd.

The test results for EUT's BLE function are contained in No.ACI-F23003 report.

Date of Test : 2022.12.18-2023.01.08 Date of Report : 2023.01.17

Producer : *Mindy Wang*
 MINDY WANG / Assistant

Review : *Byron Wu*
 BYRON WU / Deputy Assistant Manager
 For and on behalf of
 Audix Technology (Shanghai) Co., Ltd.

Signatory : *Kamp Chen*
 Authorized Signature(s) KAMPCHEN / Manager

1 SUMMARY OF STANDARDS AND RESULTS

1.1 Description of Standards and Results

The EUT have been tested according to the applicable standards as referenced below:

Description / Test Item	Test Standard	Results	Meets Limit
EMISSION			
Conducted Emission	FCC RULES AND REGULATIONS PART 15 SUBPART C AND ANSI C63.10:2013	Pass	15.207
Radiated Emission	FCC RULES AND REGULATIONS PART 15 SUBPART C AND ANSI C63.10:2013	Pass	15.209(a) 15.205(a)(c)
6 dB Bandwidth Measurement	FCC RULES AND REGULATIONS PART 15 SUBPART C AND ANSI C63.10:2013	Pass	15.247(a)(2)
Maximum Peak Output Power Measurement	FCC RULES AND REGULATIONS PART 15 SUBPART C AND ANSI C63.10:2013	Pass	15.247(b)(3)
Emission Limitations Measurement	FCC RULES AND REGULATIONS PART 15 SUBPART C AND ANSI C63.10:2013	Pass	15.247(d)
Band Edge Measurement	FCC RULES AND REGULATIONS PART 15 SUBPART C AND ANSI C63.10:2013	Pass	15.247(d)
Power Spectral Density Measurement	FCC RULES AND REGULATIONS PART 15 SUBPART C AND ANSI C63.10:2013	Pass	15.247(e)
Antenna Requirement	FCC RULES AND REGULATIONS PART 15 SUBPART C AND ANSI C63.10:2013	Pass	15.203
N/A is an abbreviation for Not Applicable.			

2 GENERAL INFORMATION

2.1 Description of Equipment Under Test

Description : Direct Connect Full Color A19

Type of EUT : Production Pre-product Pro-type

Model Number : CLEDA199CD1, CLEDA199CDRV

Test model : CLEDA199CD1

Note : The Models are the same except for Model Name as sale purpose.

Radio Tech : BLE 4.2;
IEEE 802.11 b/g/n.

Channel Freq. : BLE: 2402MHz-2480MHz;
802.11b/g/n20: 2412MHz-2462MHz;
802.11n40: 2422MHz-2452MHz.

Modulation : BLE: GFSK;
802.11b: DSSS (CCK, DQPSK, DBPSK);
802.11g/n: OFDM (64QAM, 16QAM, QPSK, BPSK).

Antenna Info. : Antenna Type: PCB Antenna
Antenna Gain: 0.5 dBi

Applicant : Savant Technologies LLC, dba GE Lighting, a Savant company
1975 Noble Road, Cleveland, OH 44112

Manufacturer : same as Applicant

Factory : Foshan Electrical and Lighting Co., Ltd
64 Notth of Fenjiang Rd, Foshan, Guangdong, China

2.2 EUT Specifications Assessed in Current Report

Mode	Modulation	Data Rate(Mbps)
802.11b	DS (DQPSK, DBPSK, CCK)	Up to 11
802.11g	OFDM (64-QAM, 16-QAM, QPSK, BPSK)	Up to 54
802.11n-HT 20	OFDM (64-QAM, 16-QAM, QPSK, BPSK)	Up to 72.2
802.11n-HT 40	OFDM (64-QAM, 16-QAM, QPSK, BPSK)	Up to 150

Channel List			
Channel No.	Frequency (MHz)	Channel No.	Frequency (MHz)
1	2412	7	2442
2	2417	8	2447
3	2422	9	2452
4	2427	10	2457
5	2432	11	2462
6	2437		

2.3 Test Information

The test software “ EspRFTestTool_v2.8_Manual.exe” was used to control EUT work in TX mode, Power Index and select test channel.

Modulation	data rate (Mbps)	Test Channel		Frequency (MHz)
802.11b	11	Low:	1	2412
		Middle:	6	2437
		High:	11	2462
802.11g	6	Low:	1	2412
		Middle:	6	2437
		High:	11	2462
802.11n20	MCS0	Low:	1	2412
		Middle:	6	2437
		High:	11	2462
802.11n40	MCS0	Low:	3	2422
		Middle:	6	2437
		High:	9	2452

2.4 Sample Description

Test Item	Model Number	Sample Number	Date of receipted
Conducted Emission	CLEDA199CD1	E2212968-03/03	2022.12.14
Radiated Emission	CLEDA199CD1	E2211905-01/03	2022.11.28
Conducted RF Test	CLEDA199CD1	E2211905-01/03	2022.11.28

2.5 Supported equipment

Brand : Acer
Product Name: : Notebook PC
Model Name : TravelMate P238 series
Model Number : N15W8

Product Name : Test Fixture
Product Function : USB to TTL

2.6 Description of Test Facility

Name of Firm : Audix Technology (Shanghai) Co., Ltd.

Site Location : 3F and 4F, 34Bldg, 680 Guiping Rd.,
Caohejing Hi-Tech Park,
Shanghai 200233, China.

Accredited by NVLAP, Lab Code : 200371-0

FCC Designation Number : CN5027

Test Firm Registration Number : 954668

3 CONDUCTED EMISSION TEST

3.1 Test Equipment

The following test equipments are used during the conducted emission test in a shielded room:

Item	Type	Manufacturer	Model No.	Serial No.	Cal. Date	Cal. Interval
1.	Test Receiver	R&S	ESCI	100841	2022.01.25	1 Year
2.	Artificial Mains Network (AMN)	R&S	ESH2-Z5	843890/011	2022.01.06	1 Year
3.	Software	Audix	e3	6.2009-1-15	--	--

3.2 Block Diagram of Test Setup

3.2.1 Conducted Disturbance Test Setup

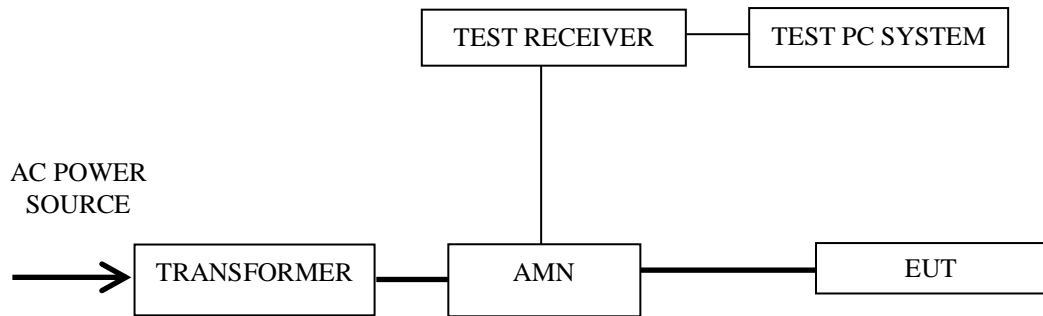

— : Signal Line
 — : Power Line

3.3 Conducted Emission Limits (§15.207)

Frequency Range (MHz)	Limits dB(μV)	
	Quasi-peak	Average
0.15 ~ 0.5	66~56	56~46
0.5 ~ 5	56	46
5 ~ 30	60	50
NOTE 1 – The lower limit shall apply at the transition frequencies. NOTE 2 – The limit decreases linearly with the logarithm of the frequency in the range 0.15 MHz~0.50 MHz		

3.4 Test Configuration

The EUT (listed in Sec.2.1) was installed as shown on Sec.3.2 to meet FCC requirement and operating in a manner which tends to maximize its emission level in a normal application.

3.5 Operating Condition of EUT

- 3.5.1 Setup the EUT as shown in Sec. 3.2.
- 3.5.2 Turn on the power of all equipment.
- 3.5.3 Turn the EUT on the test mode, and then test.

3.6 Test Procedures

The EUT was placed upon a non-metallic table, which is 0.8 m above the horizontal conducting ground plane and 0.4 m from a vertical reference plane. The EUT was connected to the power mains through an Artificial Mains Network (AMN) to provide a 50 Ω coupling impedance for the measuring equipment. Both sides of AC line (Line & Neutral) were checked to find out the maximum conducted emission according to FCC Part 15 Subpart C and ANSI C63.10: 2013 requirements during conducted disturbance test.

The I.F. bandwidth of Test Receiver ESCI was set at 9 kHz.

The frequency range from 150 kHz to 30 MHz was checked.

Test with a dummy load in lieu of the antenna to determine compliance with Section 15.207 limits within the transmitter's fundamental emission band. (According to KDB 174176 D01 Line Conducted FAQ)

The test modes were done on conducted disturbance test and all the test results are listed in Sec. 3.7

3.7 Test Results

< **PASS** >

The frequency and amplitude of the highest conducted emission relative the limit is reported. All the emissions not reported below are too low against the FCC limit.

Worst case emission:

No.	Operation	Modulation	Channel	Frequency (MHz)	Data Page
1.	Transmitting	802.11b	1	2412	P12

NOTE 1 – Level = Read Level + AMN Factor + Cable Loss

NOTE 2 – “QP” means “Quasi-Peak” values

NOTE 3 – The emission levels which not reported are too low against the official limit.

Worst case emission

EUT : Direct Connect Full Color A19 Temperature : 22°C

Model No. : CLEDA199CD1 Humidity : 51%RH

Test Mode : Transmitting Date of Test : 2022.12.16

Polarization	Frequency (MHz)	Meter Reading dB (µV)	AMN Factor (dB)	Cable Loss (dB)	Emission Level dB (µV)	Limits dB (µV)	Margin (dB)	Remark
Line	0.1524	52.82	0.16	0.03	53.01	65.87	12.86	QP
	0.1524	27.66	0.16	0.03	27.85	55.87	28.02	Average
	0.1694	51.54	0.16	0.03	51.73	64.99	13.26	QP
	0.1694	27.6	0.16	0.03	27.79	54.99	27.2	Average
	0.204	48.5	0.17	0.03	48.7	63.45	14.75	QP
	0.204	24.2	0.17	0.03	24.4	53.45	29.05	Average
	0.2445	45.33	0.18	0.03	45.54	61.94	16.4	QP
	0.2445	20.1	0.18	0.03	20.31	51.94	31.63	Average
	0.4916	30.25	0.2	0.04	30.49	56.14	25.65	QP
	0.4916	9.5	0.2	0.04	9.74	46.14	36.4	Average
	2.709	16.2	0.25	0.1	16.55	56	39.45	QP
	2.709	3.21	0.25	0.1	3.56	46	42.44	Average
Neutral	0.1516	52.9	0.12	0.03	53.05	65.91	12.86	QP
	0.1516	28	0.12	0.03	28.15	55.91	27.76	Average
	0.174	50.9	0.12	0.03	51.05	64.77	13.72	QP
	0.174	27.4	0.12	0.03	27.55	54.77	27.22	Average
	0.2071	47.88	0.12	0.03	48.03	63.32	15.29	QP
	0.2071	23.9	0.12	0.03	24.05	53.32	29.27	Average
	0.2442	44.97	0.14	0.03	45.14	61.95	16.81	QP
	0.2442	20.1	0.14	0.03	20.27	51.95	31.68	Average
	0.6612	25.73	0.22	0.05	26	56	30	QP
	0.6612	12.8	0.22	0.05	13.07	46	32.93	Average
	2.71	16.82	0.37	0.1	17.29	56	38.71	QP
	2.71	3.11	0.37	0.1	3.58	46	42.42	Average

TEST ENGINEER: Jarey

4 RADIATED EMISSION TEST

4.1 Test Equipment

The following test equipment are used during the radiated emission test in a semi-anechoic chamber:

Item	Type	Manufacturer	Model No.	Serial No.	Cal. Date	Cal. Interval
1.	Preamplifier	Agilent	8447D	2944A10548	2022.06.06	1 Year
2.	Preamplifier	HP	8449B	3008A00864	2022.06.06	1 Year
3.	Spectrum Analyzer	Agilent	N9010A	MY52221182	2022.09.15	1 Year
4.	Test Receiver	R&S	ESCI	101303	2022.06.06	1 Year
5.	Bilog Antenna+6dB Attenuator	Schwarz beck	VULB 9168+EMCI-N-6-06	707+AT-N0637	2022.07.25	1 Year
6.	Horn Antenna	EMCO	3115	9607-4878	2022.07.27	1 Year
7.	Horn Antenna	EMCO	3116	00062643	2021.12.13	2 Year
8.	Cavity Band Rejection Filter	Microwave	WT-A3882-R10	WT200312-1-1	2022.06.06	1 Year
9.	Software	Audix	e3	SET00200 9912M295-2	--	--

4.2 Block Diagram of Test Setup

4.2.1 EUT & Peripherals



4.2.2 Below 1GHz

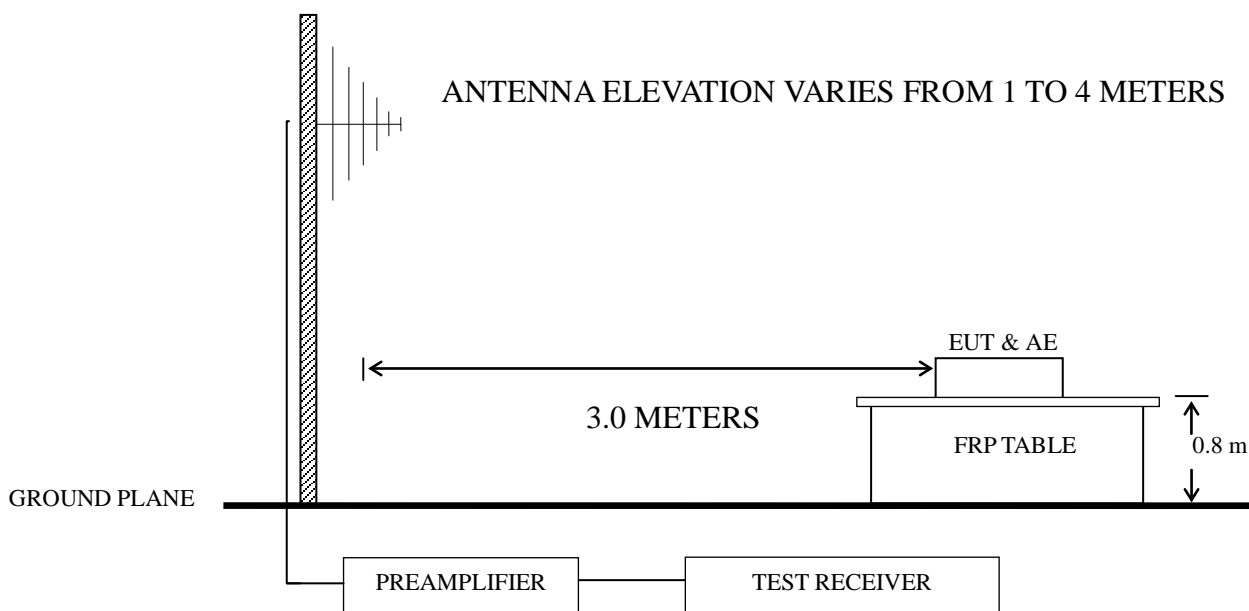

4.2.3 Above 1GHz

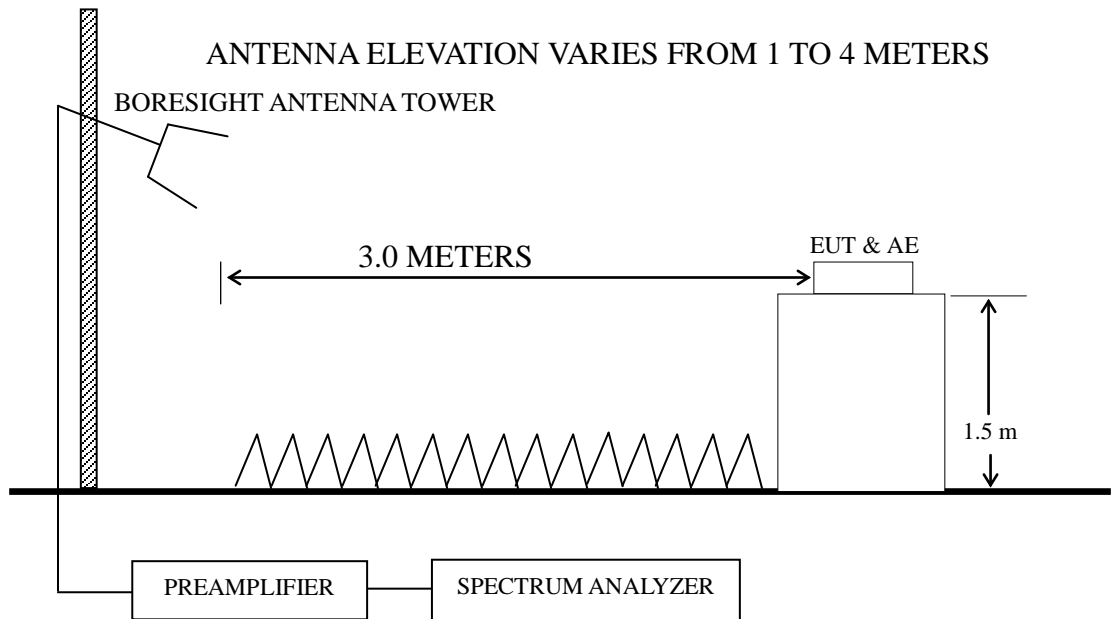

4.3 Radiated Emission Limit (§15.209)

Frequency (MHz)	Distance (m)	Field strength limits (μV/m)	
		(μV/m)	dB(μV/m)
30 ~ 88	3	100	40.0
88 ~ 216	3	150	43.5
216 ~ 960	3	200	46.0
Above 960	3	500	54.0

NOTE 1 - Emission Level dB (μV/m) = 20 log Emission Level (μV/m)

NOTE 2 - The tighter limit applies at the band edges.

NOTE 3 - Distance refers to the distance in meters between the measuring instrument antenna and the closed point of any part of the device or system.

NOTE 4 - The limits shown are based on Quasi-peak value detector below or equal to 1GHz and Average value detector above 1GHz.

NOTE 5 - Above 1 GHz, the limit on peak emission is 20 dB above the maximum permitted average emission limit applicable to the EUT

4.4 Test Configuration

The EUT (listed in Sec.2.1) and the simulators (listed in Sec.2.2) were installed as shown on Sec.4.2 to meet FCC requirements and operating in a manner that tends to maximize its emission level in a normal application.

4.5 Operating Condition of EUT

4.5.1 Setup the EUT as shown in Sec. 4.2.

4.5.2 Turn on the power of all equipment.

4.5.3 Turn the EUT on the test mode, and then test.

4.6 Test Procedures

Radiated emission test applies to harmonics/spurs that fall in the restricted bands listed in Section 15.205. The maximum permitted average field strength is listed in Section 15.209. A pre-amp is necessary for this measurement. For measurement above 1 GHz, set RBW = 1MHz, VBW = 10 Hz, Sweep: Auto. If the emission is pulsed, modify the unit for continuous operation; use the settings shown above, then correct the reading by subtracting the peak-average correction factor, derived from the appropriate duty cycle calculation.

The EUT was placed on a turntable. Below 1 GHz, the table height is 80 cm above the reference ground plane. Above 1 GHz, the table height is 1.5 m. The turntable rotated 360 degrees to determine the position of the maximum emission level. The EUT was set 3 meters away from the receiving antenna, which was mounted on an antenna tower. The antenna moved up and down between 1 meter and 4 meters to find out the maximum emission level. Broadband antenna (Calibrated Bilog Antenna) or Horn antenna was used as receiving antenna. Both horizontal and vertical polarizations of the antenna were set on measurement. In order to find the maximum emission, all of the interference cables were manipulated according to ANSI C63.10: 2013 requirements during radiated emission test.

The bandwidth of Test Receiver R&S ESCI was set at 120 kHz from 30MHz to 1000MHz.

The bandwidth of Agilent N9010A was set at 1MHz for above 1GHz.

The frequency range from 30 MHz to 25 GHz (Up to 10th harmonics from fundamental frequency) was checked.

All the test results are listed in Sec.4.7.

4.7 Test Results

<PASS>

The frequency and amplitude of the highest radiated emission relative the limit is reported. All the emissions not reported below are too low against the FCC limit.

Frequency range: below 1GHz (Worst case emission)

No.	Operation	Modulation	Channel	Frequency	Data Page
1.	Transmitting	802.11b	1	2412 MHz	P18
2.		802.11g	11	2462 MHz	P18
3.		802.11n20	11	2462 MHz	P19
4.		802.11n40	9	2452MHz	P19

Frequency range: above 1GHz

No.	Operation	Modulation	Channel	Frequency	Data Page
1.	Transmitting	802.11b	1	2412 MHz	P20
2.			6	2437 MHz	P20
3.			11	2462 MHz	P21
4.		802.11g	11	2462 MHz	P21
5.		802.11n20	11	2462 MHz	P22
6.		802.11n40	9	2452 MHz	P22

Band-Edge:

No.	Operation	Modulation	Channel	Frequency	Data Page
1.	Transmitting	802.11b	1	2412 MHz	P23
2.			11	2462 MHz	P23
3.		802.11g	1	2412 MHz	P23
4.			11	2462 MHz	P24
5.		802.11n20	1	2412 MHz	P24
6.			11	2462 MHz	P24
7.		802.11n40	3	2422 MHz	P25
8.			9	2452 MHz	P25

Restricted bands:

No.	Operation	Modulation	Channel	Frequency	Data Page
1.	Transmitting	802.11b	1	2412 MHz	P26
2.			11	2462 MHz	P26
3.		802.11g	1	2412 MHz	P27
4.			11	2462 MHz	P27
5.		802.11n20	1	2412 MHz	P28
6.			11	2462 MHz	P28
7.		802.11n40	3	2422 MHz	P29
8.			9	2452 MHz	P29

NOTE 1 – Level = Read Level + Antenna Factor + Cable Loss - Preamp Factor
 NOTE 2 – “QP” means “Quasi-Peak” values

NOTE 3 – 0° was the table front facing the antenna. Degree is calculated from 0° clockwise facing the antenna.

NOTE 4 – The emission levels which not reported are too low against the official limit.

NOTE 5 – The emission levels recorded below is data of EUT configured in Standing direction, for Standing direction was the maximum emission direction during the test. The data of Side & Lying direction are too low against the official limit to be reported.

NOTE 6 – All reading are Quasi-Peak values below or equal to 1GHz, Peak and Average values above 1GHz.

For above 1GHz test, if the peak measured value complies with the average limit, it is unnecessary to perform an average measurement.

NOTE 7 – The frequency range 2310-2390MHz & 2483.5-2500MHz were tested for Restricted bands.

Worst case emission < 1GHz

EUT : Direct Connect Full Color A19 Temperature : 22°C

Model No. : CLEDA199CD1 Humidity : 51%RH

Test Mode : Transmitting Date of Test : 2023.01.08

802.11b CH2412MHz

Polarization	Frequency (MHz)	Meter Reading dB (µV)	Antenna Factor (dB/m)	Cable Loss (dB)	Preamplifier Factor (dB)	Emission Level dB (µV/m)	Limits dB (µV/m)	Margin (dB)	Remark
Horizontal	49.359	23.71	19.47	0.74	28.2	15.72	40	24.28	QP
	143.33	38.95	19.05	1.29	27.82	31.47	43.5	12.03	QP
	168.41	38.8	18.85	1.39	27.67	31.37	43.5	12.13	QP
	191.75	38.36	16.7	1.51	27.47	29.1	43.5	14.4	QP
	319.94	34.31	19.9	1.95	27.13	29.03	46	16.97	QP
	449.56	28.65	23	2.29	27.8	26.14	46	19.86	QP
Vertical	53.318	23.13	19.57	0.78	28.19	15.29	40	24.71	QP
	97.456	34.46	14.6	1.08	28.01	22.13	43.5	21.37	QP
	143.83	26.67	19.1	1.29	27.82	19.24	43.5	24.26	QP
	169.01	26.63	18.8	1.39	27.66	19.16	43.5	24.34	QP
	319.94	27.12	19.9	1.95	27.13	21.84	46	24.16	QP
	550.95	25.8	24.3	2.53	27.9	24.73	46	21.27	QP

802.11g CH2462MHz

Polarization	Frequency (MHz)	Meter Reading dB (µV)	Antenna Factor (dB/m)	Cable Loss (dB)	Preamplifier Factor (dB)	Emission Level dB (µV/m)	Limits dB (µV/m)	Margin (dB)	Remark
Horizontal	56.593	23.92	19.44	0.81	28.17	16	40	24	QP
	143.83	38.37	19.1	1.29	27.82	30.94	43.5	12.56	QP
	155.91	38.22	19.3	1.34	27.76	31.1	43.5	12.4	QP
	180.65	37.52	17.85	1.44	27.58	29.23	43.5	14.27	QP
	319.94	33.36	19.9	1.95	27.13	28.08	46	17.92	QP
	576.64	24.19	24.73	2.65	27.84	23.73	46	22.27	QP
Vertical	52.391	24.89	19.6	0.78	28.19	17.08	40	22.92	QP
	97.456	34.55	14.6	1.08	28.01	22.22	43.5	21.28	QP
	143.33	26.77	19.05	1.29	27.82	19.29	43.5	24.21	QP
	168.41	26.81	18.85	1.39	27.67	19.38	43.5	24.12	QP
	319.94	28.88	19.9	1.95	27.13	23.6	46	22.4	QP
	590.97	24.9	25.1	2.73	27.81	24.92	46	21.08	QP

802.11n20 CH2462MHz

Polarization	Frequency (MHz)	Meter Reading dB (μV)	Antenna Factor (dB/m)	Cable Loss (dB)	Preamplifier Factor (dB)	Emission Level dB (μV/m)	Limits dB (μV/m)	Margin (dB)	Remark
Horizontal	51.301	22.93	19.6	0.76	28.19	15.1	40	24.9	QP
	143.83	39.19	19.1	1.29	27.82	31.76	43.5	11.74	QP
	155.91	38.29	19.3	1.34	27.76	31.17	43.5	12.33	QP
	180.65	37.88	17.85	1.44	27.58	29.59	43.5	13.91	QP
	319.94	32.88	19.9	1.95	27.13	27.6	46	18.4	QP
	578.67	24.77	24.77	2.65	27.83	24.36	46	21.64	QP
Vertical	56.593	24.73	19.44	0.81	28.17	16.81	40	23.19	QP
	97.456	35.46	14.6	1.08	28.01	23.13	43.5	20.37	QP
	143.83	27.44	19.1	1.29	27.82	20.01	43.5	23.49	QP
	169.01	26.62	18.8	1.39	27.66	19.15	43.5	24.35	QP
	319.94	28.2	19.9	1.95	27.13	22.92	46	23.08	QP
	550.95	26.39	24.3	2.53	27.9	25.32	46	20.68	QP

802.11n40 CH2452MHz

Polarization	Frequency (MHz)	Meter Reading dB (μV)	Antenna Factor (dB/m)	Cable Loss (dB)	Preamplifier Factor (dB)	Emission Level dB (μV/m)	Limits dB (μV/m)	Margin (dB)	Remark
Horizontal	48.502	23.4	19.35	0.74	28.21	15.28	40	24.72	QP
	143.83	39.16	19.1	1.29	27.82	31.73	43.5	11.77	QP
	155.91	38.58	19.3	1.34	27.76	31.46	43.5	12.04	QP
	191.75	38.62	16.7	1.51	27.47	29.36	43.5	14.14	QP
	319.94	33.53	19.9	1.95	27.13	28.25	46	17.75	QP
	533.83	27.46	23.9	2.52	27.9	25.98	46	20.02	QP
Vertical	48.502	24.53	19.35	0.74	28.21	16.41	40	23.59	QP
	97.456	33.89	14.6	1.08	28.01	21.56	43.5	21.94	QP
	144.34	27.38	19.1	1.29	27.82	19.95	43.5	23.55	QP
	167.82	26.9	18.9	1.39	27.67	19.52	43.5	23.98	QP
	319.94	27.46	19.9	1.95	27.13	22.18	46	23.82	QP
	550.95	24.96	24.3	2.53	27.9	23.89	46	22.11	QP

TEST ENGINEER: Jarey

Radiated Emission > 1GHz

EUT : Direct Connect Full Color A19 Temperature : 22°C

Model No. : CLEDA199CD1 Humidity : 51%RH

Test Mode : Transmitting Date of Test : 2022.12.22-2023.01.08

802.11b CH2412MHz

Polarization	Frequency (MHz)	Meter Reading dB (µV)	Antenna Factor (dB/m)	Cable Loss (dB)	Preamp Factor (dB)	Emission Level dB (µV/m)	Limits dB (µV/m)	Margin (dB)	Remark
Horizontal	1378	50.94	24.87	4.11	36.3	43.62	74	30.38	Peak
	3367	42.39	31.01	6.23	35.18	44.45	74	29.55	Peak
	4824	50.14	33.26	7.55	34.75	56.2	74	17.8	Peak
	4824	42.83	33.26	7.55	34.75	48.89	54	5.11	Average
	6616	37.7	34.69	8.93	34.76	46.56	74	27.44	Peak
	8416	36.83	38.47	10.46	34.76	51	74	23	Peak
Vertical	1360	48.02	24.81	4.07	36.3	40.6	74	33.4	Peak
	3421	41.46	31.14	6.31	35.16	43.75	74	30.25	Peak
	4824	51.67	33.26	7.55	34.75	57.73	74	16.27	Peak
	4824	44.64	33.26	7.55	34.75	50.7	54	3.3	Average
	6814	37.27	35.17	9.09	34.78	46.75	74	27.25	Peak
	8569	36.84	38.54	10.52	34.74	51.16	74	22.84	Peak

802.11b CH2437MHz

Polarization	Frequency (MHz)	Meter Reading dB (µV)	Antenna Factor (dB/m)	Cable Loss (dB)	Preamp Factor (dB)	Emission Level dB (µV/m)	Limits dB (µV/m)	Margin (dB)	Remark
Horizontal	1189	51.45	24.29	3.79	36.3	43.23	74	30.77	Peak
	3439	41.83	31.16	6.31	35.16	44.14	74	29.86	Peak
	4870	47.16	33.49	7.61	34.74	53.52	74	20.48	Peak
	4874	39.27	33.49	7.61	34.74	45.63	54	8.37	Average
	6886	38.42	35.36	9.18	34.79	48.17	74	25.83	Peak
	8398	36.95	38.43	10.4	34.76	51.02	74	22.98	Peak
Vertical	1900	44.16	26.76	4.81	36.3	39.43	74	34.57	Peak
	3583	41.85	31.53	6.44	35.12	44.7	74	29.3	Peak
	4874	51.78	33.49	7.61	34.74	58.14	74	15.86	Peak
	4874	44.42	33.49	7.61	34.74	50.78	54	3.22	Average
	7255	36.83	36.25	9.47	34.8	47.75	74	26.25	Peak
	9091	36.72	38.22	10.79	34.69	51.04	74	22.96	Peak

802.11b CH2462MHz

Polarization	Frequency (MHz)	Meter Reading dB (μV)	Antenna Factor (dB/m)	Cable Loss (dB)	Preamp Factor (dB)	Emission Level dB (μV/m)	Limits dB (μV/m)	Margin (dB)	Remark
Horizontal	1189	49.95	24.29	3.79	36.3	41.73	74	32.27	Peak
	3043	42.56	30.21	5.92	35.28	43.41	74	30.59	Peak
	4924	46.06	33.72	7.67	34.72	52.73	74	21.27	Peak
	4924	37.81	33.72	7.67	34.72	44.48	54	9.52	Average
	6751	38.37	35.02	9.01	34.78	47.62	74	26.38	Peak
	8533	37.83	38.56	10.52	34.75	52.16	74	21.84	Peak
Vertical	1360	47.41	24.81	4.07	36.3	39.99	74	34.01	Peak
	3448	43.62	31.19	6.31	35.15	45.97	74	28.03	Peak
	4924	51.2	33.72	7.67	34.72	57.87	74	16.13	Peak
	4924	43.66	33.72	7.67	34.72	50.33	54	3.67	Average
	6877	39.84	35.31	9.18	34.79	49.54	74	24.46	Peak
	8632	36.73	38.48	10.52	34.73	51	74	23	Peak

802.11g CH2462MHz

Polarization	Frequency (MHz)	Meter Reading dB (μV)	Antenna Factor (dB/m)	Cable Loss (dB)	Preamp Factor (dB)	Emission Level dB (μV/m)	Limits dB (μV/m)	Margin (dB)	Remark
Horizontal	1801	45.89	26.42	4.68	36.3	40.69	74	33.31	Peak
	3385	42.51	31.05	6.27	35.17	44.66	74	29.34	Peak
	4924	47.72	33.72	7.67	34.72	54.39	74	19.61	Peak
	4924	36.52	33.72	7.67	34.72	43.19	54	10.81	Average
	6958	37.15	35.5	9.18	34.8	47.03	74	26.97	Peak
	8434	37.22	38.51	10.46	34.75	51.44	74	22.56	Peak
Vertical	1594	47.97	25.6	4.43	36.3	41.7	74	32.3	Peak
	3781	43.01	31.99	6.58	35.06	46.52	74	27.48	Peak
	4924	54.29	33.72	7.67	34.72	60.96	74	13.04	Peak
	4924	41.74	33.72	7.67	34.72	48.41	54	5.59	Average
	6904	40.09	35.36	9.18	34.79	49.84	74	24.16	Peak
	8614	36.78	38.5	10.52	34.74	51.06	74	22.94	Peak

802.11n20 CH2462MHz

Polarization	Frequency (MHz)	Meter Reading dB (μV)	Antenna Factor (dB/m)	Cable Loss (dB)	Preamplifier Factor (dB)	Emission Level dB (μV/m)	Limits dB (μV/m)	Margin (dB)	Remark
Horizontal	1702	43.98	26.04	4.56	36.3	38.28	74	35.72	Peak
	3502	40.64	31.33	6.36	35.14	43.19	74	30.81	Peak
	4924	44.02	33.72	7.67	34.72	50.69	74	23.31	Peak
	4924	33.78	33.72	7.67	34.72	40.45	54	13.55	Average
	6868	36.41	35.31	9.18	34.79	46.11	74	27.89	Peak
	8506	36.4	38.58	10.46	34.75	50.69	74	23.31	Peak
Vertical	2179	44.9	27.63	5.12	36.09	41.56	74	32.44	Peak
	3862	40.74	32.17	6.66	35.04	44.53	74	29.47	Peak
	4933	52.03	33.72	7.67	34.72	58.7	74	15.3	Peak
	4933	40.35	33.72	7.67	34.72	47.02	54	6.98	Average
	6706	37.94	34.88	9.01	34.77	47.06	74	26.94	Peak
	8407	35.82	38.47	10.46	34.76	49.99	74	24.01	Peak

802.11n40 CH2452MHz

Polarization	Frequency (MHz)	Meter Reading dB (μV)	Antenna Factor (dB/m)	Cable Loss (dB)	Preamplifier Factor (dB)	Emission Level dB (μV/m)	Limits dB (μV/m)	Margin (dB)	Remark
Horizontal	1810	44.42	26.44	4.72	36.3	39.28	74	34.72	Peak
	3439	41.54	31.16	6.31	35.16	43.85	74	30.15	Peak
	4897	43.41	33.6	7.61	34.73	49.89	74	24.11	Peak
	4897	32.14	33.6	7.61	34.73	38.62	54	15.38	Average
	6409	39.39	34.38	8.76	34.74	47.79	74	26.21	Peak
	8344	35.99	38.34	10.4	34.77	49.96	74	24.04	Peak
Vertical	1756	46.07	26.25	4.65	36.3	40.67	74	33.33	Peak
	3223	42.73	30.67	6.09	35.22	44.27	74	29.73	Peak
	4897	47.48	33.6	7.61	34.73	53.96	74	20.04	Peak
	4897	36.73	33.6	7.61	34.73	43.21	54	10.79	Average
	6445	39.61	34.39	8.76	34.75	48.01	74	25.99	Peak
	8299	36.37	38.26	10.4	34.77	50.26	74	23.74	Peak

TEST ENGINEER: Jarey

Band-Edge:

EUT : Direct Connect Full Color A19 Temperature : 22°C

Model No. : CLEDA199CD1 Humidity : 51%RH

Test Mode : Transmitting Date of Test : 2022.12.22-2023.01.08

802.11b CH2412MHz

Polarization	Frequency (MHz)	Meter Reading dB (μV)	Antenna Factor (dB/m)	Cable Loss (dB)	Preamp Factor (dB)	Emission Level dB (μV/m)	Limits dB (μV/m)	Margin (dB)	Remark
Horizontal	2390	56.36	28.21	5.36	35.86	54.07	74	19.93	Peak
	2390	46.51	28.21	5.36	35.86	44.22	54	9.78	Average
Vertical	2390	60.33	28.21	5.36	35.86	58.04	74	15.96	Peak
	2390	48.47	28.21	5.36	35.86	46.18	54	7.82	Average

802.11b CH2462MHz

Polarization	Frequency (MHz)	Meter Reading dB (μV)	Antenna Factor (dB/m)	Cable Loss (dB)	Preamp Factor (dB)	Emission Level dB (μV/m)	Limits dB (μV/m)	Margin (dB)	Remark
Horizontal	2483.5	53.62	28.46	5.43	35.76	51.75	74	22.25	Peak
	2483.5	44.23	28.46	5.43	35.76	42.36	54	11.64	Average
Vertical	2483.5	53.73	28.46	5.43	35.76	51.86	74	22.14	Peak
	2483.5	43.45	28.46	5.43	35.76	41.58	54	12.42	Average

802.11g CH2412MHz

Polarization	Frequency (MHz)	Meter Reading dB (μV)	Antenna Factor (dB/m)	Cable Loss (dB)	Preamp Factor (dB)	Emission Level dB (μV/m)	Limits dB (μV/m)	Margin (dB)	Remark
Horizontal	2390	66.43	28.21	5.36	35.86	64.14	74	9.86	Peak
	2390	49.55	28.21	5.36	35.86	47.26	54	6.74	Average
Vertical	2390	66.52	28.21	5.36	35.86	64.23	74	9.77	Peak
	2390	51.65	28.21	5.36	35.86	49.36	54	4.64	Average

802.11g CH2462MHz

Polarization	Frequency (MHz)	Meter Reading dB (μ V)	Antenna Factor (dB/m)	Cable Loss (dB)	Preamp Factor (dB)	Emission Level dB (μ V/m)	Limits dB (μ V/m)	Margin (dB)	Remark
Horizontal	2483.5	66.3	28.46	5.43	35.76	64.43	74	9.57	Peak
	2483.5	48.3	28.46	5.43	35.76	46.43	54	7.57	Average
Vertical	2483.5	67.69	28.46	5.43	35.76	65.82	74	8.18	Peak
	2483.5	47.75	28.46	5.43	35.76	45.88	54	8.12	Average

802.11n20 CH2412MHz

Polarization	Frequency (MHz)	Meter Reading dB (μ V)	Antenna Factor (dB/m)	Cable Loss (dB)	Preamp Factor (dB)	Emission Level dB (μ V/m)	Limits dB (μ V/m)	Margin (dB)	Remark
Horizontal	2390	61.32	28.21	5.36	35.86	59.03	74	14.97	Peak
	2390	46.17	28.21	5.36	35.86	43.88	54	10.12	Average
Vertical	2390	61	28.21	5.36	35.86	58.71	74	15.29	Peak
	2390	46.98	28.21	5.36	35.86	44.69	54	9.31	Average

802.11n20 CH2462MHz

Polarization	Frequency (MHz)	Meter Reading dB (μ V)	Antenna Factor (dB/m)	Cable Loss (dB)	Preamp Factor (dB)	Emission Level dB (μ V/m)	Limits dB (μ V/m)	Margin (dB)	Remark
Horizontal	2483.5	63.3	28.46	5.43	35.76	61.43	74	12.57	Peak
	2483.5	45.92	28.46	5.43	35.76	44.05	54	9.95	Average
Vertical	2483.5	60.1	28.46	5.43	35.76	58.23	74	15.77	Peak
	2483.5	45.15	28.46	5.43	35.76	43.28	54	10.72	Average

802.11n40 CH2422MHz

Polarization	Frequency (MHz)	Meter Reading dB (μV)	Antenna Factor (dB/m)	Cable Loss (dB)	Preamp Factor (dB)	Emission Level dB (μV/m)	Limits dB (μV/m)	Margin (dB)	Remark
Horizontal	2390	64.43	28.21	5.36	35.86	62.14	74	11.86	Peak
	2390	51.02	28.21	5.36	35.86	48.73	54	5.27	Average
Vertical	2390	65.47	28.21	5.36	35.86	63.18	74	10.82	Peak
	2390	50.66	28.21	5.36	35.86	48.37	54	5.63	Average

802.11n40 CH2452MHz

Polarization	Frequency (MHz)	Meter Reading dB (μV)	Antenna Factor (dB/m)	Cable Loss (dB)	Preamp Factor (dB)	Emission Level dB (μV/m)	Limits dB (μV/m)	Margin (dB)	Remark
Horizontal	2483.5	60.13	28.46	5.43	35.76	58.26	74	15.74	Peak
	2483.5	50.07	28.46	5.43	35.76	48.2	54	5.8	Average
Vertical	2483.5	59.45	28.46	5.43	35.76	57.58	74	16.42	Peak
	2483.5	46.26	28.46	5.43	35.76	44.39	54	9.61	Average

Emissions in restricted frequency bands:

EUT : Direct Connect Full Color A19 Temperature : 22°C

Model No. : CLEDA199CD1 Humidity : 51%RH

Test Mode : Transmitting Date of Test : 2022.12.22-2023.01.08

802.11b CH2412MHz

Polarization	Frequency (MHz)	Meter Reading dB (µV)	Antenna Factor (dB/m)	Cable Loss (dB)	Preamp Factor (dB)	Emission Level dB (µV/m)	Limits dB (µV/m)	Margin (dB)	Remark
Horizontal	2327.2	53.87	28.05	5.29	35.93	51.28	74	22.72	Peak
	2327.2	42.33	28.05	5.29	35.93	39.74	54	14.26	Average
	2348.6	54.68	28.1	5.32	35.9	52.2	74	21.8	Peak
	2348.6	42.47	28.1	5.32	35.9	39.99	54	14.01	Average
	2385.4	57.51	28.21	5.36	35.87	55.21	74	18.79	Peak
	2385.4	44.35	28.21	5.36	35.87	42.05	54	11.95	Average
Vertical	2328.1	55.53	28.05	5.29	35.93	52.94	74	21.06	Peak
	2328.1	42.35	28.05	5.29	35.93	39.76	54	14.24	Average
	2351.2	55.09	28.12	5.32	35.9	52.63	74	21.37	Peak
	2351.2	43.51	28.12	5.32	35.9	41.05	54	12.95	Average
	2385.9	60.64	28.21	5.36	35.87	58.34	74	15.66	Peak
	2385.9	46.26	28.21	5.36	35.87	43.96	54	10.04	Average

802.11b CH2462MHz

Polarization	Frequency (MHz)	Meter Reading dB (µV)	Antenna Factor (dB/m)	Cable Loss (dB)	Preamp Factor (dB)	Emission Level dB (µV/m)	Limits dB (µV/m)	Margin (dB)	Remark
Horizontal	2484.2	54.32	28.46	5.43	35.76	52.45	74	21.55	Peak
	2484.2	44.13	28.46	5.43	35.76	42.26	54	11.74	Average
	2490.7	54.47	28.48	5.47	35.76	52.66	74	21.34	Peak
	2490.7	43.54	28.48	5.47	35.76	41.73	54	12.27	Average
	2495.8	54.43	28.48	5.47	35.76	52.62	74	21.38	Peak
	2495.8	42.14	28.48	5.47	35.76	40.33	54	13.67	Average
Vertical	2485.2	55.15	28.46	5.47	35.76	53.32	74	20.68	Peak
	2485.2	43.31	28.46	5.47	35.76	41.48	54	12.52	Average
	2491.9	54.28	28.48	5.47	35.76	52.47	74	21.53	Peak
	2491.9	42.43	28.48	5.47	35.76	40.62	54	13.38	Average
	2497.3	54.31	28.5	5.47	35.76	52.52	74	21.48	Peak
	2497.3	42.13	28.5	5.47	35.76	40.34	54	13.66	Average

802.11g CH2412MHz

Polarization	Frequency (MHz)	Meter Reading dB (μ V)	Antenna Factor (dB/m)	Cable Loss (dB)	Preamp Factor (dB)	Emission Level dB (μ V/m)	Limits dB (μ V/m)	Margin (dB)	Remark
Horizontal	2336.2	54.81	28.08	5.29	35.92	52.26	74	21.74	Peak
	2336.2	43.28	28.08	5.29	35.92	40.73	54	13.27	Average
	2368.2	54.77	28.15	5.32	35.89	52.35	74	21.65	Peak
	2368.2	44.49	28.15	5.32	35.89	42.07	54	11.93	Average
	2389.7	67.33	28.21	5.36	35.86	65.04	74	8.96	Peak
	2389.7	48.31	28.21	5.36	35.86	46.02	54	7.98	Average
Vertical	2338.4	55.28	28.08	5.29	35.92	52.73	74	21.27	Peak
	2338.4	44.33	28.08	5.29	35.92	41.78	54	12.22	Average
	2364.9	54.33	28.15	5.32	35.89	51.91	74	22.09	Peak
	2364.9	43.55	28.15	5.32	35.89	41.13	54	12.87	Average
	2389.5	67.03	28.21	5.36	35.86	64.74	74	9.26	Peak
	2389.5	50.2	28.21	5.36	35.86	47.91	54	6.09	Average

802.11g CH2462MHz

Polarization	Frequency (MHz)	Meter Reading dB (μ V)	Antenna Factor (dB/m)	Cable Loss (dB)	Preamp Factor (dB)	Emission Level dB (μ V/m)	Limits dB (μ V/m)	Margin (dB)	Remark
Horizontal	2483.8	68.26	28.46	5.43	35.76	66.39	74	7.61	Peak
	2483.8	47.26	28.46	5.43	35.76	45.39	54	8.61	Average
	2490.3	58.59	28.48	5.47	35.76	56.78	74	17.22	Peak
	2490.3	43.25	28.48	5.47	35.76	41.44	54	12.56	Average
	2497.7	55.12	28.5	5.47	35.76	53.33	74	20.67	Peak
	2497.7	43.21	28.5	5.47	35.76	41.42	54	12.58	Average
Vertical	2483.7	68.16	28.46	5.43	35.76	66.29	74	7.71	Peak
	2483.7	47.42	28.46	5.43	35.76	45.55	54	8.45	Average
	2491.3	58.65	28.48	5.47	35.76	56.84	74	17.16	Peak
	2491.3	44.37	28.48	5.47	35.76	42.56	54	11.44	Average
	2498.4	55.2	28.5	5.47	35.76	53.41	74	20.59	Peak
	2498.4	43.12	28.5	5.47	35.76	41.33	54	12.67	Average

802.11n20 CH2412MHz

Polarization	Frequency (MHz)	Meter Reading dB (μ V)	Antenna Factor (dB/m)	Cable Loss (dB)	Preamp Factor (dB)	Emission Level dB (μ V/m)	Limits dB (μ V/m)	Margin (dB)	Remark
Horizontal	2335.4	55.26	28.06	5.29	35.92	52.69	74	21.31	Peak
	2335.4	43.24	28.06	5.29	35.92	40.67	54	13.33	Average
	2365.3	54.61	28.15	5.32	35.89	52.19	74	21.81	Peak
	2365.3	42.27	28.15	5.32	35.89	39.85	54	14.15	Average
	2389.4	61.02	28.21	5.36	35.86	58.73	74	15.27	Peak
	2389.4	45.2	28.21	5.36	35.86	42.91	54	11.09	Average
Vertical	2331.2	54.9	28.06	5.29	35.93	52.32	74	21.68	Peak
	2331.2	42.58	28.06	5.29	35.93	40	54	14	Average
	2357.1	55.19	28.14	5.32	35.89	52.76	74	21.24	Peak
	2357.1	42.32	28.14	5.32	35.89	39.89	54	14.11	Average
	2388.8	59.8	28.21	5.36	35.86	57.51	74	16.49	Peak
	2388.8	45.48	28.21	5.36	35.86	43.19	54	10.81	Average

802.11n20 CH2462MHz

Polarization	Frequency (MHz)	Meter Reading dB (μ V)	Antenna Factor (dB/m)	Cable Loss (dB)	Preamp Factor (dB)	Emission Level dB (μ V/m)	Limits dB (μ V/m)	Margin (dB)	Remark
Horizontal	2484.1	61.52	28.46	5.43	35.76	59.65	74	14.35	Peak
	2484.1	45.25	28.46	5.43	35.76	43.38	54	10.62	Average
	2492.5	54.73	28.48	5.47	35.76	52.92	74	21.08	Peak
	2492.5	42.72	28.48	5.47	35.76	40.91	54	13.09	Average
	2497.6	54.32	28.5	5.47	35.76	52.53	74	21.47	Peak
	2497.6	42.43	28.5	5.47	35.76	40.64	54	13.36	Average
Vertical	2483.8	61.67	28.46	5.43	35.76	59.8	74	14.2	Peak
	2483.8	45.37	28.46	5.43	35.76	43.5	54	10.5	Average
	2489.5	55.93	28.48	5.47	35.76	54.12	74	19.88	Peak
	2489.5	43.69	28.48	5.47	35.76	41.88	54	12.12	Average
	2496.1	55.43	28.48	5.47	35.76	53.62	74	20.38	Peak
	2496.1	42.77	28.48	5.47	35.76	40.96	54	13.04	Average

802.11n40 CH2422MHz

Polarization	Frequency (MHz)	Meter Reading dB (μ V)	Antenna Factor (dB/m)	Cable Loss (dB)	Preamp Factor (dB)	Emission Level dB (μ V/m)	Limits dB (μ V/m)	Margin (dB)	Remark
Horizontal	2333.8	54.7	28.06	5.29	35.92	52.13	74	21.87	Peak
	2333.8	42.38	28.06	5.29	35.92	39.81	54	14.19	Average
	2355	54.65	28.12	5.32	35.9	52.19	74	21.81	Peak
	2355	43.57	28.12	5.32	35.9	41.11	54	12.89	Average
	2388.7	63.93	28.21	5.36	35.86	61.64	74	12.36	Peak
	2388.7	50.49	28.21	5.36	35.86	48.2	54	5.8	Average
Vertical	2329	54.72	28.06	5.29	35.93	52.14	74	21.86	Peak
	2329	42.58	28.06	5.29	35.93	40	54	14	Average
	2362.8	55.06	28.14	5.32	35.89	52.63	74	21.37	Peak
	2362.8	43.4	28.14	5.32	35.89	40.97	54	13.03	Average
	2389.3	65.11	28.21	5.36	35.86	62.82	74	11.18	Peak
	2389.3	50.31	28.21	5.36	35.86	48.02	54	5.98	Average

802.11n40 CH2452MHz

Polarization	Frequency (MHz)	Meter Reading dB (μ V)	Antenna Factor (dB/m)	Cable Loss (dB)	Preamp Factor (dB)	Emission Level dB (μ V/m)	Limits dB (μ V/m)	Margin (dB)	Remark
Horizontal	2484.3	61.25	28.46	5.47	35.76	59.42	74	14.58	Peak
	2484.3	49.42	28.46	5.47	35.76	47.59	54	6.41	Average
	2492.1	57.2	28.48	5.47	35.76	55.39	74	18.61	Peak
	2492.1	45.22	28.48	5.47	35.76	43.41	54	10.59	Average
	2497.3	54.31	28.5	5.47	35.76	52.52	74	21.48	Peak
	2497.3	43.53	28.5	5.47	35.76	41.74	54	12.26	Average
Vertical	2483.8	61.06	28.46	5.43	35.76	59.19	74	14.81	Peak
	2483.8	46.31	28.46	5.43	35.76	44.44	54	9.56	Average
	2489.7	58.95	28.48	5.47	35.76	57.14	74	16.86	Peak
	2489.7	43.59	28.48	5.47	35.76	41.78	54	12.22	Average
	2495.5	55.25	28.48	5.47	35.76	53.44	74	20.56	Peak
	2495.5	42.63	28.48	5.47	35.76	40.82	54	13.18	Average

TEST ENGINEER: Jarey

5 99% OCCUPIED BANDWIDTH MEASUREMENT

5.1 Test Equipment

The following test equipment was used during the Emission Bandwidth measurement:

Item	Type	Manufacturer	Model No.	Serial No.	Cal. Date	Cal. Interval
1.	Spectrum Analyzer	Agilent	N9010A	MY52221182	2022.09.15	1 Year
2.	Coaxial Cable	WOKEN	SFL402-105F LEX	F02-150819-045	2022.03.07	1 Year
3.	20 dB Attenuator	Mini-Circuits	VAT-20+	001	2022.08.06	1 Year

5.2 Block Diagram of Test Setup

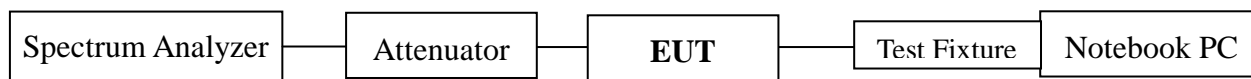

5.3 Operating Condition of EUT

The software as section 2.3 was used to enable the EUT to change the test mode one by one.

5.4 Test Procedure

The transmitter output was connected to the spectrum analyzer. The bandwidth of 99% power bandwidth was measure by spectrum analyzer with settings: Span = between 1.5 times and 5.0 times of the OBW, RBW = 1% to 5% of the OBW, VBW $\geq 3 \times$ RBW, Detector = Peak, Trace = Max Hold.

Use the 99% power bandwidth function of the instrument and report the measured bandwidth.

The test procedure is defined in ANSI C63.10-2013 (the 6.9.3 Measurement Procedure “Occupied bandwidth—power bandwidth (99%) measurement procedure” was used).

5.5 Test Results

PASSED.

All the test results are attached in next pages.

(Test Date: 2022.12.15 Temperature: 23°C Humidity: 51 %)

Modulation	Channel	Frequency (MHz)	99% Bandwidth (MHz)
802.11b	1	2412	13.196
	6	2437	13.215
	11	2462	13.202
802.11g	1	2412	16.519
	6	2437	16.593
	11	2462	16.577
802.11n20	1	2412	17.086
	6	2437	17.082
	11	2462	17.081
802.11n40	3	2422	33.019
	6	2437	32.979
	9	2452	33.049

802.11b CH2412MHz

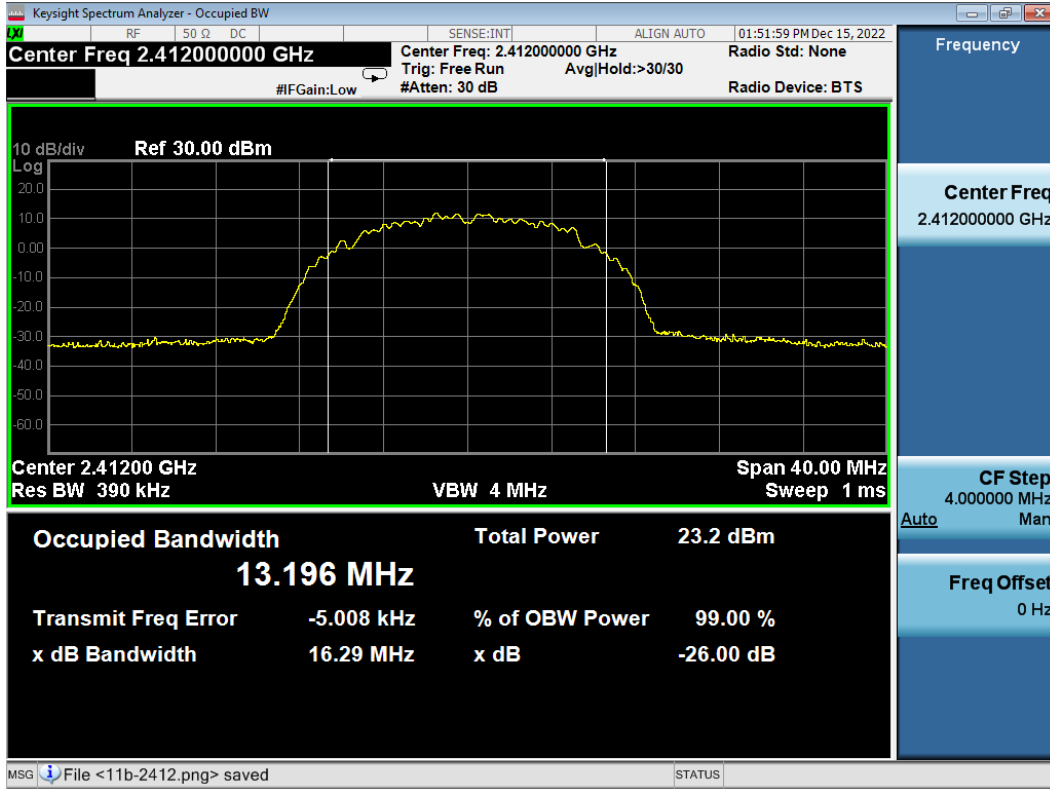

802.11b CH2437MHz

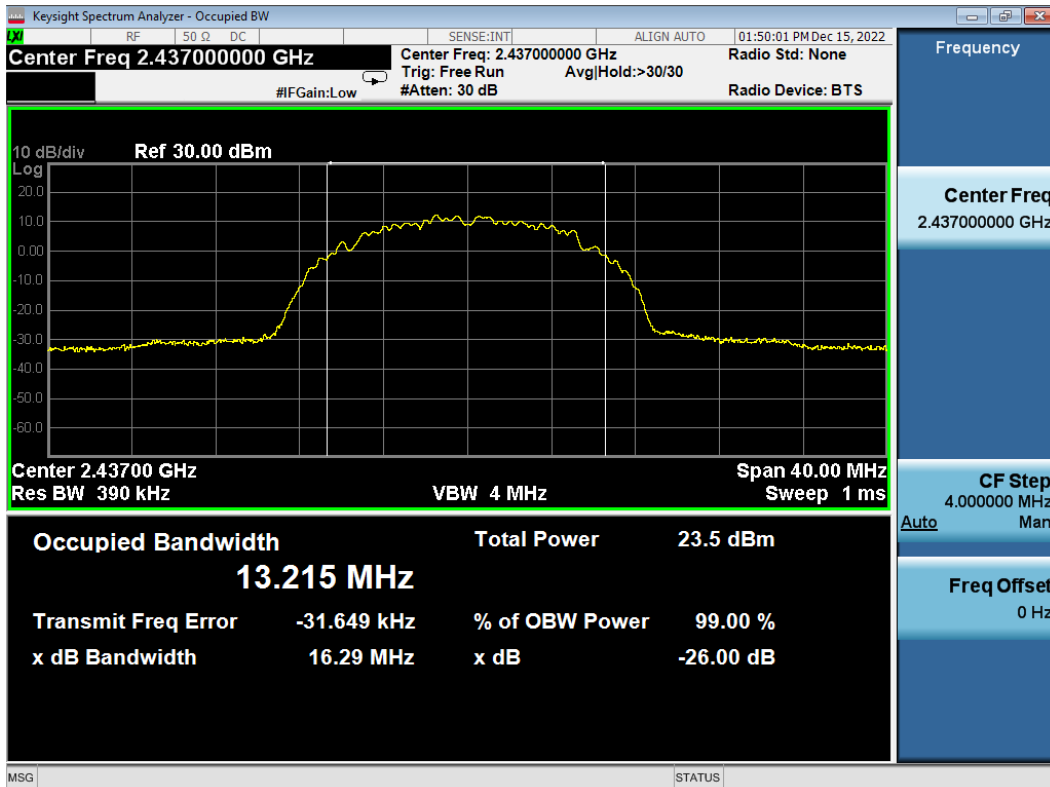

802.11b CH2462MHz

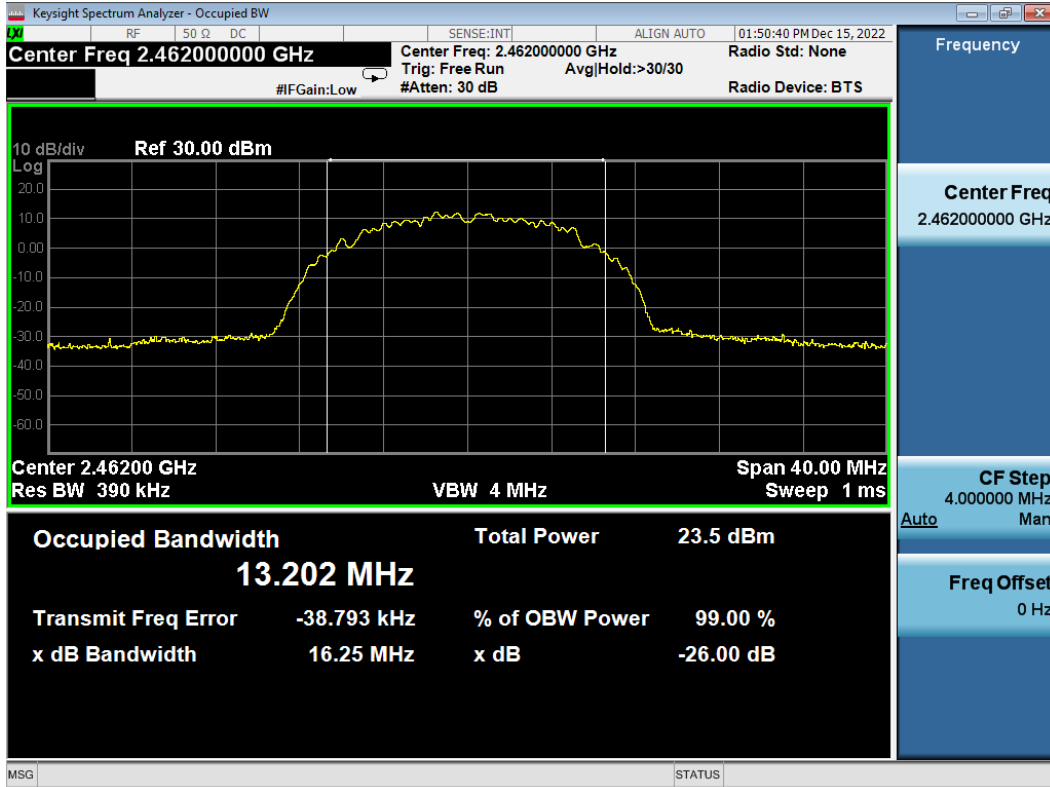

802.11g CH2412MHz

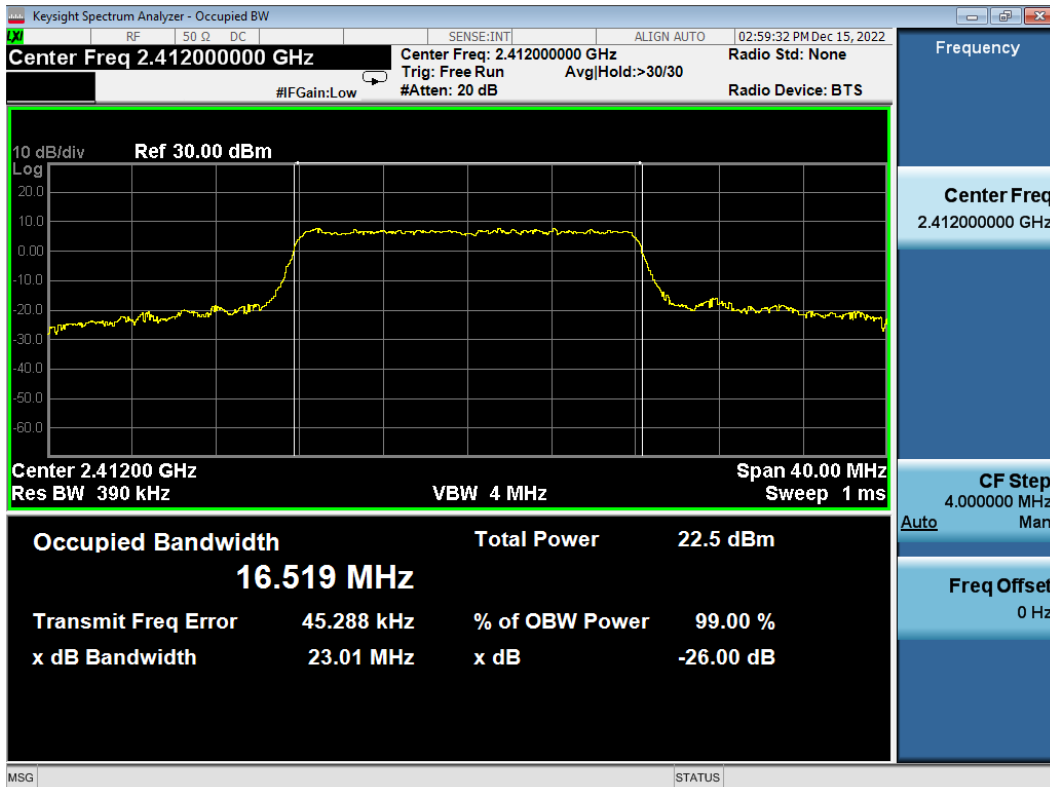

802.11g CH2437MHz

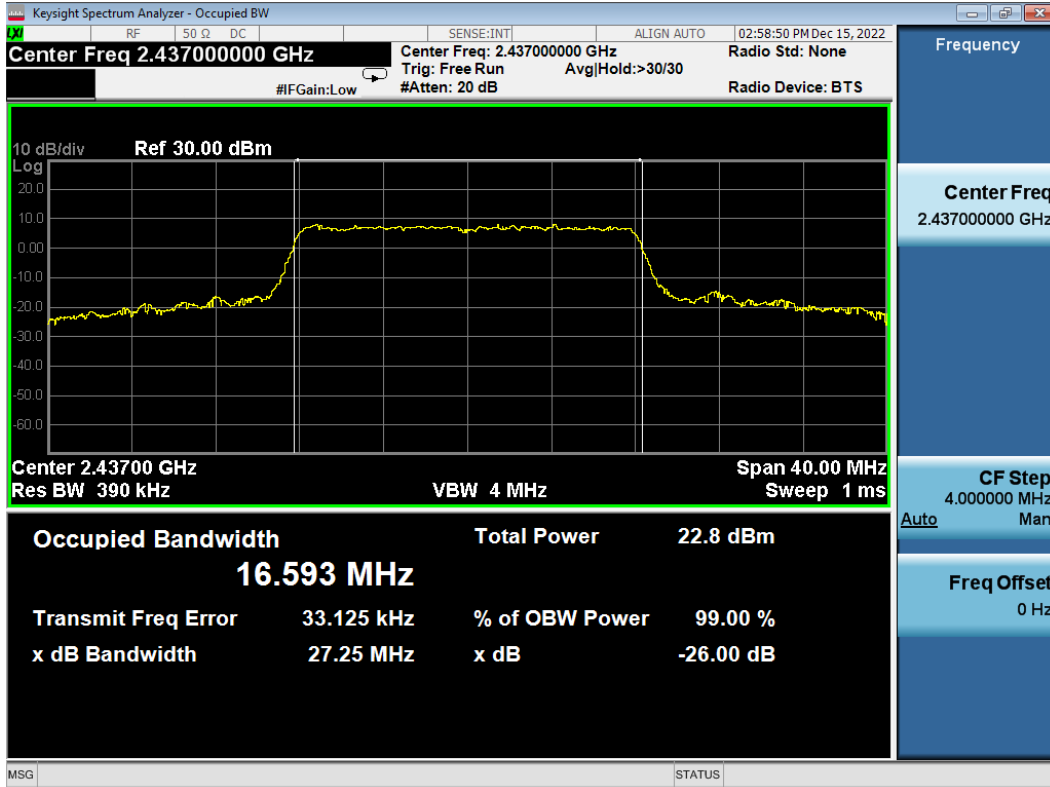

802.11g CH2462MHz

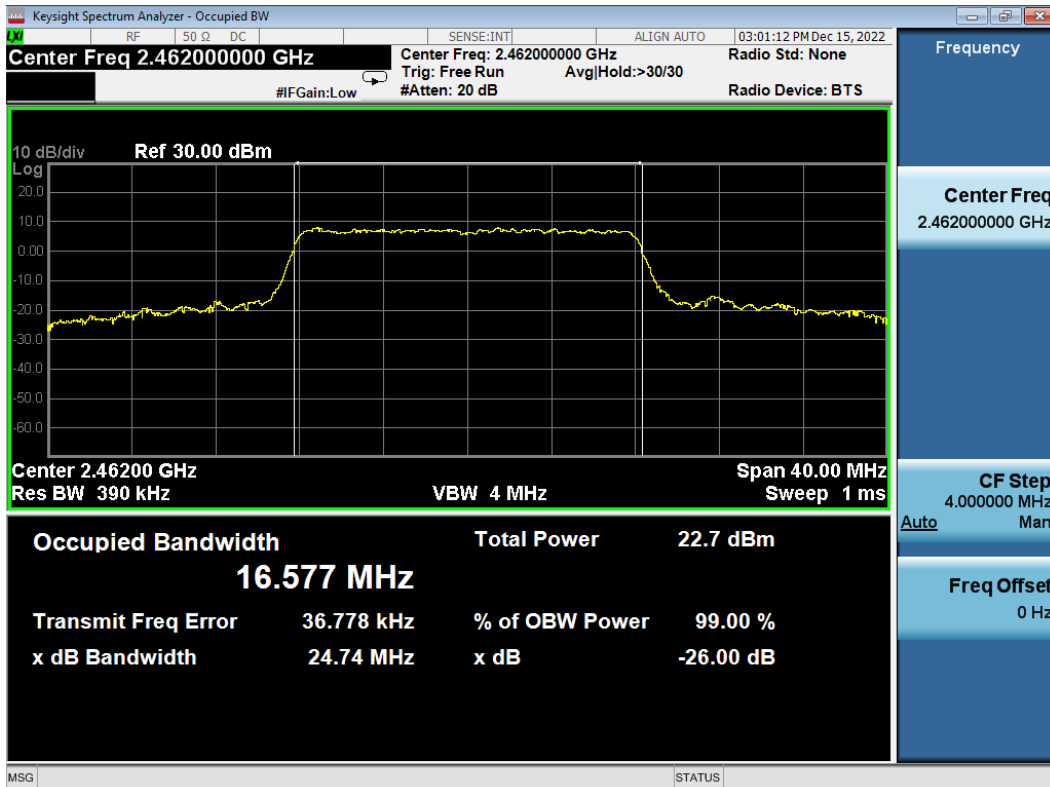

802.11n20 CH2412MHz

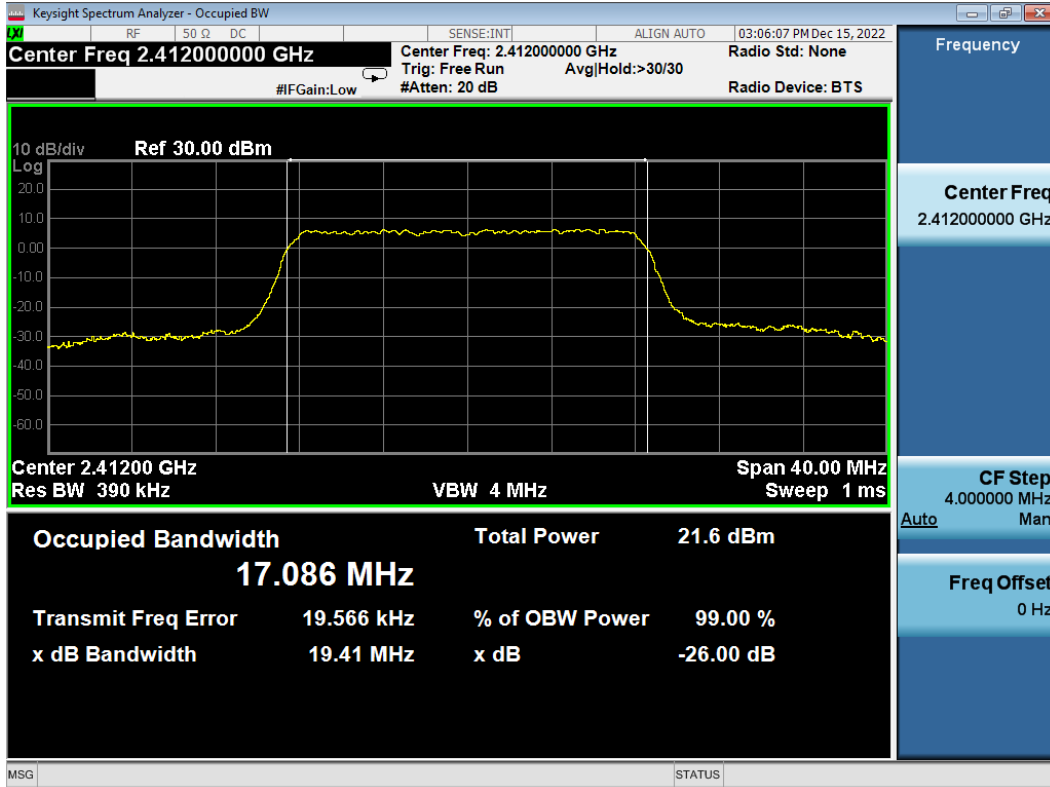

802.11n20 CH2437MHz

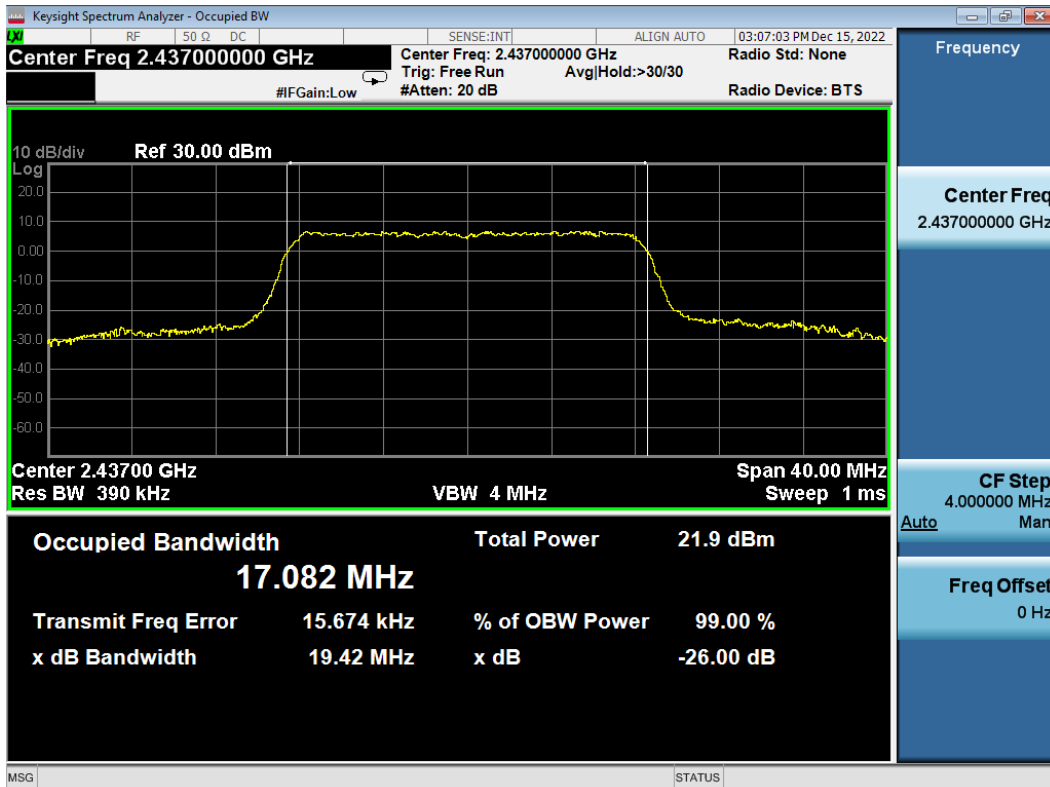

802.11n20 CH2462MHz

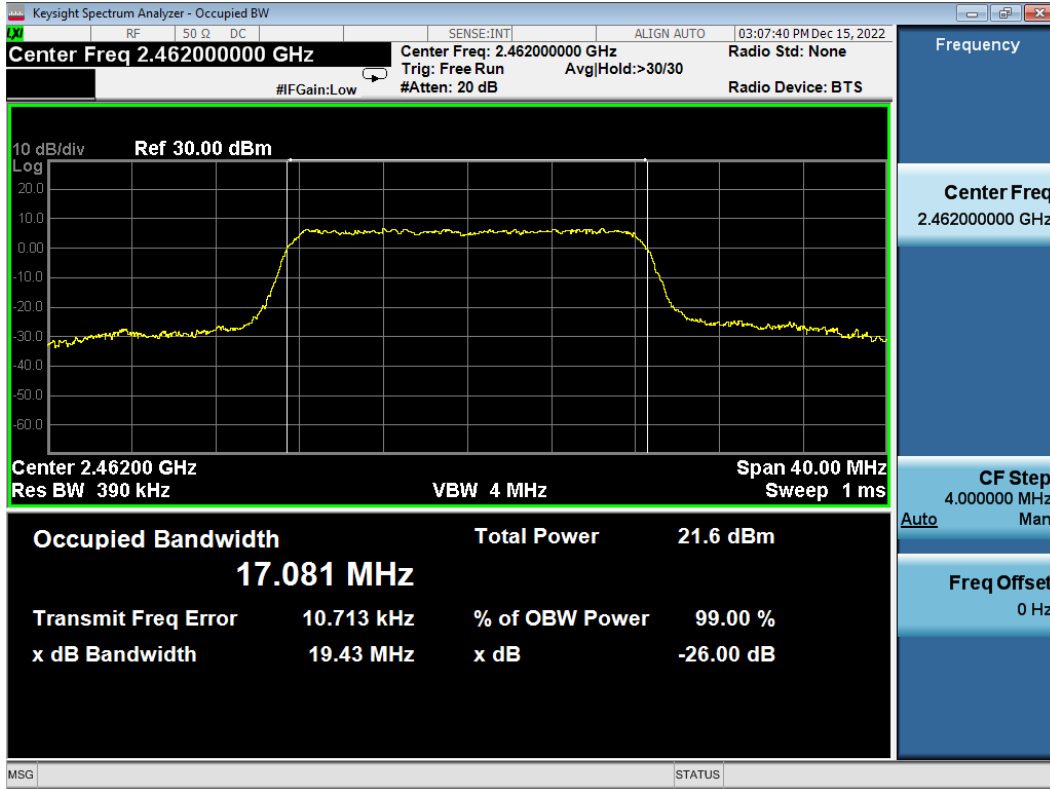

802.11n40 CH2422MHz

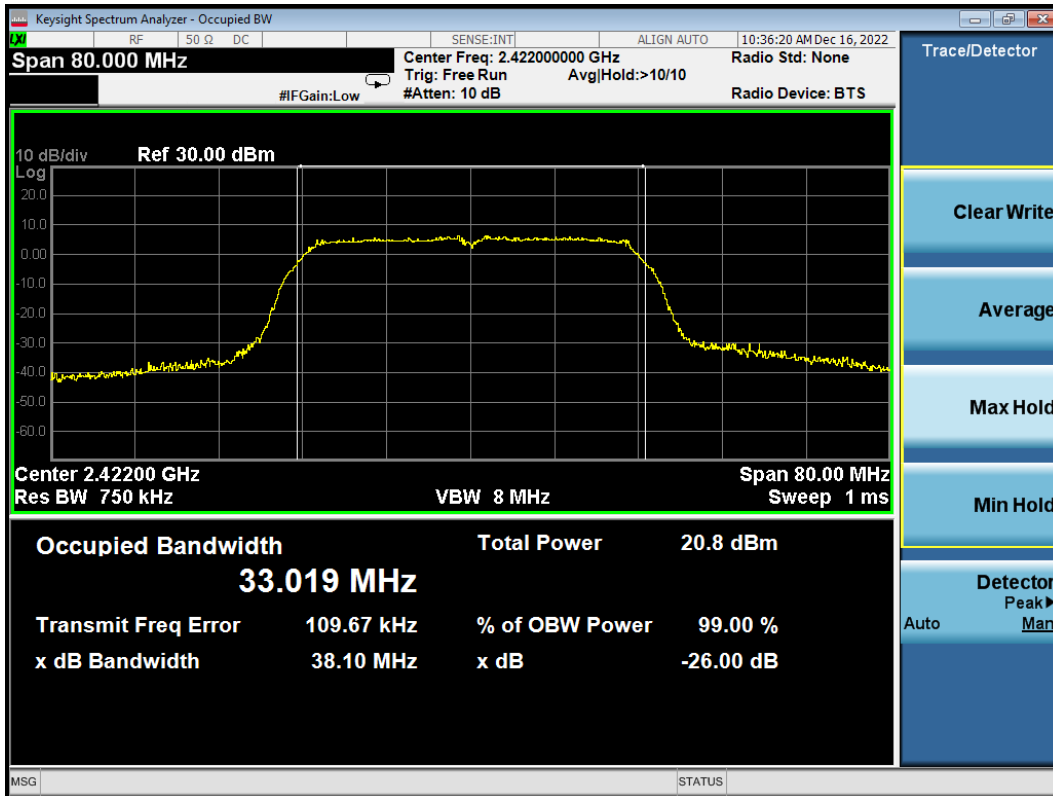

802.11n40 CH2437MHz

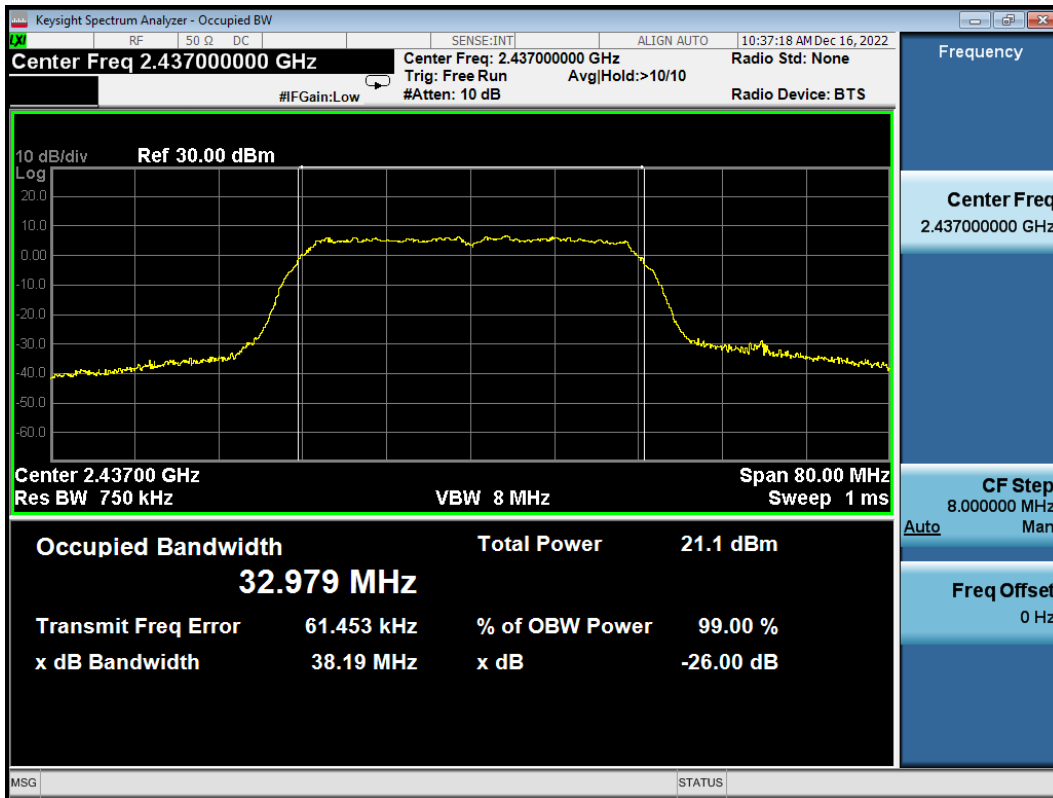

802.11n40 CH2452MHz

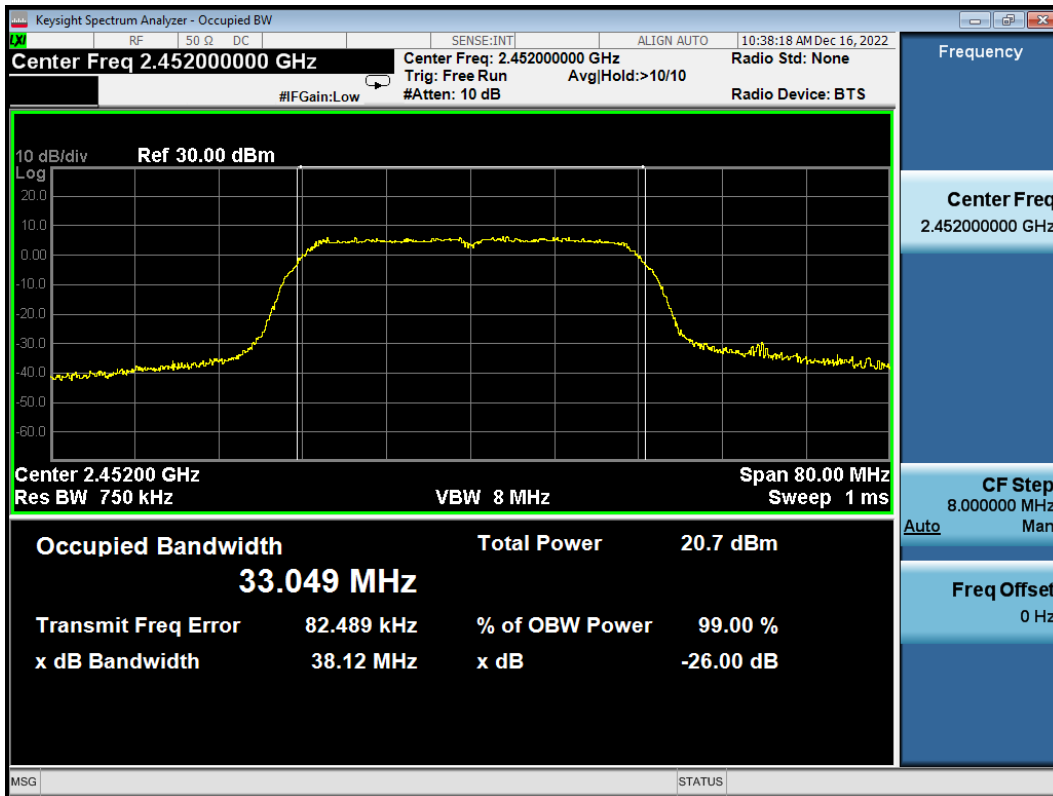

6 6 dB BANDWIDTH MEASUREMENT

6.1 Test Equipment

The following test equipment was used during the Emission Bandwidth measurement:

Item	Type	Manufacturer	Model No.	Serial No.	Cal. Date	Cal. Interval
4.	Spectrum Analyzer	Agilent	N9010A	MY52221182	2022.09.15	1 Year
5.	Coaxial Cable	WOKEN	SFL402-105F LEX	F02-150819-045	2022.03.07	1 Year
6.	20 dB Attenuator	Mini-Circuits	VAT-20+	001	2022.08.06	1 Year

6.2 Block Diagram of Test Setup

The Same as Section. 5.2.

6.3 Specification Limits (§15.247(a)(2))

The minimum 6 dB bandwidth shall be at least 500 kHz.

6.4 Operating Condition of EUT

The software as section 2.3 was used to enable the EUT to change the test mode one by one.

6.5 Test Procedure

The transmitter output was connected to the spectrum analyzer. The bandwidth of the fundamental frequency was measure by spectrum analyzer with settings: RBW = 100kHz, VBW $\geq 3 \times$ RBW.

The 6 dB bandwidth is defined as the total spectrum the power of which is lower than peak power minus 6 dB .

The test procedure is defined in ANSI C63.10-2013 (the 11.8.2 Measurement Procedure “Option 2” was used).

6.6 Test Results

PASSED.

All the test results are attached in next pages.

(Test Date: 2022.12.15 Temperature: 23°C Humidity: 51 %)

Modulation	Channel	Frequency (MHz)	6dB Bandwidth (MHz)	Limit
802.11b	1	2412	9.562	500 kHz
	6	2437	10.04	500 kHz
	11	2462	10.06	500 kHz
802.11g	1	2412	16.13	500 kHz
	6	2437	16.15	500 kHz
	11	2462	16.1	500 kHz
802.11n20	1	2412	16.14	500 kHz
	6	2437	16.28	500 kHz
	11	2462	16.16	500 kHz
802.11n40	3	2422	30.22	500 kHz
	6	2437	30.23	500 kHz
	9	2452	30.23	500 kHz

802.11b CH2412MHz

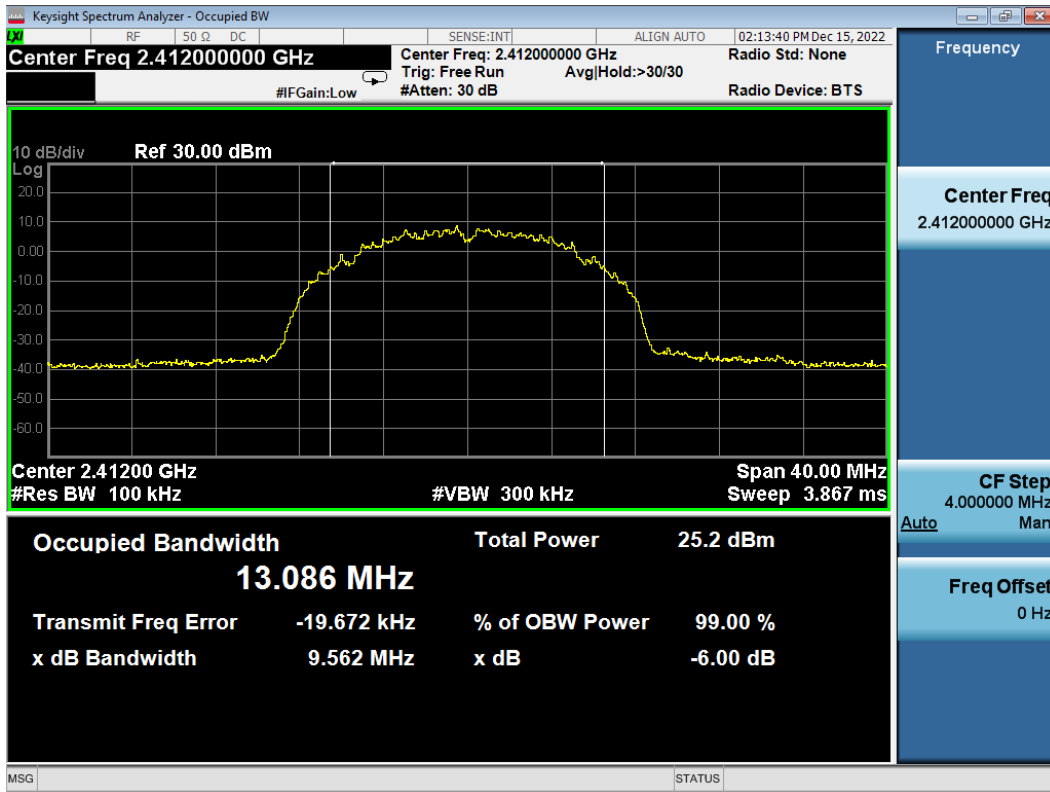

802.11b CH2437MHz

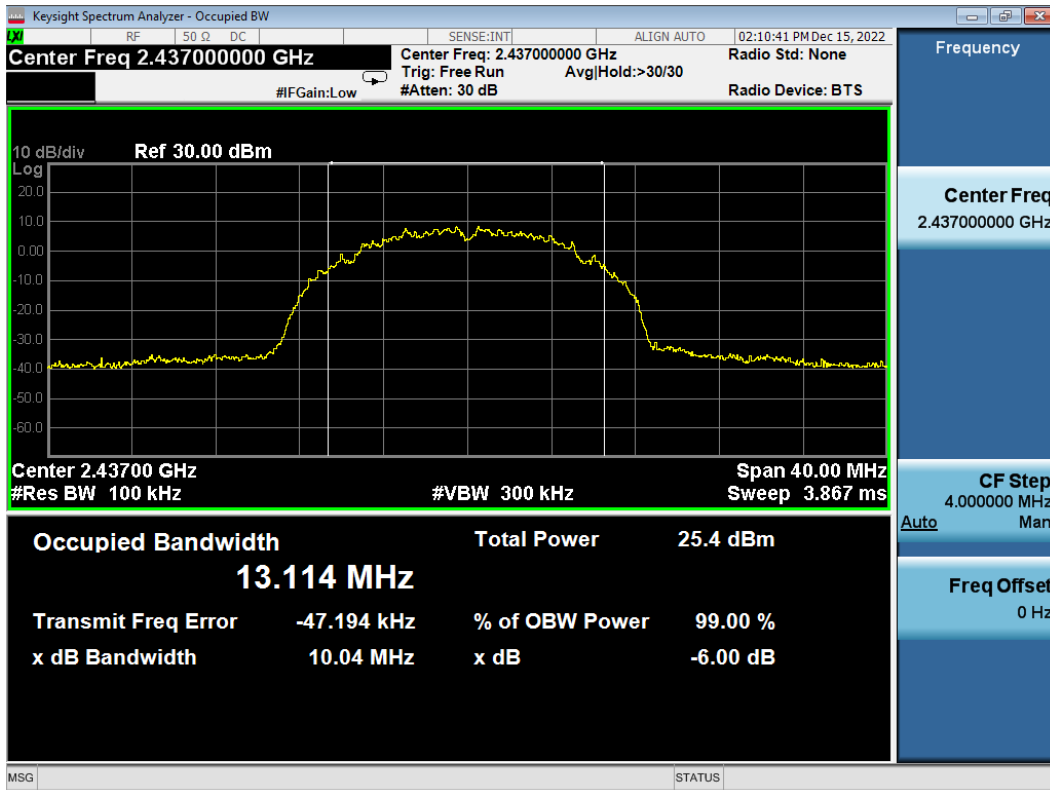

802.11b CH2462MHz

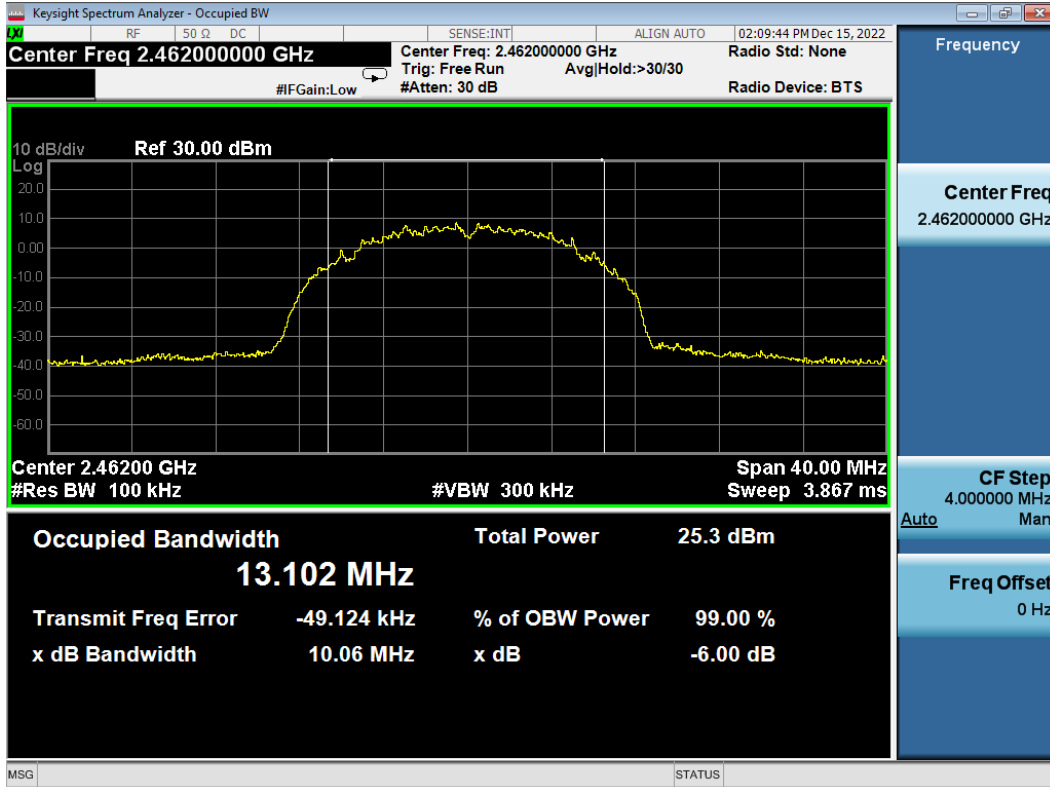

802.11g CH2412MHz

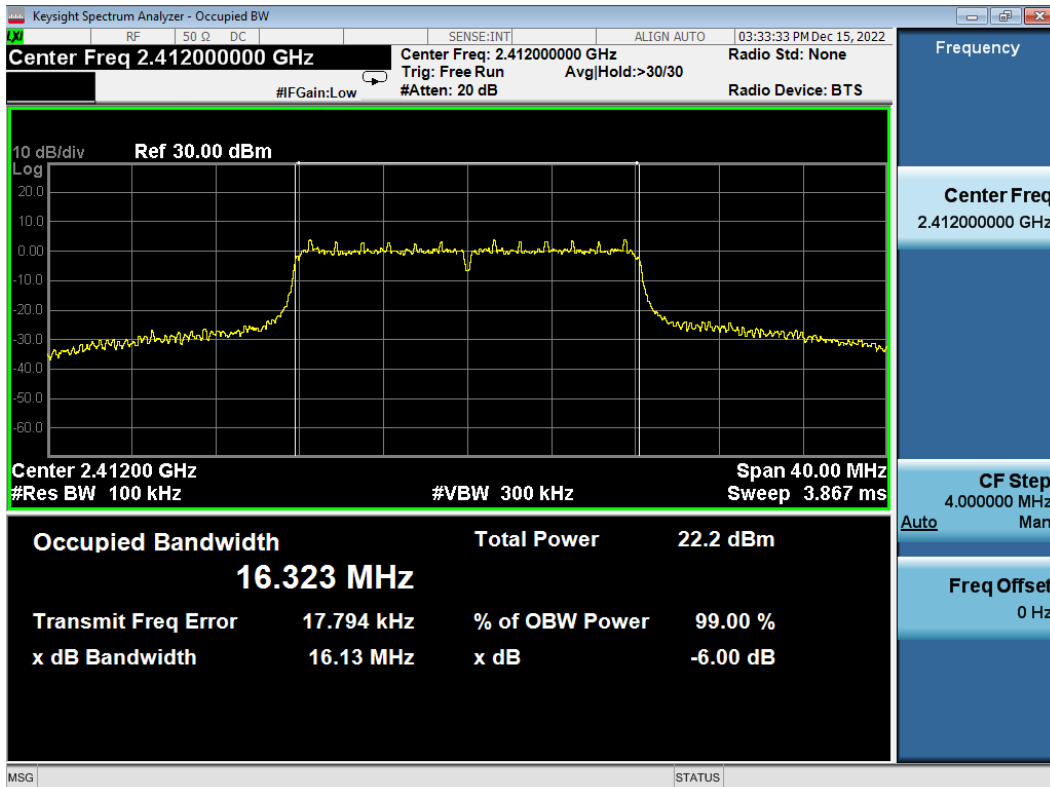

802.11g CH2437MHz

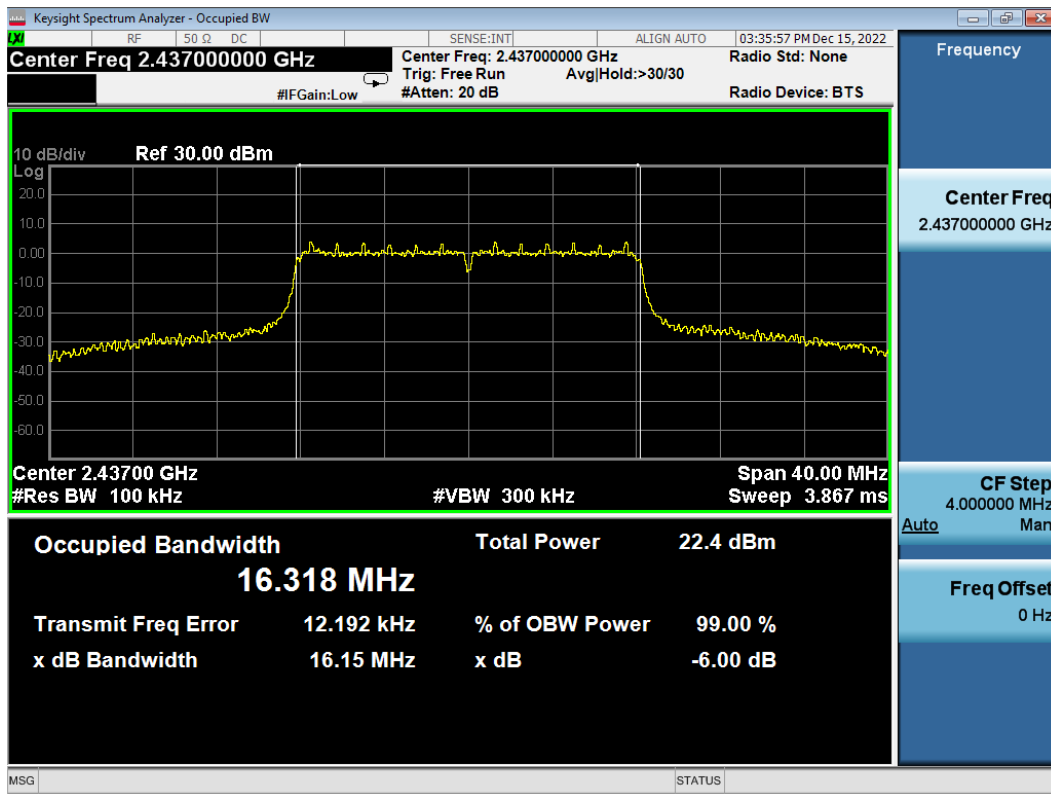

802.11g CH2462MHz

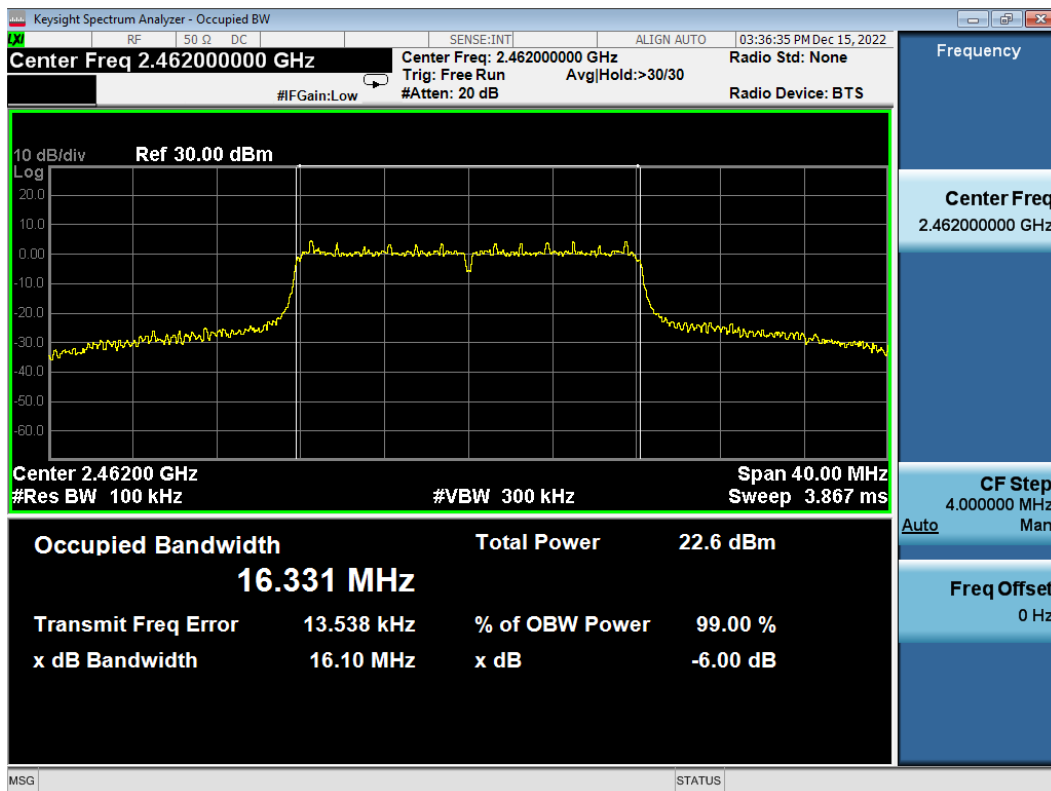

802.11n20 CH2412MHz

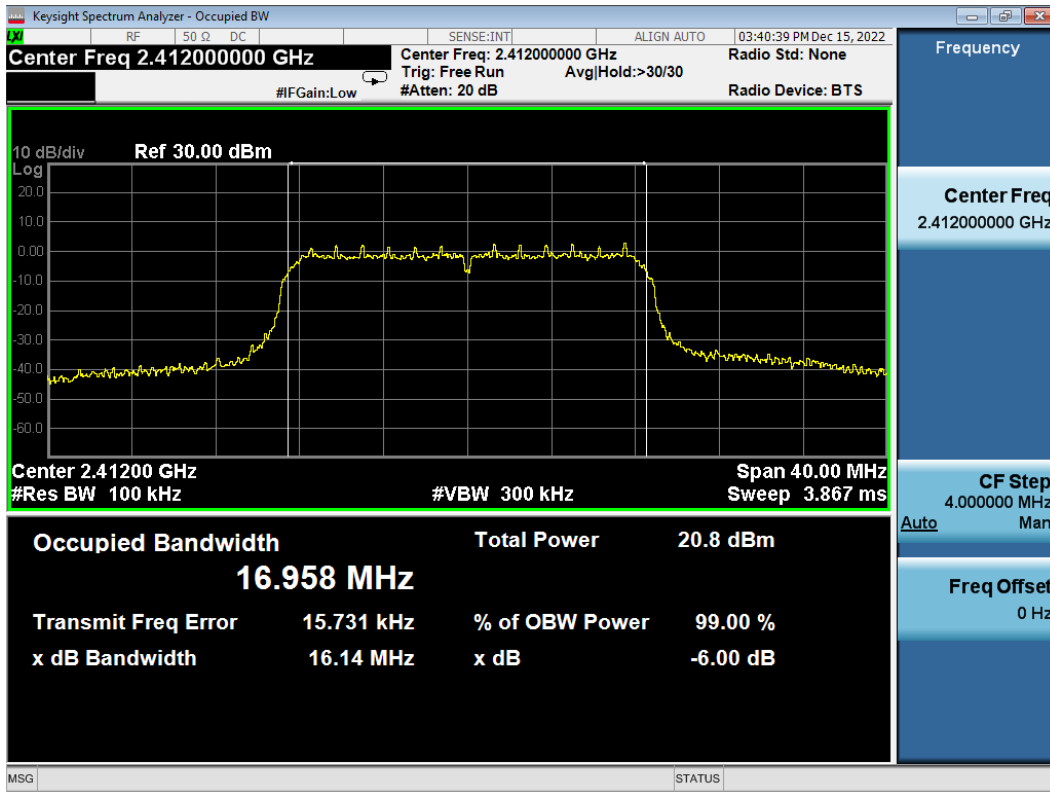

802.11n20 CH2437MHz

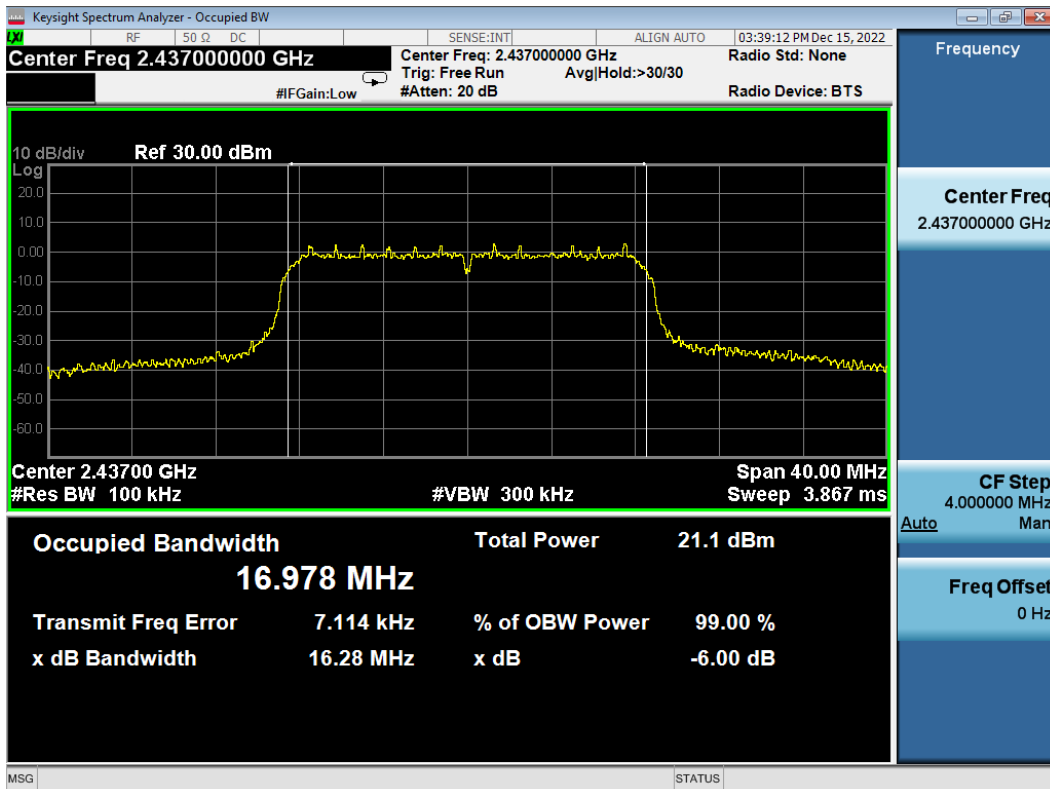

802.11n20 CH2462MHz

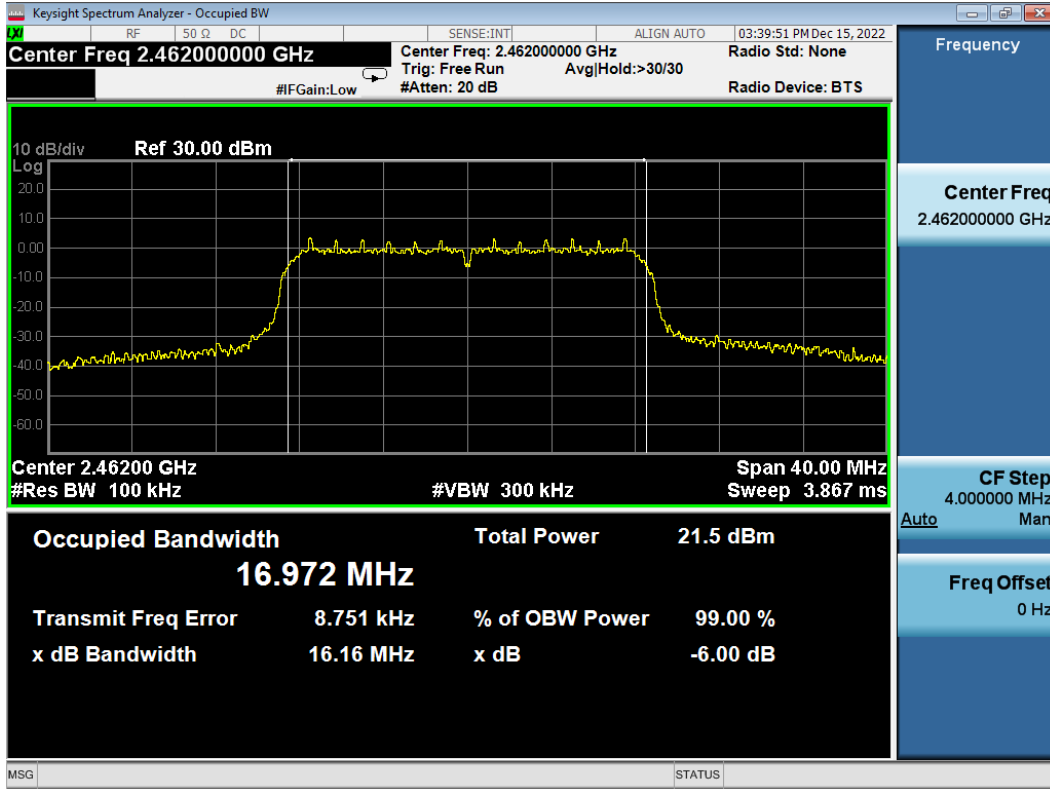

802.11n40 CH2422MHz

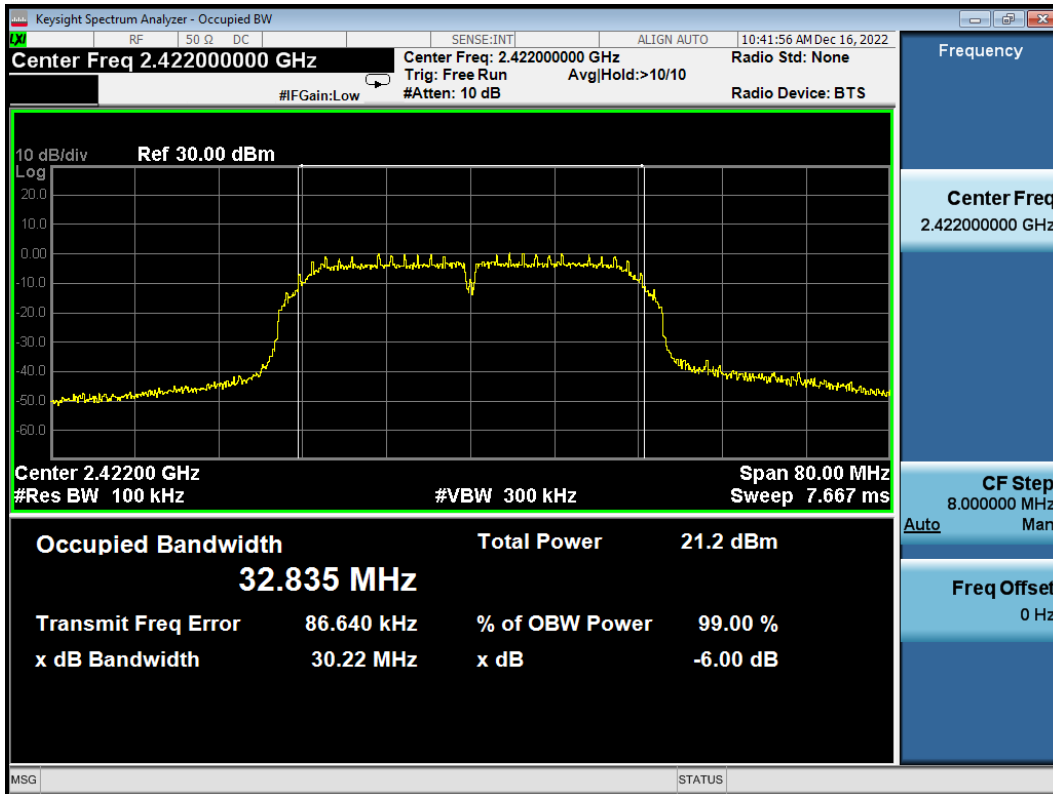

802.11n40 CH2437MHz

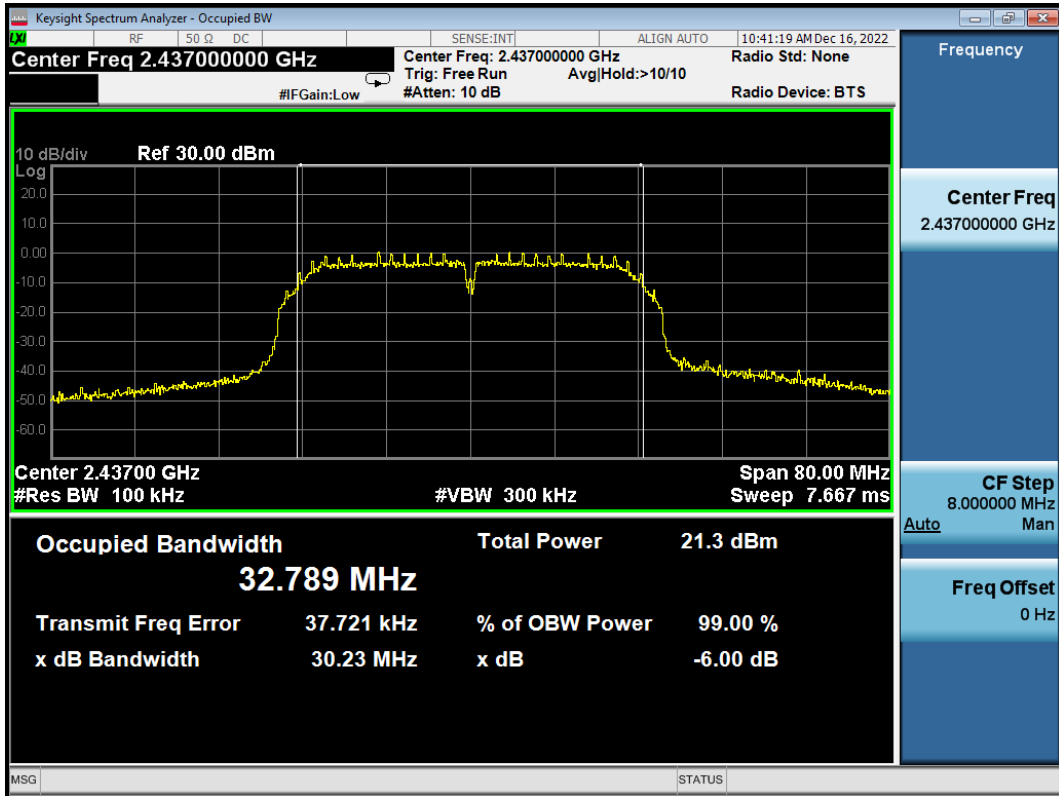

802.11n40 CH2452MHz

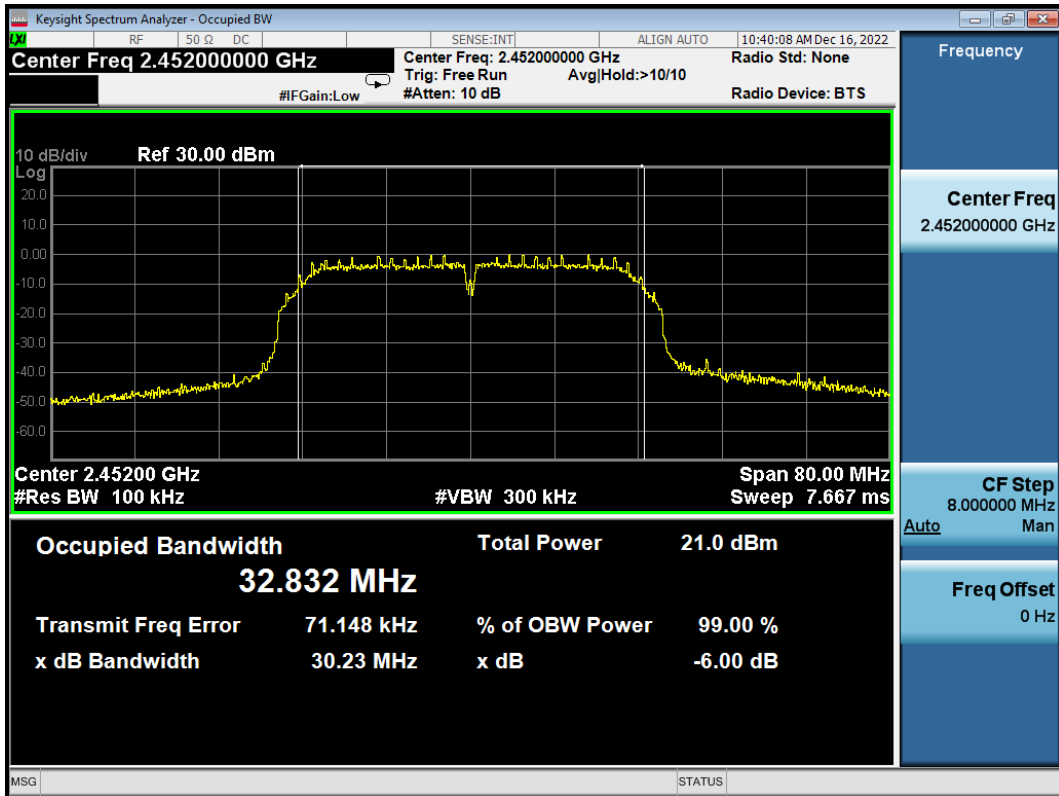

7 MAXIMUM PEAK OUTPUT POWER MEASUREMENT

7.1 Test Equipment

The following test equipment was used during the maximum peak output power measurement:

Item	Type	Manufacturer	Model No.	Serial No.	Cal. Date	Cal. Interval
1.	Spectrum Analyzer	Agilent	N9010A	MY52221182	2022.09.15	1 Year
2.	Coaxial Cable	WOKEN	SFL402-105F LEX	F02-150819-0 45	2022.03.07	1 Year
3.	20 dB Attenuator	Mini-Circuits	VAT-20+	001	2022.08.06	1 Year

7.2 Block Diagram of Test Setup

The Same as Section. 5.2.

7.3 Specification Limits ((§15.247(b)(3))

The Limits of maximum Peak Output Power for digital modulation in 2400-2483.5 MHz is: 1 Watt. (30 dBm)

7.4 Operating Condition of EUT

The software as section 2.3 was used to enable the EUT to change the test mode one by one.

7.5 Test Procedure

The transmitter output was connected to the spectrum analyzer.

Method AVGSA-1 uses trace averaging with the EUT transmitting at full power throughout each sweep.

The procedure for this method is as follows:

- a) Set span to at least 1.5 times the OBW.
- b) Set RBW = 1% to 5% of the OBW, not to exceed 1 MHz.
- c) Set VBW $\geq [3 \times \text{RBW}]$.
- d) Number of points in sweep $\geq [2 \times \text{span} / \text{RBW}]$. (This gives bin-to-bin spacing $\leq \text{RBW} / 2$, so that narrowband signals are not lost between frequency bins.)
- e) Sweep time = auto.
- f) Detector = RMS (i.e., power averaging), if available. Otherwise, use sample detector mode.
- g) If transmit duty cycle $< 98\%$, use a sweep trigger with the level set to enable triggering only on full power pulses. The transmitter shall operate at the maximum power control level for the entire duration of every sweep. If the EUT transmits continuously (i.e., with no OFF intervals) or at duty cycle $\geq 98\%$, and if each transmission is entirely at the maximum power control level, then the trigger shall be set to “free run.”
- h) Trace average at least 100 traces in power averaging (rms) mode.
- i) Compute power by integrating the spectrum across the OBW of the signal using the instrument’s band power measurement function, with band limits set equal to the OBW band edges. If the instrument does not have a band power

function, sum the spectrum levels (in power units) at intervals equal to the RBW extending across the entire OBW of the spectrum.

The test procedure is defined in ANSI C63.10-2013 (11.9.2.2.2 Measurement Procedure “ Method AVGSA-1” was used).

7.6 Test Results

PASSED.

All the test results are listed below.

(Test Date: 2022.12.15 Temperature: 23°C Humidity: 51 %)

Modulation	Transmission Duration (ms)	Transmission Period (ms)	Duty Cycle (%)	Correct Factor (dB)
802.11b	∞	∞	100	0
802.11g	∞	∞	100	0
802.11n20	∞	∞	100	0
802.11n40	∞	∞	100	0

Modulation	Channel	Frequency (MHz)	Maximum conducted (average) Output Power (dBm)	Limit
802.11b	1	2412	15.26	30 dBm
	6	2437	15.77	30 dBm
	11	2462	15.78	30 dBm
802.11g	1	2412	14.87	30 dBm
	6	2437	15.09	30 dBm
	11	2462	15.12	30 dBm
802.11n20	1	2412	13.53	30 dBm
	6	2437	13.98	30 dBm
	11	2462	14.03	30 dBm
802.11n40	3	2422	13.3	30 dBm
	6	2437	13.22	30 dBm
	9	2452	13.31	30 dBm

802.11b CH2412MHz

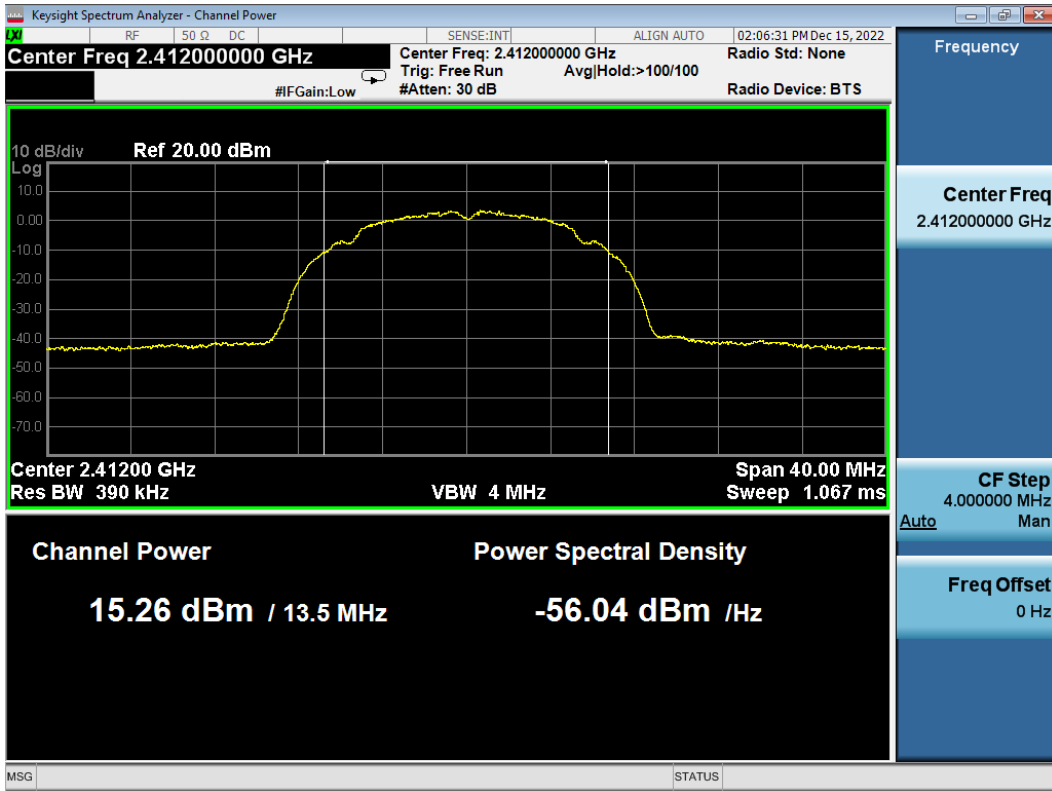

802.11b CH2437MHz

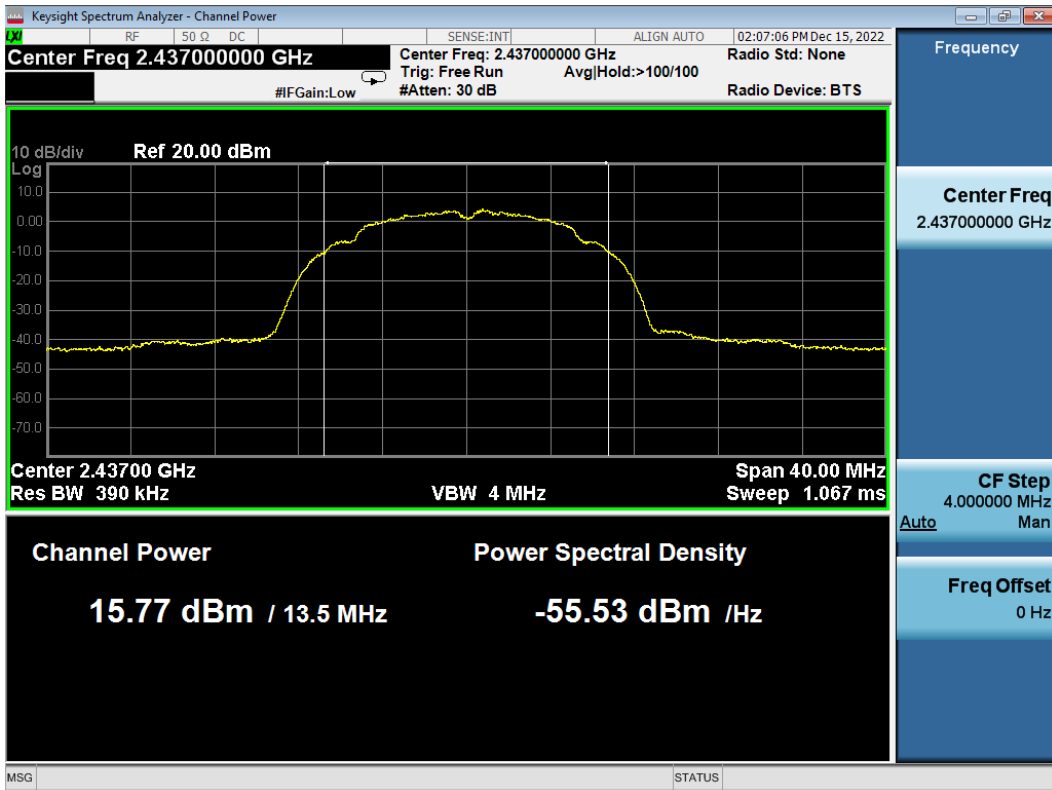

802.11b CH2462MHz

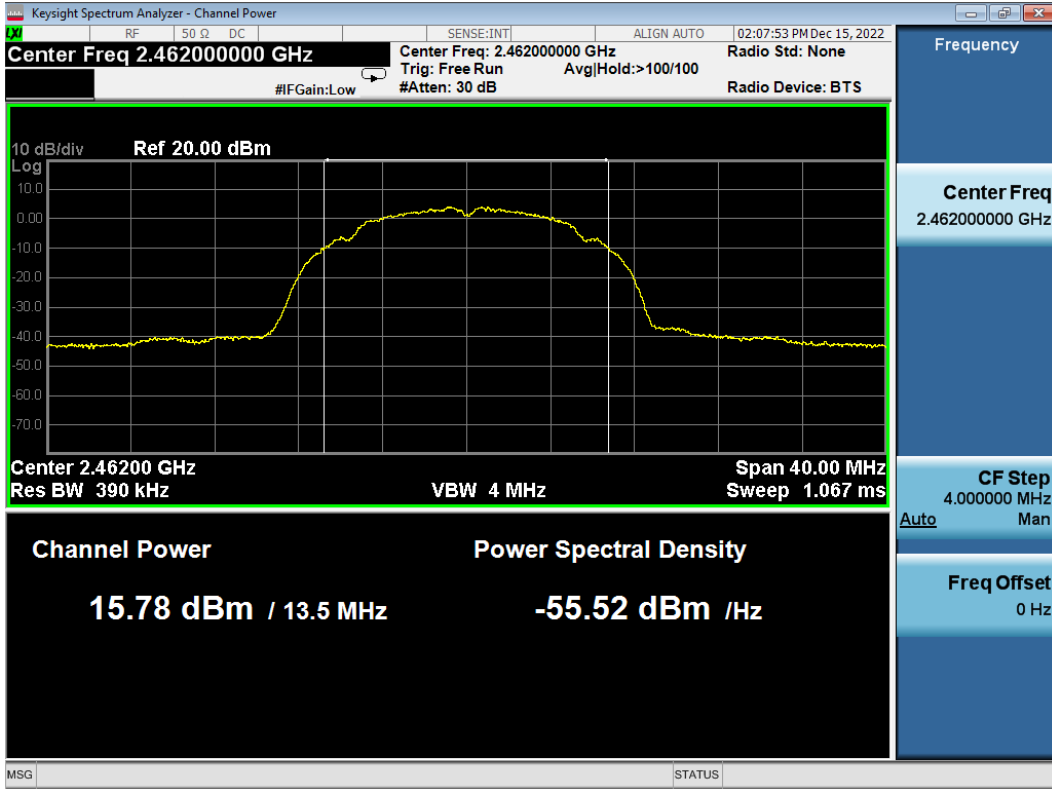

802.11g CH2412MHz

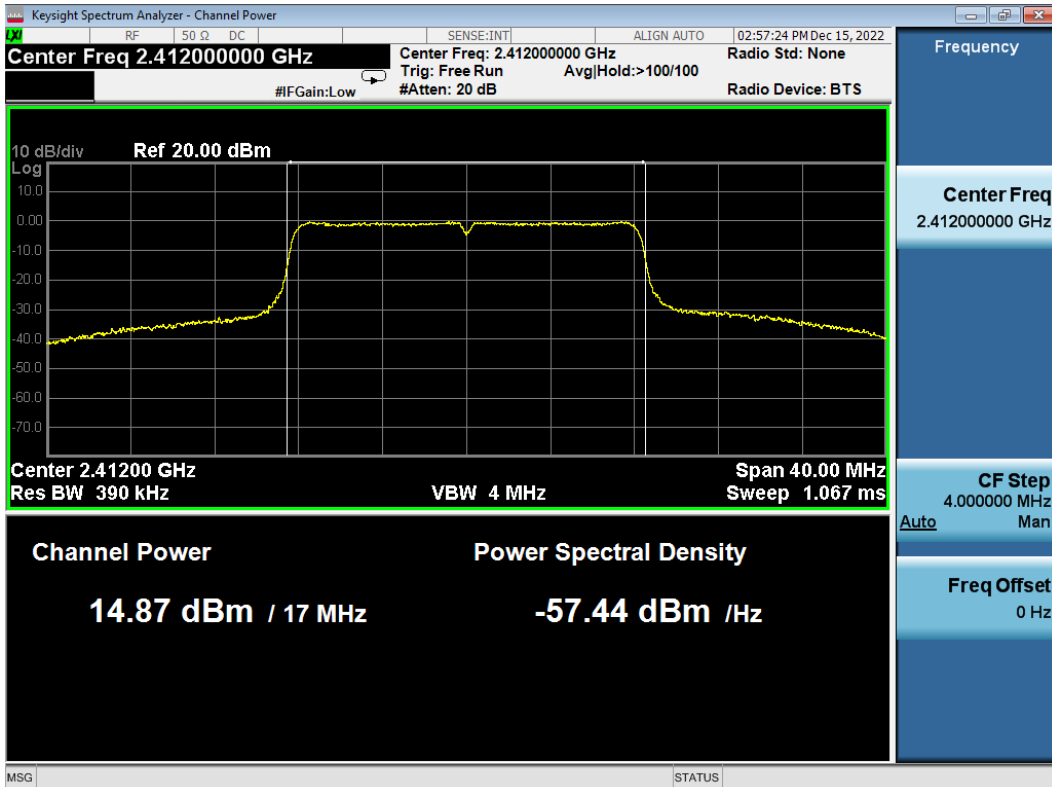

802.11g CH2437MHz

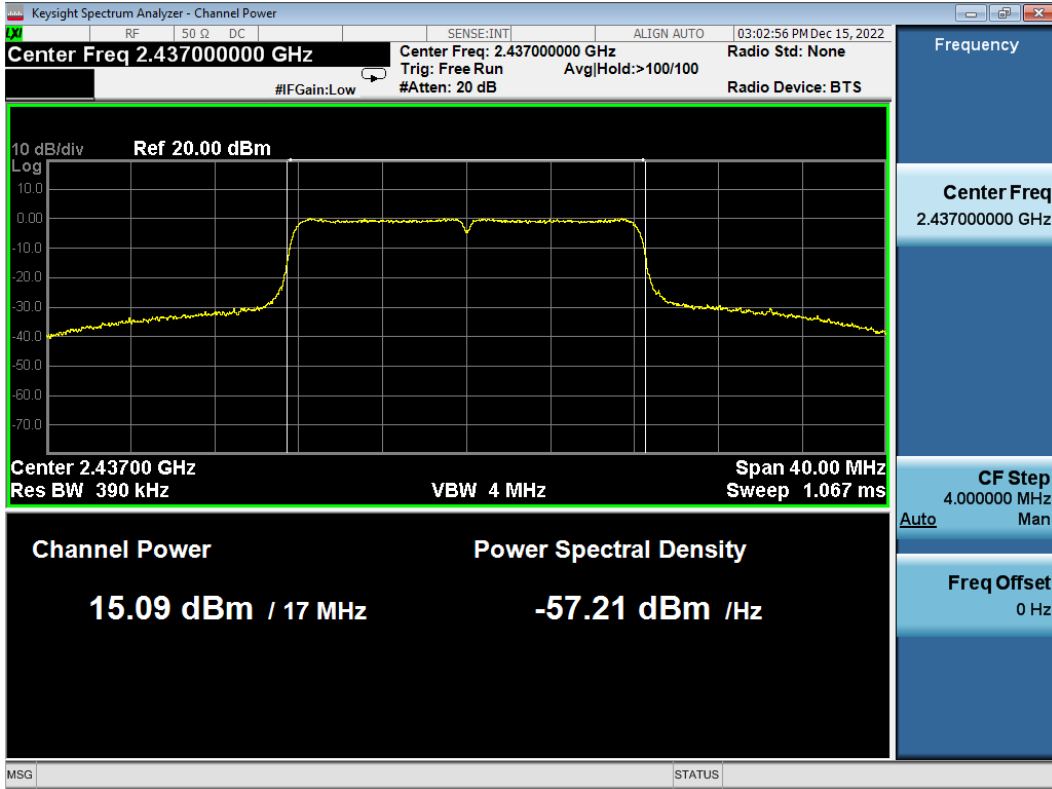

802.11g CH2462MHz

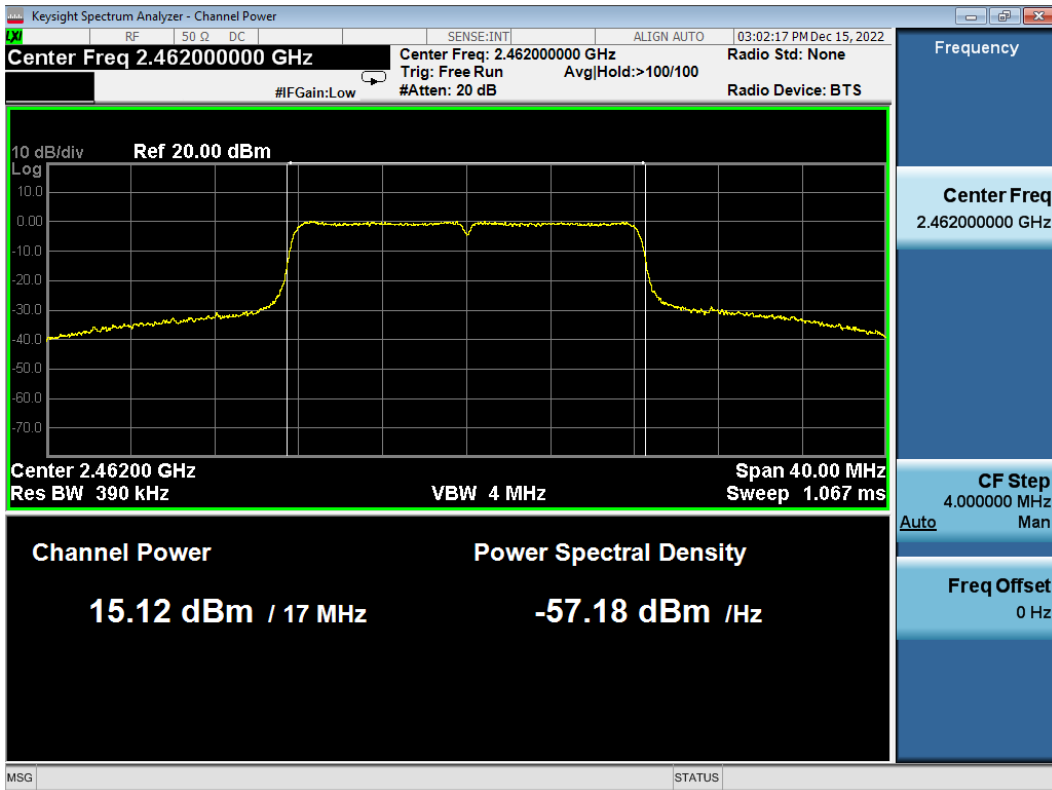

802.11n20 CH2412MHz

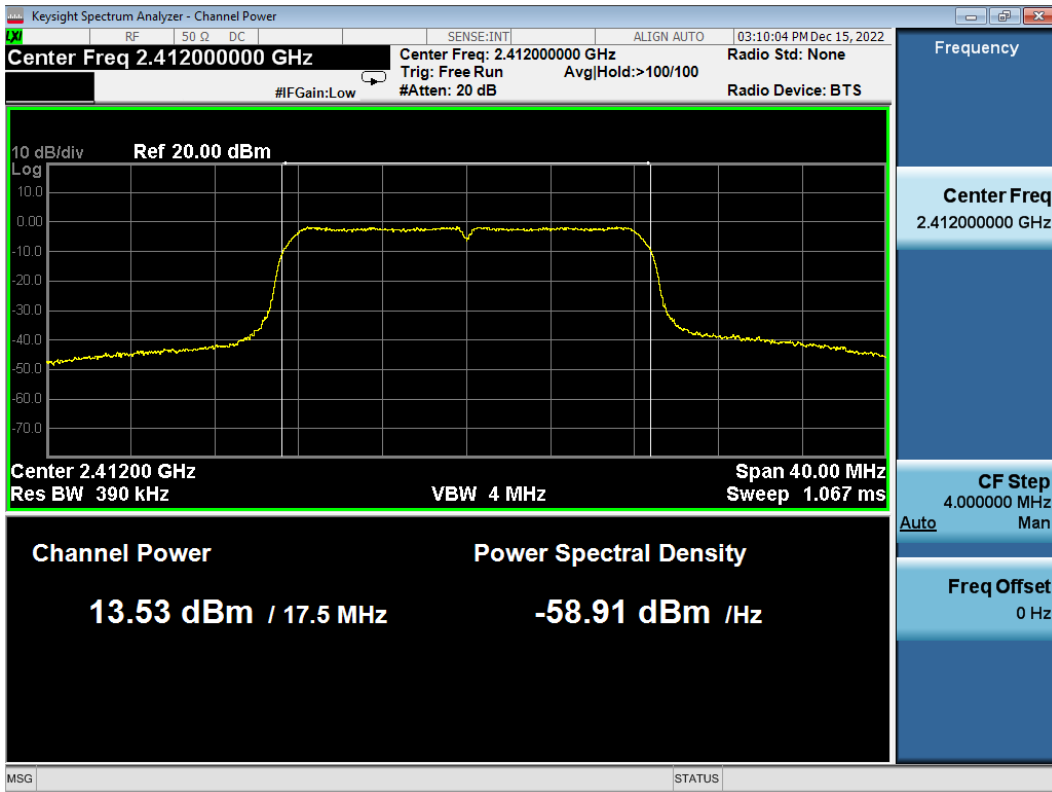

802.11n20 CH2437MHz

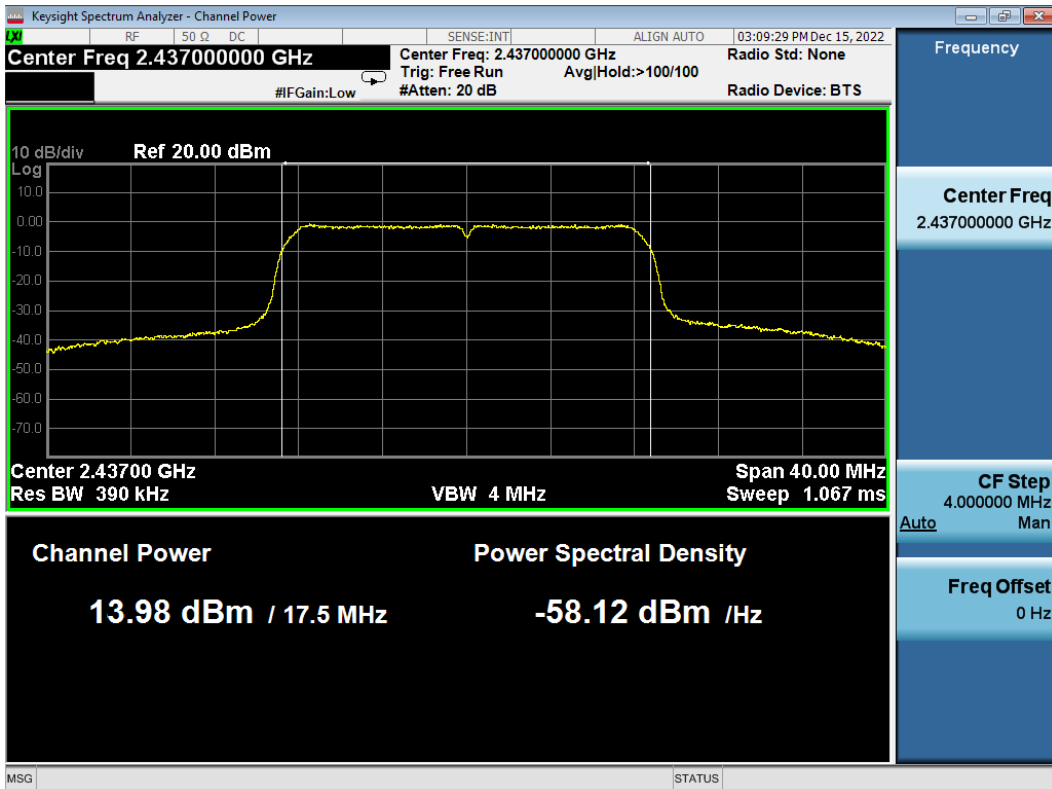

802.11n20 CH2462MHz

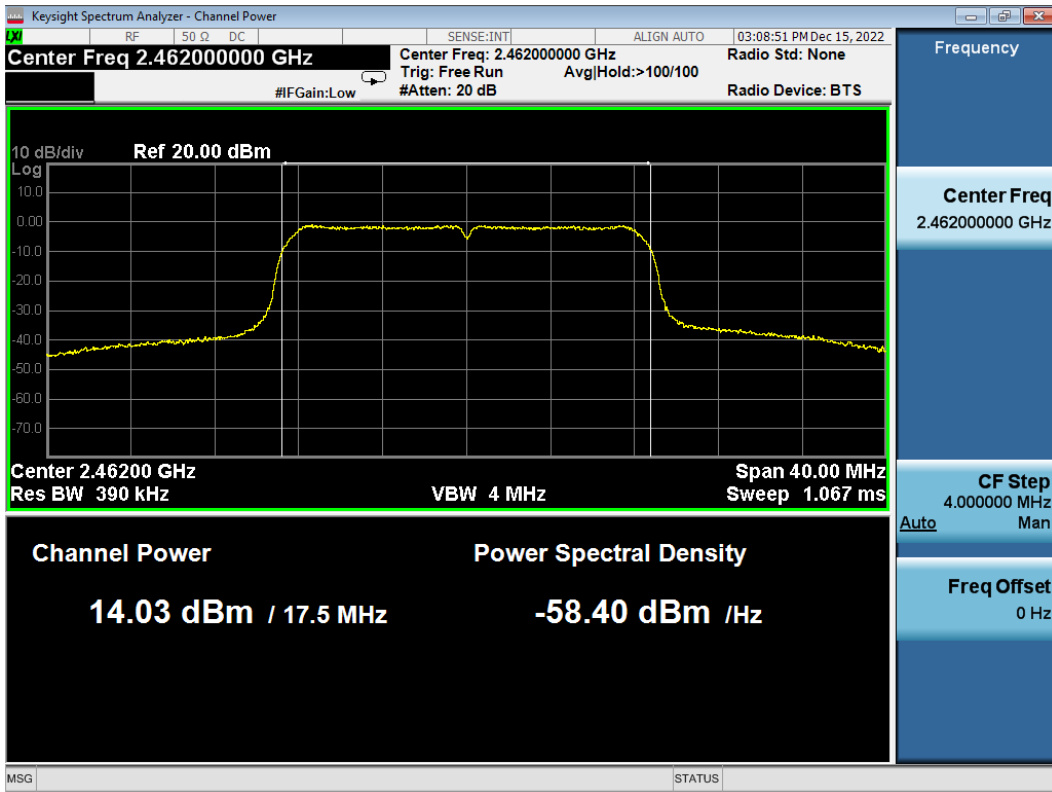

802.11n40 CH2422MHz

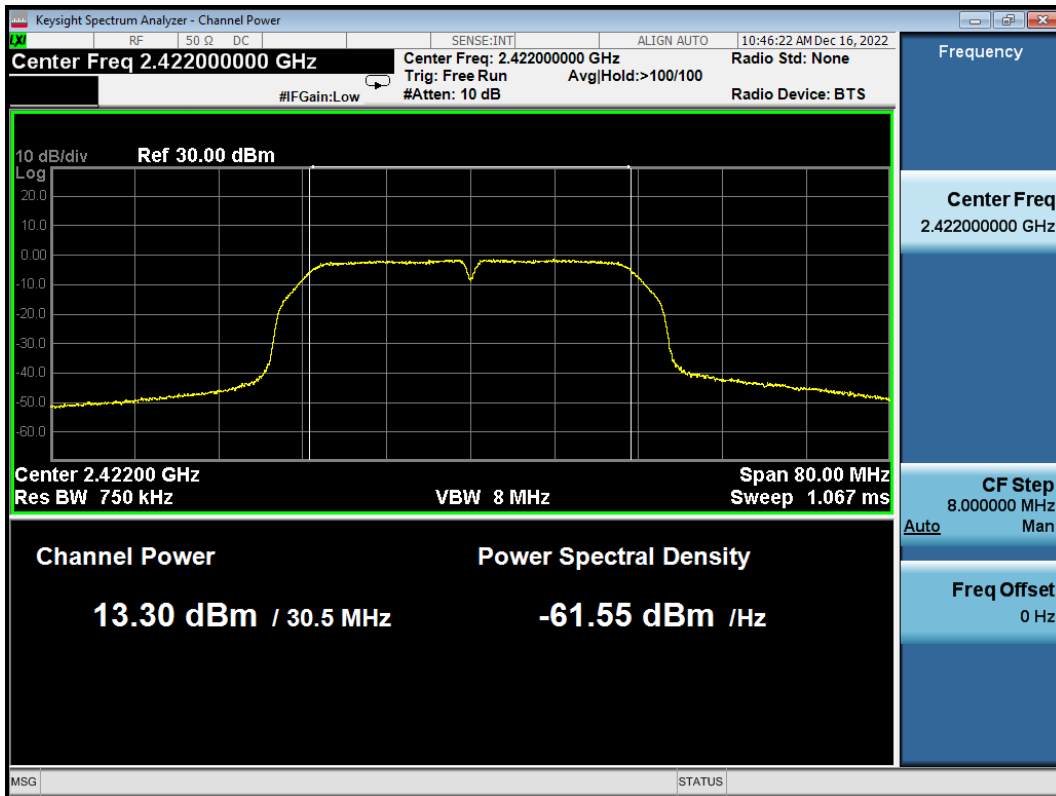

802.11n40 CH2437MHz

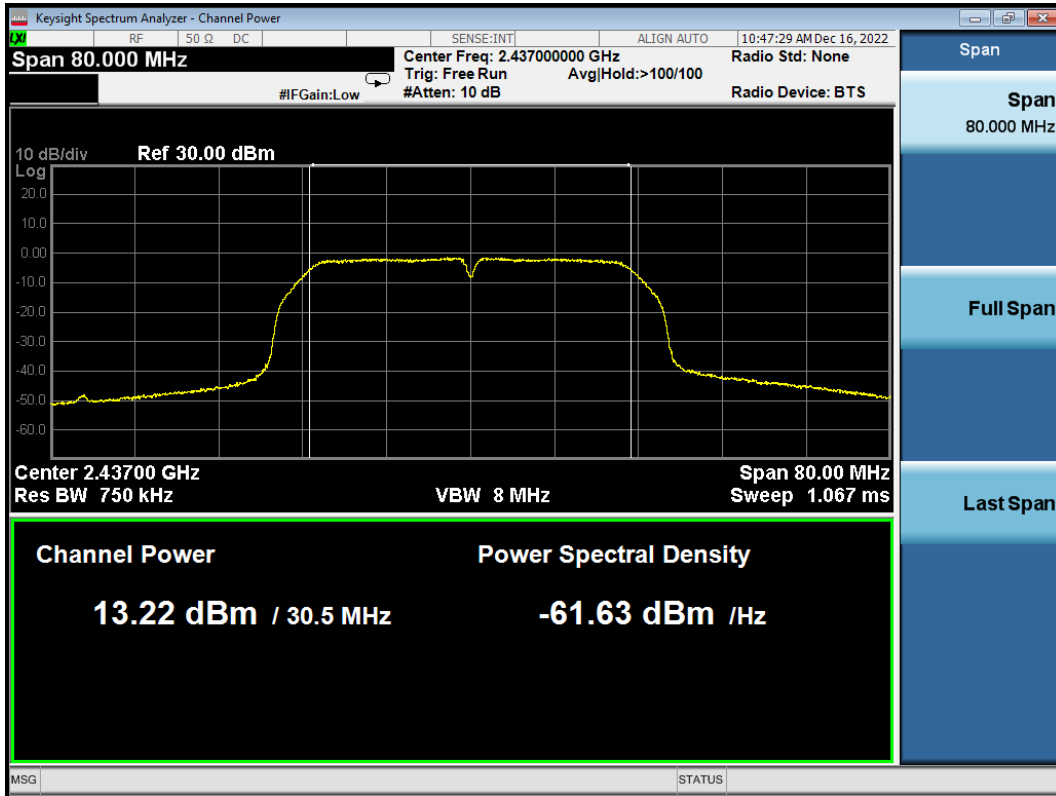

802.11n40 CH2452MHz

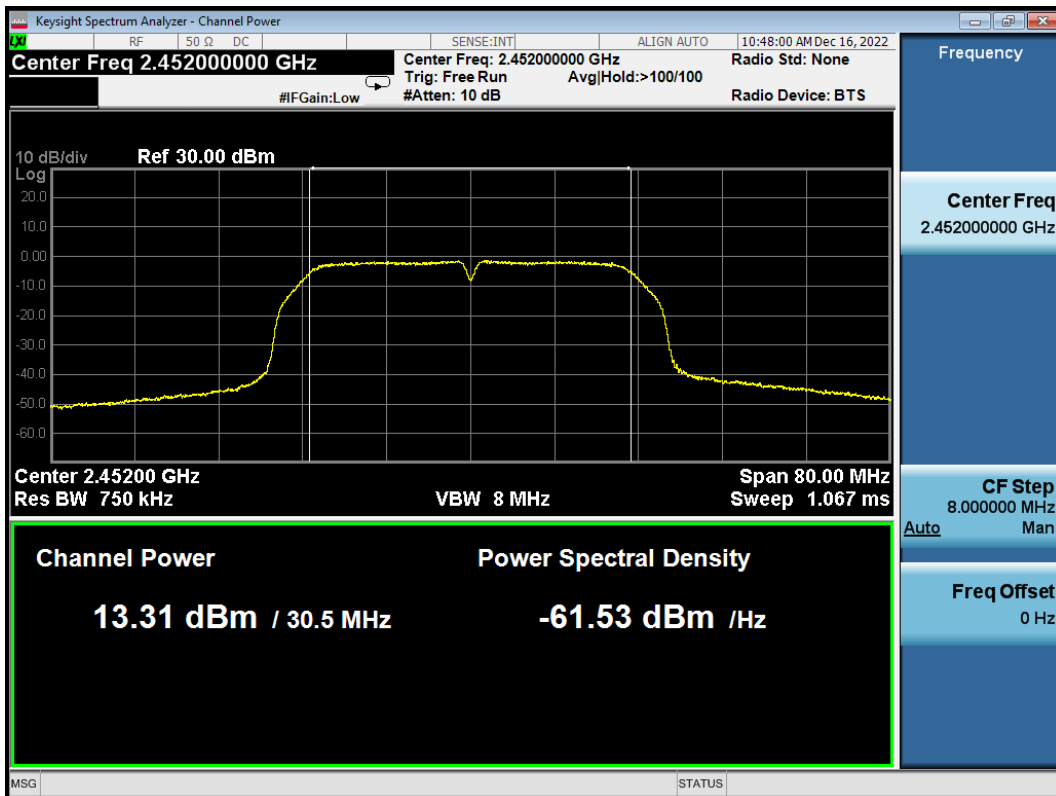

8 EMISSION LIMITATIONS MEASUREMENT

8.1 Test Equipment

The following test equipment was used during the emission limitations test:

Item	Type	Manufacturer	Model No.	Serial No.	Cal. Date	Cal. Interval
1.	Spectrum Analyzer	Agilent	N9010A	MY52221182	2022.09.15	1 Year
2.	Coaxial Cable	WOKEN	SFL402-105F LEX	F02-150819-045	2022.03.07	1 Year
3.	20 dB Attenuator	Mini-Circuits	VAT-20+	001	2022.08.06	1 Year

8.2 Block Diagram of Test Setup

The Same as Section. 5.2.

8.3 Specification Limits (§15.247(d))

In any 100 kHz bandwidth outside the frequency band in which the spread spectrum or digitally modulated intentional radiator is operating, the radio frequency power that is produced by the intentional radiator shall be at least 20 dB below that in the 100 kHz bandwidth within the band that contains the highest level of the desired power, based on either an RF conducted or a radiated measurement, provided the transmitter demonstrates compliance with the peak conducted power limits. If the transmitter complies with the conducted power limits based on the use of RMS averaging over a time interval, as permitted under paragraph (b)(3) of this section, the attenuation required under this paragraph shall be 30 dB instead of 20 dB. Attenuation below the general limits specified in §15.209(a) is not required.

In addition, radiated emissions which fall in the restricted bands, as defined in §15.205(a), must also comply with the radiated emission limits specified in §15.209(a) (see §15.205(c)). (※This test result attaching to Section. 3.7)

8.4 Operating Condition of EUT

The software as section 2.3 was used to enable the EUT to change the test mode one by one.

8.5 Test Procedure

The transmitter output was connected to the spectrum analyzer.

Establish a reference level by using the following procedure:

- a) Set instrument center frequency to DTS channel center frequency.
- b) Set the span to ≥ 1.5 times the DTS bandwidth.
- c) Set the RBW = 100 kHz.
- d) Set the VBW $\geq [3 \times \text{RBW}]$.
- e) Detector = peak.
- f) Sweep time = auto couple.
- g) Trace mode = max hold.
- h) Allow trace to fully stabilize.
- i) Use the peak marker function to determine the maximum PSD level.

Note that the channel found to contain the maximum PSD level can be used to establish the reference level.

Establish an emission level by using the following procedure:

- a) Set the center frequency and span to encompass frequency range to be measured.
- b) Set the RBW = 100 kHz.
- c) Set the VBW $\geq [3 \times \text{RBW}]$.
- d) Detector = peak.
- e) Sweep time = auto couple.
- f) Trace mode = max hold.
- g) Allow trace to fully stabilize.
- h) Use the peak marker function to determine the maximum amplitude level.

Ensure that the amplitude of all unwanted emissions outside of the authorized frequency band (excluding restricted frequency bands) is attenuated by at least the minimum requirements specified in 11.11. Report the three highest emissions relative to the limit.

Scan up through 10th harmonic.

The test procedure is defined in ANSI C63.10-2013 (11.11.2 Reference level measurement and 11.11.3 Emission level measurement was used).

8.6 Test Results

PASSED.

The test data was attached in the next pages.

(Test Date: 2022.12.15 Temperature: 23°C Humidity: 51 %)

Modulation	Channel	Frequency (MHz)	Data Page
802.11b	1	2412	P58-59
	6	2437	P60-61
	11	2462	P62-63
802.11g	1	2412	P64-65
	6	2437	P66-67
	11	2462	P68-69
802.11n20	1	2412	P70-71
	6	2437	P72-73
	11	2462	P74-75
802.11n40	3	2422	P76-77
	6	2437	P78-79
	9	2452	P80-81

802.11b CH2412MHz

Reference level

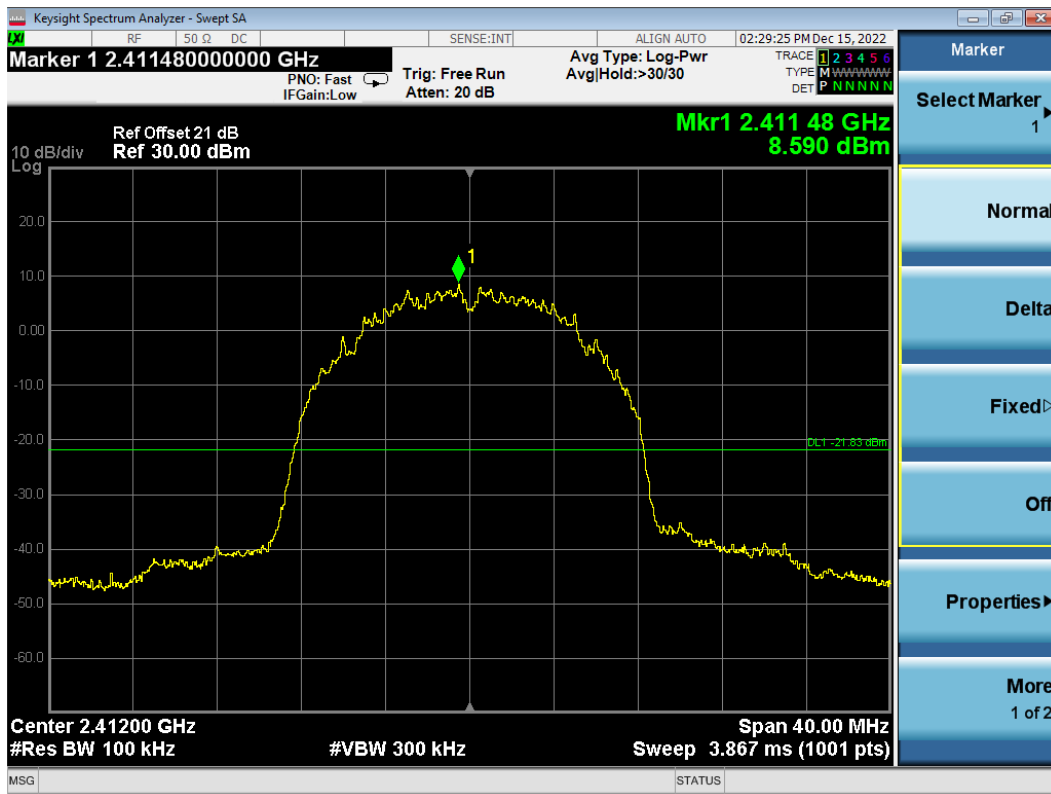

Emission level

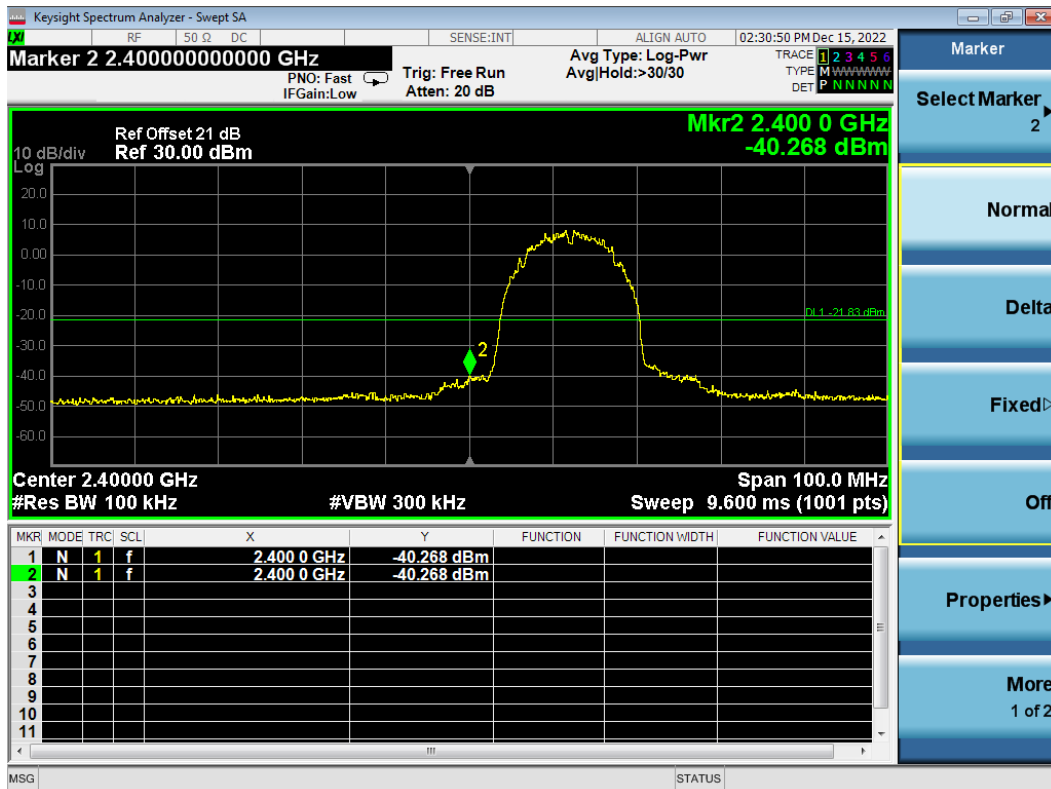

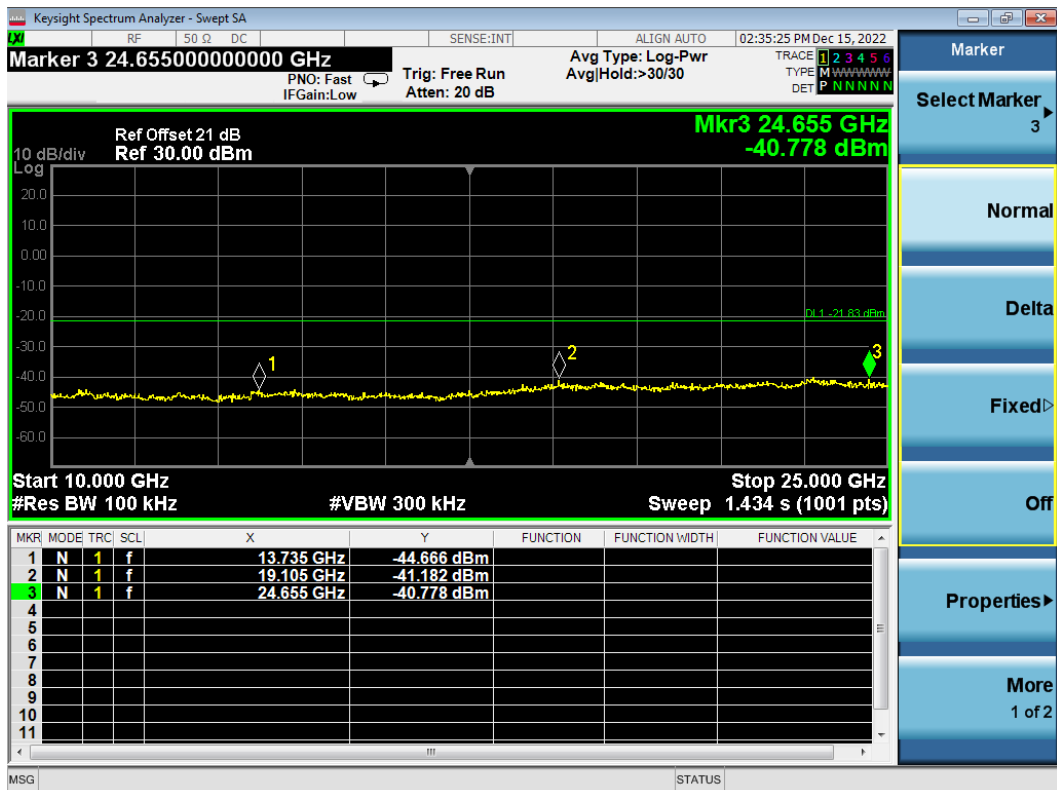
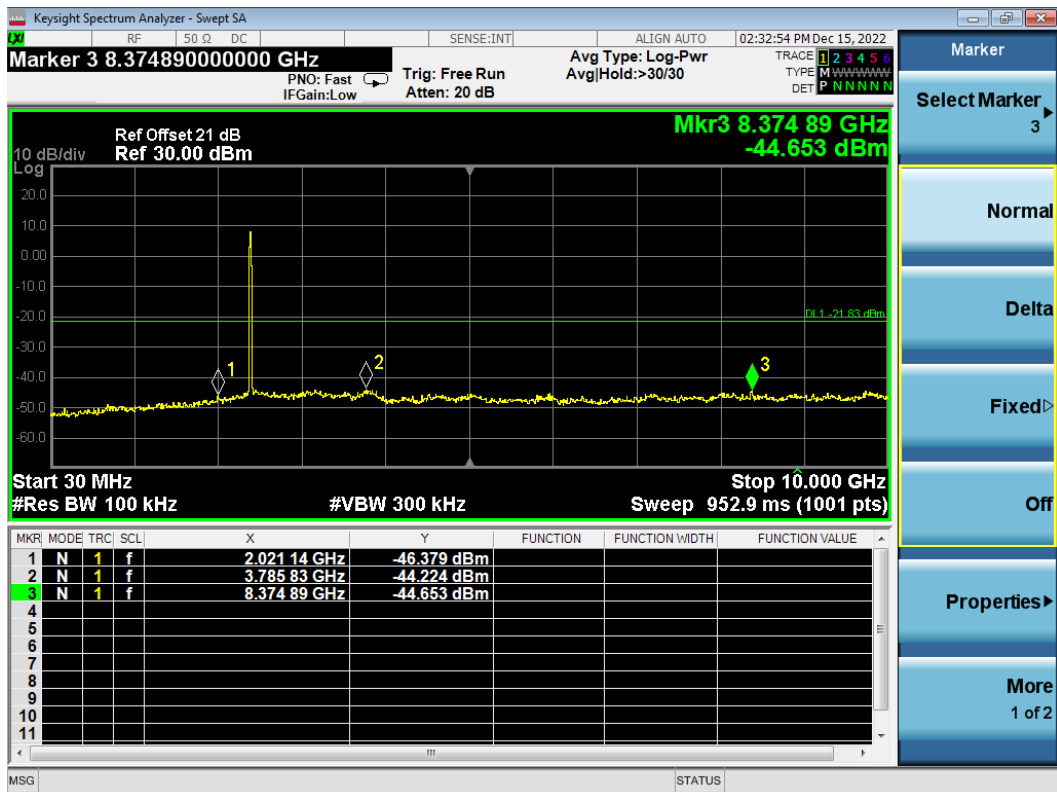

802.11b CH2437MHz

Reference level

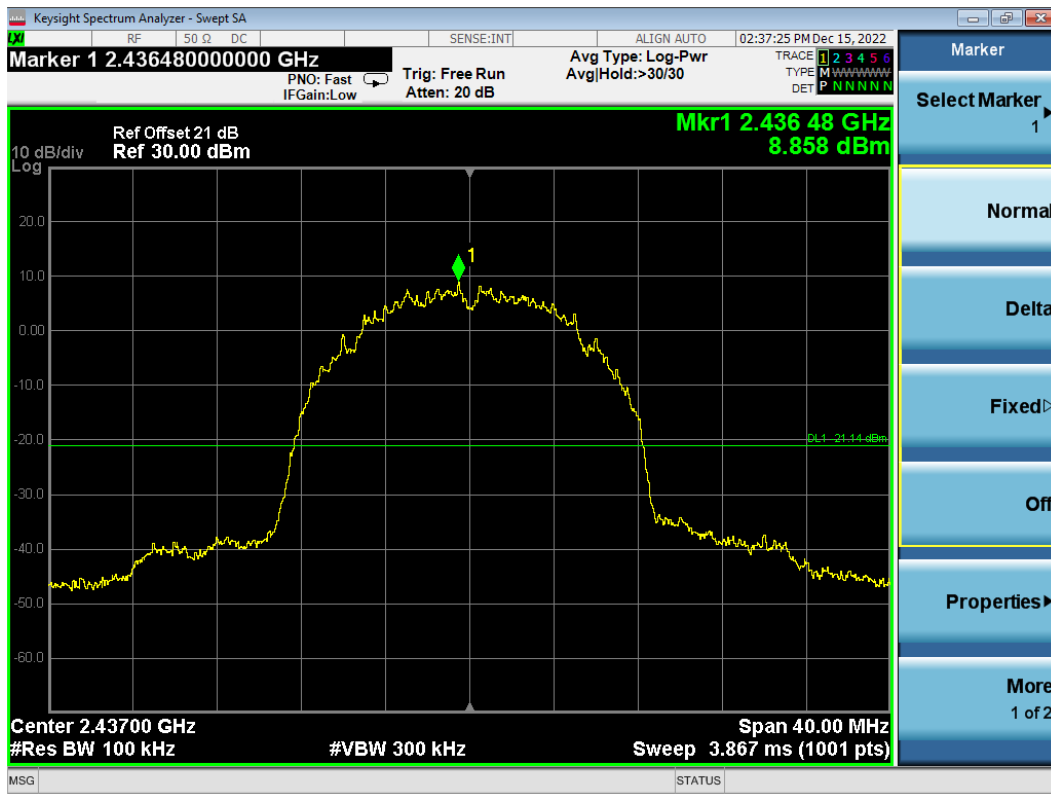

Emission level

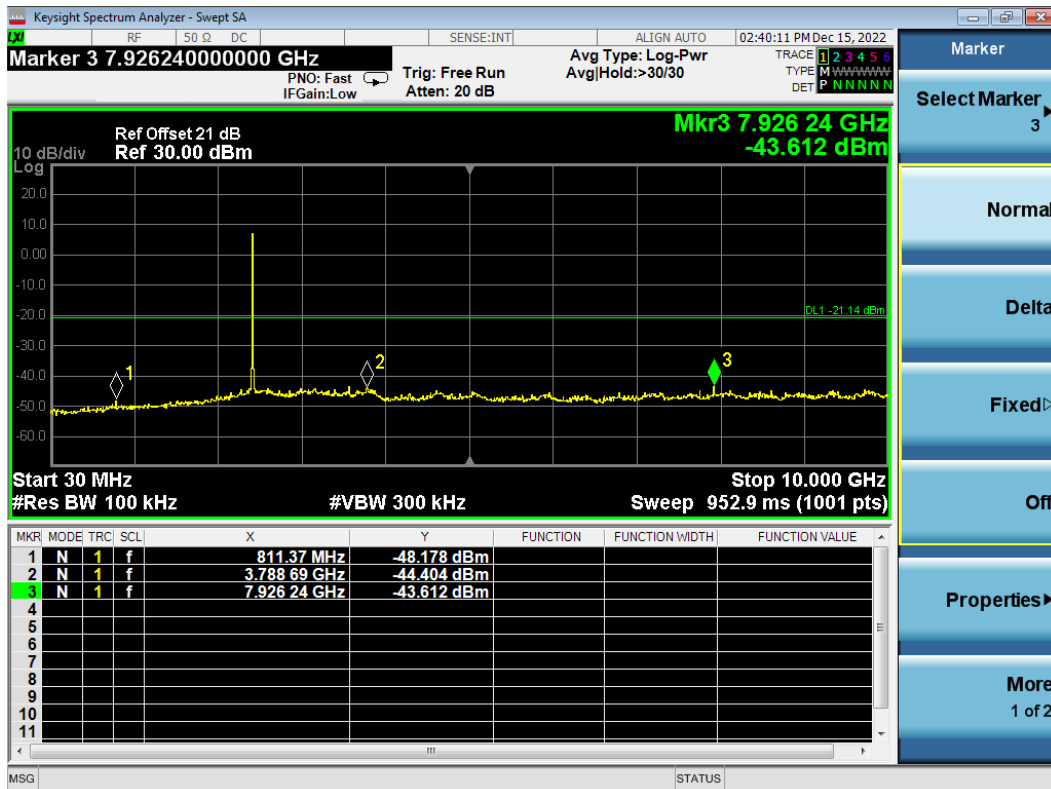

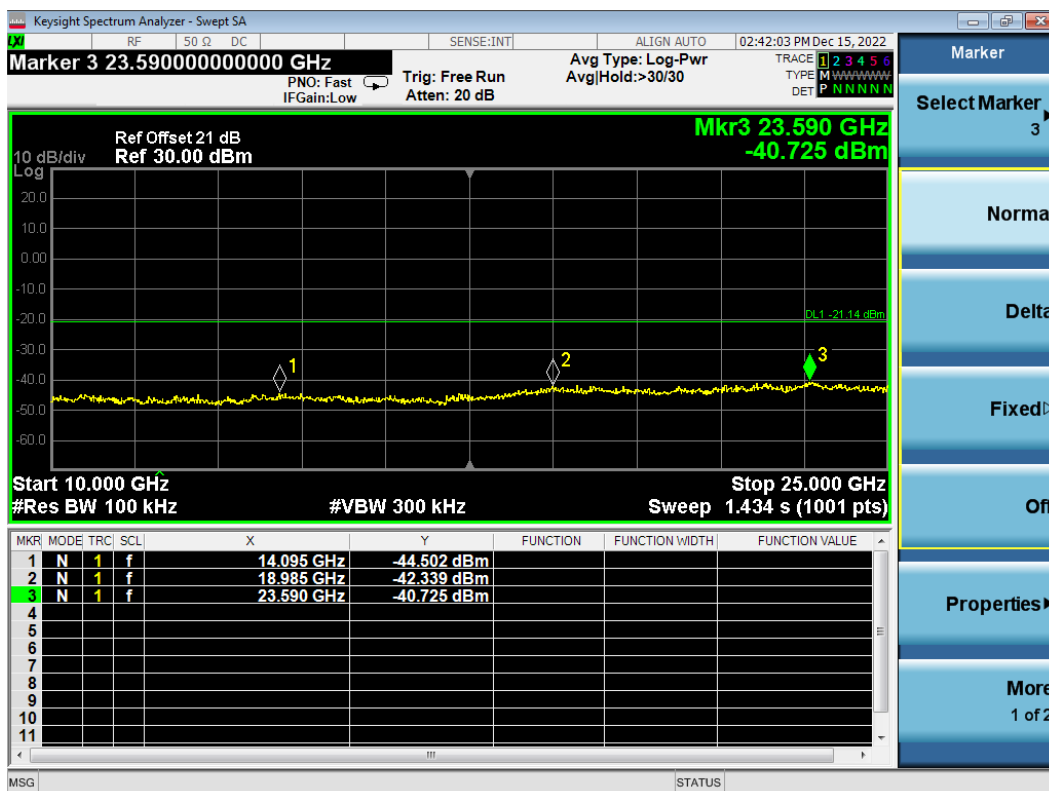

802.11b CH2462MHz

Reference level

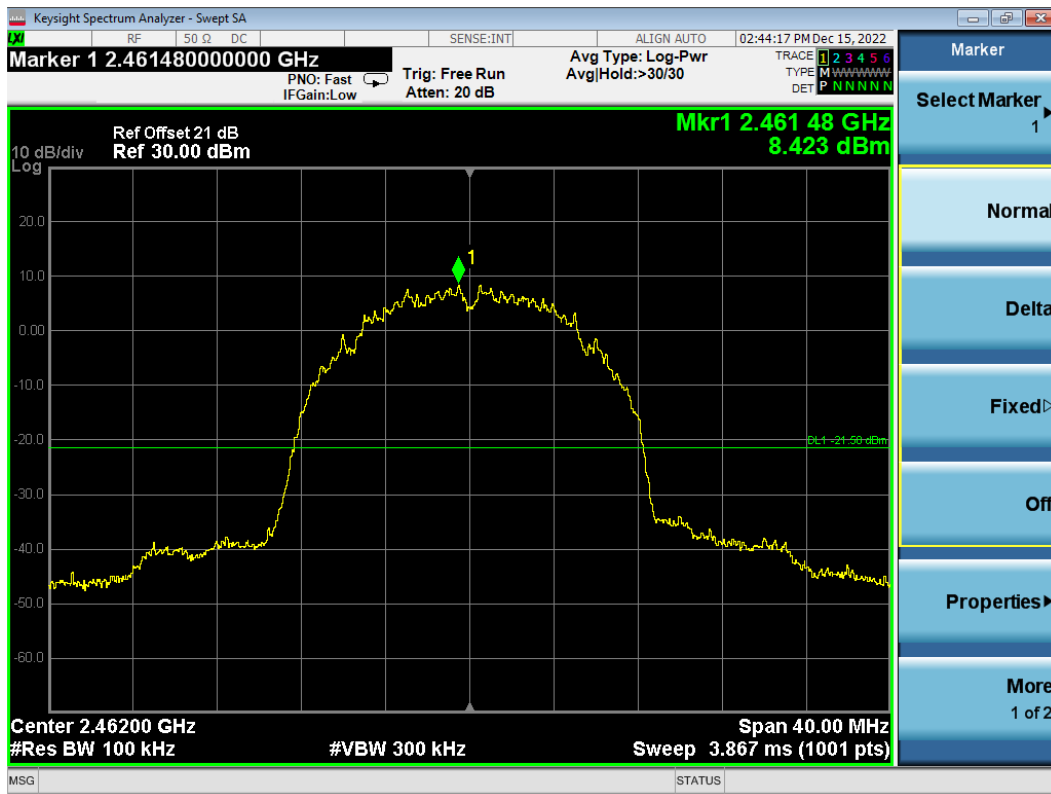

Emission level

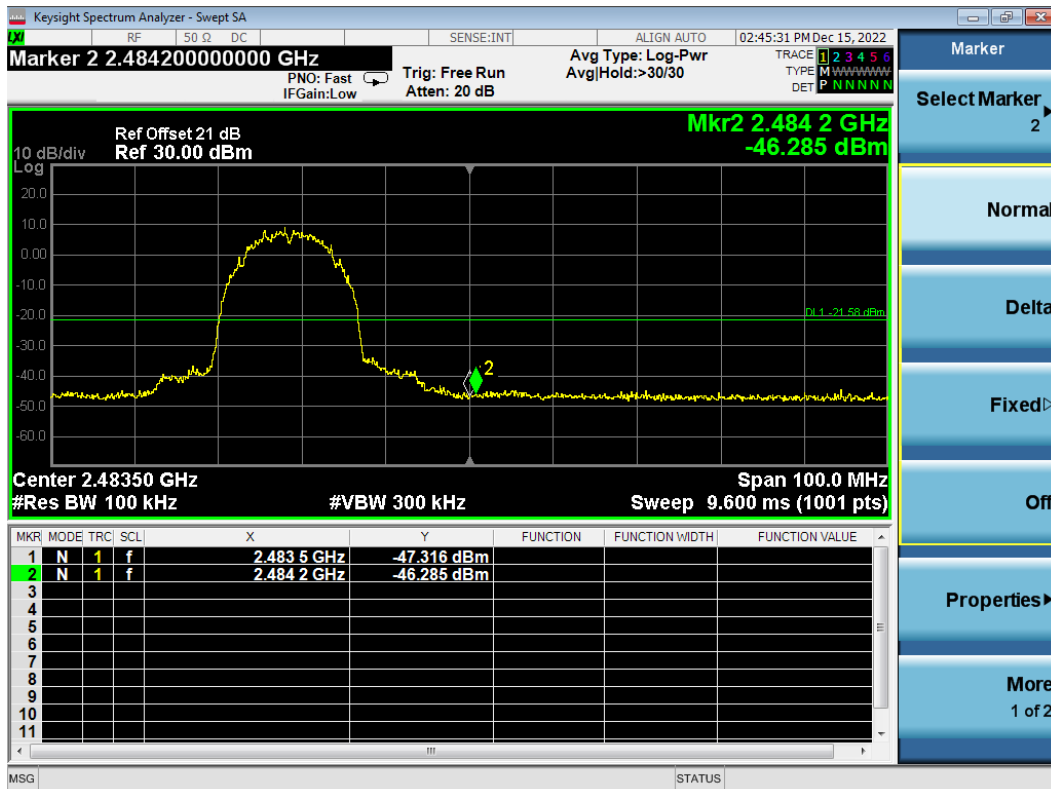

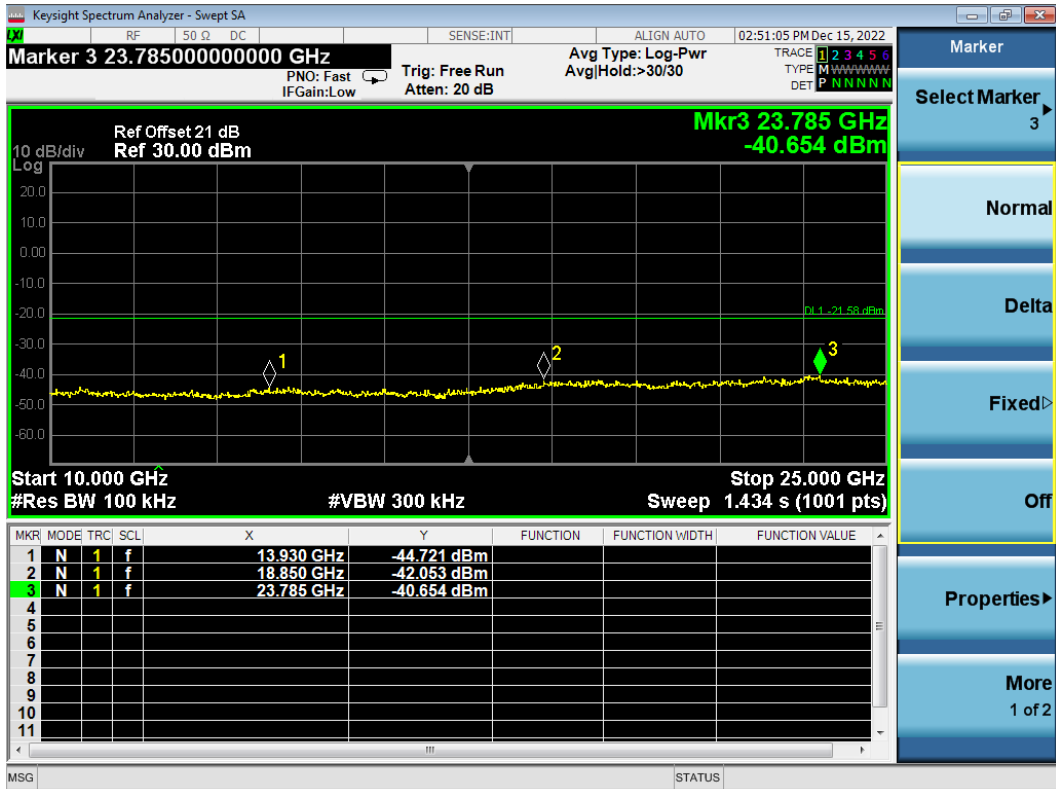
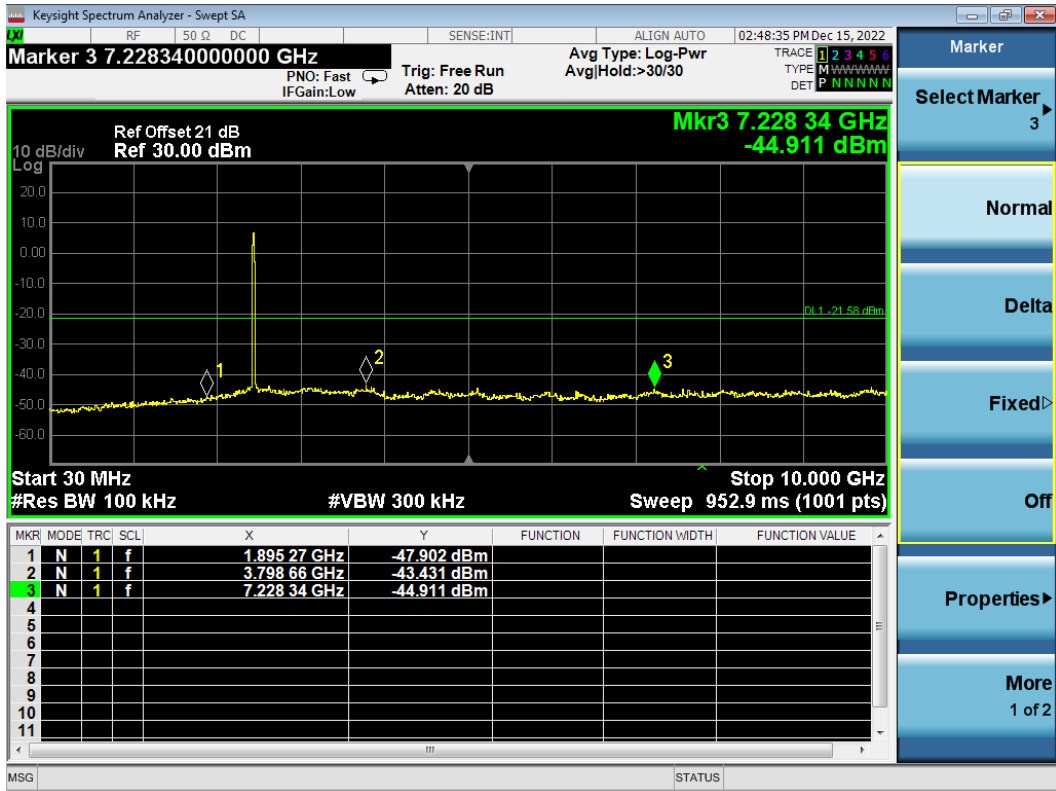

802.11g CH2412MHz

Reference level

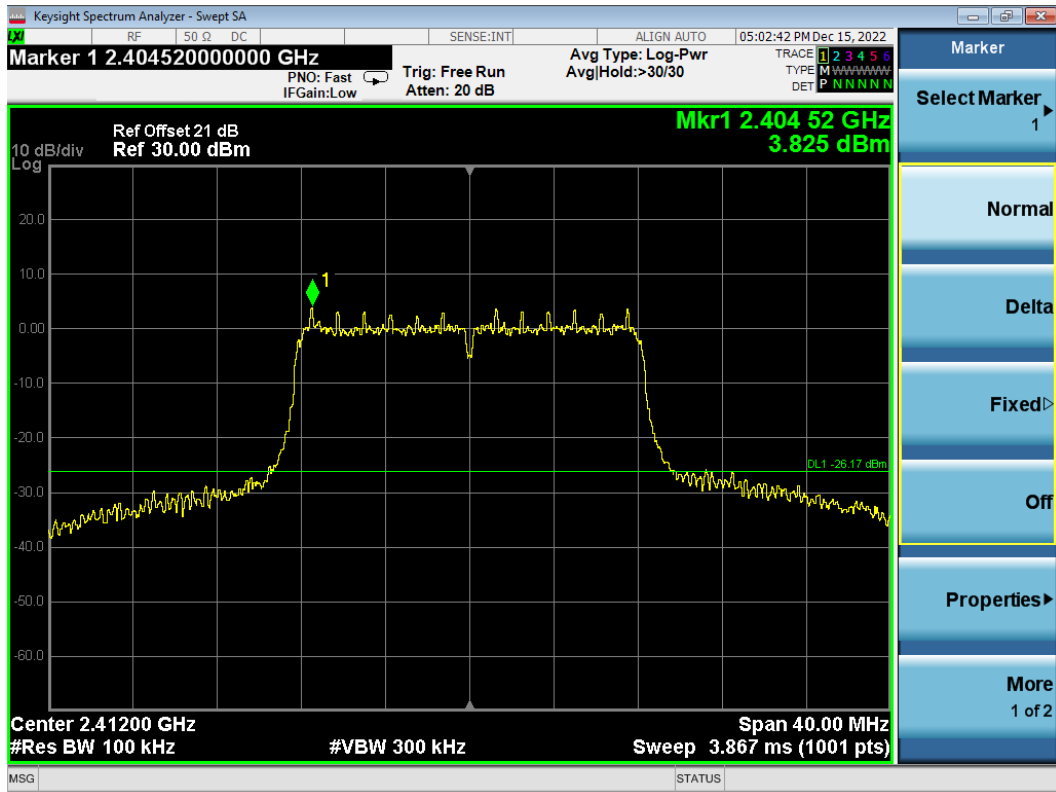

Emission level

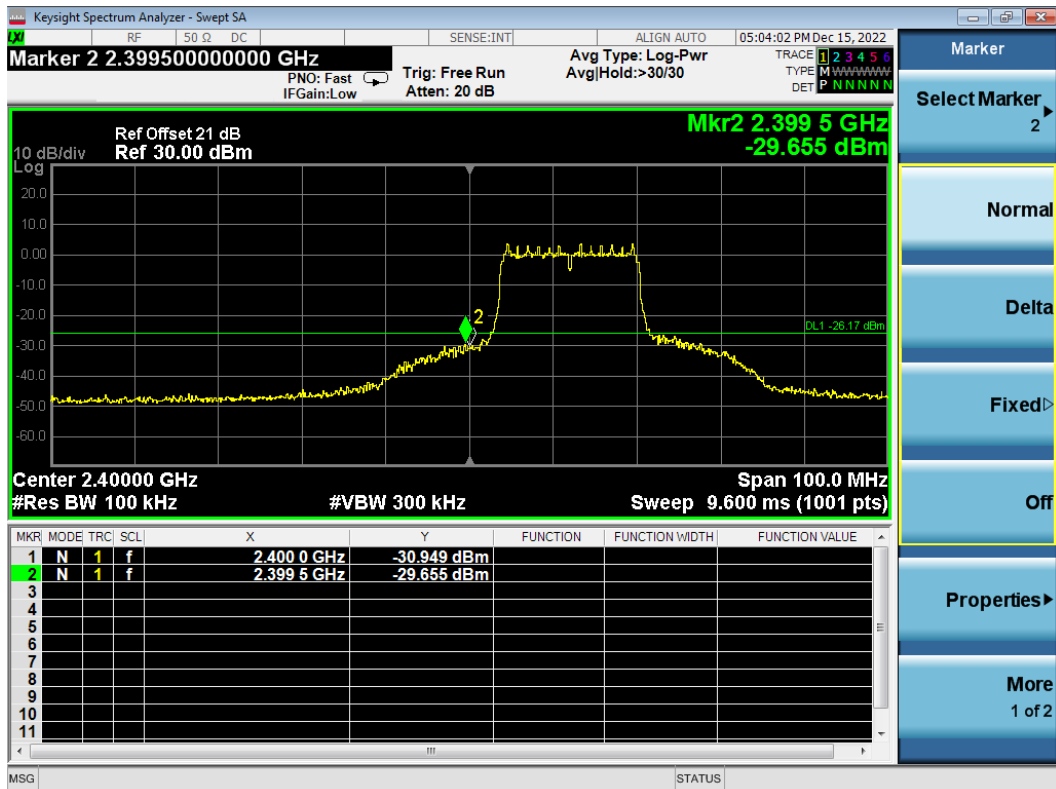

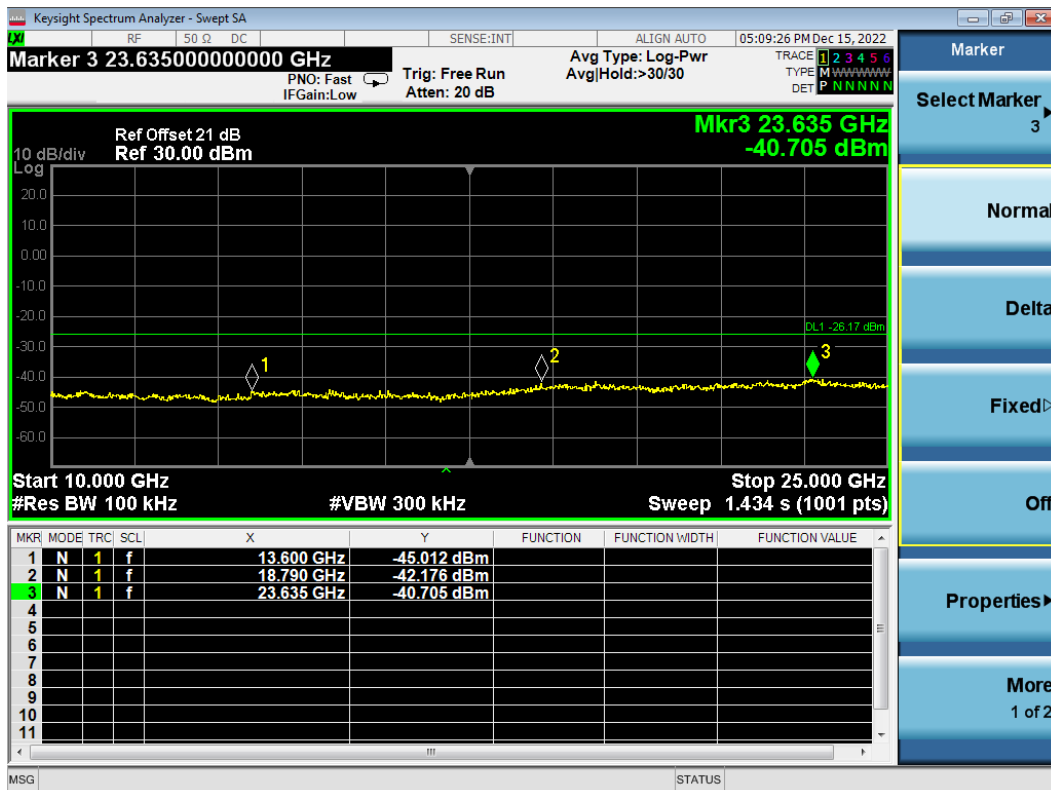
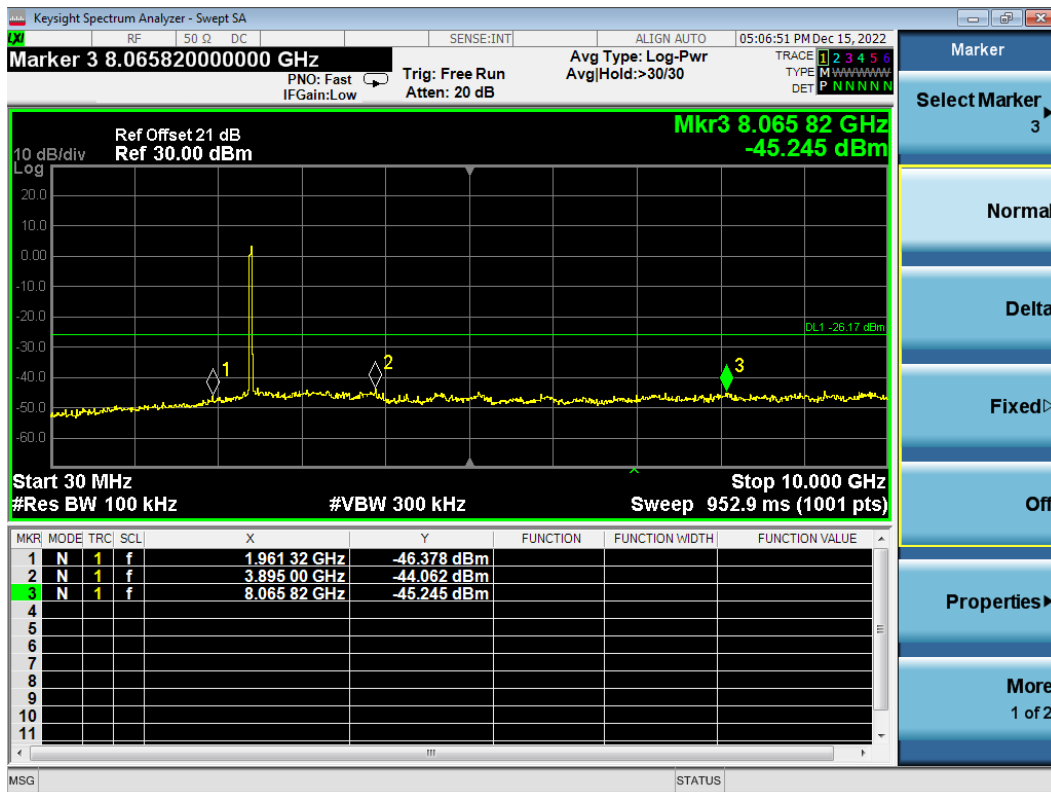

802.11g CH2437MHz

Reference level

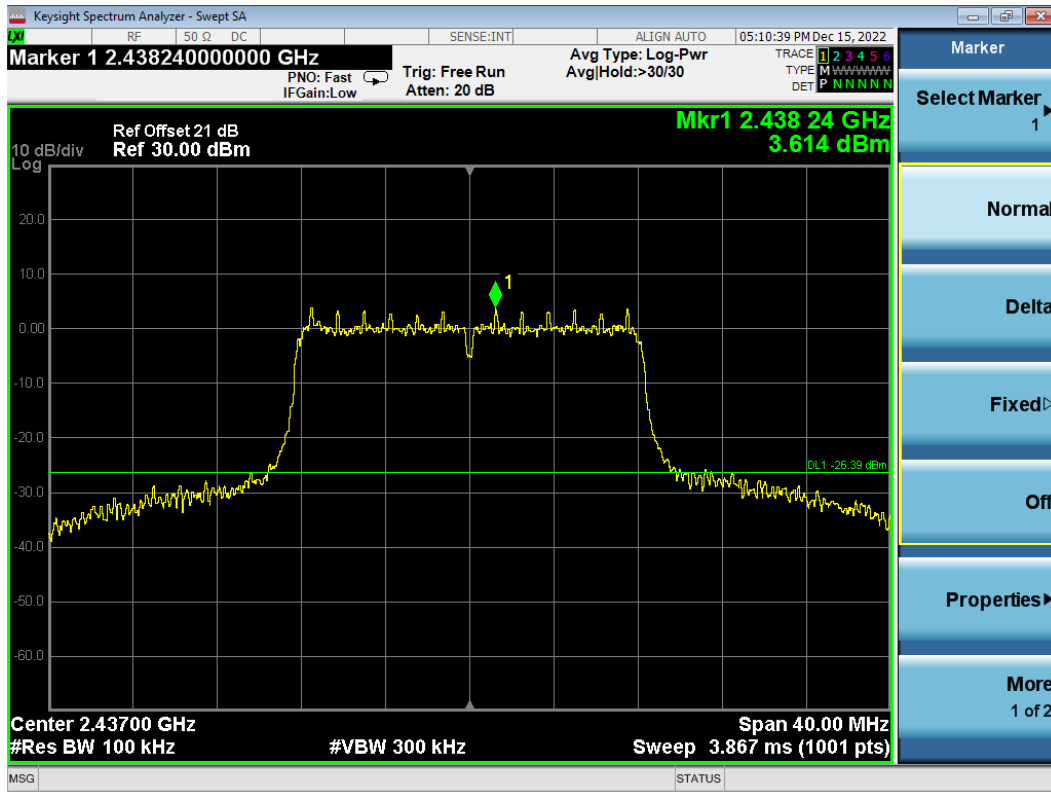

Emission level

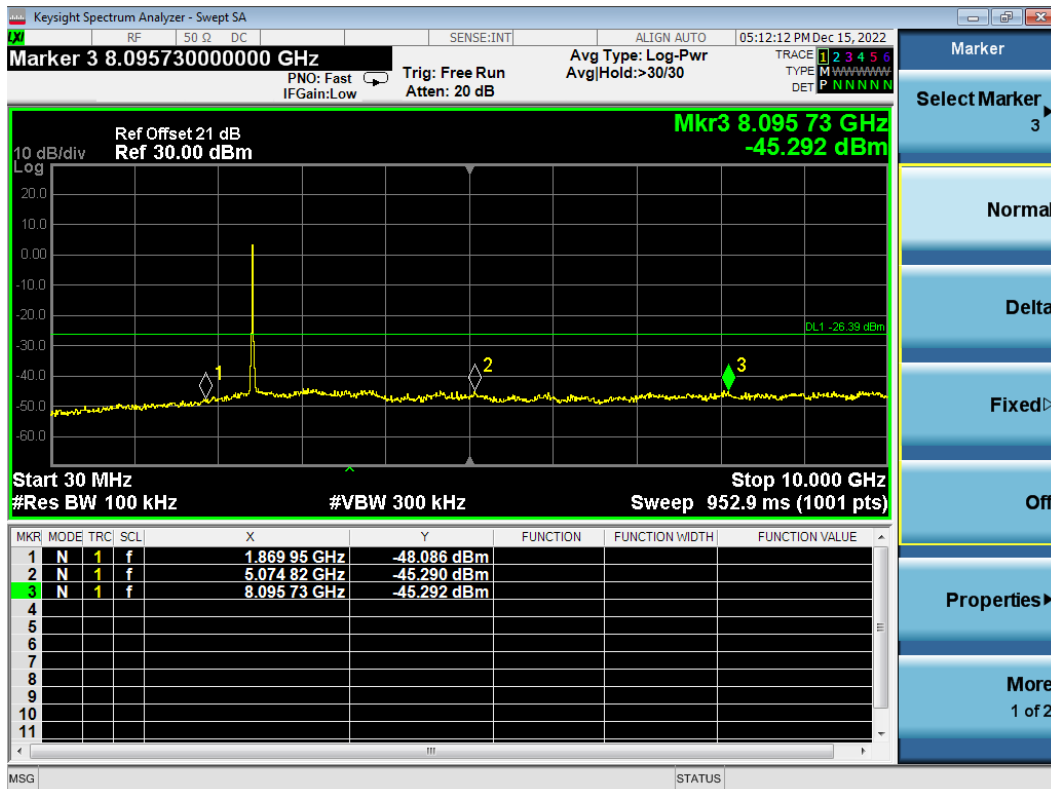

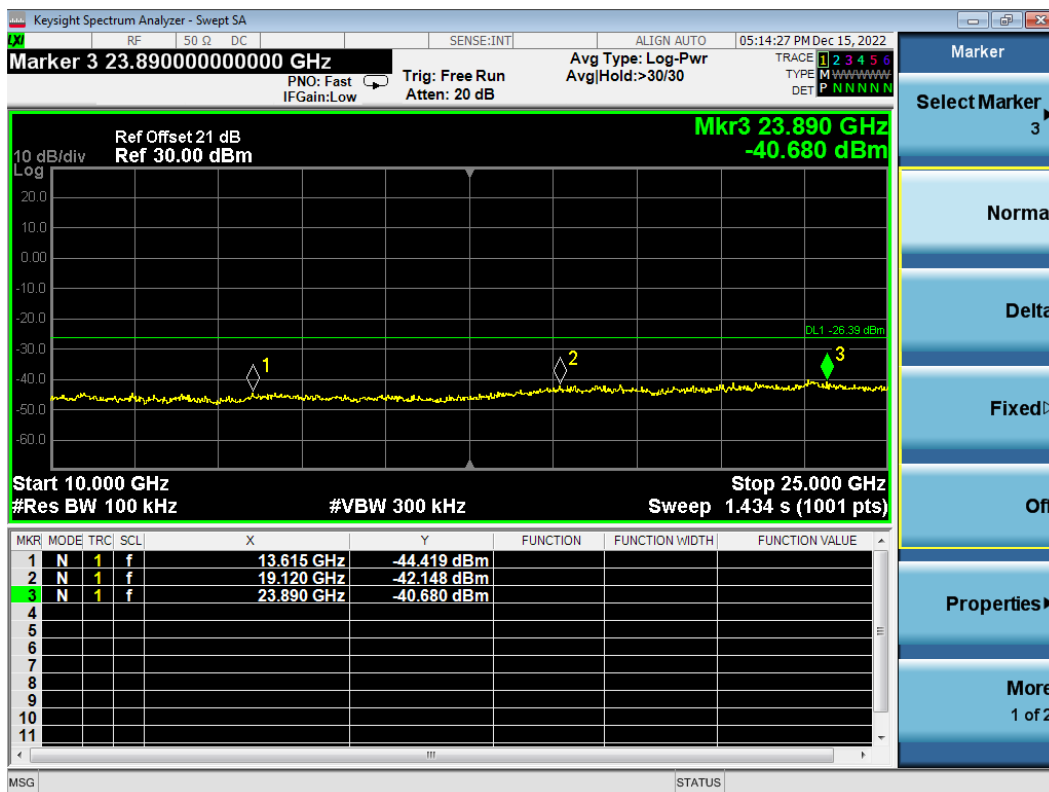

802.11g CH2462MHz

Reference level

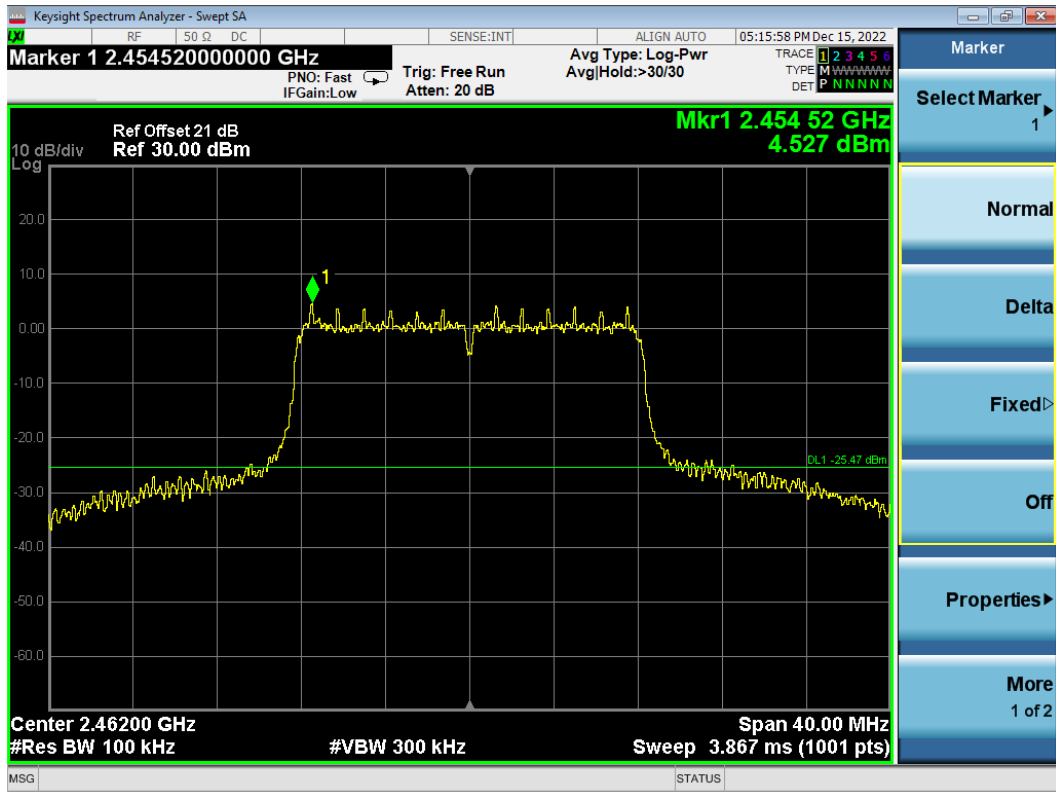

Emission level



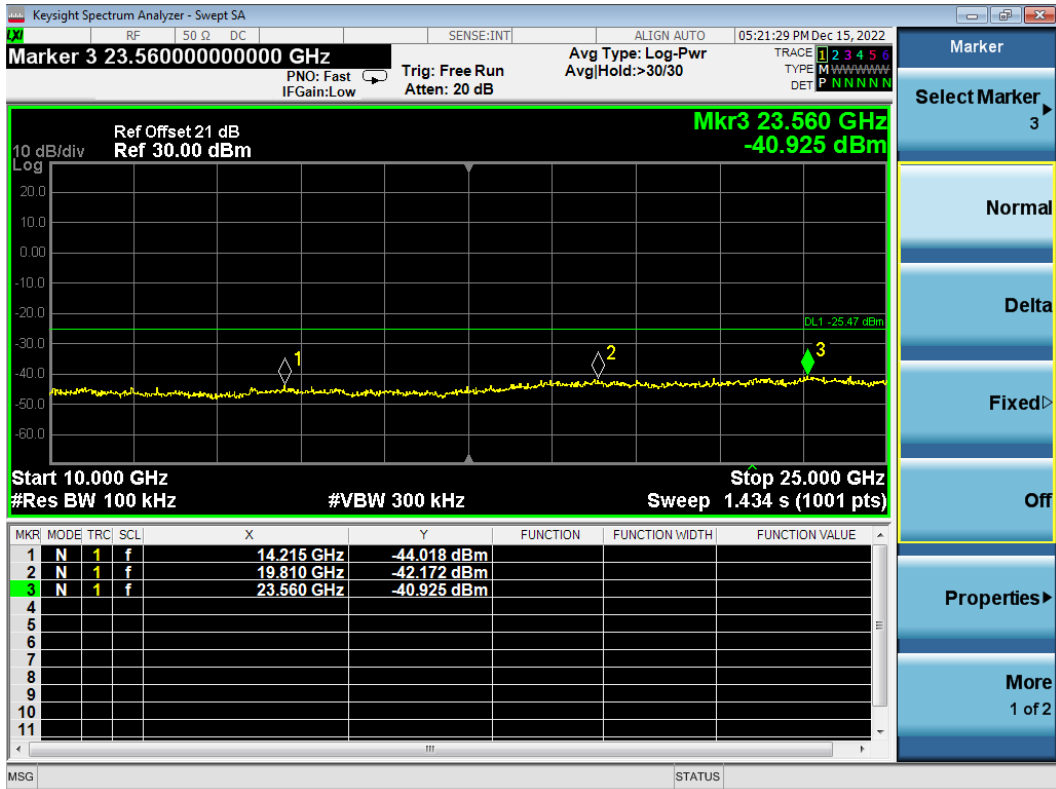
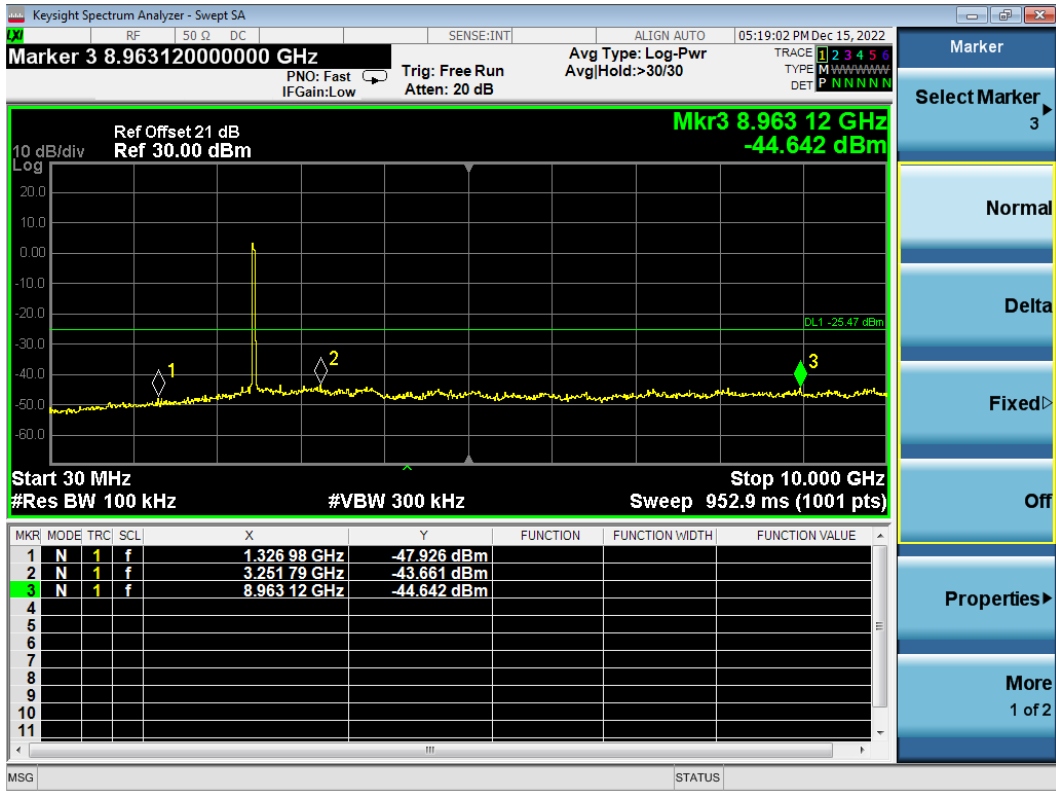

802.11n20 CH2412MHz

Reference level

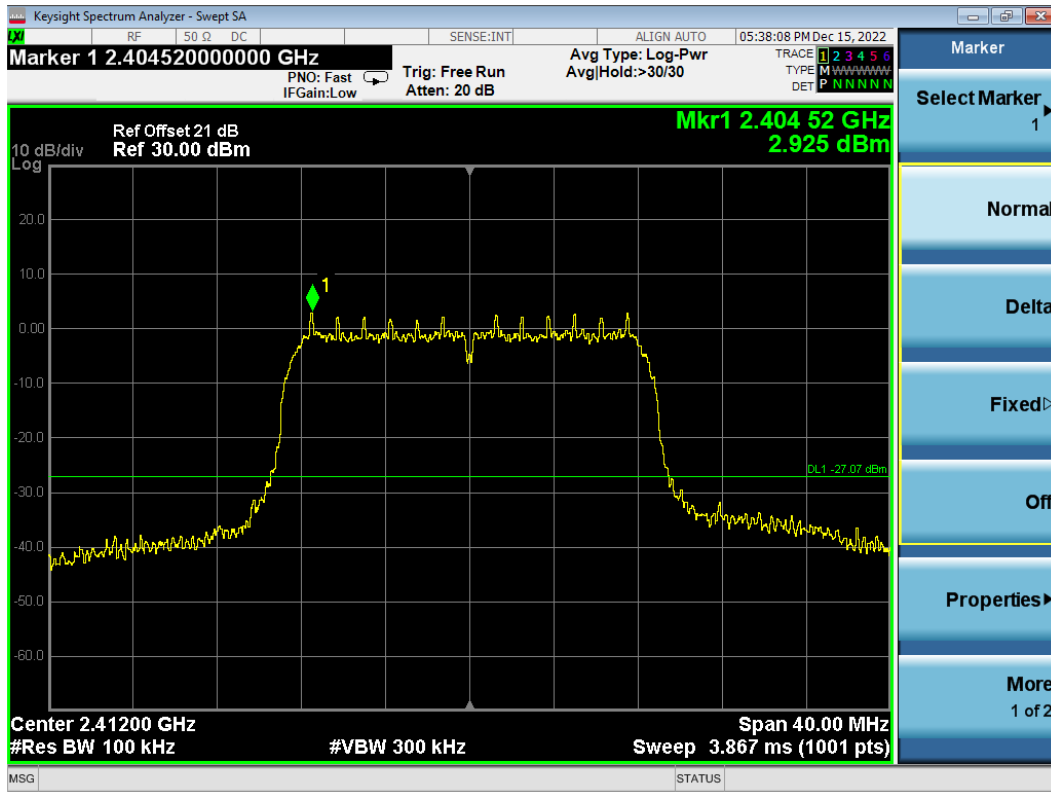

Emission level

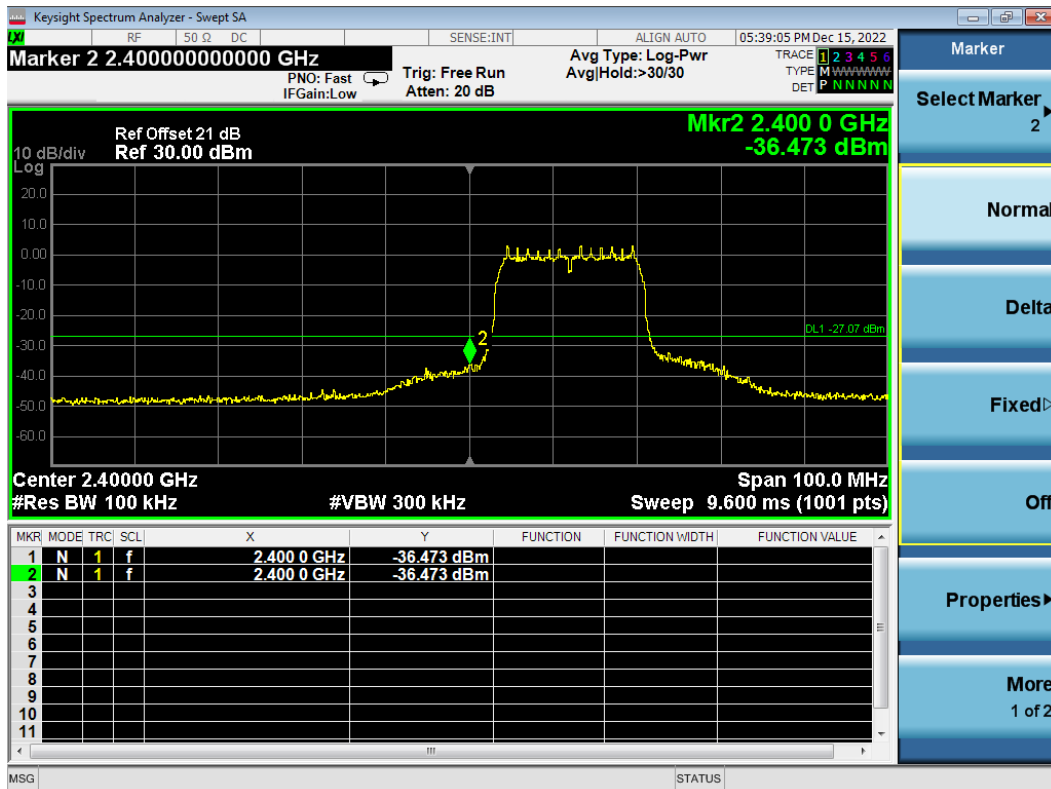

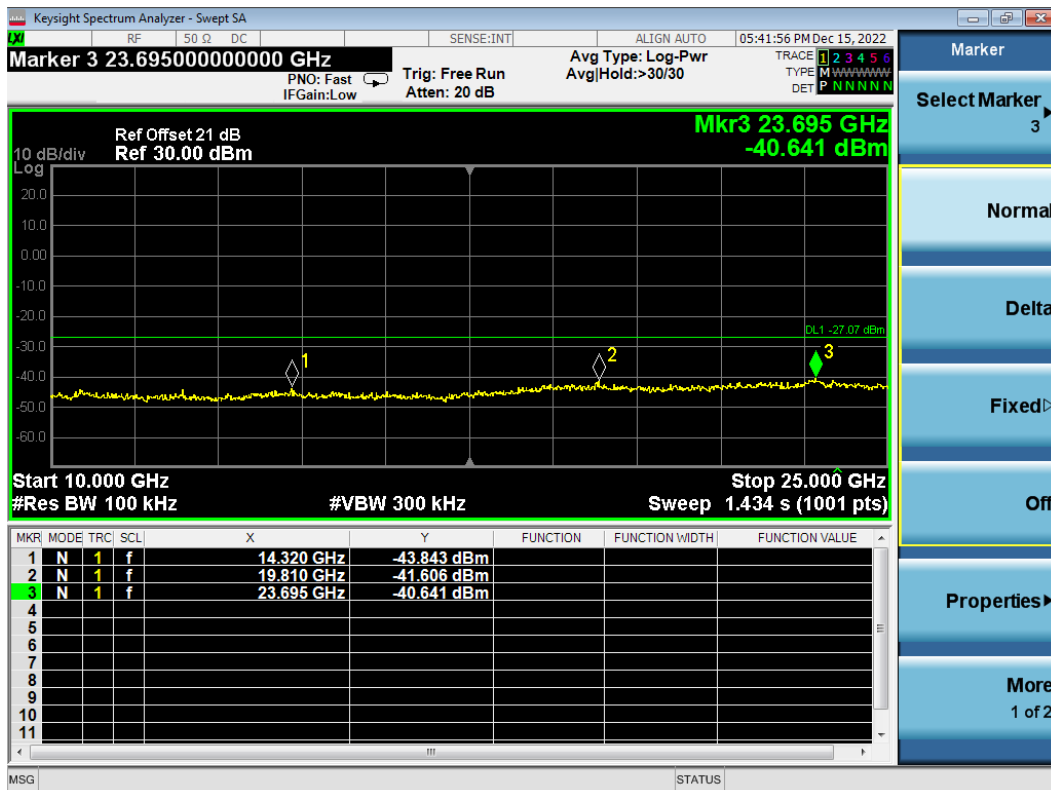
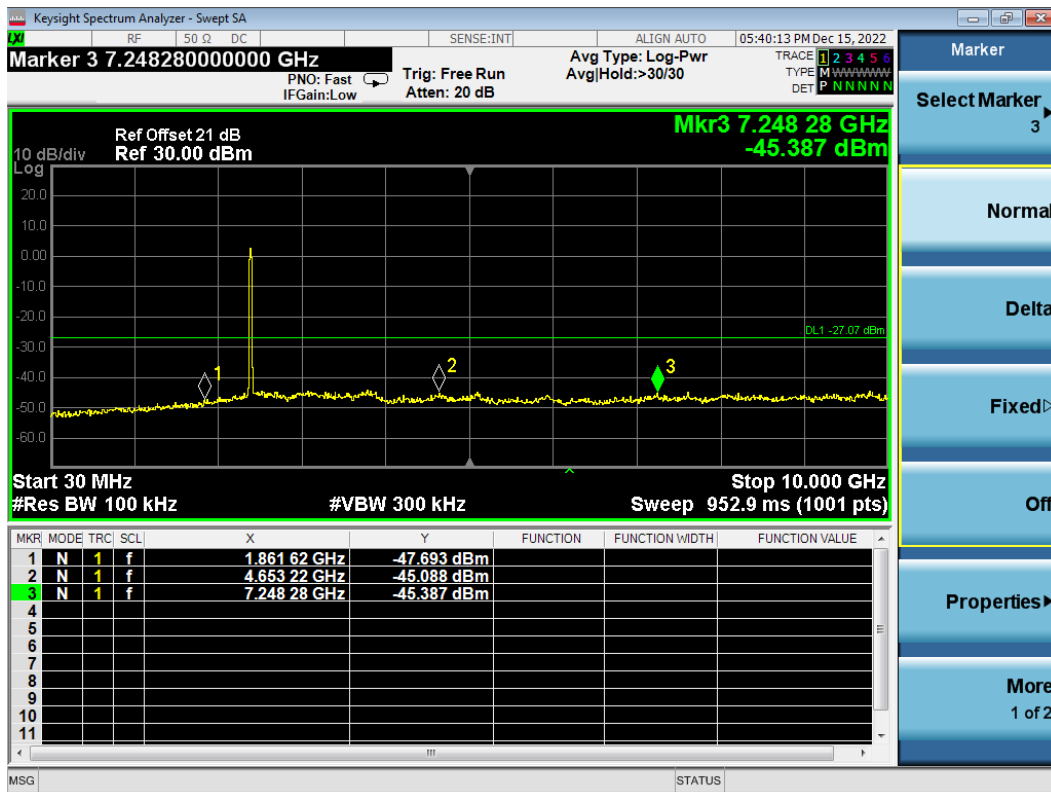

802.11n20 CH2437MHz

Reference level

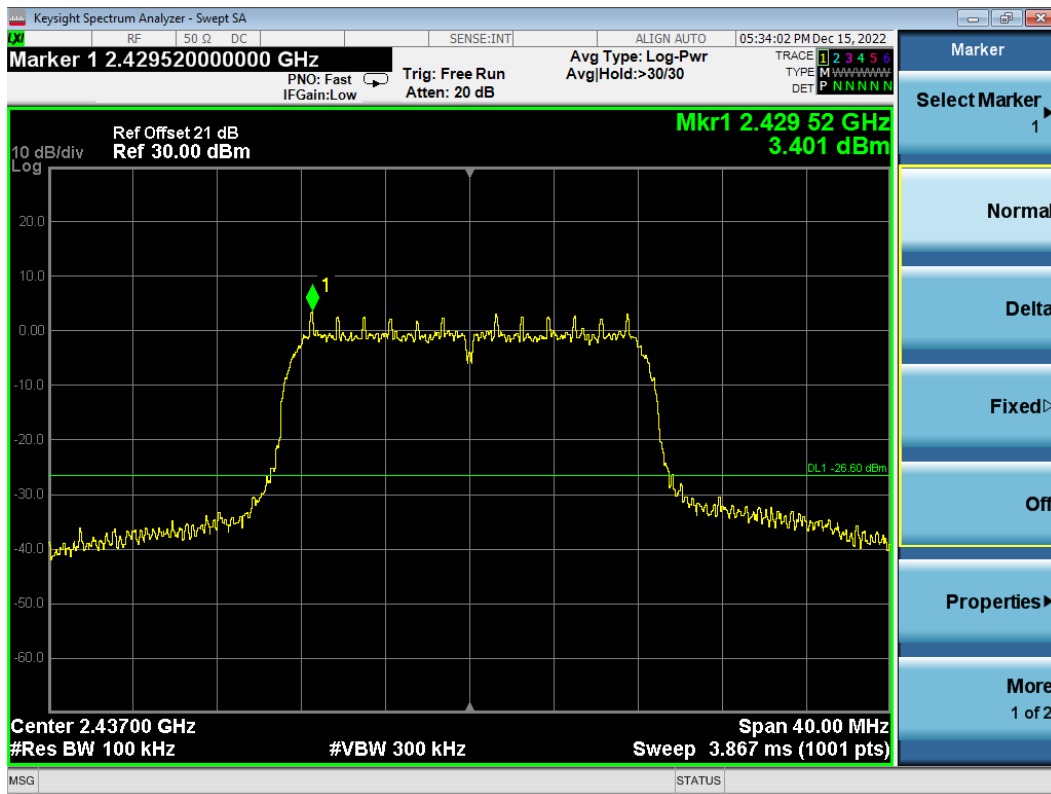

Emission level

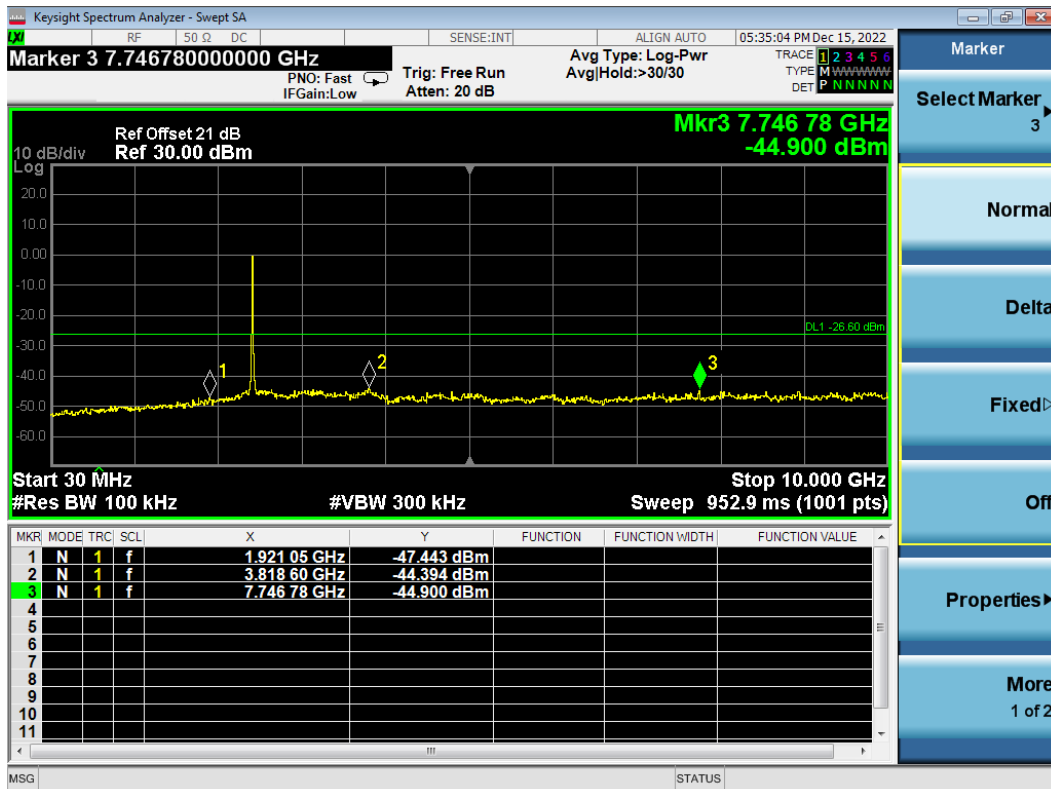

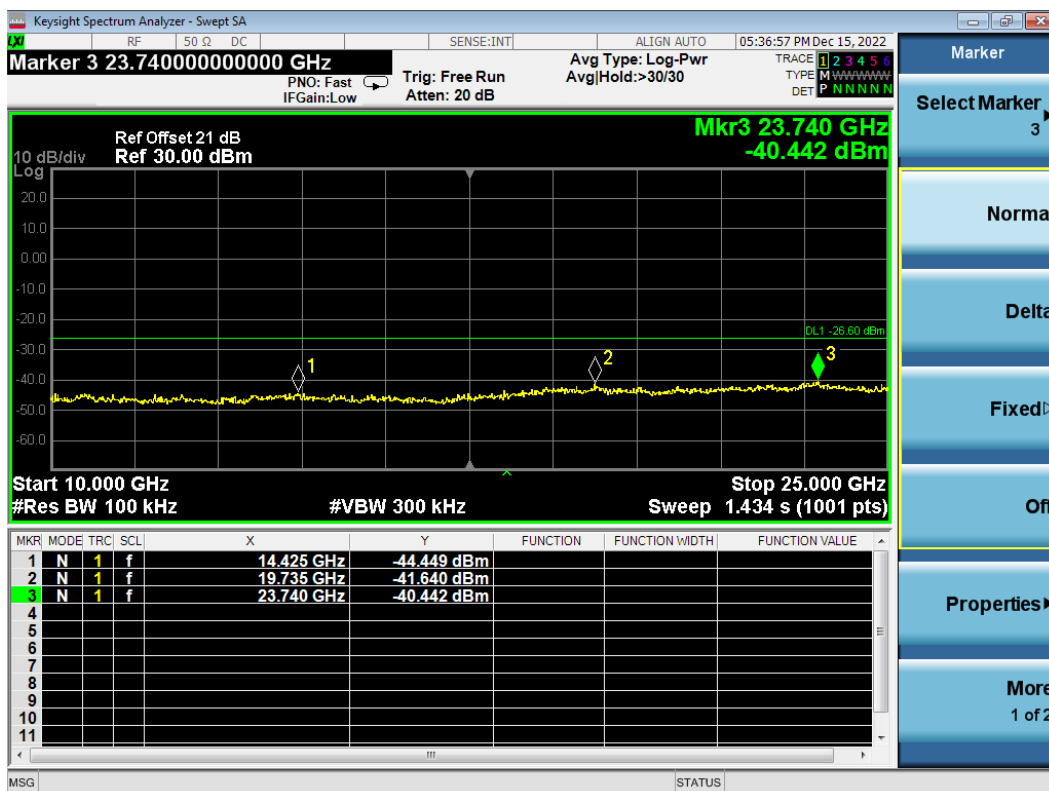

802.11n20 CH2462MHz

Reference level

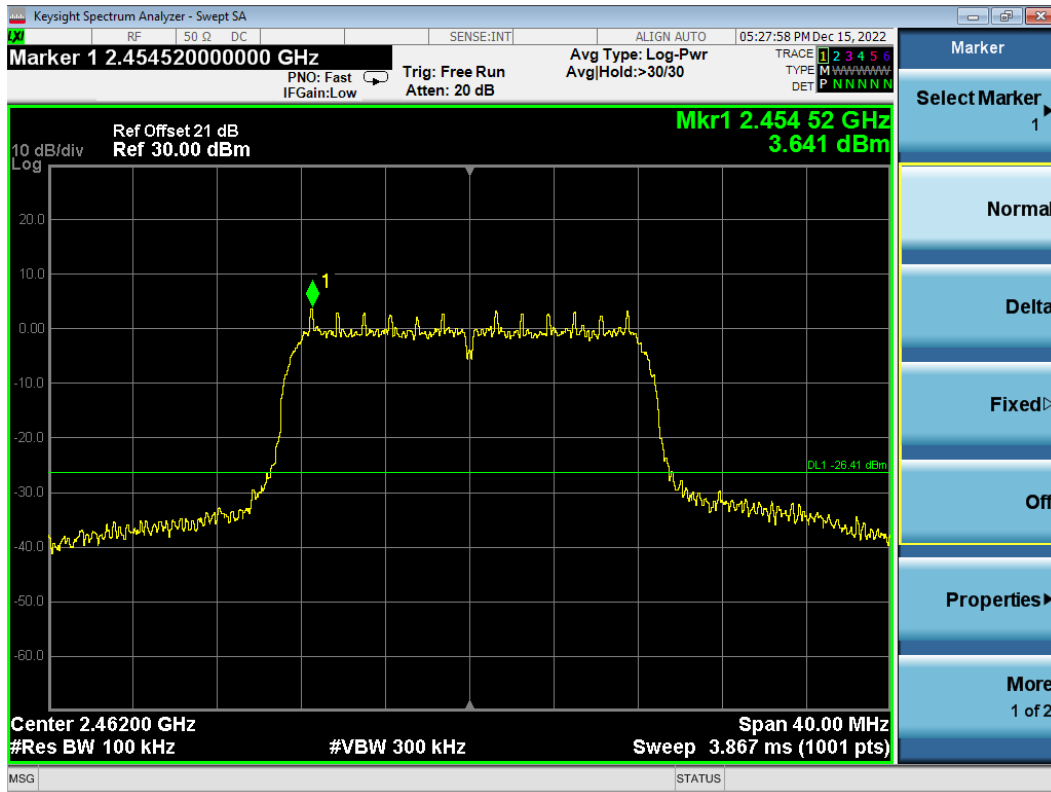

Emission level

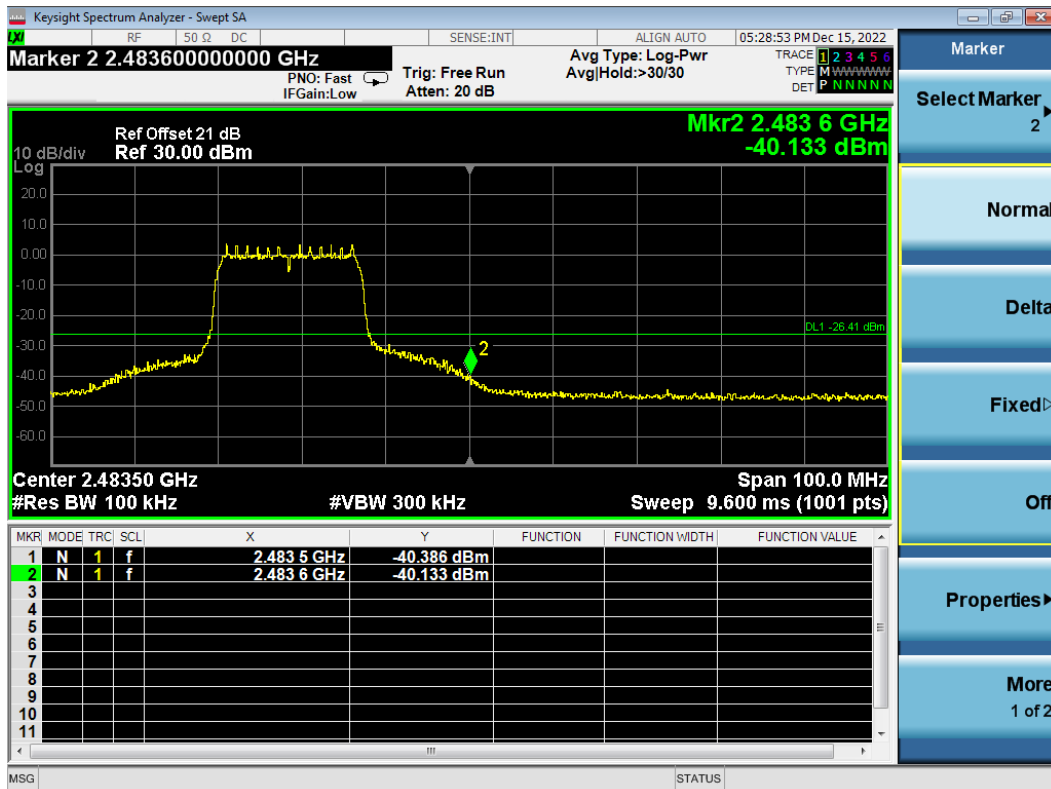

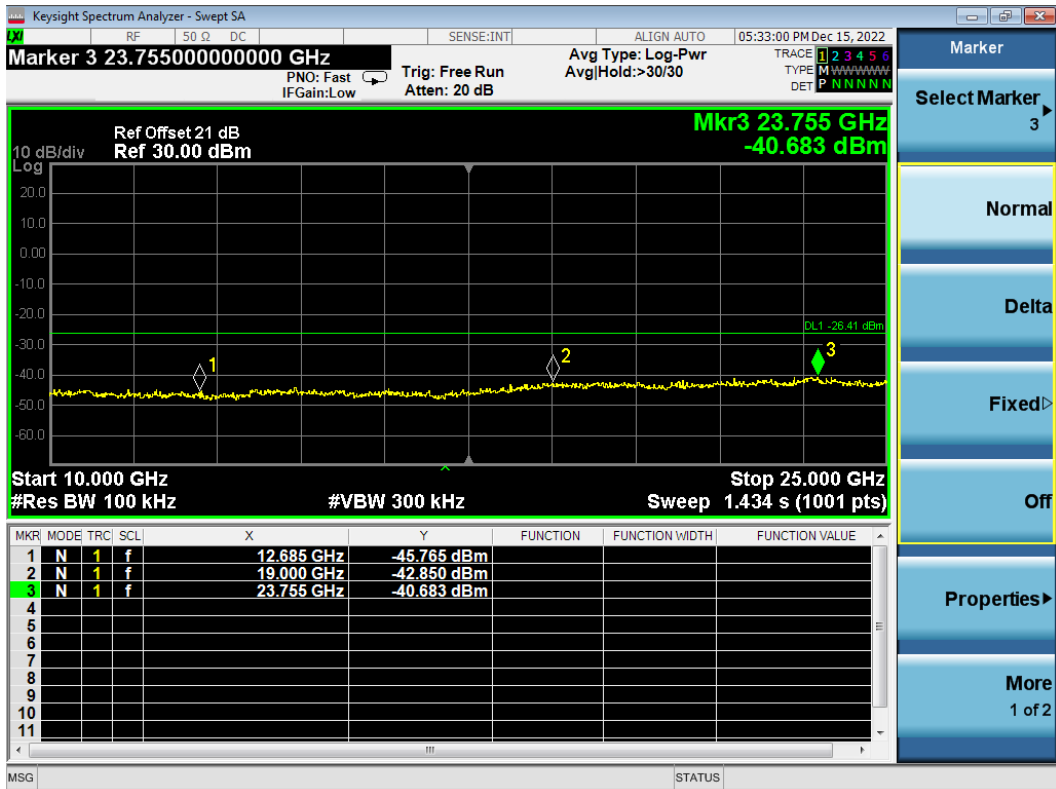
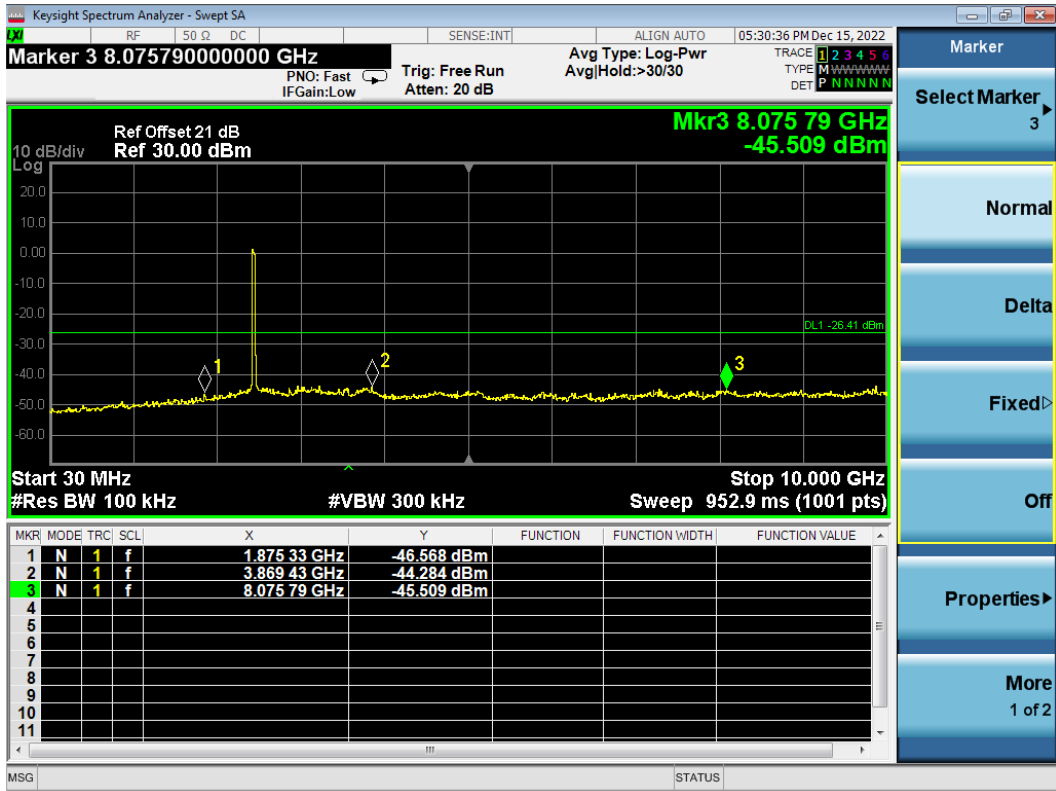

802.11n40 CH2422MHz

Reference level

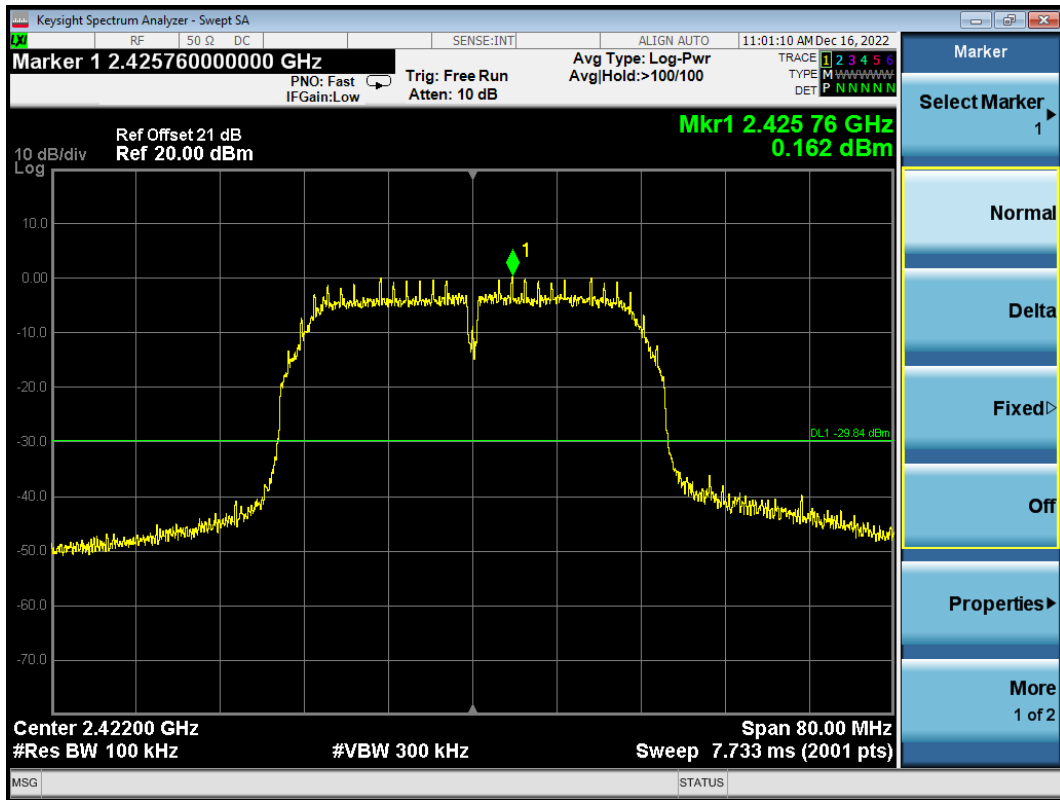

Emission level

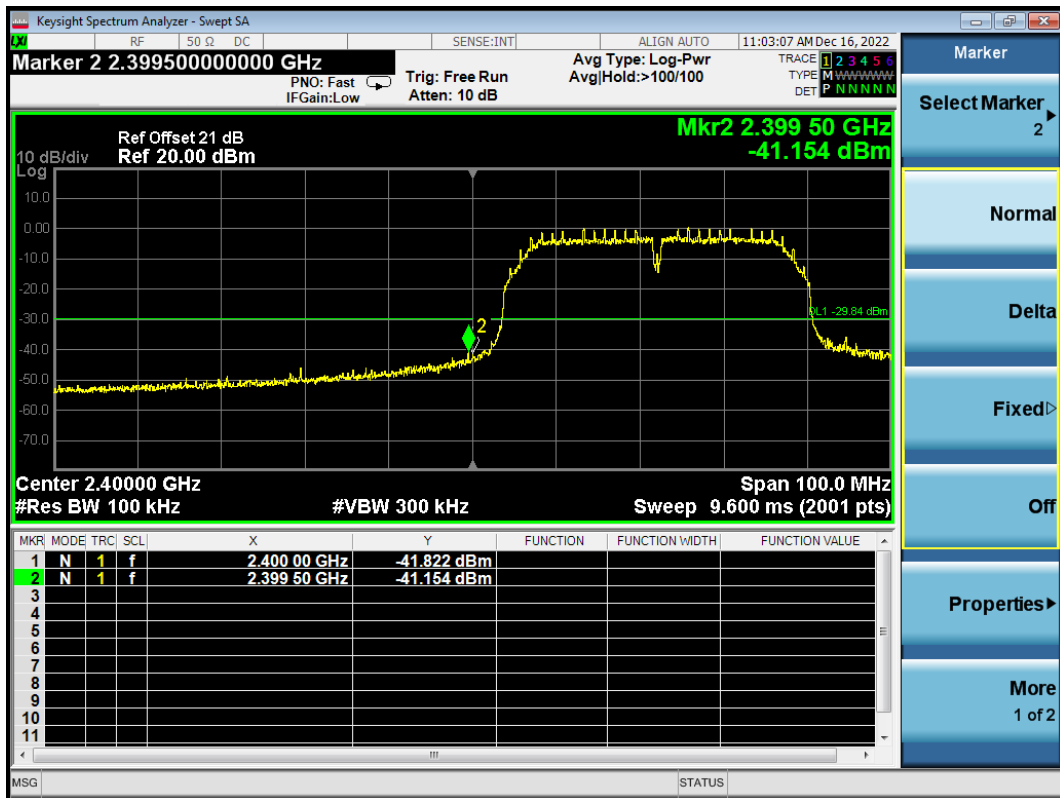

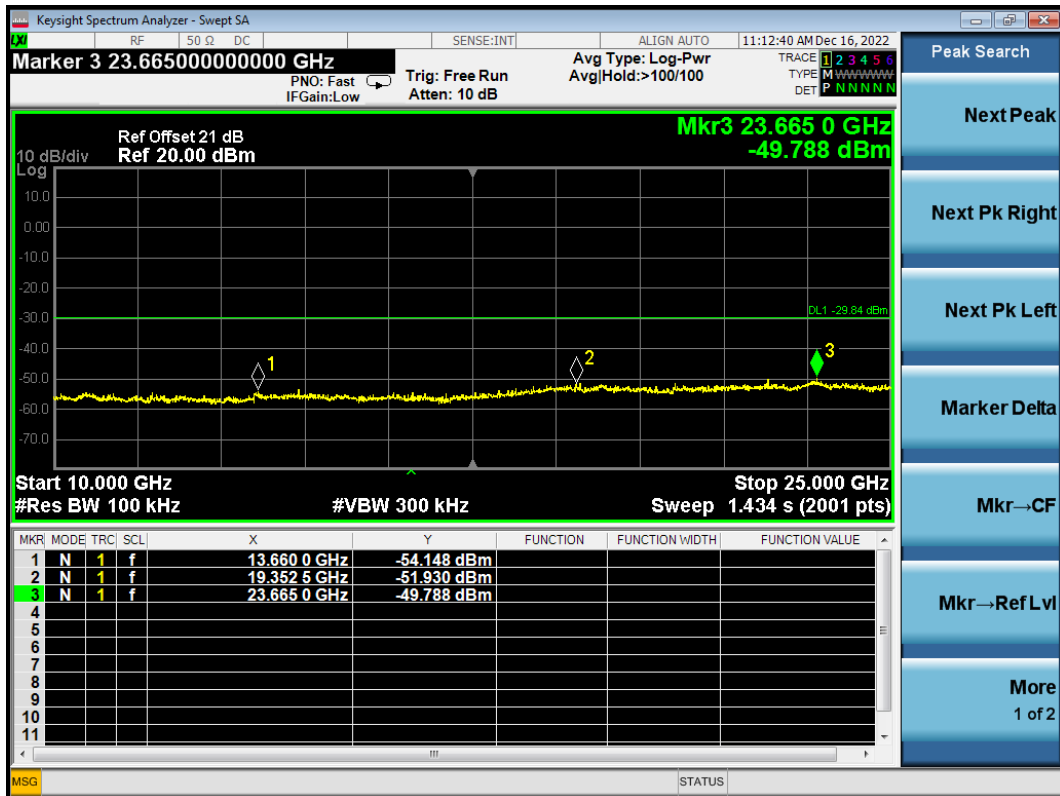
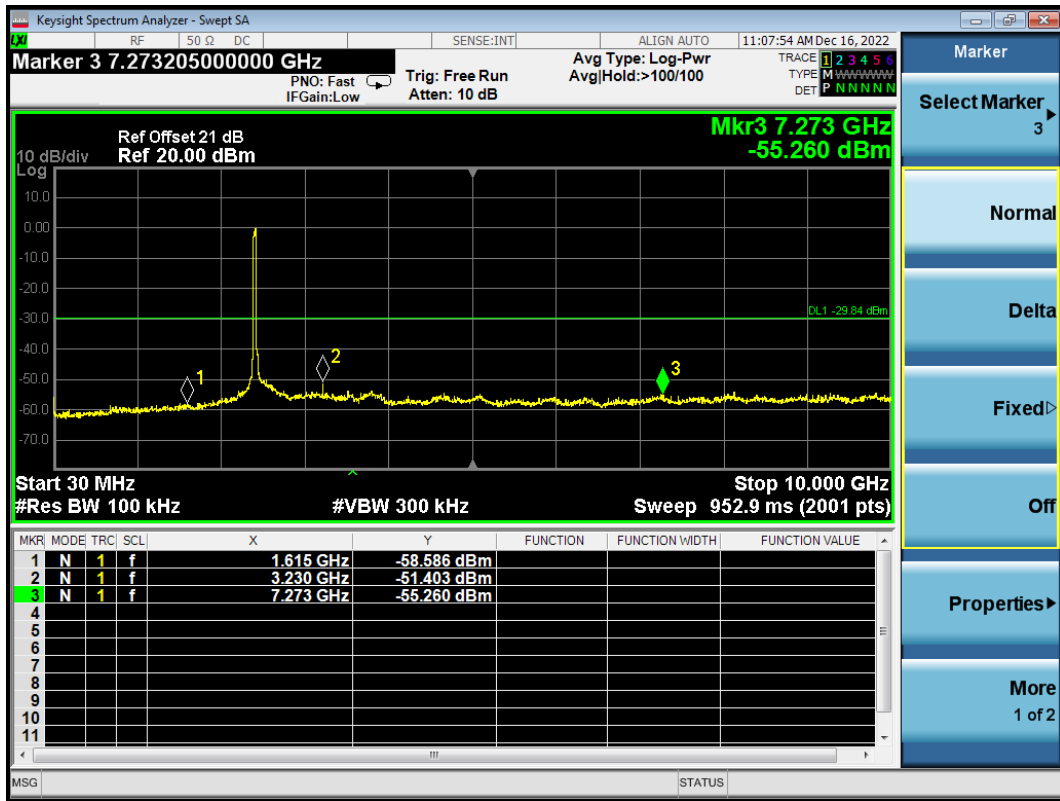

802.11n40 CH2437MHz

Reference level

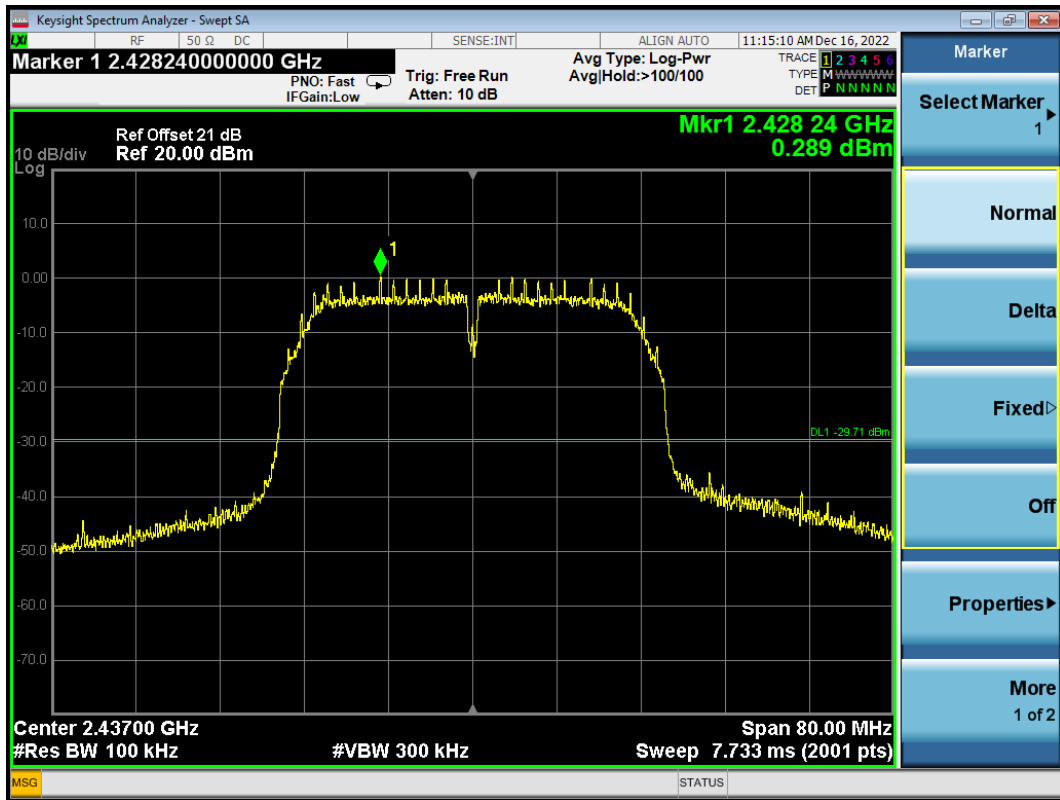

Emission level

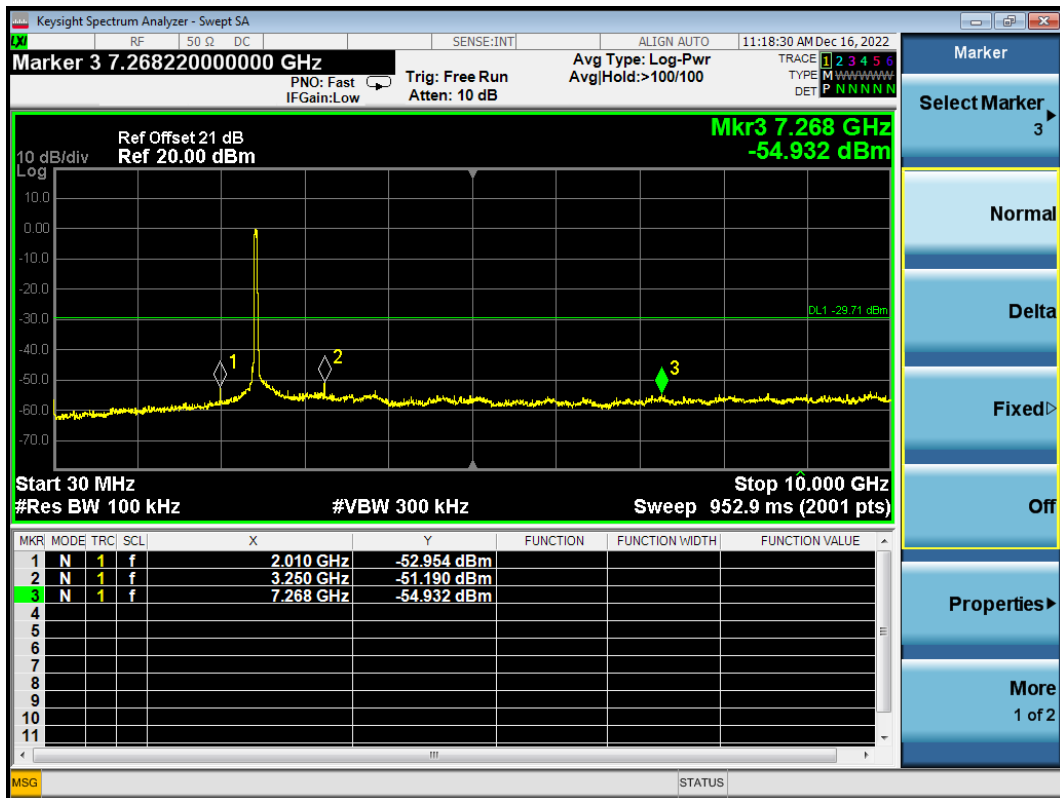

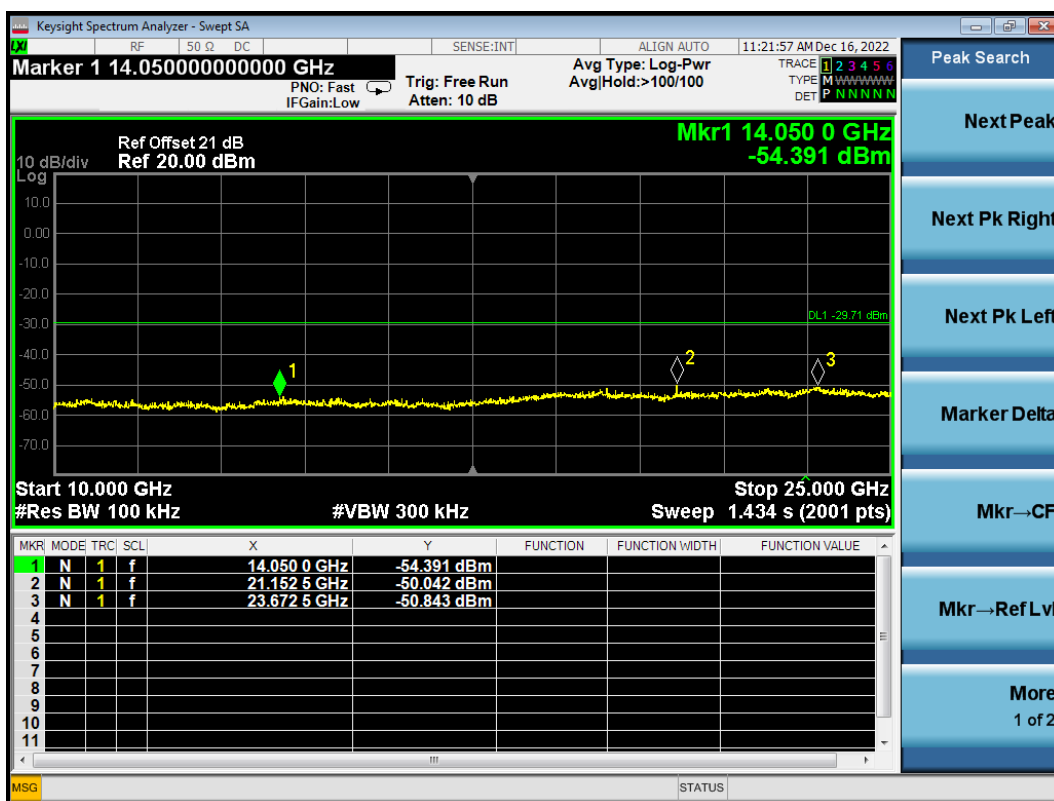

802.11n40 CH2452MHz

Reference level

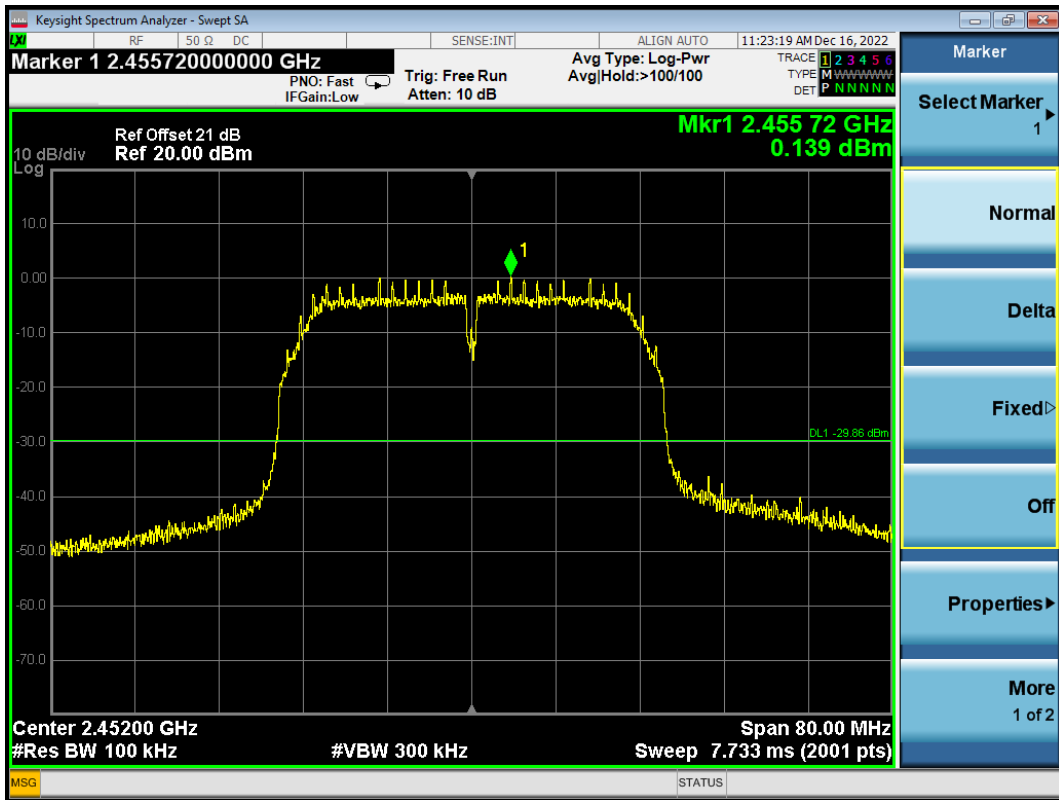

Emission level

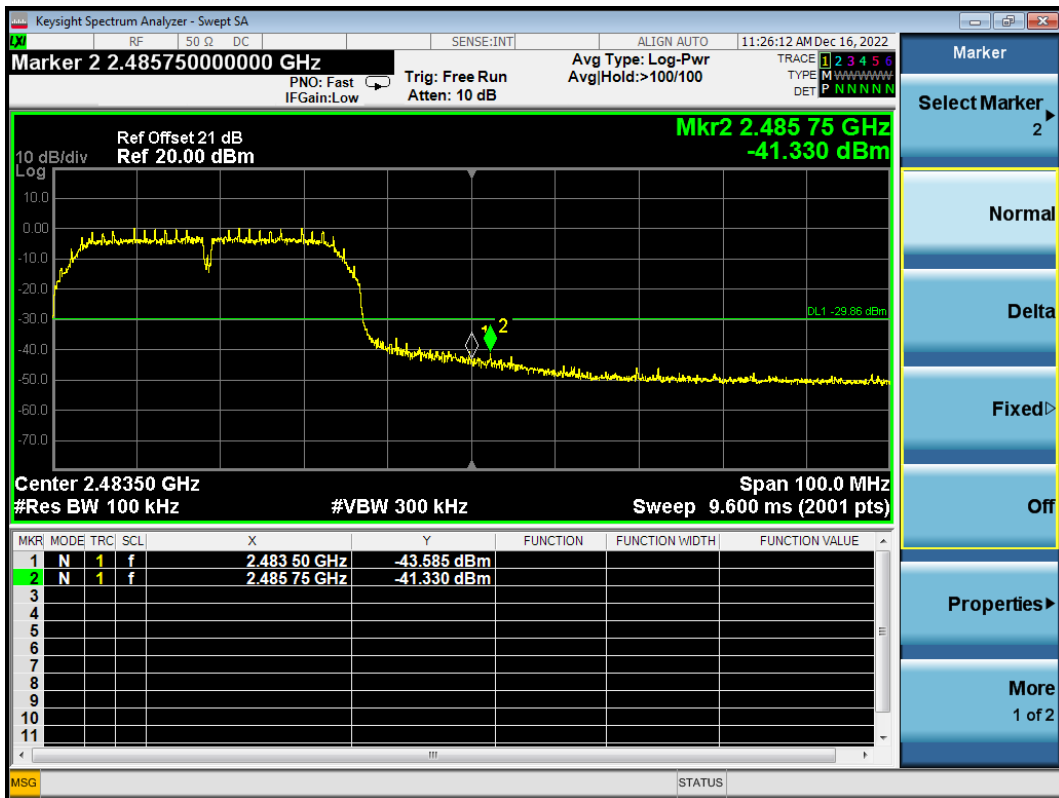

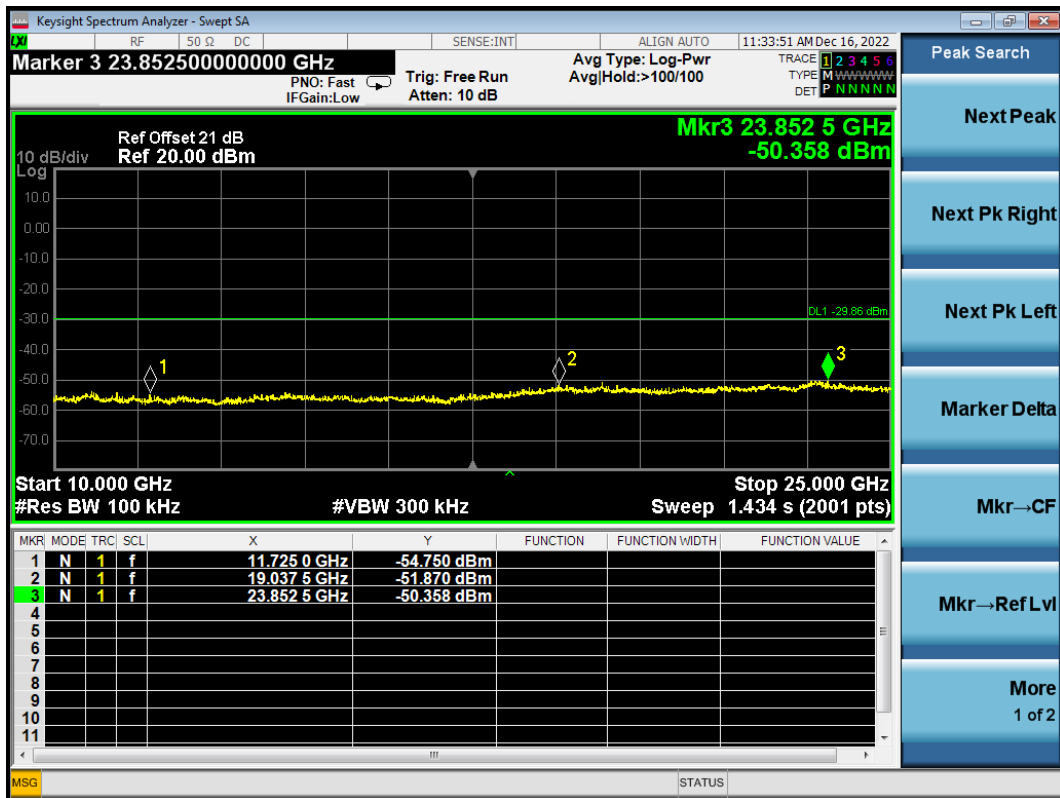
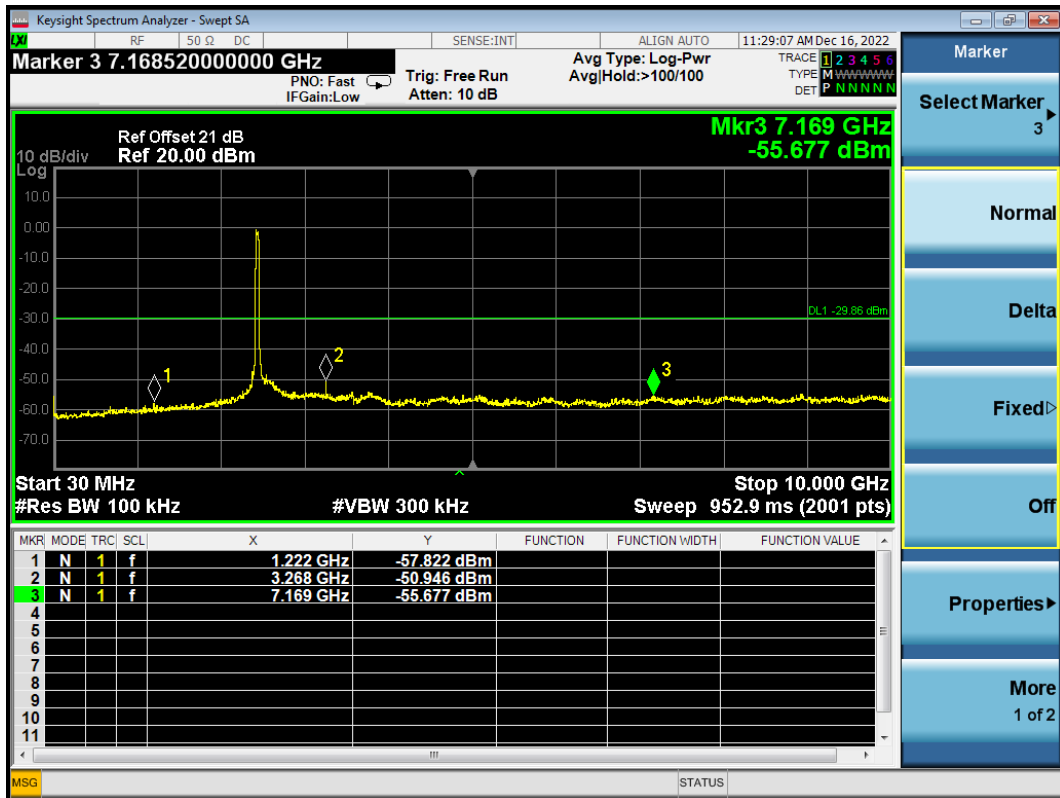

9 POWER SPECTRAL DENSITY MEASUREMENT

9.1 Test Equipment

The following test equipment was used during the power spectral density measurement:

Item	Type	Manufacturer	Model No.	Serial No.	Cal. Date	Cal. Interval
1.	Spectrum Analyzer	Agilent	N9010A	MY52221182	2022.09.15	1 Year
2.	Coaxial Cable	WOKEN	SFL402-105F LEX	F02-150819-045	2022.03.07	1 Year
3.	20 dB Attenuator	Mini-Circuits	VAT-20+	001	2022.08.06	1 Year

9.2 Block Diagram of Test Setup

The Same as section 5.2.

9.3 Specification Limits (§15.247(e))

The peak power spectral density conducted from the intentional radiator to the antenna shall not be greater than 8 dBm in any 3 kHz band.

9.4 Operating Condition of EUT

The software as section 2.3 was used to enable the EUT to change the test mode one by one.

9.5 Test Procedure

The transmitter output was connected to the spectrum analyzer.

- a) Set analyzer center frequency to DTS channel center frequency.
- b) Set the span to 1.5 times the DTS bandwidth.
- c) Set the RBW to $3 \text{ kHz} \leq \text{RBW} \leq 100 \text{ kHz}$.
- d) Set the VBW $\geq [3 \times \text{RBW}]$.
- e) Detector = peak.
- f) Sweep time = auto couple.
- g) Trace mode = max hold.
- h) Allow trace to fully stabilize.
- i) Use the peak marker function to determine the maximum amplitude level within the RBW.
- j) If measured value exceeds requirement, then reduce RBW (but no less than 3 kHz) and repeat.

The test procedure is defined in ANSI C63.10-2013 (11.10.2 Measurement Procedure “Method PKPSD (peak PSD)” was used).

9.6 Test Results

PASSED.

All the test results are attached in next pages.

(Test Date: 2022.12.15 Temperature: 23°C Humidity: 51 %)

Modulation	Channel	Frequency (MHz)	Power Spectral Density (dBm)	Limit
802.11b	1	2412	-7.209	8 dBm
	6	2437	-6.03	8 dBm
	11	2462	-5.963	8 dBm
802.11g	1	2412	-10.497	8 dBm
	6	2437	-10.276	8 dBm
	11	2462	-9.931	8 dBm
802.11n20	1	2412	-10.887	8 dBm
	6	2437	-11.045	8 dBm
	11	2462	-10.507	8 dBm
802.11n40	3	2422	-12.942	8 dBm
	6	2437	-13.168	8 dBm
	9	2452	-13.196	8 dBm

802.11b CH2412 MHz



802.11b CH2437 MHz



802.11b CH2462 MHz



802.11g CH2412 MHz

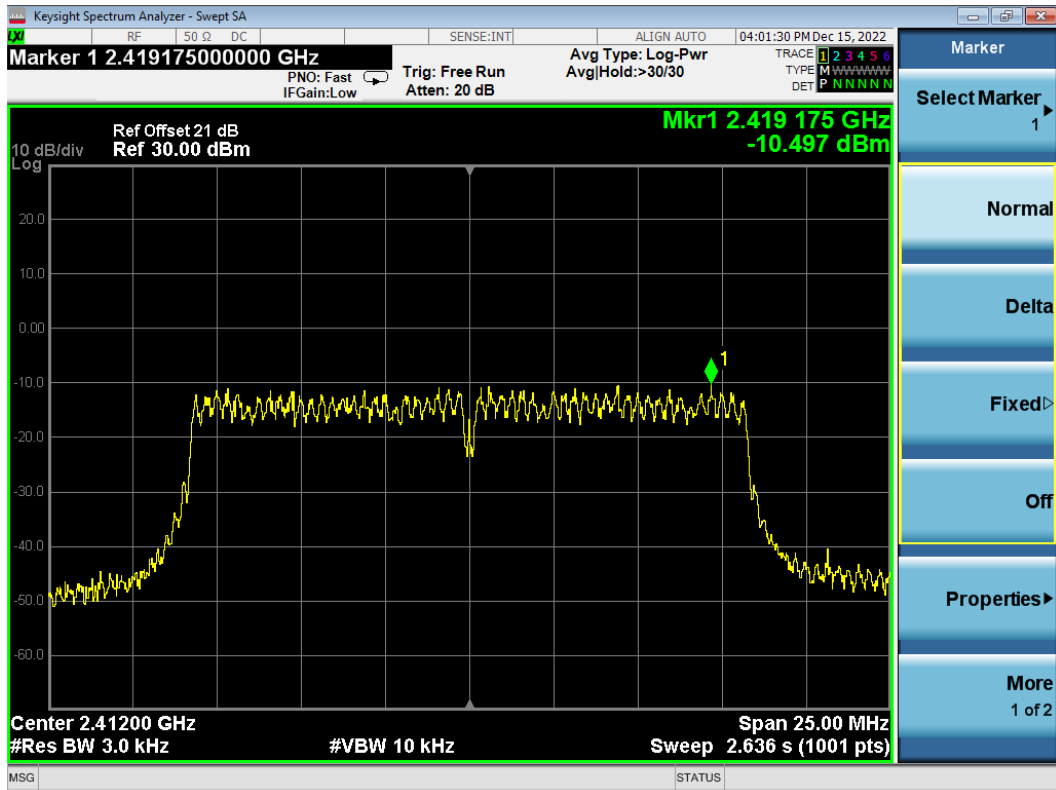

802.11g CH2437 MHz

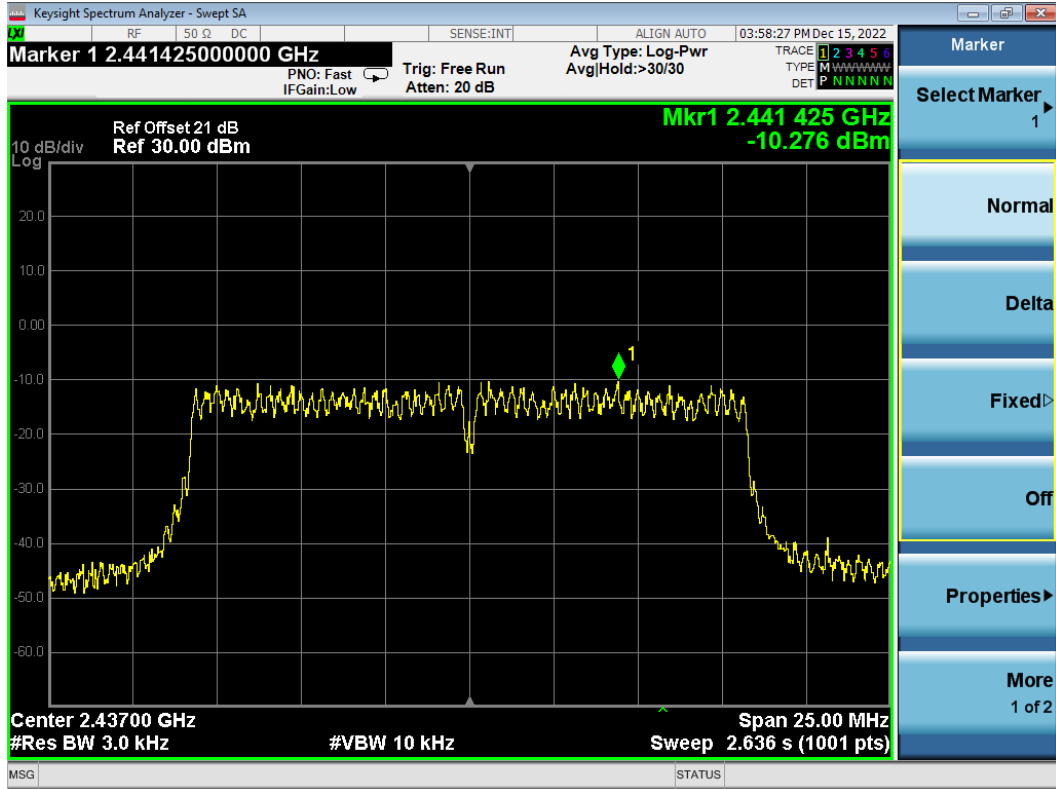

802.11g CH2462 MHz

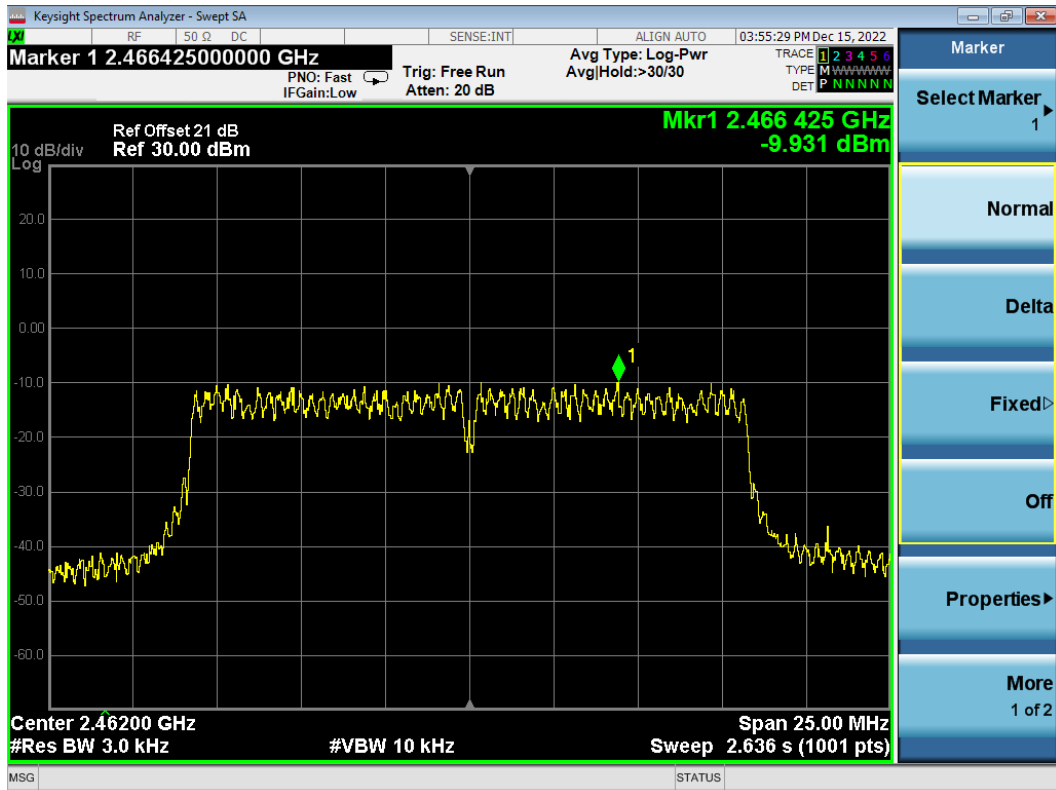

802.11n20 CH2412 MHz

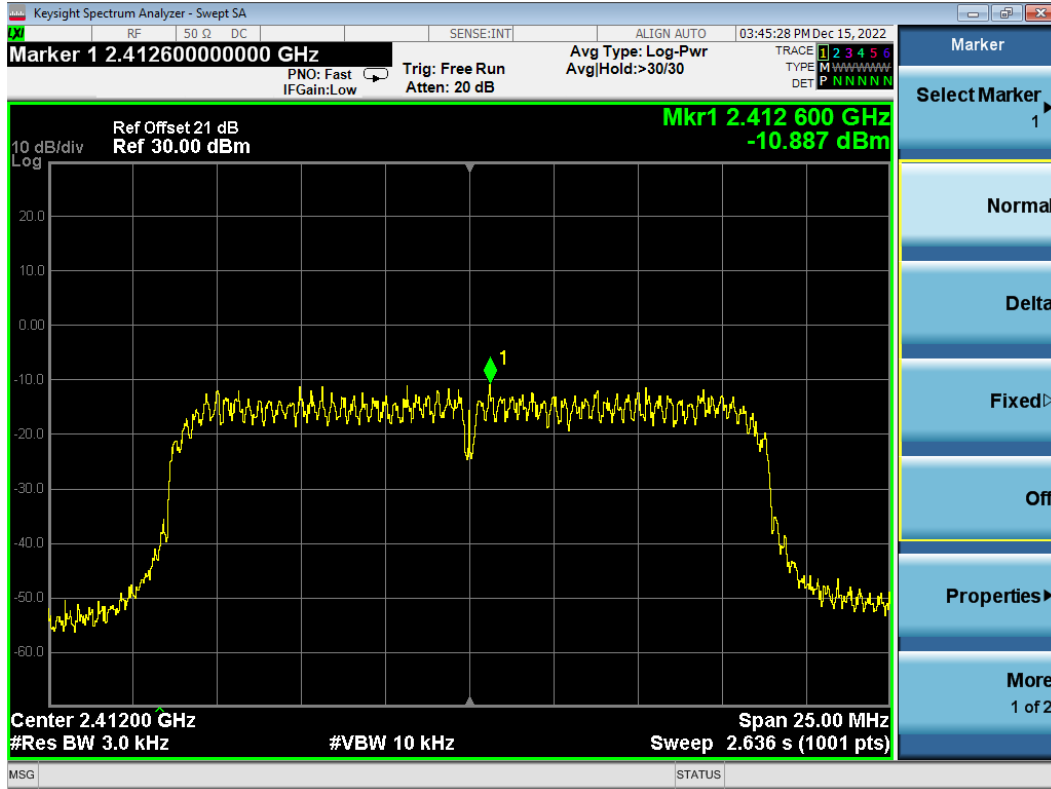

802.11n20 CH2437 MHz

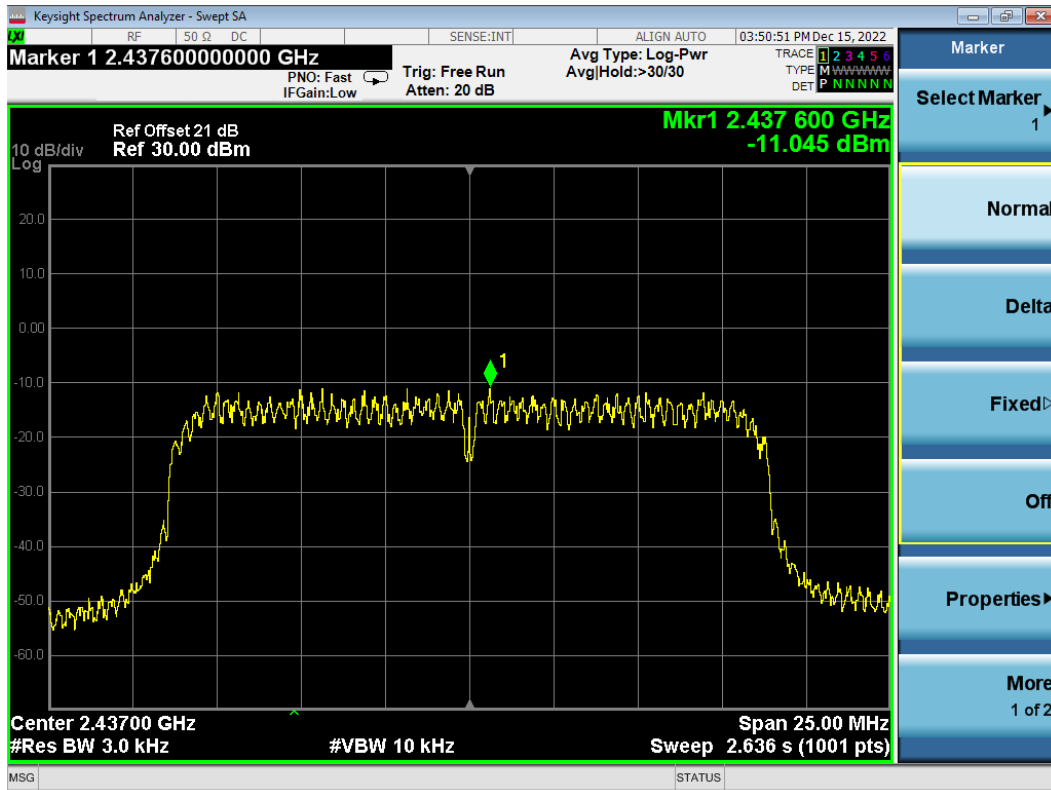

802.11n20 CH2462 MHz

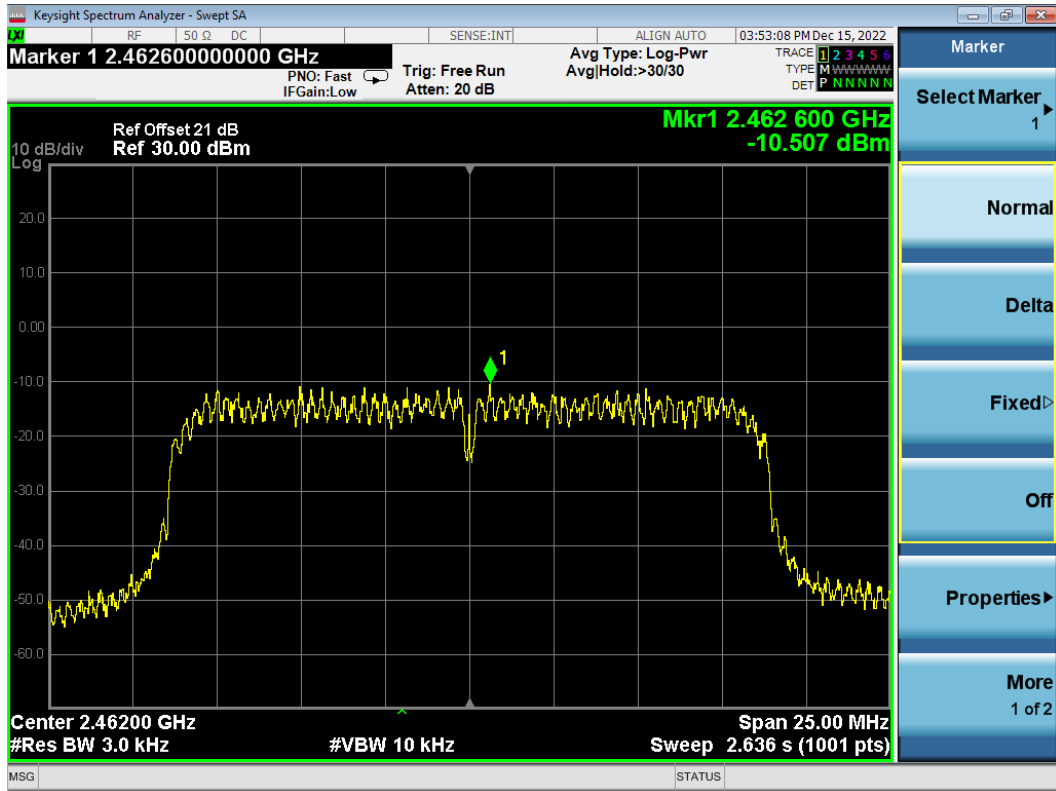

802.11n40 CH2422 MHz

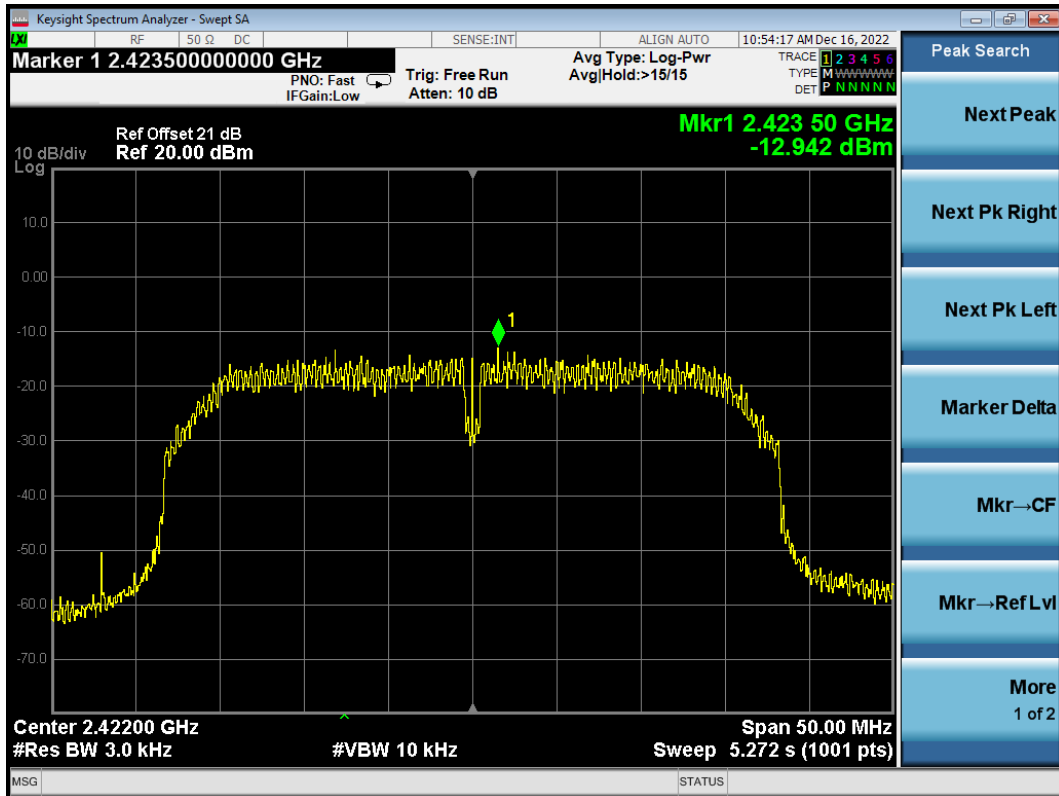

802.11n40 CH2437 MHz

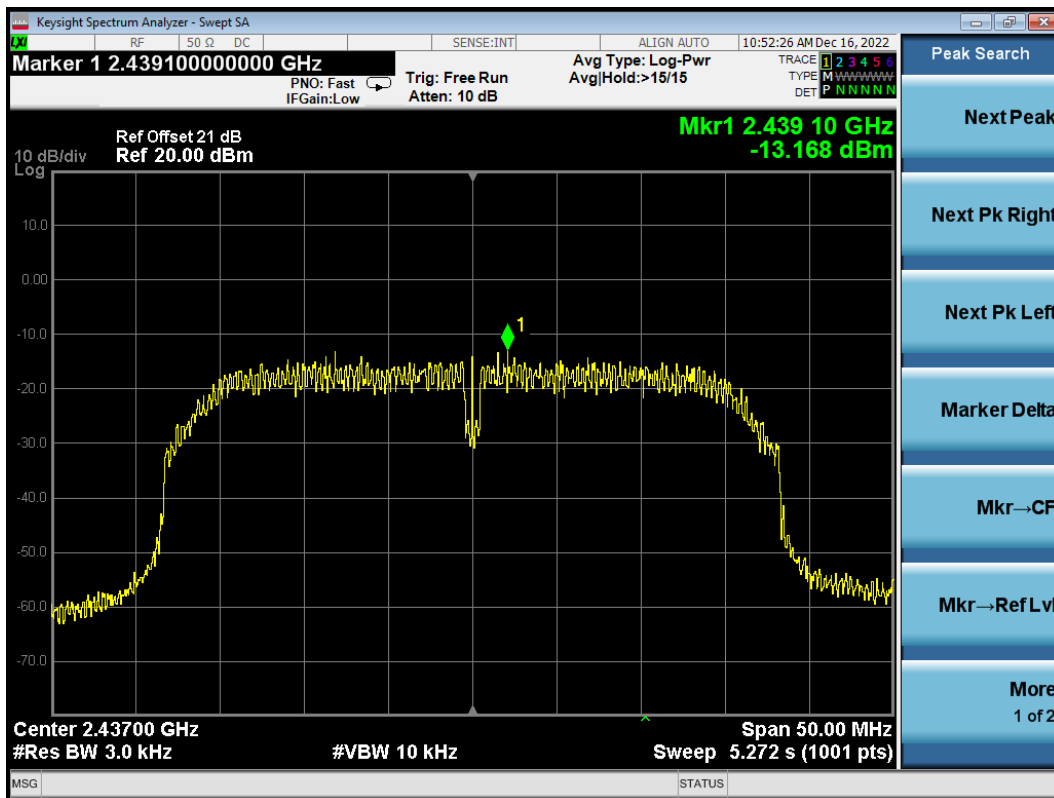

802.11n40 CH2452 MHz

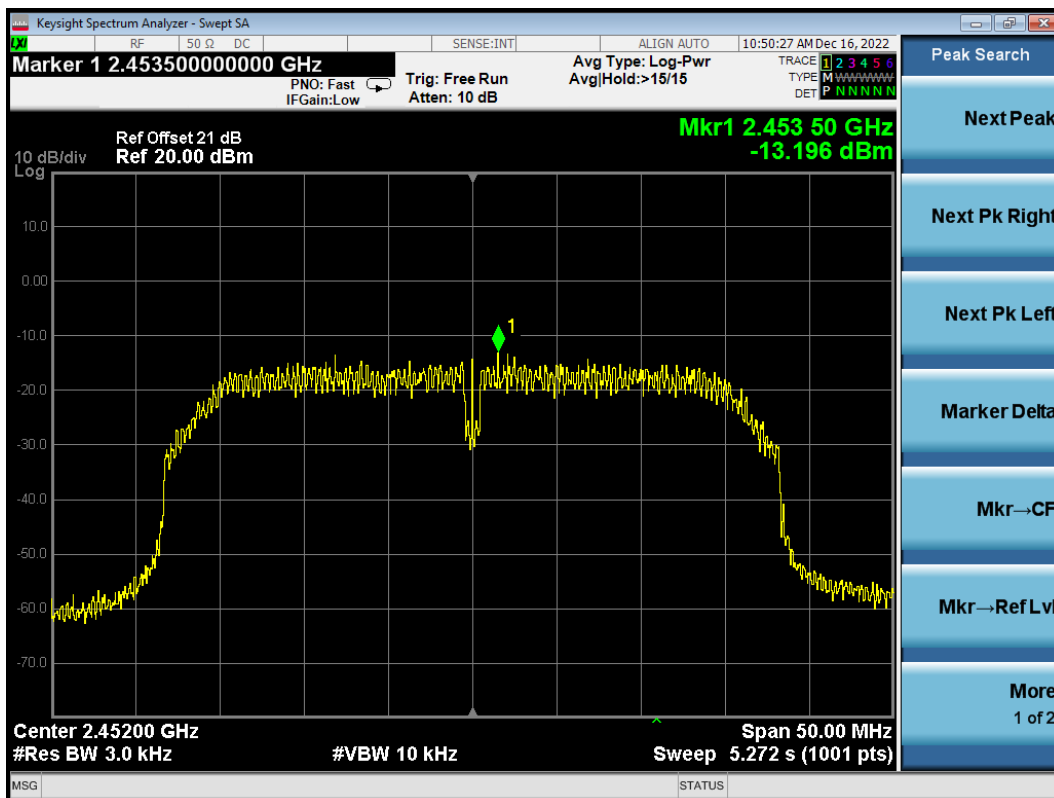

10 ANTENNA REQUIREMENT

10.1 Specification Limits (§15.203)

An intentional radiator shall be designed to ensure that no antenna other than that furnished by the responsible party shall be used with the device.

10.2 Result

According to KDB 353028 D1, the following describes the three ways that can be used to demonstrate compliance to Section 15.203:

- a) Antenna permanently attached.
- b) Unique (non-standard) antenna connector.
- c) Professional installation.

For this product, the antenna is:

- Antenna permanently attached
- Unique (non-standard) antenna connector
- Professional installation
- not meet any of ways list above

that

- compliant
- not compliant

with the requirement of Section 15.203.

11 DEVIATION TO TEST SPECIFICATIONS

None.

12 MEASUREMENT UNCERTAINTY LIST

The measurement uncertainty was estimated for test on the EUT according to CISPR 16-4-2. This uncertainty represents an expanded uncertainty expressed at approximately the 95% confidence level using a coverage of K=2.

The uncertainties value is not used in determining the PASS/FAIL results.

Test Items/Facilities	Frequency/Equipment/Unit	Uncertainty
Conducted Emission No.1 Shielded Room	9kHz~150kHz	±3.1 dB
	150kHz~30MHz	±2.6 dB
Conducted Emission No.3 Shielded Room	9kHz~150kHz	±3.1 dB
	150kHz~30MHz	±2.6 dB
Radiated Emission	30MHz~200MHz, Horizontal	±3.8 dB
	30MHz~200MHz, Vertical	±4.1 dB
	200MHz~1000MHz, Horizontal	±3.6 dB
	200MHz~1000MHz, Vertical	±5.1 dB
	1GHz~6GHz	±5.3 dB
	6GHz~18GHz	±5.3 dB
	18GHz~40GHz	±3.5 dB
Output Power Test	50MHz~18GHz	0.77 dB
Power Density Test	9kHz~6GHz	1.08 dB
RF Frequency Test	9kHz~40GHz	6×10^{-4}
Bandwidth Test	9kHz~6GHz	1.5×10^{-3}
RF Radiated Power Test	30MHz~1000MHz	3.06 dB
Conducted Output Power Test	50MHz~18GHz	0.83 dB
AC Voltage(<10kHz) Test	120V~230V	0.04 %
DC Power Test	0V~30V	0.4 %
Temperature	-40°C~+100°C	0.52 °C
Humidity	30%~95%	2.6 %