

TEST REPORT
On behalf of

Savant Technologies LLC, dba GE Lighting, a Savant company

Product Name: Direct connect Full Color A19

Model No.: CLEDA199CD1

FCC ID: PUU-A19-DMFCIV

Prepared For: Savant Technologies LLC, dba GE Lighting, a Savant company
1975 Noble Road, Cleveland, OH 44112

Prepared By: Audix Technology (Shanghai) Co., Ltd.
3F and 4F, 34Bldg, 680 Guiping Rd.,
Caohejing Hi-Tech Park,
Shanghai 200233, China

Tel: +86-21-64955500



File No. : C1D2109048
Report No. : ACI-F21205
Date of Test : 2021.09.17-22
Date of Report : 2021.09.30

The statement is based on a single evaluation of one sample of the above-mentioned products. It does not imply an assessment of the whole production and does not permit the use of the test lab logo. The report must not be used by the client to claim product certification, approval, or endorsement by NVLAP, NIST, or any agency of the Federal Government.

TABLE OF CONTENTS

	Page
1 SUMMARY OF STANDARDS AND RESULTS.....	5
1.1 Description of Standards and Results.....	5
2 GENERAL INFORMATION.....	6
2.1 Description of Equipment Under Test.....	6
2.2 EUT Specifications Assessed in Current Report.....	7
2.3 Test Information.....	7
2.4 Sample Description.....	7
2.5 Supported equipment.....	8
2.6 Description of Test Facility.....	8
3 CONDUCTED EMISSION TEST.....	9
3.1 Test Equipment.....	9
3.2 Block Diagram of Test Setup.....	9
3.3 Conducted Emission Limits (§15.207).....	10
3.4 Test Configuration.....	10
3.5 Operating Condition of EUT.....	10
3.6 Test Procedures.....	10
3.7 Test Results.....	11
4 RADIATED EMISSION TEST.....	13
4.1 Test Equipment.....	13
4.2 Block Diagram of Test Setup.....	13
4.3 Radiated Emission Limit (§15.209).....	14
4.4 Test Configuration.....	14
4.5 Operating Condition of EUT.....	15
4.6 Test Procedures.....	15
4.7 Test Results.....	16
5 6 DB BANDWIDTH MEASUREMENT.....	29
5.1 Test Equipment.....	29
5.2 Block Diagram of Test Setup.....	29
5.3 Specification Limits (§15.247(a)(2)).....	29
5.4 Operating Condition of EUT.....	29
5.5 Test Procedure.....	29
5.6 Test Results.....	30
6 MAXIMUM PEAK OUTPUT POWER MEASUREMENT.....	36
6.1 Test Equipment.....	36
6.2 Block Diagram of Test Setup.....	36
6.3 Specification Limits ((§15.247(b)(3)).....	36
6.4 Operating Condition of EUT.....	36
6.5 Test Procedure.....	36
6.6 Test Results.....	37
7 EMISSION LIMITATIONS MEASUREMENT.....	43
7.1 Test Equipment.....	43
7.2 Block Diagram of Test Setup.....	43
7.3 Specification Limits (§15.247(d)).....	43

7.4 Operating Condition of EUT 43

7.5 Test Procedure 43

7.6 Test Results 45

8 BAND EDGES MEASUREMENT 64

8.1 Test Equipment..... 64

8.2 Block Diagram of Test Setup 64

8.3 Specification Limits (§15.247(d)) 64

8.4 Operating Condition of EUT 64

8.5 Test Procedure 64

8.6 Test Results 65

9 POWER SPECTRAL DENSITY MEASUREMENT 71

9.1 Test Equipment..... 71

9.2 Block Diagram of Test Setup 71

9.3 Specification Limits (§15.247(e)) 71

9.4 Operating Condition of EUT 71

9.5 Test Procedure 71

9.6 Test Results 72

10 DEVIATION TO TEST SPECIFICATIONS 78

11 MEASUREMENT UNCERTAINTY LIST 79

TEST REPORT

Applicant : Savant Technologies LLC, dba GE Lighting, a Savant company
 EUT Description : Direct connect Full Color A19
 (A) Model No. : CLEDA199CD1
 (B) Power Supply : 120V AC 60Hz
 (C) Test Voltage : 120V/60Hz

Test Procedure Used:

*FCC RULES AND REGULATIONS PART 15 SUBPART C
 AND ANSI C63.10-2013*

The device described above is tested by Audix Technology (Shanghai) Co., Ltd. to determine the maximum emission levels emanating from the device. The maximum emission levels are compared to the FCC Part 15 Subpart C limits.

The test results are contained in this test report and Audix Technology (Shanghai) Co., Ltd. is assumed full responsibility for the accuracy and completeness of these measurements. This report also shows that the EUT (M/N: Refer to Sec2.1), which was tested is technically compliance with the FCC limits.

This report applies to above tested Sample only. This report shall not be reproduced in part without written approval of Audix Technology (Shanghai) Co., Ltd.

The test results for EUT's BLE function are contained in No.ACI-F21204 report.

Date of Test : 2021.09.17-22 Date of Report : 2021.09.30

Producer : Alan He
 ALAN HE / Assistant

Review : Byron Wu
 BYRON WU/ Deputy Assistant Manager

AUDIX® For and on behalf of
 Audix Technology (Shanghai) Co., Ltd.

Signatory : Byron Kwo
 BYRON KWO/Assistant General Manager

.....
 Authorized Signature(s)

1 SUMMARY OF STANDARDS AND RESULTS

1.1 Description of Standards and Results

The EUT have been tested according to the applicable standards as referenced below:

Description / Test Item	Test Standard	Results	Meets Limit
EMISSION			
Conducted Emission	FCC RULES AND REGULATIONS PART 15 SUBPART C AND ANSI C63.10:2013	Pass	15.207
Radiated Emission	FCC RULES AND REGULATIONS PART 15 SUBPART C AND ANSI C63.10:2013	Pass	15.209(a) 15.205(a)(c)
6 dB Bandwidth Measurement	FCC RULES AND REGULATIONS PART 15 SUBPART C AND ANSI C63.10:2013	Pass	15.247(a)(2)
Maximum Peak Output Power Measurement	FCC RULES AND REGULATIONS PART 15 SUBPART C AND ANSI C63.10:2013	Pass	15.247(b)(3)
Emission Limitations Measurement	FCC RULES AND REGULATIONS PART 15 SUBPART C AND ANSI C63.10:2013	Pass	15.247(d)
Band Edge Measurement	FCC RULES AND REGULATIONS PART 15 SUBPART C AND ANSI C63.10:2013	Pass	15.247(d)
Power Spectral Density Measurement	FCC RULES AND REGULATIONS PART 15 SUBPART C AND ANSI C63.10:2013	Pass	15.247(e)
N/A is an abbreviation for Not Applicable.			

2 GENERAL INFORMATION

2.1 Description of Equipment Under Test

Description : Direct connect Full Color A19

Type of EUT : Production Pre-product Pro-type

Model Number : CLEDA199CD1

Radio Tech : BLE 4.2;
IEEE 802.11 b/g/n.

Note: : 802.11n-HT20 only.

Channel Freq. : BLE: 2402MHz-2480MHz;
802.11b/g/n: 2412MHz-2462MHz.

Modulation : BLE: GFSK;
802.11b: DSSS (CCK, DQPSK, DBPSK);
802.11g/n: OFDM (64QAM, 16QAM, QPSK, BPSK).

Antenna Info. : Antenna Type: Metal Monopole Antenna
Antenna Gain: 0.78 dBi
The Antenna was a permanently attached antenna that is comply with 15.203 requirement.

Test Mode : The EUT was set at continuous TX during all the test in the report.

Applicant : Savant Technologies LLC, dba GE Lighting, a Savant company
1975 Noble Road, Cleveland, OH 44112

Manufacturer : same as Applicant

Factory : Jiangxi Innotech Technology Co., Ltd.
No. 399, Rule Lake Avenue, Nanchang Airport
Economic Zone, Nanchang, Jiangxi.

2.2 EUT Specifications Assessed in Current Report

Mode	Modulation	Data Rate(Mbps)
802.11b	DS (DQPSK, DBPSK, CCK)	Up to 11
802.11g	OFDM (64-QAM, 16-QAM, QPSK, BPSK)	Up to 54
802.11n-HT 20	OFDM (64-QAM, 16-QAM, QPSK, BPSK)	Up to 72.2

Channel List			
Channel No.	Frequency (MHz)	Channel No.	Frequency (MHz)
1	2412	7	2442
2	2417	8	2447
3	2422	9	2452
4	2427	10	2457
5	2432	11	2462
6	2437		

2.3 Test Information

The test software “UI_mptool.exe” was used to control EUT work in TX mode, Power Index and select test channel.

Modulation	data rate (Mbps)	Power Index	Test Channel		Frequency (MHz)
802.11b	11	89	Low:	1	2412
		88	Middle:	6	2437
		88	High:	11	2462
802.11g	6	90	Low:	1	2412
		90		2	2417
		101	Middle:	6	2437
		85		10	2457
		85	High:	11	2462
802.11n20	MCS0	86	Low:	1	2412
		86		2	2417
		97	Middle:	6	2437
		85		10	2457
		85	High:	11	2462

2.4 Sample Description

Test Item	Model Number	Sample Number	Date of receipted
Conducted Emission	CLEDA199CD1	E21091384-02/02	2021.09.17
Radiated Emission	CLEDA199CD1	E21091429-01/02	2021.09.22
Conducted RF Test	CLEDA199CD1	E21091429a-01/02	2021.09.17

2.5 Supported equipment

Brand : Acer
Product Name: : Notebook PC
Model Name : TravelMate P238 series
Model Number : N15W8

2.6 Description of Test Facility

Name of Firm : Audix Technology (Shanghai) Co., Ltd.
Site Location : 3F and 4F, 34Bldg, 680 Guiping Rd.,
Caohejing Hi-Tech Park,
Shanghai 200233, China.
Accredited by NVLAP, Lab Code : 200371-0
FCC Designation Number : CN5027
Test Firm Registration Number : 954668

3 CONDUCTED EMISSION TEST

3.1 Test Equipment

The following test equipments are used during the conducted emission test in a shielded room:

Item	Type	Manufacturer	Model No.	Serial No.	Cal. Date	Cal. Interval
1.	Test Receiver	R&S	ESCI	101302	2021.04.26	1 Year
2.	Artificial Mains Network (AMN)	R&S	ENV4200	100125	2021.06.24	1 Year
3.	Software	Audix	e3	6.2009-1-15	--	--

3.2 Block Diagram of Test Setup

3.2.1 Conducted Disturbance Test Setup

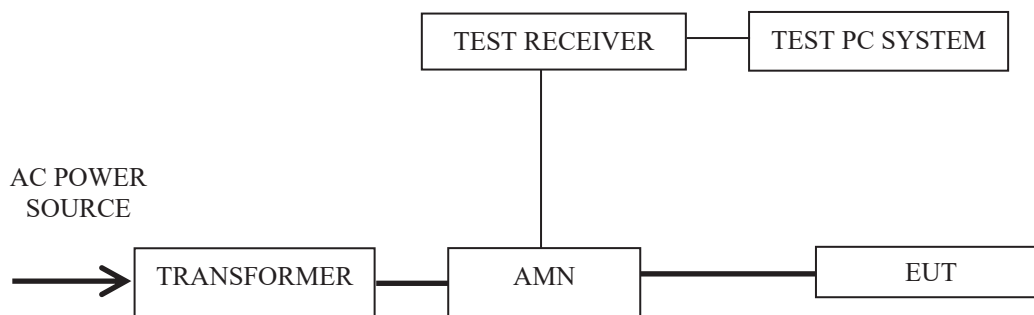

— : Signal Line
 — : Power Line

3.3 Conducted Emission Limits (§15.207)

Frequency Range (MHz)	Limits dB(μV)	
	Quasi-peak	Average
0.15 ~ 0.5	66~56	56~46
0.5 ~ 5	56	46
5 ~ 30	60	50
NOTE 1 – The lower limit shall apply at the transition frequencies. NOTE 2 – The limit decreases linearly with the logarithm of the frequency in the range 0.15 MHz~0.50 MHz		

3.4 Test Configuration

The EUT (listed in Sec.2.1) was installed as shown on Sec.3.2 to meet FCC requirement and operating in a manner which tends to maximize its emission level in a normal application.

3.5 Operating Condition of EUT

- 3.5.1 Setup the EUT as shown in Sec. 3.2.
- 3.5.2 Turn on the power of all equipment.
- 3.5.3 Turn the EUT on the test mode, and then test.

3.6 Test Procedures

The EUT was placed upon a non-metallic table, which is 0.8 m above the horizontal conducting ground plane and 0.4 m from a vertical reference plane. The EUT was connected to the power mains through an Artificial Mains Network (AMN) to provide a 50 Ω coupling impedance for the measuring equipment. Both sides of AC line (Line & Neutral) were checked to find out the maximum conducted emission according to FCC Part 15 Subpart C and ANSI C63.10: 2013 requirements during conducted disturbance test.

The I.F. bandwidth of Test Receiver ESCI was set at 9 kHz.

The frequency range from 150 kHz to 30 MHz was checked.

Test with a dummy load in lieu of the antenna to determine compliance with Section 15.207 limits within the transmitter's fundamental emission band. (According to KDB 174176 D01 Line Conducted FAQ)

The test modes were done on conducted disturbance test and all the test results are listed in Sec. 3.7

3.7 Test Results

< PASS >

The frequency and amplitude of the highest conducted emission relative the limit is reported. All the emissions not reported below are too low against the FCC limit.

Worst case emission:

No.	Operation	Modulation	Channel	Frequency (MHz)	Data Page
1.	Transmitting	--	--	--	P12

NOTE 1 – Level = Read Level + AMN Factor + Cable Loss

NOTE 2 – “QP” means “Quasi-Peak” values

NOTE 3 – The emission levels which not reported are too low against the official limit.

Worst case emission

EUT : Direct connect Full Color A19 Temperature : 22°C

Model No. : CLEDA199CD1 Humidity : 51%RH

Test Mode : Transmitting Date of Test : 2021.09.17

Polarization	Frequency (MHz)	Meter Reading dB (µV)	AMN Factor (dB)	Cable Loss (dB)	Emission Level dB (µV)	Limits dB (µV)	Margin (dB)	Remark
Line	0.1815	36.17	10.51	0.03	46.71	64.42	17.71	QP
	0.1815	21.27	10.51	0.03	31.81	54.42	22.61	Average
	0.2304	32.84	10.47	0.03	43.34	62.44	19.1	QP
	0.2304	17.72	10.47	0.03	28.22	52.44	24.22	Average
	0.352	25.76	10.41	0.04	36.21	58.91	22.7	QP
	0.352	16.95	10.41	0.04	27.4	48.91	21.51	Average
	0.6613	24.37	10.34	0.05	34.76	56	21.24	QP
	0.6613	12.18	10.34	0.05	22.57	46	23.43	Average
	1.296	25.31	10.34	0.06	35.71	56	20.29	QP
	1.296	10.89	10.34	0.06	21.29	46	24.71	Average
	28.302	5.31	10.64	0.3	16.25	60	43.75	QP
	28.302	-0.07	10.64	0.3	10.87	50	39.13	Average
Neutral	0.1516	36.87	10.72	0.03	47.62	65.91	18.29	QP
	0.1516	23.06	10.72	0.03	33.81	55.91	22.1	Average
	0.1815	36.09	10.68	0.03	46.8	64.42	17.62	QP
	0.1815	20.7	10.68	0.03	31.41	54.42	23.01	Average
	0.2304	33.75	10.62	0.03	44.4	62.44	18.04	QP
	0.2304	18.22	10.62	0.03	28.87	52.44	23.57	Average
	0.4127	26.78	10.53	0.04	37.35	57.59	20.24	QP
	0.4127	12.2	10.53	0.04	22.77	47.59	24.82	Average
	1.31	25.86	10.46	0.06	36.38	56	19.62	QP
	1.31	10.18	10.46	0.06	20.7	46	25.3	Average
	27.416	3.17	10.8	0.3	14.27	60	45.73	QP
	27.416	-1.9	10.8	0.3	9.2	50	40.8	Average

TEST ENGINEER: Jarey

4 RADIATED EMISSION TEST

4.1 Test Equipment

The following test equipment are used during the radiated emission test in a semi-anechoic chamber:

Item	Type	Manufacturer	Model No.	Serial No.	Cal. Date	Cal. Interval
1.	Preamplifier	Agilent	8447D	2944A10548	2021.03.08	1 Year
2.	Preamplifier	HP	8449B	3008A00864	2021.03.08	1 Year
3.	Spectrum Analyzer	Agilent	N9010A	MY52221182	2021.09.16	1 Year
4.	Test Receiver	R&S	ESCI	101303	2021.03.08	1 Year
5.	Bilog Antenna+6dB Attenuator	Schwarz beck	VULB 9168+EMCI-N-6-06	707+AT-N06 37	2021.03.30	1 Year
6.	Horn Antenna	EMCO	3115	9607-4878	2021.07.27	1 Year
7.	Horn Antenna	EMCO	3116	00062643	2020.10.10	1 Year
8.	Cavity Band Rejection Filter	Microwave	WT-A3882-R-10	WT200312-1-1	2021.09.15	1 Year
9.	Software	Audix	e3	SET00200 9912M295-2	--	--

4.2 Block Diagram of Test Setup

4.2.1 EUT & Peripherals



4.2.2 Below 1GHz

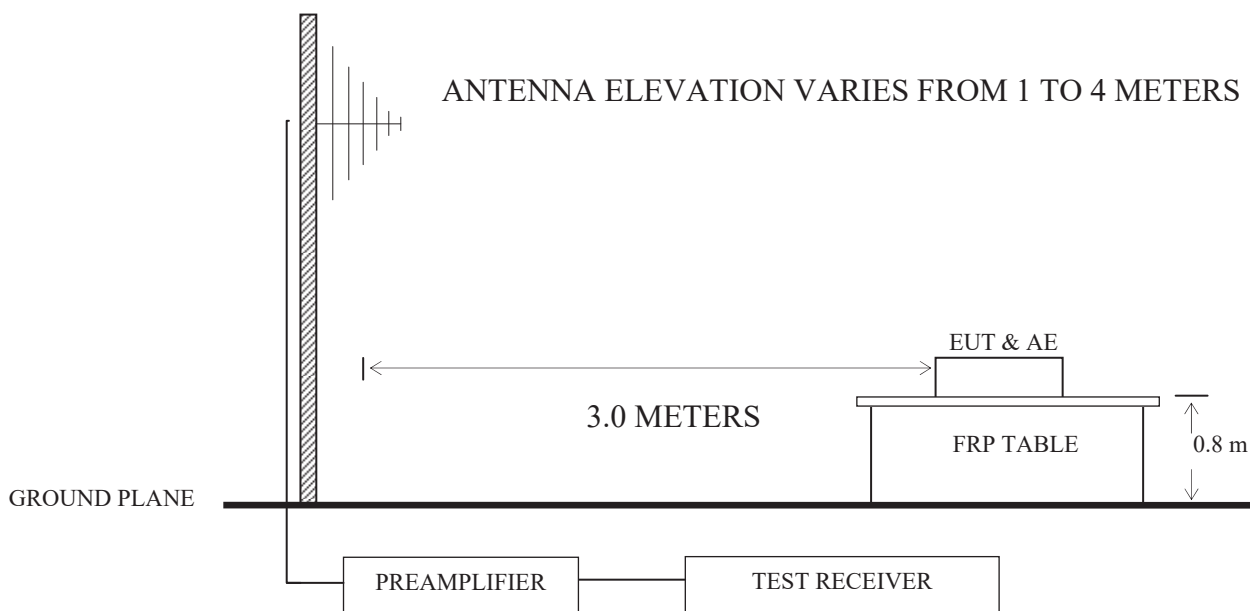

4.2.3 Above 1GHz

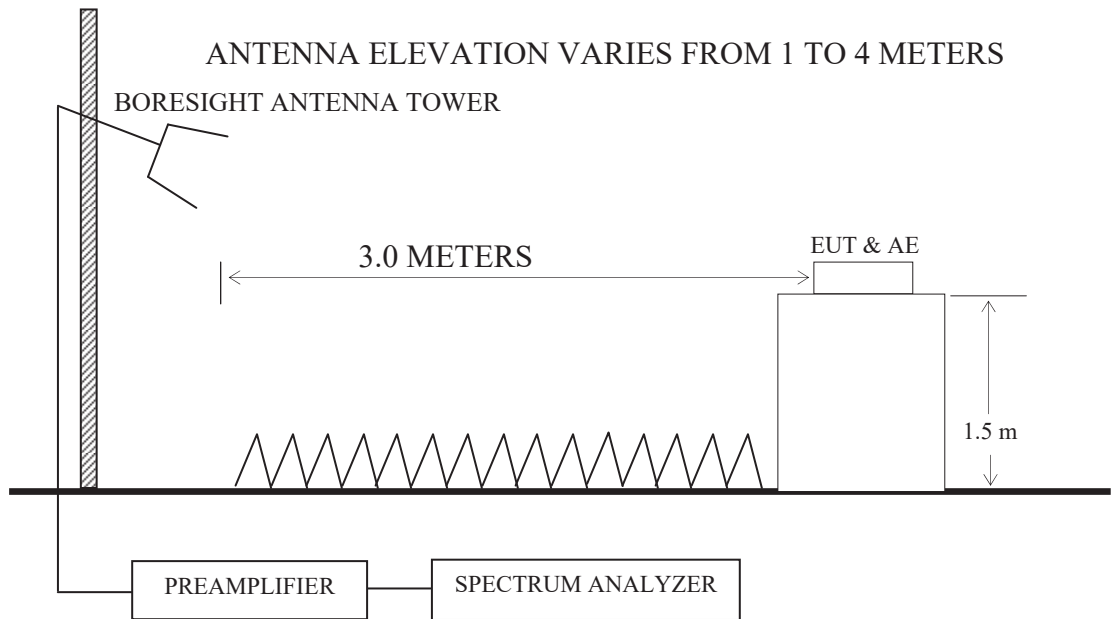

4.3 Radiated Emission Limit (§15.209)

Frequency (MHz)	Distance (m)	Field strength limits (μV/m)	
		(μV/m)	(μV/m)
30 ~ 88	3	100	40.0
88 ~ 216	3	150	43.5
216 ~ 960	3	200	46.0
Above 960	3	500	54.0

NOTE 1 - Emission Level dB (V/m) = 20 log Emission Level (V/m)

NOTE 2 - The tighter limit applies at the band edges.

NOTE 3 - Distance refers to the distance in meters between the measuring instrument antenna and the closed point of any part of the device or system.

NOTE 4 - The limits shown are based on Quasi-peak value detector below or equal to 1GHz and Average value detector above 1GHz.

NOTE 5 - Above 1 GHz, the limit on peak emission is 20 dB above the maximum permitted average emission limit applicable to the EUT

4.4 Test Configuration

The EUT (listed in Sec.2.1) and the simulators (listed in Sec.2.2) were installed as shown on Sec.4.2 to meet FCC requirements and operating in a manner that tends to maximize its emission level in a normal application.

4.5 Operating Condition of EUT

4.5.1 Setup the EUT as shown in Sec. 4.2.

4.5.2 Turn on the power of all equipment.

4.5.3 Turn the EUT on the test mode, and then test.

4.6 Test Procedures

Radiated emission test applies to harmonics/spurs that fall in the restricted bands listed in Section 15.205. The maximum permitted average field strength is listed in Section 15.209. A pre-amp is necessary for this measurement. For measurement above 1 GHz, set RBW = 1MHz, VBW = 10 Hz, Sweep: Auto. If the emission is pulsed, modify the unit for continuous operation; use the settings shown above, then correct the reading by subtracting the peak-average correction factor, derived from the appropriate duty cycle calculation.

The EUT was placed on a turntable. Below 1 GHz, the table height is 80 cm above the reference ground plane. Above 1 GHz, the table height is 1.5 m. The turntable rotated 360 degrees to determine the position of the maximum emission level. The EUT was set 3 meters away from the receiving antenna, which was mounted on an antenna tower. The antenna moved up and down between 1 meter and 4 meters to find out the maximum emission level. Broadband antenna (Calibrated Bilog Antenna) or Horn antenna was used as receiving antenna. Both horizontal and vertical polarizations of the antenna were set on measurement. In order to find the maximum emission, all of the interference cables were manipulated according to ANSI C63.10: 2013 requirements during radiated emission test.

The bandwidth of Test Receiver R&S ESCI was set at 120 kHz from 30MHz to 1000MHz.

The bandwidth of Agilent N9010A was set at 1MHz for above 1GHz.

The frequency range from 30 MHz to 25 GHz (Up to 10th harmonics from fundamental frequency) was checked.

All the test results are listed in Sec.4.7.

4.7 Test Results

<PASS>

The frequency and amplitude of the highest radiated emission relative the limit is reported. All the emissions not reported below are too low against the FCC limit.

Frequency range: below 1GHz (Worst case emission)

No.	Operation	Modulation	Channel	Frequency	Data Page
1.	Transmitting	802.11b	1	2412 MHz	P18
2.			6	2437 MHz	P18
3.			11	2462 MHz	P19
4.		802.11g	11	2462 MHz	P19
5.		802.11n20	11	2462 MHz	P20

Frequency range: above 1GHz

No.	Operation	Modulation	Channel	Frequency	Data Page
1.	Transmitting	802.11b	1	2412 MHz	P21
2.			6	2437 MHz	P21
3.			11	2462 MHz	P22
4.	Transmitting	802.11g	11	2462 MHz	P22
5.	Transmitting	802.11n20	11	2462 MHz	P23

Restricted bands:

No.	Operation	Modulation	Channel	Frequency	Data Page
1.	Transmitting	802.11b	1	2412 MHz	P24
2.			11	2462 MHz	P24
3.		802.11g	1	2412 MHz	P25
4.			2	2417 MHz	P25
5.			10	2457 MHz	P26
6.			11	2462 MHz	P26
7.		802.11n20	1	2412 MHz	P27
8.			2	2417 MHz	P27
9.			10	2457 MHz	P28
10.			11	2462 MHz	P28

NOTE 1 – Level = Read Level + Antenna Factor + Cable Loss - Preamp Factor

NOTE 2 – “QP” means “Quasi-Peak” values

NOTE 3 – 0° was the table front facing the antenna. Degree is calculated from 0° clockwise facing the antenna.

NOTE 4 – The emission levels which not reported are too low against the official limit.

NOTE 5 – The emission levels recorded below is data of EUT configured in Standing direction, for Standing direction was the maximum emission direction during the test. The data of Side & Lying direction are too low against the official limit to be reported.

NOTE 6 – All reading are Quasi-Peak values below or equal to 1GHz, Peak and Average values above 1GHz.

For above 1GHz test, if the peak measured value complies with the average limit, it is unnecessary to perform an average measurement.

NOTE 7 – The frequency range 2310-2390MHz & 2483.5-2500MHz were tested for Restricted bands.

Worst case emission < 1GHz

EUT : Direct connect Full Color A19 Temperature : 22°C

Model No. : CLEDA199CD1 Humidity : 51%RH

Test Mode : Transmitting Date of Test : 2021.09.22

802.11b CH2412MHz

Polarization	Frequency (MHz)	Meter Reading dB (µV)	Antenna Factor (dB/m)	Cable Loss (dB)	Preamp Factor (dB)	Emission Level dB (µV/m)	Limits dB (µV/m)	Margin (dB)	Remark
Horizontal	56.197	23.56	19.48	0.8	28.18	15.66	40	24.34	QP
	87.725	28.04	13.73	1.02	28.06	14.73	40	25.27	QP
	159.78	28.92	19	1.35	27.73	21.54	43.5	21.96	QP
	239.99	31.2	17.2	1.65	27.2	22.85	46	23.15	QP
	397.63	28.21	21.1	2.15	27.58	23.88	46	22.12	QP
	798.98	23.89	27.8	3.06	26.9	27.85	46	18.15	QP
Vertical	56.395	25.18	19.46	0.81	28.17	17.28	40	22.72	QP
	87.725	30.04	13.73	1.02	28.06	16.73	40	23.27	QP
	159.78	27.22	19	1.35	27.73	19.84	43.5	23.66	QP
	235.82	30.33	16.7	1.64	27.22	21.45	46	24.55	QP
	552.88	24.27	24.1	2.53	27.89	23.01	46	22.99	QP
	919.29	23.27	29.2	3.34	26.2	29.61	46	16.39	QP

802.11b CH2437MHz

Polarization	Frequency (MHz)	Meter Reading dB (µV)	Antenna Factor (dB/m)	Cable Loss (dB)	Preamp Factor (dB)	Emission Level dB (µV/m)	Limits dB (µV/m)	Margin (dB)	Remark
Horizontal	51.843	23.27	19.52	0.77	28.19	15.37	40	24.63	QP
	87.725	27.15	13.73	1.02	28.06	13.84	40	26.16	QP
	159.78	28.84	19	1.35	27.73	21.46	43.5	22.04	QP
	237.48	30.24	16.9	1.65	27.21	21.58	46	24.42	QP
	501.18	23.62	23.23	2.48	27.9	21.43	46	24.57	QP
	793.4	22.65	27.9	3.06	26.94	26.67	46	19.33	QP
Vertical	53.318	25.19	19.53	0.78	28.19	17.31	40	22.69	QP
	159.78	26.54	19	1.35	27.73	19.16	43.5	24.34	QP
	263.82	24.34	17.84	1.74	27.1	16.82	46	29.18	QP
	552.88	24.33	24.1	2.53	27.89	23.07	46	22.93	QP
	872.18	23.45	28.3	3.24	26.45	28.54	46	17.46	QP
	51.843	23.27	19.52	0.77	28.19	15.37	40	24.63	QP

802.11b CH2462MHz

Polarization	Frequency (MHz)	Meter Reading dB (μ V)	Antenna Factor (dB/m)	Cable Loss (dB)	Preamp Factor (dB)	Emission Level dB (μ V/m)	Limits dB (μ V/m)	Margin (dB)	Remark
Horizontal	56.991	23.92	19.4	0.81	28.17	15.96	40	24.04	QP
	88.033	27.96	13.7	1.02	28.06	14.62	43.5	28.88	QP
	159.78	28.55	19	1.35	27.73	21.17	43.5	22.33	QP
	247.68	30.49	17.45	1.68	27.16	22.46	46	23.54	QP
	401.84	27.49	21.13	2.17	27.6	23.19	46	22.81	QP
	801.79	23.84	27.9	3.09	26.9	27.93	46	18.07	QP
Vertical	55.221	25.66	19.66	0.8	28.18	17.94	40	22.06	QP
	88.033	29.12	13.7	1.02	28.06	15.78	43.5	27.72	QP
	263.82	23.94	17.84	1.74	27.1	16.42	46	29.58	QP
	552.88	23.8	24.1	2.53	27.89	22.54	46	23.46	QP
	875.25	22.81	28.3	3.28	26.45	27.94	46	18.06	QP
	56.991	23.92	19.4	0.81	28.17	15.96	40	24.04	QP

802.11g CH2462MHz

Polarization	Frequency (MHz)	Meter Reading dB (μ V)	Antenna Factor (dB/m)	Cable Loss (dB)	Preamp Factor (dB)	Emission Level dB (μ V/m)	Limits dB (μ V/m)	Margin (dB)	Remark
Horizontal	51.662	23.64	19.53	0.77	28.19	15.75	40	24.25	QP
	91.495	27.69	13.95	1.05	28.04	14.65	43.5	28.85	QP
	159.78	29.15	19	1.35	27.73	21.77	43.5	21.73	QP
	239.99	30.48	17.2	1.65	27.2	22.13	46	23.87	QP
	431.03	27.14	22.05	2.24	27.72	23.71	46	22.29	QP
	878.32	22.89	28.3	3.28	26.4	28.07	46	17.93	QP
Vertical	58.819	23.72	19.4	0.82	28.17	15.77	40	24.23	QP
	87.725	28.88	13.73	1.02	28.06	15.57	40	24.43	QP
	159.78	26.9	19	1.35	27.73	19.52	43.5	23.98	QP
	501.18	24.97	23.23	2.48	27.9	22.78	46	23.22	QP
	798.98	23.43	27.8	3.06	26.9	27.39	46	18.61	QP
	51.662	23.64	19.53	0.77	28.19	15.75	40	24.25	QP

802.11n20 CH2462MHz

Polarization	Frequency (MHz)	Meter Reading dB (μV)	Antenna Factor (dB/m)	Cable Loss (dB)	Preamp Factor (dB)	Emission Level dB (μV/m)	Limits dB (μV/m)	Margin (dB)	Remark
Horizontal	53.882	22.85	19.58	0.78	28.18	15.03	40	24.97	QP
	88.033	26.53	13.7	1.02	28.06	13.19	43.5	30.31	QP
	159.78	28.69	19	1.35	27.73	21.31	43.5	22.19	QP
	245.95	30.42	17.42	1.67	27.18	22.33	46	23.67	QP
	501.18	24.88	23.23	2.48	27.9	22.69	46	23.31	QP
	827.49	22.99	27.95	3.14	26.75	27.33	46	18.67	QP
Vertical	53.131	24.16	19.52	0.78	28.19	16.27	40	23.73	QP
	91.495	28.54	13.95	1.05	28.04	15.5	43.5	28	QP
	159.78	26.02	19	1.35	27.73	18.64	43.5	24.86	QP
	327.89	23.23	19.86	1.97	27.19	17.87	46	28.13	QP
	552.88	24.47	24.1	2.53	27.89	23.21	46	22.79	QP
	929.01	22.46	29.1	3.34	26.1	28.8	46	17.2	QP

TEST ENGINEER: Jarey

Radiated Emission > 1GHz

EUT : Direct connect Full Color A19 Temperature : 22°C

Model No. : CLEDA199CD1 Humidity : 51%RH

Test Mode : Transmitting Date of Test : 2021.09.22

802.11b CH2412MHz

Polarization	Frequency (MHz)	Meter Reading dB (μV)	Antenna Factor (dB/m)	Cable Loss (dB)	Preamp Factor (dB)	Emission Level dB (μV/m)	Limits dB (μV/m)	Margin (dB)	Remark
Horizontal	3532	42.73	31.4	6.4	35.13	45.4	74	28.6	Peak
	5044	38.75	34.01	7.73	34.7	45.79	74	28.21	Peak
	7108	36.7	35.9	9.37	34.8	47.17	74	26.83	Peak
	8392	37	38.43	10.4	34.76	51.07	74	22.93	Peak
	11356	35.42	38.8	11.87	34.33	51.76	74	22.24	Peak
	12256	35.75	38.8	12.56	34.12	52.99	74	21.01	Peak
Vertical	3196	43.3	30.6	6.09	35.23	44.76	74	29.24	Peak
	4816	46.95	33.26	7.55	34.75	53.01	74	20.99	Peak
	4816	38.4	33.26	7.55	34.75	44.46	54	9.54	Average
	7180	37.45	36.05	9.47	34.8	48.17	74	25.83	Peak
	9124	38.04	38.23	10.79	34.68	52.38	74	21.62	Peak
	12544	35.21	38.65	12.68	34.03	52.51	74	21.49	Peak

802.11b CH2437MHz

Polarization	Frequency (MHz)	Meter Reading dB (μV)	Antenna Factor (dB/m)	Cable Loss (dB)	Preamp Factor (dB)	Emission Level dB (μV/m)	Limits dB (μV/m)	Margin (dB)	Remark
Horizontal	3184	43.82	30.58	6.09	35.24	45.25	74	28.75	Peak
	4876	40.08	33.49	7.61	34.74	46.44	74	27.56	Peak
	7396	37.13	36.55	9.69	34.8	48.57	74	25.43	Peak
	9088	36.98	38.22	10.79	34.69	51.3	74	22.7	Peak
	11092	35.95	38.8	11.76	34.38	52.13	74	21.87	Peak
	12268	35.3	38.8	12.56	34.12	52.54	74	21.46	Peak
Vertical	3196	44.49	30.6	6.09	35.23	45.95	74	28.05	Peak
	4876	48.61	33.49	7.61	34.74	54.97	74	19.03	Peak
	4876	38.9	33.49	7.61	34.74	45.26	54	8.74	Average
	7240	37.15	36.2	9.47	34.8	48.02	74	25.98	Peak
	9880	36.86	38.37	11.33	34.61	51.95	74	22.05	Peak
	12532	35.99	38.65	12.68	34.04	53.28	74	20.72	Peak

802.11b CH2462MHz

Polarization	Frequency (MHz)	Meter Reading dB (μ V)	Antenna Factor (dB/m)	Cable Loss (dB)	Preamp Factor (dB)	Emission Level dB (μ V/m)	Limits dB (μ V/m)	Margin (dB)	Remark
Horizontal	3196	43.18	30.6	6.09	35.23	44.64	74	29.36	Peak
	4996	38.01	34	7.73	34.7	45.04	74	28.96	Peak
	7420	36.29	36.6	9.69	34.8	47.78	74	26.22	Peak
	8644	36.42	38.48	10.52	34.73	50.69	74	23.31	Peak
	10780	36.37	38.58	11.6	34.44	52.11	74	21.89	Peak
	12556	35.51	38.65	12.68	34.03	52.81	74	21.19	Peak
Vertical	3184	42.92	30.58	6.09	35.24	44.35	74	29.65	Peak
	4924	47.4	33.72	7.67	34.72	54.07	74	19.93	Peak
	4924	39.3	33.72	7.67	34.72	45.97	54	8.03	Average
	8656	37.54	38.46	10.58	34.73	51.85	74	22.15	Peak
	11356	36.98	38.8	11.87	34.33	53.32	74	20.68	Peak
	12424	36.66	38.66	12.56	34.07	53.81	74	20.19	Peak

802.11g CH2462MHz

Polarization	Frequency (MHz)	Meter Reading dB (μ V)	Antenna Factor (dB/m)	Cable Loss (dB)	Preamp Factor (dB)	Emission Level dB (μ V/m)	Limits dB (μ V/m)	Margin (dB)	Remark
Horizontal	3184	43.78	30.58	6.09	35.24	45.21	74	28.79	Peak
	5164	39.17	34.03	7.83	34.7	46.33	74	27.67	Peak
	6988	38.04	35.6	9.26	34.8	48.1	74	25.9	Peak
	8776	36.73	38.38	10.58	34.72	50.97	74	23.03	Peak
	11104	35.53	38.8	11.76	34.38	51.71	74	22.29	Peak
	12868	34.79	39.06	12.91	33.94	52.82	74	21.18	Peak
Vertical	3184	43.99	30.58	6.09	35.24	45.42	74	28.58	Peak
	4924	42.06	33.72	7.67	34.72	48.73	74	25.27	Peak
	4924	34.4	33.72	7.67	34.72	41.07	54	12.93	Average
	7804	37.47	37.37	10.01	34.8	50.05	74	23.95	Peak
	10132	36.23	38.38	11.37	34.57	51.41	74	22.59	Peak
	12208	35.94	38.83	12.45	34.14	53.08	74	20.92	Peak

802.11n20 CH2462MHz

Polarization	Frequency (MHz)	Meter Reading dB (µV)	Antenna Factor (dB/m)	Cable Loss (dB)	Preamp Factor (dB)	Emission Level dB (µV/m)	Limits dB (µV/m)	Margin (dB)	Remark
Horizontal	3364	41.69	31.01	6.23	35.18	43.75	74	30.25	Peak
	5536	38.68	34.11	8.09	34.7	46.18	74	27.82	Peak
	7444	36.57	36.7	9.69	34.8	48.16	74	25.84	Peak
	8776	37.18	38.38	10.58	34.72	51.42	74	22.58	Peak
	11248	35.27	38.8	11.87	34.35	51.59	74	22.41	Peak
	12232	35.25	38.83	12.45	34.13	52.4	74	21.6	Peak
Vertical	3184	44.62	30.58	6.09	35.24	46.05	74	27.95	Peak
	4912	42.56	33.66	7.61	34.72	49.11	74	24.89	Peak
	4912	35.35	33.66	7.61	34.72	41.9	54	12.1	Average
	7876	36.84	37.5	10.11	34.8	49.65	74	24.35	Peak
	10420	36.12	38.32	11.46	34.52	51.38	74	22.62	Peak
	12616	35.65	38.74	12.8	34.01	53.18	74	20.82	Peak

TEST ENGINEER: Jarey

Emissions in restricted frequency bands:

EUT : Direct connect Full Color A19 Temperature : 22°C

Model No. : CLEDA199CD1 Humidity : 51%RH

Test Mode : Transmitting Date of Test : 2021.09.22

802.11b CH2412MHz

Polarization	Frequency (MHz)	Meter Reading dB (µV)	Antenna Factor (dB/m)	Cable Loss (dB)	Preamp Factor (dB)	Emission Level dB (µV/m)	Limits dB (µV/m)	Margin (dB)	Remark
Horizontal	2331.3	48.68	28.06	5.29	35.93	46.1	74	27.9	Peak
	2331.3	38.57	28.06	5.29	35.93	35.99	54	18.01	Average
	2362.3	49.32	28.14	5.32	35.89	46.89	74	27.11	Peak
	2362.3	38.43	28.14	5.32	35.89	36	54	18	Average
	2389.3	50.32	28.21	5.36	35.86	48.03	74	25.97	Peak
	2389.3	39.53	28.21	5.36	35.86	37.24	54	16.76	Average
Vertical	2331.7	54.75	28.06	5.29	35.93	52.17	74	21.83	Peak
	2331.7	41.38	28.06	5.29	35.93	38.8	54	15.2	Average
	2363.2	53.08	28.15	5.32	35.89	50.66	74	23.34	Peak
	2363.2	41.41	28.15	5.32	35.89	38.99	54	15.01	Average
	2389.6	58.11	28.21	5.36	35.86	55.82	74	18.18	Peak
	2389.6	44.21	28.21	5.36	35.86	41.92	54	12.08	Average

802.11b CH2462MHz

Polarization	Frequency (MHz)	Meter Reading dB (µV)	Antenna Factor (dB/m)	Cable Loss (dB)	Preamp Factor (dB)	Emission Level dB (µV/m)	Limits dB (µV/m)	Margin (dB)	Remark
Horizontal	2483.7	49.2	28.46	5.43	35.76	47.33	74	26.67	Peak
	2483.7	39.32	28.46	5.43	35.76	37.45	54	16.55	Average
	2489.4	50.64	28.48	5.47	35.76	48.83	74	25.17	Peak
	2489.4	39.46	28.48	5.47	35.76	37.65	54	16.35	Average
	2497.5	49.84	28.5	5.47	35.76	48.05	74	25.95	Peak
	2497.5	38.68	28.5	5.47	35.76	36.89	54	17.11	Average
Vertical	2483.6	52.44	28.46	5.43	35.76	50.57	74	23.43	Peak
	2483.6	42.24	28.46	5.43	35.76	40.37	54	13.63	Average
	2493	50.74	28.48	5.47	35.76	48.93	74	25.07	Peak
	2493	40.58	28.48	5.47	35.76	38.77	54	15.23	Average
	2498.5	51.08	28.5	5.47	35.76	49.29	74	24.71	Peak
	2498.5	40.21	28.5	5.47	35.76	38.42	54	15.58	Average

802.11g CH2412MHz

Polarization	Frequency (MHz)	Meter Reading dB (μ V)	Antenna Factor (dB/m)	Cable Loss (dB)	Preamp Factor (dB)	Emission Level dB (μ V/m)	Limits dB (μ V/m)	Margin (dB)	Remark
Horizontal	2333.3	49.17	28.06	5.29	35.92	46.6	74	27.4	Peak
	2333.3	38.32	28.06	5.29	35.92	35.75	54	18.25	Average
	2358.4	48.44	28.14	5.32	35.89	46.01	74	27.99	Peak
	2358.4	38.24	28.14	5.32	35.89	35.81	54	18.19	Average
	2390	49.74	28.21	5.36	35.86	47.45	74	26.55	Peak
	2390	39.37	28.21	5.36	35.86	37.08	54	16.92	Average
Vertical	2335.3	54.37	28.06	5.29	35.92	51.8	74	22.2	Peak
	2335.3	41.24	28.06	5.29	35.92	38.67	54	15.33	Average
	2371	54.63	28.17	5.32	35.89	52.23	74	21.77	Peak
	2371	44.17	28.17	5.32	35.89	41.77	54	12.23	Average
	2390	59.05	28.21	5.36	35.86	56.76	74	17.24	Peak
	2390	46.8	28.21	5.36	35.86	44.51	54	9.49	Average

802.11g CH2417MHz

Polarization	Frequency (MHz)	Meter Reading dB (μ V)	Antenna Factor (dB/m)	Cable Loss (dB)	Preamp Factor (dB)	Emission Level dB (μ V/m)	Limits dB (μ V/m)	Margin (dB)	Remark
Horizontal	2329.4	48.83	28.06	5.29	35.93	46.25	74	27.75	Peak
	2329.4	38.59	28.06	5.29	35.93	36.01	54	17.99	Average
	2359.4	48.68	28.14	5.32	35.89	46.25	74	27.75	Peak
	2359.4	38.57	28.14	5.32	35.89	36.14	54	17.86	Average
	2388.5	53.09	28.21	5.36	35.86	50.8	74	23.2	Peak
	2388.5	39.61	28.21	5.36	35.86	37.32	54	16.68	Average
Vertical	2333.5	54.31	28.06	5.29	35.92	51.74	74	22.26	Peak
	2333.5	40.14	28.06	5.29	35.92	37.57	54	16.43	Average
	2373.6	55.6	28.17	5.32	35.88	53.21	74	20.79	Peak
	2373.6	44.37	28.17	5.32	35.88	41.98	54	12.02	Average
	2389.1	57.25	28.21	5.36	35.86	54.96	74	19.04	Peak
	2389.1	44.52	28.21	5.36	35.86	42.23	54	11.77	Average

802.11g CH2457MHz

Polarization	Frequency (MHz)	Meter Reading dB (μ V)	Antenna Factor (dB/m)	Cable Loss (dB)	Preamp Factor (dB)	Emission Level dB (μ V/m)	Limits dB (μ V/m)	Margin (dB)	Remark
Horizontal	2483.9	48.61	28.46	5.43	35.76	46.74	74	27.26	Peak
	2483.9	38.46	28.46	5.43	35.76	36.59	54	17.41	Average
	2492.7	49.78	28.48	5.47	35.76	47.97	74	26.03	Peak
	2492.7	38.38	28.48	5.47	35.76	36.57	54	17.43	Average
	2497.8	49.5	28.5	5.47	35.76	47.71	74	26.29	Peak
	2497.8	38.25	28.5	5.47	35.76	36.46	54	17.54	Average
Vertical	2484	52.6	28.46	5.43	35.76	50.73	74	23.27	Peak
	2484	41.36	28.46	5.43	35.76	39.49	54	14.51	Average
	2492	51.15	28.48	5.47	35.76	49.34	74	24.66	Peak
	2492	40.52	28.48	5.47	35.76	38.71	54	15.29	Average
	2497.4	49.97	28.5	5.47	35.76	48.18	74	25.82	Peak
	2497.4	39.7	28.5	5.47	35.76	37.91	54	16.09	Average

802.11g CH2462MHz

Polarization	Frequency (MHz)	Meter Reading dB (μ V)	Antenna Factor (dB/m)	Cable Loss (dB)	Preamp Factor (dB)	Emission Level dB (μ V/m)	Limits dB (μ V/m)	Margin (dB)	Remark
Horizontal	2483.6	50.39	28.46	5.43	35.76	48.52	74	25.48	Peak
	2483.6	39.14	28.46	5.43	35.76	37.27	54	16.73	Average
	2490	49.73	28.48	5.47	35.76	47.92	74	26.08	Peak
	2490	38.47	28.48	5.47	35.76	36.66	54	17.34	Average
	2494.2	51.97	28.48	5.47	35.76	50.16	74	23.84	Peak
	2494.2	38.3	28.48	5.47	35.76	36.49	54	17.51	Average
Vertical	2483.5	54.48	28.46	5.43	35.76	52.61	74	21.39	Peak
	2483.5	43.25	28.46	5.43	35.76	41.38	54	12.62	Average
	2491.7	50.99	28.48	5.47	35.76	49.18	74	24.82	Peak
	2491.7	41.6	28.48	5.47	35.76	39.79	54	14.21	Average
	2497.8	50.86	28.5	5.47	35.76	49.07	74	24.93	Peak
	2497.8	40.39	28.5	5.47	35.76	38.6	54	15.4	Average

802.11n20 CH2412MHz

Polarization	Frequency (MHz)	Meter Reading dB (μV)	Antenna Factor (dB/m)	Cable Loss (dB)	Preamp Factor (dB)	Emission Level dB (μV/m)	Limits dB (μV/m)	Margin (dB)	Remark
Horizontal	2332.5	48.56	28.06	5.29	35.93	45.98	74	28.02	Peak
	2332.5	38.46	28.06	5.29	35.93	35.88	54	18.12	Average
	2364.9	48.5	28.15	5.32	35.89	46.08	74	27.92	Peak
	2364.9	38.26	28.15	5.32	35.89	35.84	54	18.16	Average
	2390	52.21	28.21	5.36	35.86	49.92	74	24.08	Peak
	2390	40.32	28.21	5.36	35.86	38.03	54	15.97	Average
Vertical	2333	51.68	28.06	5.29	35.93	49.1	74	24.9	Peak
	2333	40.57	28.06	5.29	35.93	37.99	54	16.01	Average
	2374.6	54.76	28.17	5.32	35.88	52.37	74	21.63	Peak
	2374.6	44.39	28.17	5.32	35.88	42	54	12	Average
	2389.9	60.12	28.21	5.36	35.86	57.83	74	16.17	Peak
	2389.9	46.21	28.21	5.36	35.86	43.92	54	10.08	Average

802.11n20 CH2417MHz

Polarization	Frequency (MHz)	Meter Reading dB (μV)	Antenna Factor (dB/m)	Cable Loss (dB)	Preamp Factor (dB)	Emission Level dB (μV/m)	Limits dB (μV/m)	Margin (dB)	Remark
Horizontal	2323.9	48.7	28.05	5.29	35.93	46.11	74	27.89	Peak
	2323.9	38.36	28.05	5.29	35.93	35.77	54	18.23	Average
	2355.4	48.71	28.12	5.32	35.9	46.25	74	27.75	Peak
	2355.4	38.27	28.12	5.32	35.9	35.81	54	18.19	Average
	2389.3	51.85	28.21	5.36	35.86	49.56	74	24.44	Peak
	2389.3	40.48	28.21	5.36	35.86	38.19	54	15.81	Average
Vertical	2338.8	51.71	28.08	5.29	35.92	49.16	74	24.84	Peak
	2338.8	40.37	28.08	5.29	35.92	37.82	54	16.18	Average
	2367.9	51.86	28.15	5.32	35.89	49.44	74	24.56	Peak
	2367.9	41.3	28.15	5.32	35.89	38.88	54	15.12	Average
	2383.5	56.05	28.21	5.36	35.87	53.75	74	20.25	Peak
	2383.5	44.5	28.21	5.36	35.87	42.2	54	11.8	Average

802.11n20 CH2457MHz

Polarization	Frequency (MHz)	Meter Reading dB (μ V)	Antenna Factor (dB/m)	Cable Loss (dB)	Preamplifier Factor (dB)	Emission Level dB (μ V/m)	Limits dB (μ V/m)	Margin (dB)	Remark
Horizontal	2483.6	48.02	28.46	5.43	35.76	46.15	74	27.85	Peak
	2483.6	39.3	28.46	5.43	35.76	37.43	54	16.57	Average
	2490.2	48.63	28.48	5.47	35.76	46.82	74	27.18	Peak
	2490.2	39.26	28.48	5.47	35.76	37.45	54	16.55	Average
	2497.8	48.19	28.5	5.47	35.76	46.4	74	27.6	Peak
	2497.8	38.12	28.5	5.47	35.76	36.33	54	17.67	Average
Vertical	2483.7	53.89	28.46	5.43	35.76	52.02	74	21.98	Peak
	2483.7	42.49	28.46	5.43	35.76	40.62	54	13.38	Average
	2489.7	53.7	28.48	5.47	35.76	51.89	74	22.11	Peak
	2489.7	42.36	28.48	5.47	35.76	40.55	54	13.45	Average
	2499.1	50.82	28.5	5.47	35.76	49.03	74	24.97	Peak
	2499.1	40.48	28.5	5.47	35.76	38.69	54	15.31	Average

802.11n20 CH2462MHz

Polarization	Frequency (MHz)	Meter Reading dB (μ V)	Antenna Factor (dB/m)	Cable Loss (dB)	Preamplifier Factor (dB)	Emission Level dB (μ V/m)	Limits dB (μ V/m)	Margin (dB)	Remark
Horizontal	2483.9	49.9	28.46	5.43	35.76	48.03	74	25.97	Peak
	2483.9	39.49	28.46	5.43	35.76	37.62	54	16.38	Average
	2492.1	49.19	28.48	5.47	35.76	47.38	74	26.62	Peak
	2492.1	38.32	28.48	5.47	35.76	36.51	54	17.49	Average
	2497.3	49.76	28.5	5.47	35.76	47.97	74	26.03	Peak
	2497.3	38.58	28.5	5.47	35.76	36.79	54	17.21	Average
Vertical	2484.1	54.95	28.46	5.43	35.76	53.08	74	20.92	Peak
	2484.1	43.59	28.46	5.43	35.76	41.72	54	12.28	Average
	2493.4	53.38	28.48	5.47	35.76	51.57	74	22.43	Peak
	2493.4	40.34	28.48	5.47	35.76	38.53	54	15.47	Average
	2497.3	51.28	28.5	5.47	35.76	49.49	74	24.51	Peak
	2497.3	40.53	28.5	5.47	35.76	38.74	54	15.26	Average

TEST ENGINEER: Jarey

5 6 dB BANDWIDTH MEASUREMENT

5.1 Test Equipment

The following test equipment was used during the Emission Bandwidth measurement:

Item	Type	Manufacturer	Model No.	Serial No.	Cal. Date	Cal. Interval
4.	Spectrum Analyzer	Agilent	N9010A	MY52221182	2021.09.15	1 Year
5.	Coaxial Cable	WOKEN	SFL402-105F LEX	F02-150819-045	2021.03.08	1 Year
6.	20 dB Attenuator	Mini-Circuits	VAT-20+	001	2021.08.06	1 Year

5.2 Block Diagram of Test Setup

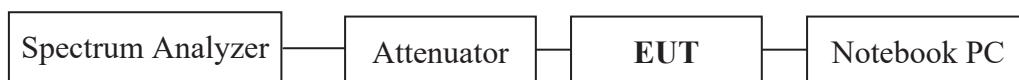

5.3 Specification Limits (§15.247(a)(2))

The minimum 6 dB bandwidth shall be at least 500 kHz.

5.4 Operating Condition of EUT

The switch ON/OFF was used to enable the EUT to change the channel one by one.

5.5 Test Procedure

The transmitter output was connected to the spectrum analyzer. The bandwidth of the fundamental frequency was measure by spectrum analyzer with settings: RBW = 100kHz, VBW $\geq 3 \times$ RBW.

The 6 dB bandwidth is defined as the total spectrum the power of which is lower than peak power minus 6 dB .

The test procedure is defined in ANSI C63.10-2013 (the 11.8.2 Measurement Procedure “Option 2” was used).

5.6 Test Results

PASSED.

All the test results are attached in next pages.

(Test Date: 2021.09.17 Temperature: 23°C Humidity: 51 %)

Modulation	Channel	Frequency (MHz)	6dB Bandwidth (MHz)	Limit
802.11b	1	2412	8.439	500 kHz
	6	2437	8.435	500 kHz
	11	2462	8.435	500 kHz
802.11g	1	2412	16.57	500 kHz
	6	2437	16.58	500 kHz
	11	2462	16.57	500 kHz
802.11n20	1	2412	17.79	500 kHz
	6	2437	17.8	500 kHz
	11	2462	17.79	500 kHz

802.11b CH2412MHz

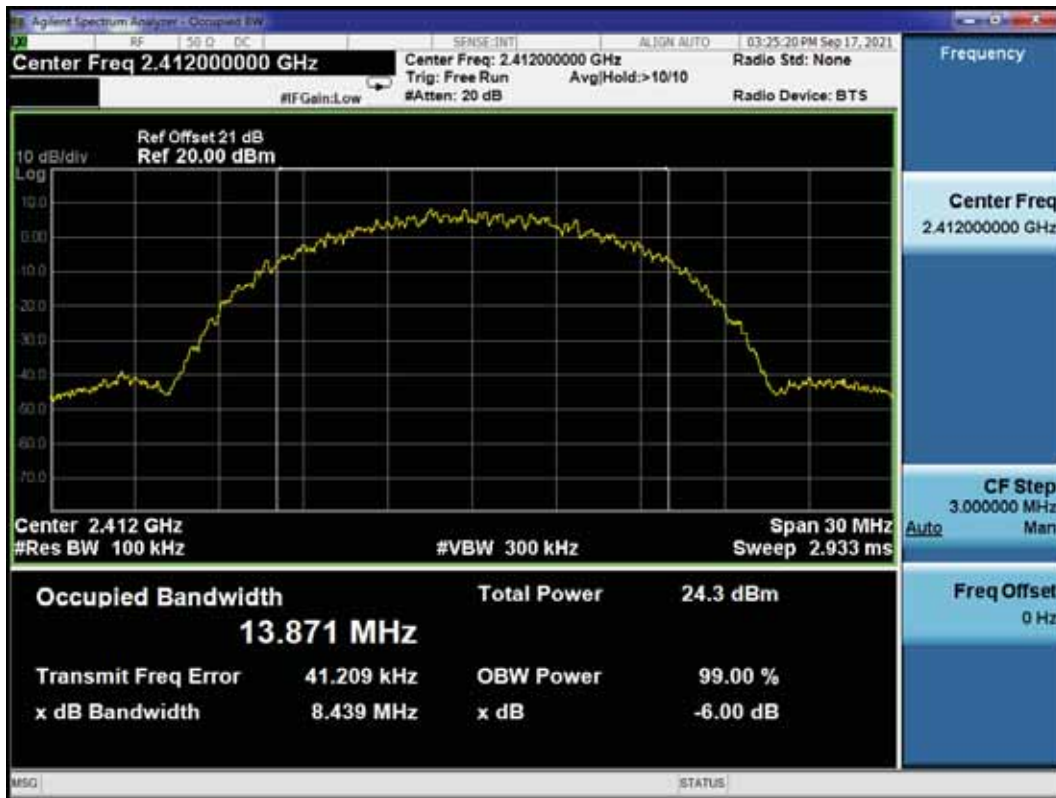

802.11b CH2437MHz



802.11b CH2462MHz

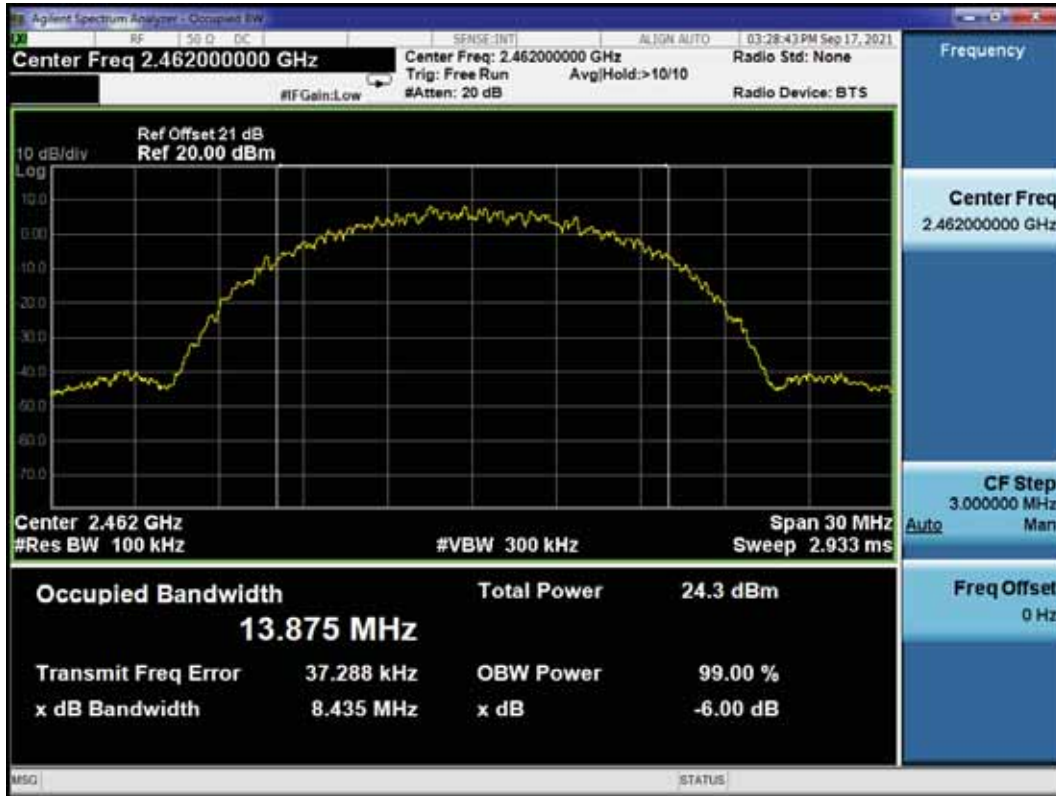

802.11g CH2412MHz



802.11g CH2437MHz

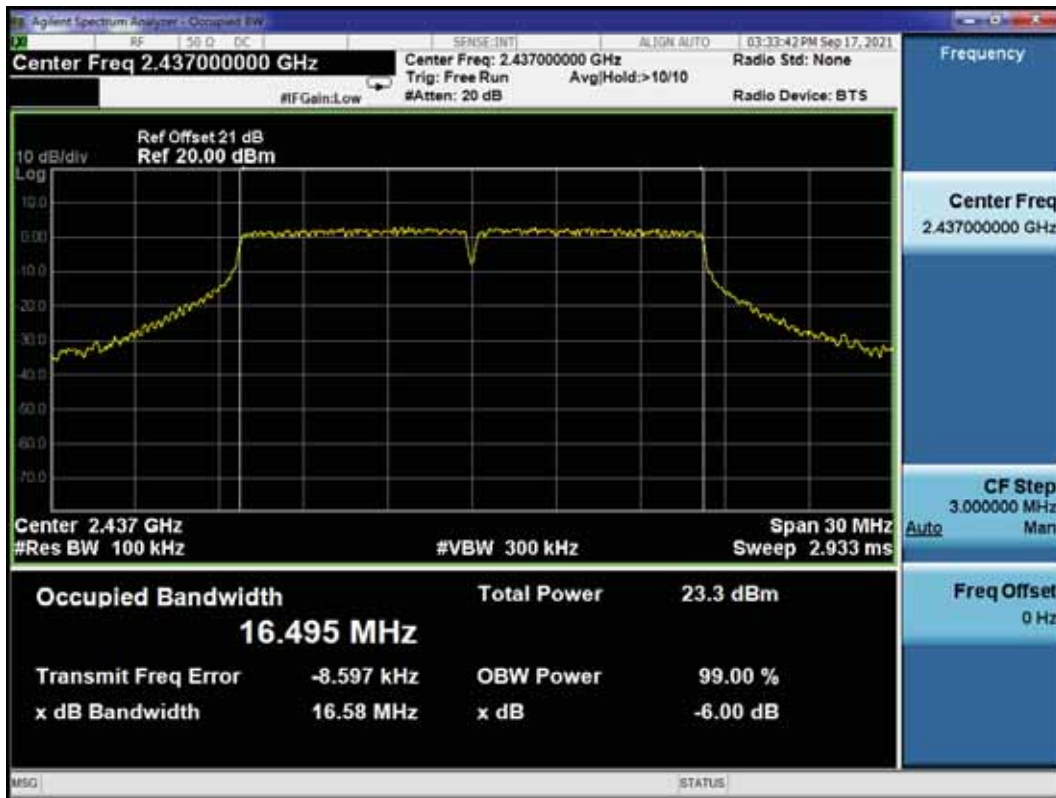

802.11g CH2462MHz



802.11n20 CH2412MHz



802.11n20 CH2437MHz

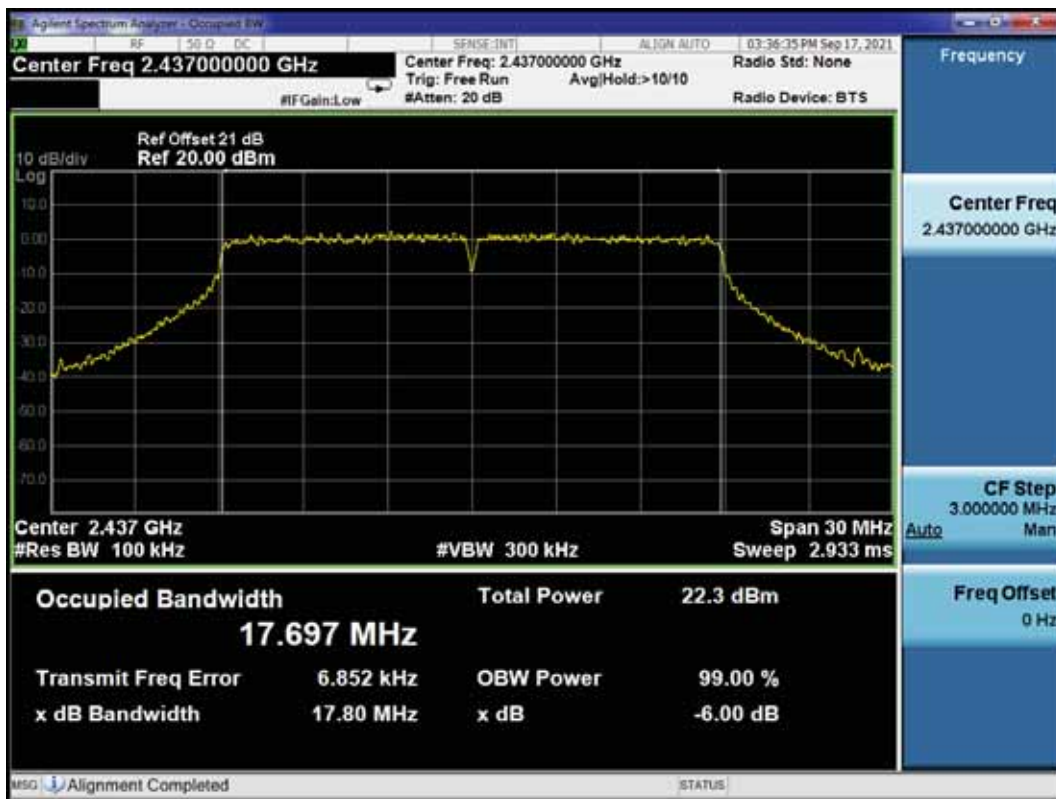

802.11n20 CH2462MHz



6 MAXIMUM PEAK OUTPUT POWER MEASUREMENT

6.1 Test Equipment

The following test equipment was used during the maximum peak output power measurement:

Item	Type	Manufacturer	Model No.	Serial No.	Cal. Date	Cal. Interval
1.	Spectrum Analyzer	Agilent	N9010A	MY52221182	2021.09.15	1 Year
2.	Coaxial Cable	WOKEN	SFL402-105F LEX	F02-150819-045	2021.03.08	1 Year
3.	20 dB Attenuator	Mini-Circuits	VAT-20+	001	2021.08.06	1 Year

6.2 Block Diagram of Test Setup

The Same as Section. 5.2.

6.3 Specification Limits ((§15.247(b)(3))

The Limits of maximum Peak Output Power for digital modulation in 2400-2483.5 MHz is: 1 Watt. (30 dBm)

6.4 Operating Condition of EUT

The switch ON/OFF was used to enable the EUT to change the channel one by one.

6.5 Test Procedure

The transmitter output was connected to the spectrum analyzer.

The following procedure can be used when the maximum available RBW of the instrument is less than the DTS bandwidth:

- a) Set the RBW = 1 MHz.
- b) Set the VBW \geq [3 RBW].
- c) Set the span \geq [1.5 DTS bandwidth].
- d) Detector = peak.
- e) Sweep time = auto couple.
- f) Trace mode = max hold.
- g) Allow trace to fully stabilize.
- h) Use the instrument's band/channel power measurement function with the band limits set equal to the DTS bandwidth edges (for some instruments, this may require a manual override to select the peak detector). If the instrument does not have a band power function, then sum the spectrum levels (in linear power units) at intervals equal to the RBW extending across the DTS channel bandwidth

The test procedure is defined in ANSI C63.10-2013 (11.9.1.2 Measurement Procedure " Integrated band power method" was used).

6.6 Test Results

PASSED.

All the test results are listed below.

(Test Date: 2021.09.17 Temperature: 23°C Humidity: 51 %)

Modulation	Channel	Frequency (MHz)	Peak Output Power (dBm)	Limit
802.11b	1	2412	22.81	30 dBm
	6	2437	22.76	30 dBm
	11	2462	22.82	30 dBm
802.11g	1	2412	21.85	30 dBm
	6	2437	24.39	30 dBm
	11	2462	20.96	30 dBm
802.11n20	1	2412	21.03	30 dBm
	6	2437	23.69	30 dBm
	11	2462	21.06	30 dBm

802.11b CH2412MHz



802.11b CH2437MHz



802.11b CH2462MHz



802.11g CH2412MHz



802.11g CH2437MHz

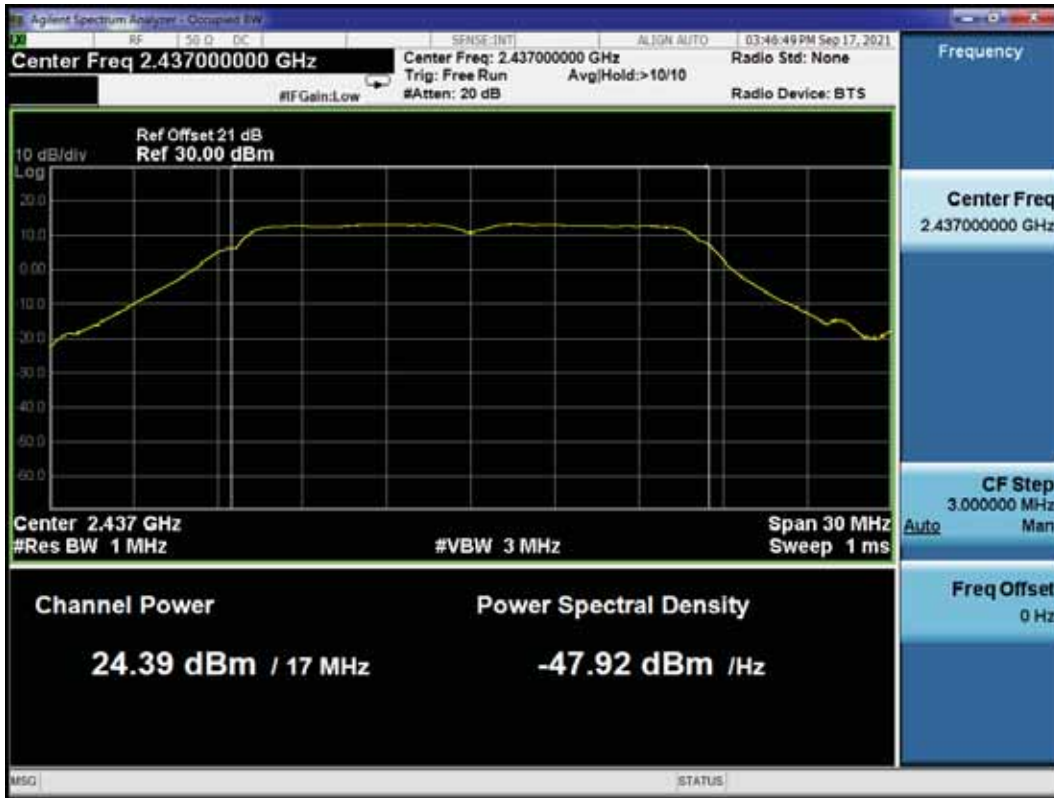

802.11g CH2462MHz



802.11n20 CH2412MHz



802.11n20 CH2437MHz



802.11n20 CH2462MHz



7 EMISSION LIMITATIONS MEASUREMENT

7.1 Test Equipment

The following test equipment was used during the emission limitations test:

Item	Type	Manufacturer	Model No.	Serial No.	Cal. Date	Cal. Interval
1.	Spectrum Analyzer	Agilent	N9010A	MY52221182	2021.09.15	1 Year
2.	Coaxial Cable	WOKEN	SFL402-105F LEX	F02-150819-045	2021.03.08	1 Year
3.	20 dB Attenuator	Mini-Circuits	VAT-20+	001	2021.08.06	1 Year

7.2 Block Diagram of Test Setup

The Same as Section. 5.2.

7.3 Specification Limits (§15.247(d))

In any 100 kHz bandwidth outside the frequency band in which the spread spectrum or digitally modulated intentional radiator is operating, the radio frequency power that is produced by the intentional radiator shall be at least 20 dB below that in the 100 kHz bandwidth within the band that contains the highest level of the desired power, based on either an RF conducted or a radiated measurement, provided the transmitter demonstrates compliance with the peak conducted power limits. If the transmitter complies with the conducted power limits based on the use of RMS averaging over a time interval, as permitted under paragraph (b)(3) of this section, the attenuation required under this paragraph shall be 30 dB instead of 20 dB. Attenuation below the general limits specified in §15.209(a) is not required.

In addition, radiated emissions which fall in the restricted bands, as defined in §15.205(a), must also comply with the radiated emission limits specified in §15.209(a) (see §15.205(c)). (※This test result attaching to Section. 3.7)

7.4 Operating Condition of EUT

The switch ON/OFF was used to enable the EUT to change the channel one by one.

7.5 Test Procedure

The transmitter output was connected to the spectrum analyzer.

Establish a reference level by using the following procedure:

- a) Set instrument center frequency to DTS channel center frequency.
- b) Set the span to ≥ 1.5 times the DTS bandwidth.
- c) Set the RBW = 100 kHz.
- d) Set the VBW $\geq [3 \times \text{RBW}]$.
- e) Detector = peak.
- f) Sweep time = auto couple.
- g) Trace mode = max hold.
- h) Allow trace to fully stabilize.
- i) Use the peak marker function to determine the maximum PSD level.

Note that the channel found to contain the maximum PSD level can be used to

establish the reference level.

Establish an emission level by using the following procedure:

- a) Set the center frequency and span to encompass frequency range to be measured.
- b) Set the RBW = 100 kHz.
- c) Set the VBW $\geq [3 \times \text{RBW}]$.
- d) Detector = peak.
- e) Sweep time = auto couple.
- f) Trace mode = max hold.
- g) Allow trace to fully stabilize.
- h) Use the peak marker function to determine the maximum amplitude level.

Ensure that the amplitude of all unwanted emissions outside of the authorized frequency band (excluding restricted frequency bands) is attenuated by at least the minimum requirements specified in 11.11. Report the three highest emissions relative to the limit.

Scan up through 10th harmonic.

The test procedure is defined in ANSI C63.10-2013 (11.11.2 Reference level measurement and 11.11.3 Emission level measurement was used).

7.6 Test Results

PASSED.

The test data was attached in the next pages.

(Test Date: 2021.09.17 Temperature: 23°C Humidity: 51 %)

Modulation	Channel	Frequency (MHz)	Data Page
802.11b	1	2412 MHz	P46-47
	6	2437 MHz	P48-49
	11	2462 MHz	P50-51
802.11g	1	2412 MHz	P52-53
	6	2437 MHz	P54-55
	11	2462 MHz	P56-57
802.11n20	1	2412 MHz	P58-59
	6	2437 MHz	P60-61
	11	2462 MHz	P62-63

802.11b CH2412MHz

Reference level



Emission level





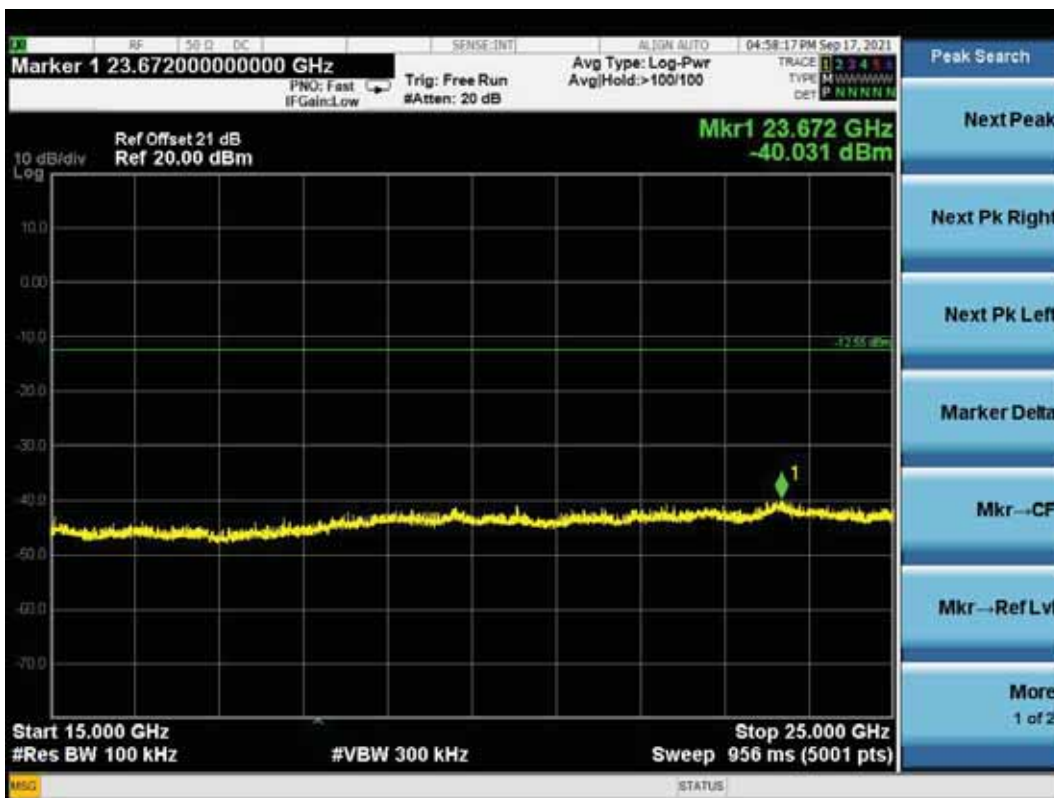

802.11b CH2462MHz

Reference level

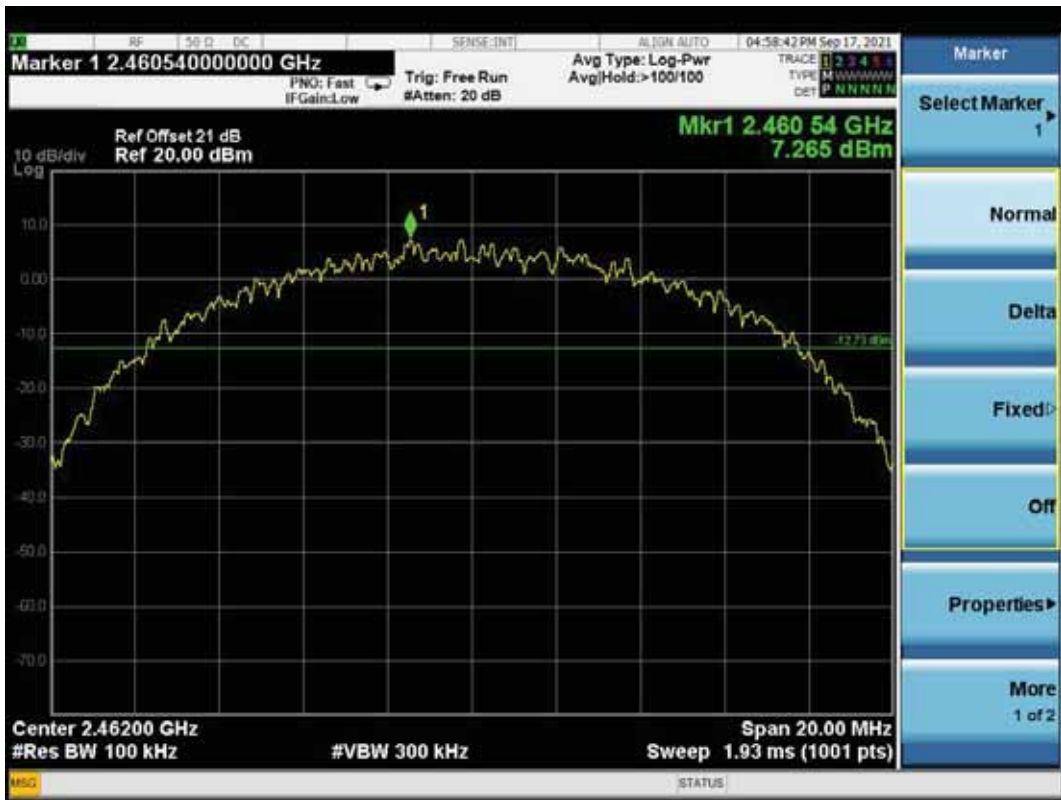

Emission level





802.11g CH2412MHz

Reference level

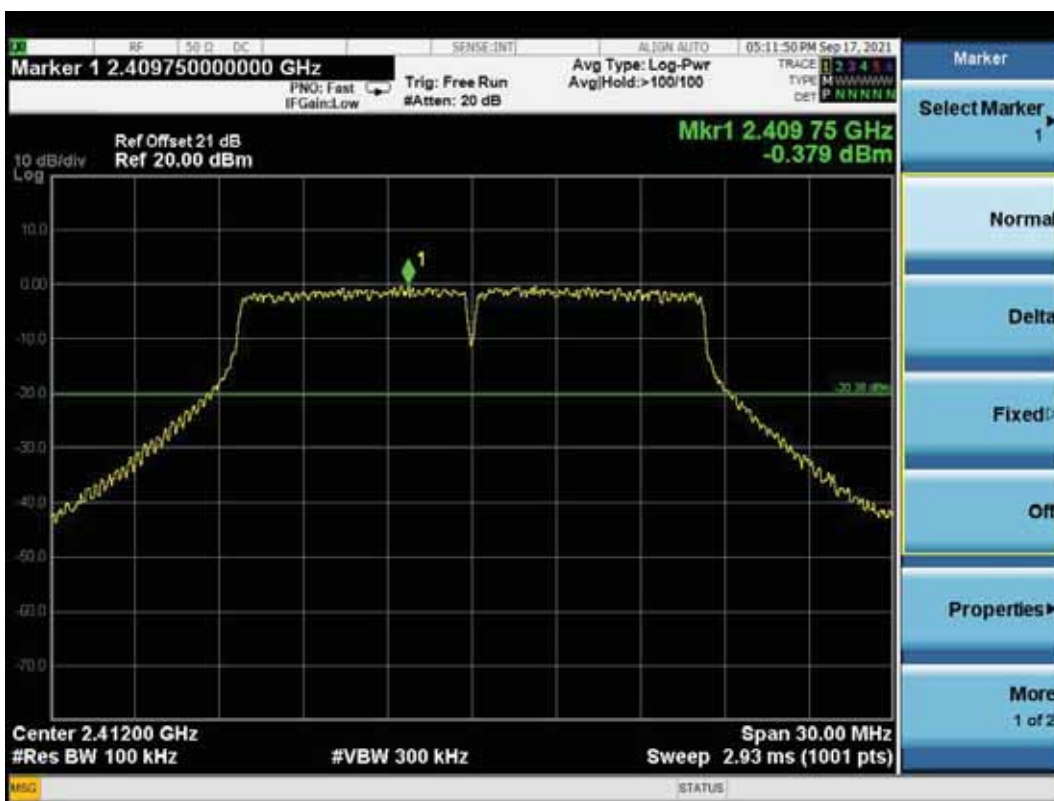

Emission level

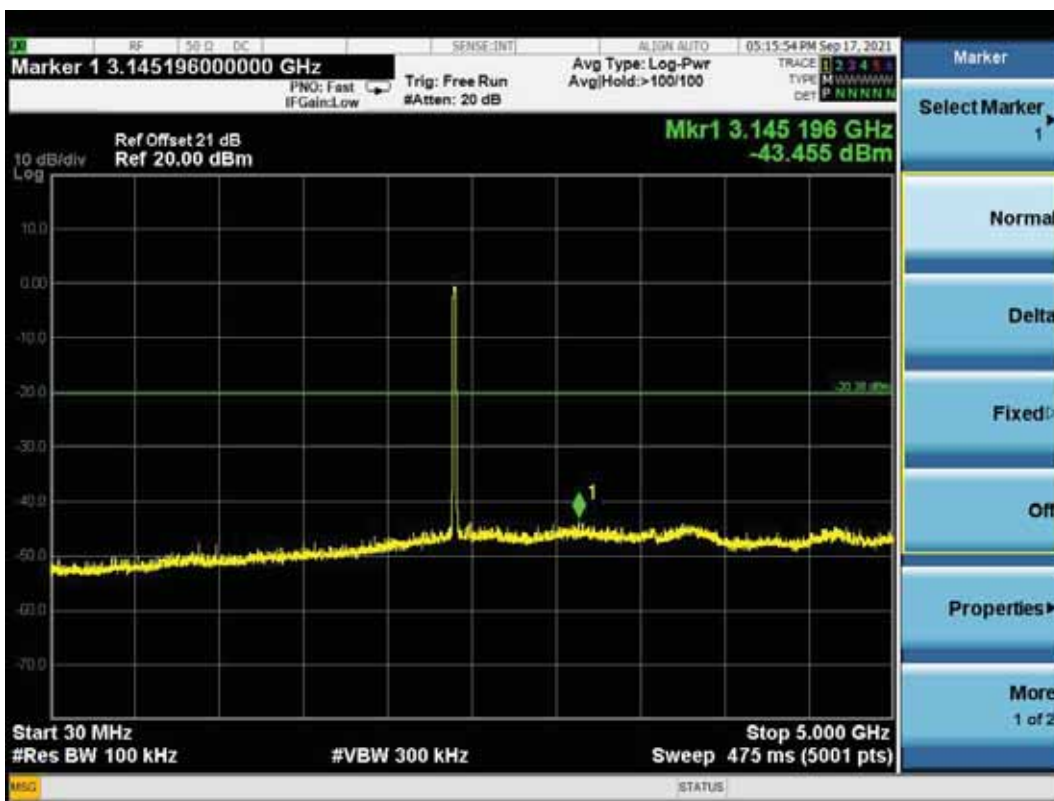

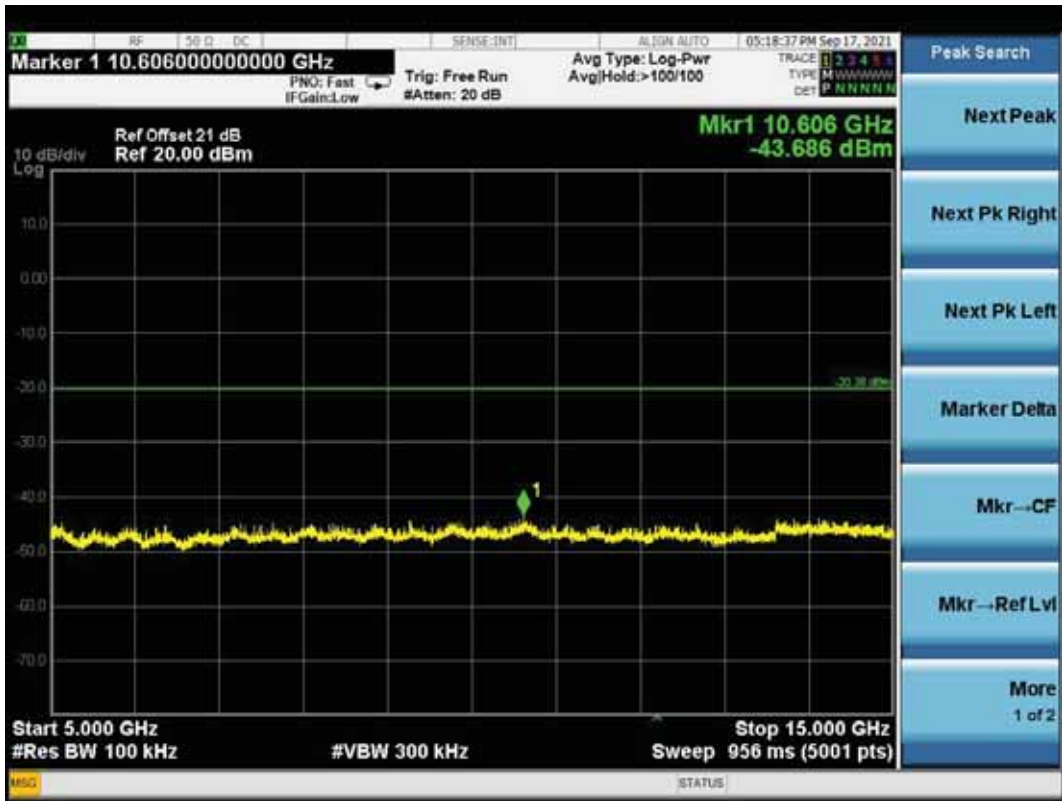

802.11g CH2437MHz

Reference level



Emission level

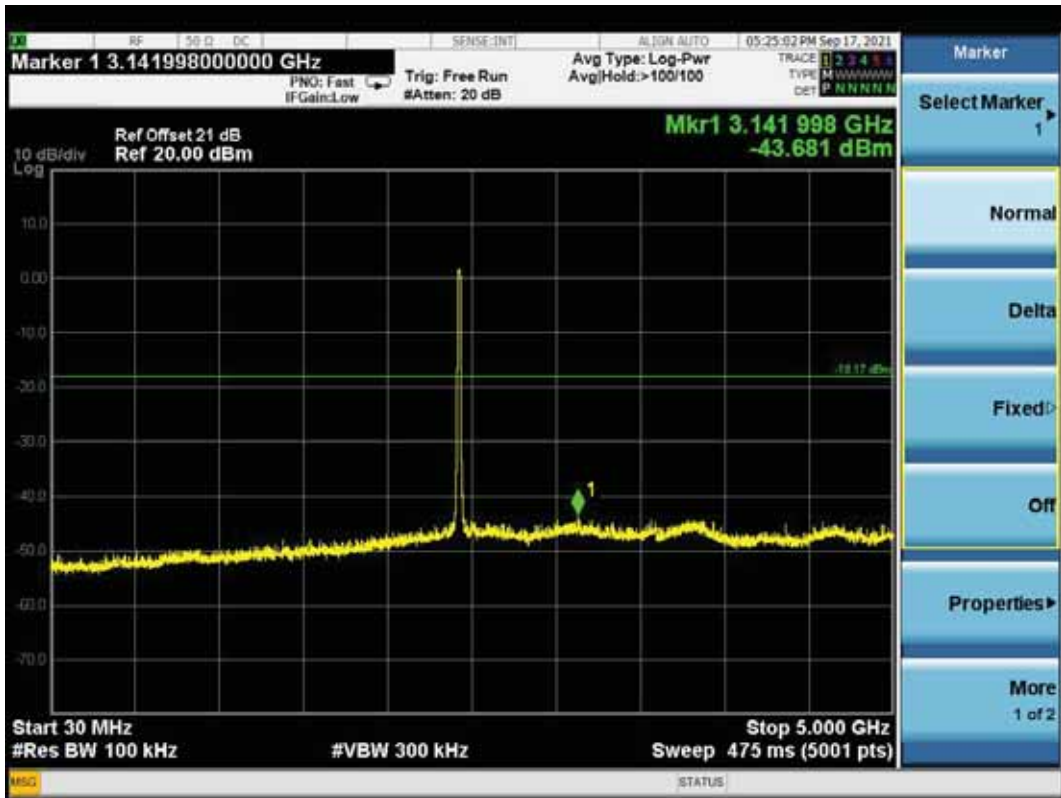



802.11g CH2462MHz

Reference level



Emission level



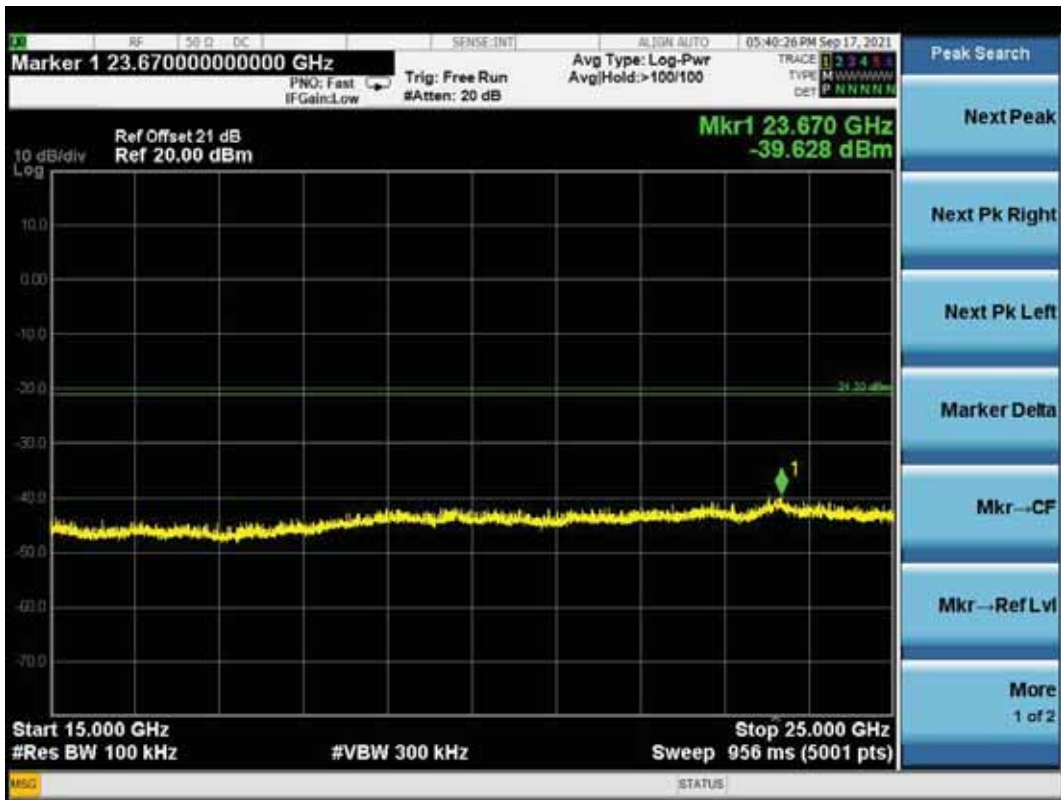

802.11n20 CH2412MHz

Reference level



Emission level



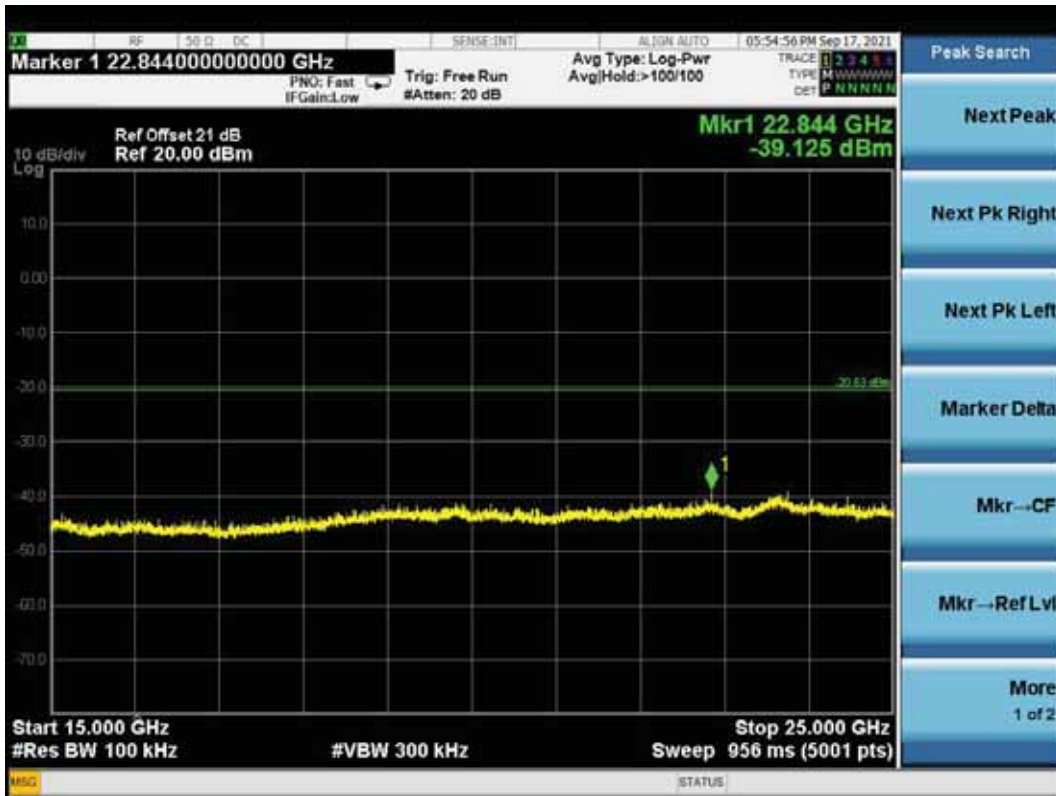
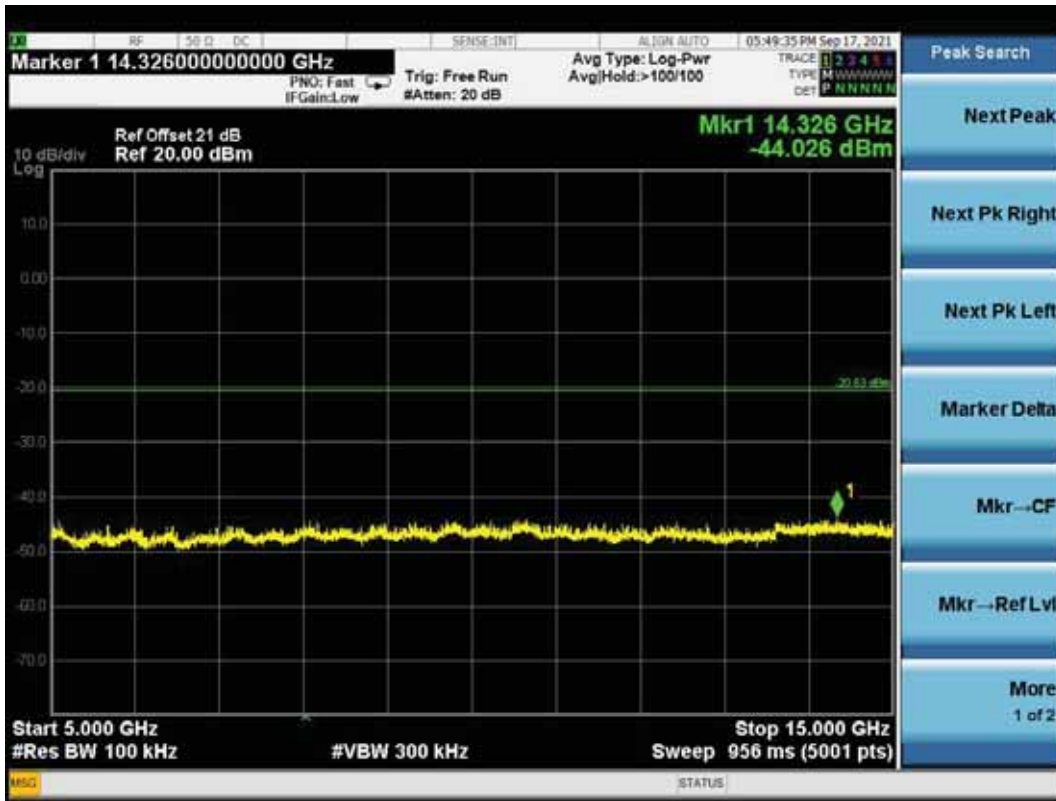

802.11n20 CH2437MHz

Reference level



Emission level



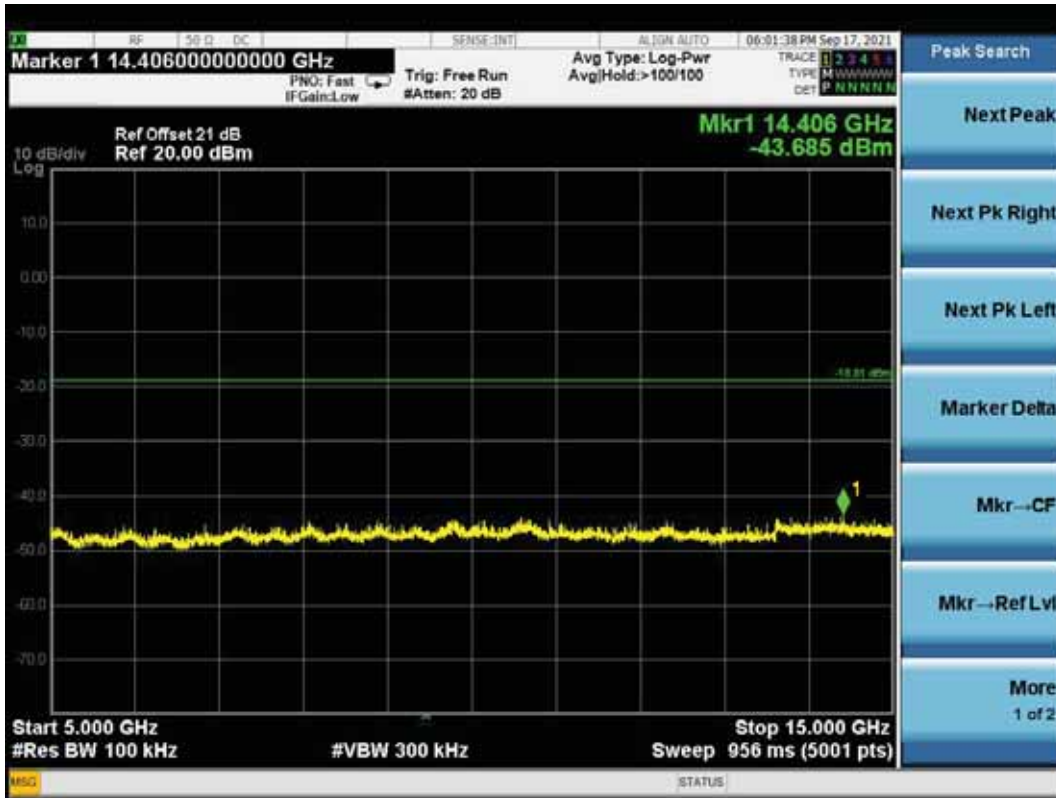

802.11n20 CH2462MHz

Reference level

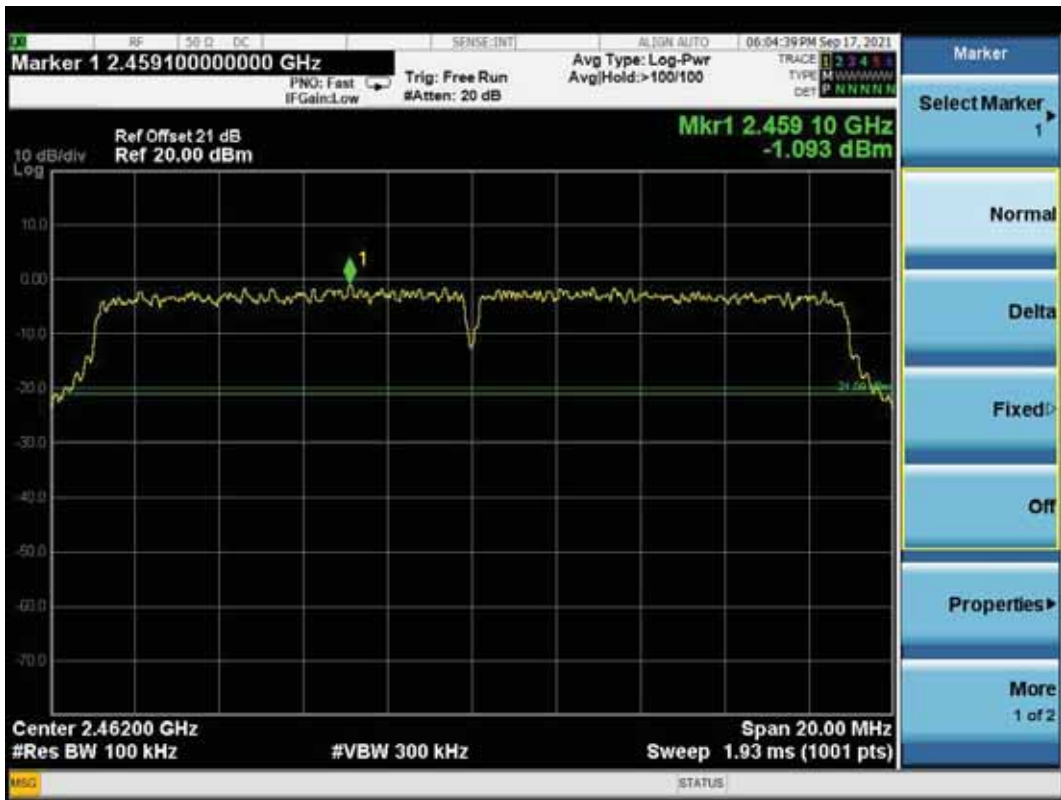

Emission level



8 BAND EDGES MEASUREMENT

8.1 Test Equipment

The following test equipment was used during the band edges measurement:

Item	Type	Manufacturer	Model No.	Serial No.	Cal. Date	Cal. Interval
1.	Spectrum Analyzer	Agilent	N9010A	MY52221182	2021.09.15	1 Year
2.	Coaxial Cable	WOKEN	SFL402-105F LEX	F02-150819-045	2021.03.08	1 Year
3.	20 dB Attenuator	Mini-Circuits	VAT-20+	001	2021.08.06	1 Year

8.2 Block Diagram of Test Setup

The Same as section. 5.2.

8.3 Specification Limits (§15.247(d))

In any 100 kHz bandwidth outside the frequency band in which the spread spectrum or digitally modulated intentional radiator is operating, the radio frequency power that is produced by the intentional radiator shall be at least 20 dB below that in the 100 kHz bandwidth within the band that contains the highest level of the desired power, based on either an RF conducted or a radiated measurement, provided the transmitter demonstrates compliance with the peak conducted power limits. If the transmitter complies with the conducted power limits based on the use of RMS averaging over a time interval, as permitted under paragraph (b)(3) of this section, the attenuation required under this paragraph shall be 30 dB instead of 20 dB. Attenuation below the general limits specified in §15.209(a) is not required.

8.4 Operating Condition of EUT

The switch ON/OFF was used to enable the EUT to change the channel one by one.

8.5 Test Procedure

The transmitter output was connected to the spectrum analyzer. Set RBW of Test Receiver to 100kHz and VBW to 300kHz with suitable frequency span including 100kHz bandwidth from band edge.

The test procedure is defined in ANSI C63.10-2013 (11.11.3 Emission level measurement was used).

8.6 Test Results

PASSED.

All the test results are attached in next pages.

(Test Date: 2021.09.17 Temperature: 23°C Humidity: 51 %)

Modulation	Location	Channel	Frequency (MHz)	Delta Marker (dB)	Result
802.11b	Below Band Edge	1	2412	54.148	More than 20 dB below the highest level of the desired power
	Upper Band Edge	11	2462	54.266	
802.11g	Below Band Edge	1	2412	46.023	More than 20 dB below the highest level of the desired power
		2	2417	46.356	
	Upper Band Edge	10	2457	44.819	
		11	2462	45.371	
802.11n20	Below Band Edge	1	2412	45.006	More than 20 dB below the highest level of the desired power
		2	2417	45.99	
	Upper Band Edge	10	2457	45.428	
		11	2462	45.258	

802.11b CH2412MHz (Below Edge 2390 MHz)

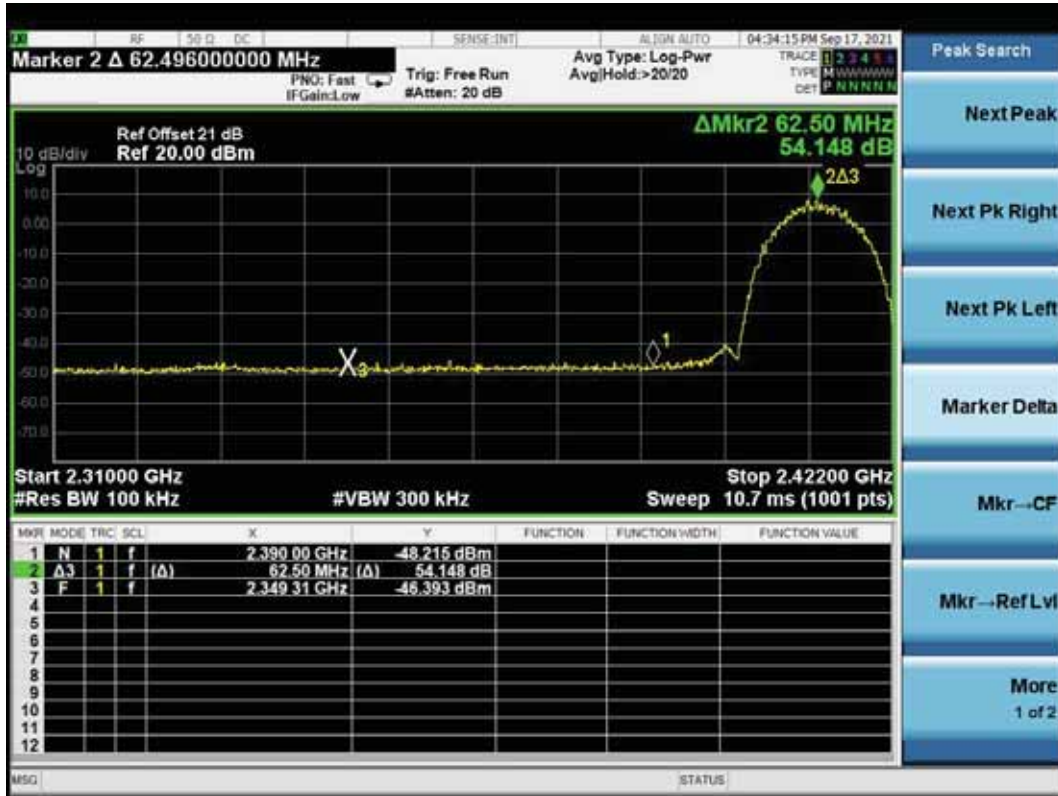

802.11b CH2462MHz (Upper Edge 2483.5 MHz)



802.11g CH2412MHz (Below Edge 2390 MHz)

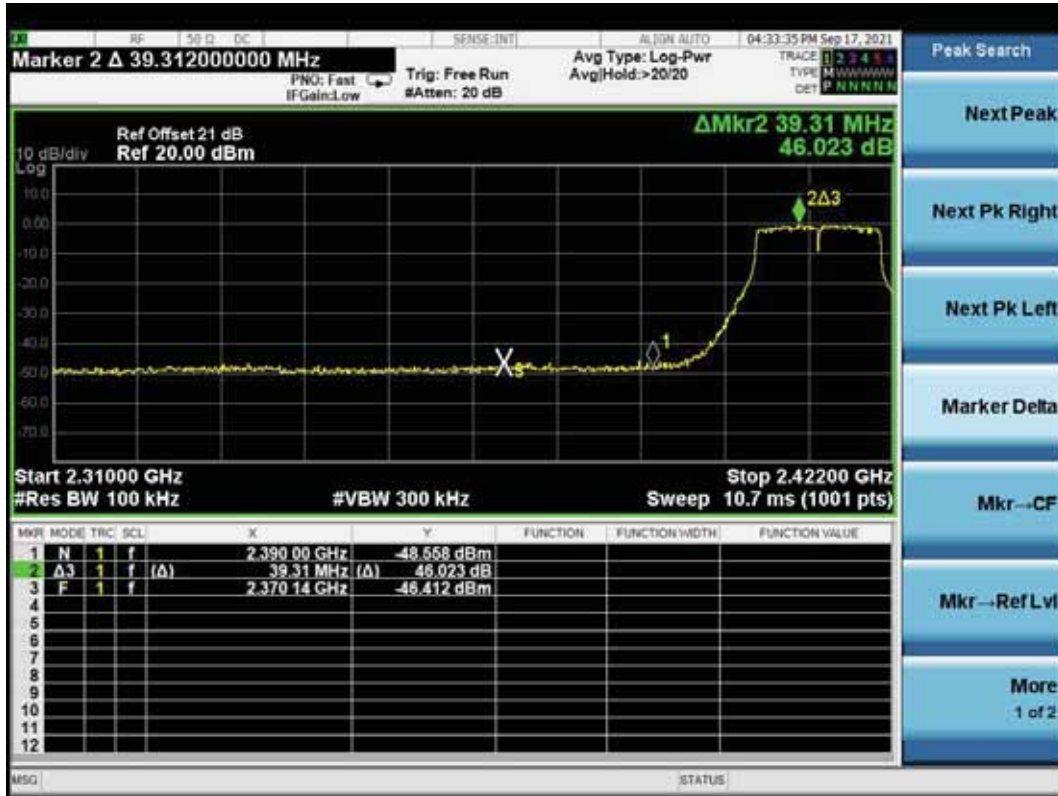

802.11g CH2417MHz (Below Edge 2390 MHz)



802.11g CH2457MHz (Upper Edge 2483.5 MHz)



802.11g CH2462MHz (Upper Edge 2483.5 MHz)



802.11n20 CH2412MHz (Below Edge 2390 MHz)

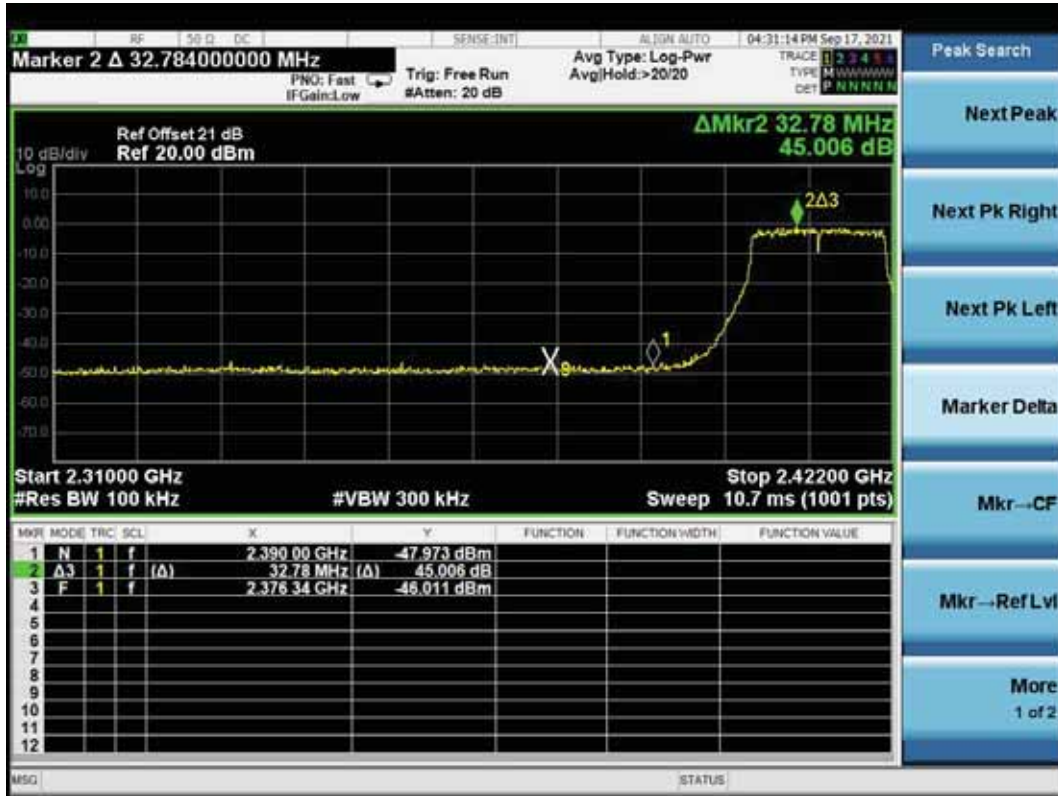

802.11n20 CH2417MHz (Below Edge 2390 MHz)



802.11n20 CH2457MHz (Upper Edge 2483.5 MHz)

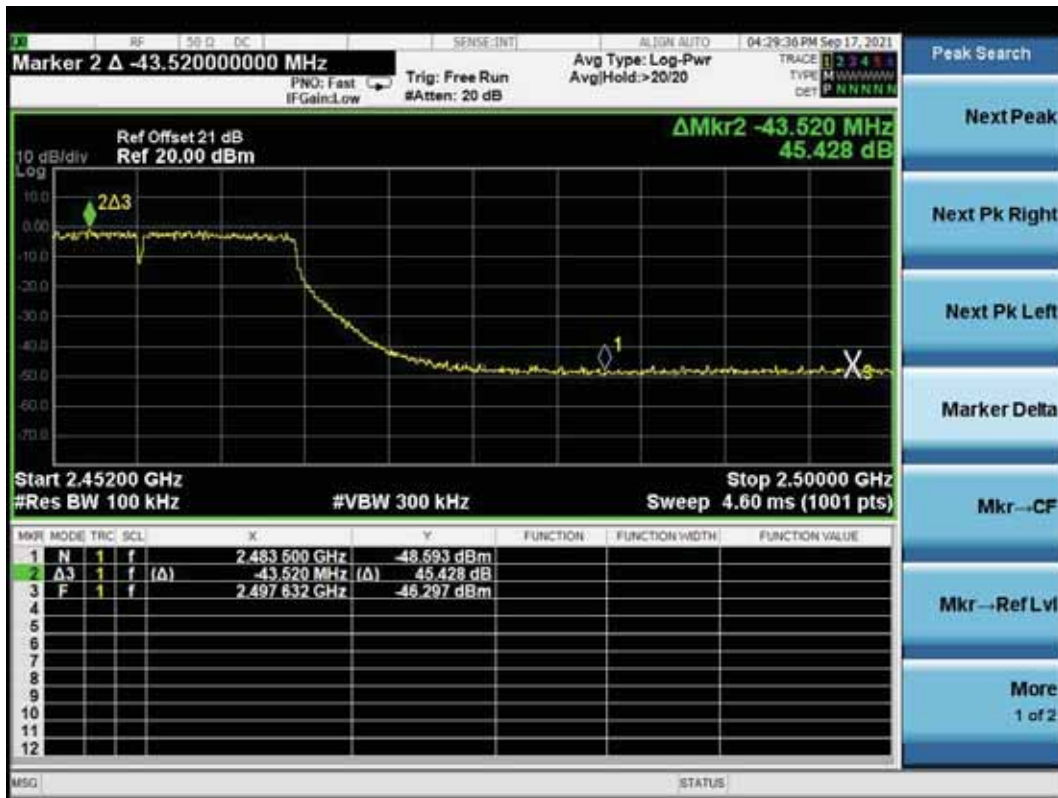

802.11n20 CH2462MHz (Upper Edge 2483.5 MHz)



9 POWER SPECTRAL DENSITY MEASUREMENT

9.1 Test Equipment

The following test equipment was used during the power spectral density measurement:

Item	Type	Manufacturer	Model No.	Serial No.	Cal. Date	Cal. Interval
1.	Spectrum Analyzer	Agilent	N9010A	MY52221182	2021.09.15	1 Year
2.	Coaxial Cable	WOKEN	SFL402-105F LEX	F02-150819-0 45	2021.03.08	1 Year
3.	20 dB Attenuator	Mini-Circuits	VAT-20+	001	2021.08.06	1 Year

9.2 Block Diagram of Test Setup

The Same as section 5.2.

9.3 Specification Limits (§15.247(e))

The peak power spectral density conducted from the intentional radiator to the antenna shall not be greater than 8 dBm in any 3 kHz band.

9.4 Operating Condition of EUT

The switch ON/OFF was used to enable the EUT to change the channel one by one.

9.5 Test Procedure

The transmitter output was connected to the spectrum analyzer.

- a) Set analyzer center frequency to DTS channel center frequency.
- b) Set the span to 1.5 times the DTS bandwidth.
- c) Set the RBW to $3 \text{ kHz} \leq \text{RBW} \leq 100 \text{ kHz}$.
- d) Set the VBW $\geq [3 \times \text{RBW}]$.
- e) Detector = peak.
- f) Sweep time = auto couple.
- g) Trace mode = max hold.
- h) Allow trace to fully stabilize.
- i) Use the peak marker function to determine the maximum amplitude level within the RBW.
- j) If measured value exceeds requirement, then reduce RBW (but no less than 3 kHz) and repeat.

The test procedure is defined in ANSI C63.10-2013 (11.10.2 Measurement Procedure “Method PKPSD (peak PSD)” was used).

9.6 Test Results

PASSED.

All the test results are attached in next pages.

(Test Date: 2021.09.17 Temperature: 23°C Humidity: 51 %)

Modulation	Channel	Frequency (MHz)	Power Spectral Density (dBm)	Limit
802.11b	1	2412	-6.147	8 dBm
	6	2437	-6.424	8 dBm
	11	2462	-6.355	8 dBm
802.11g	1	2412	-14.269	8 dBm
	6	2437	-11.817	8 dBm
	11	2462	-15.166	8 dBm
802.11n20	1	2412	-14.937	8 dBm
	6	2437	-12.298	8 dBm
	11	2462	-14.904	8 dBm

802.11b CH2412 MHz

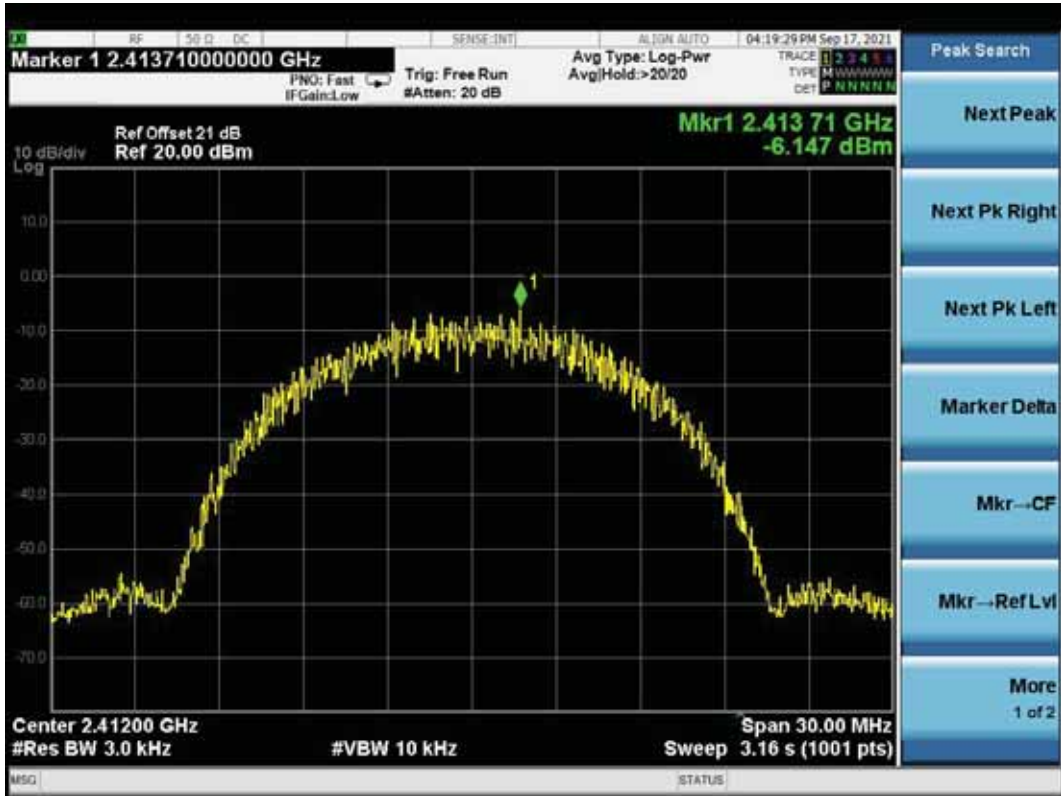

802.11b CH2437 MHz

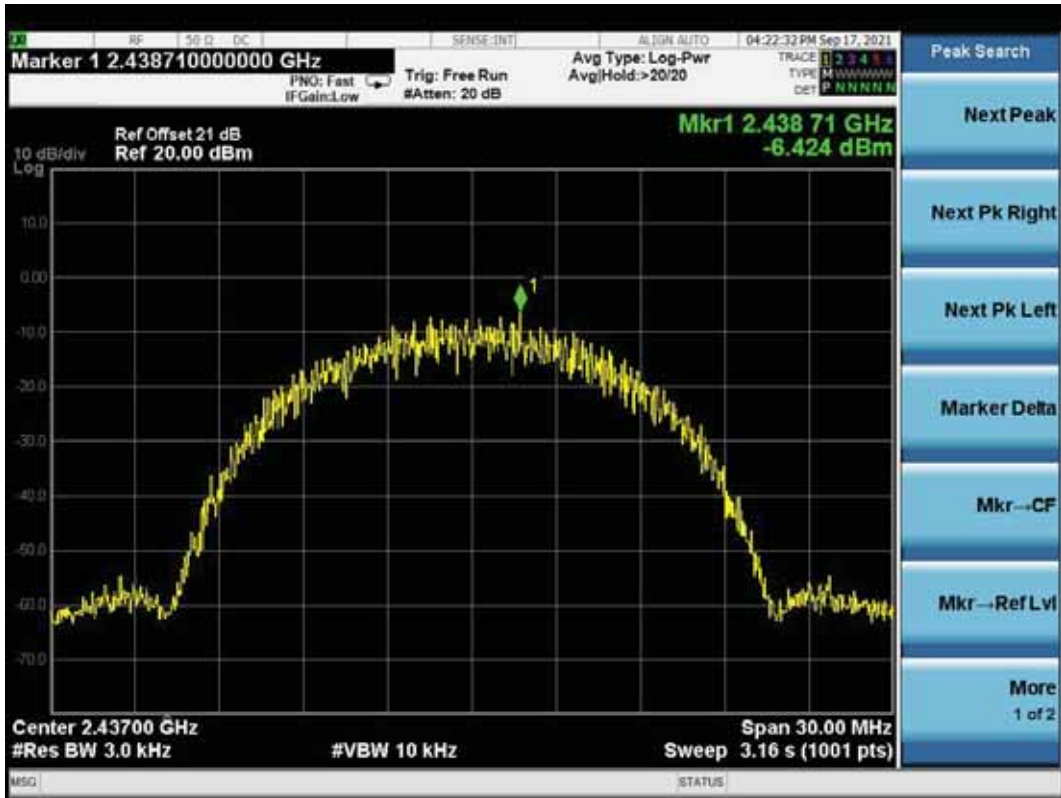

802.11b CH2462 MHz

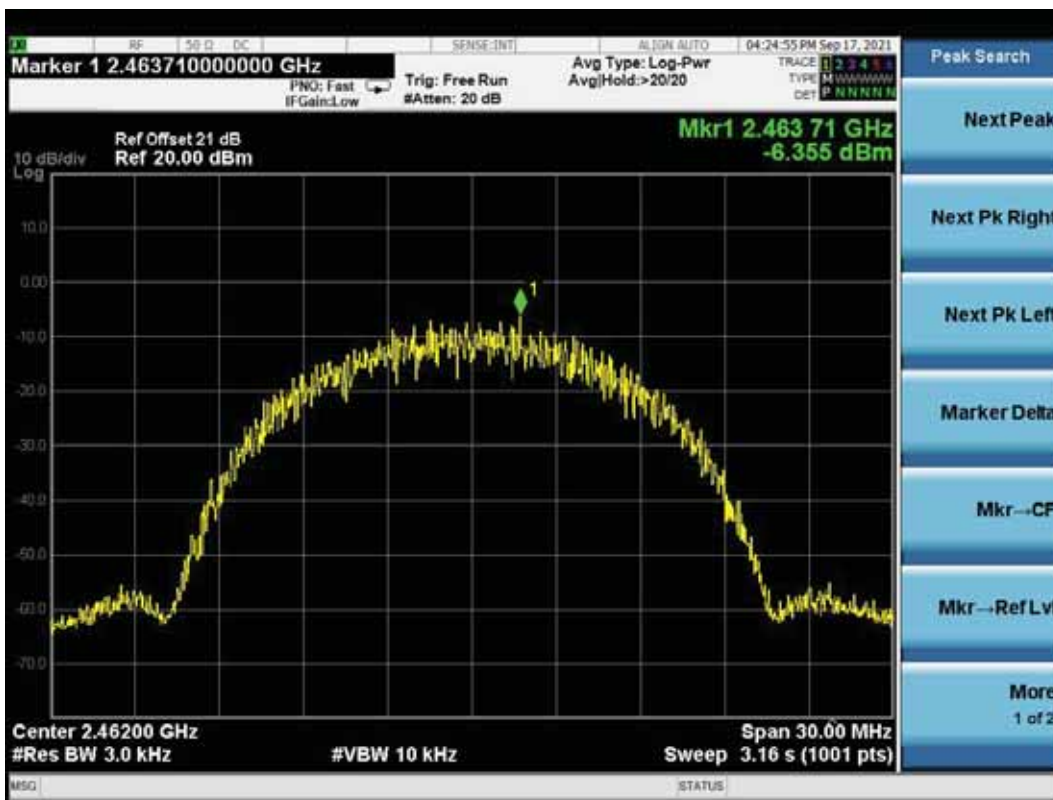

802.11g CH2412 MHz

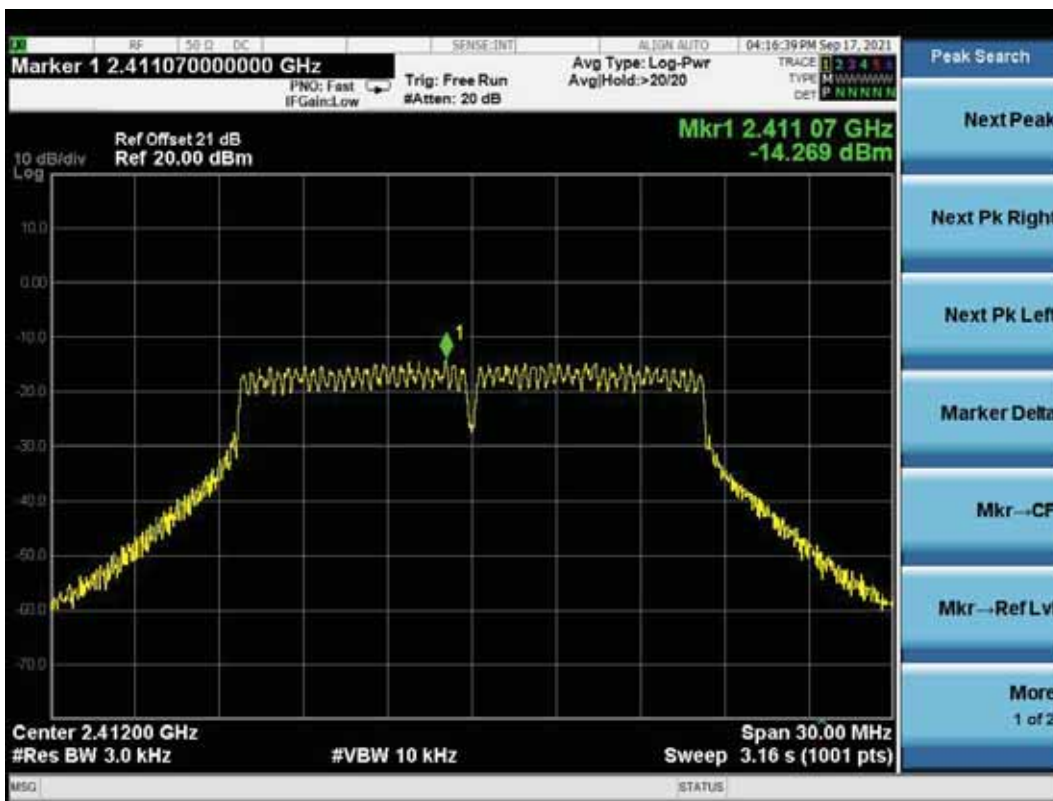

802.11g CH2437 MHz

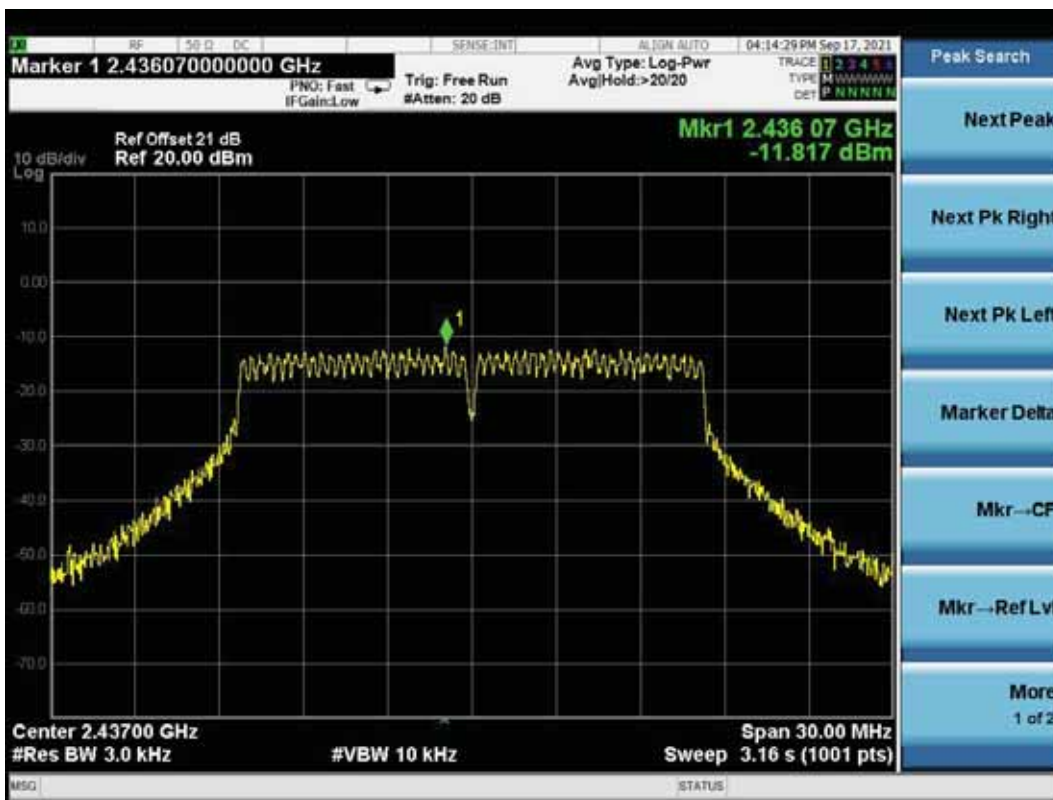

802.11g CH2462 MHz

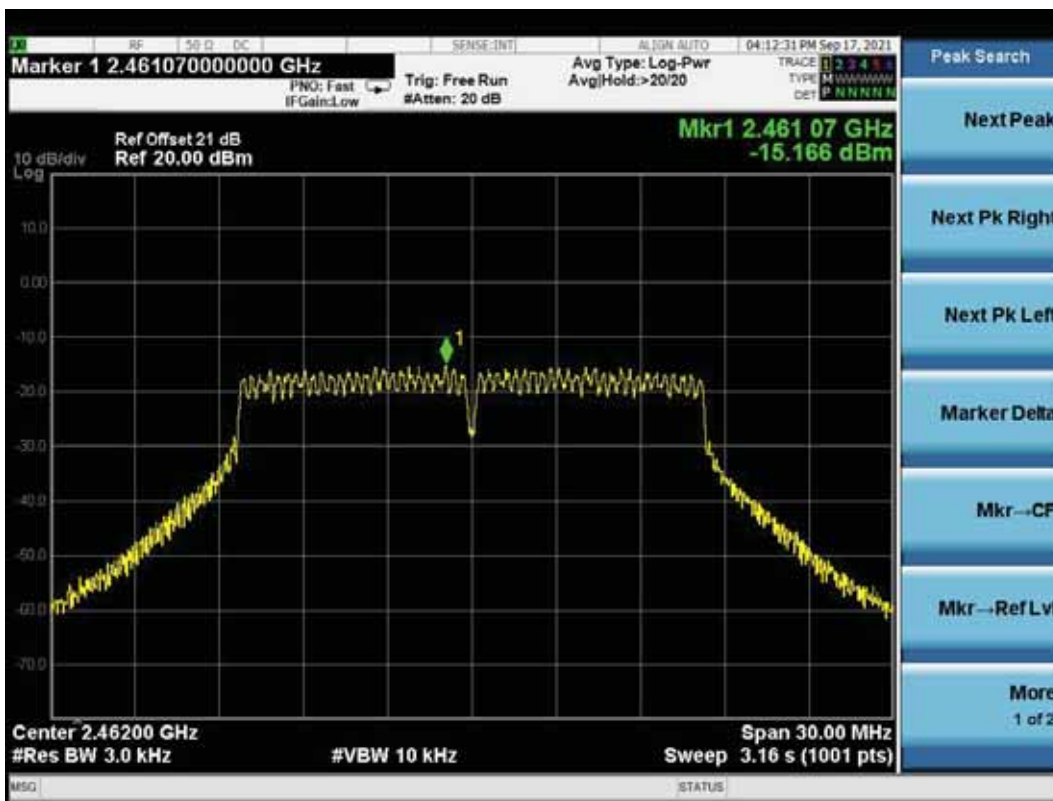

802.11n20 CH2412 MHz

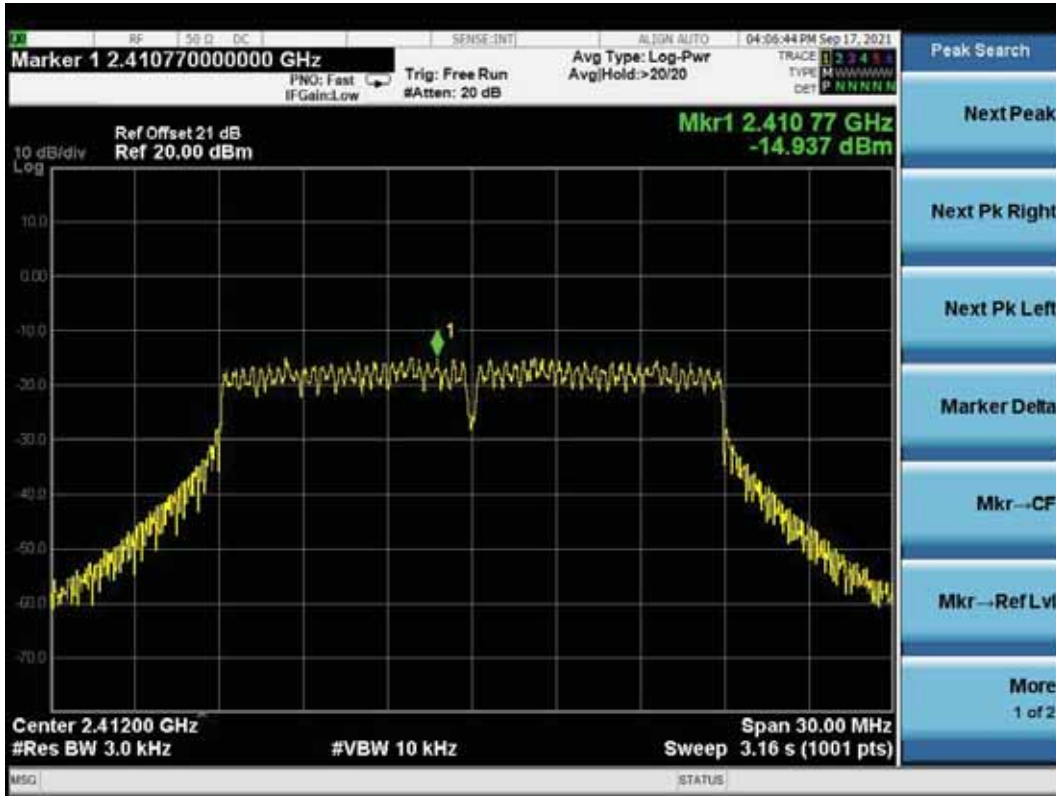

802.11n20 CH2437 MHz

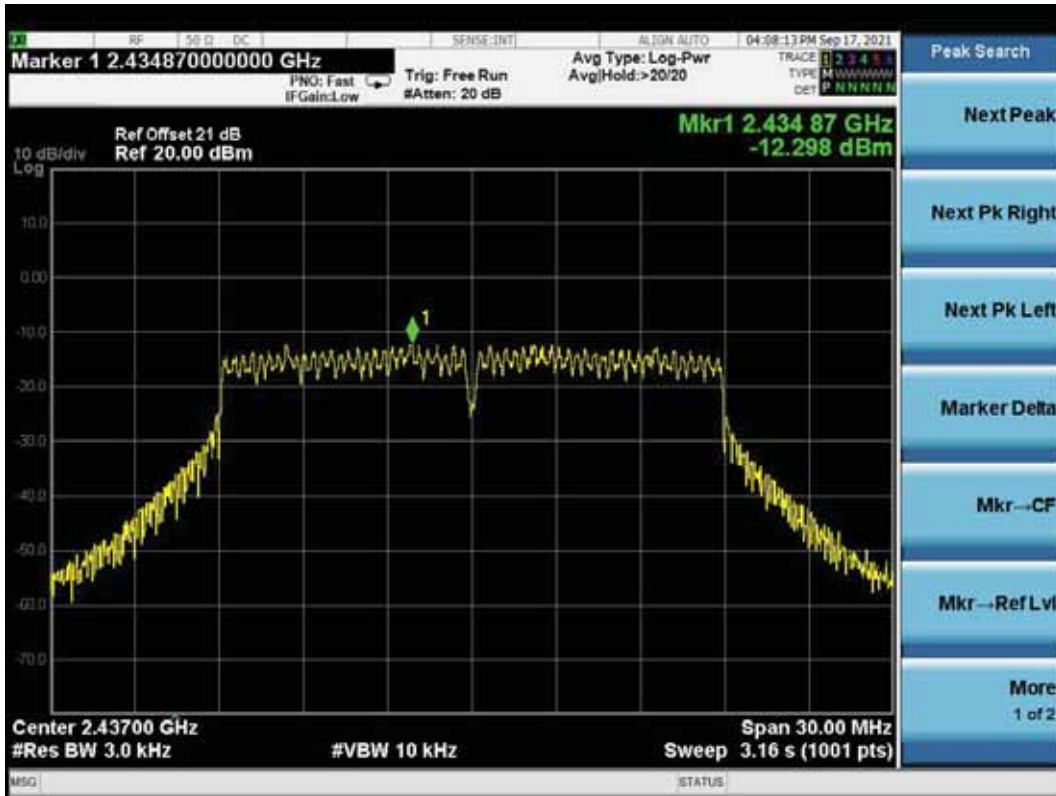

802.11n20 CH2462 MHz

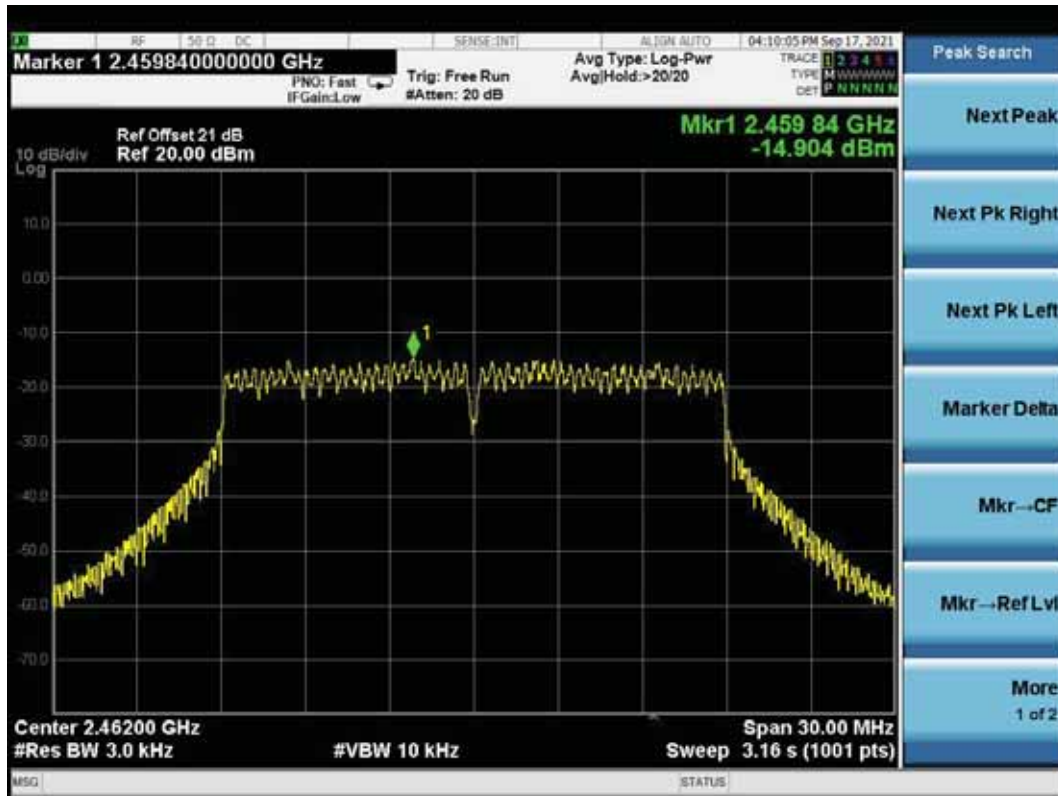

10 DEVIATION TO TEST SPECIFICATIONS

None.

11 MEASUREMENT UNCERTAINTY LIST

The measurement uncertainty was estimated for test on the EUT according to CISPR 16-4-2. This uncertainty represents an expanded uncertainty expressed at approximately the 95% confidence level using a coverage of K=2.

The uncertainties value is not used in determining the PASS/FAIL results.

Test Items/Facilities	Frequency/Equipment/Unit	Uncertainty
Conducted Emission No.1 Shielded Room	9kHz~150kHz	±3.1 dB
	150kHz~30MHz	±2.6 dB
Conducted Emission No.3 Shielded Room	9kHz~150kHz	±3.1 dB
	150kHz~30MHz	±2.6 dB
Radiated Emission	30MHz~200MHz, Horizontal	±3.8 dB
	30MHz~200MHz, Vertical	±4.1 dB
	200MHz~1000MHz, Horizontal	±3.6 dB
	200MHz~1000MHz, Vertical	±5.1 dB
	1GHz~6GHz	±5.3 dB
	6GHz~18GHz	±5.3 dB
	18GHz~40GHz	±3.5 dB
Output Power Test	50MHz~18GHz	0.77 dB
Power Density Test	9kHz~6GHz	1.08 dB
RF Frequency Test	9kHz~40GHz	6×10^{-4}
Bandwidth Test	9kHz~6GHz	1.5×10^{-3}
RF Radiated Power Test	30MHz~1000MHz	3.06 dB
Conducted Output Power Test	50MHz~18GHz	0.83 dB
AC Voltage(<10kHz) Test	120V~230V	0.04 %
DC Power Test	0V~30V	0.4 %
Temperature	-40°C~+100°C	0.52 °C
Humidity	30%~95%	2.6 %