

TEST REPORT
On behalf of

Savant Technologies LLC, dba GE Lighting, a Savant company

Product Name: Direct connect Full Color A19

Model No.: CLEDA199CD1

FCC ID: PUU-A19-DMFCIV

Prepared For: Savant Technologies LLC, dba GE Lighting, a Savant company
1975 Noble Road, Cleveland, OH 44112

Prepared By: Audix Technology (Shanghai) Co., Ltd.
3F and 4F, 34Bldg, 680 Guiping Rd.,
Caohejing Hi-Tech Park,
Shanghai 200233, China

Tel: +86-21-64955500



File No. : C1D2109048
Report No. : ACI-F21204
Date of Test : 2021.09.15-22
Date of Report : 2021.09.30

The statement is based on a single evaluation of one sample of the above-mentioned products. It does not imply an assessment of the whole production and does not permit the use of the test lab logo. The report must not be used by the client to claim product certification, approval, or endorsement by NVLAP, NIST, or any agency of the Federal Government.

TABLE OF CONTENTS

	Page
1 SUMMARY OF STANDARDS AND RESULTS.....	5
1.1 Description of Standards and Results.....	5
2 GENERAL INFORMATION.....	6
2.1 Description of Equipment Under Test.....	6
2.2 EUT Specifications Assessed in Current Report.....	7
2.3 Test Information.....	7
2.4 Sample Description.....	7
2.5 Supported equipment.....	8
2.6 Description of Test Facility.....	8
3 CONDUCTED EMISSION TEST.....	9
3.1 Test Equipment.....	9
3.2 Block Diagram of Test Setup.....	9
3.3 Conducted Emission Limits (§15.207).....	10
3.4 Test Configuration.....	10
3.5 Operating Condition of EUT.....	10
3.6 Test Procedures.....	10
3.7 Test Results.....	11
4 RADIATED EMISSION TEST.....	13
4.1 Test Equipment.....	13
4.2 Block Diagram of Test Setup.....	13
4.3 Radiated Emission Limit (§15.209).....	14
4.4 Test Configuration.....	14
4.5 Operating Condition of EUT.....	15
4.6 Test Procedures.....	15
4.7 Test Results.....	16
5 6 DB BANDWIDTH MEASUREMENT.....	22
5.1 Test Equipment.....	22
5.2 Block Diagram of Test Setup.....	22
5.3 Specification Limits (§15.247(a)(2)).....	22
5.4 Operating Condition of EUT.....	22
5.5 Test Procedure.....	22
5.6 Test Results.....	23
6 MAXIMUM PEAK OUTPUT POWER MEASUREMENT.....	26
6.1 Test Equipment.....	26
6.2 Block Diagram of Test Setup.....	26
6.3 Specification Limits ((§15.247(b)(3)).....	26
6.4 Operating Condition of EUT.....	26
6.5 Test Procedure.....	26
6.6 Test Results.....	27
7 EMISSION LIMITATIONS MEASUREMENT.....	30
7.1 Test Equipment.....	30
7.2 Block Diagram of Test Setup.....	30
7.3 Specification Limits (§15.247(d)).....	30

7.4 Operating Condition of EUT 30

7.5 Test Procedure 30

7.6 Test Results 32

8 BAND EDGES MEASUREMENT 39

8.1 Test Equipment..... 39

8.2 Block Diagram of Test Setup 39

8.3 Specification Limits (§15.247(d)) 39

8.4 Operating Condition of EUT 39

8.5 Test Procedure 39

8.6 Test Results 40

9 POWER SPECTRAL DENSITY MEASUREMENT 42

9.1 Test Equipment..... 42

9.2 Block Diagram of Test Setup 42

9.3 Specification Limits (§15.247(e)) 42

9.4 Operating Condition of EUT 42

9.5 Test Procedure 42

9.6 Test Results 43

10 DEVIATION TO TEST SPECIFICATIONS 46

11 MEASUREMENT UNCERTAINTY LIST 47

TEST REPORT

Applicant : Savant Technologies LLC, dba GE Lighting, a Savant company
 EUT Description : Direct connect Full Color A19
 (A) Model No. : CLEDA199CD1
 (B) Power Supply : 120V AC 60Hz
 (C) Test Voltage : 120V/60Hz

Test Procedure Used:

*FCC RULES AND REGULATIONS PART 15 SUBPART C
 AND ANSI C63.10-2013*

The device described above is tested by Audix Technology (Shanghai) Co., Ltd. to determine the maximum emission levels emanating from the device. The maximum emission levels are compared to the FCC Part 15 Subpart C limits.

The test results are contained in this test report and Audix Technology (Shanghai) Co., Ltd. is assumed full responsibility for the accuracy and completeness of these measurements. This report also shows that the EUT (M/N: Refer to Sec2.1), which was tested is technically compliance with the FCC limits.

This report applies to above tested Sample only. This report shall not be reproduced in part without written approval of Audix Technology (Shanghai) Co., Ltd.

The test results for EUT's WIFI function are contained in No.ACI-F21205 report.

Date of Test : 2021.04.10-18 Date of Report : 2021.09.30

Producer : Alan He
 ALAN HE / Assistant

Review : Byron Wu
 BYRON WU/ Deputy Assistant Manager

AUDIX[®] For and on behalf of
 Audix Technology (Shanghai) Co., Ltd.

Signatory : Byron Kwo
 Authorized Signature(s) BYRON KWO/Assistant General Manager

1 SUMMARY OF STANDARDS AND RESULTS

1.1 Description of Standards and Results

The EUT have been tested according to the applicable standards as referenced below:

Description / Test Item	Test Standard	Results	Meets Limit
EMISSION			
Conducted Emission	FCC RULES AND REGULATIONS PART 15 SUBPART C AND ANSI C63.10:2013	Pass	15.207
Radiated Emission	FCC RULES AND REGULATIONS PART 15 SUBPART C AND ANSI C63.10:2013	Pass	15.209(a) 15.205(a)(c)
6 dB Bandwidth Measurement	FCC RULES AND REGULATIONS PART 15 SUBPART C AND ANSI C63.10:2013	Pass	15.247(a)(2)
Maximum Peak Output Power Measurement	FCC RULES AND REGULATIONS PART 15 SUBPART C AND ANSI C63.10:2013	Pass	15.247(b)(3)
Emission Limitations Measurement	FCC RULES AND REGULATIONS PART 15 SUBPART C AND ANSI C63.10:2013	Pass	15.247(d)
Band Edge Measurement	FCC RULES AND REGULATIONS PART 15 SUBPART C AND ANSI C63.10:2013	Pass	15.247(d)
Power Spectral Density Measurement	FCC RULES AND REGULATIONS PART 15 SUBPART C AND ANSI C63.10:2013	Pass	15.247(e)
N/A is an abbreviation for Not Applicable.			

2 GENERAL INFORMATION

2.1 Description of Equipment Under Test

Description : Direct connect Full Color A19

Type of EUT : Production Pre-product Pro-type

Model Number : CLEDA199CD1

Radio Tech : BLE 4.2;
IEEE 802.11 b/g/n.

Note: : 802.11n-HT20 only.

Channel Freq. : BLE: 2402MHz-2480MHz;
802.11b/g/n: 2412MHz-2462MHz.

Modulation : BLE: GFSK;
802.11b: DSSS (CCK, DQPSK, DBPSK);
802.11g/n: OFDM (64QAM, 16QAM, QPSK, BPSK).

Antenna Info. : Antenna Type: Metal Monopole Antenna
Antenna Gain: 0.78 dBi
The Antenna was a permanently attached antenna that is comply with 15.203 requirement.

Test Mode : The EUT was set at continuous TX during all the test in the report.

Applicant : Savant Technologies LLC, dba GE Lighting, a Savant company
1975 Noble Road, Cleveland, OH 44112

Manufacturer : same as Applicant

Factory : Jiangxi Innotech Technology Co., Ltd.
No. 399, Rule Lake Avenue, Nanchang Airport
Economic Zone, Nanchang, Jiangxi.

2.2 EUT Specifications Assessed in Current Report

Mode	Modulation	Data Rate(Mbps)
BLE	GFSK	1

Channel List			
Channel No.	Frequency (MHz)	Channel No.	Frequency (MHz)
00	2402	20	2442
01	2404	21	2444
02	2406	22	2446
...
...
...
17	2436	37	2476
18	2438	38	2478
19	2440	39	2480

2.3 Test Information

The test software “RTLBTAPP.exe” was used to control EUT work in TX mode, Power Setting and select test channel.

Modulation	data rate (Mbps)	Power Setting	Test Channel		Frequency (MHz)
BLE	1	Default	Low:	00	2402
		Default	Middle:	20	2442
		Default	High:	39	2480

2.4 Sample Description

Test Item	Model Number	Sample Number	Date of receipted
Conducted Emission	CLEDA199CD1	E21091384-02/02	2021.09.17
Radiated Emission	CLEDA199CD1	E21091429-01/02	2021.09.22
Conducted RF Test	CLEDA199CD1	E21091429a-01/02	2021.09.15

2.5 Supported equipment

Brand : Acer
Product Name: : Notebook PC
Model Name : TravelMate P238 series
Model Number : N15W8

2.6 Description of Test Facility

Name of Firm : Audix Technology (Shanghai) Co., Ltd.
Site Location : 3F and 4F, 34Bldg, 680 Guiping Rd.,
Caohejing Hi-Tech Park,
Shanghai 200233, China.
Accredited by NVLAP, Lab Code : 200371-0
FCC Designation Number : CN5027
Test Firm Registration Number : 954668

3 CONDUCTED EMISSION TEST

3.1 Test Equipment

The following test equipments are used during the conducted emission test in a shielded room:

Item	Type	Manufacturer	Model No.	Serial No.	Cal. Date	Cal. Interval
1.	Test Receiver	R&S	ESCI	101302	2021.04.26	1 Year
2.	Artificial Mains Network (AMN)	R&S	ENV4200	100125	2021.06.24	1 Year
3.	Software	Audix	e3	6.2009-1-15	--	--

3.2 Block Diagram of Test Setup

3.2.1 Conducted Disturbance Test Setup

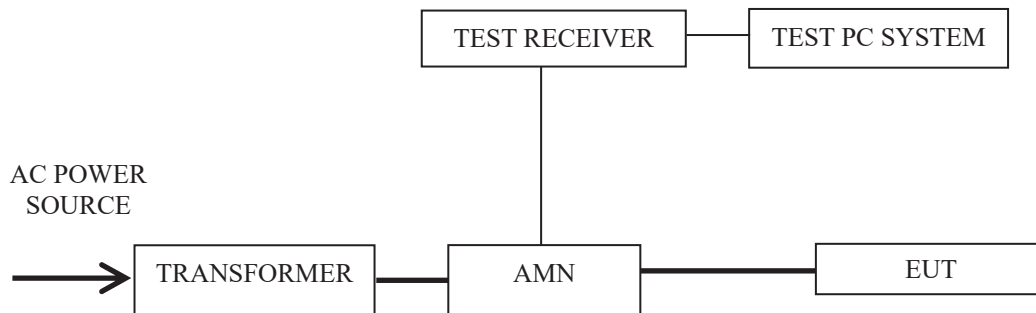

— : Signal Line
 — : Power Line

3.3 Conducted Emission Limits (§15.207)

Frequency Range (MHz)	Limits dB(μV)	
	Quasi-peak	Average
0.15 ~ 0.5	66~56	56~46
0.5 ~ 5	56	46
5 ~ 30	60	50
NOTE 1 – The lower limit shall apply at the transition frequencies. NOTE 2 – The limit decreases linearly with the logarithm of the frequency in the range 0.15 MHz~0.50 MHz		

3.4 Test Configuration

The EUT (listed in Sec.2.1) was installed as shown on Sec.3.2 to meet FCC requirement and operating in a manner which tends to maximize its emission level in a normal application.

3.5 Operating Condition of EUT

- 3.5.1 Setup the EUT as shown in Sec. 3.2.
- 3.5.2 Turn on the power of all equipment.
- 3.5.3 Turn the EUT on the test mode, and then test.

3.6 Test Procedures

The EUT was placed upon a non-metallic table, which is 0.8 m above the horizontal conducting ground plane and 0.4 m from a vertical reference plane. The EUT was connected to the power mains through an Artificial Mains Network (AMN) to provide a 50 Ω coupling impedance for the measuring equipment. Both sides of AC line (Line & Neutral) were checked to find out the maximum conducted emission according to FCC Part 15 Subpart C and ANSI C63.10: 2013 requirements during conducted disturbance test.

The I.F. bandwidth of Test Receiver ESCI was set at 9 kHz.

The frequency range from 150 kHz to 30 MHz was checked.

Test with a dummy load in lieu of the antenna to determine compliance with Section 15.207 limits within the transmitter's fundamental emission band. (According to KDB 174176 D01 Line Conducted FAQ)

The test modes were done on conducted disturbance test and all the test results are listed in Sec. 3.7

3.7 Test Results

< PASS >

The frequency and amplitude of the highest conducted emission relative the limit is reported. All the emissions not reported below are too low against the FCC limit.

Worst case emission:

No.	Operation	Modulation	Channel	Frequency (MHz)	Data Page
1.	Transmitting	--	--	--	P12

NOTE 1 – Level = Read Level + AMN Factor + Cable Loss

NOTE 2 – “QP” means “Quasi-Peak” values

NOTE 3 – The emission levels which not reported are too low against the official limit.

Worst case emission

EUT : Direct connect Full Color A19 Temperature : 22°C

Model No. : CLEDA199CD1 Humidity : 51%RH

Test Mode : Transmitting Date of Test : 2021.09.17

Polarization	Frequency (MHz)	Meter Reading dB (µV)	AMN Factor (dB)	Cable Loss (dB)	Emission Level dB (µV)	Limits dB (µV)	Margin (dB)	Remark
Line	0.1815	36.17	10.51	0.03	46.71	64.42	17.71	QP
	0.1815	21.27	10.51	0.03	31.81	54.42	22.61	Average
	0.2304	32.84	10.47	0.03	43.34	62.44	19.1	QP
	0.2304	17.72	10.47	0.03	28.22	52.44	24.22	Average
	0.352	25.76	10.41	0.04	36.21	58.91	22.7	QP
	0.352	16.95	10.41	0.04	27.4	48.91	21.51	Average
	0.6613	24.37	10.34	0.05	34.76	56	21.24	QP
	0.6613	12.18	10.34	0.05	22.57	46	23.43	Average
	1.296	25.31	10.34	0.06	35.71	56	20.29	QP
	1.296	10.89	10.34	0.06	21.29	46	24.71	Average
	28.302	5.31	10.64	0.3	16.25	60	43.75	QP
	28.302	-0.07	10.64	0.3	10.87	50	39.13	Average
Neutral	0.1516	36.87	10.72	0.03	47.62	65.91	18.29	QP
	0.1516	23.06	10.72	0.03	33.81	55.91	22.1	Average
	0.1815	36.09	10.68	0.03	46.8	64.42	17.62	QP
	0.1815	20.7	10.68	0.03	31.41	54.42	23.01	Average
	0.2304	33.75	10.62	0.03	44.4	62.44	18.04	QP
	0.2304	18.22	10.62	0.03	28.87	52.44	23.57	Average
	0.4127	26.78	10.53	0.04	37.35	57.59	20.24	QP
	0.4127	12.2	10.53	0.04	22.77	47.59	24.82	Average
	1.31	25.86	10.46	0.06	36.38	56	19.62	QP
	1.31	10.18	10.46	0.06	20.7	46	25.3	Average
	27.416	3.17	10.8	0.3	14.27	60	45.73	QP
	27.416	-1.9	10.8	0.3	9.2	50	40.8	Average

TEST ENGINEER: Jarey

4 RADIATED EMISSION TEST

4.1 Test Equipment

The following test equipment are used during the radiated emission test in a semi-anechoic chamber:

Item	Type	Manufacturer	Model No.	Serial No.	Cal. Date	Cal. Interval
1.	Preamplifier	Agilent	8447D	2944A10548	2021.03.08	1 Year
2.	Preamplifier	HP	8449B	3008A00864	2021.03.08	1 Year
3.	Spectrum Analyzer	Agilent	N9010A	MY52221182	2021.09.16	1 Year
4.	Test Receiver	R&S	ESCI	101303	2021.03.08	1 Year
5.	Bilog Antenna+6dB Attenuator	Schwarz beck	VULB 9168+EMCI-N-6-06	707+AT-N0637	2021.03.30	1 Year
6.	Horn Antenna	EMCO	3115	9607-4878	2021.07.27	1 Year
7.	Horn Antenna	EMCO	3116	00062643	2020.10.10	1 Year
8.	Cavity Band Rejection Filter	Microwave	WT-A3882-R-10	WT200312-1-1	2021.09.15	1 Year
9.	Software	Audix	e3	SET00200 9912M295-2	--	--

4.2 Block Diagram of Test Setup

4.2.1 EUT & Peripherals

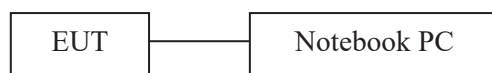

4.2.2 Below 1GHz

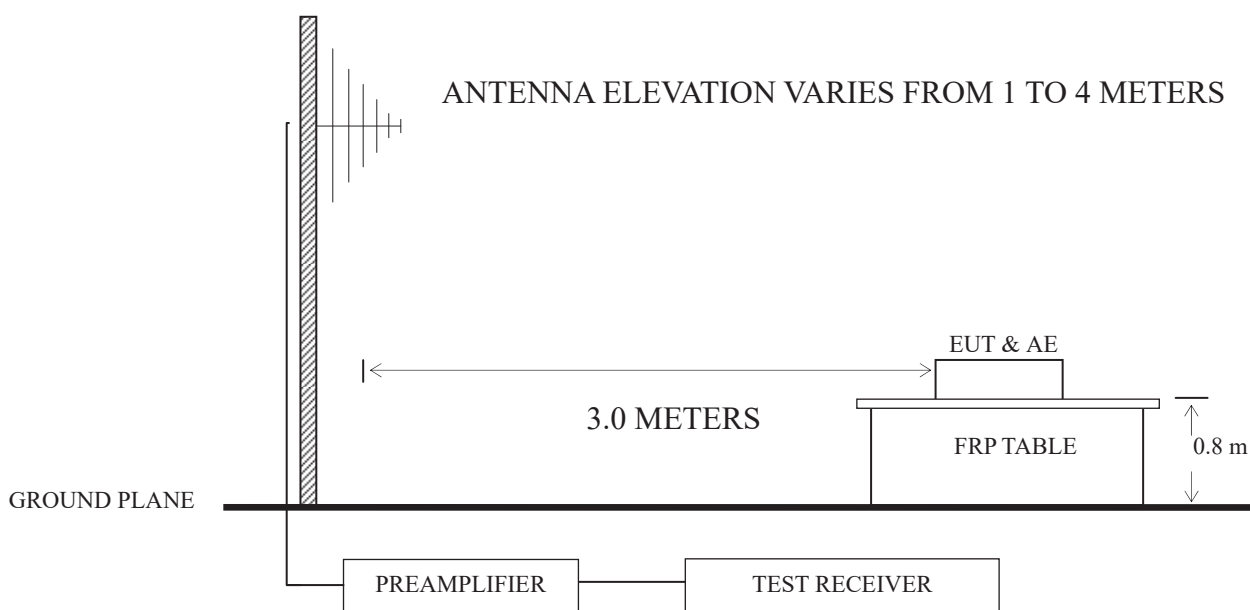

4.2.3 Above 1GHz

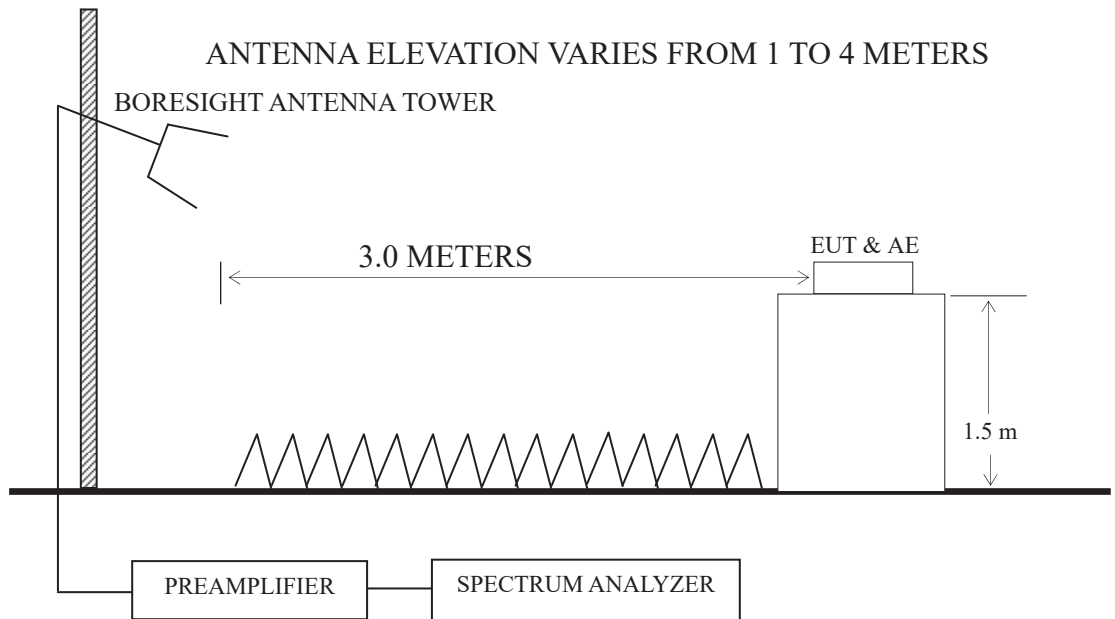

4.3 Radiated Emission Limit (§15.209)

Frequency (MHz)	Distance (m)	Field strength limits (μV/m)	
		(μV/m)	dB(μV/m)
30 ~ 88	3	100	40.0
88 ~ 216	3	150	43.5
216 ~ 960	3	200	46.0
Above 960	3	500	54.0

NOTE 1 - Emission Level dB (μV/m) = 20 log Emission Level (μV/m)

NOTE 2 - The tighter limit applies at the band edges.

NOTE 3 - Distance refers to the distance in meters between the measuring instrument antenna and the closed point of any part of the device or system.

NOTE 4 - The limits shown are based on Quasi-peak value detector below or equal to 1GHz and Average value detector above 1GHz.

NOTE 5 - Above 1 GHz, the limit on peak emission is 20 dB above the maximum permitted average emission limit applicable to the EUT

4.4 Test Configuration

The EUT (listed in Sec.2.1) and the simulators (listed in Sec.2.2) were installed as shown on Sec.4.2 to meet FCC requirements and operating in a manner that tends to maximize its emission level in a normal application.

4.5 Operating Condition of EUT

4.5.1 Setup the EUT as shown in Sec. 4.2.

4.5.2 Turn on the power of all equipment.

4.5.3 Turn the EUT on the test mode, and then test.

4.6 Test Procedures

Radiated emission test applies to harmonics/spurs that fall in the restricted bands listed in Section 15.205. The maximum permitted average field strength is listed in Section 15.209. A pre-amp is necessary for this measurement. For measurement above 1 GHz, set RBW = 1MHz, VBW = 10 Hz, Sweep: Auto. If the emission is pulsed, modify the unit for continuous operation; use the settings shown above, then correct the reading by subtracting the peak-average correction factor, derived from the appropriate duty cycle calculation.

The EUT was placed on a turntable. Below 1 GHz, the table height is 80 cm above the reference ground plane. Above 1 GHz, the table height is 1.5 m. The turntable rotated 360 degrees to determine the position of the maximum emission level. The EUT was set 3 meters away from the receiving antenna, which was mounted on an antenna tower. The antenna moved up and down between 1 meter and 4 meters to find out the maximum emission level. Broadband antenna (Calibrated Bilog Antenna) or Horn antenna was used as receiving antenna. Both horizontal and vertical polarizations of the antenna were set on measurement. In order to find the maximum emission, all of the interference cables were manipulated according to ANSI C63.10: 2013 requirements during radiated emission test.

The bandwidth of Test Receiver R&S ESCI was set at 120 kHz from 30MHz to 1000MHz.

The bandwidth of Agilent N9010A was set at 1MHz for above 1GHz.

The frequency range from 30 MHz to 25 GHz (Up to 10th harmonics from fundamental frequency) was checked.

All the test results are listed in Sec.4.7.

4.7 Test Results

<PASS>

The frequency and amplitude of the highest radiated emission relative the limit is reported. All the emissions not reported below are too low against the FCC limit.

Frequency range: below 1GHz (Worst case emission)

No.	Operation	Modulation	Channel	Frequency	Data Page
1.	Transmitting	BLE	00	2402 MHz	P17
2.			20	2442 MHz	P17
3.			39	2480 MHz	P18

Frequency range: above 1GHz

No.	Operation	Modulation	Channel	Frequency	Data Page
1.	Transmitting	BLE	00	2402 MHz	P19
2.			20	2442 MHz	P19
3.			39	2480 MHz	P20

Restricted bands:

No.	Operation	Modulation	Channel	Frequency	Data Page
1.	Transmitting	BLE	00	2402 MHz	P21
2.			39	2480 MHz	P21

NOTE 1 – Level = Read Level + Antenna Factor + Cable Loss - Preamp Factor

NOTE 2 – “QP” means “Quasi-Peak” values

NOTE 3 – 0° was the table front facing the antenna. Degree is calculated from 0° clockwise facing the antenna.

NOTE 4 – The emission levels which not reported are too low against the official limit.

NOTE 5 – The emission levels recorded below is data of EUT configured in Standing direction, for Standing direction was the maximum emission direction during the test. The data of Side & Lying direction are too low against the official limit to be reported.

NOTE 6 – All reading are Quasi-Peak values below or equal to 1GHz, Peak and Average values above 1GHz.

For above 1GHz test, if the peak measured value complies with the average limit, it is unnecessary to perform an average measurement.

NOTE 7 – The frequency range 2310-2390MHz & 2483.5-2500MHz were tested for Restricted bands.

Worst case emission < 1GHz

EUT : Direct connect Full Color A19 Temperature : 22°C

Model No. : CLEDA199CD1 Humidity : 51%RH

Test Mode : Transmitting Date of Test : 2021.09.22

BLE CH2402MHz

Polarization	Frequency (MHz)	Meter Reading dB (µV)	Antenna Factor (dB/m)	Cable Loss (dB)	Preamp Factor (dB)	Emission Level dB (µV/m)	Limits dB (µV/m)	Margin (dB)	Remark
Horizontal	58.819	23.71	19.4	0.82	28.17	15.76	40	24.24	QP
	88.033	28.1	13.7	1.02	28.06	14.76	43.5	28.74	QP
	159.78	29.44	19	1.35	27.73	22.06	43.5	21.44	QP
	239.99	32.45	17.2	1.65	27.2	24.1	46	21.9	QP
	501.18	24.69	23.23	2.48	27.9	22.5	46	23.5	QP
	798.98	23.6	27.8	3.06	26.9	27.56	46	18.44	QP
Vertical	57.392	25.04	19.4	0.82	28.17	17.09	40	22.91	QP
	91.495	29.41	13.95	1.05	28.04	16.37	43.5	27.13	QP
	159.78	26.93	19	1.35	27.73	19.55	43.5	23.95	QP
	263.82	25.78	17.84	1.74	27.1	18.26	46	27.74	QP
	552.88	25.37	24.1	2.53	27.89	24.11	46	21.89	QP
	875.25	23.04	28.3	3.28	26.45	28.17	46	17.83	QP

BLE CH2442MHz

Polarization	Frequency (MHz)	Meter Reading dB (µV)	Antenna Factor (dB/m)	Cable Loss (dB)	Preamp Factor (dB)	Emission Level dB (µV/m)	Limits dB (µV/m)	Margin (dB)	Remark
Horizontal	54.071	23.86	19.6	0.79	28.18	16.07	40	23.93	QP
	87.725	29.23	13.73	1.02	28.06	15.92	40	24.08	QP
	159.78	28.99	19	1.35	27.73	21.61	43.5	21.89	QP
	263.82	28.65	17.84	1.74	27.1	21.13	46	24.87	QP
	501.18	24.71	23.23	2.48	27.9	22.52	46	23.48	QP
	836.24	23.7	27.9	3.14	26.7	28.04	46	17.96	QP
Vertical	51.121	23.98	19.58	0.76	28.2	16.12	40	23.88	QP
	91.495	29.65	13.95	1.05	28.04	16.61	43.5	26.89	QP
	159.78	27.2	19	1.35	27.73	19.82	43.5	23.68	QP
	257.42	24.67	17.6	1.71	27.11	16.87	46	29.13	QP
	407.52	25.36	21.25	2.18	27.63	21.16	46	24.84	QP
	801.79	23.9	27.9	3.09	26.9	27.99	46	18.01	QP

BLE CH2480MHz

Polarization	Frequency (MHz)	Meter Reading dB (μV)	Antenna Factor (dB/m)	Cable Loss (dB)	Preamp Factor (dB)	Emission Level dB (μV/m)	Limits dB (μV/m)	Margin (dB)	Remark
Horizontal	60.28	23.84	19.18	0.84	28.16	15.7	40	24.3	QP
	88.033	29.39	13.7	1.02	28.06	16.05	43.5	27.45	QP
	159.78	28.9	19	1.35	27.73	21.52	43.5	21.98	QP
	263.82	29.31	17.84	1.74	27.1	21.79	46	24.21	QP
	560.69	24.2	24.2	2.57	27.88	23.09	46	22.91	QP
	906.48	22.71	28.7	3.35	26.25	28.51	46	17.49	QP
Vertical	53.318	23.71	19.53	0.78	28.19	15.83	40	24.17	QP
	91.495	29.61	13.95	1.05	28.04	16.57	43.5	26.93	QP
	159.78	27.42	19	1.35	27.73	20.04	43.5	23.46	QP
	234.17	31.07	16.45	1.64	27.23	21.93	46	24.07	QP
	447.98	25.94	22.67	2.28	27.8	23.09	46	22.91	QP
	798.98	23.66	27.8	3.06	26.9	27.62	46	18.38	QP

TEST ENGINEER: Jarey

Radiated Emission > 1GHz

EUT : Direct connect Full Color A19 Temperature : 22°C

Model No. : CLEDA199CD1 Humidity : 51%RH

Test Mode : Transmitting Date of Test : 2021.09.22

BLE CH2402MHz

Polarization	Frequency (MHz)	Meter Reading dB (μV)	Antenna Factor (dB/m)	Cable Loss (dB)	Preamp Factor (dB)	Emission Level dB (μV/m)	Limits dB (μV/m)	Margin (dB)	Remark
Horizontal	2668	44.91	29.08	5.61	35.59	44.01	74	29.99	Peak
	5236	38.32	34.05	7.89	34.7	45.56	74	28.44	Peak
	7084	36.88	35.8	9.37	34.8	47.25	74	26.75	Peak
	9376	36.2	38.27	10.97	34.66	50.78	74	23.22	Peak
	11356	35.44	38.8	11.87	34.33	51.78	74	22.22	Peak
	12748	34.99	38.92	12.8	33.97	52.74	74	21.26	Peak
Vertical	3196	43.27	30.6	6.09	35.23	44.73	74	29.27	Peak
	5248	37.93	34.05	7.89	34.7	45.17	74	28.83	Peak
	7144	37.06	35.95	9.37	34.8	47.58	74	26.42	Peak
	8908	36.24	38.26	10.7	34.71	50.49	74	23.51	Peak
	10660	36.94	38.46	11.55	34.47	52.48	74	21.52	Peak
	12376	35.95	38.71	12.56	34.08	53.14	74	20.86	Peak

BLE CH2442MHz

Polarization	Frequency (MHz)	Meter Reading dB (μV)	Antenna Factor (dB/m)	Cable Loss (dB)	Preamp Factor (dB)	Emission Level dB (μV/m)	Limits dB (μV/m)	Margin (dB)	Remark
Horizontal	3496	42.09	31.3	6.36	35.14	44.61	74	29.39	Peak
	5452	38.67	34.09	8.04	34.7	46.1	74	27.9	Peak
	7204	37.32	36.1	9.47	34.8	48.09	74	25.91	Peak
	9064	36.62	38.22	10.79	34.69	50.94	74	23.06	Peak
	11188	35.36	38.8	11.76	34.36	51.56	74	22.44	Peak
	12304	36.77	38.77	12.56	34.1	54	74	20	Peak
Vertical	3484	42.57	31.28	6.36	35.14	45.07	74	28.93	Peak
	5380	38.34	34.08	7.99	34.7	45.71	74	28.29	Peak
	7480	36.93	36.75	9.69	34.8	48.57	74	25.43	Peak
	9196	36.07	38.24	10.88	34.68	50.51	74	23.49	Peak
	11164	35.37	38.8	11.76	34.37	51.56	74	22.44	Peak
	12268	34.79	38.8	12.56	34.12	52.03	74	21.97	Peak

BLE CH2480MHz

Polarization	Frequency (MHz)	Meter Reading dB (μV)	Antenna Factor (dB/m)	Cable Loss (dB)	Preamp Factor (dB)	Emission Level dB (μV/m)	Limits dB (μV/m)	Margin (dB)	Remark
Horizontal	3076	41.67	30.3	5.96	35.27	42.66	74	31.34	Peak
	4984	38.39	33.94	7.67	34.7	45.3	74	28.7	Peak
	7504	36.55	36.8	9.79	34.8	48.34	74	25.66	Peak
	9484	36.19	38.29	11.06	34.65	50.89	74	23.11	Peak
	11416	35.38	38.8	11.99	34.32	51.85	74	22.15	Peak
	12280	35.58	38.77	12.56	34.12	52.79	74	21.21	Peak
Vertical	2944	42.4	29.95	5.85	35.35	42.85	74	31.15	Peak
	5128	37.53	34.03	7.78	34.7	44.64	74	29.36	Peak
	7180	37.05	36.05	9.47	34.8	47.77	74	26.23	Peak
	9148	37.39	38.23	10.79	34.68	51.73	74	22.27	Peak
	10816	35.94	38.61	11.6	34.43	51.72	74	22.28	Peak
	12424	34.9	38.66	12.56	34.07	52.05	74	21.95	Peak

TEST ENGINEER: Jarey

Emissions in restricted frequency bands:

EUT : Direct connect Full Color A19 Temperature : 22°C

Model No. : CLEDA199CD1 Humidity : 51%RH

Test Mode : Transmitting Date of Test : 2021.09.22

BLE CH2402MHz

Polarization	Frequency (MHz)	Meter Reading dB (μV)	Antenna Factor (dB/m)	Cable Loss (dB)	Preamp Factor (dB)	Emission Level dB (μV/m)	Limits dB (μV/m)	Margin (dB)	Remark
Horizontal	2333.1	45.85	28.06	5.29	35.92	43.28	74	30.72	Peak
	2333.1	33.39	28.06	5.29	35.92	30.82	54	23.18	Average
	2364.1	45.61	28.15	5.32	35.89	43.19	74	30.81	Peak
	2364.1	33.37	28.15	5.32	35.89	30.95	54	23.05	Average
	2389.7	58.71	28.21	5.36	35.86	56.42	74	17.58	Peak
	2389.7	36.37	28.21	5.36	35.86	34.08	54	19.92	Average
Vertical	2321.6	46.29	28.03	5.29	35.93	43.68	74	30.32	Peak
	2321.6	34.42	28.03	5.29	35.93	31.81	54	22.19	Average
	2353.4	46.02	28.12	5.32	35.9	43.56	74	30.44	Peak
	2353.4	34.2	28.12	5.32	35.9	31.74	54	22.26	Average
	2390	57.28	28.21	5.36	35.86	54.99	74	19.01	Peak
	2390	40.33	28.21	5.36	35.86	38.04	54	15.96	Average

BLE CH2480MHz

Polarization	Frequency (MHz)	Meter Reading dB (μV)	Antenna Factor (dB/m)	Cable Loss (dB)	Preamp Factor (dB)	Emission Level dB (μV/m)	Limits dB (μV/m)	Margin (dB)	Remark
Horizontal	2484.1	42.62	28.46	5.43	35.76	40.75	74	33.25	Peak
	2484.1	33.36	28.46	5.43	35.76	31.49	54	22.51	Average
	2492.4	43.72	28.48	5.47	35.76	41.91	74	32.09	Peak
	2492.4	33.37	28.48	5.47	35.76	31.56	54	22.44	Average
	2498	44.09	28.5	5.47	35.76	42.3	74	31.7	Peak
	2498	33.51	28.5	5.47	35.76	31.72	54	22.28	Average
Vertical	2483.7	47.2	28.46	5.43	35.76	45.33	74	28.67	Peak
	2483.7	38.32	28.46	5.43	35.76	36.45	54	17.55	Average
	2490.9	46.08	28.48	5.47	35.76	44.27	74	29.73	Peak
	2490.9	33.5	28.48	5.47	35.76	31.69	54	22.31	Average
	2496.6	45.59	28.5	5.47	35.76	43.8	74	30.2	Peak
	2496.6	34.36	28.5	5.47	35.76	32.57	54	21.43	Average

TEST ENGINEER: Jarey

5 6 dB BANDWIDTH MEASUREMENT

5.1 Test Equipment

The following test equipment was used during the Emission Bandwidth measurement:

Item	Type	Manufacturer	Model No.	Serial No.	Cal. Date	Cal. Interval
1.	Spectrum Analyzer	Agilent	N9010A	MY52221182	2021.09.15	1 Year
2.	Coaxial Cable	WOKEN	SFL402-105F LEX	F02-150819-045	2021.03.08	1 Year
3.	10 dB Attenuator	Mini-Circuits	VAT-10W2+	001	2021.08.06	1 Year

5.2 Block Diagram of Test Setup



5.3 Specification Limits (§15.247(a)(2))

The minimum 6 dB bandwidth shall be at least 500 kHz.

5.4 Operating Condition of EUT

The switch ON/OFF was used to enable the EUT to change the channel one by one.

5.5 Test Procedure

The transmitter output was connected to the spectrum analyzer. The bandwidth of the fundamental frequency was measure by spectrum analyzer with settings: RBW = 100kHz, VBW ≥ 3 × RBW.

The 6 dB bandwidth is defined as the total spectrum the power of which is lower than peak power minus 6 dB .

The test procedure is defined in ANSI C63.10-2013 (the 11.8.2 Measurement Procedure “Option 2” was used).

5.6 Test Results

PASSED.

All the test results are attached in next pages.

(Test Date: 2021.09.15 Temperature: 23°C Humidity: 51 %)

Modulation	Channel	Frequency (MHz)	6dB Bandwidth (kHz)	Limit
BLE	00	2402	665.5	500 kHz
	20	2442	656.9	500 kHz
	39	2480	667.9	500 kHz

BLE CH2402MHz



BLE CH2442MHz



BLE CH2480MHz



6 MAXIMUM PEAK OUTPUT POWER MEASUREMENT

6.1 Test Equipment

The following test equipment was used during the maximum peak output power measurement:

Item	Type	Manufacturer	Model No.	Serial No.	Cal. Date	Cal. Interval
1.	Spectrum Analyzer	Agilent	N9010A	MY52221182	2021.09.15	1 Year
2.	Coaxial Cable	WOKEN	SFL402-105F LEX	F02-150819-045	2021.03.08	1 Year
3.	10 dB Attenuator	Mini-Circuits	VAT-10W2+	001	2021.08.06	1 Year

6.2 Block Diagram of Test Setup

The Same as Section. 5.2.

6.3 Specification Limits ((§15.247(b)(3))

The Limits of maximum Peak Output Power for digital modulation in 2400-2483.5 MHz is: 1 Watt. (30 dBm)

6.4 Operating Condition of EUT

The switch ON/OFF was used to enable the EUT to change the channel one by one.

6.5 Test Procedure

The transmitter output was connected to the spectrum analyzer.

The following procedure shall be used when an instrument with a resolution bandwidth that is greater than the DTS bandwidth is available to perform the measurement:

- a) $RBW \geq DTS$ Bandwidth.
- b) $VBW \geq [3 \times RBW]$.
- c) $Span \geq [3 \times RBW]$.
- d) Sweep time = auto.
- e) Detector = peak.
- f) Trace mode = max hold.
- g) Allow trace to fully stabilize.
- h) Use peak marker function to determine the peak amplitude level.

The test procedure is defined in ANSI C63.10-2013 (11.9.1.1 Measurement Procedure “ $RBW \geq DTS$ bandwidth” was used).

6.6 Test Results

PASSED.

All the test results are listed below.

(Test Date: 2021.09.15 Temperature: 23°C Humidity: 51 %)

Modulation	Channel	Frequency (MHz)	Peak Output Power (dBm)	Limit
BLE	00	2402	5.48	30 dBm
	20	2442	5.859	30 dBm
	39	2480	5.655	30 dBm

BLE CH2402MHz

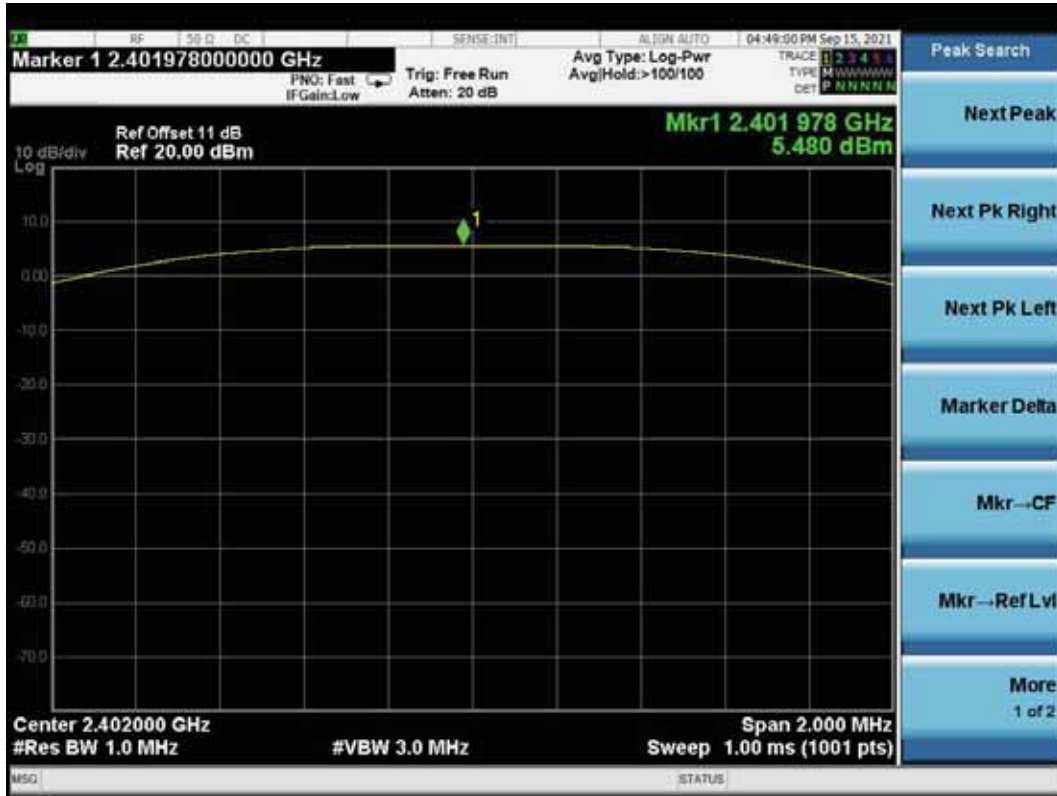

BLE CH2442MHz

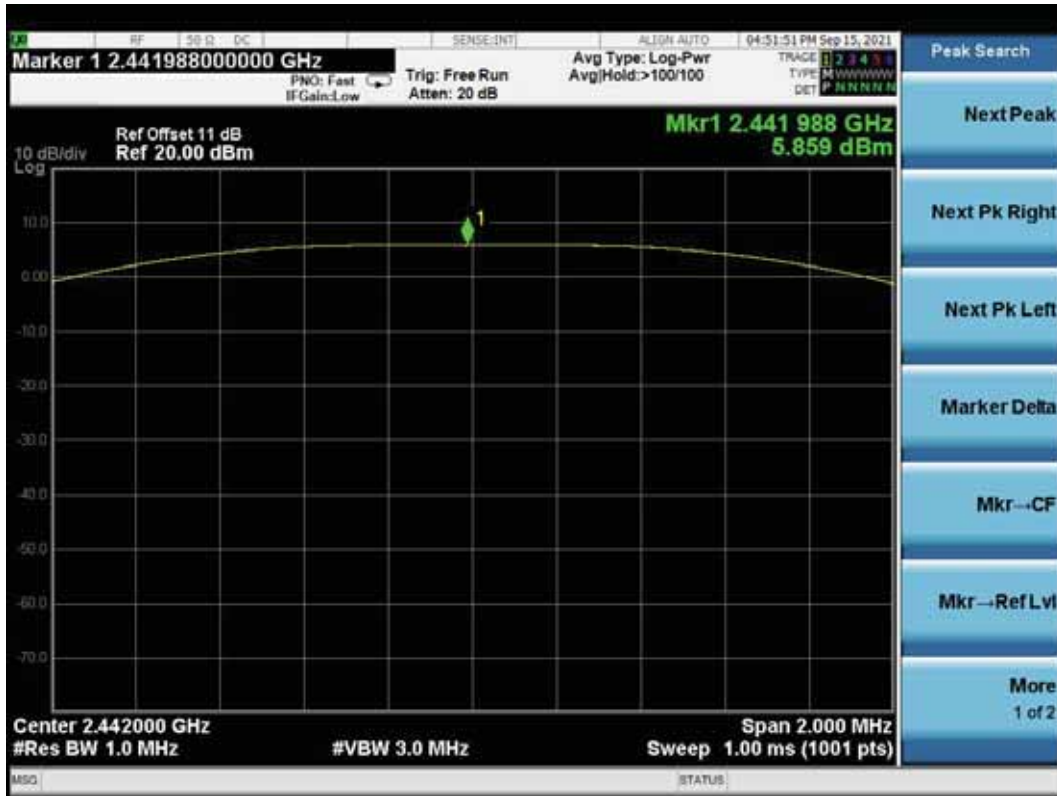

BLE CH2480MHz

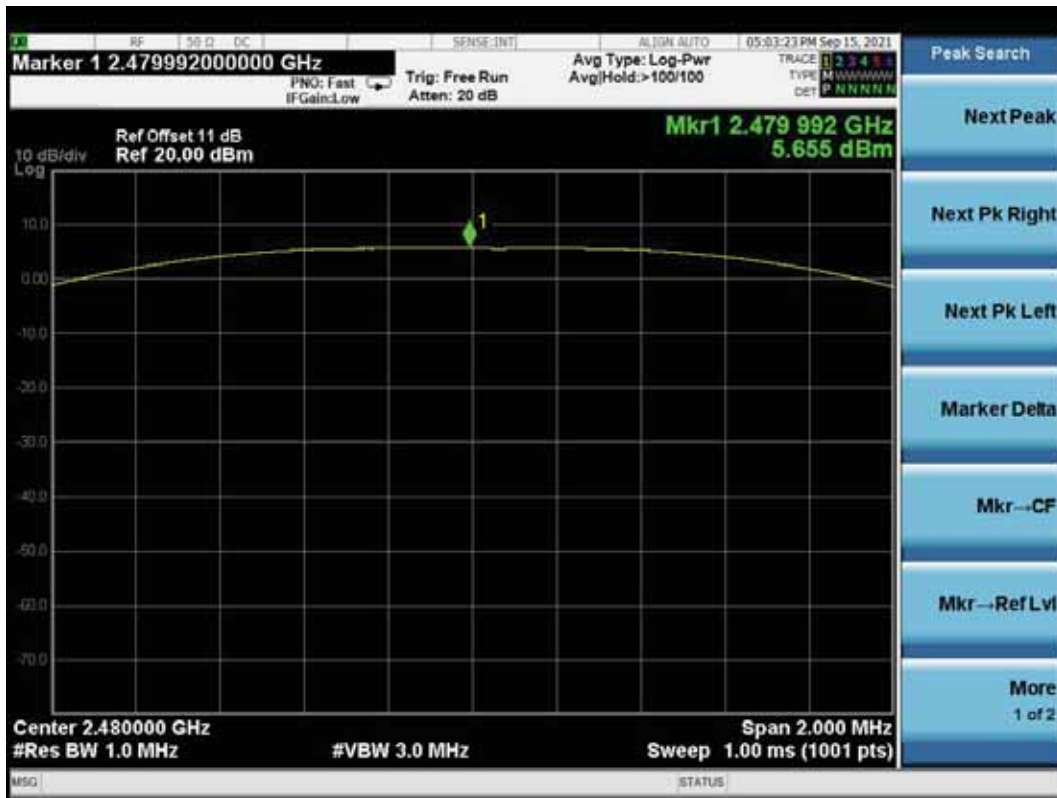

7 EMISSION LIMITATIONS MEASUREMENT

7.1 Test Equipment

The following test equipment was used during the emission limitations test:

Item	Type	Manufacturer	Model No.	Serial No.	Cal. Date	Cal. Interval
1.	Spectrum Analyzer	Agilent	N9010A	MY52221182	2021.09.15	1 Year
2.	Coaxial Cable	WOKEN	SFL402-105F LEX	F02-150819-045	2021.03.08	1 Year
3.	10 dB Attenuator	Mini-Circuits	VAT-10W2+	001	2021.08.06	1 Year

7.2 Block Diagram of Test Setup

The Same as Section. 5.2.

7.3 Specification Limits (§15.247(d))

In any 100 kHz bandwidth outside the frequency band in which the spread spectrum or digitally modulated intentional radiator is operating, the radio frequency power that is produced by the intentional radiator shall be at least 20 dB below that in the 100 kHz bandwidth within the band that contains the highest level of the desired power, based on either an RF conducted or a radiated measurement, provided the transmitter demonstrates compliance with the peak conducted power limits. If the transmitter complies with the conducted power limits based on the use of RMS averaging over a time interval, as permitted under paragraph (b)(3) of this section, the attenuation required under this paragraph shall be 30 dB instead of 20 dB. Attenuation below the general limits specified in §15.209(a) is not required.

In addition, radiated emissions which fall in the restricted bands, as defined in §15.205(a), must also comply with the radiated emission limits specified in §15.209(a) (see §15.205(c)). (※This test result attaching to Section. 3.7)

7.4 Operating Condition of EUT

The switch ON/OFF was used to enable the EUT to change the channel one by one.

7.5 Test Procedure

The transmitter output was connected to the spectrum analyzer.

Establish a reference level by using the following procedure:

- a) Set instrument center frequency to DTS channel center frequency.
- b) Set the span to ≥ 1.5 times the DTS bandwidth.
- c) Set the RBW = 100 kHz.
- d) Set the VBW $\geq [3 \times \text{RBW}]$.
- e) Detector = peak.
- f) Sweep time = auto couple.
- g) Trace mode = max hold.
- h) Allow trace to fully stabilize.
- i) Use the peak marker function to determine the maximum PSD level.

Note that the channel found to contain the maximum PSD level can be used to

establish the reference level.

Establish an emission level by using the following procedure:

- a) Set the center frequency and span to encompass frequency range to be measured.
- b) Set the RBW = 100 kHz.
- c) Set the VBW $\geq [3 \times \text{RBW}]$.
- d) Detector = peak.
- e) Sweep time = auto couple.
- f) Trace mode = max hold.
- g) Allow trace to fully stabilize.
- h) Use the peak marker function to determine the maximum amplitude level.

Ensure that the amplitude of all unwanted emissions outside of the authorized frequency band (excluding restricted frequency bands) is attenuated by at least the minimum requirements specified in 11.11. Report the three highest emissions relative to the limit.

Scan up through 10th harmonic.

The test procedure is defined in ANSI C63.10-2013 (11.11.2 Reference level measurement and 11.11.3 Emission level measurement was used).

7.6 Test Results

PASSED.

The test data was attached in the next pages.

(Test Date: 2021.09.15 Temperature: 23°C Humidity: 51 %)

Modulation	Channel	Frequency (MHz)	Data Page
BLE	00	2402	P33-34
	20	2442	P35-36
	39	2480	P37-38

BLE CH2402MHz

Reference level



Emission level

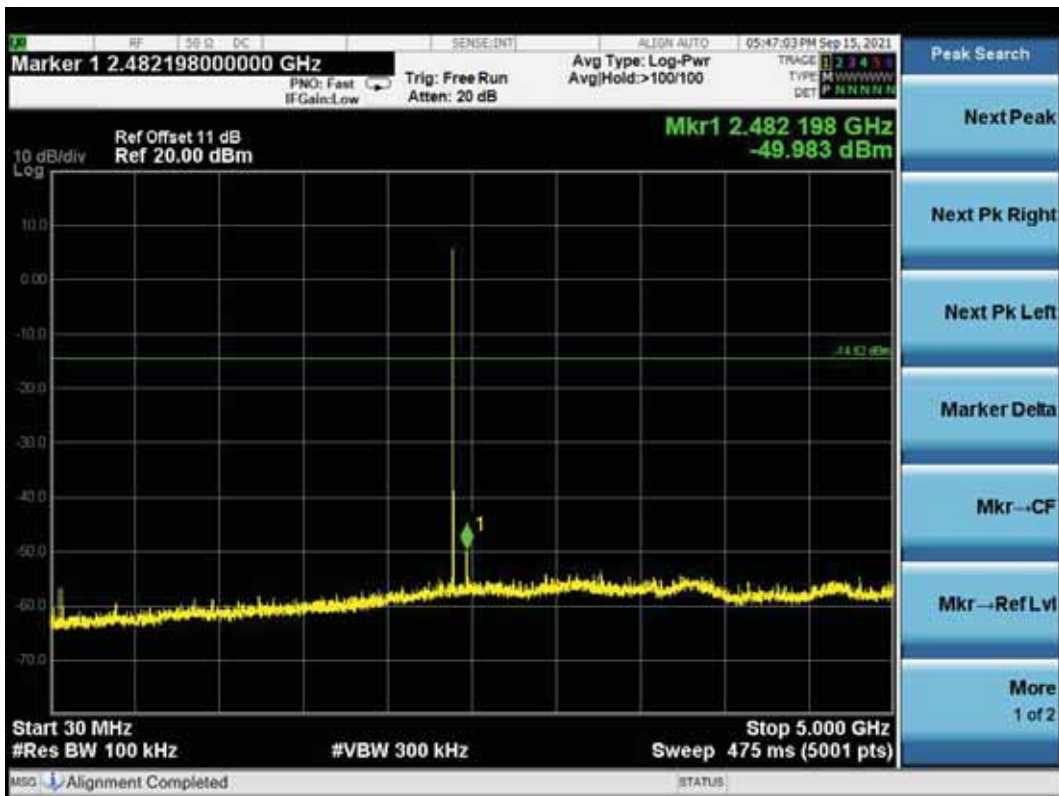



BLE CH2442MHz

Reference level



Emission level





BLE CH2480MHz

Reference level



Emission level

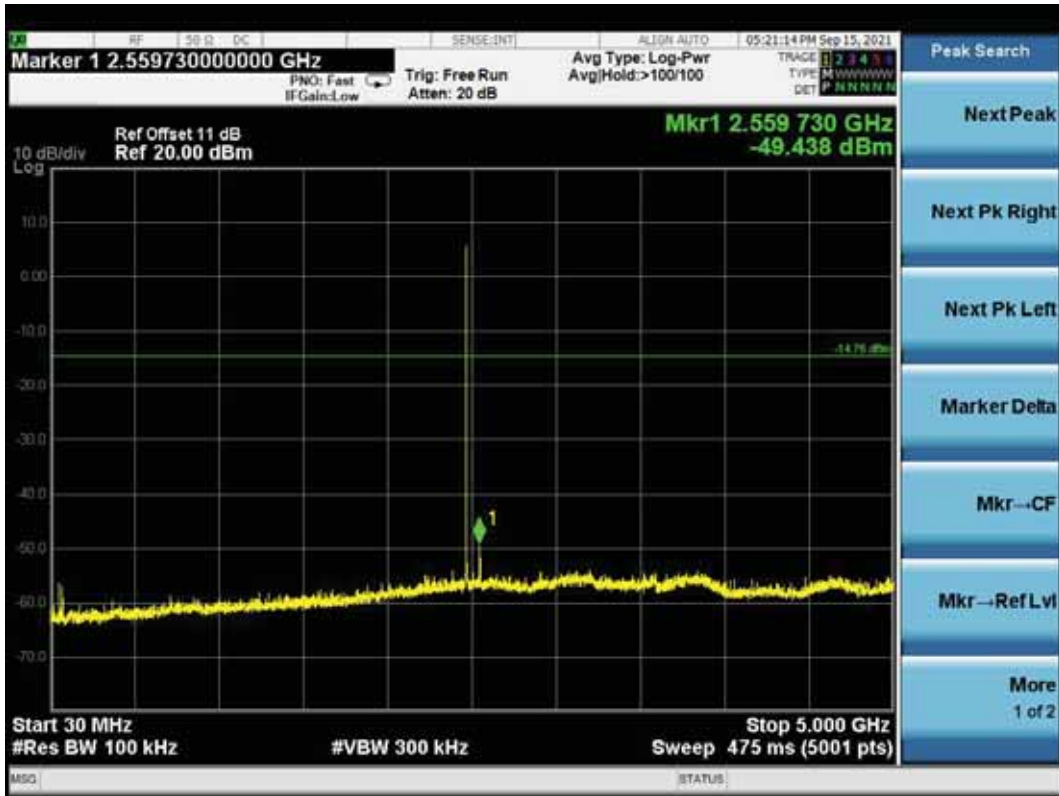



8 BAND EDGES MEASUREMENT

8.1 Test Equipment

The following test equipment was used during the band edges measurement:

Item	Type	Manufacturer	Model No.	Serial No.	Cal. Date	Cal. Interval
1.	Spectrum Analyzer	Agilent	N9010A	MY52221182	2021.09.15	1 Year
2.	Coaxial Cable	WOKEN	SFL402-105F LEX	F02-150819-045	2021.03.08	1 Year
3.	10 dB Attenuator	Mini-Circuits	VAT-10W2+	001	2021.08.06	1 Year

8.2 Block Diagram of Test Setup

The Same as section. 5.2.

8.3 Specification Limits (§15.247(d))

In any 100 kHz bandwidth outside the frequency band in which the spread spectrum or digitally modulated intentional radiator is operating, the radio frequency power that is produced by the intentional radiator shall be at least 20 dB below that in the 100 kHz bandwidth within the band that contains the highest level of the desired power, based on either an RF conducted or a radiated measurement, provided the transmitter demonstrates compliance with the peak conducted power limits. If the transmitter complies with the conducted power limits based on the use of RMS averaging over a time interval, as permitted under paragraph (b)(3) of this section, the attenuation required under this paragraph shall be 30 dB instead of 20 dB. Attenuation below the general limits specified in §15.209(a) is not required.

8.4 Operating Condition of EUT

The switch ON/OFF was used to enable the EUT to change the channel one by one.

8.5 Test Procedure

The transmitter output was connected to the spectrum analyzer. Set RBW of Test Receiver to 100kHz and VBW to 300kHz with suitable frequency span including 100kHz bandwidth from band edge.

The test procedure is defined in ANSI C63.10-2013 (11.11.3 Emission level measurement was used).

8.6 Test Results

PASSED.

All the test results are attached in next pages.

(Test Date: 2021.09.15 Temperature: 23°C Humidity: 51 %)

Modulation	Location	Channel	Frequency (MHz)	Delta Marker (dB)	Result
BLE	Below Band Edge	00	2402	61.381	More than 20 dB below the highest level of the desired power
	Upper Band Edge	39	2480	59.366	

BLE CH2402MHz (Below Edge 2390 MHz)

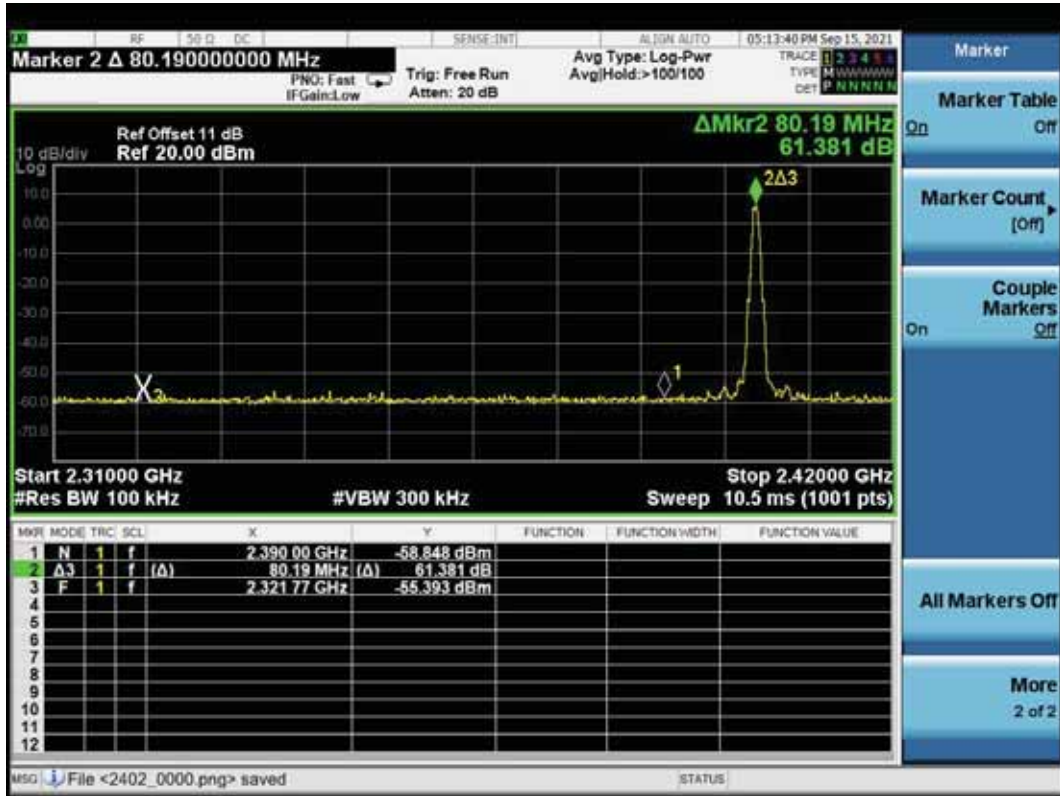

BLE CH2480MHz (Upper Edge 2483.5 MHz)

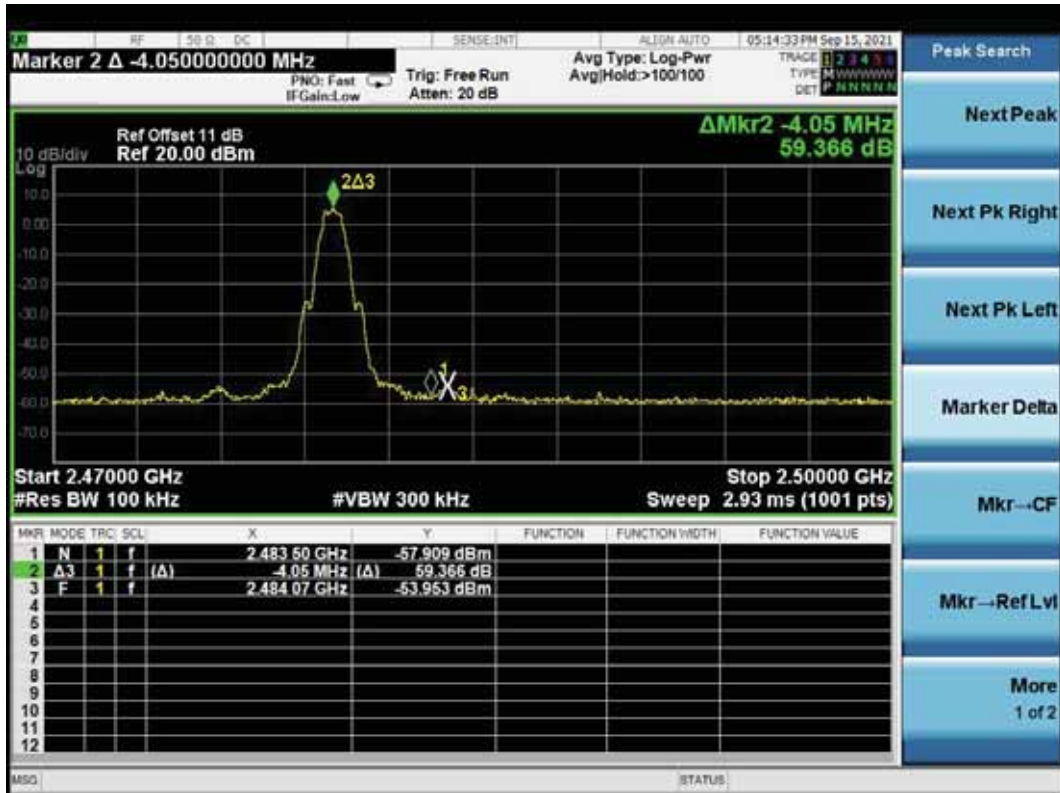

9 POWER SPECTRAL DENSITY MEASUREMENT

9.1 Test Equipment

The following test equipment was used during the power spectral density measurement:

Item	Type	Manufacturer	Model No.	Serial No.	Cal. Date	Cal. Interval
1.	Spectrum Analyzer	Agilent	N9010A	MY52221182	2021.09.15	1 Year
2.	Coaxial Cable	WOKEN	SFL402-105F LEX	F02-150819-0 45	2021.03.08	1 Year
3.	10 dB Attenuator	Mini-Circuits	VAT-10W2+	001	2021.08.06	1 Year

9.2 Block Diagram of Test Setup

The Same as section 5.2.

9.3 Specification Limits (§15.247(e))

The peak power spectral density conducted from the intentional radiator to the antenna shall not be greater than 8 dBm in any 3 kHz band.

9.4 Operating Condition of EUT

The switch ON/OFF was used to enable the EUT to change the channel one by one.

9.5 Test Procedure

The transmitter output was connected to the spectrum analyzer.

- a) Set analyzer center frequency to DTS channel center frequency.
- b) Set the span to 1.5 times the DTS bandwidth.
- c) Set the RBW to $3 \text{ kHz} \leq \text{RBW} \leq 100 \text{ kHz}$.
- d) Set the VBW $\geq [3 \times \text{RBW}]$.
- e) Detector = peak.
- f) Sweep time = auto couple.
- g) Trace mode = max hold.
- h) Allow trace to fully stabilize.
- i) Use the peak marker function to determine the maximum amplitude level within the RBW.
- j) If measured value exceeds requirement, then reduce RBW (but no less than 3 kHz) and repeat.

The test procedure is defined in ANSI C63.10-2013 (11.10.2 Measurement Procedure “Method PKPSD (peak PSD)” was used).

9.6 Test Results

PASSED.

All the test results are attached in next pages.

(Test Date: 2021.09.15 Temperature: 23°C Humidity: 51 %)

Modulation	Channel	Frequency (MHz)	Power Spectral Density (dBm)	Limit
BLE	00	2402	-9.115	8 dBm
	20	2442	-10.303	8 dBm
	39	2480	-9.703	8 dBm

BLE CH2402 MHz

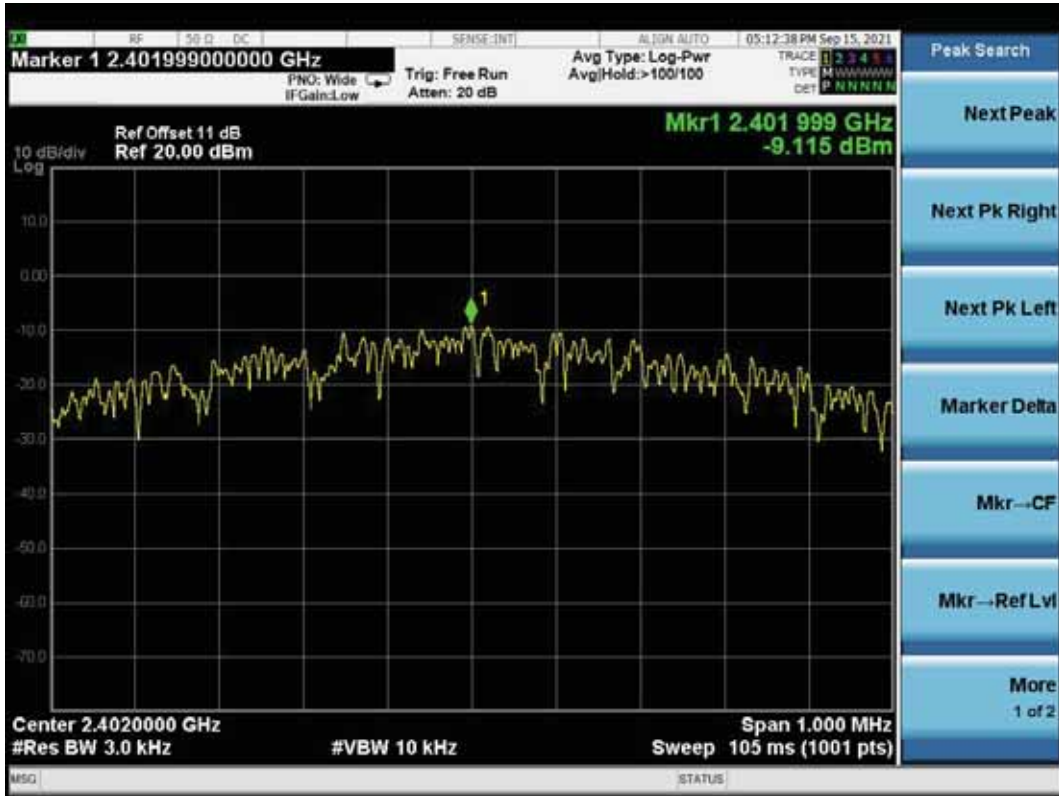

BLE CH2442 MHz



BLE CH2480 MHz



10 DEVIATION TO TEST SPECIFICATIONS

None.

11 MEASUREMENT UNCERTAINTY LIST

The measurement uncertainty was estimated for test on the EUT according to CISPR 16-4-2. This uncertainty represents an expanded uncertainty expressed at approximately the 95% confidence level using a coverage of K=2. The uncertainties value is not used in determining the PASS/FAIL results.

Test Items/Facilities	Frequency/Equipment/Unit	Uncertainty
Conducted Emission No.1 Shielded Room	9kHz~150kHz	±3.1 dB
	150kHz~30MHz	±2.6 dB
Conducted Emission No.3 Shielded Room	9kHz~150kHz	±3.1 dB
	150kHz~30MHz	±2.6 dB
Radiated Emission	30MHz~200MHz, Horizontal	±3.8 dB
	30MHz~200MHz, Vertical	±4.1 dB
	200MHz~1000MHz, Horizontal	±3.6 dB
	200MHz~1000MHz, Vertical	±5.1 dB
	1GHz~6GHz	±5.3 dB
	6GHz~18GHz	±5.3 dB
	18GHz~40GHz	±3.5 dB
Output Power Test	50MHz~18GHz	0.77 dB
Power Density Test	9kHz~6GHz	1.08 dB
RF Frequency Test	9kHz~40GHz	6×10^{-4}
Bandwidth Test	9kHz~6GHz	1.5×10^{-3}
RF Radiated Power Test	30MHz~1000MHz	3.06 dB
Conducted Output Power Test	50MHz~18GHz	0.83 dB
AC Voltage(<10kHz) Test	120V~230V	0.04 %
DC Power Test	0V~30V	0.4 %
Temperature	-40°C~+100°C	0.52 °C
Humidity	30%~95%	2.6 %