



**FCC 47 CFR PART 15 SUBPART C &  
INDUSTRY CANADA RSS-210**

**TEST REPORT**

**For**

**Kobo Vox eReader Tablet**

**Model: K080**

**Trade Name: kobo**

*Issued to*

**Wistron Corporation**  
21F, No. 88, Sec. 1, Hsin Tai Wu Rd., Hsichih Dist,  
New Taipei City 221, Taiwan R.O.C.

*Issued by*

**Compliance Certification Services Inc.**  
No.11, Wu-Gong 6th Rd., Wugu Industrial Park,  
New Taipei City 248, Taiwan (R.O.C.)  
<http://www.ccsrf.com>  
[service@ccsrf.com](mailto:service@ccsrf.com)  
**Issued Date: September 15, 2011**



---

*Note: This report shall not be reproduced except in full, without the written approval of Compliance Certification Services Inc. This document may be altered or revised by Compliance Certification Services Inc. personnel only, and shall be noted in the revision section of the document.*



**Revision History**

Rev.	Issue Date	Revisions	Effect Page	Revised By
00	September 15, 2011	Initial Issue	ALL	Eunice Shen



## TABLE OF CONTENTS

<b>1. TEST RESULT CERTIFICATION.....</b>	<b>4</b>
<b>2. EUT DESCRIPTION .....</b>	<b>5</b>
<b>3. TEST METHODOLOGY .....</b>	<b>6</b>
3.1 EUT CONFIGURATION .....	6
3.2 EUT EXERCISE.....	6
3.3 GENERAL TEST PROCEDURES.....	6
3.4 FCC PART 15.205 RESTRICTED BANDS OF OPERATIONS.....	7
3.5 DESCRIPTION OF TEST MODES .....	8
<b>4. INSTRUMENT CALIBRATION.....</b>	<b>9</b>
4.1 MEASURING INSTRUMENT CALIBRATION .....	9
4.2 MEASUREMENT EQUIPMENT USED .....	9
4.3 MEASUREMENT UNCERTAINTY .....	10
<b>5. FACILITIES AND ACCREDITATIONS .....</b>	<b>11</b>
5.1 FACILITIES .....	11
5.2 EQUIPMENT.....	11
5.3 LABORATORY ACCREDITATIONS AND LISTING.....	11
5.4 TABLE OF ACCREDITATIONS AND LISTINGS.....	12
<b>6. SETUP OF EQUIPMENT UNDER TEST .....</b>	<b>13</b>
6.1 SETUP CONFIGURATION OF EUT.....	13
6.2 SUPPORT EQUIPMENT .....	13
<b>7. APPLICABLE RULES FOR INDUSTRY CANADA RSS-210 .....</b>	<b>14</b>
<b>8. FCC PART 15.247 REQUIREMENTS &amp; RSS-210 REQUIREMENTS.....</b>	<b>23</b>
8.1 99% BANDWIDTH .....	23
8.2 6DB BANDWIDTH.....	30
8.3 PEAK POWER.....	41
8.4 AVERAGE POWER .....	43
8.5 BAND EDGES MEASUREMENT .....	45
8.6 PEAK POWER SPECTRAL DENSITY.....	58
8.7 SPURIOUS EMISSIONS.....	69
8.8 RADIATED EMISSIONS .....	79
8.9 POWERLINE CONDUCTED EMISSIONS.....	94
<b>APPENDIX I RADIO FREQUENCY EXPOSURE.....</b>	<b>97</b>
<b>APPENDIX II PHOTOGRAPHS OF TEST SETUP.....</b>	<b>98</b>
<b>APPENDIX 1 - PHOTOGRAPHS OF EUT</b>	



# 1. TEST RESULT CERTIFICATION

**Applicant:** Wistron Corporation  
21F, No. 88, Sec. 1, Hsin Tai Wu Rd., Hsichih Dist,  
New Taipei City 221, Taiwan R.O.C.

**Manufacturer:** Wistron Corporation  
21F, No. 88, Sec. 1, Hsin Tai Wu Rd., Hsichih Dist,  
New Taipei City 221, Taiwan R.O.C.

**Equipment Under Test:** Kobo Vox eReader Tablet

**Trade Name:** kobo

**Model:** K080

**Date of Test:** August 30 ~ September 14, 2011

APPLICABLE STANDARDS	
STANDARD	TEST RESULT
FCC 47 CFR Part 15 Subpart C & Industry Canada RSS-210 Issue 8 December, 2010	No non-compliance noted

### We hereby certify that:

The above equipment was tested by Compliance Certification Services Inc. The test data, data evaluation, test procedures, and equipment configurations shown in this report were made in accordance with the procedures given in ANSI C63.4: 2003 and the energy emitted by the sample EUT tested as described in this report is in compliance with the requirements of FCC Rules Part 15.207, 15.209, 15.247 and Industry Canada RSS-210.

The test results of this report relate only to the tested sample EUT identified in this report.

Approved by:

Reviewed by:

\_\_\_\_\_  
Rex Lai  
Section Manager  
Compliance Certification Services Inc.

\_\_\_\_\_  
Gina Lo  
Section Manager  
Compliance Certification Services Inc.



## 2. EUT DESCRIPTION

<b>Product</b>	Kobo Vox eReader Tablet			
<b>Trade Name</b>	kobo			
<b>Model Number</b>	K080			
<b>Model Discrepancy</b>	N/A			
<b>Received Date</b>	August 25, 2011			
<b>Power Supply</b>	<p>1. Power from Power Adapter</p> <p>A) PHIHONG / PSAC10R-050 I/P: 100-240VAC, 50-60Hz, 0.3A, 23-32VA O/P: 5V, 2.0A</p> <p>B) DARFON / BU10-0501XX (X= 0~9 for different country) I/P: 100-240VAC, 50-60Hz, 0.3A I O/P: 5V, 2.0A</p> <p>2. Power from Battery Model: D1-11-04 Rating: 3.7V, 4000mAh, 14.8Wh</p>			
<b>Frequency Range</b>	2412 ~ 2462 MHz			
<b>Transmit Power</b>	<b>Mode</b>	<b>Frequency Range</b>	<b>Output Power (dBm)</b>	<b>Output Power (Mw)</b>
	802.11b	2412 - 2462	19.44	87.9023
	802.11g	2412 - 2462	22.17	164.8162
	802.11n Standard-20 MHz	2412 - 2462	22.03	159.5879
<b>Modulation Technique</b>	<p>IEEE 802.11b mode: DSSS (1, 2, 5.5 and 11 Mbps)</p> <p>IEEE 802.11g mode: OFDM (6, 9, 12, 18, 24, 36, 48 and 54 Mbps)</p> <p>IEEE 802.11n HT 20 MHz Channel mode: OFDM (6.5, 7.2, 13, 14.4, 14.44, 19.5, 21.7, 26, 28.89, 28.9, 39, 43.3, 43.33 52, 57.78, 57.8, 58.5, 65.0, 72.2, 78, 86.67, 104, 115.56, 117, 130, 144.44 Mbps)</p>			
<b>Number of Channels</b>	<p>IEEE 802.11b/g mode: 11 Channels</p> <p>IEEE 802.11n HT 20 MHz Channel mode: 11 Channels</p>			
<b>Antenna Specification</b>	Chip Antenna / Gain: 3.0 dBi			

### Remark:

1. The sample selected for test was engineering sample that approximated to production product and was provided by manufacturer.
2. This submittal(s) (test report) is intended for FCC ID: **PU5K080** filing to comply with Section 15.207, 15.209 and 15.247 of the FCC Part 15, Subpart C Rules.



### **3. TEST METHODOLOGY**

The tests documented in this report were performed in accordance with ANSI C63.4 and FCC CFR 47 2.1046, 2.1047, 2.1049, 2.1051, 2.1053, 2.1055, 2.1057, 15.207, 15.209 and 15.247.

The tests documented in this report were performed in accordance with IC RSS-210, IC RSS-Gen, IC RSS-102, IC RSS-212, and ANSI C63.4.

This submittal(s) (test report) is intended for IC Certification with Industry Canada RSS-210.

#### **3.1 EUT CONFIGURATION**

The EUT configuration for testing is installed on RF field strength measurement to meet the Commissions requirement and operating in a manner that intends to maximize its emission characteristics in a continuous normal application.

#### **3.2 EUT EXERCISE**

The EUT was operated in the engineering mode to fix the TX frequency that was for the purpose of the measurements.

According to its specifications, the EUT must comply with the requirements of the Section 15.207, 15.209 and 15.247 under the FCC Rules Part 15 Subpart C.

The tests documented in this report were performed in accordance with IC RSS-210, IC RSS-Gen, IC RSS-102, and ANSI C63.4.

#### **3.3 GENERAL TEST PROCEDURES**

##### **Conducted Emissions**

The EUT is placed on the turntable, which is 0.8 m above ground plane. According to the requirements in Section 13.1.4.1 of ANSI C63.4 Conducted emissions from the EUT measured in the frequency range between 0.15 MHz and 30MHz using CISPR Quasi-peak and average detector modes.

##### **Radiated Emissions**

The EUT is placed on a turn table, which is 0.8 m above ground plane. The turntable shall rotate 360 degrees to determine the position of maximum emission level. EUT is set 3m away from the receiving antenna, which varied from 1m to 4m to find out the highest emission. And also, each emission was to be maximized by changing the polarization of receiving antenna both horizontal and vertical. In order to find out the maximum emissions, exploratory radiated emission measurements were made according to the requirements in Section 13.1.4.1 of ANSI C63.4.



### 3.4 FCC PART 15.205 RESTRICTED BANDS OF OPERATIONS

(a) Except as shown in paragraph (d) of this section, only spurious emissions are permitted in any of the frequency bands listed below:

MHz	MHz	MHz	GHz
0.090 - 0.110	16.42 - 16.423	399.9 - 410	4.5 - 5.15
<sup>1</sup> 0.495 - 0.505	16.69475 - 16.69525	608 - 614	5.35 - 5.46
2.1735 - 2.1905	16.80425 - 16.80475	960 - 1240	7.25 - 7.75
4.125 - 4.128	25.5 - 25.67	1300 - 1427	8.025 - 8.5
4.17725 - 4.17775	37.5 - 38.25	1435 - 1626.5	9.0 - 9.2
4.20725 - 4.20775	73 - 74.6	1645.5 - 1646.5	9.3 - 9.5
6.215 - 6.218	74.8 - 75.2	1660 - 1710	10.6 - 12.7
6.26775 - 6.26825	108 - 121.94	1718.8 - 1722.2	13.25 - 13.4
6.31175 - 6.31225	123 - 138	2200 - 2300	14.47 - 14.5
8.291 - 8.294	149.9 - 150.05	2310 - 2390	15.35 - 16.2
8.362 - 8.366	156.52475 -	2483.5 - 2500	17.7 - 21.4
8.37625 - 8.38675	156.52525	2655 - 2900	22.01 - 23.12
8.41425 - 8.41475	156.7 - 156.9	3260 - 3267	23.6 - 24.0
12.29 - 12.293	162.0125 - 167.17	3332 - 3339	31.2 - 31.8
12.51975 - 12.52025	167.72 - 173.2	3345.8 - 3358	36.43 - 36.5
12.57675 - 12.57725	240 - 285	3600 - 4400	( <sup>2</sup> )
13.36 - 13.41	322 - 335.4		

<sup>1</sup> Until February 1, 1999, this restricted band shall be 0.490-0.510 MHz.

<sup>2</sup> Above 38.6

(b) Except as provided in paragraphs (d) and (e), the field strength of emissions appearing within these frequency bands shall not exceed the limits shown in Section 15.209. At frequencies equal to or less than 1000 MHz, compliance with the limits in Section 15.209 shall be demonstrated using measurement instrumentation employing a CISPR quasi-peak detector. Above 1000 MHz, compliance with the emission limits in Section 15.209 shall be demonstrated based on the average value of the measured emissions. The provisions in Section 15.35 apply to these measurements.



### 3.5 DESCRIPTION OF TEST MODES

The EUT (model: K080) had been tested under operating condition.

Software used to control the EUT for staying in continuous transmitting mode was programmed.

After verification, all tests were carried out with the worst case test modes as shown below except radiated spurious emission below 1GHz and power line conducted emissions below 30MHz, which worst case was in normal link mode only.

**IEEE 802.11b mode:**

Channel Low (2412MHz), Channel Mid (2442MHz) and Channel High (2462MHz) with 1Mbps data rate were chosen for full testing.

**IEEE 802.11g mode:**

Channel Low (2412MHz), Channel Mid (2442MHz) and Channel High (2462MHz) with 6Mbps data rate were chosen for full testing.

**IEEE 802.11n HT 20 MHz mode:**

Channel Low (2412MHz), Channel Mid (2442MHz) and Channel High (2462MHz) with 6.5Mbps data rate were chosen for full testing.

**For spurious emission**

The field strength of spurious emission was measured in the following position: EUT stand-up position (Z axis), lie-down position (X, Y axis) and docking mode. The worst emission was found in stand-up position (Z axis) and the worst case was recorded.

**For AC line conducted emission**

The field strength of AC line conducted emission was measured in the following position: EUT stand-up position (Z axis), lie-down position (X, Y axis) and docking mode. The worst emission was found in docking mode and the worst case was recorded.





## 4. INSTRUMENT CALIBRATION

### 4.1 MEASURING INSTRUMENT CALIBRATION

The measuring equipment, which was utilized in performing the tests documented herein, has been calibrated in accordance with the manufacturer's recommendations for utilizing calibration equipment, which is traceable to recognized national standards.

### 4.2 MEASUREMENT EQUIPMENT USED

#### Equipment Used for Emissions Measurement

*Remark: Each piece of equipment is scheduled for calibration once a year and Loop Antenna is scheduled for calibration once three years.*

Conducted Emissions Test Site				
Name of Equipment	Manufacturer	Model	Serial Number	Calibration Due
Spectrum Analyzer	Agilent	E4446A	MY43360131	03/17/2012
Power Meter	Anritsu	ML2495A	1012009	04/27/2012
Power Sensor	Anritsu	MA2411B	0917072	04/27/2012

Wugu 966 Chamber A				
Name of Equipment	Manufacturer	Model	Serial Number	Calibration Due
Spectrum Analyzer	Agilent	E4446A	US42510252	11/03/2011
EMI Test Receiver	R&S	ESCI	100064	02/03/2012
Pre-Amplifier	Mini-Circuits	ZFL-1000LN	SF350700823	01/12/2012
Pre-Amplifier	MITEQ	AFS44-00102650-42-10P-44	1415367	11/19/2011
Bilog Antenna	Sunol Sciences	JB3	A030105	10/06/2011
Horn Antenna	EMCO	3117	00055165	01/12/2012
Loop Antenna	EMCO	6502	8905/2356	06/10/2013
Turn Table	CCS	CC-T-1F	N/A	N.C.R
Antenna Tower	CCS	CC-A-1F	N/A	N.C.R
Controller	CCS	CC-C-1F	N/A	N.C.R
Site NSA	CCS	N/A	N/A	12/26/2011
Test S/W	EZ-EMC (CCS-3A1RE)			

Conducted Emission room # A				
Name of Equipment	Manufacturer	Model	Serial Number	Calibration Due
EMI Test Receiver	R&S	ESHS10	843743/015	05/01/2012
LISN	SCHWARZBECK	NSLK 8127	8127-541	12/18/2011
LISN	SCHAFFNER	NNB 41	03/10013	N.C.R.
Test S/W	CCS-3A1-CE			



### 4.3 MEASUREMENT UNCERTAINTY

PARAMETER	UNCERTAINTY
Powerline Conducted Emission	+/- 1.2159
3M Semi Anechoic Chamber / 30M~200M	+/- 3.9163
3M Semi Anechoic Chamber / 200M~1000M	+/- 3.9030
3M Semi Anechoic Chamber / 1G~8G	+/- 2.5208
3M Semi Anechoic Chamber / 8G~18G	+/- 2.5659
3M Semi Anechoic Chamber / 18G~26G	+/- 2.6971
3M Semi Anechoic Chamber / 26G~40G	+/- 3.1003

**Remark:** This uncertainty represents an expanded uncertainty expressed at approximately the 95% confidence level using a coverage factor of  $k=2$ .



## 5. FACILITIES AND ACCREDITATIONS

### 5.1 FACILITIES

All measurement facilities used to collect the measurement data are located at

- No.199, Chunghsen Road, Hsintien City, Taipei Hsien, Taiwan, R.O.C.  
Tel: 886-2-2217-0894 / Fax: 886-2-2217-1029
- No.11, Wu-Gong 6th Rd., Wugu Industrial Park, New Taipei City 248, Taiwan (R.O.C.)  
Tel: 886-2-2299-9720 / Fax: 886-2-2298-4045
- No.81-1, Lane 210, Bade 2nd Rd., Lujhu Township, Taoyuan County 33841, TAIWAN,  
R.O.C.  
Tel: 886-3-324-0332 / Fax: 886-3-324-5235

The sites are constructed in conformance with the requirements of ANSI C63.7, ANSI C63.4 and CISPR Publication 22.

### 5.2 EQUIPMENT

Radiated emissions are measured with one or more of the following types of linearly polarized antennas: tuned dipole, biconical, log periodic, bi-log, and/or ridged waveguide, horn. Spectrum analyzers with pre-selectors and quasi-peak detectors are used to perform radiated measurements.

Conducted emissions are measured with Line Impedance Stabilization Networks and EMI Test Receivers.

Calibrated wideband preamplifiers, coaxial cables, and coaxial attenuators are also used for making measurements.



All receiving equipment conforms to CISPR Publication 16-1, "Radio Interference Measuring Apparatus and Measurement Methods."

### 5.3 LABORATORY ACCREDITATIONS AND LISTING

The test facilities used to perform radiated and conducted emissions tests are accredited by American Association for Laboratory Accreditation Program for the specific scope accreditation under Lab Code: 0824-01 to perform Electromagnetic Interference tests according to FCC Part 15 and CISPR 22 requirements. In addition, the test facilities are listed with Industry Canada, Certification and Engineering Bureau, IC 2324G-1 for 3M Semi Anechoic Chamber A, 2324G-2 for 3M Semi Anechoic Chamber B.



### 5.4 TABLE OF ACCREDITATIONS AND LISTINGS

Country	Agency	Scope of Accreditation	Logo
USA	FCC	3M Semi Anechoic Chamber (FCC MRA: TW1039) to perform FCC Part 15 measurements	 FCC MRA: TW1039
Taiwan	TAF	LP0002, RTTE01, FCC Method-47 CFR Part 15 Subpart C, D, E, RSS-210, RSS-310 IDA TS SRD, AS/NZS 4268, AS/NZS 4771, TS 12.1 & 12.2, ETSI EN 300 440-1, ETSI EN 300 440-2, ETSI EN 300 328, ETSI EN 300 220-1, ETSI EN 300 220-2, ETSI EN 301 893, ETSI EN 301 489-1/3/7/17 FCC OET Bulletin 65 + Supplement C, EN 50360, EN 50361, EN 50371, RSS 102, EN 50383, EN 50385, EN 50392, IEC 62209, CNS 14958-1, CNS 14959 FCC Method -47 CFR Part 15 Subpart B IEC / EN 61000-3-2, IEC / EN 61000-3-3, IEC / EN 61000-4-2/3/4/5/6/8/11	
Canada	Industry Canada	3M Semi Anechoic Chamber (IC 2324G-1 / IC 2324G-2) to perform	 IC 2324G-1 IC 2324G-2

\* No part of this report may be used to claim or imply product endorsement by A2LA or any agency of the US Government.



## 6. SETUP OF EQUIPMENT UNDER TEST

### 6.1 SETUP CONFIGURATION OF EUT

See test photographs attached in Appendix II for the actual connections between EUT and support equipment.

### 6.2 SUPPORT EQUIPMENT

No	Equipment	Brand	Model	Series No.	FCC ID	Data Cable	Power Cord
1	Notebook PC	FUjiTSU	S Series	914KG01002G03 00002DKS00	N/A	N/A	Unshielded, 2.8m
2	Multimedia Headset	Labtec	Axis-301	N/A	FCC DoC	Unshielded, 1.8m x 2	N/A
3	Mirco SD Card	N/A	N/A	N/A	SANDISK	N/A	N/A
4	Test Kit	N/A	N/A	N/A	N/A	N/A	N/A
5	Wireless Router (Remote)	PLANEX	BLW-04SAG	40DDA0421	FCC DoC	N/A	Unshielded, 1.8m

**Remark:**

1. All the equipment/cables were placed in the worst-case configuration to maximize the emission during the test.
2. Grounding was established in accordance with the manufacturer's requirements and conditions for the intended use.



## 7. APPLICABLE RULES FOR INDUSTRY CANADA RSS-210

### **RSS-210 §2 General Certification Requirements and Specifications**

#### **RSS-210 §2.1 RSS-Gen Compliance**

In addition to RSS-210, the requirements in RSS-Gen, *General Requirements and Information for the Certification of Radio Apparatus*, must be met.

#### **RSS-210 §2.2 Emissions Falling Within Restricted Frequency Bands**

Category I licence-exempt equipment is required to comply with the provisions in RSS-Gen with respect to emissions falling within restricted frequency bands. These restricted frequency bands are listed in RSS-Gen.

#### **RSS-210 §2.3 Receivers**

Category I equipment receivers for use with transmitters subject to RSS-210 must comply with the applicable requirements set out in RSS-Gen and be certified under RSS-210. Category II equipment receivers for use with transmitters subject to RSS-210 are exempt from certification, but are subject to compliance with RSS-Gen and RSS-310.

#### **RSS-210 §2.5 General Field Strength Limits**

RSS-Gen includes the general field strength limits of unwanted emissions, where applicable, for transmitters and receivers operating in accordance with the provisions specified in this standard. Unwanted emissions of transmitters and receivers are permitted to fall within the restricted bands listed in RSS-Gen, and including the TV bands, but fundamental emissions are prohibited in the restricted bands.

#### **RSS-210 §2.5.1 Transmitters with Wanted Emissions that are Within the General Field Strength Limits**

Whether or not their operation is addressed by published RSS standards, transmitters whose wanted and unwanted emissions are within the general field strength limits shown in RSS-Gen, they may operate in any of the frequency bands, other than the restricted bands listed in RSS-Gen and including the TV bands, and shall be certified under RSS-210. Under no conditions may the level of any unwanted emissions exceed the level of the fundamental emission.

**Note:** Devices operating below 490 kHz in which all emissions are at least 40 dB below the limit listed in RSS-Gen (*General Field Strength Limits for Transmitters at Frequencies below 30 MHz*) are Category II devices and are subject to RSS-310.



## **RSS-210 §2.7 Tables**

### **RSS-210 §Annex 8: Frequency Hopping and Digital Modulation Systems Operating in the 902-928 MHz, 2400-2483.5 MHz, and 5725-5850 MHz Bands**

This section applies to systems that employ frequency hopping (FH) and digital modulation technology in the 902-928 MHz, 2400-2483.5 MHz and 5725-5850 MHz bands. Systems in these bands may employ frequency hopping, digital modulation and or a combination (hybrid) of both techniques.

A frequency hopping system that synchronizes with another or several other systems (to avoid frequency collision among them) via off-air sensing or via connecting cables is not hopping randomly and therefore is not in compliance with RSS-210.

### **RSS-210 §A8.1 Frequency Hopping Systems**

Frequency hopping systems are spread spectrum systems in which the carrier is modulated with coded information in a conventional manner causing a conventional spreading of the RF energy about the carrier frequency. The frequency of the carrier is not fixed but changes at fixed intervals under the direction of a coded sequence.

Frequency hopping systems are not required to employ all available hopping frequencies during each transmission. However, the system, consisting of both the transmitter and the receiver, must be designed to comply with all of the regulations in this section should the transmitter be presented with a continuous data (or information) stream.

Incorporation of intelligence into a frequency hopping system that enables it to recognize other users of the band and to avoid occupied frequencies is permitted, provided that the frequency hopping system does it individually, and independently chooses or adapts its hopset. The coordination of frequency hopping systems in any other manner for the express purpose of avoiding the simultaneous occupancy of individual hopping frequencies by multiple transmitters is not permitted.

The following applies to frequency hopping systems in each of the three bands.

(a) The bandwidth of a frequency hopping channel is the 20 dB emission bandwidth, measured with the hopping stopped. The system RF bandwidth is equal to the channel bandwidth multiplied by the number of channels in the hopset. The hopset shall be such that the near term distribution of frequencies appears random, with sequential hops randomly distributed in both direction and magnitude of change in the hopset while the long term distribution appears evenly distributed.



(b) Frequency hopping systems shall have hopping channel carrier frequencies separated by a minimum of 25 kHz or the 20 dB bandwidth of the hopping channel, whichever is greater. Alternatively, frequency hopping systems operating in the 2400-2483.5 MHz band may have hopping channel carrier frequencies that are separated by 25 kHz or two-thirds of the 20 dB bandwidth of the hopping channel, whichever is greater, provided the systems operate with an output power no greater than 0.125 W. The system receivers shall have input bandwidths that match the hopping channel bandwidths of their corresponding transmitters and shall shift frequencies in synchronization with the transmitted signals.

(d) Frequency hopping systems operating in the 2400-2483.5 MHz band shall use at least 15 hopping channels. The average time of occupancy on any channel shall not be greater than 0.4 seconds within a period of 0.4 seconds multiplied by the number of hopping channels employed. Transmissions on particular hopping frequencies may be avoided or suppressed provided that a minimum of 15 hopping channels are used.

### **RSS-210 §A8.2 Digital Modulation Systems**

These include systems employing digital modulation techniques resulting in spectral characteristics similar to direct sequence systems. The following applies to all three bands.

### **RSS-210 §A8.4 Transmitter Output Power and e.i.r.p. Requirements**

(4) For systems employing digital modulation techniques operating in the 902-928 MHz, 2400-2483.5 MHz and 5725-5850 MHz bands, the maximum peak conducted power shall not exceed 1 W. Except as provided in Section A8.4(5), the e.i.r.p. shall not exceed 4 W.

As an alternative to a peak power measurement, compliance can be based on a measurement of the maximum conducted output power (see RSS-Gen)

(5) Point-to-point systems in the bands 2400-2483.5 MHz and 5725-5850 MHz are permitted to have an e.i.r.p. higher than 4 W, provided that the higher e.i.r.p. is achieved by employing higher gain directional antennas and not higher transmitter output powers. Point-to-multipoint systems, omni-directional applications and multiple co-located transmitters transmitting the same information are prohibited from exceeding 4 W e.i.r.p. However, remote stations of point-to-multipoint systems shall be allowed to operate at greater than 4 W e.i.r.p. under the same conditions as for point-to-point systems.

**Note:** “Fixed, point-to-point operation”, excludes point-to-multipoint systems, omnidirectional applications and multiple co-located transmitters transmitting the same information.





## **RSS-210 §A8.5 Out-of-band Emissions**

In any 100 kHz bandwidth outside the frequency band in which the spread spectrum or digitally modulated device is operating, the radio frequency power that is produced shall be at least 20 dB below that in the 100 kHz bandwidth within the band that contains the highest level of the desired power, based on either an RF conducted or a radiated measurement, provided the transmitter demonstrates compliance with the peak conducted power limits. If the transmitter complies with the conducted power limits based on the use of RMS averaging over a time interval, as permitted under section A8.4(4), the attenuation required shall be 30 dB instead of 20 dB. Attenuation below the general limits specified in Tables 2 and 3 is not required.

## **RSS-Gen §2 General Information**

### **RSS-Gen §2.1.2 Category II Equipment**

Category II equipment comprises radio devices where a standard has been prescribed but for which a TAC is not required, that is, equipment certification by Industry Canada or a Certification Body (CB) is not required (certification exempt), pursuant to subsection 4(3) of the Radiocommunication Act. The manufacturer or importer shall nevertheless ensure that the standards are complied with. A test report shall be available on request and the device shall be properly labelled.

### **RSS-Gen §2.2 Receivers**

Receivers that are used for radiocommunication other than broadcasting are defined as Category I equipment or Category II equipment, subject to compliance with applicable Industry Canada standards.

Receivers shall be capable of operation only with transmitters for which RSSs are published. Receivers are classified as described in sections 2.2.1 and 2.2.2.

#### **RSS-Gen §2.2.1 Category I Equipment Receivers**

A receiver is classified as Category I equipment if it meets one of the following conditions:

- (a) a stand-alone receiver (see Note 1, below), which operates on any frequency in the band 30-960 MHz, and is used for the reception of signals in that frequency band from a transmitter classified as Category I equipment;
- (b) a Citizen's Band (CB) receiver (26.96-27.410 MHz);
- (c) a scanner receiver.

**Note 1:** A *stand-alone receiver* is defined as any receiver that is not permanently combined together with a transmitter in a single case (transceiver), in which it functions as the receiver component of the transceiver.

Receivers classified as Category I equipment shall comply with the limits for receiver spurious emissions set out in RSS-Gen; however, equipment certification is granted under the applicable RSS standard along with the associated transmitter classified as Category I equipment. Scanner receivers are covered under their own specific RSS.

#### **RSS-Gen §2.2.2 Category II Equipment Receivers**

A receiver is classified as Category II equipment if it does not meet any of the conditions of Section 2.2.1.

Category II receivers shall comply with the applicable testing, labelling and user manual requirements in RSS-310.



**RSS-Gen §2.2.3 Licence-exempt Receivers**

Certain types of radio apparatus are permitted to operate without licensing from Industry Canada. These are typically low output power devices that are intended primarily for consumer or commercial applications; however, some are intended for applications in law enforcement, medical and other specialized applications.

Licence-exempt radio apparatus shares spectrum with licensed radio services and must operate on a no-interference, no-protection basis. Licence-exempt radio apparatus may not cause radio interference to, and cannot claim protection from interference caused by, licensed radio services.

General requirements for licence-exempt radio apparatus are contained in Section 7.

**RSS-Gen §5.6 Exposure of Humans to RF Fields**

Category I and Category II equipment shall comply with the applicable requirements of RSS-102.

**RSS-Gen §6 Receiver Spurious Emission Standard**

Receivers shall comply with the limits of spurious emissions set out in this section, measured over the frequency range determined in accordance with Section 4.10.

**RSS-Gen §6.1 Radiated Limits**

Radiated spurious emission measurements shall be performed with the receiver antenna connected to the receiver antenna terminals.

Spurious emissions from receivers shall not exceed the radiated limits shown in the table below:

**RSS-Gen Table 2 - Spurious Emission Limits for Receivers**

<b>Frequency (MHz)</b>	<b>Field Strength microvolts/m at 3 metres</b>
30-88	100
88-216	150
216-960	200
Above 960	500

\*Measurements for compliance with limits in the above table may be performed at distances other than 3 metres, in accordance with Section 7.2.7.

**RSS- Gen Table 3: Restricted Frequency Bands** <sup>(Note)</sup>

MHz	MHz	MHz	MHz	GHz
0.090-0.110	8.37625-8.38675	--	1718.8-1722.2	9.0-9.2
--	8.41425-8.41475	156.52475-156.52525	2200-2300	9.3-9.5
2.1735-2.1905	12.29-12.293	156.7-156.9	2310-2390	10.6-12.7
3.020-3.026	12.51975-12.52025	--	--	13.25-13.4
4.125-4.128	12.57675-12.57725	--	2655-2900	14.47-14.5
4.17725-4.17775	13.36-13.41	240-285	3260-3267	15.35-16.2
4.20725-4.20775	16.42-16.423	322-335.4	3332-3339	17.7-21.4
5.677-5.683	16.69475-16.69525	399.9-410	3345.8-3358	22.01-23.12
6.215-6.218	16.80425-16.80475	608-614	3500-4400	23.6-24.0
6.26775-6.26825	25.5-25.67	960-1427	4500-5150	31.2-31.8
6.31175-6.31225	37.5-38.25	1435-1626.5	5350-5460	36.43-36.5
8.291-8.294	73-74.6; 74.8-75.2	1645.5-1646.5	7250-7750	Above 38.6
8.362-8.366	108-138	1660-1710	8025-8500	

**Note:** Certain frequency bands listed in Table 2 and above 38.6 GHz are designated for low-power licence-exempt applications. These frequency bands and the requirements that apply to the devices are set out in this Standard as well as RSS-310.

**RSS- Gen Table 5: General Field Strength Limits for Transmitters at Frequencies Above 30 MHz**

Frequency (MHz)	Field Strength (microvolt/m at 3 metres)
30-88	100
88-216	150
216-960	200
Above 960	500

**Note:** Transmitting devices are not permitted in Table 1 bands or, unless stated otherwise, in TV bands (54-72 MHz, 76-88 MHz, 174-216 MHz, 470-608 MHz and 614-806 MHz).



**RSS- Gen Table 6: General Field Strength Limits for Transmitters at Frequencies Below 30 MHz (Transmit)**

Frequency (fundamental or spurious)	Field Strength (microvolts/m)	Magnetic H-Field (microamperes/m)	Measurement Distance (metres)
9-490 kHz	2,400/F (F in kHz)	2,400/377F (F in Hz)	300
490-1.705 kHz	24,000/F (F in kHz)	24,000/377F (F in kHz)	30
1.705-30 MHz	30	N/A	30

*Note: The emission limits for the bands 9-90 kHz and 110-490 kHz are based on measurements employing an average detector.*



### **RSS-Gen §7.1.2 Transmitter Antenna**

A transmitter can only be sold or operated with antennas with which it was approved. Transmitter may be approved with multiple antenna types. An antenna type comprises antennas having similar in-band and out-of-band radiation patterns. Testing shall be performed using the highest gain antenna of each combination of transmitter and antenna type for which approval is being sought, with the transmitter output power set at the maximum level. Any antenna of the same type having equal or lesser gain as an antenna that had been successfully tested with the transmitter, will also be considered approved with the transmitter, and may be used and marketed with the transmitter. For Category I transmitters, the manufacturer shall include with the application for certification a list of acceptable antenna types to be used with the transmitter.

When a measurement at the antenna connector is used to determine RF output power, the effective gain of the device's antenna shall be stated, based on measurement or on data from the antenna manufacturer.

For transmitters of RF output power of 10 milliwatts or less, only the portion of the antenna gain that is in excess of 6 dBi (6 dB above isotropic gain) shall be added to the measured RF output power to demonstrate compliance with the radiated power limits specified in the applicable standard. For transmitters of output power greater than 10 milliwatts, the total antenna gain shall be added to the measured RF output power to demonstrate compliance to the specified radiated power limits. User manuals for transmitters shall display the following notice in a conspicuous location:

*Under Industry Canada regulations, this radio transmitter may only operate using an antenna of a type and maximum (or lesser) gain approved for the transmitter by Industry Canada. To reduce potential radio interference to other users, the antenna type and its gain should be so chosen that the equivalent isotropically radiated power (e.i.r.p.) is not more than that necessary for successful communication.*

The above notice may be affixed to the device instead of displayed in the user manual.

User manuals for transmitters equipped with detachable antennas shall also contain the following notice in a conspicuous location:

*This radio transmitter (identify the device by certification number, or model number if Category II) has been approved by Industry Canada to operate with the antenna types listed below with the maximum permissible gain and required antenna impedance for each antenna type indicated. Antenna types not included in this list, having a gain greater than the maximum gain indicated for that type, are strictly prohibited for use with this device.*

Immediately following the above notice, the manufacturer shall provide a list of all antenna types approved for use with the transmitter, indicating the maximum permissible antenna gain (in dBi) and required impedance for each.



**RSS-Gen §7.2.4 Transmitter and Receiver AC Power Lines Conducted Emission Limits**

Except when the requirements applicable to a given device state otherwise, for any radio apparatus equipped to operate from the public utility AC power supply, either directly or indirectly (such as with a battery charger), the radio frequency voltage of emissions conducted back onto the AC power lines in the frequency range of 0.15 MHz to 30 MHz shall not exceed the limits shown in the table below. The more stringent limit applies at the frequency range boundaries.

The conducted emissions shall be measured with a 50 ohm/50 microhenry line impedance stabilization network (LISN).

**RSS-Gen Table 4 – AC Power Line Conducted Emission Limits**

Frequency Range (MHz)	Conducted limit (dBµV)	
	Quasi-peak	Average
0.15 to 0.5	66 to 56*	56 to 46*
0.5 to 5	56	46
5 to 30	60	50

*\*Decreases with the logarithm of the frequency.*



## 8. FCC PART 15.247 REQUIREMENTS & RSS-210 REQUIREMENTS

### 8.1 99% BANDWIDTH

#### Test Configuration

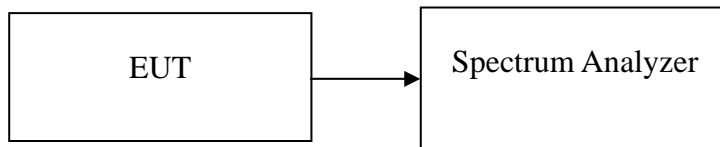

#### TEST PROCEDURE

The resolution bandwidth shall be set to as close to 1% of the selected span as is possible without being below 1%. The video bandwidth shall be set to 3 times the resolution bandwidth. Video averaging is not permitted. Where practical, a sampling detector shall be used since a peak or, peak hold.



**Test Data**

**Test mode: IEEE 802.11b mode**

Channel	Frequency (MHz)	99% Bandwidth (MHz)
Low	2412	12.8671
Mid	2442	12.8833
High	2462	12.7920

**Test mode: IEEE 802.11g mode**

Channel	Frequency (MHz)	99% Bandwidth (MHz)
Low	2412	16.7572
Mid	2442	16.7070
High	2462	16.7834

**Test mode: IEEE 802.11n HT 20 MHz Channel mode**

Channel	Frequency (MHz)	99% Bandwidth (MHz)
Low	2412	17.5928
Mid	2442	17.5757
High	2462	17.5112





**Test Plot**

**IEEE 802.11b mode**

**99% Bandwidth (CH Low)**

Agilent 13:20:16 Sep 13, 2011

R T

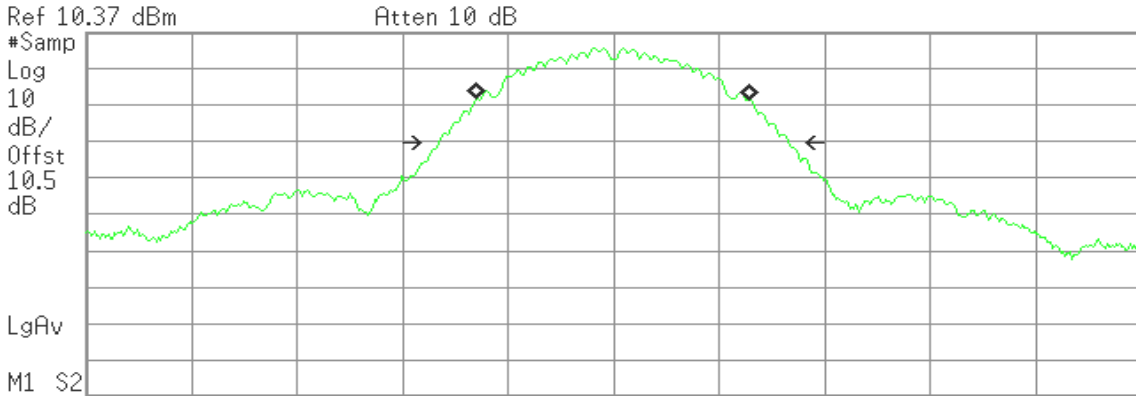

Center 2.412 00 GHz Span 50 MHz  
 #Res BW 510 kHz #VBW 1.5 MHz Sweep 1 ms (601 pts)

**Occupied Bandwidth**  
**12.8671 MHz**

**Occ BW % Pwr** 99.00 %  
**x dB** -26.00 dB

**Transmit Freq Error** -31.438 kHz  
**x dB Bandwidth** 16.551 MHz\*

**99% Bandwidth (CH Mid)**

Agilent 13:20:41 Sep 13, 2011

R T

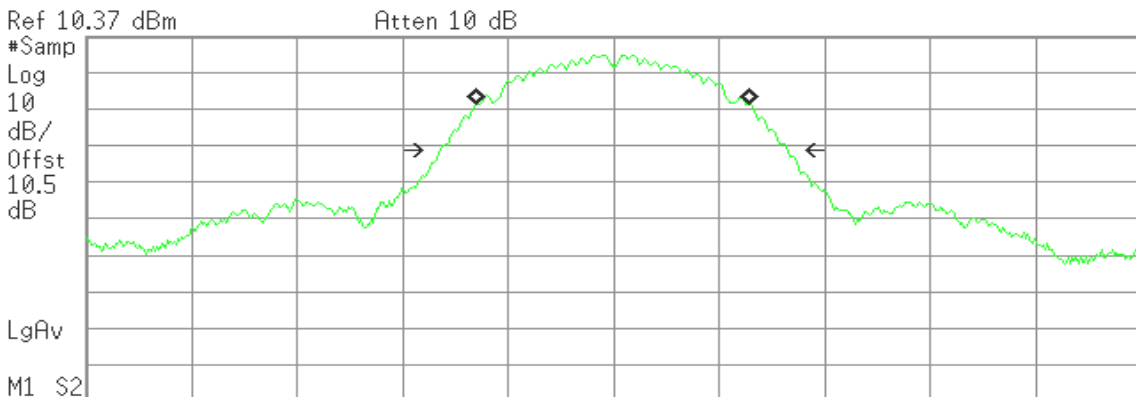

Center 2.442 00 GHz Span 50 MHz  
 #Res BW 510 kHz #VBW 1.5 MHz Sweep 1 ms (601 pts)

**Occupied Bandwidth**  
**12.8833 MHz**

**Occ BW % Pwr** 99.00 %  
**x dB** -26.00 dB

**Transmit Freq Error** -19.099 kHz  
**x dB Bandwidth** 16.397 MHz\*



### 99% Bandwidth (CH High)

Agilent 13:21:02 Sep 13, 2011

R T

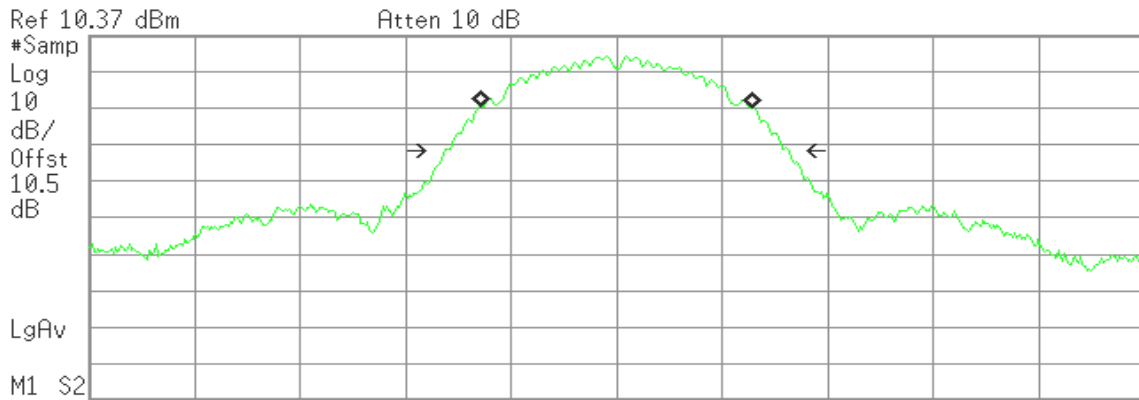

Ref 10.37 dBm      Atten 10 dB  
 #Samp  
 Log  
 10  
 dB/  
 Offst  
 10.5  
 dB  
 LgAv  
 M1 S2  
 Center 2.462 00 GHz      Span 50 MHz  
 #Res BW 510 kHz      #VBW 1.5 MHz      Sweep 1 ms (601 pts)

**Occupied Bandwidth**  
**12.7920 MHz**

**Occ BW % Pwr**    99.00 %  
**x dB**            -26.00 dB

**Transmit Freq Error**    -19.235 kHz  
**x dB Bandwidth**        16.283 MHz\*

### IEEE 802.11g mode

### 99% Bandwidth (CH Low)

Agilent 13:22:06 Sep 13, 2011

R T

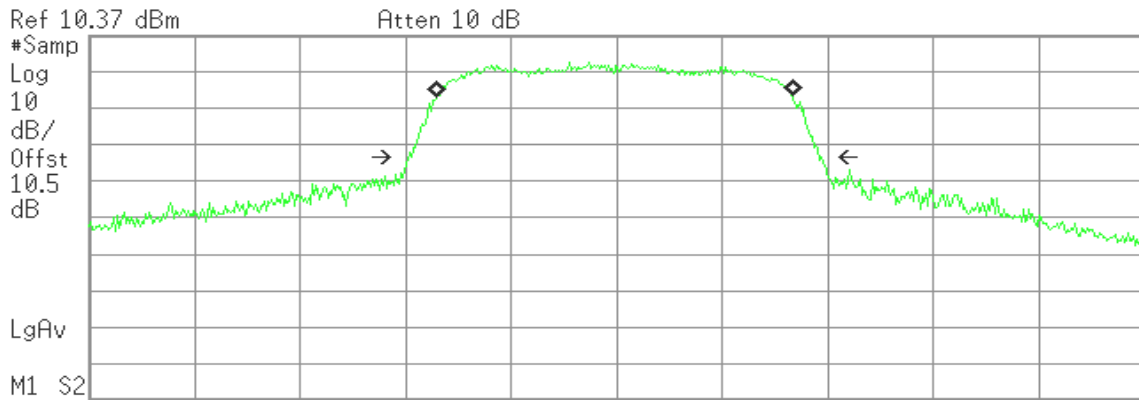

Ref 10.37 dBm      Atten 10 dB  
 #Samp  
 Log  
 10  
 dB/  
 Offst  
 10.5  
 dB  
 LgAv  
 M1 S2  
 Center 2.412 00 GHz      Span 50 MHz  
 #Res BW 510 kHz      #VBW 1.5 MHz      Sweep 1 ms (601 pts)

**Occupied Bandwidth**  
**16.7572 MHz**

**Occ BW % Pwr**    99.00 %  
**x dB**            -26.00 dB

**Transmit Freq Error**    -81.352 kHz  
**x dB Bandwidth**        19.488 MHz\*



### 99% Bandwidth (CH Mid)

Agilent 13:21:54 Sep 13, 2011

R T

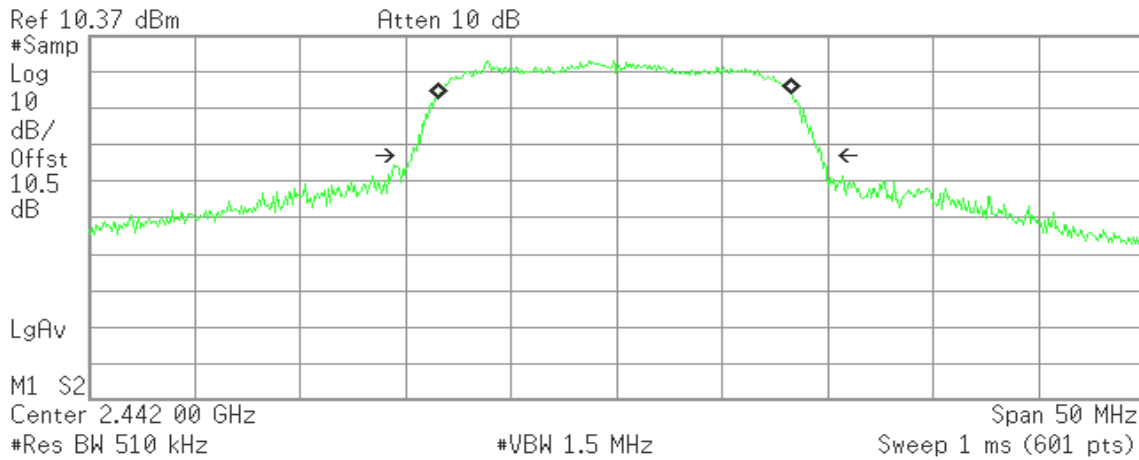

Occupied Bandwidth  
16.7070 MHz

Occ BW % Pwr 99.00 %  
x dB -26.00 dB

Transmit Freq Error -71.923 kHz  
x dB Bandwidth 19.321 MHz\*

### 99% Bandwidth (CH High)

Agilent 13:21:39 Sep 13, 2011

R T

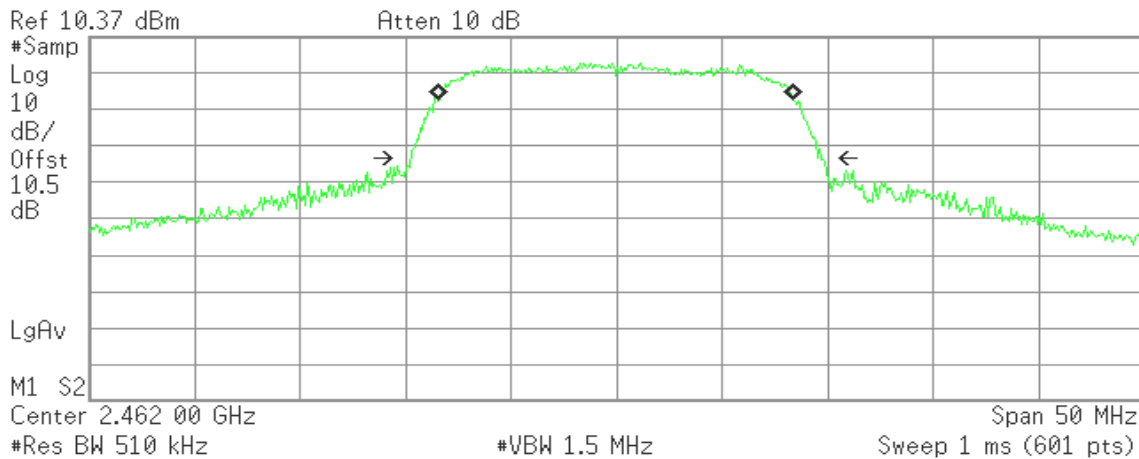

Occupied Bandwidth  
16.7834 MHz

Occ BW % Pwr 99.00 %  
x dB -26.00 dB

Transmit Freq Error -63.480 kHz  
x dB Bandwidth 19.372 MHz\*



### IEEE 802.11n HT 20 MHz Channel mode

#### 99% Bandwidth (CH Low)

Agilent 13:22:28 Sep 13, 2011

R T

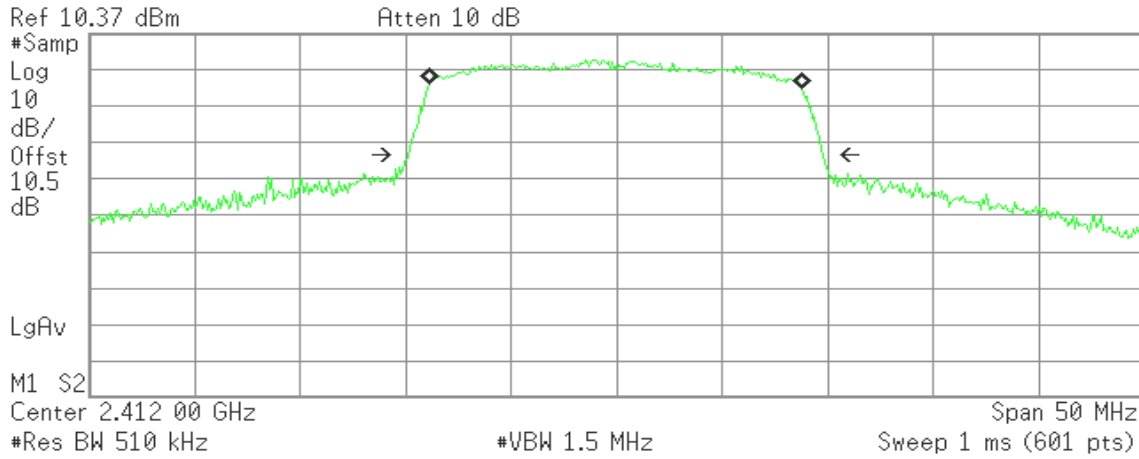

**Occupied Bandwidth**  
17.5928 MHz

**Occ BW % Pwr** 99.00 %  
**x dB** -26.00 dB

**Transmit Freq Error** -55.994 kHz  
**x dB Bandwidth** 19.561 MHz\*

#### 99% Bandwidth (CH Mid)

Agilent 13:22:48 Sep 13, 2011

R T

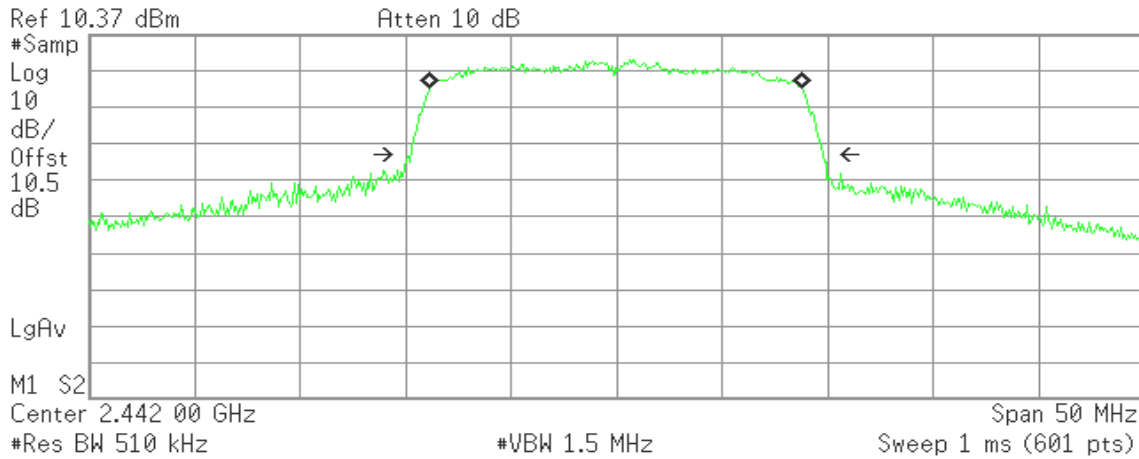

**Occupied Bandwidth**  
17.5757 MHz

**Occ BW % Pwr** 99.00 %  
**x dB** -26.00 dB

**Transmit Freq Error** -29.156 kHz  
**x dB Bandwidth** 19.471 MHz\*



### 99% Bandwidth (CH High)

Agilent 13:23:40 Sep 13, 2011

R T

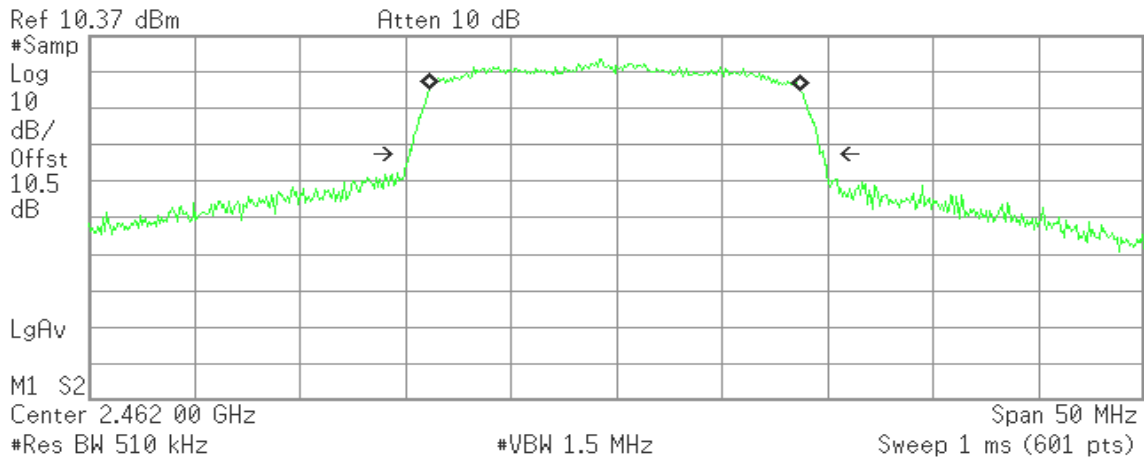

**Occupied Bandwidth**  
17.5112 MHz

**Occ BW % Pwr** 99.00 %  
**x dB** -26.00 dB

**Transmit Freq Error** -57.435 kHz  
**x dB Bandwidth** 19.566 MHz\*



## 8.2 6DB BANDWIDTH

### LIMIT

According to §15.247(a)(2) & RSS-210 §A8.2(a), systems using digital modulation techniques may operate in the 902 - 928 MHz, 2400 - 2483.5 MHz, and 5725 - 5850 MHz bands. The minimum 6dB bandwidth shall be at least 500 kHz.

### Test Configuration

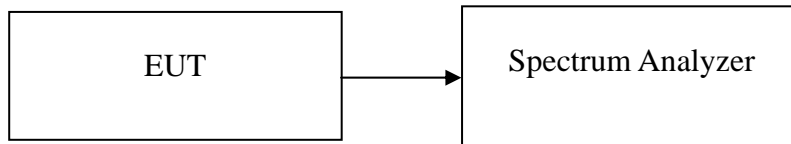

### TEST PROCEDURE

1. Place the EUT on the table and set it in the transmitting mode.
2. Remove the antenna from the EUT and then connect a low loss RF cable from the antenna port to the spectrum analyzer.
3. Set the spectrum analyzer as RBW = 100 kHz, VBW = 300 kHz, Span = 50 MHz, Sweep = 500ms.
4. Mark the peak frequency and -6dB (upper and lower) frequency.
5. Repeat until all the rest channels are investigated.

### TEST RESULTS

*No non-compliance noted*



**Test Data**

**Test mode: IEEE 802.11b mode**

Channel	Frequency (MHz)	6dB Bandwidth (MHz)	Limit (kHz)	Result
Low	2412	8.1666	>500	PASS
Mid	2442	8.1666		PASS
High	2462	8.1666		PASS

**Test mode: IEEE 802.11g mode**

Channel	Frequency (MHz)	6dB Bandwidth (MHz)	Limit (kHz)	Result
Low	2412	15.3334	>500	PASS
Mid	2442	15.1666		PASS
High	2462	15.25		PASS

**Test mode: IEEE 802.11n HT 20 MHz Channel mode**

Channel	Frequency (MHz)	6dB Bandwidth (MHz)	Limit (kHz)	Result
Low	2412	15.25	>500	PASS
Mid	2442	15.3334		PASS
High	2462	15.25		PASS



**Test Plot**

**IEEE 802.11b mode**

**6dB Bandwidth (CH Low)**

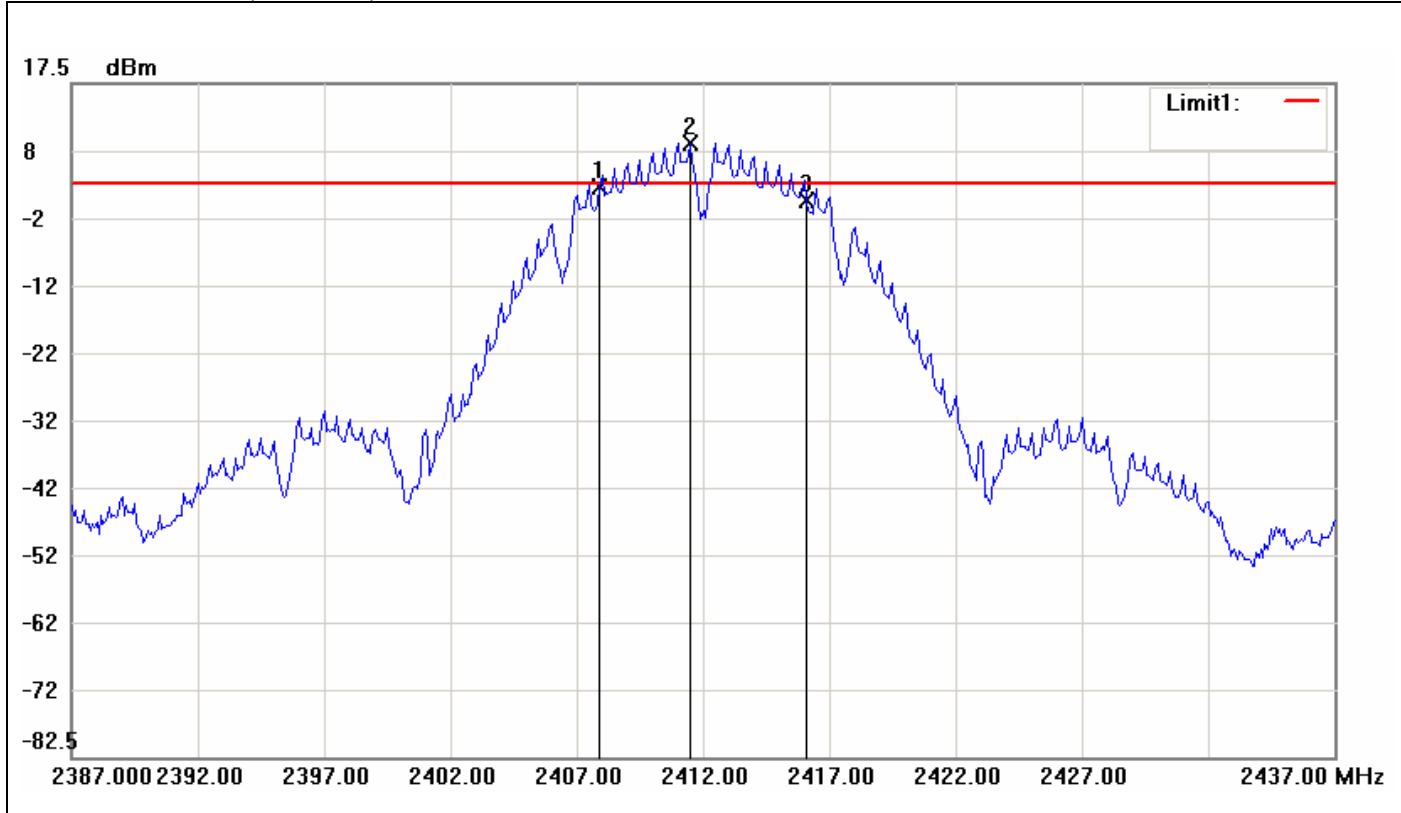

No.	Frequency(MHz)	Level(dBm)	Limit(dBm)	Margin(dBm)
1	2407.9167	2.24	2.74	-0.50
2	2411.5000	8.74	2.74	6.00
3	2416.0833	0.13	2.74	-2.61

No.		$\Delta$ Frequency(MHz)	$\Delta$ Level(dB)
1	mk3-mk1	8.1666	-2.11





**6dB Bandwidth (CH Mid)**

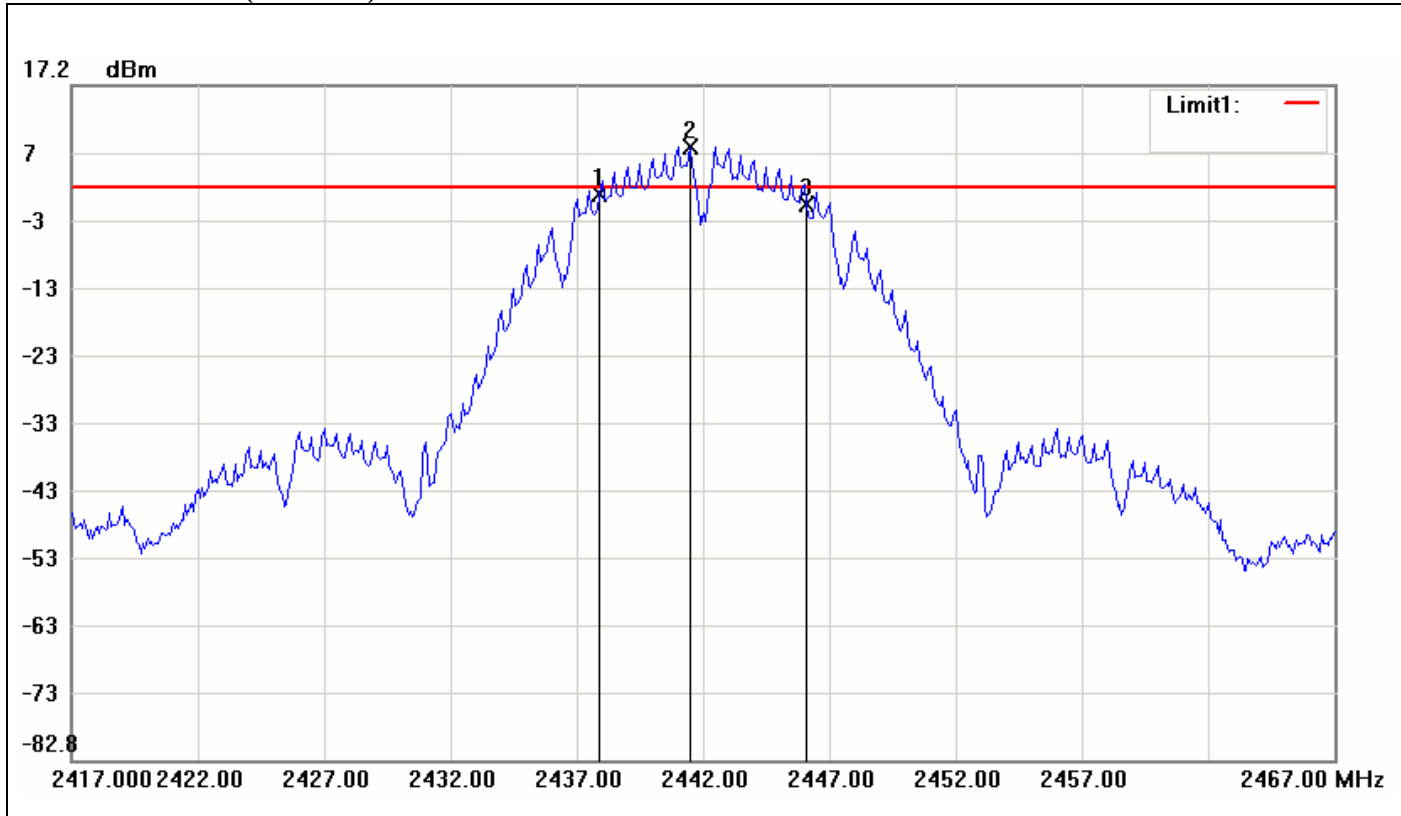

No.	Frequency(MHz)	Level(dBm)	Limit(dBm)	Margin(dBm)
1	2437.9167	1.02	2.14	-1.12
2	2441.5000	8.14	2.14	6.00
3	2446.0833	-0.47	2.14	-2.61

No.		$\Delta$ Frequency(MHz)	$\Delta$ Level(dB)
1	mk3-mk1	8.1666	-1.49



### 6dB Bandwidth (CH High)

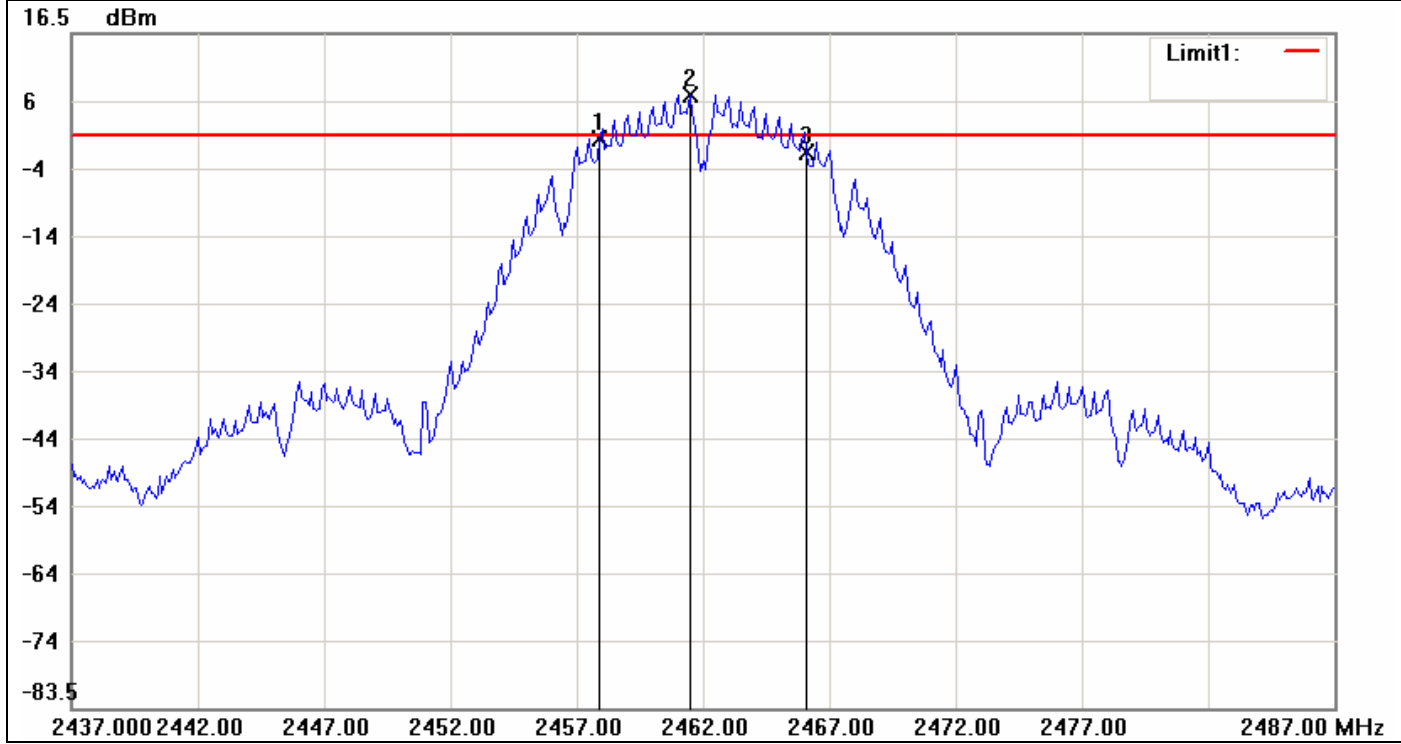

No.	Frequency(MHz)	Level(dBm)	Limit(dBm)	Margin(dBm)
1	2457.9167	0.94	1.45	-0.51
2	2461.5000	7.45	1.45	6.00
3	2466.0833	-1.03	1.45	-2.48

No.		$\Delta$ Frequency(MHz)	$\Delta$ Level(dB)
1	mk3-mk1	8.1666	-1.97



IEEE 802.11g mode

6dB Bandwidth (CH Low)

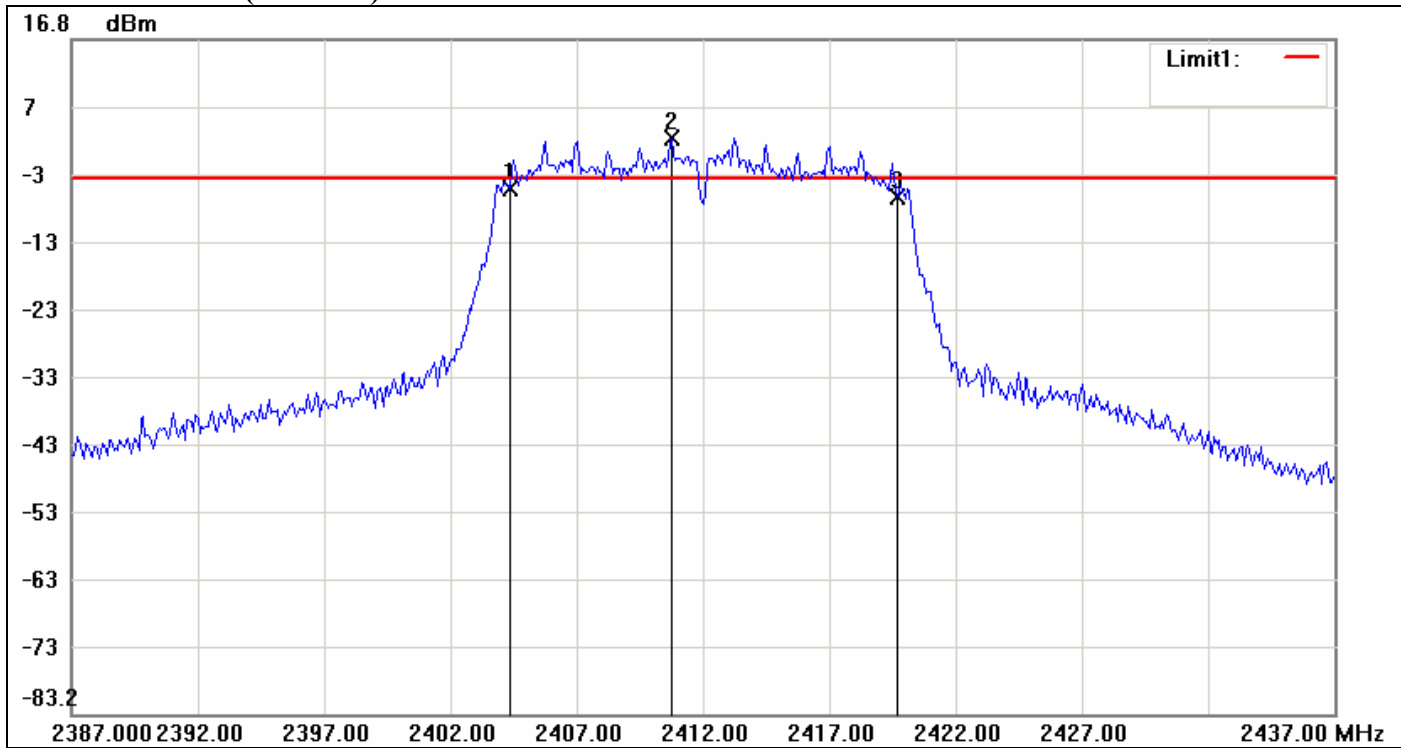

No.	Frequency(MHz)	Level(dBm)	Limit(dBm)	Margin(dBm)
1	2404.3333	-5.42	-3.71	-1.71
2	2410.7500	2.29	-3.71	6.00
3	2419.6667	-6.50	-3.71	-2.79

No.	$\Delta$ Frequency(MHz)	$\Delta$ Level(dB)
1	mk3-mk1	15.3334



**6dB Bandwidth (CH Mid)**

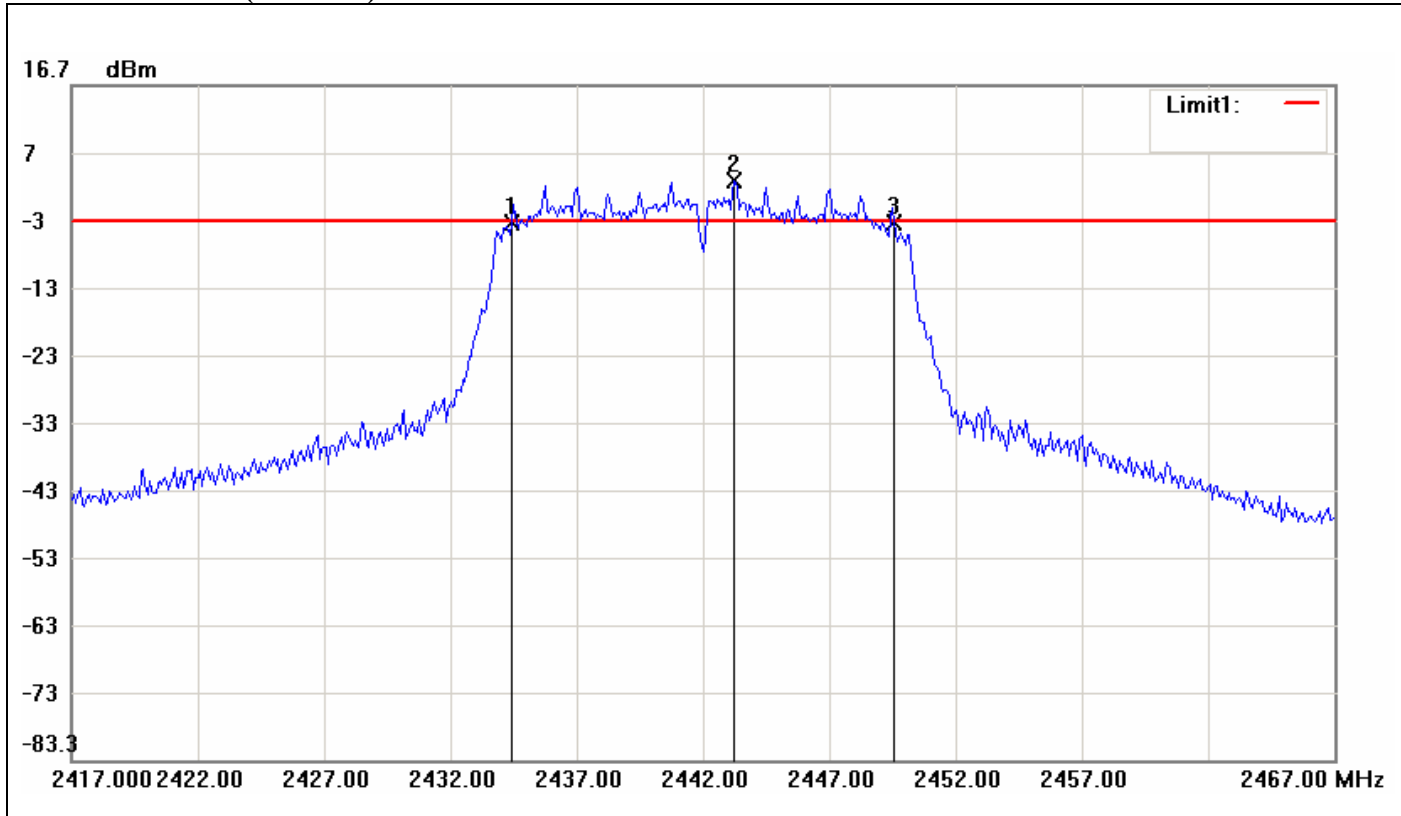

No.	Frequency(MHz)	Level(dBm)	Limit(dBm)	Margin(dBm)
1	2434.4167	-3.80	-3.54	-0.26
2	2443.2500	2.46	-3.54	6.00
3	2449.5833	-3.81	-3.54	-0.27

No.		$\Delta$ Frequency(MHz)	$\Delta$ Level(dB)
1	mk3-mk1	15.1666	-0.01



**6dB Bandwidth (CH High)**

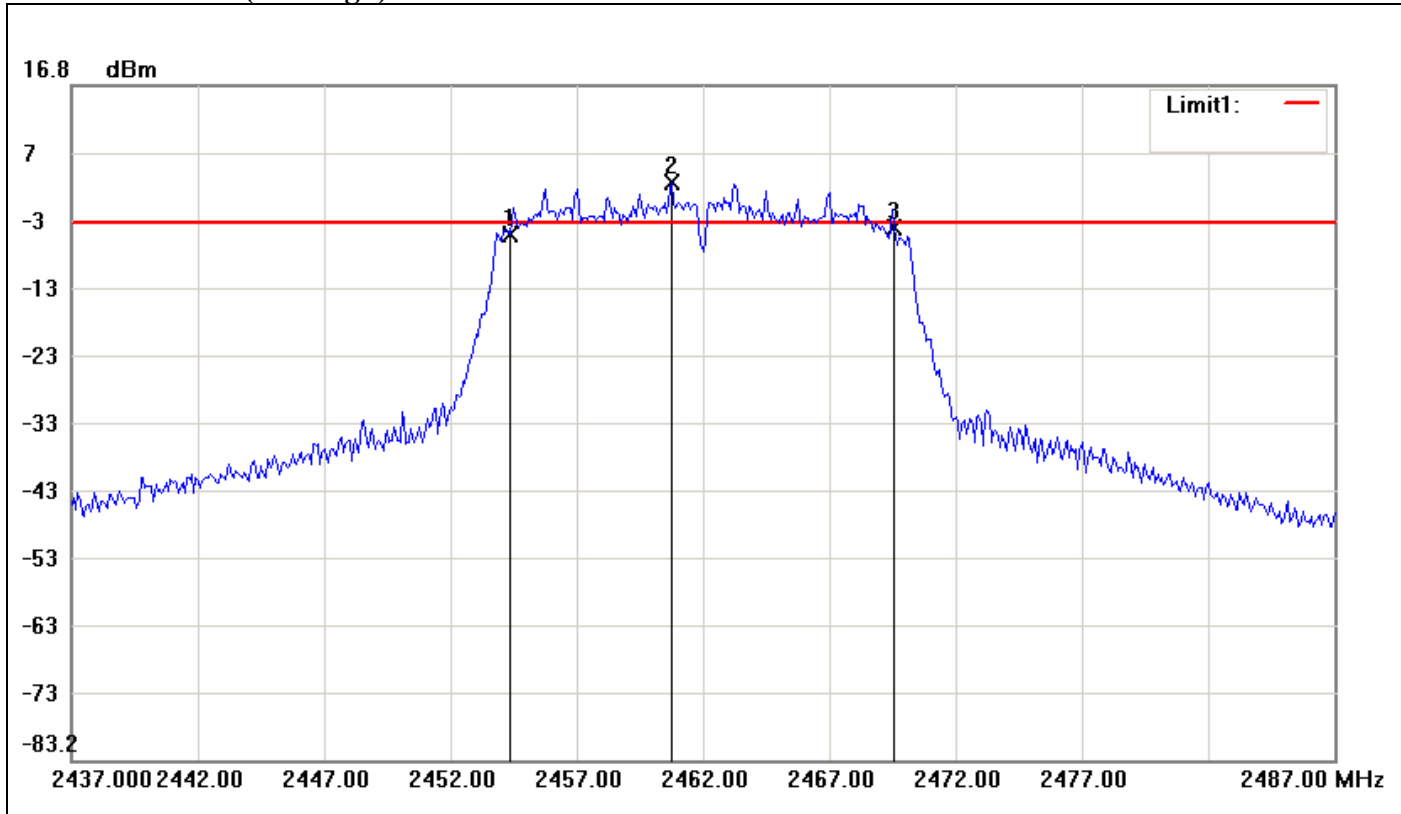

No.	Frequency(MHz)	Level(dBm)	Limit(dBm)	Margin(dBm)
1	2454.3333	-5.39	-3.57	-1.82
2	2460.7500	2.43	-3.57	6.00
3	2469.5833	-4.23	-3.57	-0.66

No.		$\Delta$ Frequency(MHz)	$\Delta$ Level(dB)
1	mk3-mk1	15.25	1.16



### IEEE 802.11n HT 20 MHz Channel mode

#### 6dB Bandwidth (CH Low)

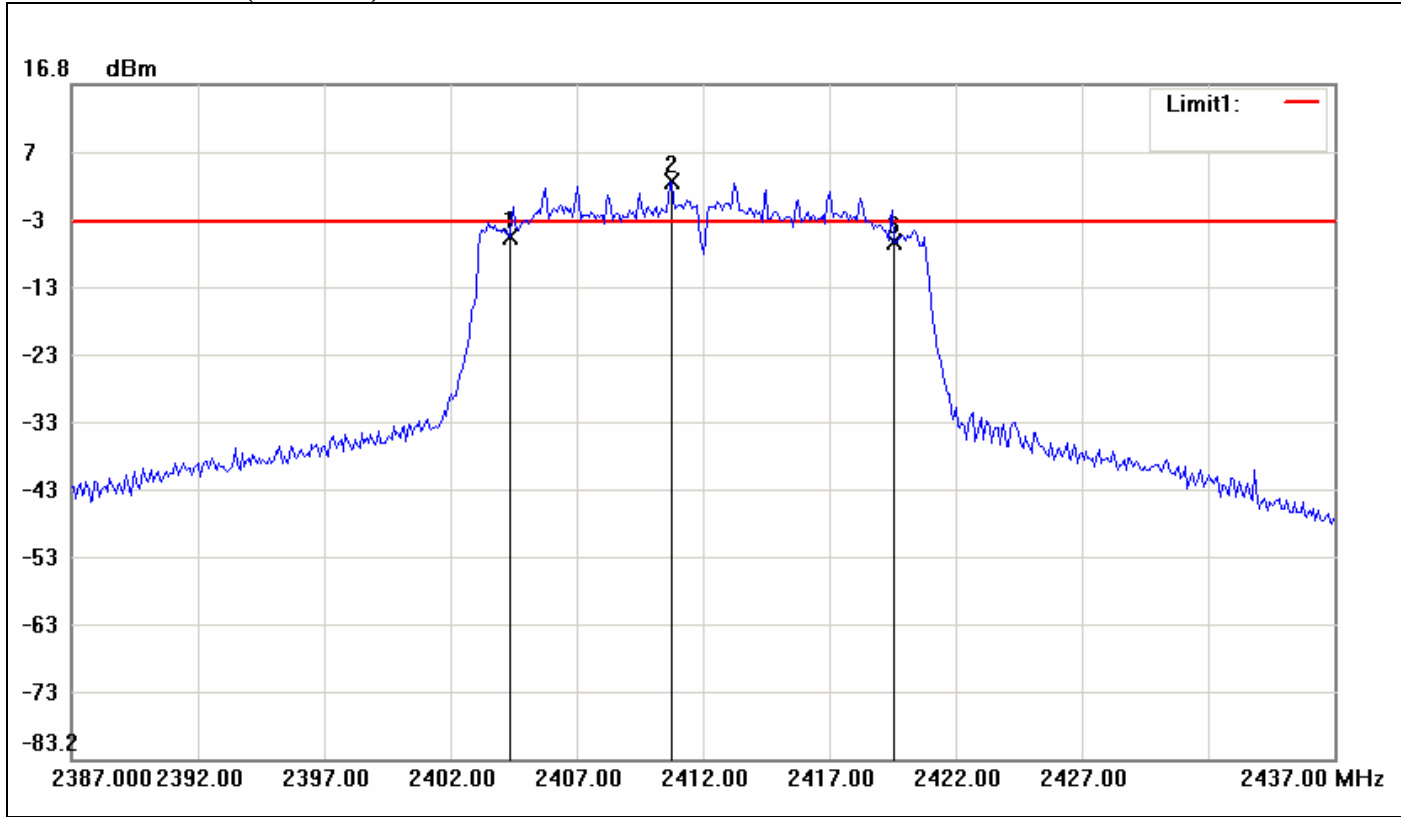

No.	Frequency(MHz)	Level(dBm)	Limit(dBm)	Margin(dBm)
1	2404.3333	-5.89	-3.65	-2.24
2	2410.7500	2.35	-3.65	6.00
3	2419.5833	-6.51	-3.65	-2.86

No.		$\Delta$ Frequency(MHz)	$\Delta$ Level(dB)
1	mk3-mk1	15.25	-0.62



**6dB Bandwidth (CH Mid)**

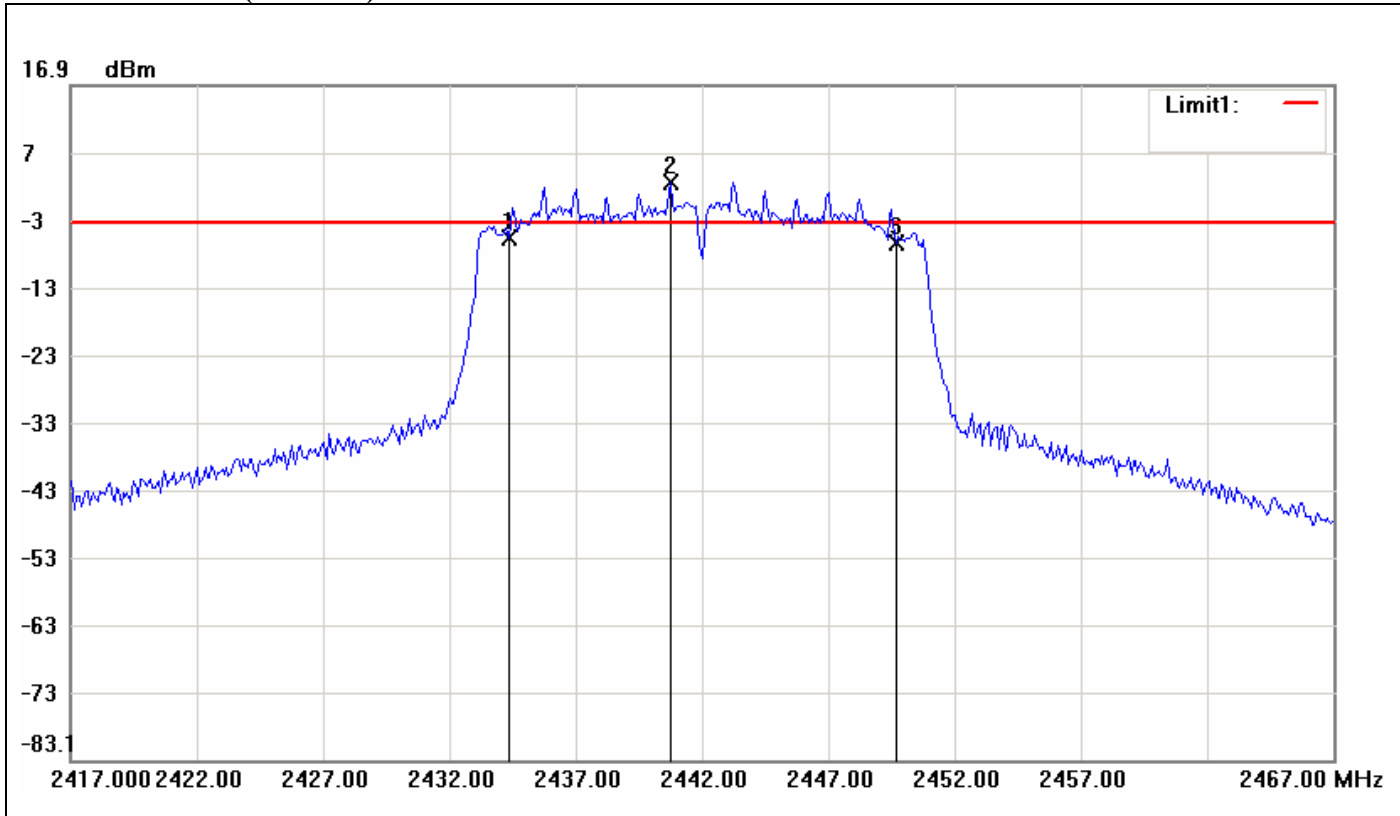

No.	Frequency(MHz)	Level(dBm)	Limit(dBm)	Margin(dBm)
1	2434.3333	-5.75	-3.50	-2.25
2	2440.7500	2.50	-3.50	6.00
3	2449.6667	-6.46	-3.50	-2.96

No.	$\Delta$ Frequency(MHz)	$\Delta$ Level(dB)
1	mk3-mk1	15.3334
		-0.71



**6dB Bandwidth (CH High)**

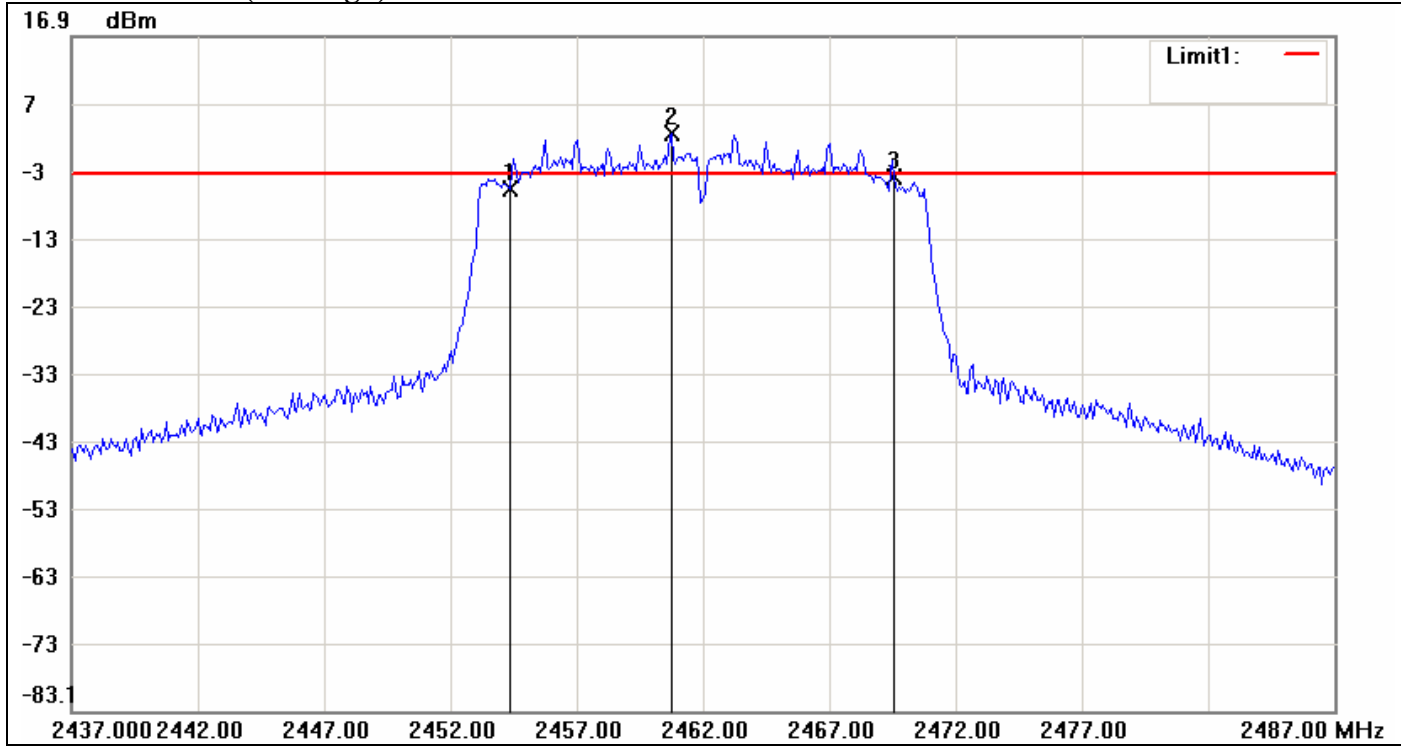

No.	Frequency(MHz)	Level(dBm)	Limit(dBm)	Margin(dBm)
1	2454.3333	-5.77	-3.54	-2.23
2	2460.7500	2.46	-3.54	6.00
3	2469.5833	-3.83	-3.54	-0.29

No.		$\Delta$ Frequency(MHz)	$\Delta$ Level(dB)
1	mk3-mk1	15.25	1.94





### 8.3 PEAK POWER

#### LIMIT

The maximum peak output power of the intentional radiator shall not exceed the following:

1. According to §15.247(b)(3), for systems using digital modulation in the bands of 902-928 MHz, 2400-2483.5 MHz, and 5725-5850 MHz: 1 Watt.
2. According to §15.247(b)(4), the conducted output power limit specified in paragraph (b) of this section is based on the use of antennas with directional gains that do not exceed 6 dBi. Except as shown in paragraph (c) of this section, if transmitting antennas of directional gain greater than 6 dBi are used, the conducted output power from the intentional radiator shall be reduced below the stated values in paragraphs (b)(1), (b)(2), and (b)(3) of this section, as appropriate, by the amount in dB that the directional gain of the antenna exceeds 6 dBi.
3. According to RSS-210 §A8.4(4), for systems employing digital modulation techniques operating in the bands 902-928 MHz, 2400-2483.5 MHz and 5725-5850 MHz, the maximum peak conducted output power shall not exceed 1 W.

#### Test Configuration

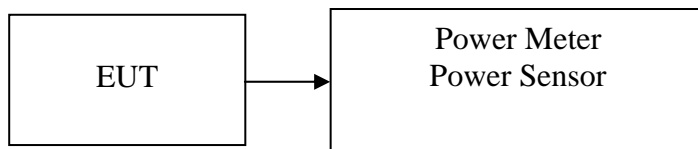

#### TEST PROCEDURE

The transmitter output is connected to the Power Meter. The Power Meter is set to the peak power detection.

#### TEST RESULTS

*No non-compliance noted*



**Test Data**

**Test mode: IEEE 802.11b mode**

Channel	Frequency (MHz)	Output Power (dBm)	Output Power (W)	Limit (W)	Result
Low	2412	19.44	0.0879	1.00	PASS
Mid	2442	18.82	0.0762		PASS
High	2462	18.17	0.0656		PASS

**Test mode: IEEE 802.11g mode**

Channel	Frequency (MHz)	Output Power (dBm)	Output Power (W)	Limit (W)	Result
Low	2412	22.09	0.1618	1.00	PASS
Mid	2442	22.17	0.1648		PASS
High	2462	22.04	0.1600		PASS

**Test mode: IEEE 802.11n HT 20 MHz Channel mode**

Channel	Frequency (MHz)	Output Power (dBm)	Output Power (W)	Limit (W)	Result
Low	2412	22.03	0.1596	1.00	PASS
Mid	2442	22	0.1585		PASS
High	2462	22.02	0.1592		PASS



## 8.4 AVERAGE POWER

### LIMIT

None; for reporting purposes only.

### Test Configuration

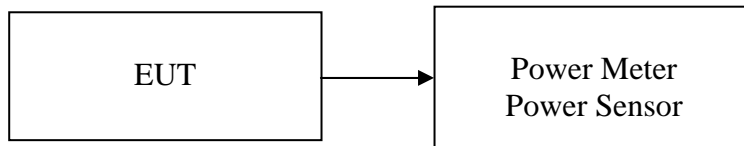

### TEST PROCEDURE

The transmitter output is connected to the Power Meter. The Power Meter is set to the peak power detection.

### TEST RESULTS

*No non-compliance noted*



**Test Data**

**Test mode: IEEE 802.11b mode**

Channel	Frequency (MHz)	Output Power (dBm)	Output Power (W)
Low	2412	16.61	0.0458
Mid	2442	16.07	0.0405
High	2462	15.34	0.0342

**Test mode: IEEE 802.11g mode**

Channel	Frequency (MHz)	Output Power (dBm)	Output Power (W)
Low	2412	12.68	0.0185
Mid	2442	12.87	0.0194
High	2462	12.63	0.0183

**Test mode: IEEE 802.11n HT 20 MHz Channel mode**

Channel	Frequency (MHz)	Output Power (dBm)	Output Power (W)
Low	2412	12.65	0.0184
Mid	2442	12.51	0.0178
High	2462	12.52	0.0179



## 8.5 BAND EDGES MEASUREMENT

### LIMIT

According to §15.247(d) & RSS-210 §A8.5, in any 100 kHz bandwidth outside the frequency bands in which the spread spectrum intentional radiator is operating, the radio frequency power that is produced by the intentional radiator shall be at least 20 dB below that in the 100 kHz bandwidth within the band that contains the highest level of the desired power, based on either an RF conducted or a radiated measurement, provided the transmitter demonstrates compliance with the peak conducted power limits. In addition, radiated emissions which fall in the restricted bands, as defined in §15.205(a), must also comply with the radiated emission limits specified in 15.209(a) (see Section 15.205(c)).

### Test Configuration

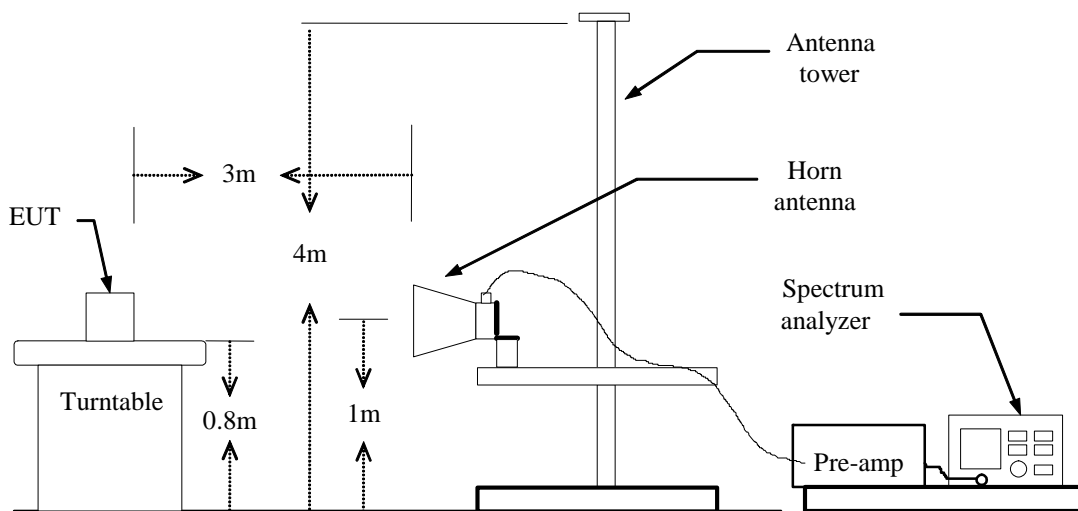

### TEST PROCEDURE

1. The EUT is placed on a turntable, which is 0.8m above the ground plane.
2. The turntable shall be rotated for 360 degrees to determine the position of maximum emission level.
3. EUT is set 3m away from the receiving antenna, which is varied from 1m to 4m to find out the highest emission.
4. Set the spectrum analyzer in the following setting in order to capture the lower and upper band-edges of the emission:
  - (a) PEAK: RBW=VBW=1MHz / Sweep=AUTO
  - (b) AVERAGE: RBW=1MHz / VBW=10Hz / Sweep=AUTO
5. Repeat the procedures until all the PEAK and AVERAGE versus POLARIZATION are measured.

### TEST RESULTS

Refer to attach spectrum analyzer data chart.



### Band Edges (IEEE 802.11b mode / CH Low)

Detector mode: Peak

Polarity: Vertical

Agilent 20:04:33 14 Sep 2011

R T

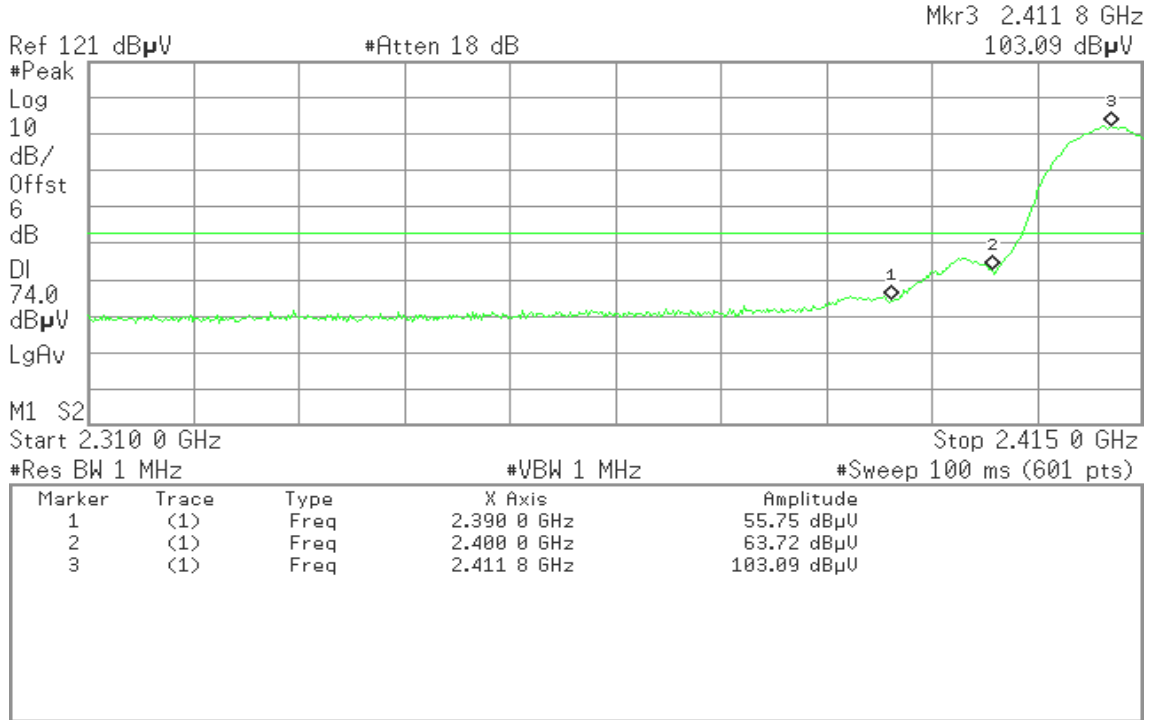

Detector mode: Average

Polarity: Vertical

Agilent 20:04:09 14 Sep 2011

R T

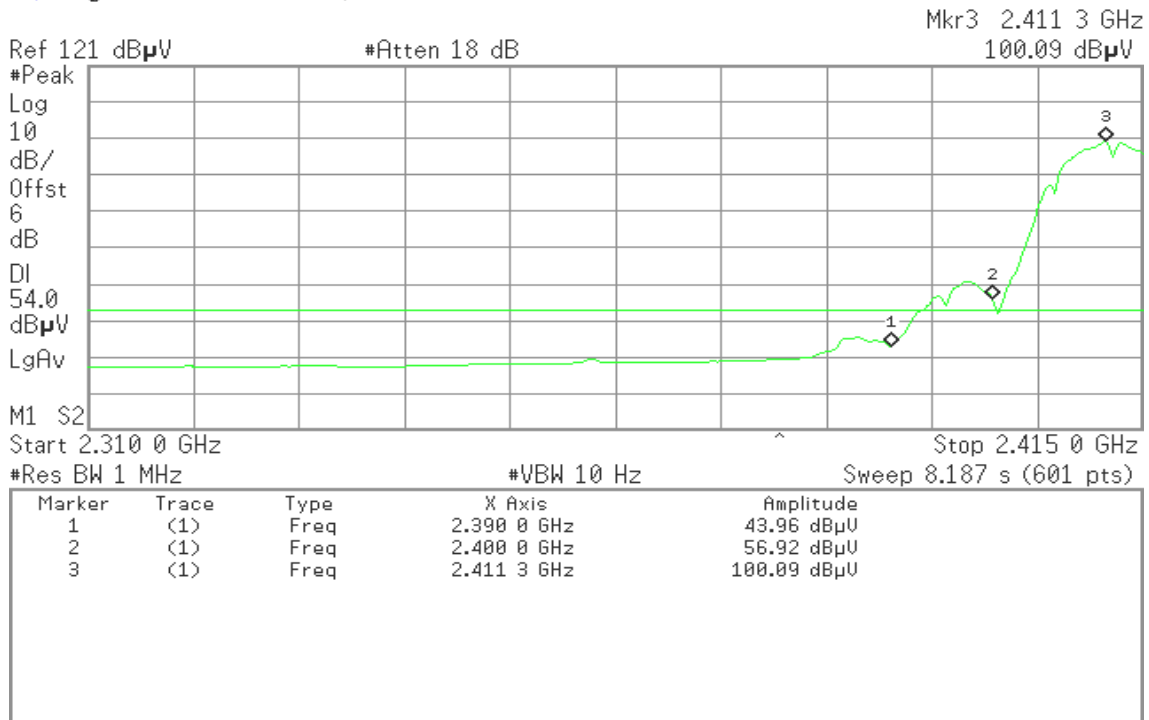



Detector mode: Peak

Polarity: Horizontal

Agilent 20:05:20 14 Sep 2011

R T

Mkr3 2.411 8 GHz  
103.38 dBµV

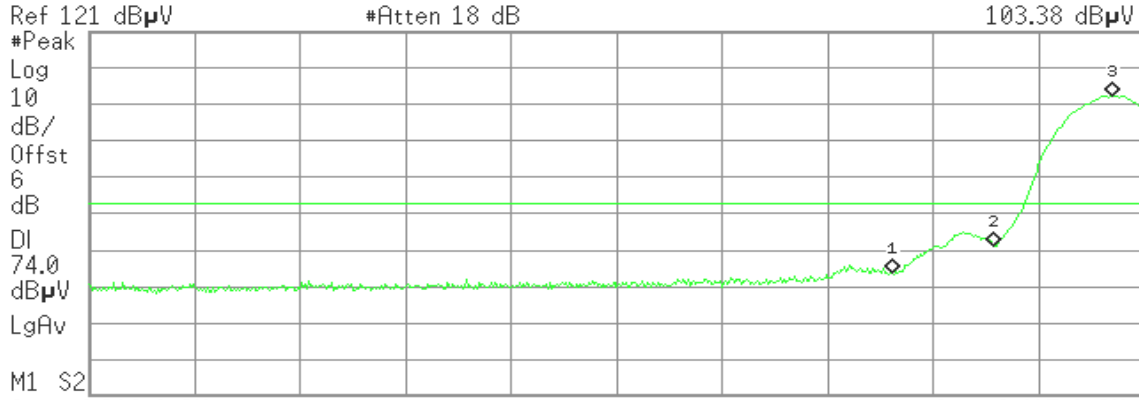

Marker	Trace	Type	X Axis	Amplitude
1	(1)	Freq	2.390 0 GHz	54.82 dBµU
2	(1)	Freq	2.400 0 GHz	62.32 dBµU
3	(1)	Freq	2.411 8 GHz	103.38 dBµU

#Res BW 1 MHz #VBW 1 MHz #Sweep 100 ms (601 pts)

Detector mode: Average

Polarity: Horizontal

Agilent 20:05:50 14 Sep 2011

R T

Mkr3 2.411 2 GHz  
100.37 dBµV

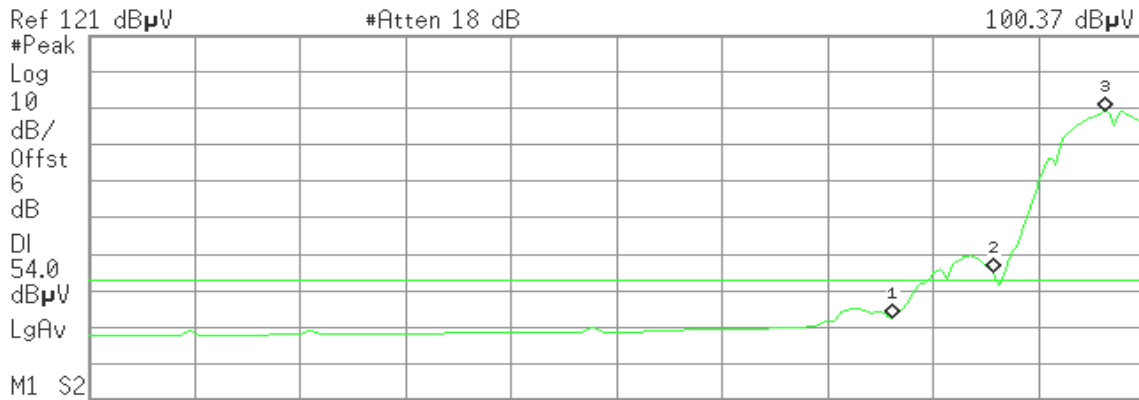

Marker	Trace	Type	X Axis	Amplitude
1	(1)	Freq	2.390 0 GHz	43.63 dBµU
2	(1)	Freq	2.400 0 GHz	55.93 dBµU
3	(1)	Freq	2.411 2 GHz	100.37 dBµU

#Res BW 1 MHz #VBW 10 Hz Sweep 8.187 s (601 pts)



### Band Edges (IEEE 802.11b mode / CH High)

Detector mode: Peak

Polarity: Vertical

Agilent 19:34:30 14 Sep 2011

R T

Mkr1 2.483 50 GHz  
52.80 dB $\mu$ V

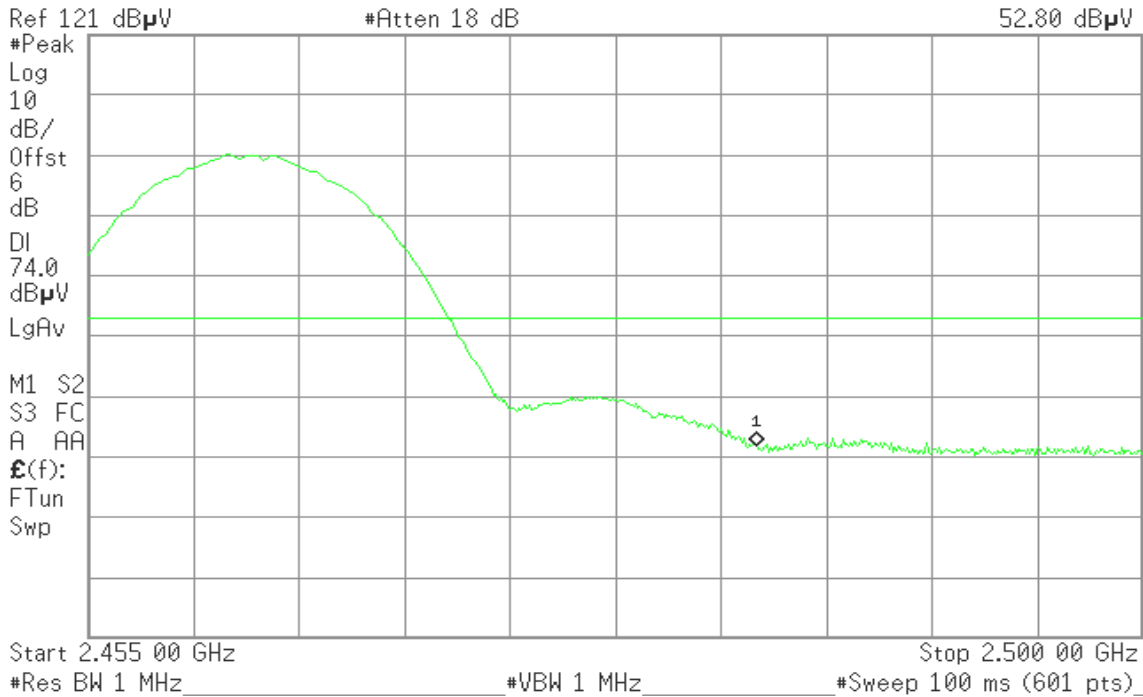

Detector mode: Average

Polarity: Vertical

Agilent 19:34:52 14 Sep 2011

R T

Mkr1 2.483 50 GHz  
40.52 dB $\mu$ V







**Detector mode: Peak**

**Polarity: Horizontal**

Agilent 19:29:24 14 Sep 2011

R T

Mkr1 2.483 50 GHz  
52.62 dB $\mu$ V

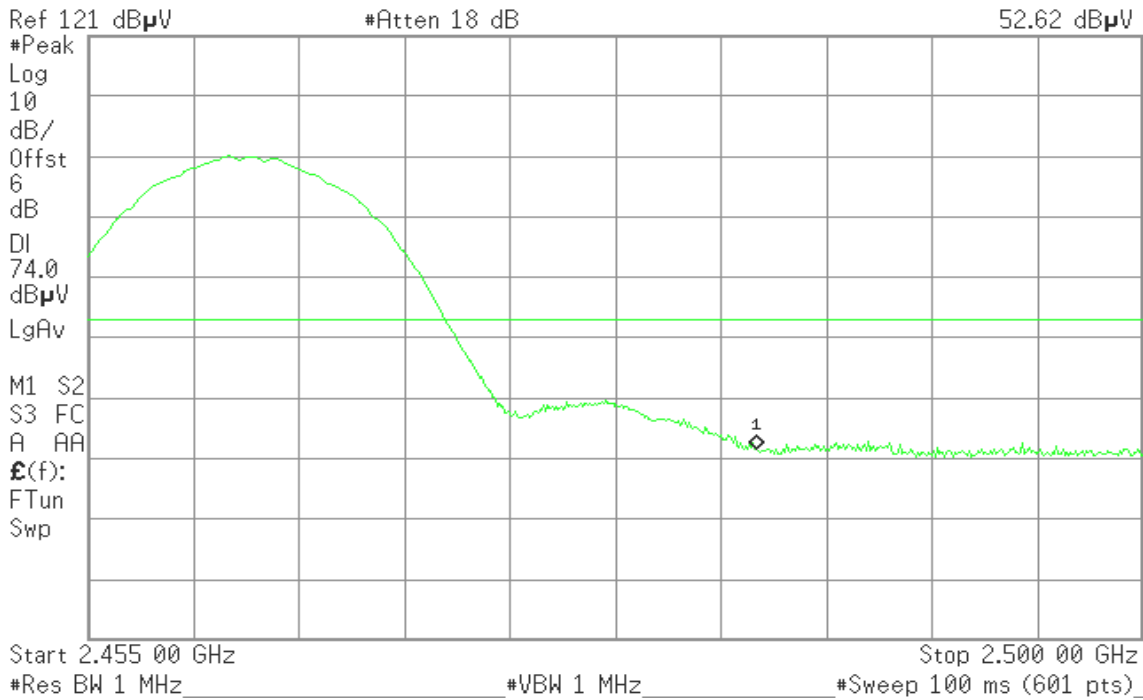

**Detector mode: Average**

**Polarity: Horizontal**

Agilent 19:30:20 14 Sep 2011

R T

Mkr1 2.483 50 GHz  
40.21 dB $\mu$ V

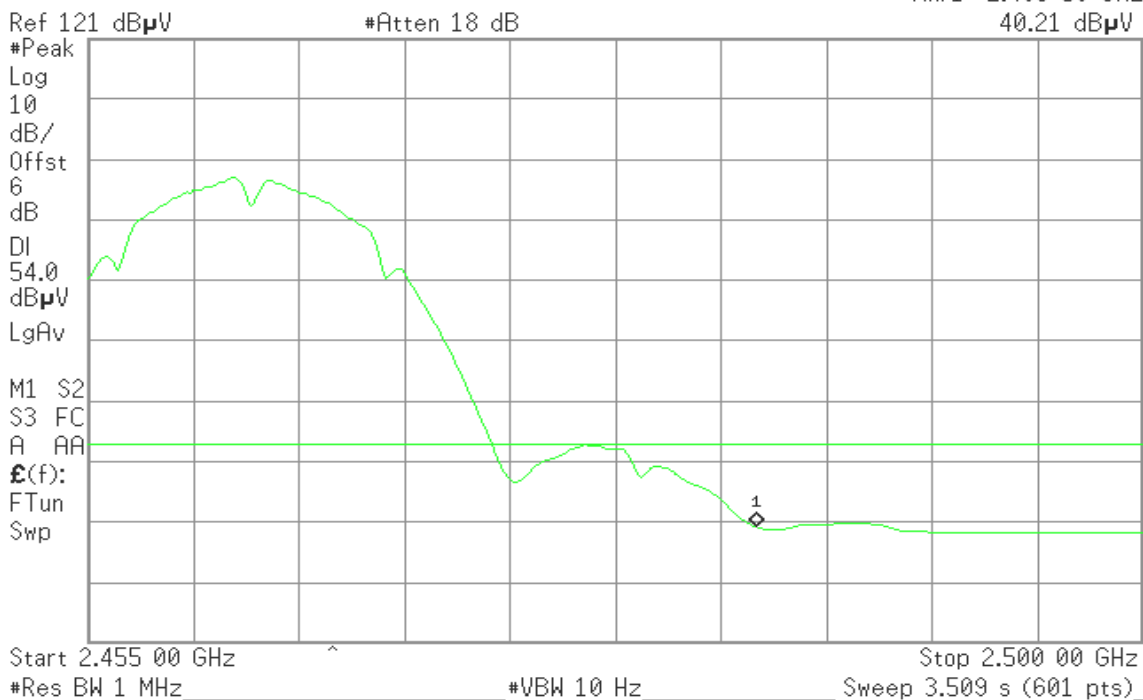



### Band Edges (IEEE 802.11g mode / CH Low)

Detector mode: Peak

Polarity: Vertical

Agilent 20:01:34 14 Sep 2011

R T

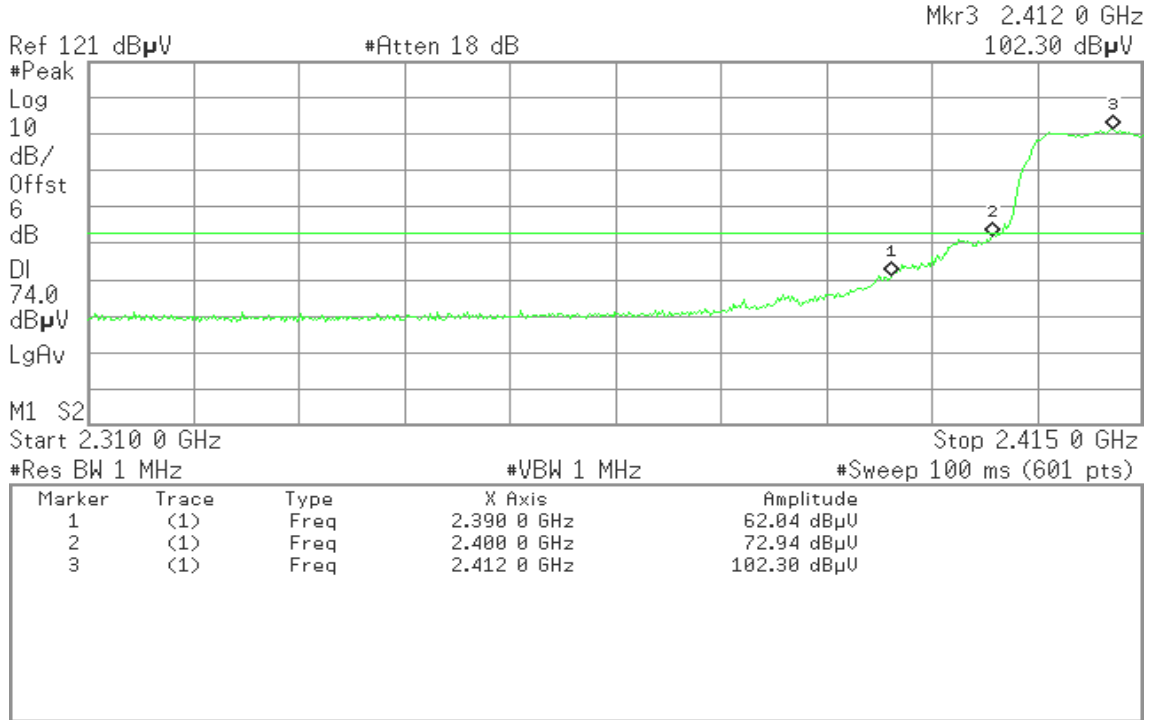

Detector mode: Average

Polarity: Vertical

Agilent 20:02:02 14 Sep 2011

R T

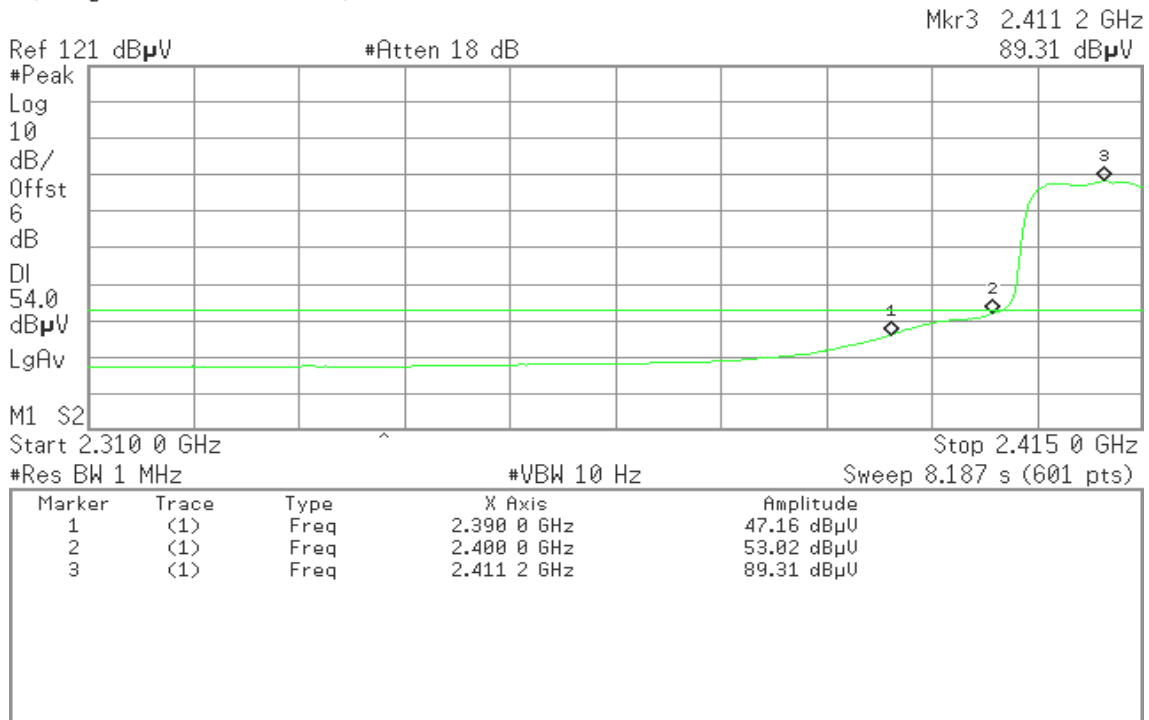



Detector mode: Peak

Polarity: Horizontal

Agilent 20:00:11 14 Sep 2011

R T

Mkr3 2.412 0 GHz  
102.65 dBµV

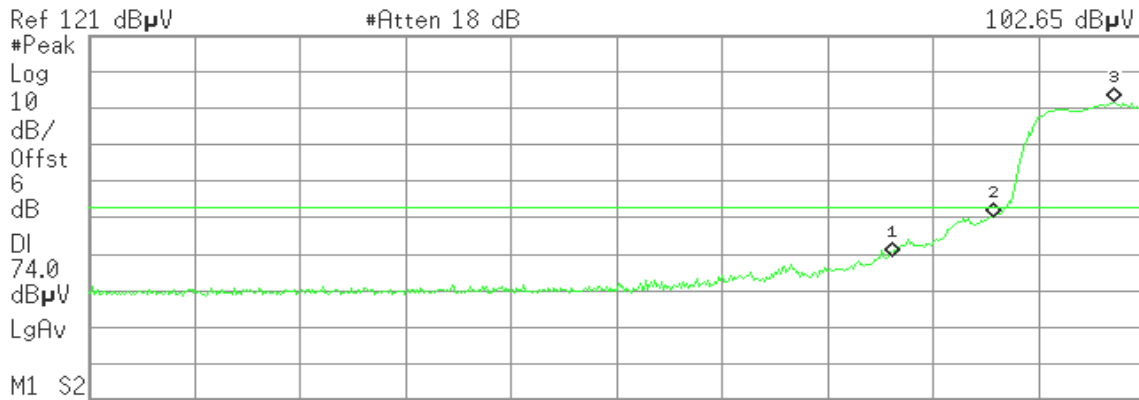

Marker	Trace	Type	X Axis	Amplitude
1	(1)	Freq	2.390 0 GHz	60.49 dBµU
2	(1)	Freq	2.400 0 GHz	71.12 dBµU
3	(1)	Freq	2.412 0 GHz	102.65 dBµU

#Res BW 1 MHz #VBW 1 MHz #Sweep 100 ms (601 pts)

Detector mode: Average

Polarity: Horizontal

Agilent 19:59:44 14 Sep 2011

R T

Mkr3 2.411 2 GHz  
89.58 dBµV

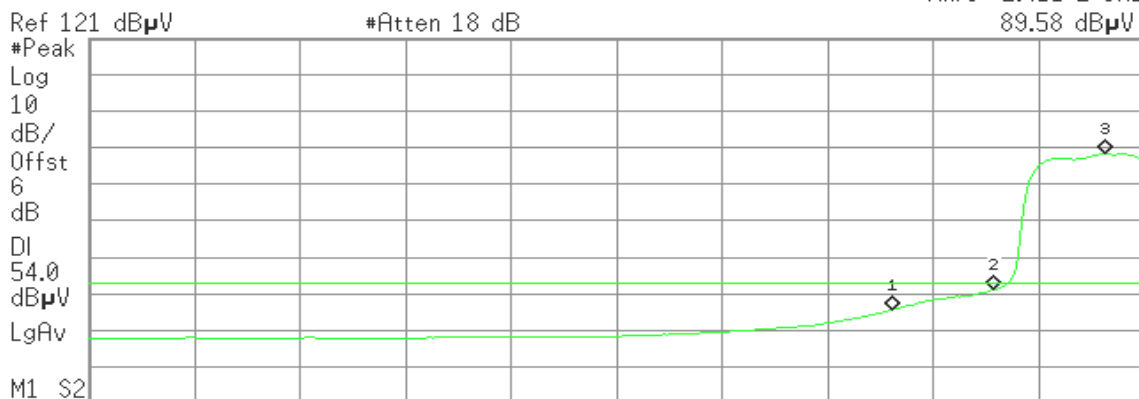

Marker	Trace	Type	X Axis	Amplitude
1	(1)	Freq	2.390 0 GHz	46.58 dBµU
2	(1)	Freq	2.400 0 GHz	52.17 dBµU
3	(1)	Freq	2.411 2 GHz	89.58 dBµU

#Res BW 1 MHz #VBW 10 Hz Sweep 8.187 s (601 pts)



### Band Edges (IEEE 802.11g mode / CH High)

Detector mode: Peak

Polarity: Vertical

Agilent 19:37:36 14 Sep 2011

R T

Mkr1 2.483 50 GHz  
60.38 dB $\mu$ V

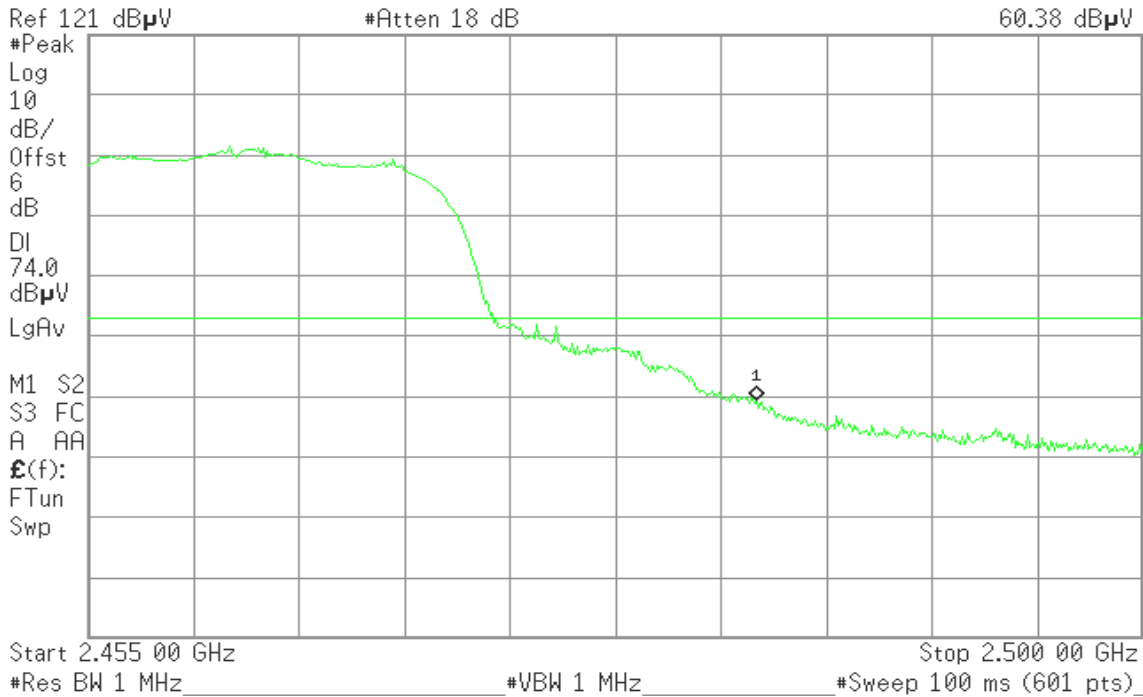

Detector mode: Average

Polarity: Vertical

Agilent 19:37:14 14 Sep 2011

R T

Mkr1 2.483 50 GHz  
45.14 dB $\mu$ V

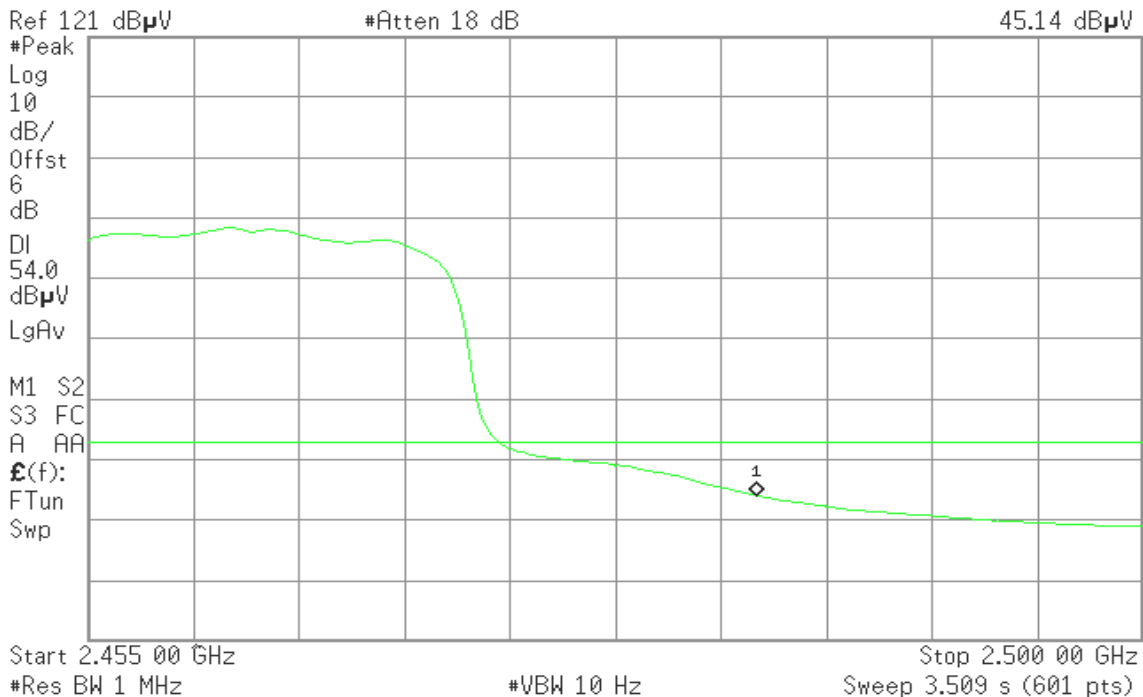



**Detector mode: Peak**

**Polarity: Horizontal**

Agilent 19:39:31 14 Sep 2011

R T

Mkr1 2.483 50 GHz  
59.69 dB $\mu$ V

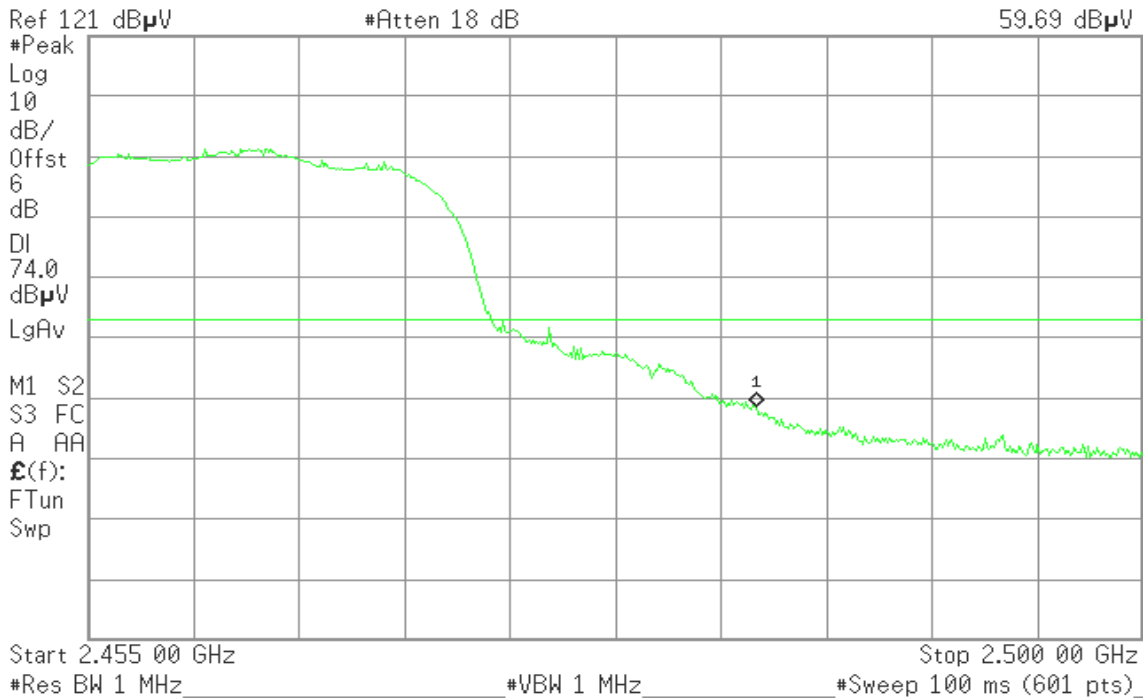

**Detector mode: Average**

**Polarity: Horizontal**

Agilent 19:39:49 14 Sep 2011

R T

Mkr1 2.483 50 GHz  
44.57 dB $\mu$ V

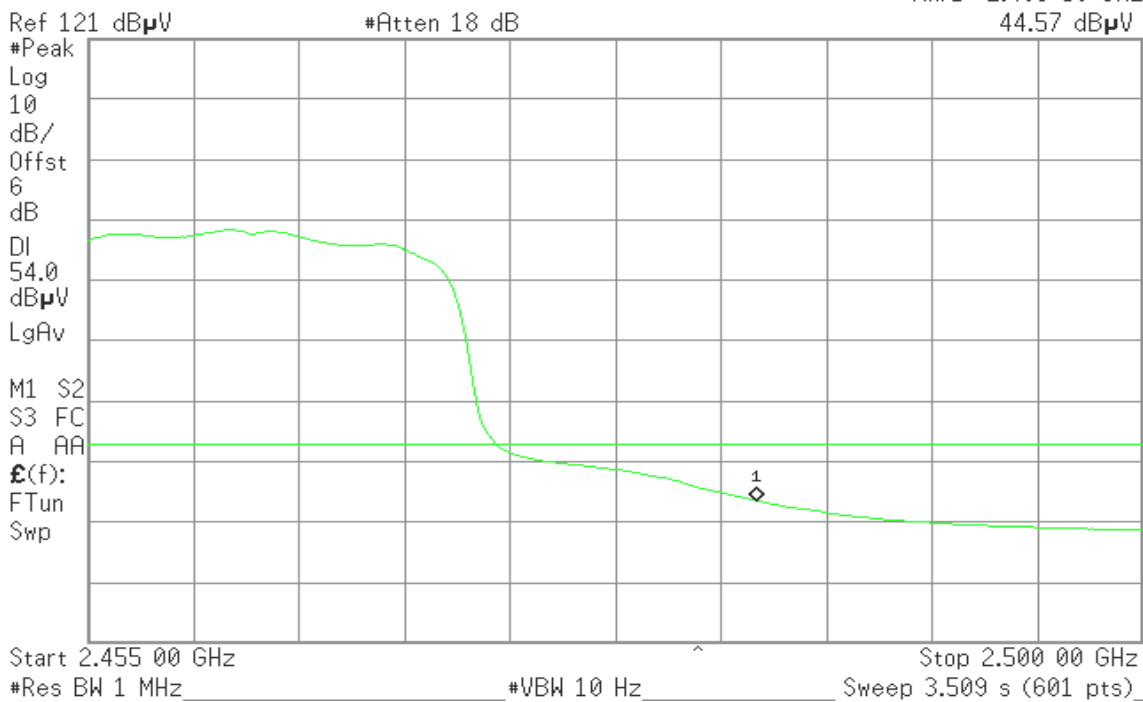



Band Edges (IEEE 802.11n HT 20 MHz mode / CH Low)

Detector mode: Peak

Polarity: Vertical

Agilent 19:51:31 14 Sep 2011

R T

Mkr3 2.411 8 GHz  
102.44 dBµV

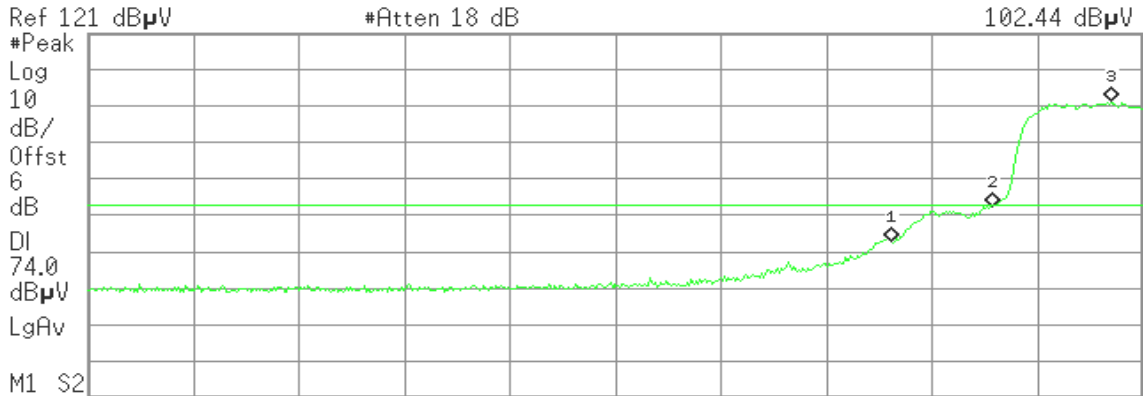

Marker	Trace	Type	X Axis	Amplitude
1	(1)	Freq	2.390 0 GHz	63.79 dBµU
2	(1)	Freq	2.400 0 GHz	73.36 dBµU
3	(1)	Freq	2.411 8 GHz	102.44 dBµU

Detector mode: Average

Polarity: Vertical

Agilent 19:52:07 14 Sep 2011

R T

Mkr3 2.411 5 GHz  
88.60 dBµV

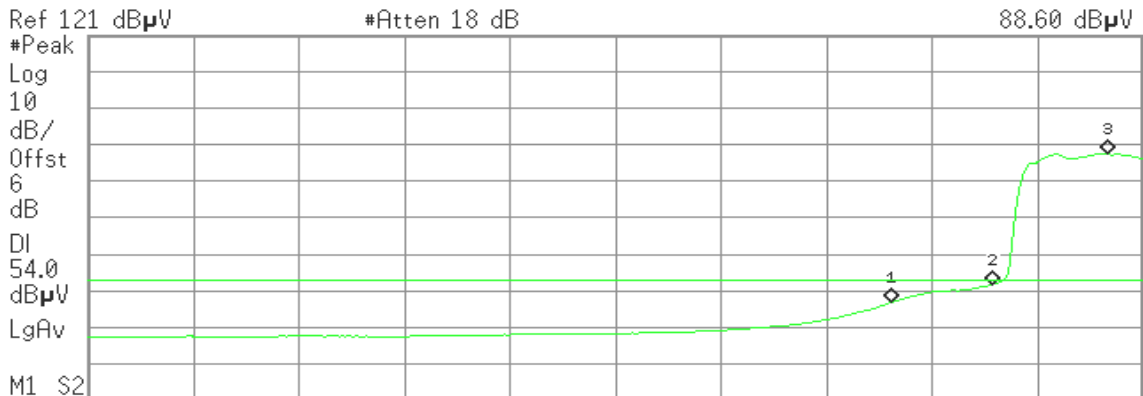

Marker	Trace	Type	X Axis	Amplitude
1	(1)	Freq	2.390 0 GHz	47.77 dBµU
2	(1)	Freq	2.400 0 GHz	52.78 dBµU
3	(1)	Freq	2.411 5 GHz	88.60 dBµU



Detector mode: Peak

Polarity: Horizontal

Agilent 19:57:10 14 Sep 2011

R T

Mkr3 2.411 5 GHz  
102.22 dBµV

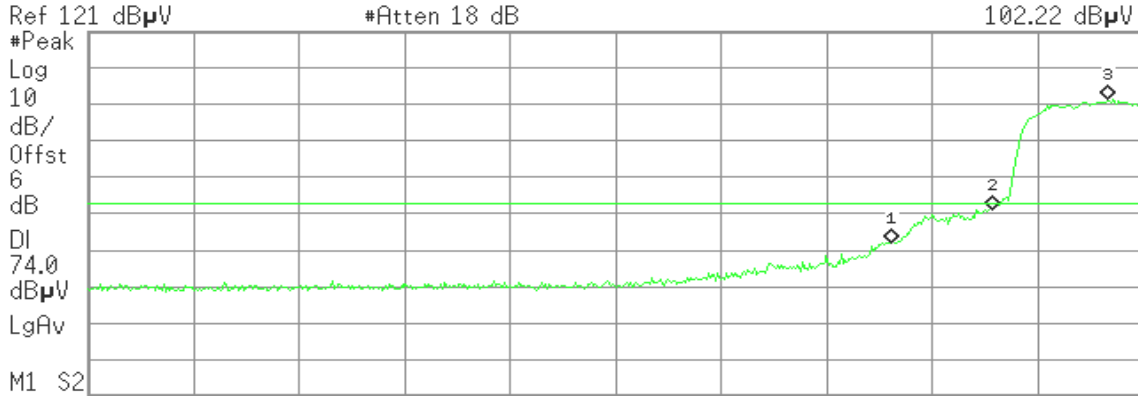

Start 2.310 0 GHz Stop 2.415 0 GHz  
#Res BW 1 MHz #VBW 1 MHz #Sweep 100 ms (601 pts)

Marker	Trace	Type	X Axis	Amplitude
1	(1)	Freq	2.390 0 GHz	62.84 dBµU
2	(1)	Freq	2.400 0 GHz	72.19 dBµU
3	(1)	Freq	2.411 5 GHz	102.22 dBµU

Detector mode: Average

Polarity: Horizontal

Agilent 19:57:37 14 Sep 2011

R T

Mkr3 2.411 5 GHz  
88.84 dBµV

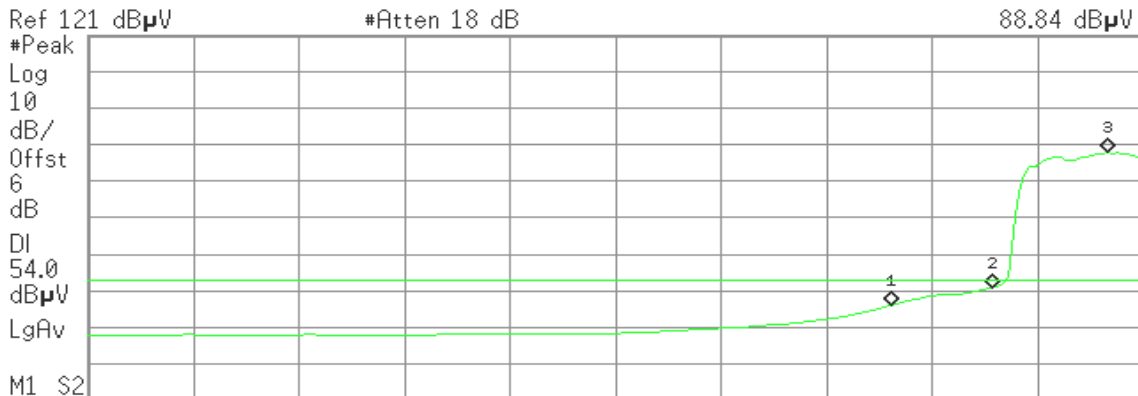

Start 2.310 0 GHz Stop 2.415 0 GHz  
#Res BW 1 MHz #VBW 10 Hz Sweep 8.187 s (601 pts)

Marker	Trace	Type	X Axis	Amplitude
1	(1)	Freq	2.390 0 GHz	47.05 dBµU
2	(1)	Freq	2.400 0 GHz	51.87 dBµU
3	(1)	Freq	2.411 5 GHz	88.84 dBµU



### Band Edges (IEEE 802.11n HT 20 MHz mode / CH High)

Detector mode: Peak

Polarity: Vertical

Agilent 19:44:27 14 Sep 2011

R T

Mkr1 2.483 50 GHz  
60.70 dB $\mu$ V

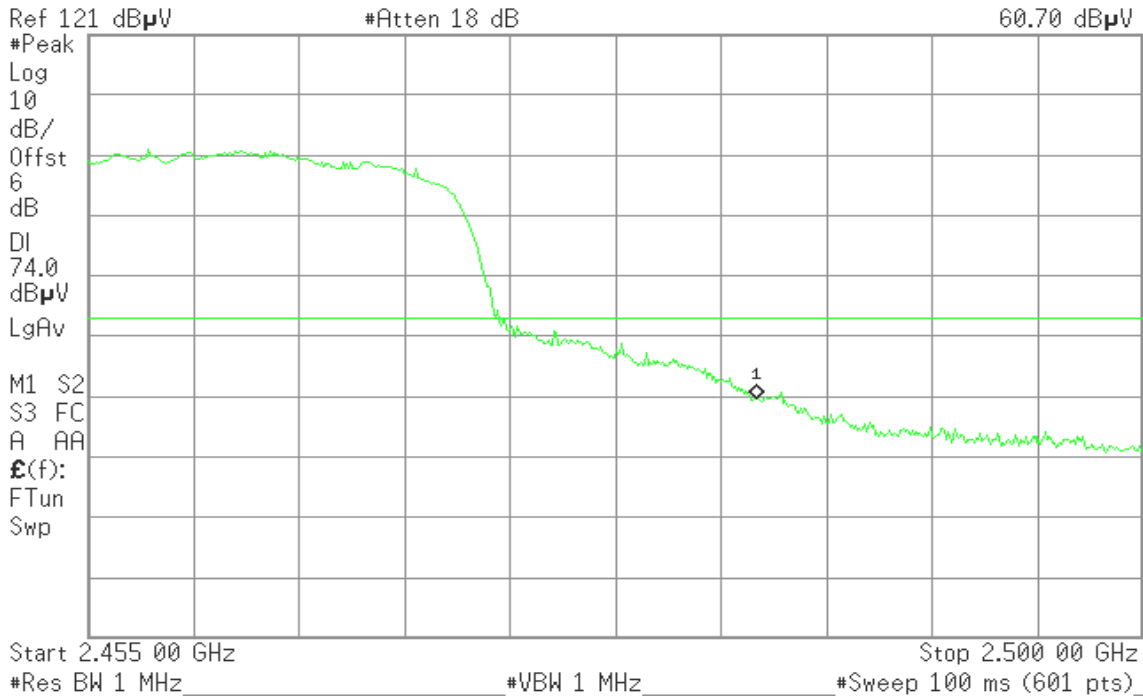

Detector mode: Average

Polarity: Vertical

Agilent 19:44:01 14 Sep 2011

R T

Mkr1 2.483 50 GHz  
45.28 dB $\mu$ V

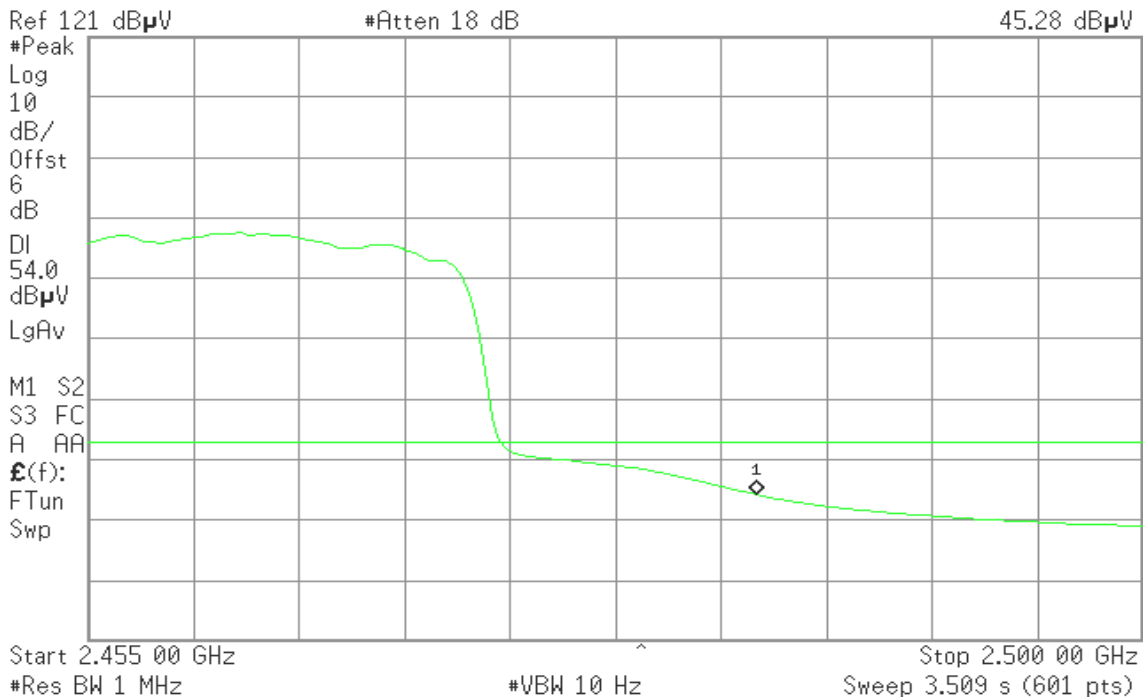





**Detector mode: Peak**

**Polarity: Horizontal**

Agilent 19:42:40 14 Sep 2011

R T

Mkr1 2.483 50 GHz  
60.29 dB $\mu$ V

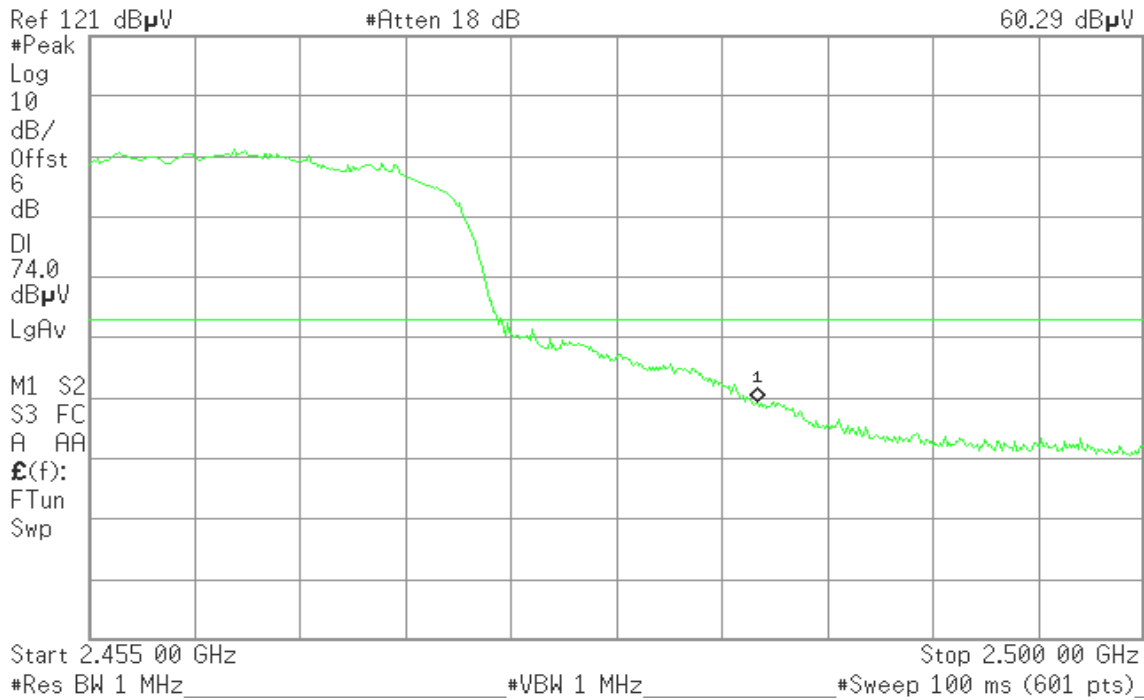

**Detector mode: Average**

**Polarity: Horizontal**

Agilent 19:43:01 14 Sep 2011

R T

Mkr1 2.483 50 GHz  
44.73 dB $\mu$ V

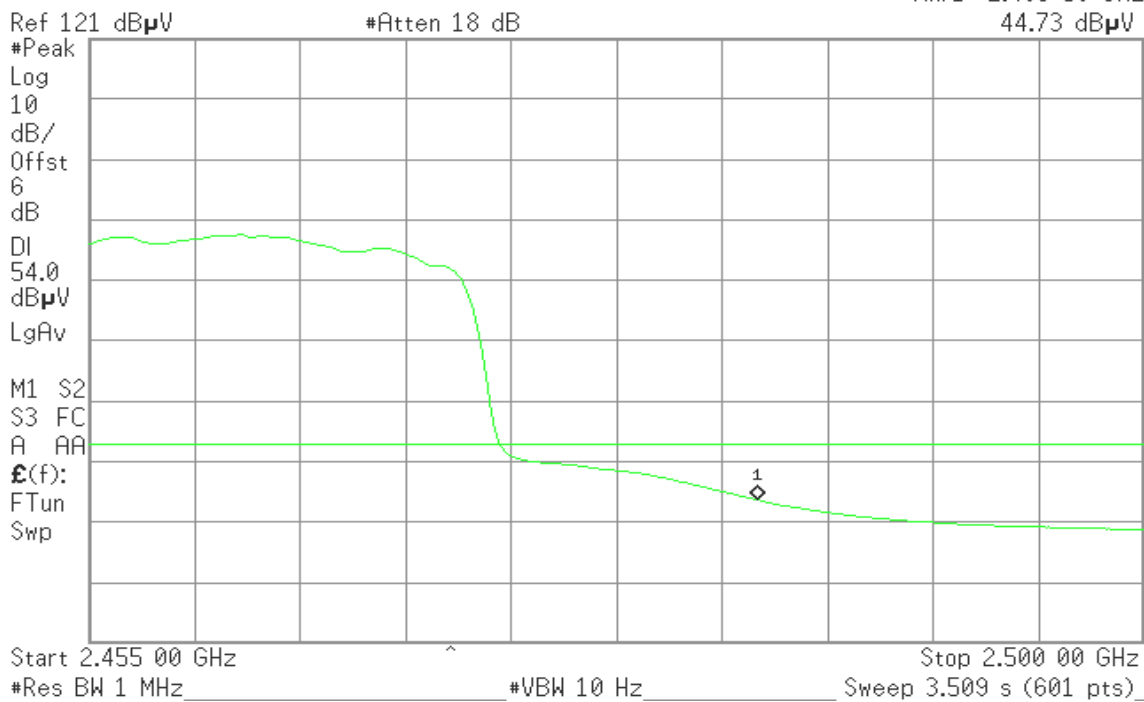



## **8.6 PEAK POWER SPECTRAL DENSITY**

### **LIMIT**

1. According to §15.247(e) & RSS-210 §A8.2, for digitally modulated systems, the power spectral density conducted from the intentional radiator to the antenna shall not be greater than 8 dBm in any 3 kHz band during any time interval of continuous transmission.
2. According to §15.247(f) & RSS-210 §A8.3, the digital modulation operation of the hybrid system, with the frequency hopping turned off, shall comply with the power density requirements of paragraph (d) of this section.

### **Test Configuration**

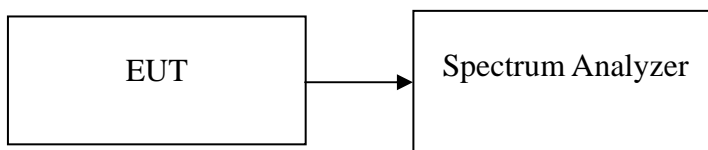

### **TEST PROCEDURE**

1. Place the EUT on the table and set it in transmitting mode.  
Remove the antenna from the EUT and then connect a low loss RF cable from the antenna port to the spectrum analyzer.
2. Set the spectrum analyzer as RBW = 3 kHz, VBW = 10 kHz, Span = 300 kHz,  
Sweep time = 100000ms.
3. Record the max reading.
4. Repeat the above procedure until the measurements for all frequencies are completed.

### **TEST RESULTS**

*No non-compliance noted*



**Test Data**

**Test mode: IEEE 802.11b mode**

Channel	Frequency (MHz)	PPSD (dBm)	Limit (dBm)	Result
Low	2412	2.79	8.00	PASS
Mid	2442	2.32		PASS
High	2462	1.55		PASS

**Test mode: IEEE 802.11g mode**

Channel	Frequency (MHz)	PPSD (dBm)	Limit (dBm)	Result
Low	2412	-12.37	8.00	PASS
Mid	2442	-11.86		PASS
High	2462	-12.67		PASS

**Test mode: IEEE 802.11n HT 20 MHz Channel mode**

Channel	Frequency (MHz)	PPSD (dBm)	Limit (dBm)	Result
Low	2412	-12.81	8.00	PASS
Mid	2442	-12.95		PASS
High	2462	-12.89		PASS



**Test Plot**

IEEE 802.11b mode

PPSD (CH Low)

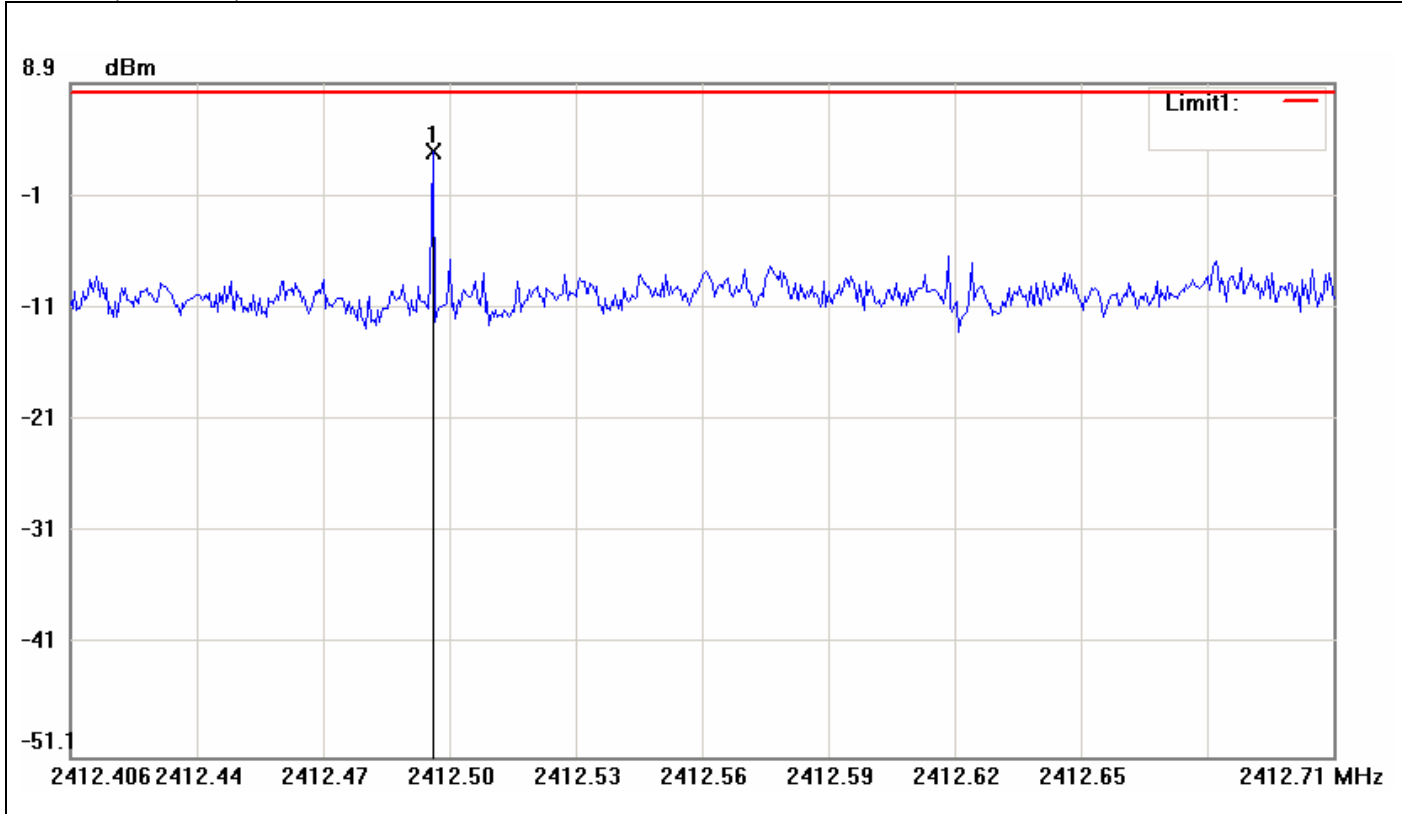

No.	Frequency(MHz)	Level(dBm)	Limit(dBm)	Margin(dBm)
1	2412.4920	2.79	8.00	-5.21



PPSD (CH Mid)

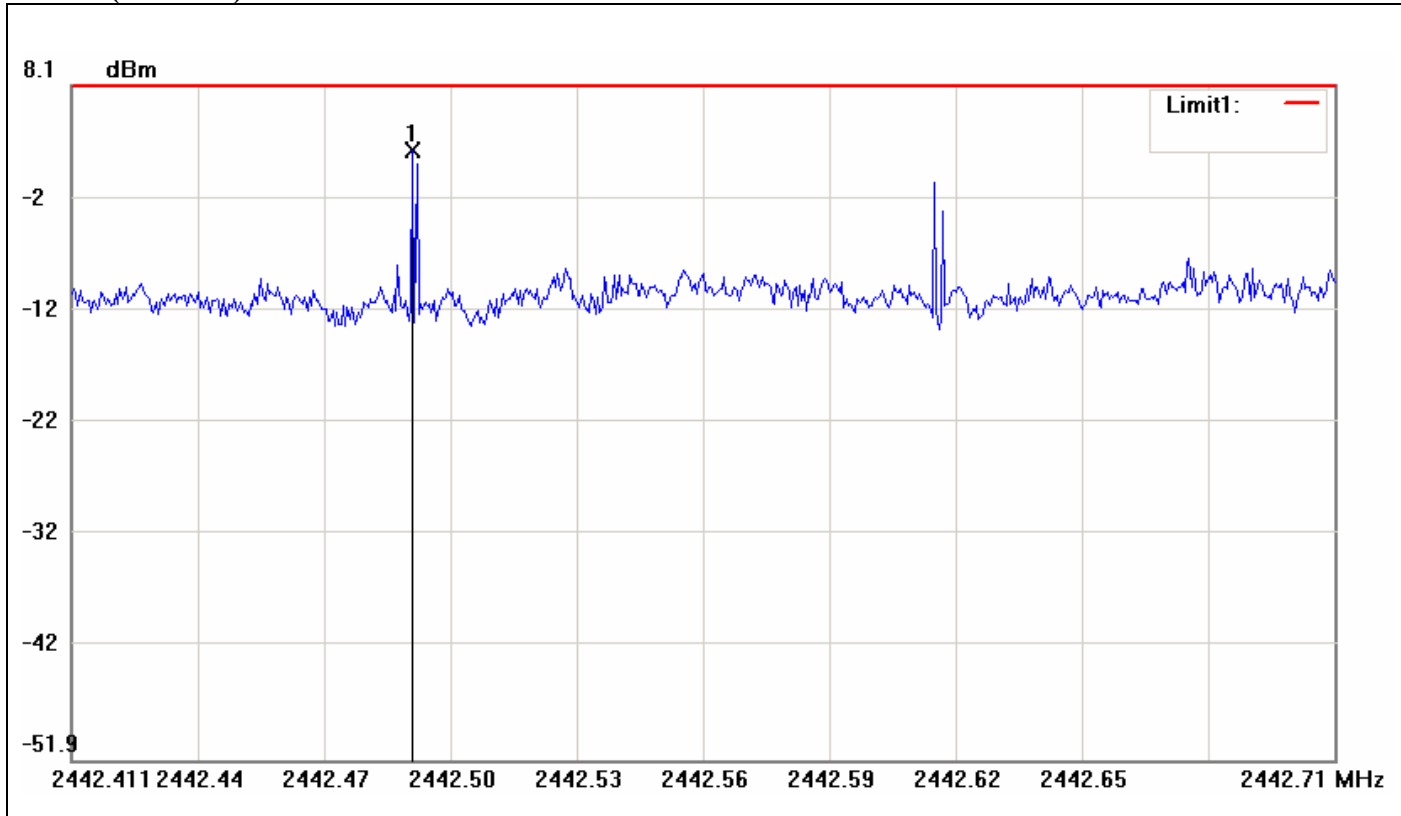

No.	Frequency(MHz)	Level(dBm)	Limit(dBm)	Margin(dBm)
1	2442.4923	2.32	8.00	-5.68



PPSD (CH High)

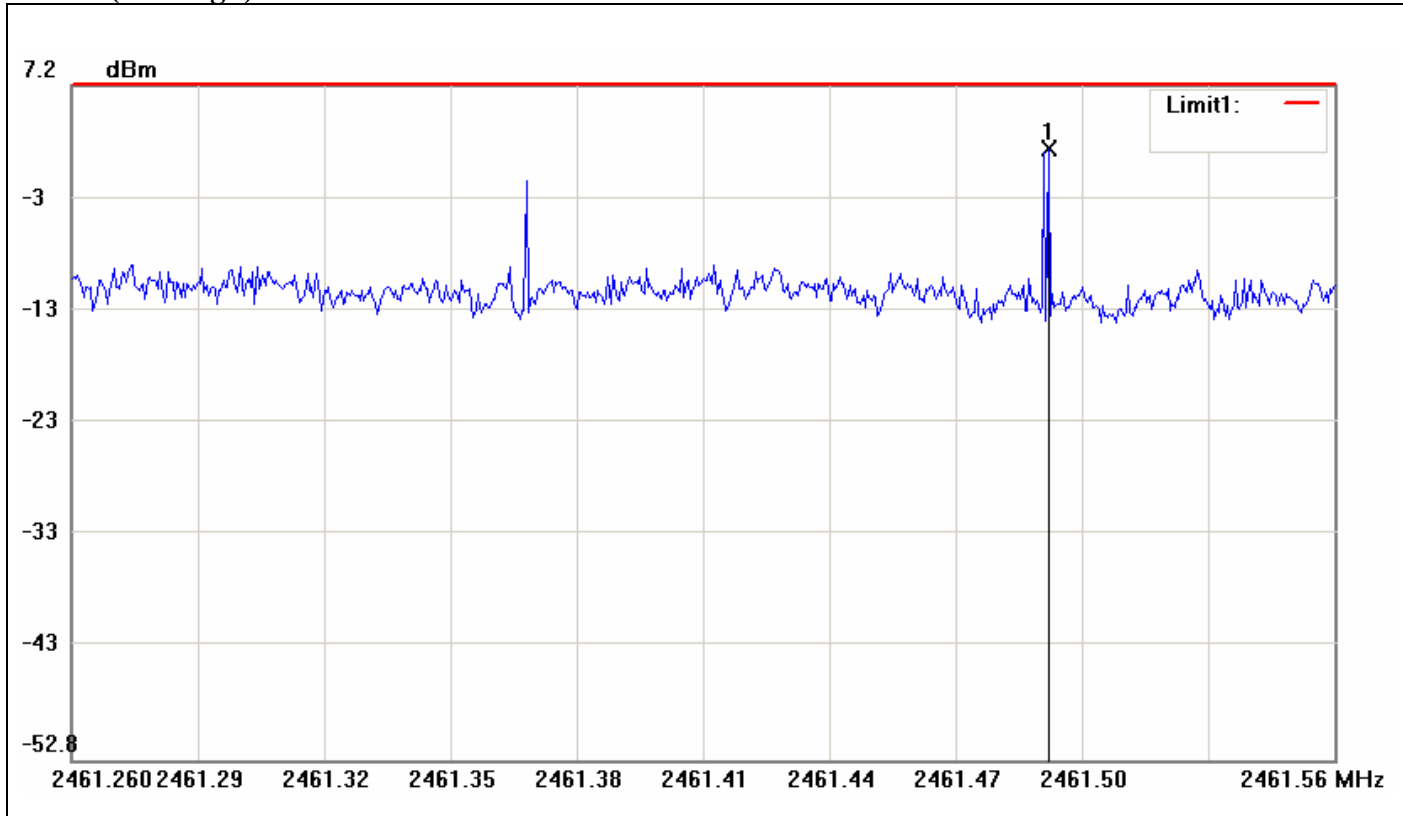

No.	Frequency(MHz)	Level(dBm)	Limit(dBm)	Margin(dBm)
1	2461.4922	1.55	8.00	-6.45



IEEE 802.11g mode

PPSD (CH Low)

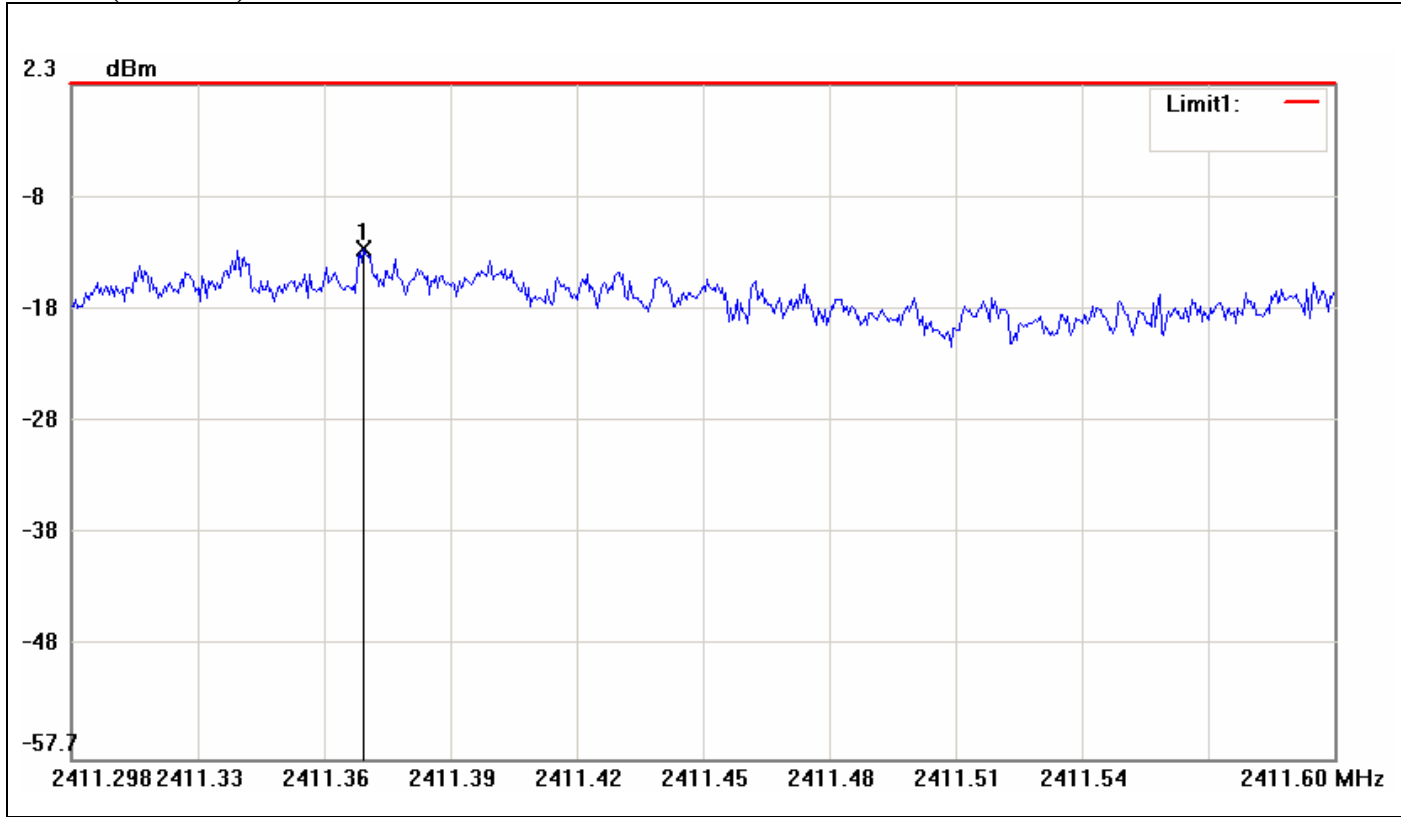

No.	Frequency(MHz)	Level(dBm)	Limit(dBm)	Margin(dBm)
1	2411.3674	-12.37	8.00	-20.37



PPSD (CH Mid)

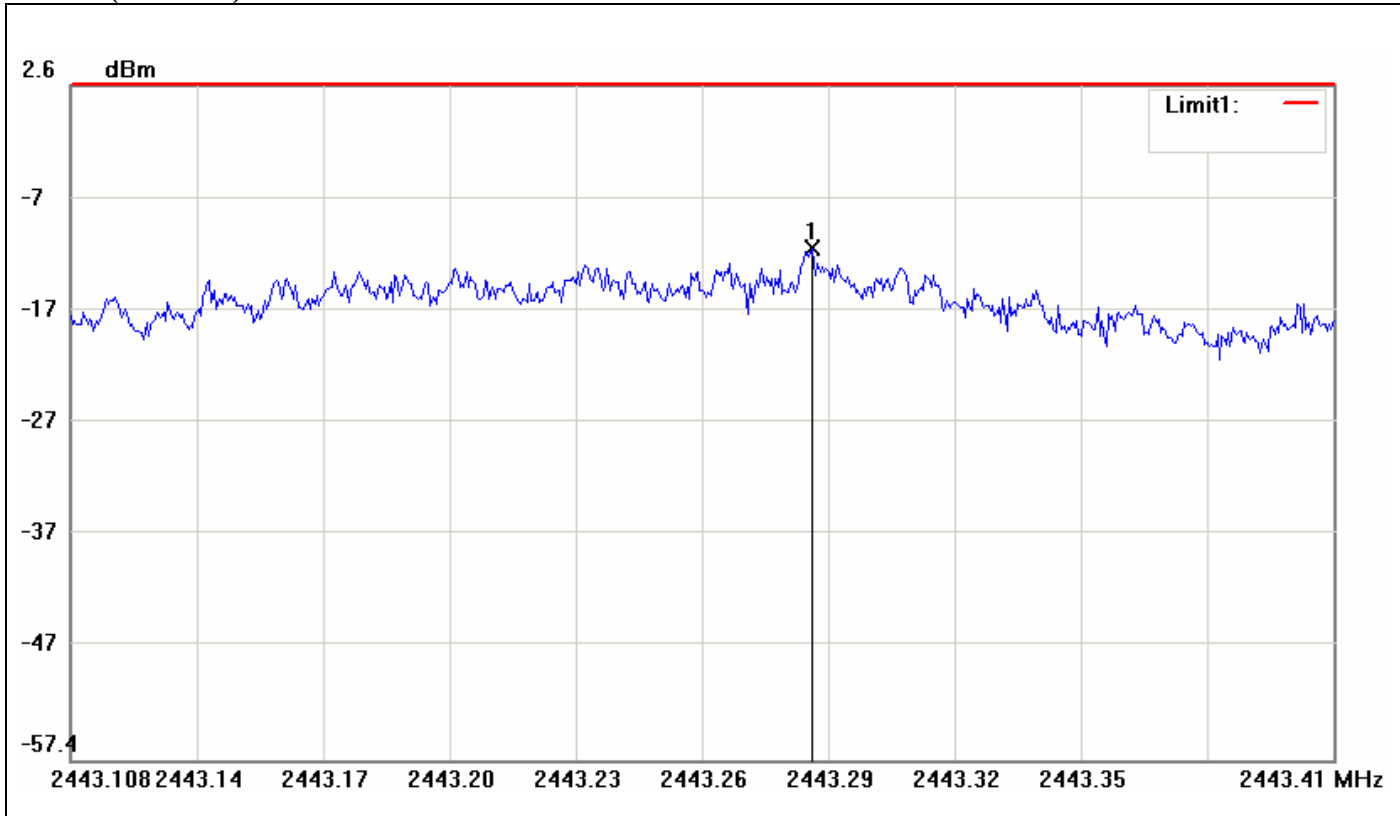

No.	Frequency(MHz)	Level(dBm)	Limit(dBm)	Margin(dBm)
1	2443.2844	-11.86	8.00	-19.86





### PPSD (CH High)

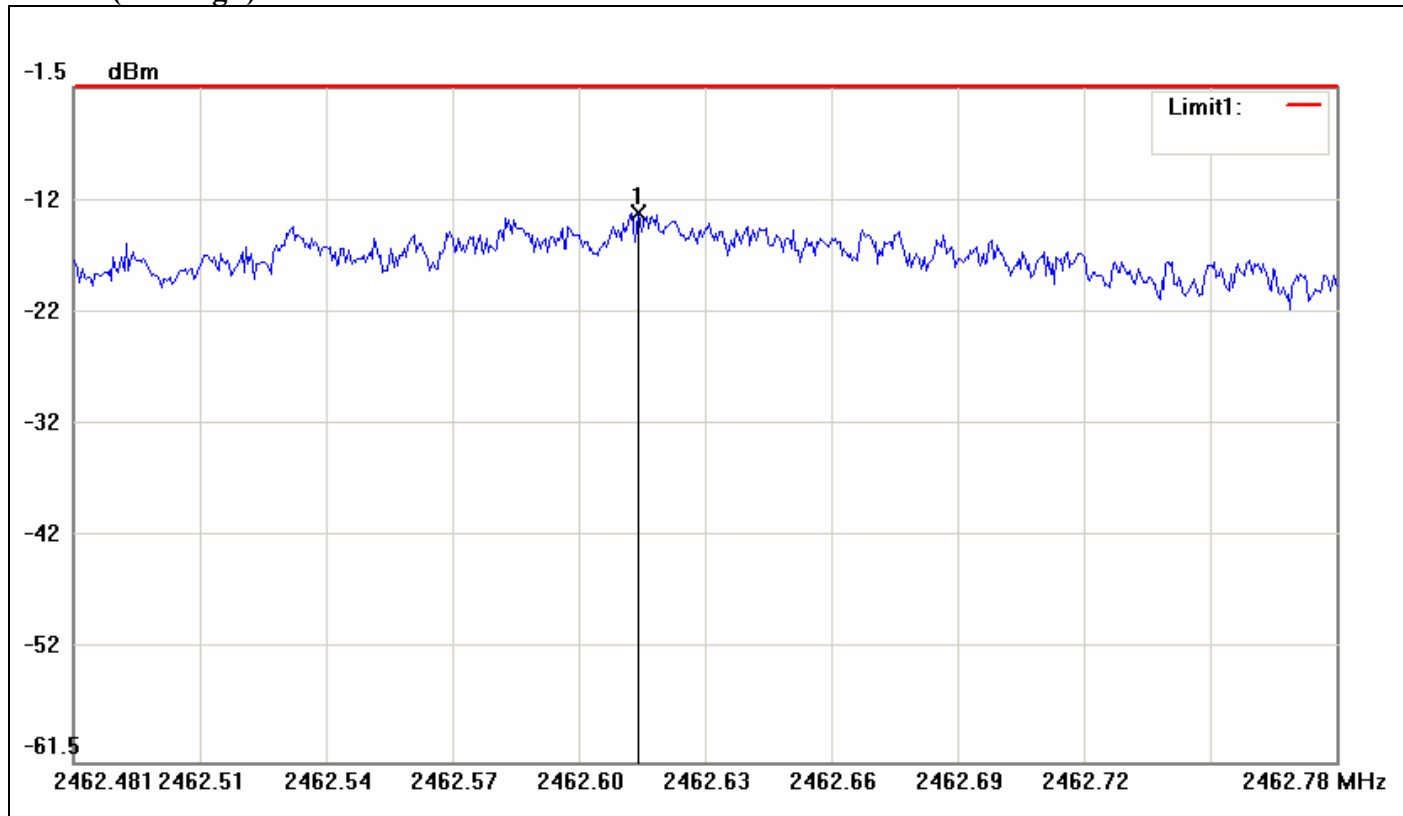

No.	Frequency(MHz)	Level(dBm)	Limit(dBm)	Margin(dBm)
1	2462.6152	-12.67	8.00	-20.67



### IEEE 802.11n HT 20 MHz Channel mode

#### PPSD (CH Low)

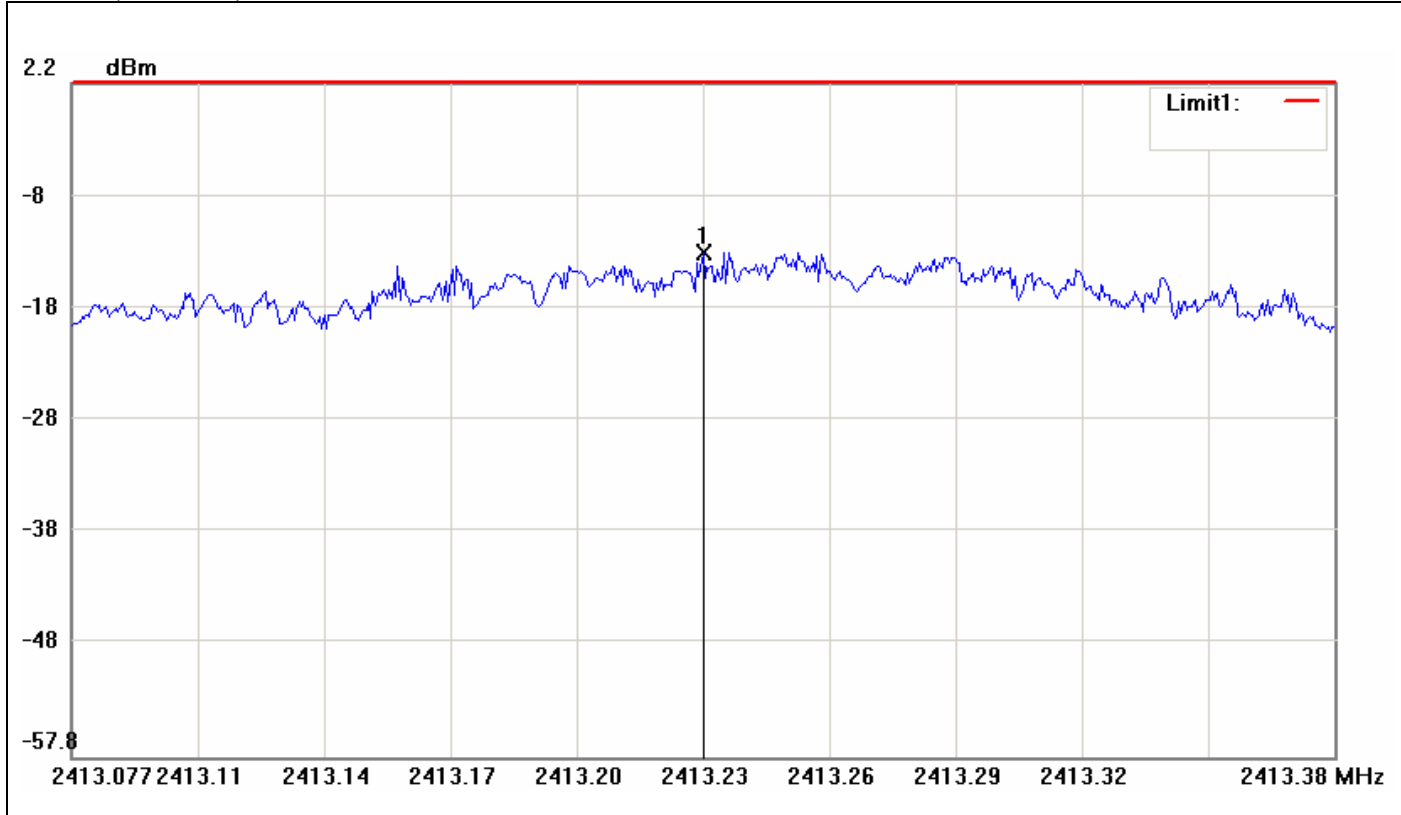

No.	Frequency(MHz)	Level(dBm)	Limit(dBm)	Margin(dBm)
1	2413.2274	-12.81	8.00	-20.81



PPSD (CH Mid)

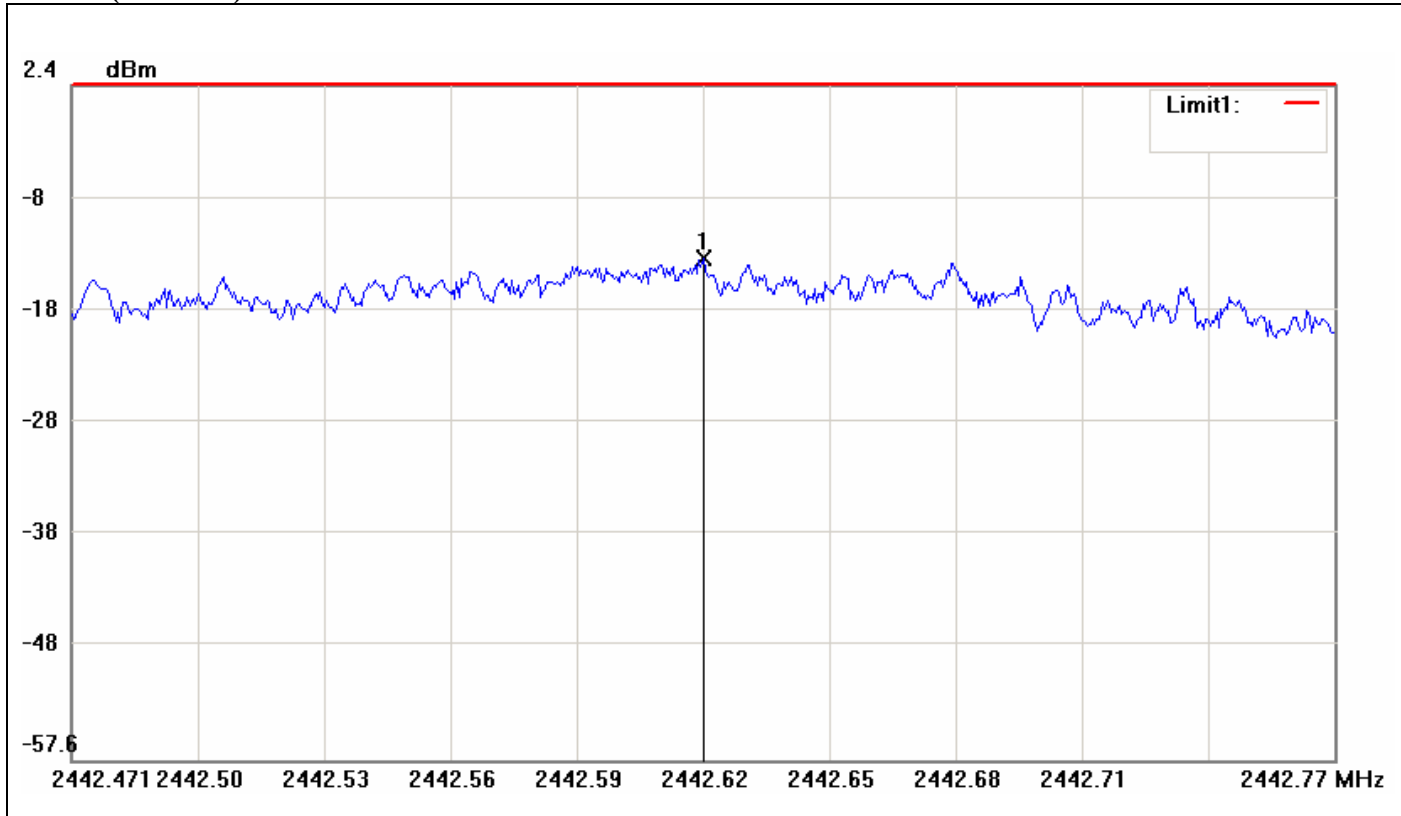

No.	Frequency(MHz)	Level(dBm)	Limit(dBm)	Margin(dBm)
1	2442.6212	-12.95	8.00	-20.95



### PPSD (CH High)

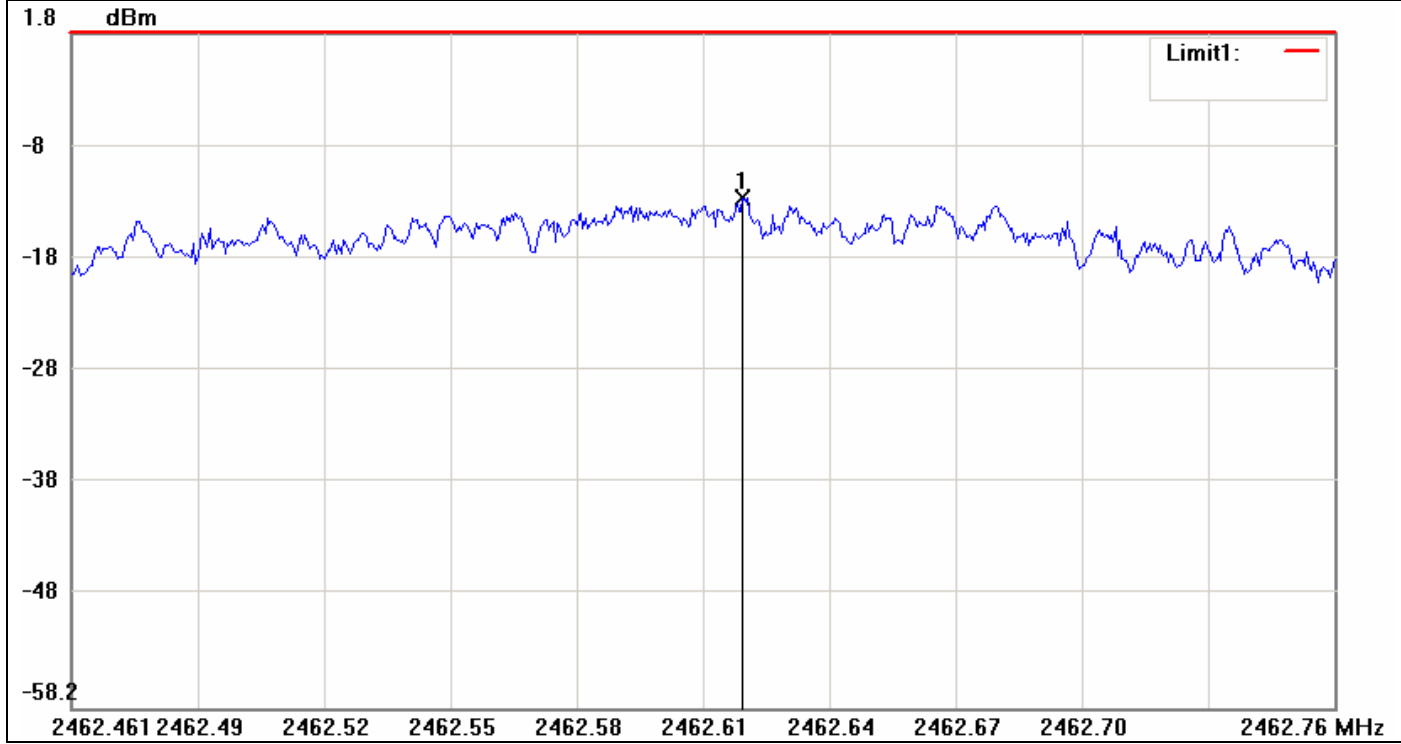

No.	Frequency(MHz)	Level(dBm)	Limit(dBm)	Margin(dBm)
1	2462.6203	-12.89	8.00	-20.89



## 8.7 SPURIOUS EMISSIONS

### 8.7.1 Conducted Measurement

#### LIMIT

According to §15.247(d) & RSS-210 §A8.5, in any 100 kHz bandwidth outside the frequency bands in which the spread spectrum intentional radiator is operating, the radio frequency power that is produced by the intentional radiator shall be at least 20 dB below that in the 100 kHz bandwidth within the band that contains the highest level of the desired power, based on either an RF conducted or a radiated measurement, provided the transmitter demonstrates compliance with the peak conducted power limits. In addition, radiated emissions which fall in the restricted bands, as defined in §15.205(a), must also comply with the radiated emission limits specified in 15.209(a) (see Section 15.205(c)).

#### Test Configuration

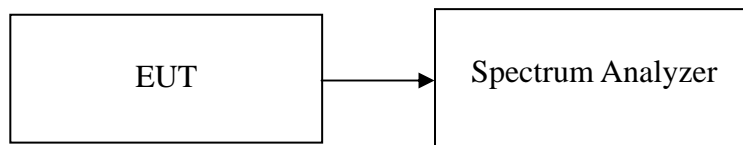

#### TEST PROCEDURE

Conducted RF measurements of the transmitter output were made to confirm that the EUT antenna port conducted emissions meet the specified limit and to identify any spurious signals that require further investigation or measurements on the radiated emissions site.

The transmitter output is connected to the spectrum analyzer. The resolution bandwidth is set to 100 kHz. The video bandwidth is set to 100 kHz.

Measurements are made over the 30MHz to 26GHz range with the transmitter set to the lowest, middle, and highest channels.

#### TEST RESULTS

*No non-compliance noted*



**Test Plot**

**IEEE 802.11b mode**

**CH Low**

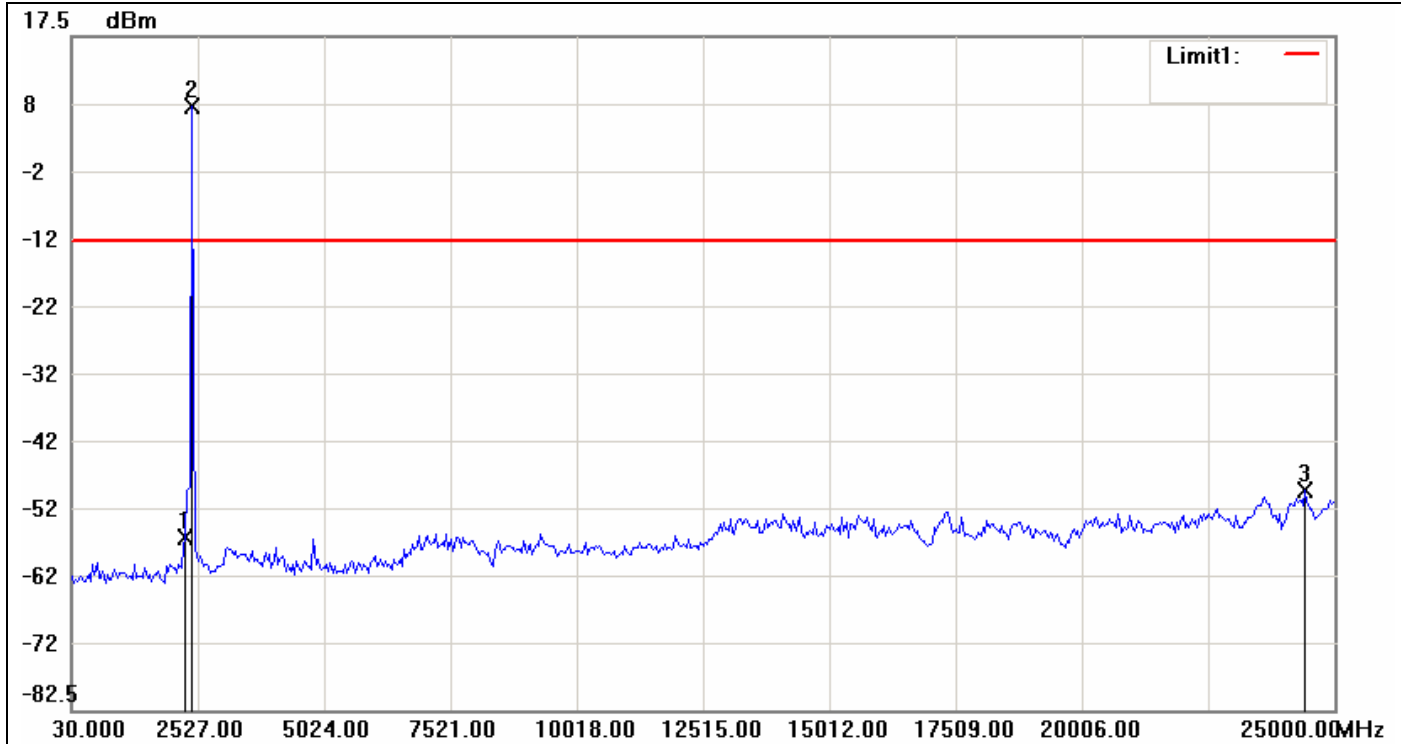

No.	Frequency(MHz)	Level(dBm)	Limit(dBm)	Margin(dBm)
1	2277.3000	-56.89	-12.82	-44.07
2	2402.1500	7.18	-12.82	20.00
3	24417.3667	-49.94	-12.82	-37.12



CH Mid



No.	Frequency(MHz)	Level(dBm)	Limit(dBm)	Margin(dBm)
1	2277.3000	-57.81	-12.88	-44.93
2	2443.7667	7.12	-12.88	20.00
3	24250.9000	-50.90	-12.88	-38.02



CH High

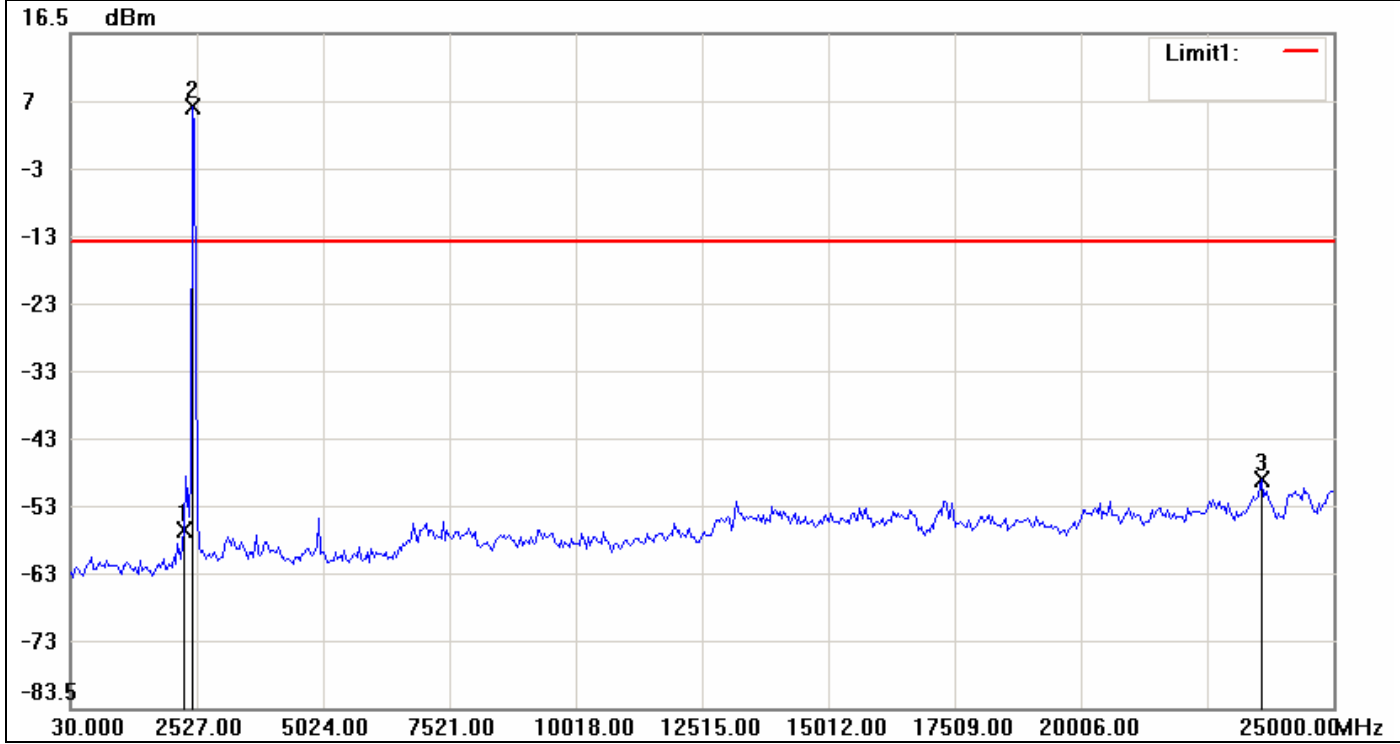

No.	Frequency(MHz)	Level(dBm)	Limit(dBm)	Margin(dBm)
1	2277.3000	-57.12	-14.29	-42.83
2	2443.7667	5.71	-14.29	20.00
3	23585.0333	-49.73	-14.29	-35.44





### IEEE 802.11g mode

#### CH Low

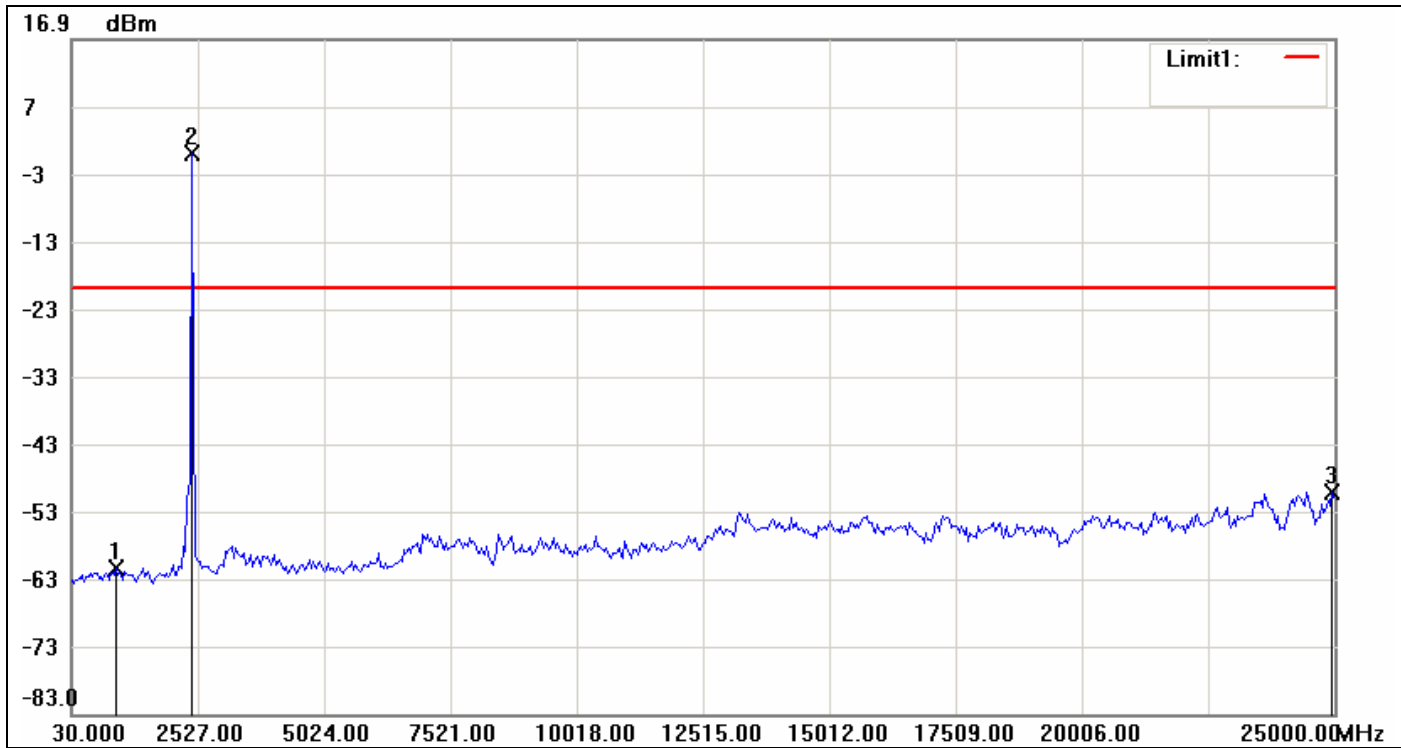

No.	Frequency(MHz)	Level(dBm)	Limit(dBm)	Margin(dBm)
1	903.9500	-61.36	-19.97	-41.39
2	2402.1500	0.03	-19.97	20.00
3	24958.3833	-50.09	-19.97	-30.12



CH Mid

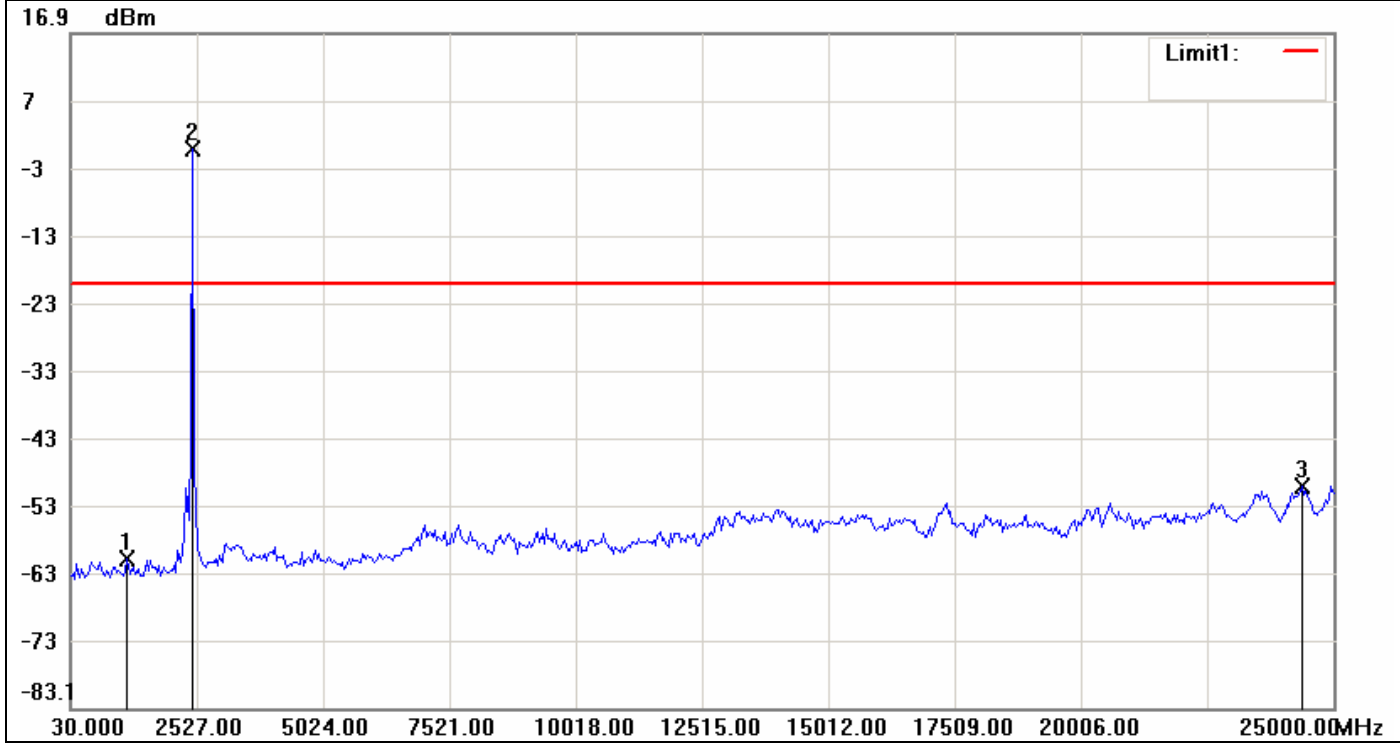

No.	Frequency(MHz)	Level(dBm)	Limit(dBm)	Margin(dBm)
1	1153.6500	-61.06	-20.19	-40.87
2	2443.7667	-0.19	-20.19	20.00
3	24375.7500	-50.24	-20.19	-30.05



CH High



No.	Frequency(MHz)	Level(dBm)	Limit(dBm)	Margin(dBm)
1	1444.9667	-61.39	-20.70	-40.69
2	2443.7667	-0.70	-20.70	20.00
3	24417.3667	-49.84	-20.70	-29.14



### IEEE 802.11n HT 20 MHz Channel mode

#### CH Low

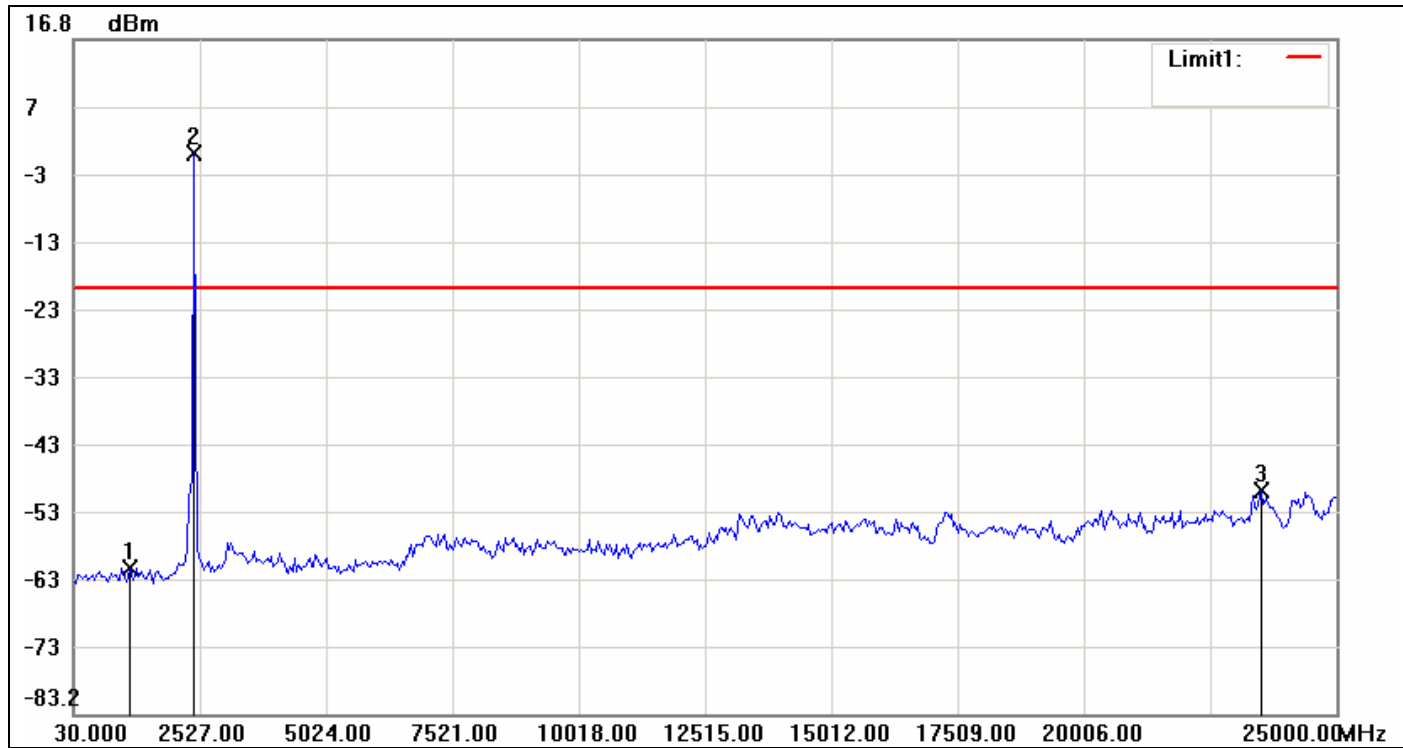

No.	Frequency(MHz)	Level(dBm)	Limit(dBm)	Margin(dBm)
1	1153.6500	-61.49	-20.04	-41.45
2	2402.1500	-0.04	-20.04	20.00
3	23501.8000	-50.08	-20.04	-30.04



CH Mid

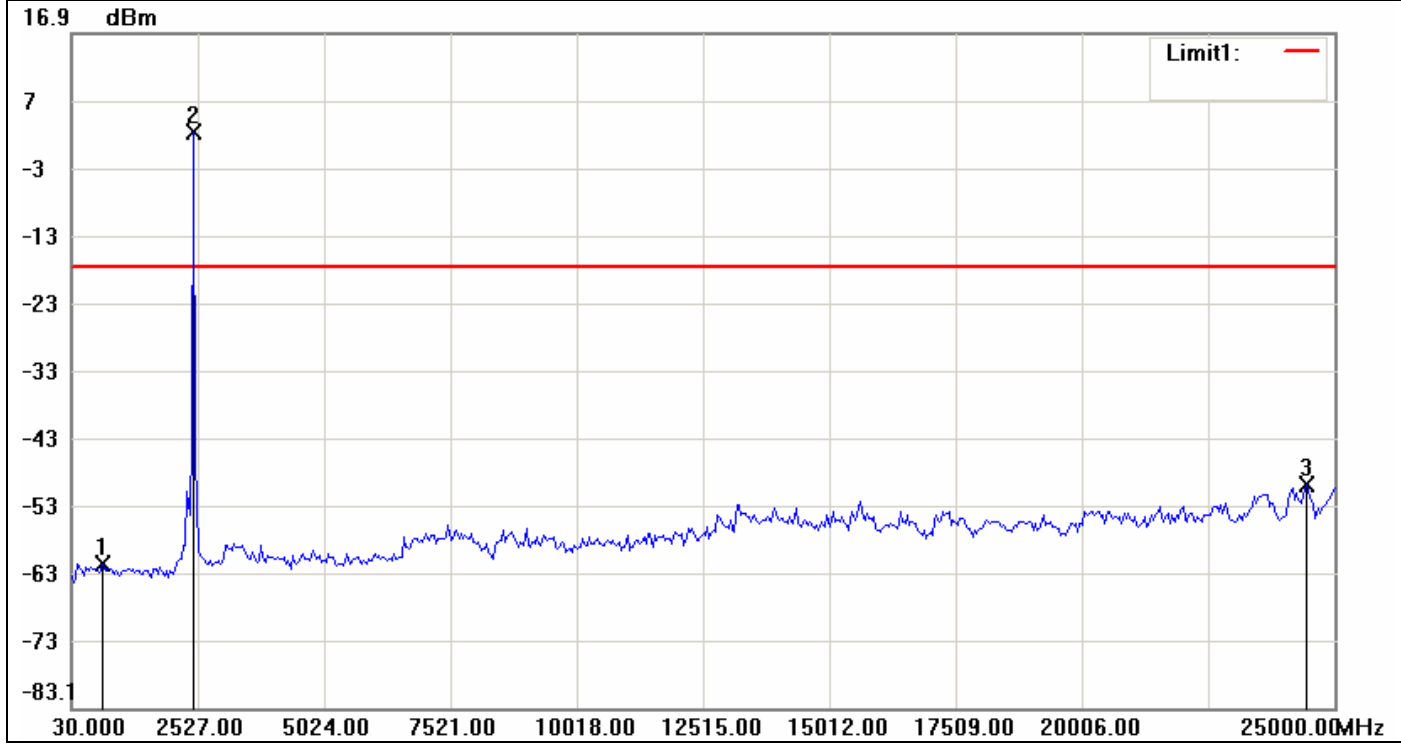

No.	Frequency(MHz)	Level(dBm)	Limit(dBm)	Margin(dBm)
1	654.2500	-61.71	-17.86	-43.85
2	2443.7667	2.14	-17.86	20.00
3	24458.9833	-50.05	-17.86	-32.19



### CH High



No.	Frequency(MHz)	Level(dBm)	Limit(dBm)	Margin(dBm)
1	529.4000	-60.80	-18.52	-42.28
2	2443.7667	1.48	-18.52	20.00
3	24958.3833	-50.56	-18.52	-32.04



## 8.8 RADIATED EMISSIONS

### LIMIT

All spurious emissions shall comply with the limits of §15.209(a) and RSS-Gen Table 2 & Table 5.

#### **RSS-Gen Table 2 & Table 5: General Field Strength Limits for Transmitters and Receivers at Frequencies Above 30 MHz** <sup>(Note)</sup>

Frequency (MHz)	Field Strength microvolts/m at 3 metres (watts, e.i.r.p.)	
	Transmitters	Receivers
30-88	100 (3 nW)	100 (3 nW)
88-216	150 (6.8 nW)	150 (6.8 nW)
216-960	200 (12 nW)	200 (12 nW)
Above 960	500 (75 nW)	500 (75 nW)

**Note:** \*Measurements for compliance with limits in the above table may be performed at distances other than 3 metres, in accordance with Section 7.2.7.

Transmitting devices are not permitted in Table 1 bands or, unless stated otherwise, in TV bands (54-72 MHz, 76-88 MHz, 174-216 MHz, 470-608 MHz and 614-806 MHz).

#### **RSS-Gen Table 6: General Field Strength Limits for Transmitters at Frequencies Below 30 MHz (Transmit)**

Frequency	Field Strength (microvolts/m)	Magnetic H-Field (microamperes/m)	Measurement Distance (metres)
9-490 kHz	2,400/F (F in kHz)	2,400/377F (F in kHz)	3000
490-1,705 kHz	24,000/F (F in kHz)	24,000/377F (F in kHz)	30
1.705-30 MHz	30	N/A	30

**Note:** The emission limits for the bands 9-90 kHz and 110-490 kHz are based on measurements employing an average detector.



### Test Configuration

#### 9kHz ~ 30MHz

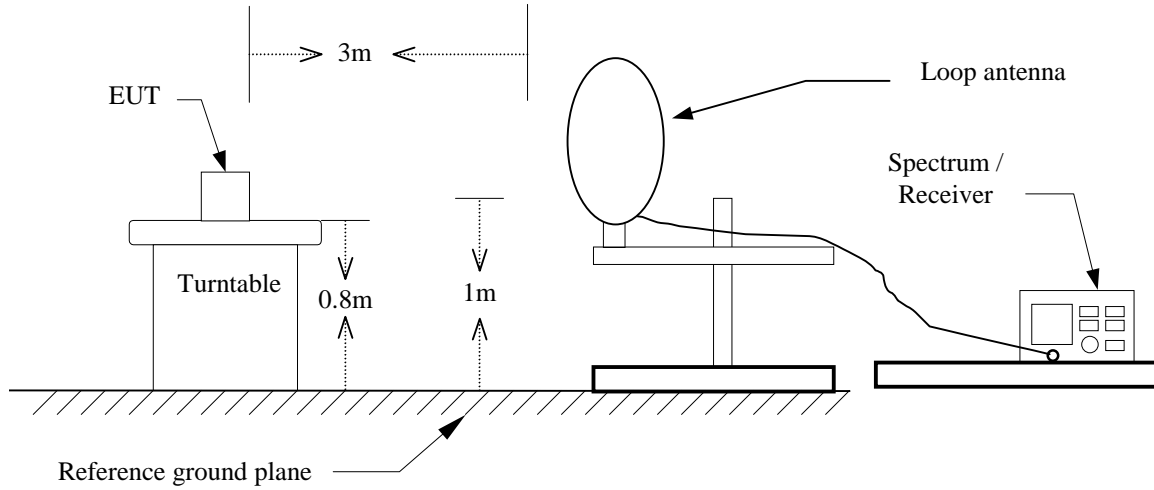

#### 30MHz ~ 1GHz

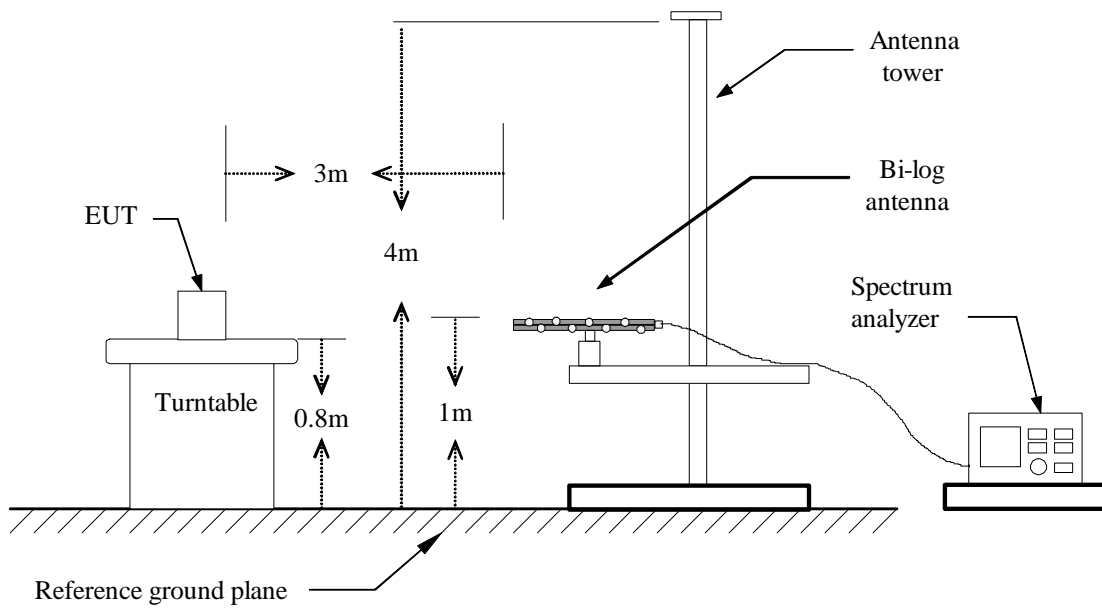





Above 1 GHz

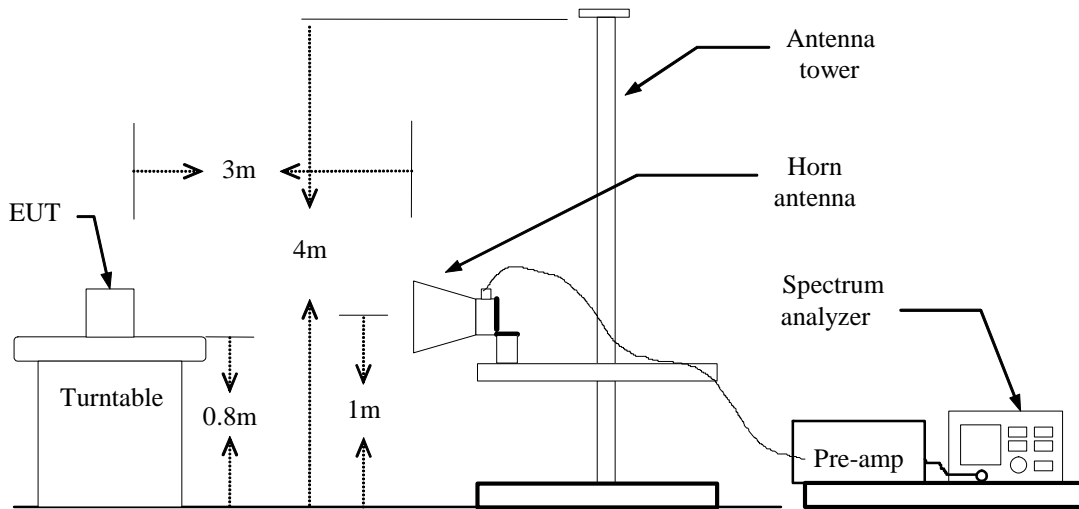



## **TEST PROCEDURE**

1. The EUT is placed on a turntable, which is 0.8m above ground plane.
2. The turntable shall be rotated for 360 degrees to determine the position of maximum emission level.
3. EUT is set 3m away from the receiving antenna, which is varied from 1m to 4m to find out the highest emissions.
4. Maximum procedure was performed on the six highest emissions to ensure EUT compliance.
5. And also, each emission was to be maximized by changing the polarization of receiving antenna both horizontal and vertical.
6. Set the spectrum analyzer in the following setting as:  
Below 1GHz:  
RBW=100kHz / VBW=300kHz / Sweep=AUTO  
Above 1GHz:  
(a) PEAK: RBW=VBW=1MHz / Sweep=AUTO  
(b) AVERAGE: RBW=1MHz / VBW=10Hz / Sweep=AUTO
7. Repeat above procedures until the measurements for all frequencies are complete.

**Below 1GHz****Operation Mode:** Normal Link**Test Date:** September 14, 2011**Temperature:** 23°C**Tested by:** Wolf Huang**Humidity:** 56% RH**Polarity:** Ver. / Hor.

Frequency (MHz)	Reading (dBuV)	Correction Factor (dB/m)	Result (dBuV/m)	Limit (dBuV/m)	Margin (dB)	Remark	Ant. Pol. (H/V)
99.52	43.47	-13.16	30.32	43.50	-13.18	Peak	V
299.98	44.15	-9.24	34.91	46.00	-11.09	Peak	V
359.80	45.22	-7.86	37.36	46.00	-8.64	Peak	V
372.73	41.31	-7.61	33.70	46.00	-12.30	Peak	V
479.43	36.75	-5.44	31.31	46.00	-14.69	Peak	V
964.43	37.06	0.51	37.57	54.00	-16.43	Peak	V
99.52	47.68	-13.16	34.53	43.50	-8.97	Peak	H
240.17	53.08	-11.09	41.99	46.00	-4.01	Peak	H
299.98	52.77	-9.24	43.53	46.00	-2.47	QP	H
359.80	52.42	-7.86	44.56	46.00	-1.44	QP	H
372.73	49.35	-7.61	41.74	46.00	-4.26	Peak	H
660.50	38.64	-2.82	35.82	46.00	-10.18	Peak	H

**Remark:**

1. Measuring frequencies from 30 MHz to the 1GHz.
2. Radiated emissions measured in frequency range from 30 MHz to 1000MHz were made with an instrument using peak/quasi-peak detector mode.
3. Quasi-peak test would be performed if the peak result were greater than the quasi-peak limit or as required by the applicant.
4. Measurements above show only up to 6 maximum emissions noted, or would be lesser, with " N/A " remark, if no specific emissions from the EUT are recorded (ie: margin>20dB from the applicable limit) and considered that's already beyond the background noise floor.
5. Margin (dB) = Result (dBuV/m) – Limit (dBuV/m).

**Above 1 GHz****Operation Mode:** TX / IEEE 802.11b / CH Low**Test Date:** September 14, 2011**Temperature:** 23°C**Tested by:** Wolf Huang**Humidity:** 56% RH**Polarity:** Ver. / Hor.

Frequency (MHz)	Reading (Peak) (dBuV)	Reading (Average) (dBuV)	Correction Factor (dB/m)	Result (Peak) (dBuV/m)	Result (Average) (dBuV/m)	Limit (Peak) (dBuV/m)	Limit (Average) (dBuV/m)	Margin (dB)	Remark	Ant. Pol. (H/V)
1890.00	56.57	---	-6.59	49.99	---	74.00	54.00	-4.01	Peak	V
4825.00	46.28	---	2.61	48.89	---	74.00	54.00	-5.11	Peak	V
N/A										
1910.00	56.74	---	-6.38	50.36	---	74.00	54.00	-3.64	Peak	H
4825.00	47.23	---	2.61	49.84	---	74.00	54.00	-4.16	Peak	H
N/A										

**Remark:**

1. Measuring frequencies from 1 GHz to the 10th harmonic of highest fundamental frequency.
2. Radiated emissions measured in frequency above 1000MHz were made with an instrument using peak/average detector mode.
3. Average test would be performed if the peak result were greater than the average limit or as required by the applicant.
4. Data of measurement within this frequency range shown " --- " in the table above means the reading of emissions are attenuated more than 20dB below the permissible limits or the field strength is too small to be measured.
5. Measurements above show only up to 6 maximum emissions noted, or would be lesser, with " N/A " remark, if no specific emissions from the EUT are recorded (ie: margin > 20dB from the applicable limit) and considered that's already beyond the background noise floor.
6. Margin (dB) = Remark result (dBuV/m) – Average limit (dBuV/m).

**Operation Mode:** TX / IEEE 802.11b / CH Mid**Test Date:** September 14, 2011**Temperature:** 23°C**Tested by:** Wolf Huang**Humidity:** 56% RH**Polarity:** Ver. / Hor.

Frequency (MHz)	Reading (Peak) (dBuV)	Reading (Average) (dBuV)	Correction Factor (dB/m)	Result (Peak) (dBuV/m)	Result (Average) (dBuV/m)	Limit (Peak) (dBuV/m)	Limit (Average) (dBuV/m)	Margin (dB)	Remark	Ant. Pol. (H/V)
1913.33	56.07	---	-6.35	49.72	---	74.00	54.00	-4.28	Peak	V
4891.67	47.52	---	2.74	50.27	---	74.00	54.00	-3.73	Peak	V
N/A										
1996.67	56.28	---	-5.50	50.78	---	74.00	54.00	-3.22	Peak	H
4875.00	46.88	---	2.71	49.59	---	74.00	54.00	-4.41	Peak	H
N/A										

**Remark:**

1. Measuring frequencies from 1 GHz to the 10th harmonic of highest fundamental frequency.
2. Radiated emissions measured in frequency above 1000MHz were made with an instrument using peak/average detector mode.
3. Average test would be performed if the peak result were greater than the average limit or as required by the applicant.
4. Data of measurement within this frequency range shown " --- " in the table above means the reading of emissions are attenuated more than 20dB below the permissible limits or the field strength is too small to be measured.
5. Measurements above show only up to 6 maximum emissions noted, or would be lesser, with " N/A " remark, if no specific emissions from the EUT are recorded (ie: margin > 20dB from the applicable limit) and considered that's already beyond the background noise floor.
6. Margin (dB) = Remark result (dBuV/m) – Average limit (dBuV/m).



Operation Mode: TX / IEEE 802.11b / CH High

Test Date: September 14, 2011

Temperature: 23°C

Tested by: Wolf Huang

Humidity: 56% RH

Polarity: Ver. / Hor.

Frequency (MHz)	Reading (Peak) (dBuV)	Reading (Average) (dBuV)	Correction Factor (dB/m)	Result (Peak) (dBuV/m)	Result (Average) (dBuV/m)	Limit (Peak) (dBuV/m)	Limit (Average) (dBuV/m)	Margin (dB)	Remark	Ant. Pol. (H/V)
1936.67	56.50	---	-6.11	50.39	---	74.00	54.00	-3.61	Peak	V
4941.67	46.75	---	2.84	49.59	---	74.00	54.00	-4.41	Peak	V
N/A										
1980.00	56.28	---	-5.67	50.61	---	74.00	54.00	-3.39	Peak	H
4933.33	46.97	---	2.83	49.80	---	74.00	54.00	-4.20	Peak	H
N/A										

Remark:

1. Measuring frequencies from 1 GHz to the 10th harmonic of highest fundamental frequency.
2. Radiated emissions measured in frequency above 1000MHz were made with an instrument using peak/average detector mode.
3. Average test would be performed if the peak result were greater than the average limit or as required by the applicant.
4. Data of measurement within this frequency range shown " --- " in the table above means the reading of emissions are attenuated more than 20dB below the permissible limits or the field strength is too small to be measured.
5. Measurements above show only up to 6 maximum emissions noted, or would be lesser, with " N/A " remark, if no specific emissions from the EUT are recorded (ie: margin > 20dB from the applicable limit) and considered that's already beyond the background noise floor.
6. Margin (dB) = Remark result (dBuV/m) – Average limit (dBuV/m).



Operation Mode: TX / IEEE 802.11g / CH Low

Test Date: September 14, 2011

Temperature: 23°C

Tested by: Wolf Huang

Humidity: 56% RH

Polarity: Ver. / Hor.

Frequency (MHz)	Reading (Peak) (dBuV)	Reading (Average) (dBuV)	Correction Factor (dB/m)	Result (Peak) (dBuV/m)	Result (Average) (dBuV/m)	Limit (Peak) (dBuV/m)	Limit (Average) (dBuV/m)	Margin (dB)	Remark	Ant. Pol. (H/V)
1920.00	56.26	---	-6.28	49.98	---	74.00	54.00	-4.02	Peak	V
N/A										
2000.00	55.96	---	-5.47	50.49	---	74.00	54.00	-3.51	Peak	H
N/A										

Remark:

1. Measuring frequencies from 1 GHz to the 10th harmonic of highest fundamental frequency.
2. Radiated emissions measured in frequency above 1000MHz were made with an instrument using peak/average detector mode.
3. Average test would be performed if the peak result were greater than the average limit or as required by the applicant.
4. Data of measurement within this frequency range shown " --- " in the table above means the reading of emissions are attenuated more than 20dB below the permissible limits or the field strength is too small to be measured.
5. Measurements above show only up to 6 maximum emissions noted, or would be lesser, with " N/A " remark, if no specific emissions from the EUT are recorded (ie: margin > 20dB from the applicable limit) and considered that's already beyond the background noise floor.
6. Margin (dB) = Remark result (dBuV/m) – Average limit (dBuV/m).

**Operation Mode:** TX / IEEE 802.11g / CH Mid**Test Date:** September 14, 2011**Temperature:** 23°C**Tested by:** Wolf Huang**Humidity:** 56% RH**Polarity:** Ver. / Hor.

Frequency (MHz)	Reading (Peak) (dBuV)	Reading (Average) (dBuV)	Correction Factor (dB/m)	Result (Peak) (dBuV/m)	Result (Average) (dBuV/m)	Limit (Peak) (dBuV/m)	Limit (Average) (dBuV/m)	Margin (dB)	Remark	Ant. Pol. (H/V)
1783.33	56.47	---	-7.67	48.80	---	74.00	54.00	-5.20	Peak	V
1860.00	57.28	---	-6.89	50.38	---	74.00	54.00	-3.62	Peak	V
N/A										
1950.00	55.92	---	-5.98	49.94	---	74.00	54.00	-4.06	Peak	H
N/A										

**Remark:**

1. Measuring frequencies from 1 GHz to the 10th harmonic of highest fundamental frequency.
2. Radiated emissions measured in frequency above 1000MHz were made with an instrument using peak/average detector mode.
3. Average test would be performed if the peak result were greater than the average limit or as required by the applicant.
4. Data of measurement within this frequency range shown " --- " in the table above means the reading of emissions are attenuated more than 20dB below the permissible limits or the field strength is too small to be measured.
5. Measurements above show only up to 6 maximum emissions noted, or would be lesser, with " N/A " remark, if no specific emissions from the EUT are recorded (ie: margin > 20dB from the applicable limit) and considered that's already beyond the background noise floor.
6. Margin (dB) = Remark result (dBuV/m) – Average limit (dBuV/m).





Operation Mode: TX / IEEE 802.11g / CH High

Test Date: September 14, 2011

Temperature: 23°C

Tested by: Wolf Huang

Humidity: 56% RH

Polarity: Ver. / Hor.

Frequency (MHz)	Reading (Peak) (dBuV)	Reading (Average) (dBuV)	Correction Factor (dB/m)	Result (Peak) (dBuV/m)	Result (Average) (dBuV/m)	Limit (Peak) (dBuV/m)	Limit (Average) (dBuV/m)	Margin (dB)	Remark	Ant. Pol. (H/V)
1826.67	56.96	---	-7.23	49.73	---	74.00	54.00	-4.27	Peak	V
N/A										
1756.67	57.34	---	-7.94	49.40	---	74.00	54.00	-4.60	Peak	H
N/A										

Remark:

1. Measuring frequencies from 1 GHz to the 10th harmonic of highest fundamental frequency.
2. Radiated emissions measured in frequency above 1000MHz were made with an instrument using peak/average detector mode.
3. Average test would be performed if the peak result were greater than the average limit or as required by the applicant.
4. Data of measurement within this frequency range shown " --- " in the table above means the reading of emissions are attenuated more than 20dB below the permissible limits or the field strength is too small to be measured.
5. Measurements above show only up to 6 maximum emissions noted, or would be lesser, with " N/A " remark, if no specific emissions from the EUT are recorded (ie: margin > 20dB from the applicable limit) and considered that's already beyond the background noise floor.
6. Margin (dB) = Remark result (dBuV/m) – Average limit (dBuV/m).



Operation Mode: TX / IEEE 802.11n HT 20 MHz Channel mode / CH Low

Test Date: September 14, 2011

Temperature: 23°C

Tested by: Wolf Huang

Humidity: 56% RH

Polarity: Ver. / Hor.

Frequency (MHz)	Reading (Peak) (dBuV)	Reading (Average) (dBuV)	Correction Factor (dB/m)	Result (Peak) (dBuV/m)	Result (Average) (dBuV/m)	Limit (Peak) (dBuV/m)	Limit (Average) (dBuV/m)	Margin (dB)	Remark	Ant. Pol. (H/V)
1940.00	55.98	---	-6.08	49.90	---	74.00	54.00	-4.10	Peak	V
N/A										
1763.33	56.37	---	-7.87	48.50	---	74.00	54.00	-5.50	Peak	H
N/A										

Remark:

1. Measuring frequencies from 1 GHz to the 10th harmonic of highest fundamental frequency.
2. Radiated emissions measured in frequency above 1000MHz were made with an instrument using peak/average detector mode.
3. Average test would be performed if the peak result were greater than the average limit or as required by the applicant.
4. Data of measurement within this frequency range shown " --- " in the table above means the reading of emissions are attenuated more than 20dB below the permissible limits or the field strength is too small to be measured.
5. Measurements above show only up to 6 maximum emissions noted, or would be lesser, with " N/A " remark, if no specific emissions from the EUT are recorded (ie: margin>20dB from the applicable limit) and considered that's already beyond the background noise floor.
6. Margin (dB) = Remark result (dBuV/m) – Average limit (dBuV/m).



Operation Mode: TX / IEEE 802.11n HT 20 MHz Channel mode / CH Mid

Test Date: September 14, 2011

Temperature: 23°C

Tested by: Wolf Huang

Humidity: 56% RH

Polarity: Ver. / Hor.

Frequency (MHz)	Reading (Peak) (dBuV)	Reading (Average) (dBuV)	Correction Factor (dB/m)	Result (Peak) (dBuV/m)	Result (Average) (dBuV/m)	Limit (Peak) (dBuV/m)	Limit (Average) (dBuV/m)	Margin (dB)	Remark	Ant. Pol. (H/V)
1926.67	55.92	---	-6.22	49.70	---	74.00	54.00	-4.30	Peak	V
N/A										
1913.33	55.98	---	-6.35	49.63	---	74.00	54.00	-4.37	Peak	H
N/A										

Remark:

1. Measuring frequencies from 1 GHz to the 10th harmonic of highest fundamental frequency.
2. Radiated emissions measured in frequency above 1000MHz were made with an instrument using peak/average detector mode.
3. Average test would be performed if the peak result were greater than the average limit or as required by the applicant.
4. Data of measurement within this frequency range shown " --- " in the table above means the reading of emissions are attenuated more than 20dB below the permissible limits or the field strength is too small to be measured.
5. Measurements above show only up to 6 maximum emissions noted, or would be lesser, with " N/A " remark, if no specific emissions from the EUT are recorded (ie: margin>20dB from the applicable limit) and considered that's already beyond the background noise floor.
6. Margin (dB) = Remark result (dBuV/m) – Average limit (dBuV/m).



**Operation Mode:** TX / IEEE 802.11n HT 20 MHz Channel mode / CH High

**Test Date:** September 14, 2011

**Temperature:** 23°C

**Tested by:** Wolf Huang

**Humidity:** 56% RH

**Polarity:** Ver. / Hor.

Frequency (MHz)	Reading (Peak) (dBuV)	Reading (Average) (dBuV)	Correction Factor (dB/m)	Result (Peak) (dBuV/m)	Result (Average) (dBuV/m)	Limit (Peak) (dBuV/m)	Limit (Average) (dBuV/m)	Margin (dB)	Remark	Ant. Pol. (H/V)
1870.00	56.12	---	-6.79	49.32	---	74.00	54.00	-4.68	Peak	V
4933.33	46.97	---	2.83	49.79	---	74.00	54.00	-4.21	Peak	V
N/A										
1906.67	55.90	---	-6.42	49.48	---	74.00	54.00	-4.52	Peak	H
N/A										

**Remark:**

1. Measuring frequencies from 1 GHz to the 10th harmonic of highest fundamental frequency.
2. Radiated emissions measured in frequency above 1000MHz were made with an instrument using peak/average detector mode.
3. Average test would be performed if the peak result were greater than the average limit or as required by the applicant.
4. Data of measurement within this frequency range shown " --- " in the table above means the reading of emissions are attenuated more than 20dB below the permissible limits or the field strength is too small to be measured.
5. Measurements above show only up to 6 maximum emissions noted, or would be lesser, with " N/A " remark, if no specific emissions from the EUT are recorded (ie: margin > 20dB from the applicable limit) and considered that's already beyond the background noise floor.
6. Margin (dB) = Remark result (dBuV/m) – Average limit (dBuV/m).

**Operation Mode:** RX / IEEE 802.11g / CH Mid**Test Date:** September 14, 2011**Temperature:** 23°C**Tested by:** Wolf Huang**Humidity:** 55 % RH**Polarity:** Ver. / Hor.

Frequency (MHz)	Reading (Peak) (dBuV)	Reading (Average) (dBuV)	Correction Factor (dB/m)	Result (Peak) (dBuV/m)	Result (Average) (dBuV/m)	Limit (Peak) (dBuV/m)	Limit (Average) (dBuV/m)	Margin (dB)	Remark	Ant. Pol. (H/V)
1973.33	49.37	---	-5.74	43.63	---	74.00	54.00	-10.37	Peak	V
N/A										
1986.67	49.77	---	-5.61	44.17	---	74.00	54.00	-9.83	Peak	H
N/A										

**Remark:**

1. Measuring frequencies from 1 GHz to the 10th harmonic of highest fundamental frequency.
2. Radiated emissions measured in frequency above 1000MHz were made with an instrument using peak/average detector mode.
3. Average test would be performed if the peak result were greater than the average limit or as required by the applicant.
4. Data of measurement within this frequency range shown " --- " in the table above means the reading of emissions are attenuated more than 20dB below the permissible limits or the field strength is too small to be measured.
5. Measurements above show only up to 6 maximum emissions noted, or would be lesser, with " N/A " remark, if no specific emissions from the EUT are recorded (ie: margin > 20dB from the applicable limit) and considered that's already beyond the background noise floor.
6. Margin (dB) = Remark result (dBuV/m) – Average limit (dBuV/m).



## 8.9 POWERLINE CONDUCTED EMISSIONS

### LIMIT

According to §15.207(a) & RSS-Gen §7.2.2, except as shown in paragraphs (b) and (c) of this section, for an intentional radiator that is designed to be connected to the public utility (AC) power line, the radio frequency voltage that is conducted back onto the AC power line on any frequency or frequencies within the band 150 kHz to 30 MHz shall not exceed the limits in the following table, as measured using a 50  $\mu$ H/50 ohms line impedance stabilization network (LISN). Compliance with the provisions of this paragraph shall be based on the measurement of the radio frequency voltage between each power line and ground at the power terminal. The lower limit applies at the boundary between the frequency ranges.

Frequency Range (MHz)	Limits (dB $\mu$ V)	
	Quasi-peak	Average
0.15 to 0.50	66 to 56*	56 to 46*
0.50 to 5	56	46
5 to 30	60	50

\* Decreases with the logarithm of the frequency.

### Test Configuration

See test photographs attached in Appendix II for the actual connections between EUT and support equipment.

### TEST PROCEDURE

1. The EUT was placed on a table, which is 0.8m above ground plane.
2. Maximum procedure was performed on the six highest emissions to ensure EUT compliance.
3. Repeat above procedures until all frequency measured were complete.



## TEST RESULTS

The initial step in collecting conducted data is a spectrum analyzer peak scan of the measurement range. Significant peaks are then marked as shown on the following data page, and these signals are then quasi-peaked.

### Test Data

**Operation Mode:** Normal Link                      **Test Date:** August 30, 2011  
**Temperature:** 26°C                                      **Tested by:** Rex Huang  
**Humidity:** 60% RH

Freq. (MHz)	QP Reading (dBuV)	AV Reading (dBuV)	Corr. factor (dB/m)	QP Result (dBuV/m)	AV Result (dBuV/m)	QP Limit (dBuV)	AV Limit (dBuV)	QP Margin (dB)	AV Margin (dB)	Note
0.1500	45.83	36.13	0.17	46.00	36.30	65.99	56.00	-19.99	-19.70	L1
0.1750	50.64	40.74	0.16	50.80	40.90	64.71	54.72	-13.91	-13.82	L1
0.3000	42.84	37.14	0.16	43.00	37.30	60.24	50.24	-17.24	-12.94	L1
0.5700	44.34	38.74	0.16	44.50	38.90	56.00	46.00	-11.50	-7.10	L1
0.9700	46.33	38.73	0.17	46.50	38.90	56.00	46.00	-9.50	-7.10	L1
1.3800	46.12	38.32	0.18	46.30	38.50	56.00	46.00	-9.70	-7.50	L1
0.1500	45.24	36.84	0.26	45.50	37.10	66.00	56.00	-20.50	-18.90	L2
0.2200	42.25	33.85	0.25	42.50	34.10	62.82	52.82	-20.32	-18.72	L2
0.4050	47.75	41.65	0.25	48.00	41.90	57.75	47.75	-9.75	-5.85	L2
0.5750	45.05	39.35	0.25	45.30	39.60	56.00	46.00	-10.70	-6.40	L2
0.9750	46.84	38.94	0.26	47.10	39.20	56.00	46.00	-8.90	-6.80	L2
1.3450	45.34	37.44	0.26	45.60	37.70	56.00	46.00	-10.40	-8.30	L2

### **Remark:**

1. Measuring frequencies from 0.15 MHz to 30MHz.
2. The emissions measured in frequency range from 0.15 MHz to 30MHz were made with an instrument using Quasi-peak detector and average detector.
3. The IF bandwidth of SPA between 0.15MHz and 30MHz was 10 kHz; the IF bandwidth of Test Receiver between 0.15MHz and 30MHz was 9 kHz;
4. L1 = Line One (Live Line) / L2 = Line Two (Neutral Line)



### Test Plots

#### Conducted emissions (Line 1)

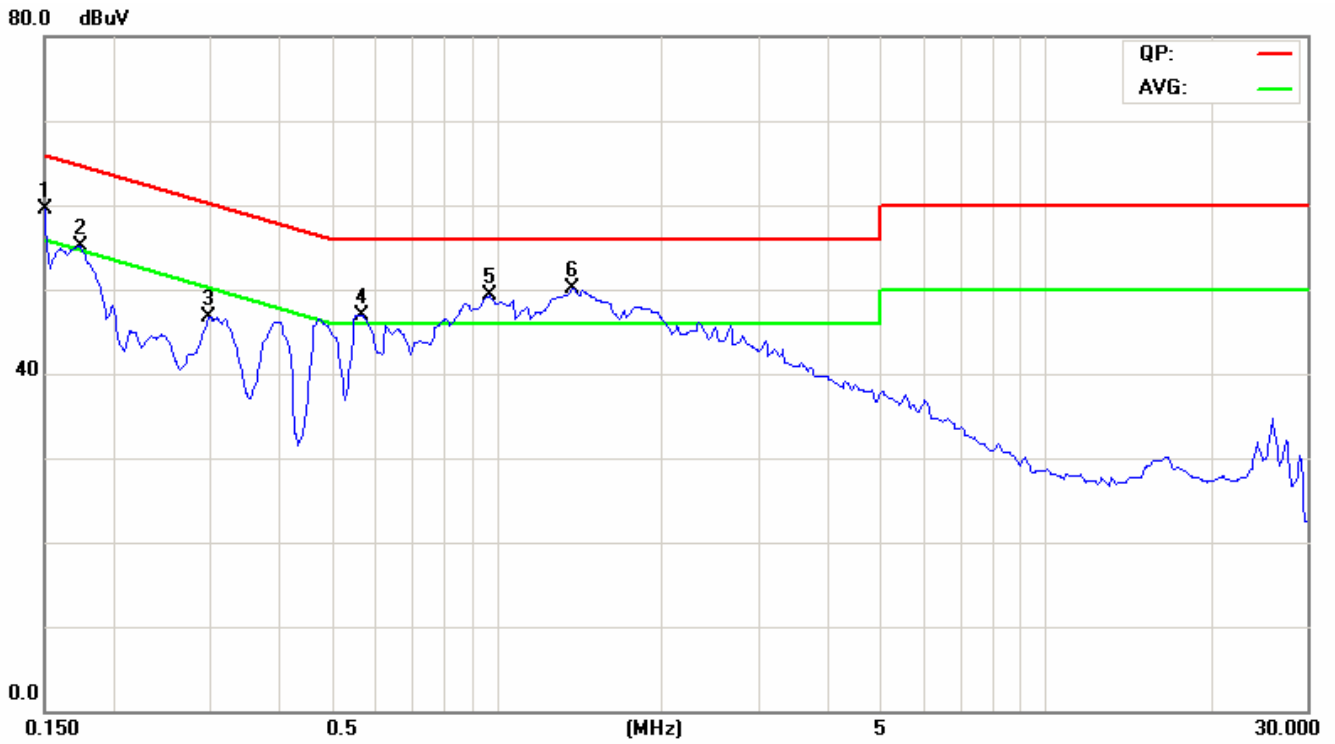

#### Conducted emissions (Line 2)

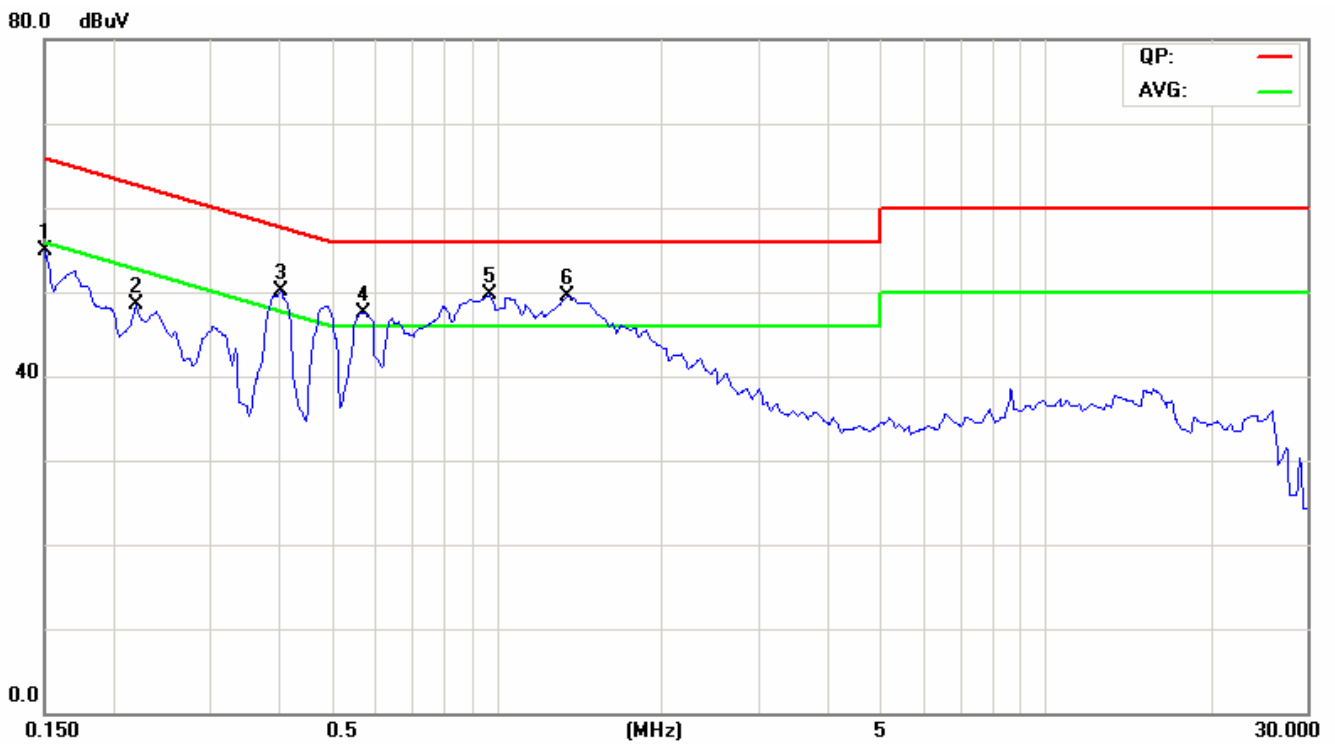





## APPENDIX I RADIO FREQUENCY EXPOSURE

### LIMIT

According to §15.247(i), systems operating under the provisions of this section shall be operated in a manner that ensures that the public is not exposed to radio frequency energy levels in excess of the Commission's guidelines. See § 1.1307(b)(1) of this chapter.

### EUT Specification

<b>EUT</b>	Kobo Vox eReader Tablet
<b>Frequency band (Operating)</b>	<input checked="" type="checkbox"/> WLAN: 2.412GHz ~ 2.462GHz <input type="checkbox"/> WLAN: 5.18GHz ~ 5.32GHz / 5.50GHz ~ 5.70GHz <input type="checkbox"/> WLAN: 5.745GHz ~ 5.825GHz <input type="checkbox"/> Others
<b>Device category</b>	<input checked="" type="checkbox"/> Portable (<20cm separation) <input type="checkbox"/> Mobile (>20cm separation) <input type="checkbox"/> Others
<b>Exposure classification</b>	<input type="checkbox"/> Occupational/Controlled exposure ( $S = 5\text{mW}/\text{cm}^2$ ) <input checked="" type="checkbox"/> General Population/Uncontrolled exposure ( $S=1\text{mW}/\text{cm}^2$ )
<b>Antenna diversity</b>	<input checked="" type="checkbox"/> Single antenna <input type="checkbox"/> Multiple antennas <input type="checkbox"/> Tx diversity <input type="checkbox"/> Rx diversity <input type="checkbox"/> Tx/Rx diversity
<b>Max. output power</b>	IEEE 802.11b mode: 19.44 dBm (87.9023 mW) IEEE 802.11g mode: 22.17 dBm (164.8162 mW) IEEE 802.11n HT 20 MHz Channel mode: 22.03 dBm (159.5879 mW)
<b>Antenna gain (Max)</b>	3.0 dBi (Numeric gain: 1.99)
<b>Evaluation applied</b>	<input type="checkbox"/> MPE Evaluation <input checked="" type="checkbox"/> SAR Evaluation* <input type="checkbox"/> N/A
<b>Remark:</b>	
The maximum output power is <u>22.17dBm (164.8162mW) at 2437MHz (with 1.99 numeric antenna gain.)</u>	

### TEST RESULTS

No non-compliance noted.

Remark: Please refer to the separated SAR report.

### MPE EVALUATION

Not applicable.