

FCC Test Report (Part 96)

Report No.: RF200109E02-4

FCC ID: 2AQ68T99W175

Test Model: T99W175

Received Date: Jan. 10, 2020

Test Date: Feb. 11 ~ Feb. 25, 2020

Issued Date: Mar. 16, 2020

Applicant: Hon Lin Technology Co., Ltd.

Address: 11F, No. 32, Jihu Rd., Neihu Dist., Taipei City 114, Taiwan R.O.C.

Issued By: Bureau Veritas Consumer Products Services (H.K.) Ltd., Taoyuan Branch
Lin Kou Laboratories

Lab Address: No. 47-2, 14th Ling, Chia Pau Vil., Lin Kou Dist., New Taipei City, Taiwan

Test Location: No. 19, Hwa Ya 2nd Rd., Wen Hwa Vil., Kwei Shan Dist., Taoyuan City
33383, Taiwan

**FCC Registration/
Designation Number:** 788550 / TW0003



This report is for your exclusive use. Any copying or replication of this report to or for any other person or entity, or use of our name or trademark, is permitted only with our prior written permission. This report sets forth our findings solely with respect to the test samples identified herein. The results set forth in this report are not indicative or representative of the quality or characteristics of the lot from which a test sample was taken or any similar or identical product specifically and expressly noted. Our report includes all of the tests requested by you and the results thereof based upon the information that you provided to us. You have 60 days from date of issuance of this report to notify us of any material error or omission caused by our negligence, provided, however, that such notice shall be in writing and shall specifically address the issue you wish to raise. A failure to raise such issue within the prescribed time shall constitute your unqualified acceptance of the completeness of this report, the tests conducted and the correctness of the report contents. Unless specific mention, the uncertainty of measurement has been explicitly taken into account to declare the compliance or non-compliance to the specification. The report must not be used by the client to claim product certification, approval, or endorsement by TAF or any government agencies.

Table of Contents

Release Control Record	4
1 Certificate of Conformity	5
2 Summary of Test Results	6
2.1 Measurement Uncertainty.....	6
2.2 Modification Record.....	6
3 General Information	7
3.1 General Description of EUT.....	7
3.2 Test Mode Applicability and Tested Channel Detail.....	10
3.3 Description of Support Units.....	12
3.3.1 Configuration of System under Test.....	12
3.4 General Description of Applied Standards and References.....	13
4 Test Types and Results	14
4.1 Maximum Output Power Measurement.....	14
4.1.1 Limits of Maximum Output Power Measurement.....	14
4.1.2 Test Setup.....	14
4.1.3 Test Instruments.....	15
4.1.4 Test Procedures.....	16
4.1.5 Deviation from Test Standard.....	16
4.1.6 EUT Operating Conditions.....	16
4.1.7 Test Results.....	17
4.2 Modulation Characteristics Measurement.....	25
4.2.1 Limits of Modulation Characteristics.....	25
4.2.2 Test Procedure.....	25
4.2.3 Test Setup.....	25
4.2.4 Test Results.....	25
4.3 Frequency Stability Measurement.....	26
4.3.1 Limits of Frequency Stability Measurement.....	26
4.3.2 Test Procedure.....	26
4.3.3 Test Setup.....	26
4.3.4 Test Results.....	27
4.4 Emission Bandwidth Measurement.....	31
4.4.1 Emission Bandwidth Measurement.....	31
4.4.2 Test Setup.....	31
4.4.3 Test Instruments.....	31
4.4.4 Test Procedure.....	31
4.4.5 Deviation from Test Standard.....	31
4.4.6 EUT Operating Conditions.....	31
4.4.7 Test Result (-26dB Bandwidth).....	32
4.4.8 Test Result (Occupied Bandwidth).....	34
4.5 Peak to Average Ratio Measurement.....	36
4.5.1 Limits of Peak to Average Ratio Measurement.....	36
4.5.2 Test Setup.....	36
4.5.3 Test Procedures.....	36
4.5.4 Test Results.....	37
4.6 Conducted Spurious Emissions.....	39
4.6.1 Limits of Conducted Spurious Emissions Measurement.....	39
4.6.2 Test Setup.....	39
4.6.3 Test Procedure.....	39
4.6.4 Test Results.....	40
4.7 Radiated Emission Measurement.....	60
4.7.1 Limits of Radiated Emission Measurement.....	60
4.7.2 Test Instruments.....	60

4.7.3 Test Procedures.....	60
4.7.4 Deviation from Test Standard	60
4.7.5 Test Set Up	61
4.7.6 Test Results	62
5 Pictures of Test Arrangements.....	70
Appendix – Information of the Testing Laboratories	71

Release Control Record

Issue No.	Description	Date Issued
RF200109E02-4	Original release	Mar. 16, 2020

1 Certificate of Conformity

Product: 5G WWAN Module

Brand: Foxconn

Test Model: T99W175

Sample Status: Engineering sample

Applicant: Hon Lin Technology Co., Ltd.

Test Date: Feb. 11 ~ Feb. 25, 2020

Standards: FCC 47 CFR Part 96

The above equipment has been tested by **Bureau Veritas Consumer Products Services (H.K.) Ltd., Taoyuan Branch**, and found compliance with the requirement of the above standards. The test record, data evaluation & Equipment Under Test (EUT) configurations represented herein are true and accurate accounts of the measurements of the sample's RF characteristics under the conditions specified in this report.

Prepared by : Pettie Chen , **Date:** Mar. 16, 2020
Pettie Chen / Senior Specialist

Approved by : Bruce Chen , **Date:** Mar. 16, 2020
Bruce Chen / Senior Project Engineer

2 Summary of Test Results

47 CFR FCC Part 96			
FCC Clause	Test Item	Result	Remarks
2.1046 96.41(b)	Maximum Peak Output Power	Pass	Meet the requirement of limit.
2.1047 96.41(a)	Modulation Characteristics	Pass	Meet the requirement
2.1046 96.41(b)	Maximum Power Spectral Density	Pass	Meet the requirement of limit.
96.41(g)	Peak to Average Ration	Pass	Meet the requirement of limit.
2.1049	Emission Bandwidth	Pass	Meet the requirement of limit.
2.1055	Frequency Stability	Pass	Meet the requirement of limit.
2.1051 96.41(e)	Conducted Spurious Emissions	Pass	Meet the requirement of limit.
2.1053 96.41(e)	Radiated Spurious Emissions	Pass	Meet the requirement of limit. Minimum passing margin is -4.2dB at 58.13MHz.

2.1 Measurement Uncertainty

Where relevant, the following measurement uncertainty levels have been estimated for tests performed on the EUT as specified in CISPR 16-4-2:

Measurement	Frequency	Expanded Uncertainty (k=2) (±)
Radiated Emissions up to 1 GHz	9 kHz ~ 30MHz	3.04 dB
	30 MHz ~ 200 MHz	3.59 dB
	200 MHz ~ 1000 MHz	3.60 dB
Radiated Emissions above 1 GHz	1 GHz ~ 18 GHz	2.29 dB
	18 GHz ~ 40 GHz	2.29 dB

2.2 Modification Record

There were no modifications required for compliance.

3 General Information

3.1 General Description of EUT

Product	5G WWAN Module				
Brand	Foxconn				
Test Model	T99W175				
Status of EUT	Engineering sample				
Power Supply Rating	5 Vdc (Host equipment) 3.135Vdc~3.63Vdc (Module)				
Modulation Type	QPSK, 16QAM, 64QAM				
Operating Frequency	LTE Band 48	Channel Bandwidth 5MHz	TX: 3552.5 ~ 3697.5 MHz RX: 3552.5 ~ 3697.5 MHz		
		Channel Bandwidth 10MHz	TX: 3555 ~ 3695 MHz RX: 3555 ~ 3695 MHz		
		Channel Bandwidth 15MHz	TX: 3557.5 ~ 3692.5 MHz RX: 3557.5 ~ 3692.5 MHz		
		Channel Bandwidth 20MHz	TX: 3560 ~ 3690 MHz RX: 3560 ~ 3690 MHz		
				QPSK	16QAM
Max. EIRP Power	LTE Band 48	Per 10M			
		Channel Bandwidth 5MHz	164.816mW (22.17dBm)	141.254mW (21.50dBm)	107.399mW (20.31dBm)
		Channel Bandwidth 10MHz	170.216mW (22.31dBm)	141.579mW (21.51dBm)	111.944mW (20.49dBm)
		Channel Bandwidth 15MHz	189.671mW (22.78dBm)	153.109mW (21.85dBm)	122.462mW (20.88dBm)
		Channel Bandwidth 20MHz	187.068mW (22.72dBm)	145.546mW (21.63dBm)	121.899mW (20.86dBm)
		Full Power			
		Channel Bandwidth 5MHz	164.816mW (22.17dBm)	141.254mW (21.50dBm)	107.399mW (20.31dBm)
		Channel Bandwidth 10MHz	170.216mW (22.31dBm)	141.579mW (21.51dBm)	111.944mW (20.49dBm)
		Channel Bandwidth 15MHz	190.985mW (22.81dBm)	165.577mW (22.19dBm)	127.644mW (21.06dBm)
		Channel Bandwidth 20MHz	195.884mW (22.92dBm)	169.434mW (22.29dBm)	127.350mW (21.05dBm)
Emission Designator	LTE Band 48	Channel Bandwidth 5MHz	4M49G7D	4M49D7W	4M49D7W
		Channel Bandwidth 10MHz	8M96G7D	8M97D7W	8M96D7W
		Channel Bandwidth 15MHz	13M5G7D	13M4D7W	13M4D7W
		Channel Bandwidth 20MHz	17M9G7D	17M9D7W	17M9D7W
Antenna Type	Refer to Note as below				
Antenna Connector	Refer to Note as below				
Accessory Device	NA				
Cable Supplied	NA				

Note:

- There are four Difference HW of T99W175.

Brand	Model	HW
Foxconn	T99W175	1. 3G+LTE+Sub6+eSIM
		2. 3G+LTE+Sub6 only w/o eSIM
		3. 3G+LTE+Sub6+eSIM+GNSS connector
		4. 3G+LTE+Sub6 only+w/o eSIM+GNSS connector

*After pre-testing, "HW: 1. 3G+LTE+Sub6+eSIM" is the worst for the final tests.

2. The following antennas were provided to the EUT.

Antenna No.	RF Chain No.	Brand	Model	Antenna Net Gain(dBi)	Frequency range (MHz)	Antenna Type	Connector Type
1		WHA YU	C107-511720-A	4.41	660~803	PCB	I-PEX
2		WHA YU	C107-511721-A	3.81 4.03	791~960 1447.9~1606	PCB	I-PEX
3		WHA YU	C107-511722-A	4.27 5.31	1710~2170 2500~2690	PCB	I-PEX
4		WHA YU	C107-511723-A	2.99 0.92	2300~2400 3500~3700	PCB	I-PEX
5		WHA YU	C107-511724-A	6.45	5150~5925	PCB	I-PEX
6		WHA YU	C107-511725-A	4.89	3400~3700	PCB	I-PEX
7		AVX	5000106-R1-X01	2.91	699~803	Monopole	I-PEX
8		AVX	5000107-R1-X01	2.59	791~960	Monopole	I-PEX
9		AVX	5000108-R1-X01	2.85	1427~1610	Monopole	I-PEX
10		AVX	5000109-R1-X01	2.23 2.94	1710~2200 5150~5925	Monopole	I-PEX
11		AVX	5000110-R1-X01	0.9	2300~2690	Monopole	I-PEX
12		AVX	5000111-R1-X01	0.87	3300~5000	Monopole	I-PEX
13	Tx1/ Rx1	Ethertronics	5003806	0.4 -1.61 0.39 2.95 1.98 0.38 0.83 2.31	698-821 824-960 1425-1515 1710-2200 2300-2690 3300-4200 4400-5000 5150-5925	PIFA	I-PEX
	Rx2	Ethertronics	5003807	-2.24 -4.52 2.87 2.99 2.93 2.91 2.23 -0.85 -3.04	716-821 824-960 1425-1515 1557-1610 1805-2200 2300-2690 3300-4200 4400-5000 5150-5925	PIFA	I-PEX
	Tx2/ Rx3	Ethertronics	5003806	2.21 2.25 -0.45 2.6	1710-2200 2300-2690 3300-4200 4400-5000	PIFA	I-PEX
	Rx4	Ethertronics	5003700	1.38 2.87 0.6 -2.09	1805-2200 2300-2690 3300-4200 4400-5000	PIFA	I-PEX

Antenna No.	RF Chain No.	Brand	Model	Antenna Net Gain(dBi)	Frequency range (MHz)	Antenna Type	Connector Type
14	Ant. 0 (TX/RX)	Master Wave	NA	2.4 2.2 2.9 2.9 2.9 NA	880~960 1020~2170 2545~2595 3565~3600 3900~4000 GPS	PCB	I-PEX
	Ant. 2 (TX/RX)	Master Wave	NA	NA 2.2 2.8 2.9 2.8 NA	880~960 1020~2170 2545~2595 3565~3600 3900~4000 GPS	PCB	I-PEX
	Ant. 1 (RX)	Master Wave	NA	NA 5.3 5.1 4.3 4.5 NA	880~960 1020~2170 2545~2595 3565~3600 3900~4000 GPS	PCB	I-PEX
	Ant. 3 (RX)	Master Wave	NA	1.3 6.8 3.7 6.4 6.2 3.7	880~960 1020~2170 2545~2595 3565~3600 3900~4000 GPS	PCB	I-PEX

*The antenna for the final tests as following table.

	Band	Antenna
WCDMA	2	Antenna 3
	4	Antenna 3
	5	Antenna 2
LTE	2	Antenna 3
	4	Antenna 3
	5	Antenna 2
	7	Antenna 3
	12	Antenna 1
	13	Antenna 1
	14	Antenna 1
	17	Antenna 1
	25	Antenna 3
	26	Antenna 2
	30	Antenna 4
	66	Antenna 3
	71	Antenna 1
	38	Antenna 3
	41	Antenna 3
48	Antenna 4	

3.2 Test Mode Applicability and Tested Channel Detail

Pre-Scan has been conducted to determine the worst-case mode from all possible combinations between available modulations, data rates, XYZ axis and antenna ports

The worst case was found when positioned on X-plane. Following channel(s) was (were) selected for the final test as listed below:

Test Item	Available Channel	Tested Channel	Channel Bandwidth	Modulation	Mode
Maximum Output Power	55265 to 56715	55265 (3552.5MHz), 55990 (3625.0MHz), 56715 (3697.5MHz)	5MHz	QPSK / 16QAM / 64QAM	1 RB / 0 RB Offset 1 RB / 12 RB Offset 1 RB / 24 RB Offset 12 RB / 0 RB Offset 12 RB / 6 RB Offset 12 RB / 13 RB Offset 25 RB / 0 RB Offset
	55290 to 56690	55290 (3555.0MHz), 55990 (3625.0MHz), 56690 (3695.0MHz)	10MHz	QPSK / 16QAM / 64QAM	1 RB / 0 RB Offset 1 RB / 24 RB Offset 1 RB / 49 RB Offset 25 RB / 0 RB Offset 25 RB / 12 RB Offset 25 RB / 25 RB Offset 50 RB / 0 RB Offset
	55315 to 56665	55315 (3557.5MHz), 55990 (3625.0MHz), 56665 (3692.5MHz)	15MHz	QPSK / 16QAM / 64QAM	1 RB / 0 RB Offset 1 RB / 37 RB Offset 1 RB / 74 RB Offset 36 RB / 0 RB Offset 36 RB / 19 RB Offset 36 RB / 39 RB Offset 75 RB / 0 RB Offset
	55340 to 56640	55340 (3560.0MHz), 55990 (3625.0MHz), 56640 (3690.0MHz)	20MHz	QPSK / 16QAM / 64QAM	1 RB / 0 RB Offset 1 RB / 50 RB Offset 1 RB / 99 RB Offset 50 RB / 0 RB Offset 50 RB / 25 RB Offset 50 RB / 50 RB Offset 100 RB / 0 RB Offset
Modulation Characteristics	55340 to 56640	55990 (3625.0MHz)	20MHz	QPSK / 16QAM / 64QAM	100 RB / 0 RB Offset
Frequency Stability	55265 to 56715	55265 (3552.5MHz), 56715 (3697.5MHz)	5MHz	QPSK	25 RB / 0 RB Offset
	55290 to 56690	55290 (3555.0MHz), 56690 (3695.0MHz)	10MHz	QPSK	50 RB / 0 RB Offset
	55315 to 56665	55315 (3557.5MHz), 56665 (3692.5MHz)	15MHz	QPSK	75 RB / 0 RB Offset
	55340 to 56640	55340 (3560.0MHz), 56640 (3690.0MHz)	20MHz	QPSK	100 RB / 0 RB Offset
Occupied Bandwidth	55265 to 56715	55265 (3552.5MHz), 55990 (3625.0MHz), 56715 (3697.5MHz)	5MHz	QPSK / 16QAM / 64QAM	25 RB / 0 RB Offset
	55290 to 56690	55290 (3555.0MHz), 55990 (3625.0MHz), 56690 (3695.0MHz)	10MHz	QPSK / 16QAM / 64QAM	50 RB / 0 RB Offset
	55315 to 56665	55315 (3557.5MHz), 55990 (3625.0MHz), 56665 (3692.5MHz)	15MHz	QPSK / 16QAM / 64QAM	75 RB / 0 RB Offset
	55340 to 56640	55340 (3560.0MHz), 55990 (3625.0MHz), 56640 (3690.0MHz)	20MHz	QPSK / 16QAM / 64QAM	100 RB / 0 RB Offset

Test Item	Available Channel	Tested Channel	Channel Bandwidth	Modulation	Mode
Peak to Average Ratio	55265 to 56715	55265 (3552.5MHz), 55990 (3625.0MHz), 56715 (3697.5MHz)	5MHz	QPSK / 16QAM / 64QAM	1 RB / 0 RB Offset
	55290 to 56690	55290 (3555.0MHz), 55990 (3625.0MHz), 56690 (3695.0MHz)	10MHz	QPSK / 16QAM / 64QAM	1 RB / 0 RB Offset
	55315 to 56665	55315 (3557.5MHz), 55990 (3625.0MHz), 56665 (3692.5MHz)	15MHz	QPSK / 16QAM / 64QAM	1 RB / 0 RB Offset
	55340 to 56640	55340 (3560.0MHz), 55990 (3625.0MHz), 56640 (3690.0MHz)	20MHz	QPSK / 16QAM / 64QAM	1 RB / 0 RB Offset
Conducted Emission	55265 to 56715	55265 (3552.5MHz), 55990 (3625.0MHz), 56715 (3697.5MHz)	5MHz	QPSK	1 RB / 0 RB Offset
	55290 to 56690	55290 (3555.0MHz), 55990 (3625.0MHz), 56690 (3695.0MHz)	10MHz	QPSK	1 RB / 0 RB Offset
	55315 to 56665	55315 (3557.5MHz), 55990 (3625.0MHz), 56665 (3692.5MHz)	15MHz	QPSK	1 RB / 0 RB Offset
	55340 to 56640	55340 (3560.0MHz), 55990 (3625.0MHz), 56640 (3690.0MHz)	20MHz	QPSK	1 RB / 0 RB Offset
Radiated Emission Below 1GHz	55265 to 56715	55265 (3552.5MHz)	5MHz	QPSK	1 RB / 0 RB Offset
Radiated Emission Above 1GHz	55265 to 56715	55265 (3552.5MHz), 55990 (3625.0MHz), 56715 (3697.5MHz)	5MHz	QPSK	1 RB / 0 RB Offset
	55315 to 56665	55315 (3557.5MHz), 55990 (3625.0MHz), 56665 (3692.5MHz)	15MHz	QPSK	1 RB / 0 RB Offset
	55340 to 56640	55340 (3560.0MHz), 55990 (3625.0MHz), 56640 (3690.0MHz)	20MHz	QPSK	1 RB / 0 RB Offset

Note:

1. This device was tested under all bandwidths, RB configurations and modulations. The worst case was found in QPSK modulation.
2. For radiated emission below 1GHz, low, mid and high channels were pre-tested in chamber. Low channel in 5MHz was found to be the worst case and therefore had been chosen for all final tests.
3. For radiated emission above 1GHz, according to 3GPP 36.521 Section 6.6.3.1.4, choose the lowest, 5MHz & highest channel bandwidth for final test.

Test Condition:

Test Item	Environmental Conditions	Input Power	Tested By
Maximum Output Power	25deg. C, 70%RH	5Vdc	Han Wu
Modulation characteristics	24deg. C, 64%RH	5Vdc	James Yang
Frequency Stability	24deg. C, 64%RH	5Vdc	James Yang
Occupied Bandwidth	24deg. C, 64%RH	5Vdc	James Yang
Peak to Average Ratio	24deg. C, 64%RH	5Vdc	James Yang
Condcudeted Emission	24deg. C, 64%RH	5Vdc	James Yang
Radiated Emission	22deg. C, 68%RH 25deg. C, 70%RH	120Vac, 60Hz	Greg Lin Luis Lee

3.3 Description of Support Units

The EUT has been tested as an independent unit together with other necessary accessories or support units. The following support units or accessories were used to form a representative test configuration during the tests.

ID	Product	Brand	Model No.	Serial No.	FCC ID	Remarks
A.	Wideband Radio Communication Tester	R&S	CMW500	151084	NA	-
B.	Adapter	LITEON	PA-1050-39	NA	NA	-
C.	Fixture	NA	NA	NA	NA	Provided by client.

Note:

1. All power cords of the above support units are non-shielded (1.8m).
2. Items A acted as communication partners to transfer data.

ID	Descriptions	Qty.	Length (m)	Shielding (Yes/No)	Cores (Qty.)	Remarks
1.	USB cable	1	1.5	Y	0	-

3.3.1 Configuration of System under Test

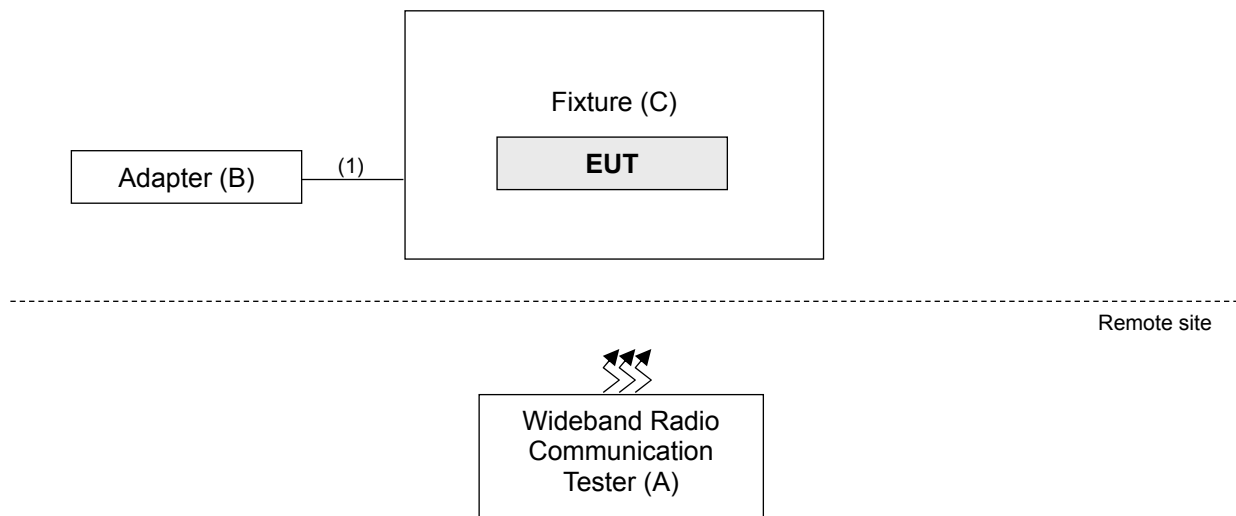

3.4 General Description of Applied Standards and References

The EUT is a RF Product. According to the specifications of the manufacturer, it must comply with the requirements of the following standards:

Test Standard:

FCC 47 CFR Part 2

FCC 47 CFR Part 96

ANSI/TIA/EIA-603-D-2010

All test items have been performed and recorded as per the above standards.

References Test Guidance:

KDB 971168 D01 Power Meas License Digital Systems v03r01

KDB 662911 D01 Multiple Transmitter Output v02r01

KDB 940660 D01 Part 96 CBRS Eqpt v02

All test items have been performed as a reference to the above KDB test guidance.

4 Test Types and Results

4.1 Maximum Output Power Measurement

4.1.1 Limits of Maximum Output Power Measurement

Device		Maximum Output Power (dBm/10 MHz)
<input checked="" type="checkbox"/>	End User Device	23
<input type="checkbox"/>	Category A CBSD	30
<input type="checkbox"/>	Category B CBSD	47

4.1.2 Test Setup

Conducted Measurement Method

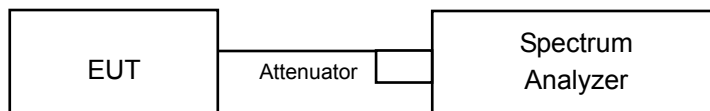

4.1.3 Test Instruments

Description & Manufacturer	Model No.	Serial No.	Cal. Date	Cal. Due
Test Receiver ROHDE & SCHWARZ	ESCI	100424	Dec. 31, 2019	Dec. 30, 2020
Spectrum Analyzer ROHDE & SCHWARZ	FSP40	100040	Sep. 23, 2019	Sep. 22, 2020
BILOG Antenna SCHWARZBECK	VULB9168	9168-155	Nov. 11, 2019	Nov. 10, 2020
HORN Antenna SCHWARZBECK	BBHA 9120D	9120D-1170	Nov. 24, 2019	Nov. 23, 2020
HORN Antenna SCHWARZBECK	BBHA 9170	BBHA9170241	Nov. 24, 2019	Nov. 23, 2020
Loop Antenna TESEQ	HLA 6121	45745	Jul. 01, 2019	Jun. 30, 2020
Radio Communication Analyzer Anritsu	MT8821C	6261806803	Jan. 22, 2019	Jan. 21, 2020
Preamplifier Agilent (Below 1GHz)	8447D	2944A10631	Jul. 11, 2019	Jul. 10, 2020
Preamplifier KEYSIGHT (Above 1GHz)	83017A	MY53270295	Jun. 11, 2019	Jun. 10, 2020
RF Coaxial Cable WORKEN With 5dB PAD	8D-FB	Cable-CH4-01	Aug. 20, 2019	Aug. 19, 2020
RF Coaxial Cable EMCI	EMC102-KM-KM-3000	150929	Aug. 20, 2019	Aug. 19, 2020
RF Coaxial Cable EMCI	EMC102-KM-KM-600	150928	Aug. 20, 2019	Aug. 19, 2020
RF signal cable HUBER+SUHNER	SUCOFLEX 104	MY 13380+295012/04	Jul. 11, 2019	Jul. 10, 2020
RF signal cable HUBER+SUHNER	SUCOFLEX 104	Cable-CH4-03 (250724)	Jul. 11, 2019	Jul. 10, 2020
Software BV ADT	ADT_Radiated_ V7.6.15.9.5	NA	NA	NA
Antenna Tower inn-co GmbH	MA 4000	010303	NA	NA
Antenna Tower Controller BV ADT	AT100	AT93021703	NA	NA
Boresight Antenna Fixture	FBA-01	FBA-SIP01	NA	NA
WIT Standard Temperature And Humidity Chamber	TH-4S-C	W981030	Jun. 03, 2019	Jun. 02, 2020
JFW 20dB attenuation	50HF-020-SMA	NA	NA	NA
True RMS Clamp Meter Fluke	325	31130711WS	May 21, 2019	May 20, 2020

Note: 1. The calibration interval of the above test instruments is 12 months and the calibrations are traceable to NML/ROC and NIST/USA.
 2. The test was performed in HwaYa Chamber 4.

4.1.4 Test Procedures

Conducted output power measurement

1. Connect the DUT transmitter output to the spectrum analyzer via coaxial cable while ensuring proper impedance matching.
2. Set span to at least 1.5 times the OBW.
3. Set RBW = 1-5% of the OBW, not to exceed 1 MHz.
4. Set VBW $\geq 3 \times$ RBW.
5. Set number of points in sweep $\geq 2 \times$ span / RBW.
6. Sweep time = auto-couple.
7. Detector = RMS (power averaging).
8. If the EUT can be configured to transmit continuously (i.e., burst duty cycle $\geq 98\%$), then set the trigger to free run.
9. If the EUT cannot be configured to transmit continuously (i.e., burst duty cycle $< 98\%$), then use a sweep trigger with the level set to enable triggering only on full power bursts and configure the EUT to transmit at full power for the entire duration of each sweep. Ensure that the sweep time is less than or equal to the transmission burst duration.
10. Trace average at least 100 traces in power averaging (i.e., RMS) mode.
11. Compute the power by integrating the spectrum across the OBW of the signal using the instrument's band or channel power measurement function, with the band/channel limits set equal to the OBW band edges. If the instrument does not have a band or channel power function, then sum the spectrum levels (in linear power units) at intervals equal to the RBW extending across the entire OBW of the spectrum.
12. For per 10MHz method, channel power integrating bandwidth 10MHz is used for bandwidth 5M, 10M, 15M and 20M. 13. For full power method, channel power integrating bandwidth 10MHz is used for bandwidth 5M, 10M, integrating bandwidth 15MHz is used for bandwidth 15M, integrating bandwidth 20MHz is used for bandwidth 20M.

Maximum EIRP

The relevant equation for determining the maximum ERP or EIRP from the measured RF output power is given in Equation as follows:

$$\text{ERP or EIRP} = P_{\text{Meas}} + G_{\text{T}}$$

where

ERP or EIRP effective radiated power or equivalent isotropically radiated power, respectively
(expressed in the same units as P_{Meas} , e.g., dBm or dBW)

P_{Meas} measured transmitter output power or PSD, in dBm or dBW

G_{T} gain of the transmitting antenna, in dBd (ERP) or dBi (EIRP)

4.1.5 Deviation from Test Standard

No deviation.

4.1.6 EUT Operating Conditions

The software provided by client to enable the EUT under transmission condition continuously at lowest, middle and highest channel frequencies individually.

4.1.7 Test Results

Conducted Output Power (dBm) / Per 10M

Band / BW	RB Size	RB Offset	QPSK			16QAM			64QAM		
			Low CH	Mid CH	High CH	Low CH	Mid CH	High CH	Low CH	Mid CH	High CH
			55265 3552.5 MHz	55990 3625 MHz	56715 3697.5 MHz	55265 3552.5 MHz	55990 3625 MHz	56715 3697.5 MHz	55265 3552.5 MHz	55990 3625 MHz	56715 3697.5 MHz
48 / 5M	1	0	21.18	21.21	21.19	20.44	20.50	20.58	19.26	19.38	19.39
	1	12	21.11	21.17	21.12	20.47	20.46	20.54	19.21	19.29	19.32
	1	24	21.24	21.25	21.23	20.50	20.54	20.56	19.27	19.28	19.37
	12	0	20.28	20.31	20.39	19.36	19.37	19.36	18.44	18.42	18.46
	12	6	20.31	20.34	20.32	19.34	19.38	19.39	18.38	18.40	18.49
	12	13	20.22	20.29	20.38	19.32	19.40	19.36	18.41	18.44	18.46
	25	0	20.31	20.38	20.35	19.39	19.38	19.44	18.38	18.42	18.44

Band / BW	RB Size	RB Offset	QPSK			16QAM			64QAM		
			Low CH	Mid CH	High CH	Low CH	Mid CH	High CH	Low CH	Mid CH	High CH
			55290 3555 MHz	55990 3625 MHz	56690 3695 MHz	55290 3555 MHz	55990 3625 MHz	56690 3695 MHz	55290 3555 MHz	55990 3625 MHz	56690 3695 MHz
48 / 10M	1	0	21.35	21.39	21.20	20.50	20.56	20.59	19.46	19.57	19.52
	1	12	21.25	21.31	21.12	20.49	20.47	20.51	19.35	19.25	19.34
	1	24	21.14	21.16	21.23	20.47	20.57	20.53	19.32	19.41	19.49
	12	0	20.34	20.36	20.38	19.34	19.41	19.39	18.43	18.46	18.54
	12	6	20.31	20.31	20.41	19.47	19.45	19.43	18.53	18.51	18.55
	12	13	20.27	20.26	20.40	19.38	19.36	19.32	18.36	18.41	18.51
	25	0	20.31	20.33	20.29	19.37	19.40	19.43	18.31	18.44	18.48

Band / BW	RB Size	RB Offset	QPSK			16QAM			64QAM		
			Low CH	Mid CH	High CH	Low CH	Mid CH	High CH	Low CH	Mid CH	High CH
			55315 3557.5 MHz	55990 3625 MHz	56665 3692.5 MHz	55315 3557.5 MHz	55990 3625 MHz	56665 3692.5 MHz	55315 3557.5 MHz	55990 3625 MHz	56665 3692.5 MHz
48 / 15M	1	0	21.86	21.23	21.15	20.93	20.47	20.40	19.86	19.22	19.63
	1	12	21.74	21.15	21.41	20.68	20.38	20.29	19.81	19.11	19.32
	1	24	21.66	21.03	21.05	20.54	20.31	20.23	19.96	19.25	19.26
	12	0	20.05	19.61	19.46	19.07	18.64	18.43	18.06	17.68	17.51
	12	6	19.99	19.57	19.44	19.01	18.58	18.46	18.11	17.65	17.48
	12	13	19.94	19.44	19.52	18.93	18.36	18.37	17.94	17.53	17.52
	25	0	18.52	18.11	18.02	17.56	17.20	17.06	16.58	16.14	16.09

Band / BW	RB Size	RB Offset	QPSK			16QAM			64QAM		
			Low CH	Mid CH	High CH	Low CH	Mid CH	High CH	Low CH	Mid CH	High CH
			55340	55990	56640	55340	55990	56640	55340	55990	56640
			3560	3625	3690	3560	3625	3690	3560	3625	3690
			MHz	MHz	MHz	MHz	MHz	MHz	MHz	MHz	MHz
48 / 20M	1	0	21.80	21.19	21.50	20.71	20.22	20.06	19.94	19.54	19.33
	1	12	21.48	21.14	21.29	20.65	20.12	19.98	19.59	19.41	19.04
	1	24	21.45	20.81	20.97	20.54	20.20	19.97	19.71	19.45	19.29
	12	0	19.99	19.55	19.47	18.98	18.59	18.51	18.01	17.63	17.54
	12	6	19.86	19.48	19.50	18.91	18.51	18.50	17.96	17.58	17.59
	12	13	19.81	19.46	19.47	18.89	18.49	18.54	17.92	17.52	17.57
	25	0	17.34	16.98	16.96	16.35	15.96	16.01	15.39	15.07	14.99

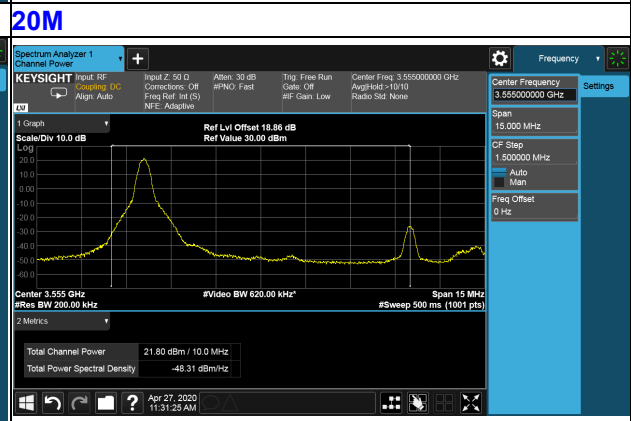
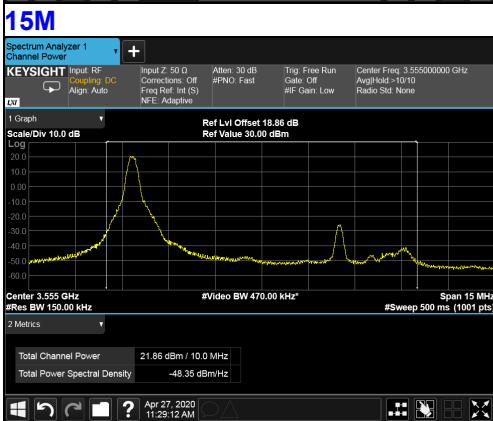
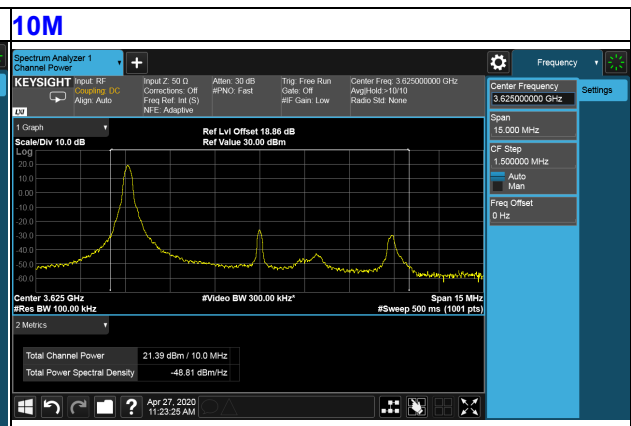
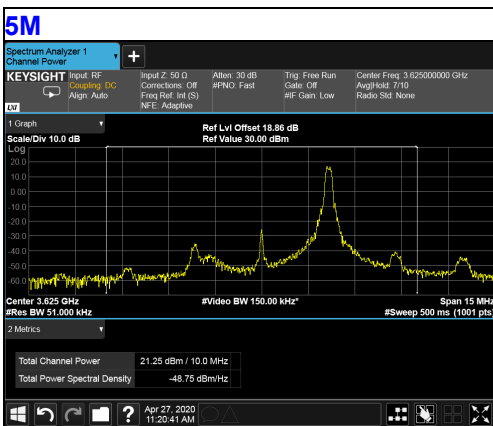

EIRP Power(dBm) / Per 10M

Band / BW	RB Size	RB Offset	QPSK			16QAM			64QAM		
			Low CH	Mid CH	High CH	Low CH	Mid CH	High CH	Low CH	Mid CH	High CH
			55265	55990	56715	55265	55990	56715	55265	55990	56715
			3552.5	3625	3697.5	3552.5	3625	3697.5	3552.5	3625	3697.5
			MHz	MHz	MHz	MHz	MHz	MHz	MHz	MHz	MHz
48 / 5M	1	0	22.10	22.13	22.11	21.36	21.42	21.50	20.18	20.30	20.31
	1	12	22.03	22.09	22.04	21.39	21.38	21.46	20.13	20.21	20.24
	1	24	22.16	22.17	22.15	21.42	21.46	21.48	20.19	20.20	20.29
	12	0	21.20	21.23	21.31	20.28	20.29	20.28	19.36	19.34	19.38
	12	6	21.23	21.26	21.24	20.26	20.30	20.31	19.30	19.32	19.41
	12	13	21.14	21.21	21.30	20.24	20.32	20.28	19.33	19.36	19.38
	25	0	21.23	21.30	21.27	20.31	20.30	20.36	19.30	19.34	19.36

Band / BW	RB Size	RB Offset	QPSK			16QAM			64QAM		
			Low CH	Mid CH	High CH	Low CH	Mid CH	High CH	Low CH	Mid CH	High CH
			55290	55990	56690	55290	55990	56690	55290	55990	56690
			3555	3625	3695	3555	3625	3695	3555	3625	3695
			MHz	MHz	MHz	MHz	MHz	MHz	MHz	MHz	MHz
48 / 10M	1	0	22.27	22.31	22.12	21.42	21.48	21.51	20.38	20.49	20.44
	1	12	22.17	22.23	22.04	21.41	21.39	21.43	20.27	20.17	20.26
	1	24	22.06	22.08	22.15	21.39	21.49	21.45	20.24	20.33	20.41
	12	0	21.26	21.28	21.30	20.26	20.33	20.31	19.35	19.38	19.46
	12	6	21.23	21.23	21.33	20.39	20.37	20.35	19.45	19.43	19.47
	12	13	21.19	21.18	21.32	20.30	20.28	20.24	19.28	19.33	19.43
	25	0	21.23	21.25	21.21	20.29	20.32	20.35	19.23	19.36	19.40

Band / BW	RB Size	RB Offset	QPSK			16QAM			64QAM		
			Low CH	Mid CH	High CH	Low CH	Mid CH	High CH	Low CH	Mid CH	High CH
			55315	55990	56665	55315	55990	56665	55315	55990	56665
			3557.5	3625	3692.5	3557.5	3625	3692.5	3557.5	3625	3692.5
			MHz	MHz	MHz	MHz	MHz	MHz	MHz	MHz	MHz
48 / 15M	1	0	22.78	22.15	22.07	21.85	21.39	21.32	20.78	20.14	20.55
	1	12	22.66	22.07	22.33	21.60	21.30	21.21	20.73	20.03	20.24
	1	24	22.58	21.95	21.97	21.46	21.23	21.15	20.88	20.17	20.18
	12	0	20.97	20.53	20.38	19.99	19.56	19.35	18.98	18.60	18.43
	12	6	20.91	20.49	20.36	19.93	19.50	19.38	19.03	18.57	18.40
	12	13	20.86	20.36	20.44	19.85	19.28	19.29	18.86	18.45	18.44
	25	0	19.44	19.03	18.94	18.48	18.12	17.98	17.50	17.06	17.01

*EIRP = Conducted + antenna gain(0.92dBi).

Band / BW	RB Size	RB Offset	QPSK			16QAM			64QAM		
			Low CH	Mid CH	High CH	Low CH	Mid CH	High CH	Low CH	Mid CH	High CH
			55340	55990	56640	55340	55990	56640	55340	55990	56640
			3560 MHz	3625 MHz	3690 MHz	3560 MHz	3625 MHz	3690 MHz	3560 MHz	3625 MHz	3690 MHz
48 / 20M	1	0	22.72	22.11	22.42	21.63	21.14	20.98	20.86	20.46	20.25
	1	12	22.40	22.06	22.21	21.57	21.04	20.90	20.51	20.33	19.96
	1	24	22.37	21.73	21.89	21.46	21.12	20.89	20.63	20.37	20.21
	12	0	20.91	20.47	20.39	19.90	19.51	19.43	18.93	18.55	18.46
	12	6	20.78	20.40	20.42	19.83	19.43	19.42	18.88	18.50	18.51
	12	13	20.73	20.38	20.39	19.81	19.41	19.46	18.84	18.44	18.49
	25	0	18.26	17.90	17.88	17.27	16.88	16.93	16.31	15.99	15.91

*EIRP = Conducted + antenna gain(0.92dBi).

Conducted Output Power (dBm) / Full Power

Band / BW	RB Size	RB Offset	QPSK			16QAM			64QAM		
			Low CH	Mid CH	High CH	Low CH	Mid CH	High CH	Low CH	Mid CH	High CH
			55265	55990	56715	55265	55990	56715	55265	55990	56715
			3552.5	3625	3697.5	3552.5	3625	3697.5	3552.5	3625	3697.5
			MHz	MHz	MHz	MHz	MHz	MHz	MHz	MHz	MHz
48 / 5M	1	0	21.18	21.21	21.19	20.44	20.50	20.58	19.26	19.38	19.39
	1	12	21.11	21.17	21.12	20.47	20.46	20.54	19.21	19.29	19.32
	1	24	21.24	21.25	21.23	20.50	20.54	20.56	19.27	19.28	19.37
	12	0	20.28	20.31	20.39	19.36	19.37	19.36	18.44	18.42	18.46
	12	6	20.31	20.34	20.32	19.34	19.38	19.39	18.38	18.40	18.49
	12	13	20.22	20.29	20.38	19.32	19.40	19.36	18.41	18.44	18.46
	25	0	20.31	20.38	20.35	19.39	19.38	19.44	18.38	18.42	18.44

Band / BW	RB Size	RB Offset	QPSK			16QAM			64QAM		
			Low CH	Mid CH	High CH	Low CH	Mid CH	High CH	Low CH	Mid CH	High CH
			55290	55990	56690	55290	55990	56690	55290	55990	56690
			3555	3625	3695	3555	3625	3695	3555	3625	3695
			MHz	MHz	MHz	MHz	MHz	MHz	MHz	MHz	MHz
48 / 10M	1	0	21.35	21.39	21.20	20.50	20.56	20.59	19.46	19.57	19.52
	1	12	21.25	21.31	21.12	20.49	20.47	20.51	19.35	19.25	19.34
	1	24	21.14	21.16	21.23	20.47	20.57	20.53	19.32	19.41	19.49
	12	0	20.34	20.36	20.38	19.34	19.41	19.39	18.43	18.46	18.54
	12	6	20.31	20.31	20.41	19.47	19.45	19.43	18.53	18.51	18.55
	12	13	20.27	20.26	20.40	19.38	19.36	19.32	18.36	18.41	18.51
	25	0	20.31	20.33	20.29	19.37	19.40	19.43	18.31	18.44	18.48

Band / BW	RB Size	RB Offset	QPSK			16QAM			64QAM		
			Low CH	Mid CH	High CH	Low CH	Mid CH	High CH	Low CH	Mid CH	High CH
			55315	55990	56665	55315	55990	56665	55315	55990	56665
			3557.5	3625	3692.5	3557.5	3625	3692.5	3557.5	3625	3692.5
			MHz	MHz	MHz	MHz	MHz	MHz	MHz	MHz	MHz
48 / 15M	1	0	21.88	21.89	21.86	21.13	21.26	21.27	19.97	20.00	20.02
	1	12	21.78	21.86	21.83	21.10	21.23	21.19	19.83	19.93	19.94
	1	24	21.73	21.83	21.88	21.12	21.21	21.22	19.89	20.01	20.14
	12	0	20.98	21.09	21.06	20.01	20.09	20.10	19.01	19.15	19.17
	12	6	20.97	21.02	21.11	19.99	20.06	20.05	18.96	19.06	19.14
	12	13	20.94	20.96	21.05	19.93	20.00	20.08	18.97	18.98	19.16
	25	0	20.88	21.03	21.06	19.98	20.02	20.15	18.96	19.04	19.12

Band / BW	RB Size	RB Offset	QPSK			16QAM			64QAM		
			Low CH	Mid CH	High CH	Low CH	Mid CH	High CH	Low CH	Mid CH	High CH
			55340	55990	56640	55340	55990	56640	55340	55990	56640
			3560	3625	3690	3560	3625	3690	3560	3625	3690
			MHz	MHz	MHz	MHz	MHz	MHz	MHz	MHz	MHz
48 / 20M	1	0	21.85	21.98	21.91	21.27	21.37	21.32	19.96	20.13	20.06
	1	12	21.77	21.95	21.86	21.11	21.26	21.18	19.87	19.98	19.92
	1	24	21.80	22.00	21.82	21.14	21.32	21.21	19.84	20.07	20.04
	12	0	20.99	21.09	21.06	20.09	20.24	20.12	19.08	19.17	19.21
	12	6	20.90	21.02	21.07	20.02	20.14	20.15	18.97	19.13	19.18
	12	13	20.86	21.08	21.09	19.99	20.12	20.08	19.02	19.16	19.19
	25	0	20.93	20.97	21.06	19.97	20.13	20.13	18.97	19.15	19.11

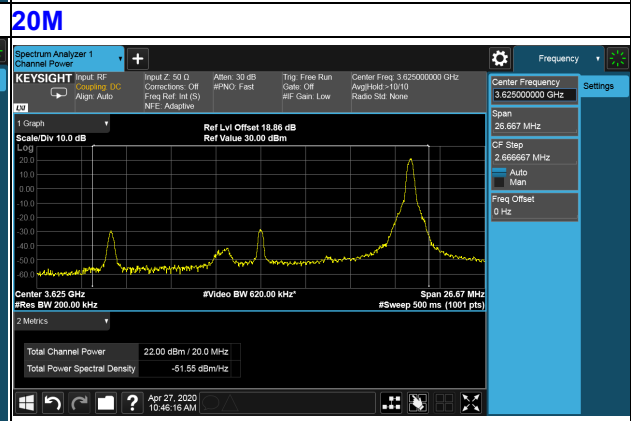
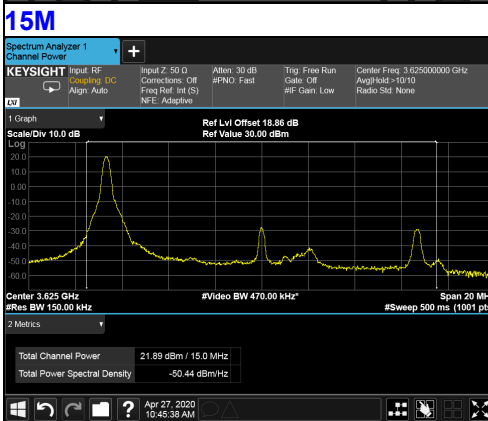
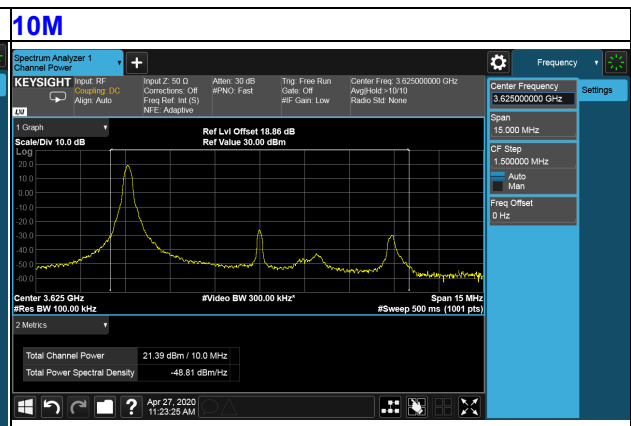
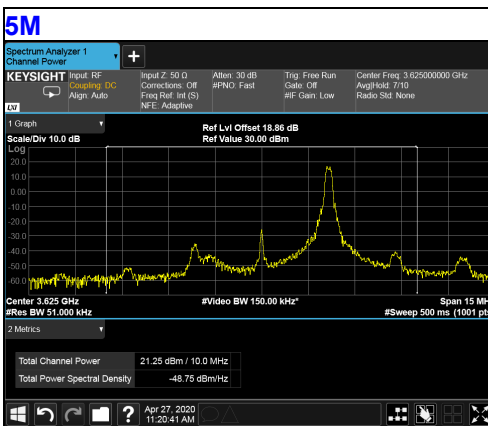

EIRP Power (dBm) / Full Power

Band / BW	RB Size	RB Offset	QPSK			16QAM			64QAM		
			Low CH	Mid CH	High CH	Low CH	Mid CH	High CH	Low CH	Mid CH	High CH
			55265	55990	56715	55265	55990	56715	55265	55990	56715
			3552.5	3625	3697.5	3552.5	3625	3697.5	3552.5	3625	3697.5
			MHz	MHz	MHz	MHz	MHz	MHz	MHz	MHz	MHz
48 / 5M	1	0	22.10	22.13	22.11	21.36	21.42	21.50	20.18	20.30	20.31
	1	12	22.03	22.09	22.04	21.39	21.38	21.46	20.13	20.21	20.24
	1	24	22.16	22.17	22.15	21.42	21.46	21.48	20.19	20.20	20.29
	12	0	21.20	21.23	21.31	20.28	20.29	20.28	19.36	19.34	19.38
	12	6	21.23	21.26	21.24	20.26	20.30	20.31	19.30	19.32	19.41
	12	13	21.14	21.21	21.30	20.24	20.32	20.28	19.33	19.36	19.38
	25	0	21.23	21.30	21.27	20.31	20.30	20.36	19.30	19.34	19.36

Band / BW	RB Size	RB Offset	QPSK			16QAM			64QAM		
			Low CH	Mid CH	High CH	Low CH	Mid CH	High CH	Low CH	Mid CH	High CH
			55290	55990	56690	55290	55990	56690	55290	55990	56690
			3555	3625	3695	3555	3625	3695	3555	3625	3695
			MHz	MHz	MHz	MHz	MHz	MHz	MHz	MHz	MHz
48 / 10M	1	0	22.27	22.31	22.12	21.42	21.48	21.51	20.38	20.49	20.44
	1	12	22.17	22.23	22.04	21.41	21.39	21.43	20.27	20.17	20.26
	1	24	22.06	22.08	22.15	21.39	21.49	21.45	20.24	20.33	20.41
	12	0	21.26	21.28	21.30	20.26	20.33	20.31	19.35	19.38	19.46
	12	6	21.23	21.23	21.33	20.39	20.37	20.35	19.45	19.43	19.47
	12	13	21.19	21.18	21.32	20.30	20.28	20.24	19.28	19.33	19.43
	25	0	21.23	21.25	21.21	20.29	20.32	20.35	19.23	19.36	19.40

Band / BW	RB Size	RB Offset	QPSK			16QAM			64QAM		
			Low CH	Mid CH	High CH	Low CH	Mid CH	High CH	Low CH	Mid CH	High CH
			55315	55990	56665	55315	55990	56665	55315	55990	56665
			3557.5	3625	3692.5	3557.5	3625	3692.5	3557.5	3625	3692.5
			MHz	MHz	MHz	MHz	MHz	MHz	MHz	MHz	MHz
48 / 15M	1	0	22.80	22.81	22.78	22.05	22.18	22.19	20.89	20.92	20.94
	1	12	22.70	22.78	22.75	22.02	22.15	22.11	20.75	20.85	20.86
	1	24	22.65	22.75	22.80	22.04	22.13	22.14	20.81	20.93	21.06
	12	0	21.90	22.01	21.98	20.93	21.01	21.02	19.93	20.07	20.09
	12	6	21.89	21.94	22.03	20.91	20.98	20.97	19.88	19.98	20.06
	12	13	21.86	21.88	21.97	20.85	20.92	21.00	19.89	19.90	20.08
	25	0	21.80	21.95	21.98	20.90	20.94	21.07	19.88	19.96	20.04

*EIRP = Conducted + antenna gain(0.92dBi).

Band / BW	RB Size	RB Offset	QPSK			16QAM			64QAM		
			Low CH	Mid CH	High CH	Low CH	Mid CH	High CH	Low CH	Mid CH	High CH
			55340	55990	56640	55340	55990	56640	55340	55990	56640
			3560	3625	3690	3560	3625	3690	3560	3625	3690
			MHz	MHz	MHz	MHz	MHz	MHz	MHz	MHz	MHz
48 / 20M	1	0	22.77	22.90	22.83	22.19	22.29	22.24	20.88	21.05	20.98
	1	12	22.69	22.87	22.78	22.03	22.18	22.10	20.79	20.90	20.84
	1	24	22.72	22.92	22.74	22.06	22.24	22.13	20.76	20.99	20.96
	12	0	21.91	22.01	21.98	21.01	21.16	21.04	20.00	20.09	20.13
	12	6	21.82	21.94	21.99	20.94	21.06	21.07	19.89	20.05	20.10
	12	13	21.78	22.00	22.01	20.91	21.04	21.00	19.94	20.08	20.11
	25	0	21.85	21.89	21.98	20.89	21.05	21.05	19.89	20.07	20.03

*EIRP = Conducted + antenna gain(0.92dBi).

4.2 Modulation Characteristics Measurement

4.2.1 Limits of Modulation Characteristics

N/A

4.2.2 Test Procedure

Connect the EUT to Communication Simulator via the antenna connector, The frequency band is set as EUT supported Modulation and Channels, the EUT output is matched with 50 ohm load, the waveform quality and constellation of the EUT was tested.

4.2.3 Test Setup



4.2.4 Test Results

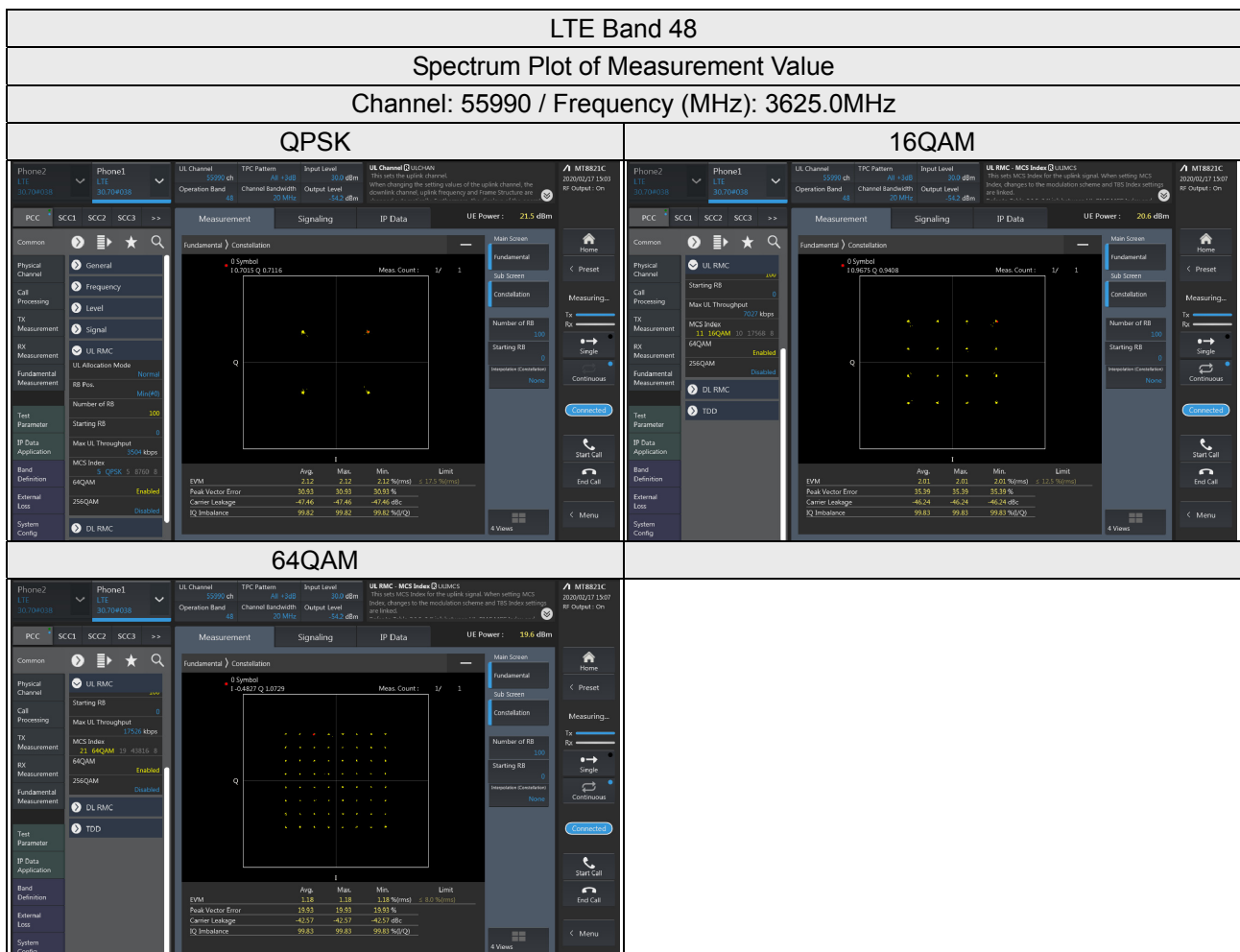

4.3 Frequency Stability Measurement

4.3.1 Limits of Frequency Stability Measurement

The frequency stability shall be sufficient to ensure that the fundamental emission stays within the authorized frequency band.

4.3.2 Test Procedure

- a. Device is placed at the oven room. The oven room could control the temperatures and humidity. Power warm up is at least 15 min and power applied should perform before recording frequency error.
- b. EUT is connected the external power supply to control the DC input power. The test voltage range is from minimum to maximum working voltage. Each step shall be record the frequency error rate.
- c. The temperature range step is 10 degrees in this test items. All temperature levels shall be hold the ± 0.5 °C during the measurement testing. The each temperature step shall be at least 0.5 hours, consider the EUT could be test under the stability condition.

NOTE: The frequency error was recorded frequency error from the communication simulator.

4.3.3 Test Setup

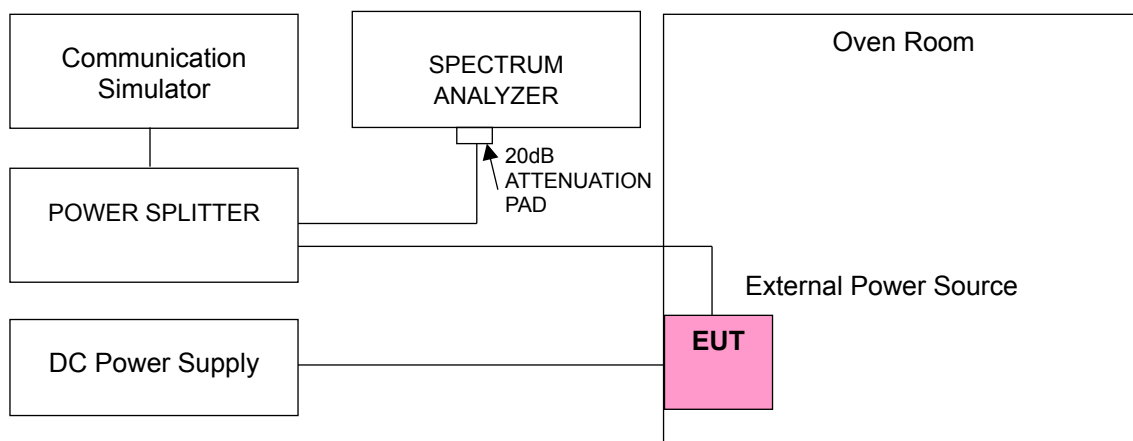

4.3.4 Test Results

Frequency Error vs. Voltage

Voltage (Volts)	LTE Band 48			
	Channel Bandwidth: 5 MHz			
	Low Channel		High Channel	
	Frequency (MHz)	Frequency Error (ppm)	Frequency (MHz)	Frequency Error (ppm)
4.25	3552.500002	0.001	3697.500004	0.001
5	3552.500004	0.001	3697.500003	0.001
5.75	3552.500004	0.001	3697.500004	0.001

Note: The applicant defined the normal working voltage is from 4.25Vdc to 5.75Vdc.

Frequency Error vs. Temperature

Temp. (°C)	LTE Band 48			
	Channel Bandwidth: 5 MHz			
	Low Channel		High Channel	
	Frequency (MHz)	Frequency Error (ppm)	Frequency (MHz)	Frequency Error (ppm)
-30	3552.500003	0.001	3697.500003	0.001
-20	3552.500004	0.001	3697.500001	0.000
-10	3552.500001	0.000	3697.500001	0.000
0	3552.500003	0.001	3697.500001	0.000
10	3552.500004	0.001	3697.500004	0.001
20	3552.499997	-0.001	3697.499998	-0.001
30	3552.499997	-0.001	3697.499998	-0.001
40	3552.499996	-0.001	3697.499999	0.000
50	3552.499998	0.000	3697.499998	0.000

Frequency Error vs. Voltage

Voltage (Volts)	LTE Band 48			
	Channel Bandwidth: 10 MHz			
	Low Channel		High Channel	
	Frequency (MHz)	Frequency Error (ppm)	Frequency (MHz)	Frequency Error (ppm)
4.25	3555.000002	0.000	3695.000004	0.001
5	3555.000004	0.001	3695.000003	0.001
5.75	3555.000003	0.001	3695.000003	0.001

Note: The applicant defined the normal working voltage is from 4.25Vdc to 5.75Vdc.

Frequency Error vs. Temperature

Temp. (°C)	LTE Band 48			
	Channel Bandwidth: 10 MHz			
	Low Channel		High Channel	
	Frequency (MHz)	Frequency Error (ppm)	Frequency (MHz)	Frequency Error (ppm)
-30	3555.000002	0.001	3695.000004	0.001
-20	3555.000002	0.000	3695.000004	0.001
-10	3555.000004	0.001	3695.000001	0.000
0	3555.000002	0.000	3695.000003	0.001
10	3555.000002	0.001	3695.000003	0.001
20	3554.999999	0.000	3694.999999	0.000
30	3554.999998	-0.001	3694.999997	-0.001
40	3554.999999	0.000	3694.999996	-0.001
50	3554.999999	0.000	3694.999998	-0.001

Frequency Error vs. Voltage

Voltage (Volts)	LTE Band 48			
	Channel Bandwidth: 15 MHz			
	Low Channel		High Channel	
	Frequency (MHz)	Frequency Error (ppm)	Frequency (MHz)	Frequency Error (ppm)
4.25	3557.500001	0.000	3692.500004	0.001
5	3557.500003	0.001	3692.500001	0.000
5.75	3557.500002	0.001	3692.500001	0.000

Note: The applicant defined the normal working voltage is from 4.25Vdc to 5.75Vdc.

Frequency Error vs. Temperature

Temp. (°C)	LTE Band 48			
	Channel Bandwidth: 15 MHz			
	Low Channel		High Channel	
	Frequency (MHz)	Frequency Error (ppm)	Frequency (MHz)	Frequency Error (ppm)
-30	3557.500003	0.001	3692.500002	0.001
-20	3557.500002	0.001	3692.500003	0.001
-10	3557.500004	0.001	3692.500002	0.000
0	3557.500003	0.001	3692.500003	0.001
10	3557.500003	0.001	3692.500001	0.000
20	3557.499996	-0.001	3692.499996	-0.001
30	3557.499997	-0.001	3692.499999	0.000
40	3557.499996	-0.001	3692.499999	0.000
50	3557.499997	-0.001	3692.499996	-0.001

Frequency Error vs. Voltage

Voltage (Volts)	LTE Band 48			
	Channel Bandwidth: 20 MHz			
	Low Channel		High Channel	
	Frequency (MHz)	Frequency Error (ppm)	Frequency (MHz)	Frequency Error (ppm)
4.25	3560.000002	0.001	3690.000001	0.000
5	3560.000001	0.000	3690.000003	0.001
5.75	3560.000003	0.001	3690.000002	0.001

Note: The applicant defined the normal working voltage is from 4.25Vdc to 5.75Vdc.

Frequency Error vs. Temperature

Temp. (°C)	LTE Band 48			
	Channel Bandwidth: 20 MHz			
	Low Channel		High Channel	
	Frequency (MHz)	Frequency Error (ppm)	Frequency (MHz)	Frequency Error (ppm)
-30	3560.000003	0.001	3690.000002	0.000
-20	3560.000004	0.001	3690.000004	0.001
-10	3560.000002	0.001	3690.000004	0.001
0	3560.000003	0.001	3690.000003	0.001
10	3560.000004	0.001	3690.000002	0.001
20	3559.999997	-0.001	3689.999996	-0.001
30	3559.999999	0.000	3689.999997	-0.001
40	3559.999998	-0.001	3689.999999	0.000
50	3559.999998	-0.001	3689.999998	0.000

4.4 Emission Bandwidth Measurement

4.4.1 Emission Bandwidth Measurement

Reference only

4.4.2 Test Setup

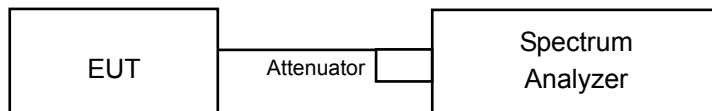

4.4.3 Test Instruments

Refer to section 4.1.3 to get information of above instrument.

4.4.4 Test Procedure

Occupied Bandwidth:

All measurements were done at low, middle and high operational frequency range. The communication simulator station system controlled a EUT to export maximum output power under transmission mode and specific channel frequency. Use OBW measurement function of Spectrum analyzer to measure 99 % occupied bandwidth.

26dBc Bandwidth:

The transmitter output was connected to the spectrum analyzer through an attenuator. The bandwidth of the fundamental frequency was measured by spectrum analyzer with RBW =51 kHz (5 MHz bandwidth), 100 kHz (10 MHz bandwidth), 150 kHz (15 MHz bandwidth), 200 kHz (20 MHz bandwidth). The emission bandwidth is defined as the width of the signal between two points, one below the carrier center frequency and one above the carrier center frequency, outside of which all emissions are attenuated at least 26 dB below the transmitter power.

4.4.5 Deviation from Test Standard

No deviation.

4.4.6 EUT Operating Conditions

The software provided by client to enable the EUT under transmission condition continuously at lowest, middle and highest channel frequencies individually.

4.4.7 Test Result (-26dB Bandwidth)

LTE Band 48

LTE Band 48, Channel Bandwidth 5MHz				
Channel	Frequency (MHz)	26dB Bandwidth (MHz)		
		QPSK	16QAM	64QAM
55265	3552.5	4.79	4.79	4.79
55990	3625.0	4.79	4.80	4.80
56715	3697.5	4.78	4.78	4.81
LTE Band 48, Channel Bandwidth 10MHz				
Channel	Frequency (MHz)	26dB Bandwidth (MHz)		
		QPSK	16QAM	64QAM
55290	3555.0	9.47	9.49	9.51
55990	3625.0	9.48	9.49	9.48
56690	3695.0	9.48	9.49	9.51
LTE Band 48, Channel Bandwidth 15MHz				
Channel	Frequency (MHz)	26dB Bandwidth (MHz)		
		QPSK	16QAM	64QAM
55315	3557.5	14.25	14.23	14.25
55990	3625.0	14.24	14.20	14.25
56665	3692.5	14.23	14.23	14.24
LTE Band 48, Channel Bandwidth 20MHz				
Channel	Frequency (MHz)	26dB Bandwidth (MHz)		
		QPSK	16QAM	64QAM
55340	3560.0	19.04	19.02	19.01
55990	3625.0	19.00	18.98	19.00
56640	3690.0	19.01	19.02	19.03

Spectrum Plot of Worst Value

5MHz / 64QAM

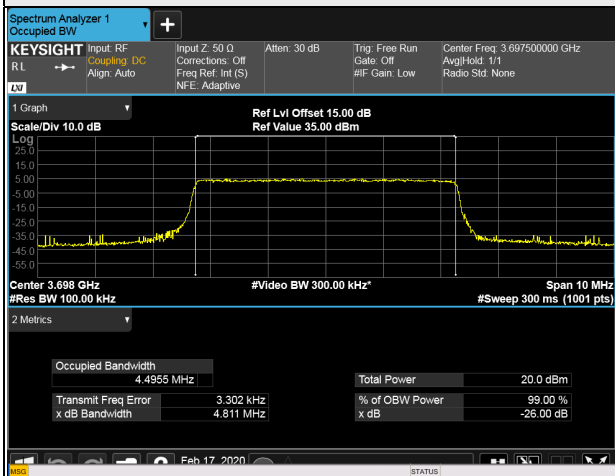

10MHz / 64QAM

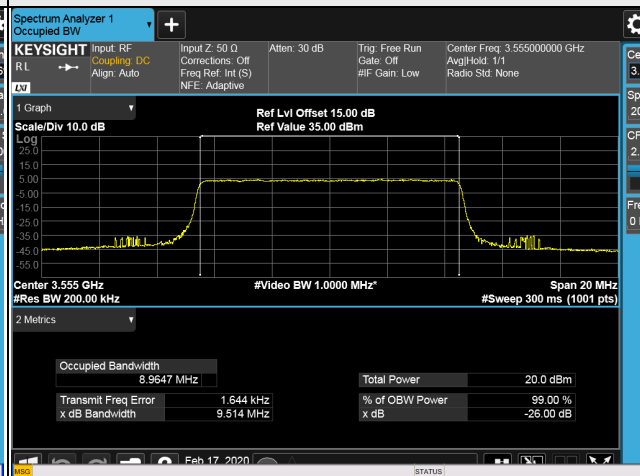

15MHz / 64QAM

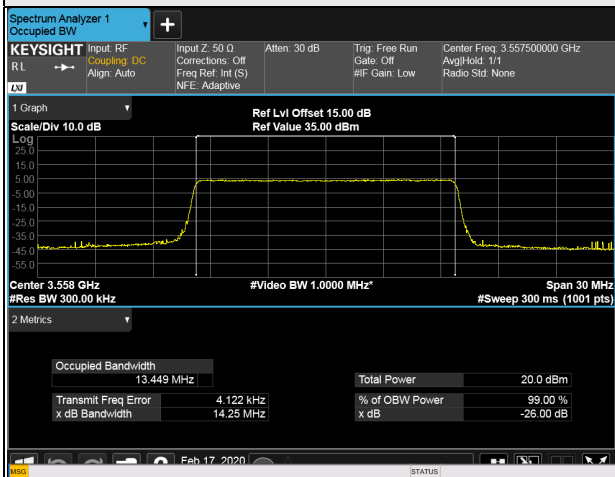

20MHz / QPSK

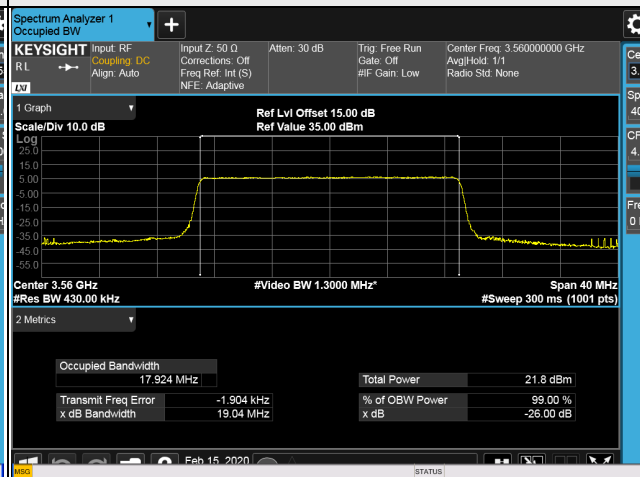

4.4.8 Test Result (Occupied Bandwidth)

LTE Band 48, Channel Bandwidth 5MHz				
Channel	Frequency (MHz)	99% Occupied Bandwidth (MHz)		
		QPSK	16QAM	64QAM
55265	3552.5	4.48	4.49	4.49
55990	3625.0	4.49	4.48	4.49
56715	3697.5	4.49	4.48	4.49
LTE Band 48, Channel Bandwidth 10MHz				
Channel	Frequency (MHz)	99% Occupied Bandwidth (MHz)		
		QPSK	16QAM	64QAM
55290	3555.0	8.95	8.97	8.96
55990	3625.0	8.96	8.96	8.96
56690	3695.0	8.95	8.96	8.96
LTE Band 48, Channel Bandwidth 15MHz				
Channel	Frequency (MHz)	99% Occupied Bandwidth (MHz)		
		QPSK	16QAM	64QAM
55315	3557.5	13.46	13.44	13.44
55990	3625.0	13.46	13.44	13.44
56665	3692.5	13.46	13.44	13.44
LTE Band 48, Channel Bandwidth 20MHz				
Channel	Frequency (MHz)	99% Occupied Bandwidth (MHz)		
		QPSK	16QAM	64QAM
55340	3560.0	17.92	17.92	17.93
55990	3625.0	17.92	17.93	17.93
56640	3690.0	17.93	17.91	17.94

Spectrum Plot of Worst Value

5MHz / 64QAM

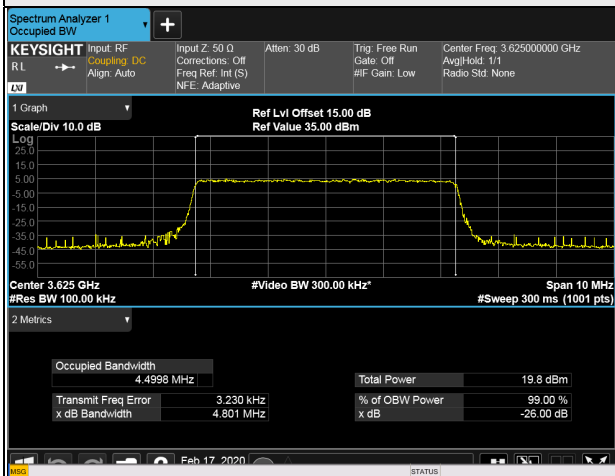

10MHz / 16QAM

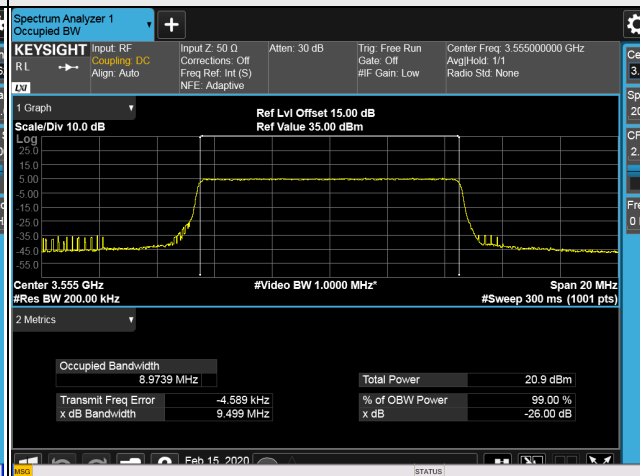

15MHz / QPSK

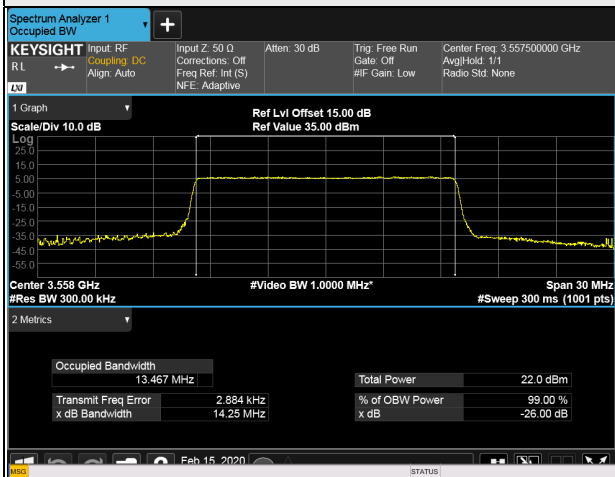

20MHz / 64QAM

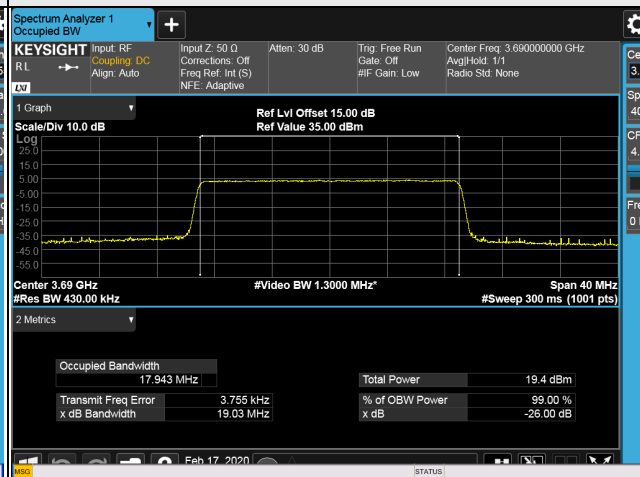

4.5 Peak to Average Ratio Measurement

4.5.1 Limits of Peak to Average Ratio Measurement

In measuring transmissions in this band using an average power technique, the peak to-average ratio (PAR) of the transmission may not exceed 13 dB

4.5.2 Test Setup

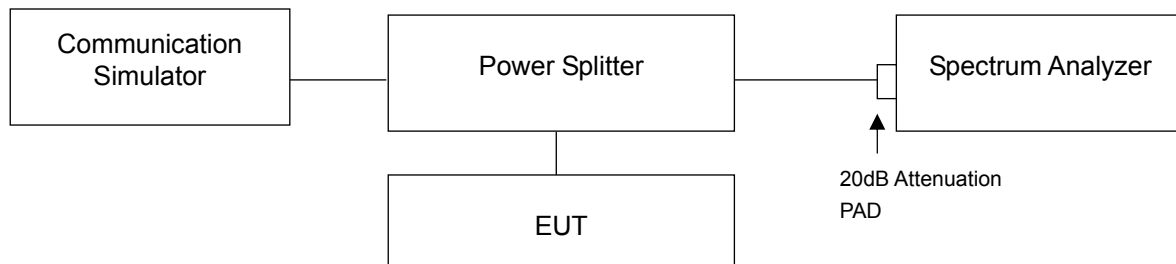

4.5.3 Test Procedures

- Set resolution/measurement bandwidth \geq signal's occupied bandwidth;
- Set the number of counts to a value that stabilizes the measured CCDF curve;
- Record the maximum PAPR level associated with a probability of 0.1%.

4.5.4 Test Results

LTE Band 48

LTE Band 48, Channel Bandwidth 5MHz				
Channel	Frequency (MHz)	Peak To Average Ratio (dB)		
		QPSK	16QAM	64QAM
55265	3552.5	3.69	5.33	6.76
55990	3625.0	3.71	4.94	6.61
56715	3697.5	3.71	5.42	6.82
LTE Band 48, Channel Bandwidth 10MHz				
Channel	Frequency (MHz)	Peak To Average Ratio (dB)		
		QPSK	16QAM	64QAM
55290	3555.0	3.69	5.65	7.11
55990	3625.0	6.34	6.34	7.22
56690	3695.0	3.73	5.64	7.08
LTE Band 48, Channel Bandwidth 15MHz				
Channel	Frequency (MHz)	Peak To Average Ratio (dB)		
		QPSK	16QAM	64QAM
55315	3557.5	4.64	6.13	6.90
55990	3625.0	4.42	5.32	6.93
56665	3692.5	4.24	5.52	6.83
LTE Band 48, Channel Bandwidth 20MHz				
Channel	Frequency (MHz)	Peak To Average Ratio (dB)		
		QPSK	16QAM	64QAM
55340	3560.0	4.64	6.42	7.19
55990	3625.0	4.47	6.07	6.89
56640	3690.0	4.41	5.66	7.09

Spectrum Plot of Worst Value

5MHz / 64QAM

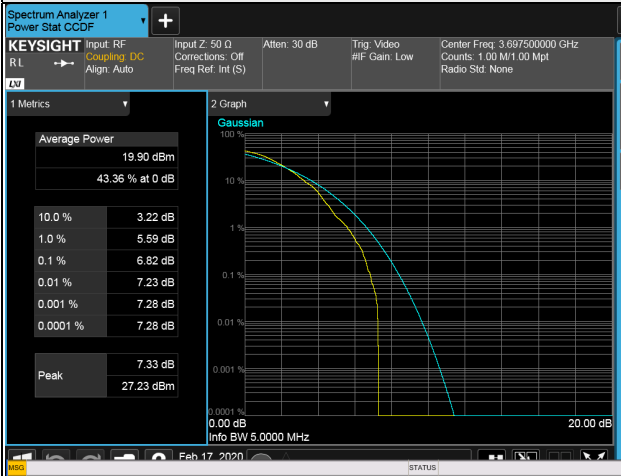

10MHz / 64QAM

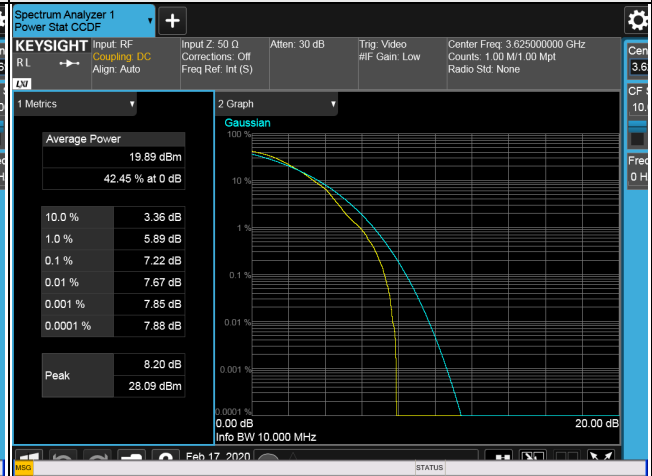

15MHz / 64QAM

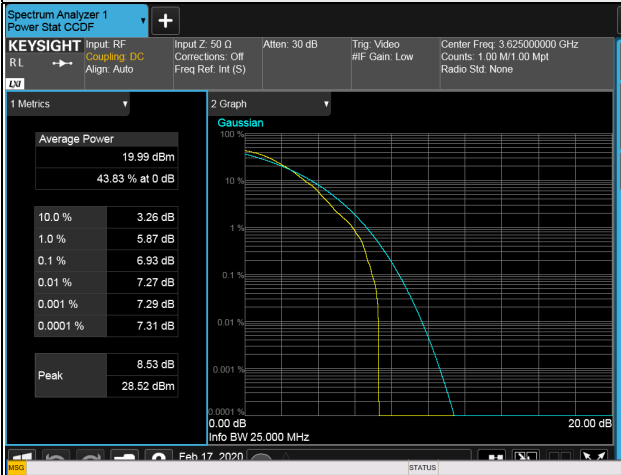

20MHz / 64QAM

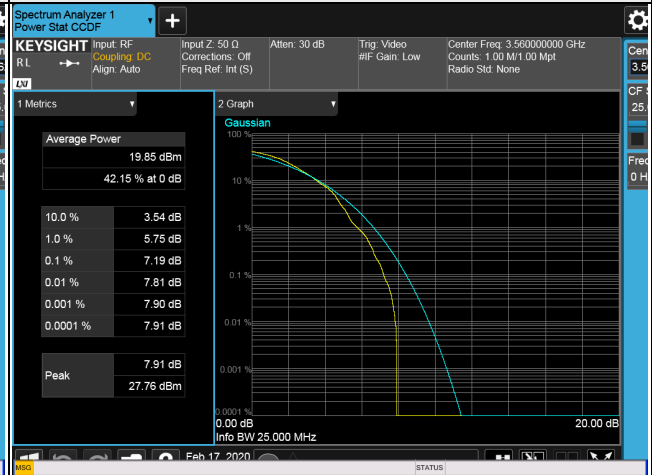

4.6 Conducted Spurious Emissions

4.6.1 Limits of Conducted Spurious Emissions Measurement

Power of any emissions outside the Fundamental	Limit
Within 0-10MHz above the Assigned Channel	-13 dBm/MHz
Within 0-10MHz below the Assigned Channel	
Greater than 0-10MHz above the Assigned Channel	-25 dBm/MHz
Greater than 0-10MHz below the Assigned Channel	
Power of any emission below 3530MHz	-40 dBm/MHz
Power of any emission above 3720MHz	

4.6.2 Test Setup

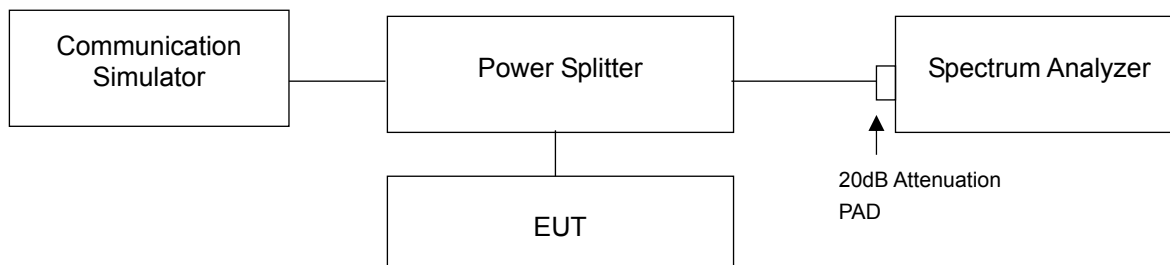

4.6.3 Test Procedure

- The EUT makes a phone call to the communication simulator. All measurements were done at low, middle and high operational frequency range.
- Measuring frequency range is from 9 kHz to 37 GHz. 20dB attenuation pad is connected with spectrum. RBW=1MHz and VBW=3MHz is used for conducted emission measurement.
- Measuring frequency band edge, 20dB attenuation pad is connected with spectrum. 1% of the fundamental emission bandwidth is used for conducted emission measurement.
- For 5MHz channel BW mode, extend the 1% range from 1M to 2M above and below the channel edge and then reduce the limit further by $10 \log(1000/51) = 13\text{dB}$ (i.e. total $-13 + -13 = -26\text{dB}$) to compensate for the integration from 51k to 1M.

4.6.4 Test Results

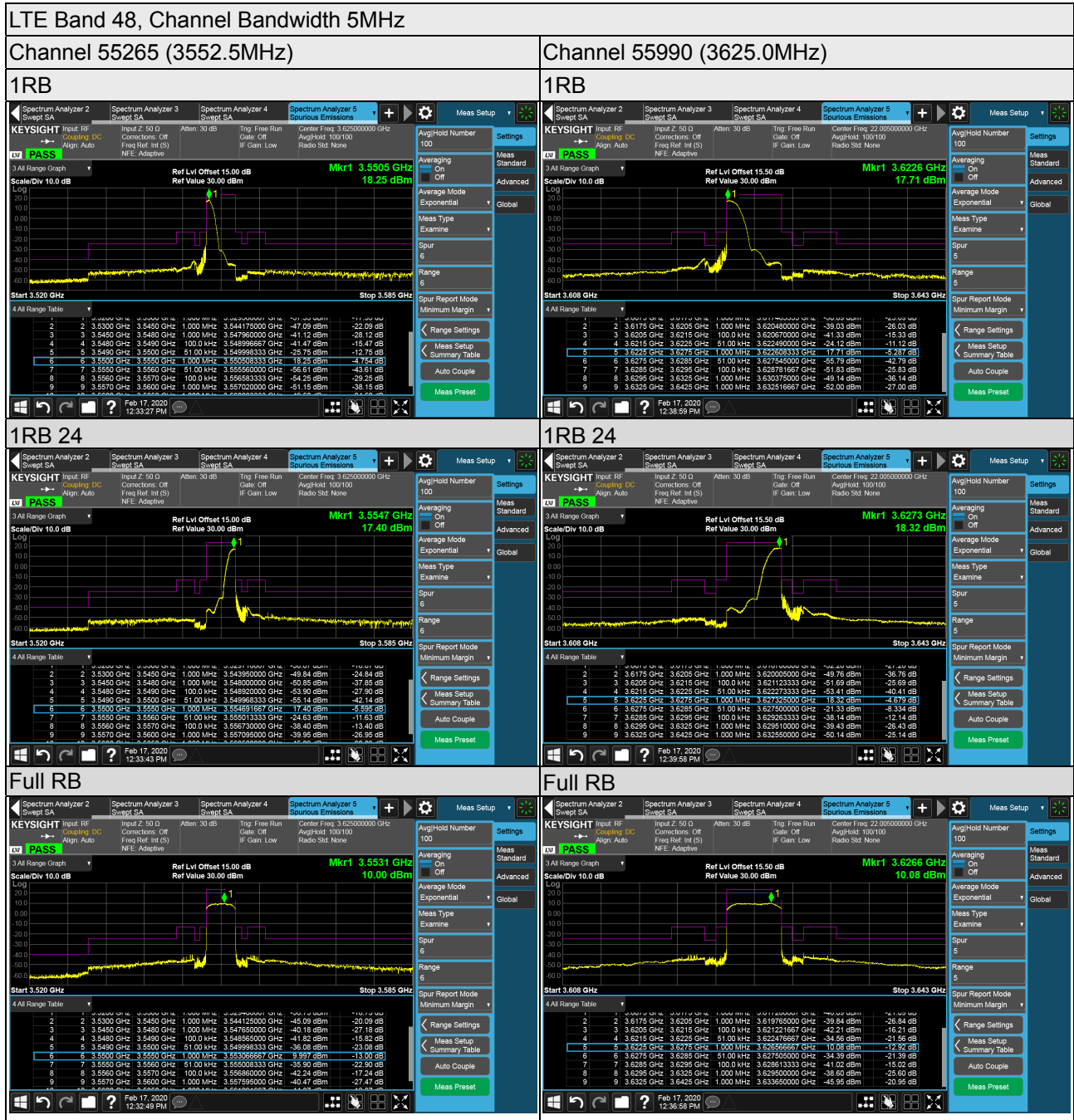

LTE Band 48, Channel Bandwidth 5MHz

Channel 56715 (3697.5MHz)

1RB

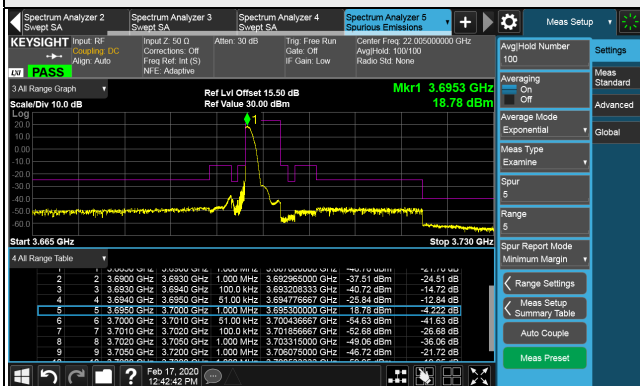

1RB 24

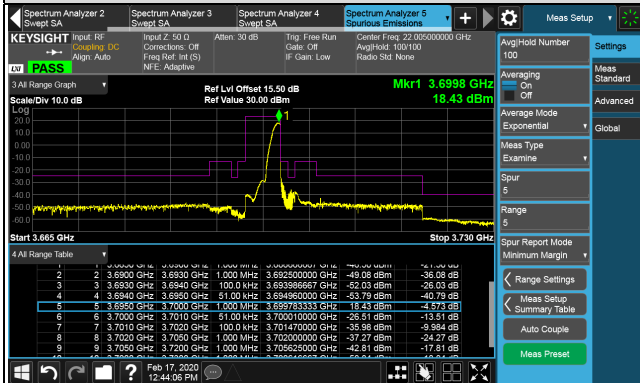

Full RB

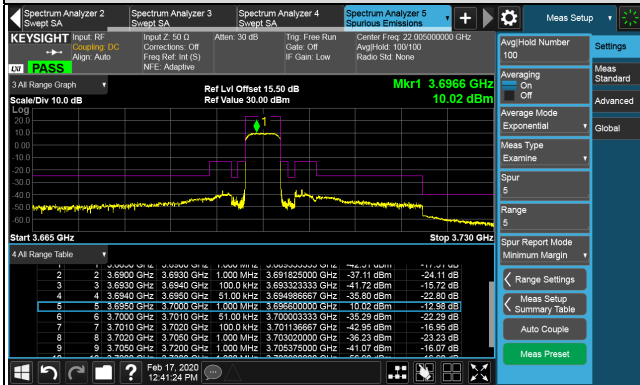

LTE Band 48, Channel Bandwidth 5MHz

Channel 55265 (3552.5MHz)

Frequency Range : 9kHz~1GHz

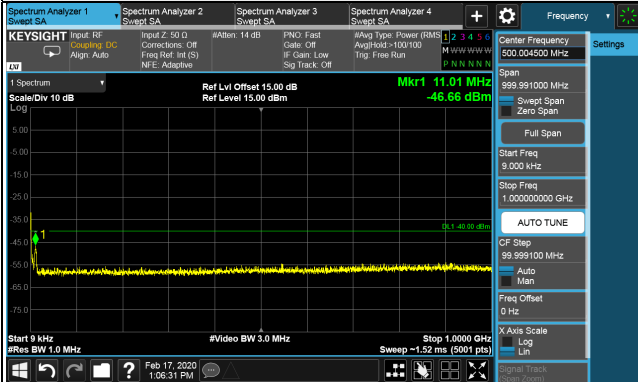

Frequency Range : 1GHz~18GHz

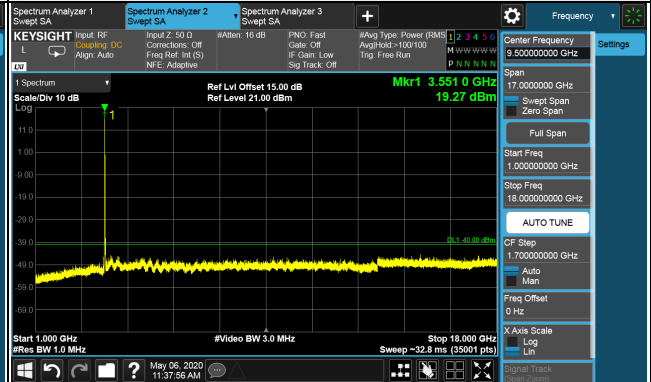

Frequency Range : 18GHz~40GHz

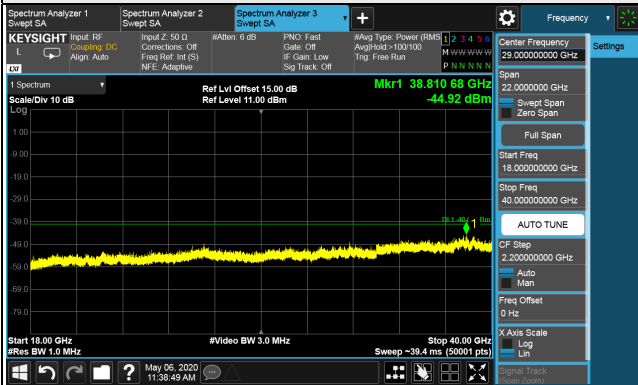

LTE Band 48, Channel Bandwidth 5MHz

Channel 55990 (3625.0MHz)

Frequency Range : 9kHz~1GHz

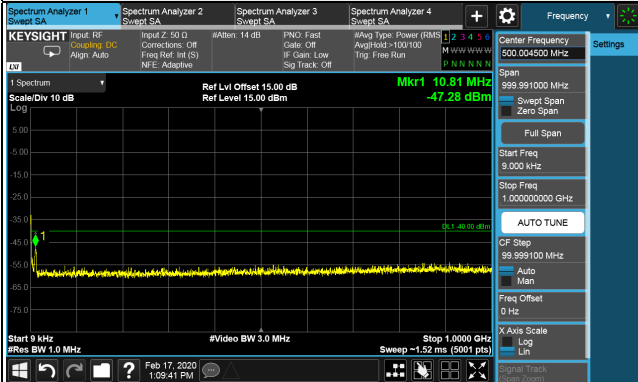

Frequency Range : 1GHz~18GHz

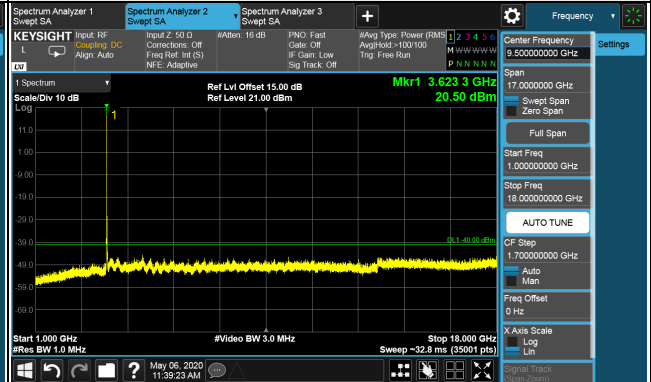

Frequency Range : 18GHz~40GHz

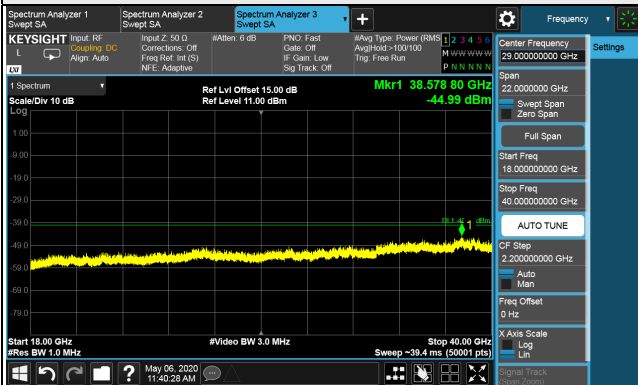

LTE Band 48, Channel Bandwidth 5MHz

Channel 56715 (3697.50MHz)

Frequency Range : 9kHz~1GHz

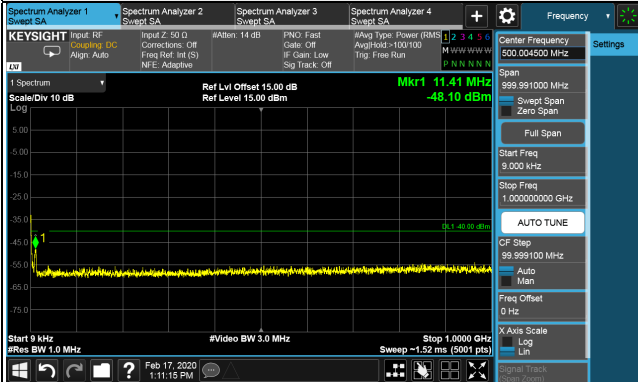

Frequency Range : 1GHz~18GHz

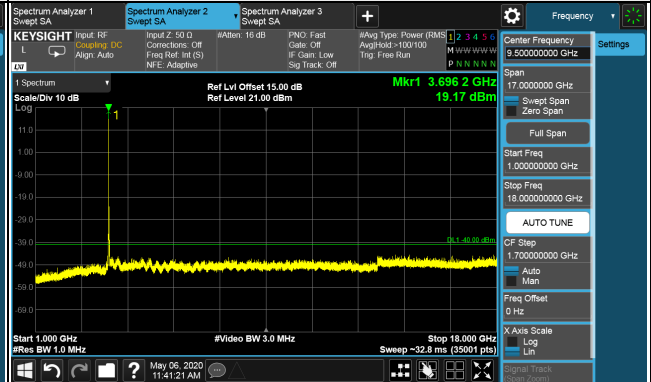

Frequency Range : 18GHz~40GHz

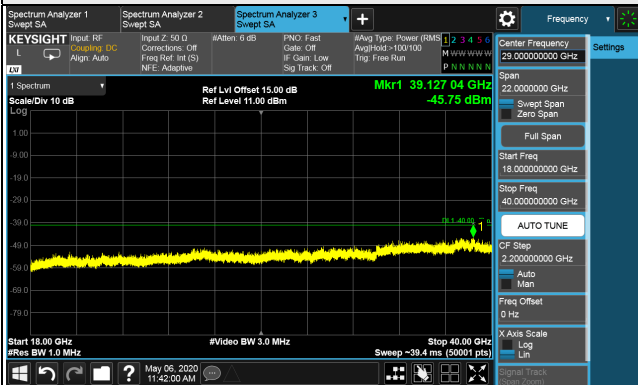

LTE Band 48, Channel Bandwidth 10MHz

Channel 55290 (3555.0MHz)

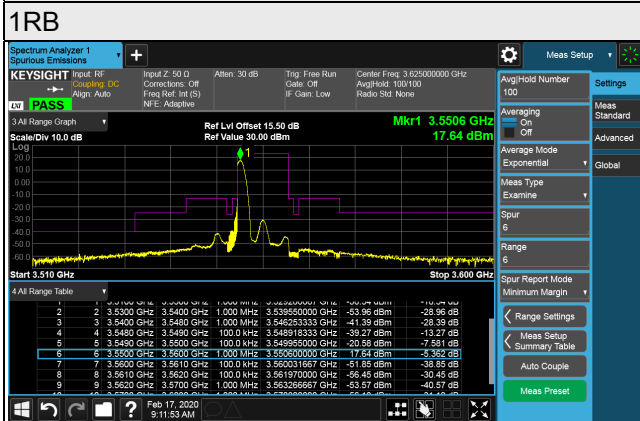

Channel 55990 (3625.0MHz)

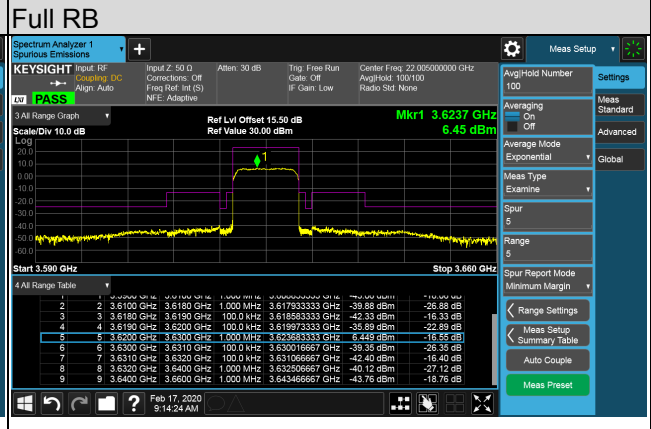
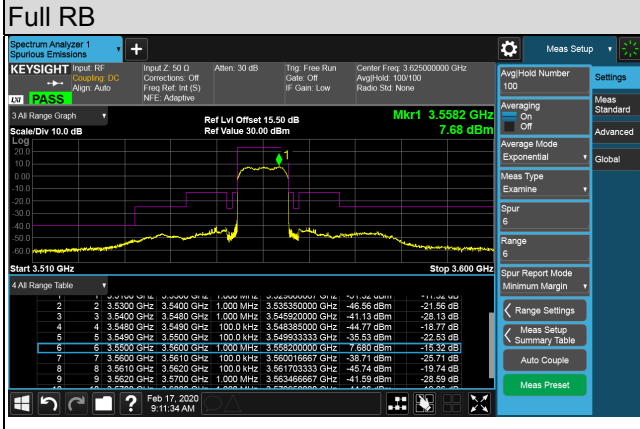
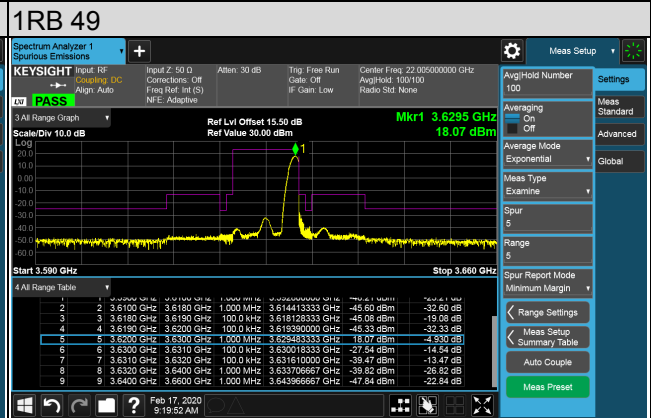
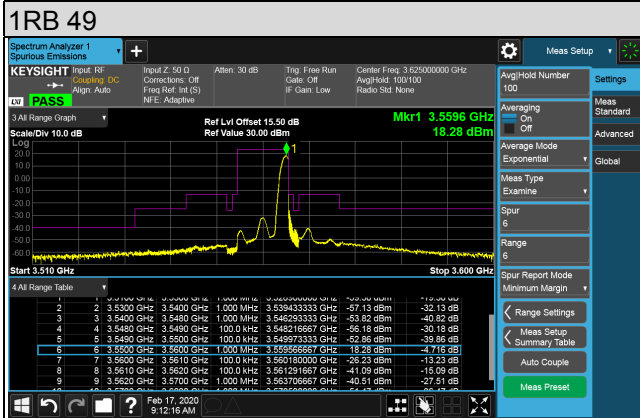
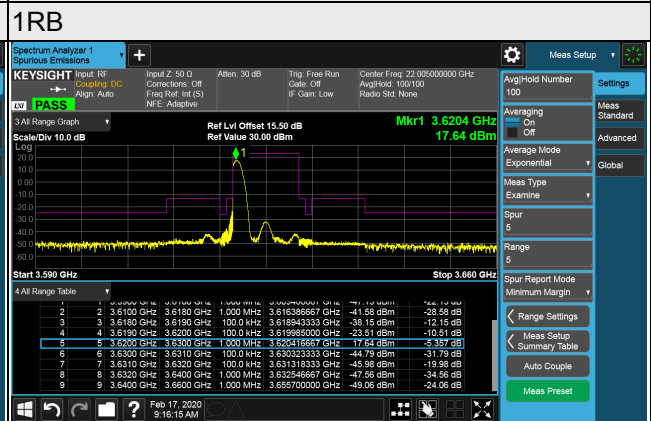

LTE Band 48, Channel Bandwidth 10MHz

Channel 56690 (3695.0MHz)

1RB

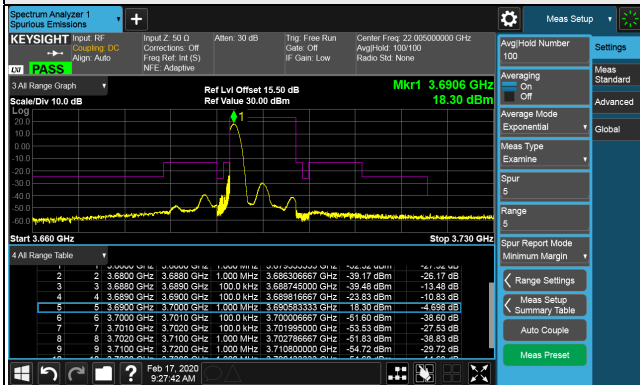

1RB 49

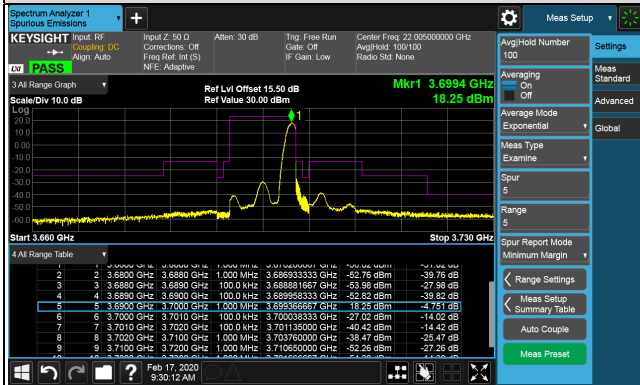

Full RB

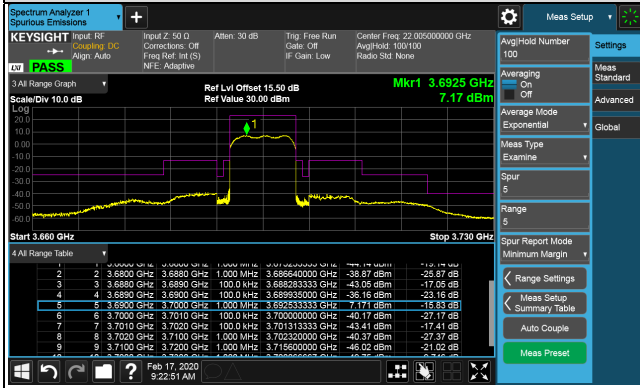

LTE Band 48, Channel Bandwidth 10MHz

Channel 55290 (3555.0MHz)

Frequency Range : 9kHz~1GHz

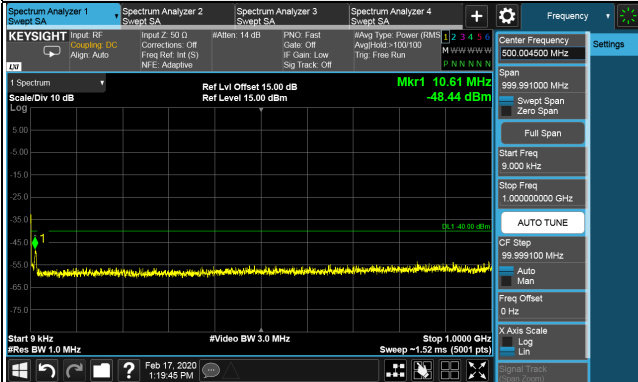

Frequency Range : 1GHz~18GHz

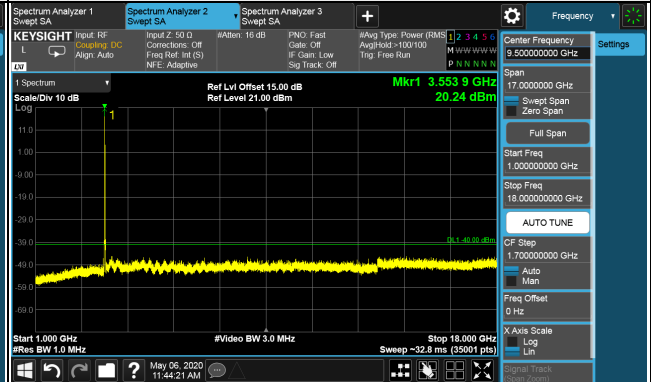

Frequency Range : 18GHz~40GHz

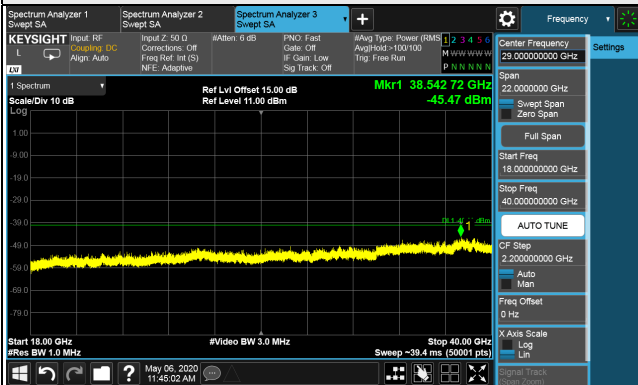

LTE Band 48, Channel Bandwidth 10MHz

Channel 55990 (3625.00MHz)

Frequency Range : 9kHz~1GHz

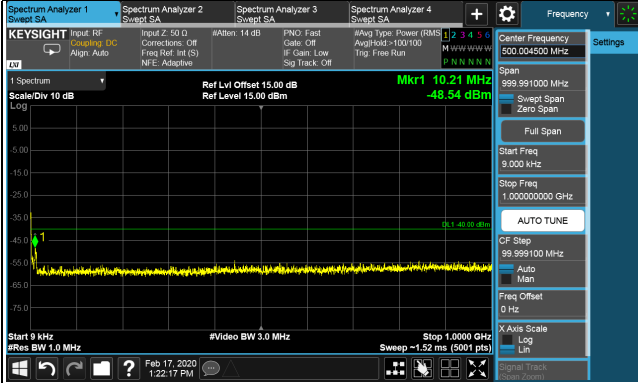

Frequency Range : 1GHz~18GHz

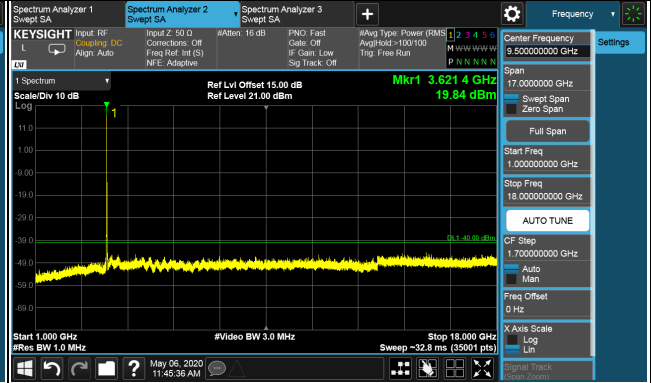

Frequency Range : 18GHz~40GHz

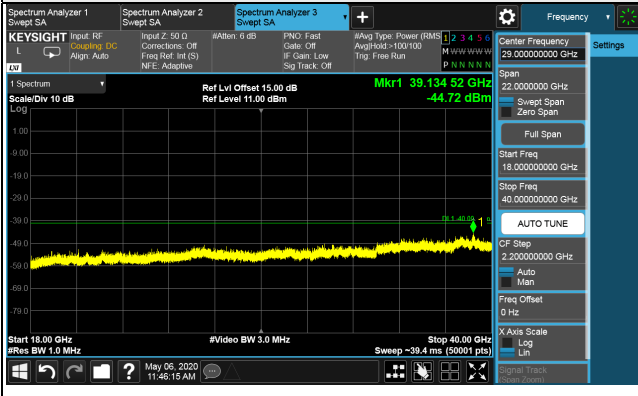

LTE Band 48, Channel Bandwidth 10MHz

Channel 56690 (3695.0MHz)

Frequency Range : 9kHz~1GHz

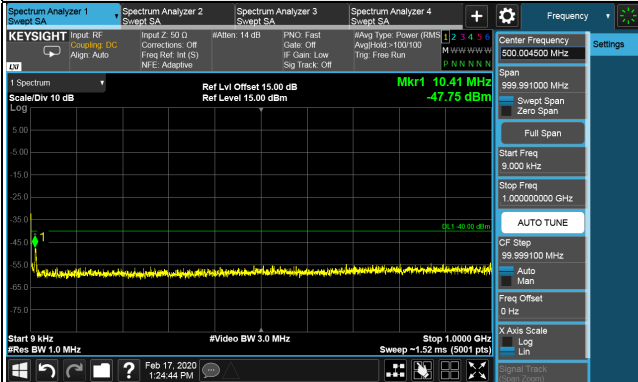

Frequency Range : 1GHz~18GHz

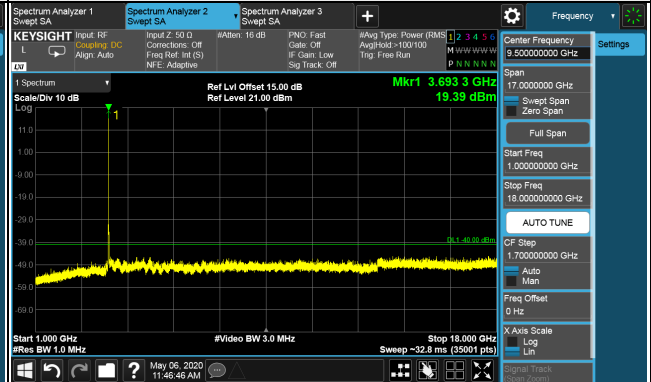

Frequency Range : 18GHz~40GHz

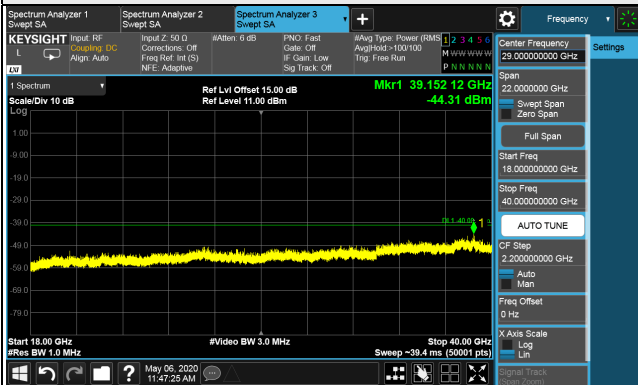

LTE Band 48, Channel Bandwidth 15MHz

Channel 55315 (3557.50MHz)

1RB

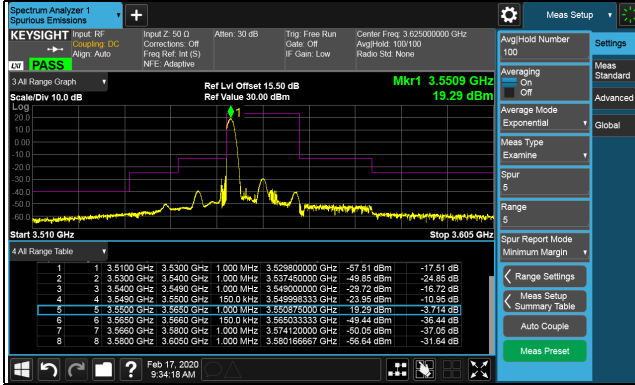

Channel 55990 (3625.0MHz)

1RB

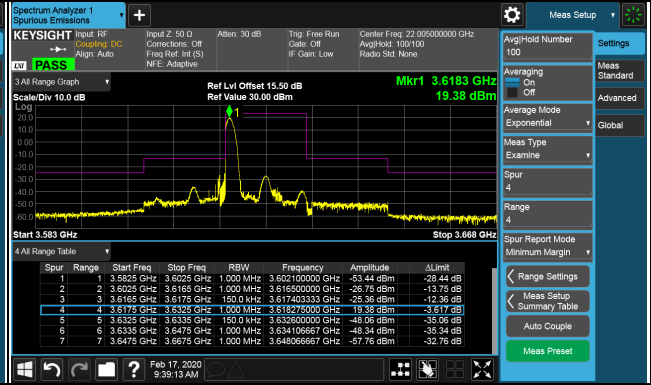

1RB 74

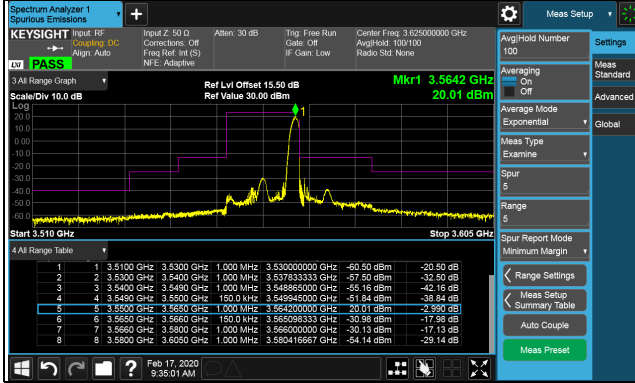

1RB 74

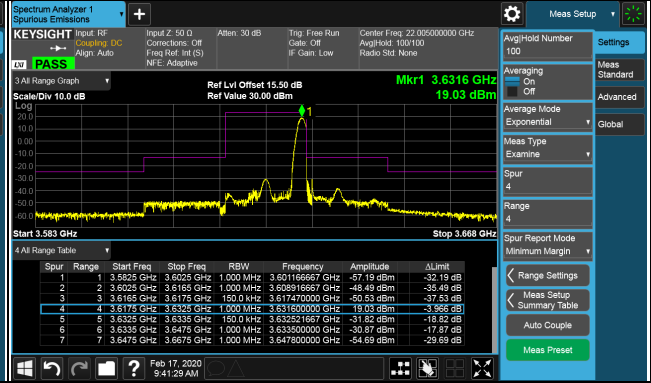

Full RB

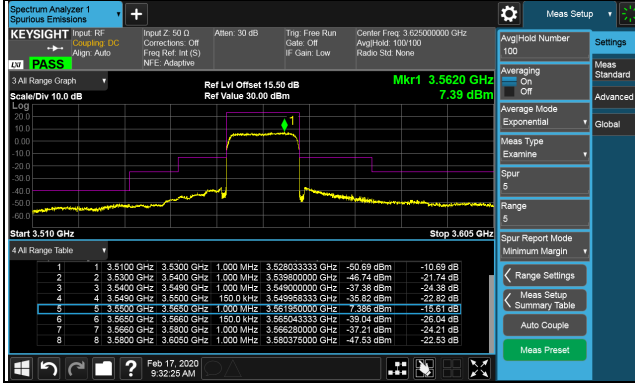

Full RB

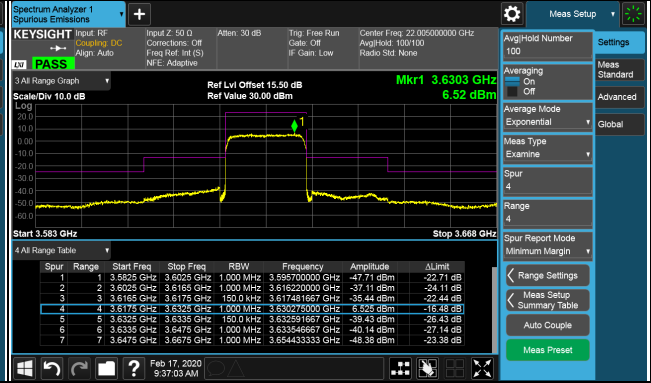

LTE Band 48, Channel Bandwidth 15MHz

Channel 56665 (3692.5MHz)

1RB

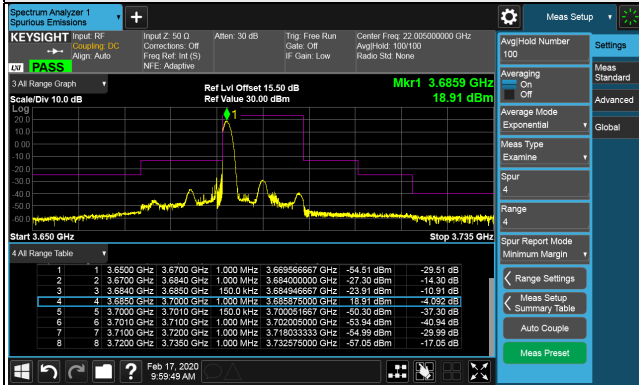

1RB 74

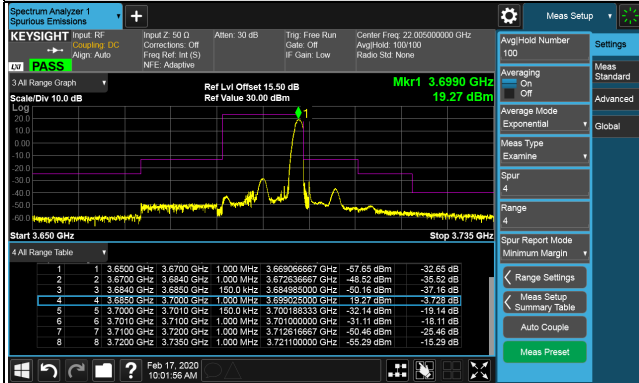

Full RB

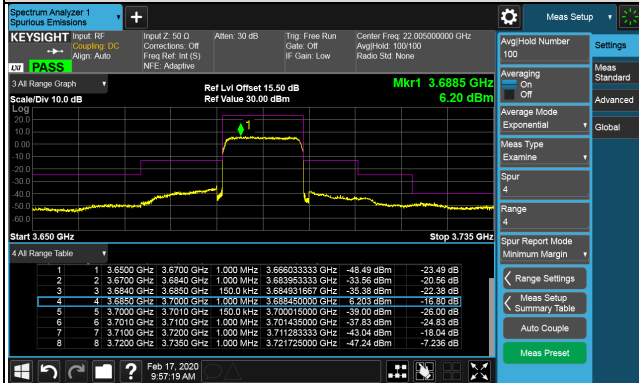

LTE Band 48, Channel Bandwidth 15MHz

Channel 55315 (3557.50MHz)

Frequency Range : 9kHz~1GHz

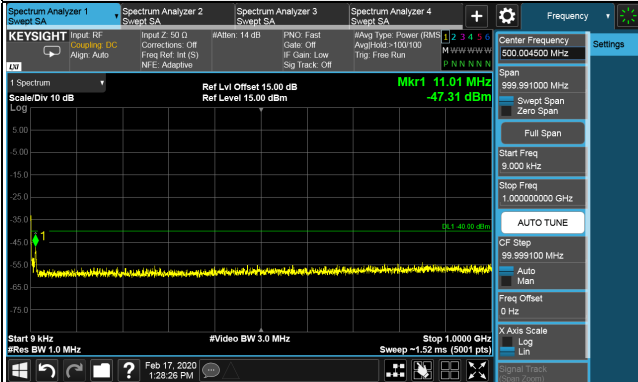

Frequency Range : 1GHz~18GHz

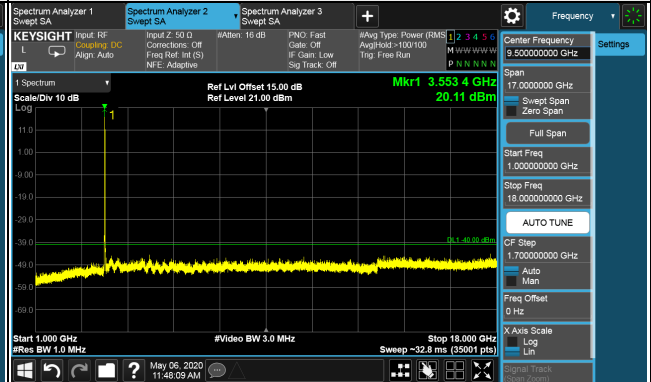

Frequency Range : 18GHz~40GHz

