

FCC Test Report (ENDC: n71+Band 2/7/66)

Report No.: RF200109E02B-14

FCC ID: 2AQ68T99W175

Test Model: T99W175

Received Date: Jan. 10, 2020

Test Date: Feb. 26 ~ May 18, 2020

Issued Date: May 26, 2020

Applicant: Hon Lin Technology Co., Ltd.

Address: 11F, No. 32, Jihu Rd., Neihu Dist., Taipei City 114, Taiwan R.O.C.

Issued By: Bureau Veritas Consumer Products Services (H.K.) Ltd., Taoyuan Branch
Lin Kou Laboratories

Lab Address: No. 47-2, 14th Ling, Chia Pau Vil., Lin Kou Dist., New Taipei City, Taiwan

Test Location: No. 19, Hwa Ya 2nd Rd., Wen Hwa Vil., Kwei Shan Dist., Taoyuan City
33383, Taiwan

FCC Registration / 788550 / TW0003

Designation Number:



This report is for your exclusive use. Any copying or replication of this report to or for any other person or entity, or use of our name or trademark, is permitted only with our prior written permission. This report sets forth our findings solely with respect to the test samples identified herein. The results set forth in this report are not indicative or representative of the quality or characteristics of the lot from which a test sample was taken or any similar or identical product specifically and expressly noted. Our report includes all of the tests requested by you and the results thereof based upon the information that you provided to us. You have 60 days from date of issuance of this report to notify us of any material error or omission caused by our negligence, provided, however, that such notice shall be in writing and shall specifically address the issue you wish to raise. A failure to raise such issue within the prescribed time shall constitute your unqualified acceptance of the completeness of this report, the tests conducted and the correctness of the report contents. Unless specific mention, the uncertainty of measurement has been explicitly taken into account to declare the compliance or non-compliance to the specification. The report must not be used by the client to claim product certification, approval, or endorsement by TAF or any government agencies

Table of Contents

Release Control Record	4
1 Certificate of Conformity	5
2 Summary of Test Results	6
2.1 Measurement Uncertainty.....	7
2.2 Test Site and Instruments.....	8
3 General Information	9
3.1 General Description of EUT.....	9
3.2 Configuration of System under Test.....	15
3.2.1 Description of Support Units.....	15
3.3 Test Mode Applicability and Tested Channel Detail.....	16
3.4 EUT Operating Conditions.....	26
3.5 General Description of Applied Standards and References.....	26
4 Test Types and Results	27
4.1 Output Power Measurement.....	27
4.1.1 Limits of Output Power Measurement.....	27
4.1.2 Test Procedures.....	27
4.1.3 Test Setup.....	27
4.1.4 Test Results.....	28
4.2 Modulation Characteristics Measurement.....	46
4.2.1 Limits of Modulation Characteristics.....	46
4.2.2 Test Procedure.....	46
4.2.3 Test Setup.....	46
4.2.4 Test Results.....	47
4.3 Frequency Stability Measurement.....	48
4.3.1 Limits of Frequency Stability Measurement.....	48
4.3.2 Test Procedure.....	48
4.3.3 Test Setup.....	48
4.3.4 Test Results.....	49
4.4 Occupied Bandwidth Measurement.....	69
4.4.1 Test Procedure.....	69
4.4.2 Test Setup.....	69
4.4.3 Test Result.....	70
4.5 Band Edge Measurement.....	90
4.5.1 Limits of Band Edge Measurement.....	90
4.5.2 Test Setup.....	90
4.5.3 Test Procedures.....	90
4.5.4 Test Results.....	91
4.6 Peak to Average Ratio.....	115
4.6.1 Limits of Peak to Average Ratio Measurement.....	115
4.6.2 Test Setup.....	115
4.6.3 Test Procedures.....	115
4.6.4 Test Results.....	116
4.7 Conducted Spurious Emissions.....	126
4.7.1 Limits of Conducted Spurious Emissions Measurement.....	126
4.7.2 Test Setup.....	126
4.7.3 Test Procedure.....	126
4.7.4 Test Results.....	127
4.8 Radiated Emission Measurement.....	155
4.8.1 Limits of Radiated Emission Measurement.....	155
4.8.2 Test Procedure.....	155
4.8.3 Deviation from Test Standard.....	155
4.8.4 Test Setup.....	156
4.8.5 Test Results.....	157

5	Pictures of Test Arrangements.....	179
	Appendix – Information of the Testing Laboratories	180

Release Control Record

Issue No.	Description	Date Issued
RF200109E02B-14	Original release	May 26, 2020

1 Certificate of Conformity

Product: 5G WWAN Module

Brand: Foxconn

Test Model: T99W175

Sample Status: Engineering Sample

Applicant: Hon Lin Technology Co., Ltd.

Test Date: Feb. 26 ~ May 18, 2020

Standards: FCC Part 24, Subpart E
FCC Part 27, Subpart L, M, N

The above equipment has been tested by **Bureau Veritas Consumer Products Services (H.K.) Ltd., Taoyuan Branch**, and found compliance with the requirement of the above standards. The test record, data evaluation & Equipment Under Test (EUT) configurations represented herein are true and accurate accounts of the measurements of the sample's RF characteristics under the conditions specified in this report.

Prepared by : Pettie Chen , **Date:** May 26, 2020
Pettie Chen / Senior Specialist

Approved by : Bruce Chen , **Date:** May 26, 2020
Bruce Chen / Senior Project Engineer

2 Summary of Test Results

Applied Standard: FCC Part 24 & Part 2			
FCC Clause	Test Item	Result	Remarks
2.1046 24.232	Effective radiated power	Pass	Meet the requirement of limit.
2.1046 24.232(d)	Peak To Average Ratio	Pass	Meet the requirement of limit.
2.1055 24.235	Frequency Stability	Pass	Meet the requirement of limit.
2.1049 24.238(b)	Occupied Bandwidth	Pass	Meet the requirement of limit.
24.238(b)	Band Edge Measurements	Pass	Meet the requirement of limit.
2.1051 24.238	Conducted Spurious Emissions	Pass	Meet the requirement of limit.
2.1053 24.238	Radiated Spurious Emissions	Pass	Meet the requirement of limit. Minimum passing margin is -33.3dB at 174.53MHz.

Note: Determining compliance based on the results of the compliance measurement, not taking into account measurement instrumentation uncertainty.

Applied Standard: FCC Part 27 & Part 2						
FCC Clause				Test Item	Result	Remarks
LTE B7	LTE B12	LTE B66	n71			
2.1046 27.50 (h)(2)	2.1046 27.50 (c)	2.1046 27.50 (d)(4)	2.1046 27.50 (c)	Equivalent Isotropically Radiated Power / Equivalent Radiated Power	Pass	Meet the requirement of limit.
----	----	----	2.1047	Modulation Characteristics	Pass	Meet the requirement of limit.
----	----	27.50 (d)(5)	----	Peak To Average Ratio	Pass	Meet the requirement of limit.
2.1055 27.54	2.1055 27.54	2.1055 27.54	2.1055 27.54	Frequency Stability Stay with the authorized bands of operation	Pass	Meet the requirement of limit.
2.1049	2.1049	2.1049	2.1049	Occupied Bandwidth	Pass	Meet the requirement of limit.
2.1051 27.53 (m)(4)(6)	2.1051 27.53(g)	2.1051 27.53(h)	2.1051 27.53(g)	Band Edge Measurements	Pass	Meet the requirement of limit.
2.1051 27.53 (m)(4)(6)	2.1051 27.53(g)	2.1051 27.53(h)	2.1051 27.53(g)	Conducted Spurious Emissions	Pass	Meet the requirement of limit.
2.1053 27.53 (m)(4)(6)	2.1053 27.53(g)	2.1053 27.53(h)	2.1053 27.53(g)	Radiated Spurious Emissions	Pass	Meet the requirement of limit. Minimum passing margin is -20.3dB at 160.95MHz.

Note: Determining compliance based on the results of the compliance measurement, not taking into account measurement instrumentation uncertainty.

2.1 Measurement Uncertainty

Where relevant, the following measurement uncertainty levels have been estimated for tests performed on the EUT as specified in CISPR 16-4-2:

Measurement	Frequency	Expanded Uncertainty (k=2) (\pm)
Radiated Emissions up to 1 GHz	9kHz ~ 30MHz	3.04 dB
	30MHz ~ 200MHz	3.63 dB
	200MHz ~ 1000MHz	3.64 dB
Radiated Emissions above 1 GHz	1GHz ~ 18GHz	2.29 dB
	18GHz ~ 40GHz	2.29 dB

2.2 Test Site and Instruments

Description & Manufacturer	Model No.	Serial No.	Cal. Date	Cal. Due
Test Receiver ROHDE & SCHWARZ	ESCI	100424	Dec. 31, 2019	Dec. 30, 2020
Spectrum Analyzer ROHDE & SCHWARZ	FSP40	100040	Sep. 23, 2019	Sep. 22, 2020
Spectrum Analyzer KEYSIGHT	N9030B	MY57140953	Jul. 03, 2019	Jul. 02, 2020
Radio Communication Analyzer Anritsu	MT8000A	6262012865	Dec. 12, 2019	Dec. 11, 2020
MXG Vector signal generator Agilent	N5182B	MY53050162	Jan. 14, 2020	Jan. 13, 2021
BILOG Antenna SCHWARZBECK	VULB9168	9168-158	Nov. 08, 2019	Nov. 07, 2020
BILOG Antenna SCHWARZBECK	VULB9168	9168-155	Nov. 11, 2019	Nov. 10, 2020
HORN Antenna SCHWARZBECK	BBHA 9120D	9120D-1170	Nov. 24, 2019	Nov. 23, 2020
HORN Antenna SCHWARZBECK	BBHA 9170	BBHA9170241	Nov. 24, 2019	Nov. 23, 2020
Loop Antenna TESEQ	HLA 6121	45745	Jul. 01, 2019	Jun. 30, 2020
Preamplifier Agilent (Below 1GHz)	8447D	2944A10631	Jul. 11, 2019	Jul. 10, 2020
Preamplifier KEYSIGHT (Above 1GHz)	83017A	MY53270295	Jun. 11, 2019	Jun. 10, 2020
RF Coaxial Cable WOKEN With 5dB PAD	8D-FB	Cable-CH4-01	Aug. 20, 2019	Aug. 19, 2020
RF Coaxial Cable EMCI	EMC102-KM-KM-3000	150929	Aug. 20, 2019	Aug. 19, 2020
RF Coaxial Cable EMCI	EMC102-KM-KM-600	150928	Aug. 20, 2019	Aug. 19, 2020
RF signal cable HUBER+SUHNER	SUCOFLEX 104	MY 13380+295012/04	Jul. 11, 2019	Jul. 10, 2020
RF signal cable HUBER+SUHNER	SUCOFLEX 104	Cable-CH4-03 (250724)	Jul. 11, 2019	Jul. 10, 2020
Software BV ADT	ADT_Radiated_V7.6.15.9.5	NA	NA	NA
Antenna Tower inn-co GmbH	MA 4000	010303	NA	NA
Antenna Tower Controller BV ADT	AT100	AT93021703	NA	NA
Boresight Antenna Fixture	FBA-01	FBA-SIP01	NA	NA
Standard Temperature And Humidity Chamber	MHU-225AU	920842	May 31, 2019	May 30, 2020
JFW 20dB attenuation	50HF-020-SMA	NA	NA	NA
True RMS Clamp Meter Fluke	325	31130711WS	May 21, 2019	May 20, 2020
DC power supply	U8002A	MY56330015	NA	NA

Note: 1. The calibration interval of the above test instruments is 12 months and the calibrations are traceable to NML/ROC and NIST/USA.

2. The test was performed in HwaYa Chamber 4.

3 General Information

3.1 General Description of EUT

Product	5G WWAN Module
Brand	Foxconn
Test Model	T99W175
Sample Status	Engineering Sample
Power Supply Rating	5 Vdc (Host equipment) 3.135Vdc~3.63Vdc (Module)

n71

Modulation Type	$\pi/2$ BPSK, QPSK, 16QAM, 64QAM, 256QAM					
Waveform Type	CP-OFDM, DFT-s-OFDM					
Operating Frequency	n71 (Channel Bandwidth 5MHz)	665.5MHz ~ 695.5MHz				
	n71 (Channel Bandwidth 10MHz)	668.0MHz ~ 693.0MHz				
	n71 (Channel Bandwidth 15MHz)	670.5MHz ~ 690.5MHz				
	n71 (Channel Bandwidth 20MHz)	673.0MHz ~ 688.0MHz				
Max. ERP Power		$\pi/2$ BPSK	QPSK	16QAM	64QAM	256QAM
	n71 (Channel Bandwidth 5MHz)	276.694mW (24.42dBm)	335.738mW (25.26dBm)	325.837mW (25.13dBm)	306.196mW (24.86dBm)	177.419mW (22.49dBm)
	n71 (Channel Bandwidth 10MHz)	345.939mW (25.39dBm)	343.558mW (25.36dBm)	327.341mW (25.15dBm)	305.492mW (24.85dBm)	179.887mW (22.55dBm)
	n71 (Channel Bandwidth 15MHz)	349.140mW (25.43dBm)	343.558mW (25.36dBm)	328.095mW (25.16dBm)	300.608mW (24.78dBm)	179.473mW (22.54dBm)
	n71 (Channel Bandwidth 20MHz)	350.752mW (25.45dBm)	341.979mW (25.34dBm)	327.341mW (25.15dBm)	306.196mW (24.86dBm)	180.302mW (22.56dBm)
Emission Designator		$\pi/2$ BPSK	QPSK	16QAM	64QAM	256QAM
	n71 (Channel Bandwidth 5MHz)	4M49G7D	4M49G7D	4M49D7W	4M50D7W	4M49D7W
	n71 (Channel Bandwidth 10MHz)	8M96G7D	8M96G7D	8M97D7W	8M96D7W	8M97D7W
	n71 (Channel Bandwidth 15MHz)	13M5G7D	13M5G7D	13M4D7W	13M4D7W	13M5D7W
	n71 (Channel Bandwidth 20MHz)	17M9G7D	17M9G7D	17M9D7W	17M9D7W	17M9D7W

LTE Band

Modulation Type	QPSK, 16QAM, 64QAM, 256QAM						
Operating Frequency	LTE Band 2	Channel Bandwidth 1.4MHz	1850.7MHz ~1909.3MHz				
		Channel Bandwidth 3MHz	1851.5MHz ~1908.5MHz				
		Channel Bandwidth 5MHz	1852.5MHz ~1907.5MHz				
		Channel Bandwidth 10MHz	1855.0MHz ~1905.0MHz				
		Channel Bandwidth 15MHz	1857.5MHz ~1902.5MHz				
		Channel Bandwidth 20MHz	1860.0MHz ~1900.0MHz				
	LTE Band 7	Channel Bandwidth 5MHz	2502.5MHz ~ 2567.5MHz				
		Channel Bandwidth 10MHz	2505.0MHz ~ 2565.0MHz				
		Channel Bandwidth 15MHz	2507.5MHz ~ 2562.5MHz				
		Channel Bandwidth 20MHz	2510.0MHz ~ 2560.0MHz				
	LTE Band 66	Channel Bandwidth 1.4MHz	1710.7MHz ~ 1779.3MHz				
		Channel Bandwidth 3MHz	1711.5MHz ~ 1778.5MHz				
		Channel Bandwidth 5MHz	1712.5MHz ~ 1777.5MHz				
		Channel Bandwidth 10MHz	1715.0MHz ~ 1775.0MHz				
		Channel Bandwidth 15MHz	1717.5MHz ~ 1772.5MHz				
		Channel Bandwidth 20MHz	1720.0MHz ~ 1770.0MHz				
	Max. EIRP Power	LTE Band 2		QPSK	16QAM	64QAM	256QAM
			Channel Bandwidth 1.4MHz	570.164mW (27.56dBm)	458.142mW (26.61dBm)	367.282mW (25.65dBm)	303.389mW (24.82dBm)
Channel Bandwidth 3MHz			583.445mW (27.66dBm)	462.381mW (26.65dBm)	365.595mW (25.63dBm)	295.801mW (24.71dBm)	
Channel Bandwidth 5MHz			583.445mW (27.66dBm)	459.198mW (26.62dBm)	366.438mW (25.64dBm)	285.102mW (24.55dBm)	
Channel Bandwidth 10MHz			582.103mW (27.65dBm)	460.257mW (26.63dBm)	368.978mW (25.67dBm)	300.608mW (24.78dBm)	
Channel Bandwidth 15MHz			580.764mW (27.64dBm)	458.142mW (26.61dBm)	368.978mW (25.67dBm)	283.792mW (24.53dBm)	
Channel Bandwidth 20MHz			584.790mW (27.67dBm)	456.037mW (26.59dBm)	368.129mW (25.66dBm)	280.543mW (24.48dBm)	
LTE Band 7		Channel Bandwidth 5MHz	693.426mW (28.41dBm)	558.470mW (27.47dBm)	533.335mW (27.27dBm)	395.367mW (25.97dBm)	
		Channel Bandwidth 10MHz	701.455mW (28.46dBm)	559.758mW (27.48dBm)	437.522mW (26.41dBm)	353.183mW (25.48dBm)	
		Channel Bandwidth 15MHz	695.024mW (28.42dBm)	567.545mW (27.54dBm)	443.609mW (26.47dBm)	353.997mW (25.49dBm)	
		Channel Bandwidth 20MHz	696.627mW (28.43dBm)	559.758mW (27.48dBm)	449.780mW (26.53dBm)	352.371mW (25.47dBm)	
LTE Band 66		Channel Bandwidth 1.4MHz	553.350mW (27.43dBm)	443.609mW (26.47dBm)	349.140mW (25.43dBm)	277.332mW (24.43dBm)	
		Channel Bandwidth 3MHz	555.904mW (27.45dBm)	437.522mW (26.41dBm)	352.371mW (25.47dBm)	282.488mW (24.51dBm)	
		Channel Bandwidth 5MHz	558.470mW (27.47dBm)	440.555mW (26.44dBm)	350.752mW (25.45dBm)	279.898mW (24.47dBm)	
		Channel Bandwidth 10MHz	554.626mW (27.44dBm)	438.531mW (26.42dBm)	350.752mW (25.45dBm)	281.190mW (24.49dBm)	
		Channel Bandwidth 15MHz	553.350mW (27.43dBm)	443.609mW (26.47dBm)	344.350mW (25.37dBm)	283.792mW (24.53dBm)	
		Channel Bandwidth 20MHz	555.904mW (27.45dBm)	443.609mW (26.47dBm)	352.371mW (25.47dBm)	283.139mW (24.52dBm)	

Emission Designator	LTE Band 2	Channel Bandwidth 1.4MHz	QPSK	16QAM	64QAM	256QAM
		Channel Bandwidth 3MHz	1M09G7D	1M09D7W	1M09D7W	1M09D7W
		Channel Bandwidth 5MHz	2M70G7D	2M70D7W	2M70D7W	2M70D7W
		Channel Bandwidth 10MHz	4M49G7D	4M49D7W	4M50D7W	4M49D7W
		Channel Bandwidth 15MHz	8M96G7D	8M96D7W	8M97D7W	8M96D7W
		Channel Bandwidth 20MHz	13M5G7D	13M5D7W	13M4D7W	13M5D7W
	LTE Band 7	Channel Bandwidth 5MHz	18M0G7D	18M0D7W	18M0D7W	18M0D7W
		Channel Bandwidth 10MHz	4M49G7D	4M49D7W	4M50D7W	4M49D7W
		Channel Bandwidth 15MHz	8M96G7D	8M96D7W	8M96D7W	8M95D7W
		Channel Bandwidth 20MHz	13M5G7D	13M5D7W	13M4D7W	13M5D7W
	LTE Band 66	Channel Bandwidth 5MHz	17M9G7D	18M0D7W	17M9D7W	18M0D7W
		Channel Bandwidth 1.4MHz	1M09G7D	1M09D7W	1M09D7W	1M09D7W
		Channel Bandwidth 3MHz	2M70G7D	2M70D7W	2M70D7W	2M70D7W
		Channel Bandwidth 5MHz	4M49G7D	4M49D7W	4M50D7W	4M49D7W
		Channel Bandwidth 10MHz	8M96G7D	8M97D7W	8M97D7W	8M97D7W
		Channel Bandwidth 15MHz	13M5G7D	13M5D7W	13M5D7W	13M5D7W
	Channel Bandwidth 20MHz	18M0G7D	18M0D7W	18M0D7W	18M0D7W	
	Antenna Type	Refer to Note as below				
Antenna Connector	Refer to Note as below					
Accessory Device	NA					
Cable Supplied	NA					

Output Power / Emission Designator	n71+LTE Band 2		Maximum EIRP / ERP	Sum Bandwidth
		n71 (ERP)	350.752mW(25.45dBm)	19M0D7W
		LTE Band 2 (EIRP)	303.389mW (24.82dBm)	
			EIRP / ERP	MAX Sum Bandwidth
		n71 (ERP)	330.370mW(25.19dBm)	35M9D7W
		LTE Band 2 (EIRP)	260.016mW(24.15dBm)	
	n71+LTE Band 7		Maximum EIRP / ERP	Sum Bandwidth
		n71 (ERP)	350.752mW(25.45dBm)	22M4D7W
		LTE Band 7 (EIRP)	395.367mW (25.97dBm)	
			EIRP / ERP	MAX Sum Bandwidth
		n71 (ERP)	330.370mW(25.19dBm)	35M9D7W
		LTE Band 7 (EIRP)	345.939mW(25.39dBm)	
	n71+LTE Band 66		Maximum EIRP / ERP	Sum Bandwidth
		n71 (ERP)	350.752mW(25.45dBm)	31M4D7W
		LTE Band 66 (EIRP)	283.792mW(24.53dBm)	
		EIRP / ERP	MAX Sum Bandwidth	
n71 (ERP)		330.370mW(25.19dBm)	36M0D7W	
LTE Band 66 (EIRP)		264.241mW(24.22dBm)		

Note:

1. This report is prepared for FCC class II permissive change. This report is issued as a supplementary report of BV CPS report no.: RF200109E02-15 Difference compared with the original report is adding Modulation Type 256QAM by software. In this software changed, will not impact the 5G NR characteristic, therefore all test results are keeping as original report stated. Therefore, the EUT was tested all tests for 256QAM and presented in the test report.
2. There are four Difference HW of T99W175.

Brand	Model	HW
Foxconn	T99W175	1. 3G+LTE+Sub6+eSIM
		2. 3G+LTE+Sub6 only w/o eSIM
		3. 3G+LTE+Sub6+eSIM+GNSS connector
		4. 3G+LTE+Sub6 only+w/o eSIM+GNSS connector

*After pre-testing, "HW: 1. 3G+LTE+Sub6+eSIM" is the worst for the final tests.

3. After pre-testing, "DFT-s-OFDM" is the worst for the final tests.

4. The following antennas were provided to the EUT.

Antenna No.	RF Chain No.	Brand	Model	Antenna Net Gain(dBi)	Frequency range (MHz)	Antenna Type	Connector Type
1		WHA YU	C107-511720-A	4.41	660~803	PCB	I-PEX
2		WHA YU	C107-511721-A	3.81 4.03	791~960 1447.9~1606	PCB	I-PEX
3		WHA YU	C107-511722-A	4.27 5.31	1710~2170 2500~2690	PCB	I-PEX
4		WHA YU	C107-511723-A	2.99 0.92	2300~2400 3500~3700	PCB	I-PEX
5		WHA YU	C107-511724-A	6.45	5150~5925	PCB	I-PEX
6		WHA YU	C107-511725-A	4.89	3400~3700	PCB	I-PEX
7		AVX	5000106-R1-X01	2.91	699~803	Monopole	I-PEX
8		AVX	5000107-R1-X01	2.59	791~960	Monopole	I-PEX
9		AVX	5000108-R1-X01	2.85	1427~1610	Monopole	I-PEX
10		AVX	5000109-R1-X01	2.23 2.94	1710~2200 5150~5925	Monopole	I-PEX
11		AVX	5000110-R1-X01	0.9	2300~2690	Monopole	I-PEX
12		AVX	5000111-R1-X01	0.87	3300~5000	Monopole	I-PEX
13	Tx1/ Rx1	Ethertronics	5003806	0.4 -1.61 0.39 2.95 1.98 0.38 0.83 2.31	698-821 824-960 1425-1515 1710-2200 2300-2690 3300-4200 4400-5000 5150-5925	PIFA	I-PEX
	Rx2	Ethertronics	5003807	-2.24 -4.52 2.87 2.99 2.93 2.91 2.23 -0.85 -3.04	716-821 824-960 1425-1515 1557-1610 1805-2200 2300-2690 3300-4200 4400-5000 5150-5925	PIFA	I-PEX
	Tx2/ Rx3	Ethertronics	5003806	2.21 2.25 -0.45 2.6	1710-2200 2300-2690 3300-4200 4400-5000	PIFA	I-PEX
	Rx4	Ethertronics	5003700	1.38 2.87 0.6 -2.09	1805-2200 2300-2690 3300-4200 4400-5000	PIFA	I-PEX

Antenna No.	RF Chain No.	Brand	Model	Antenna Net Gain(dBi)	Frequency range (MHz)	Antenna Type	Connector Type
14	Ant. 0 (TX/RX)	Master Wave	NA	2.4 2.2 2.9 2.9 2.9 NA	880~960 1020~2170 2545~2595 3565~3600 3900~4000 GPS	PCB	I-PEX
	Ant. 2 (TX/RX)	Master Wave	NA	NA 2.2 2.8 2.9 2.8 NA	880~960 1020~2170 2545~2595 3565~3600 3900~4000 GPS	PCB	I-PEX
	Ant. 1 (RX)	Master Wave	NA	NA 5.3 5.1 4.3 4.5 NA	880~960 1020~2170 2545~2595 3565~3600 3900~4000 GPS	PCB	I-PEX
	Ant. 3 (RX)	Master Wave	NA	1.3 6.8 3.7 6.4 6.2 3.7	880~960 1020~2170 2545~2595 3565~3600 3900~4000 GPS	PCB	I-PEX

*The antenna for the final tests as following table.

	Band	Antenna
5G NR	71 (15kHz) /5/10/15/20	Antenna 1

	Band	Antenna
LTE	2	Antenna 3
	7	Antenna 3
	66	Antenna 3

5. The EUT supports the following ENDC configuration.

5G NR	FCC 5G FR1			ENDC
	Band	SCS	Bandwidth (MHz)	
	n2	15kHz	5/10/15/20	Band 5/12/13/30/48/66
	n5	15kHz	5/10/15/20	Band 2/7/12/48/66
	n7	15kHz	5/10/15/20	Band 5/12
	n12	15kHz	5/10/15	Band 2/66
	n41	30kHz	20/40/50/60/80/90/100	Band 2/25/26/66/41
	n66	15kHz	5/10/15/20	Band 5/12/13/30/48/71
	n71	15kHz	5/10/15/20	Band 2/7/66

3.2 Configuration of System under Test

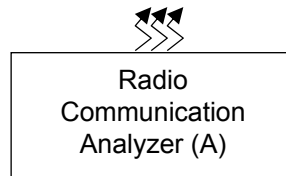
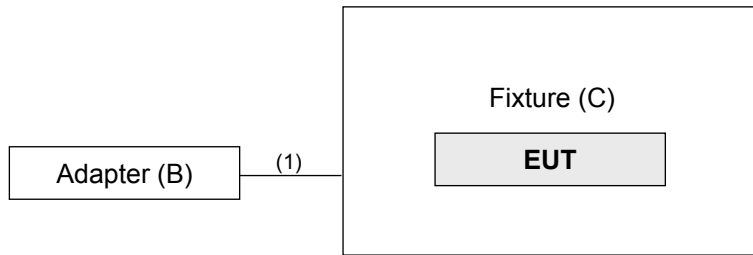

3.2.1 Description of Support Units

The EUT has been tested as an independent unit together with other necessary accessories or support units. The following support units or accessories were used to form a representative test configuration during the tests.

ID	Product	Brand	Model No.	Serial No.	FCC ID	Remarks
A.	Radio Communication Analyzer	Anritsu	MT8821C	6261806803	NA	-
B.	Adapter	LITEON	PA-1050-39	NA	NA	-
C.	Fixture	NA	NA	NA	NA	Provided by client.

Note:

1. All power cords of the above support units are non-shielded (1.8m).
2. Item A acted as a communication partner to transfer data.

ID	Descriptions	Qty.	Length (m)	Shielding (Yes/No)	Cores (Qty.)	Remarks
1.	USB cable	1	1.5	Y	0	-

3.3 Test Mode Applicability and Tested Channel Detail

Pre-Scan has been conducted to determine the worst-case mode from all possible combinations between available modulations, data rates, XYZ axis and antenna ports. The worst case was found when positioned on Z-plane. Following channel(s) was (were) selected for the final test as listed below.

n71

EUT Configure Mode	Test item	Available channel	Tested channel	Channel Bandwidth	Modulation	Mode
-	ERP	133100 to 139100	133100 (665.5MHz), 136100 (680.5MHz), 139100 (695.5MHz)	5 MHz	$\pi/2$ BPSK / QPSK / 16QAM / 64QAM / 256QAM	1 RB / 0 RB Offset 1 RB / 12 RB Offset 1 RB / 24 RB Offset 12 RB / 0 RB Offset 12 RB / 6 RB Offset 12 RB / 13 RB Offset 25 RB / 0 RB Offset
		133600 to 138600	133600 (668.0MHz), 136100 (680.5MHz), 138600 (693.0MHz)	10 MHz	$\pi/2$ BPSK / QPSK / 16QAM / 64QAM / 256QAM	1 RB / 0 RB Offset 1 RB / 24 RB Offset 1 RB / 49 RB Offset 25 RB / 0 RB Offset 25 RB / 12 RB Offset 25 RB / 25 RB Offset 50 RB / 0 RB Offset
		134100 to 138100	134100 (670.5MHz), 136100 (680.5MHz), 138100 (690.5MHz)	15 MHz	$\pi/2$ BPSK / QPSK / 16QAM / 64QAM / 256QAM	1 RB / 0 RB Offset 1 RB / 37 RB Offset 1 RB / 74 RB Offset 36 RB / 0 RB Offset 36 RB / 19 RB Offset 36 RB / 39 RB Offset 75 RB / 0 RB Offset
		134600 to 137600	134600 (673.0MHz), 136100 (680.5MHz), 137600 (688.0MHz)	20 MHz	$\pi/2$ BPSK / QPSK / 16QAM / 64QAM / 256QAM	1 RB / 0 RB Offset 1 RB / 50 RB Offset 1 RB / 99 RB Offset 50 RB / 0 RB Offset 50 RB / 25 RB Offset 50 RB / 50 RB Offset 100 RB / 0 RB Offset
-	Modulation Characteristics	134600 to 137600	136100 (680.5MHz)	20 MHz	$\pi/2$ BPSK / QPSK / 16QAM / 64QAM / 256QAM	100 RB / 0 RB Offset
-	Frequency Stability	133100 to 139100	133100 (665.5MHz), 139100 (695.5MHz)	5 MHz	$\pi/2$ BPSK	25 RB / 0 RB Offset
		133600 to 138600	133600 (668.0MHz), 138600 (693.0MHz)	10 MHz	$\pi/2$ BPSK	50 RB / 0 RB Offset
		134100 to 138100	134100 (670.5MHz), 138100 (690.5MHz)	15 MHz	$\pi/2$ BPSK	75 RB / 0 RB Offset
		134600 to 137600	134600 (673.0MHz), 137600 (688.0MHz)	20 MHz	$\pi/2$ BPSK	100 RB / 0 RB Offset
-	Emission Bandwidth	133100 to 139100	133100 (665.5MHz), 136100 (680.5MHz), 139100 (695.5MHz)	5 MHz	$\pi/2$ BPSK / QPSK / 16QAM / 64QAM / 256QAM	6 RB / 0 RB Offset
		133600 to 138600	133600 (668.0MHz), 136100 (680.5MHz), 138600 (693.0MHz)	10 MHz	$\pi/2$ BPSK / QPSK / 16QAM / 64QAM / 256QAM	15 RB / 0 RB Offset
		134100 to 138100	134100 (670.5MHz), 136100 (680.5MHz), 138100 (690.5MHz)	15 MHz	$\pi/2$ BPSK / QPSK / 16QAM / 64QAM / 256QAM	25 RB / 0 RB Offset
		134600 to 137600	134600 (673.0MHz), 136100 (680.5MHz), 137600 (688.0MHz)	20 MHz	$\pi/2$ BPSK / QPSK / 16QAM / 64QAM / 256QAM	50 RB / 0 RB Offset

EUT Configure Mode	Test item	Available channel	Tested channel	Channel Bandwidth	Modulation	Mode
-	Band Edge	133100 to 139100	133100 (665.5MHz), 139100 (695.5MHz)	5 MHz	$\pi/2$ BPSK	1 RB / 0 RB Offset 1 RB / 24 RB Offset 25 RB / 0 RB Offset
		133600 to 138600	133600 (668.0MHz), 138600 (693.0MHz)	10 MHz	$\pi/2$ BPSK	1 RB / 0 RB Offset 1 RB / 49 RB Offset 50 RB / 0 RB Offset
		134100 to 138100	134100 (670.5MHz), 138100 (690.5MHz)	15 MHz	$\pi/2$ BPSK	1 RB / 0 RB Offset 1 RB / 74 RB Offset 75 RB / 0 RB Offset
		134600 to 137600	134600 (673.0MHz), 137600 (688.0MHz)	20 MHz	$\pi/2$ BPSK	1 RB / 0 RB Offset 1 RB / 99 RB Offset 100 RB / 0 RB Offset
-	Peak to Average Ratio	133100 to 139100	133100 (665.5MHz), 136100 (680.5MHz), 139100 (695.5MHz)	5 MHz	$\pi/2$ BPSK / QPSK / 16QAM / 64QAM / 256QAM	1 RB / 24 RB Offset
		133600 to 138600	133600 (668.0MHz), 136100 (680.5MHz), 138600 (693.0MHz)	10 MHz	$\pi/2$ BPSK / QPSK / 16QAM / 64QAM / 256QAM	1 RB / 0 RB Offset
		134100 to 138100	134100 (670.5MHz), 136100 (680.5MHz), 138100 (690.5MHz)	15 MHz	$\pi/2$ BPSK / QPSK / 16QAM / 64QAM / 256QAM	1 RB / 74 RB Offset
		134600 to 137600	134600 (673.0MHz), 136100 (680.5MHz), 137600 (688.0MHz)	20 MHz	$\pi/2$ BPSK / QPSK / 16QAM / 64QAM / 256QAM	1 RB / 0 RB Offset
-	Conducted Emission	133100 to 139100	133100 (665.5MHz), 136100 (680.5MHz), 139100 (695.5MHz)	5 MHz	$\pi/2$ BPSK	1 RB / 24 RB Offset
		133600 to 138600	133600 (668.0MHz), 136100 (680.5MHz), 138600 (693.0MHz)	10 MHz	$\pi/2$ BPSK	1 RB / 0 RB Offset
		134100 to 138100	134100 (670.5MHz), 136100 (680.5MHz), 138100 (690.5MHz)	15 MHz	$\pi/2$ BPSK	1 RB / 74 RB Offset
		134600 to 137600	134600 (673.0MHz), 136100 (680.5MHz), 137600 (688.0MHz)	20 MHz	$\pi/2$ BPSK	1 RB / 0 RB Offset
-	Radiated Emission Below 1GHz	133100 to 139100	139100 (695.5MHz)	5 MHz	$\pi/2$ BPSK	1 RB / 24 RB Offset
		134600 to 137600	137600 (688.0MHz)	20 MHz	$\pi/2$ BPSK	1 RB / 0 RB Offset
-	Radiated Emission Above 1GHz	133100 to 139100	133100 (665.5MHz), 136100 (680.5MHz), 139100 (695.5MHz)	5 MHz	$\pi/2$ BPSK	1 RB / 24 RB Offset
		133600 to 138600	133600 (668.0MHz), 136100 (680.5MHz), 138600 (693.0MHz)	10 MHz	$\pi/2$ BPSK	1 RB / 0 RB Offset
		134100 to 138100	134100 (670.5MHz), 136100 (680.5MHz), 138100 (690.5MHz)	15 MHz	$\pi/2$ BPSK	1 RB / 74 RB Offset
		134600 to 137600	134600 (673.0MHz), 136100 (680.5MHz), 137600 (688.0MHz)	20 MHz	$\pi/2$ BPSK	1 RB / 0 RB Offset

Note: The conducted output power for $\pi/2$ BPSK, QPSK, 16QAM, 64QAM and 256QAM, measured value of $\pi/2$ BPSK is higher than QPSK, 16QAM, 64QAM and 256QAM mode. Therefore, only ERP, Modulation characteristics, occupied bandwidth and Peak to average ratio items had been tested under $\pi/2$ BPSK, QPSK, 16QAM, 64QAM and 256QAM modes, the other test items were performed under $\pi/2$ BPSK mode only.

LTE Band 2

EUT Configure Mode	Test item	Available channel	Tested Channel	Channel Bandwidth	Modulation	Mode
-	EIRP	18607 to 19193	18607 (1850.70MHz), 18900 (1880.00MHz), 19193 (1909.30MHz)	1.4MHz	256QAM	1 RB / 0 RB Offset 1 RB / 2 RB Offset 1 RB / 5 RB Offset 3 RB / 0 RB Offset 3 RB / 1 RB Offset 3 RB / 3 RB Offset 6 RB / 0 RB Offset
		18615 to 19185	18615 (1851.50MHz), 18900 (1880.00MHz), 19185 (1908.50MHz)	3MHz	256QAM	1 RB / 0 RB Offset 1 RB / 7 RB Offset 1 RB / 14 RB Offset 8 RB / 0 RB Offset 8 RB / 3 RB Offset 8 RB / 7 RB Offset 15 RB / 0 RB Offset
		18625 to 19175	18625 (1852.50MHz), 18900 (1880.00MHz), 19175 (1907.50MHz)	5MHz	256QAM	1 RB / 0 RB Offset 1 RB / 12 RB Offset 1 RB / 24 RB Offset 12 RB / 0 RB Offset 12 RB / 6 RB Offset 12 RB / 13 RB Offset 25 RB / 0 RB Offset
		18650 to 19150	18650 (1855.00MHz), 18900 (1880.00MHz), 19150 (1905.00MHz)	10MHz	256QAM	1 RB / 0 RB Offset 1 RB / 24 RB Offset 1 RB / 49 RB Offset 25 RB / 0 RB Offset 25 RB / 12 RB Offset 25 RB / 25 RB Offset 50 RB / 0 RB Offset
		18675 to 19125	18675 (1857.50MHz), 18900 (1880.00MHz), 19125 (1902.50MHz)	15MHz	256QAM	1 RB / 0 RB Offset 1 RB / 37 RB Offset 1 RB / 74 RB Offset 36 RB / 0 RB Offset 36 RB / 19 RB Offset 36 RB / 39 RB Offset 75 RB / 0 RB Offset
		18700 to 19100	18700 (1860.00MHz), 18900 (1880.00MHz), 19100 (1900.00MHz)	20MHz	256QAM	1 RB / 0 RB Offset 1 RB / 50 RB Offset 1 RB / 99 RB Offset 50 RB / 0 RB Offset 50 RB / 25 RB Offset 50 RB / 50 RB Offset 100 RB / 0 RB Offset
-	Frequency Stability	18607 to 19193	18607 (1850.70MHz), 19193 (1909.30MHz)	1.4MHz	256QAM	5 RB / 0 RB Offset
		18615 to 19185	18615 (1851.50MHz), 19185 (1908.50MHz)	3MHz	256QAM	15 RB / 0 RB Offset
		18625 to 19175	18625 (1852.50MHz), 19175 (1907.50MHz)	5MHz	256QAM	25 RB / 0 RB Offset
		18650 to 19150	18650 (1855.00MHz), 19150 (1905.00MHz)	10MHz	256QAM	50 RB / 0 RB Offset
		18675 to 19125	18675 (1857.50MHz), 19125 (1902.50MHz)	15MHz	256QAM	75 RB / 0 RB Offset
		18700 to 19100	18700 (1860.00MHz), 19100 (1900.00MHz)	20MHz	256QAM	100 RB / 0 RB Offset

EUT Configure Mode	Test item	Available channel	Tested Channel	Channel Bandwidth	Modulation	Mode
-	Occupied Bandwidth	18607 to 19193	18607 (1850.70MHz), 18900 (1880.00MHz), 19193 (1909.30MHz)	1.4MHz	256QAM	5 RB / 0 RB Offset
		18615 to 19185	18615 (1851.50MHz), 18900 (1880.00MHz), 19185 (1908.50MHz)	3MHz	256QAM	15 RB / 0 RB Offset
		18625 to 19175	18625 (1852.50MHz), 18900 (1880.00MHz), 19175 (1907.50MHz)	5MHz	256QAM	25 RB / 0 RB Offset
		18650 to 19150	18650 (1855.00MHz), 18900 (1880.00MHz), 19150 (1905.00MHz)	10MHz	256QAM	50 RB / 0 RB Offset
		18675 to 19125	18675 (1857.50MHz), 18900 (1880.00MHz), 19125 (1902.50MHz)	15MHz	256QAM	75 RB / 0 RB Offset
		18700 to 19100	18700 (1860.00MHz), 18900 (1880.00MHz), 19100 (1900.00MHz)	20MHz	256QAM	100 RB / 0 RB Offset
-	Band Edge	18607 to 19193	18607 (1850.70MHz), 19193 (1909.30MHz)	1.4MHz	256QAM	1 RB / 0 RB Offset 1 RB / 5 RB Offset 6 RB / 0 RB Offset
		18615 to 19185	18615 (1851.50MHz), 19185 (1908.50MHz)	3MHz	256QAM	1 RB / 0 RB Offset 1 RB / 14 RB Offset 15 RB / 0 RB Offset
		18625 to 19175	18625 (1852.50MHz), 19175 (1907.50MHz)	5MHz	256QAM	1 RB / 0 RB Offset 1 RB / 24 RB Offset 25 RB / 0 RB Offset
		18650 to 19150	18650 (1855.00MHz), 19150 (1905.00MHz)	10MHz	256QAM	1 RB / 0 RB Offset 1 RB / 49 RB Offset 50 RB / 0 RB Offset
		18675 to 19125	18675 (1857.50MHz), 19125 (1902.50MHz)	15MHz	256QAM	1 RB / 0 RB Offset 1 RB / 74 RB Offset 75 RB / 0 RB Offset
		18700 to 19100	18700 (1860.00MHz), 19100 (1900.00MHz)	20MHz	256QAM	1 RB / 0 RB Offset 1 RB / 99 RB Offset 100 RB / 0 RB Offset
-	Peak to Average Ratio	18607 to 19193	18607 (1850.70MHz), 18900 (1880.00MHz), 19193 (1909.30MHz)	1.4MHz	256QAM	1 RB / 0 RB Offset
		18615 to 19185	18615 (1851.50MHz), 18900 (1880.00MHz), 19185 (1908.50MHz)	3MHz	256QAM	1 RB / 0 RB Offset
		18625 to 19175	18625 (1852.50MHz), 18900 (1880.00MHz), 19175 (1907.50MHz)	5MHz	256QAM	1 RB / 0 RB Offset
		18650 to 19150	18650 (1855.00MHz), 18900 (1880.00MHz), 19150 (1905.00MHz)	10MHz	256QAM	1 RB / 0 RB Offset
		18675 to 19125	18675 (1857.50MHz), 18900 (1880.00MHz), 19125 (1902.50MHz)	15MHz	256QAM	1 RB / 0 RB Offset
		18700 to 19100	18700 (1860.00MHz), 18900 (1880.00MHz), 19100 (1900.00MHz)	20MHz	256QAM	1 RB / 0 RB Offset

EUT Configure Mode	Test item	Available channel	Tested Channel	Channel Bandwidth	Modulation	Mode
-	Conducted Emission	18607 to 19193	18607 (1850.70MHz), 18900 (1880.00MHz), 19193 (1909.30MHz)	1.4MHz	256QAM	1 RB / 0 RB Offset
		18615 to 19185	18615 (1851.50MHz), 18900 (1880.00MHz), 19185 (1908.50MHz)	3MHz	256QAM	1 RB / 0 RB Offset
		18625 to 19175	18625 (1852.50MHz), 18900 (1880.00MHz), 19175 (1907.50MHz)	5MHz	256QAM	1 RB / 0 RB Offset
		18650 to 19150	18650 (1855.00MHz), 18900 (1880.00MHz), 19150 (1905.00MHz)	10MHz	256QAM	1 RB / 0 RB Offset
		18675 to 19125	18675 (1857.50MHz), 18900 (1880.00MHz), 19125 (1902.50MHz)	15MHz	256QAM	1 RB / 0 RB Offset
		18700 to 19100	18700 (1860.00MHz), 18900 (1880.00MHz), 19100 (1900.00MHz)	20MHz	256QAM	1 RB / 0 RB Offset
-	Radiated Emission Below 1GHz	18700 to 19100	18900 (1880.00MHz)	20MHz	256QAM	1 RB / 0 RB Offset
-	Radiated Emission Above 1GHz	18607 to 19193	18607 (1850.70MHz), 18900 (1880.00MHz), 19193 (1909.30MHz)	1.4MHz	256QAM	1 RB / 0 RB Offset
		18625 to 19175	18625 (1852.50MHz), 18900 (1880.00MHz), 19175 (1907.50MHz)	5MHz	256QAM	1 RB / 0 RB Offset
		18700 to 19100	18700 (1860.00MHz), 18900 (1880.00MHz), 19100 (1900.00MHz)	20MHz	256QAM	1 RB / 0 RB Offset

Note: For radiated emission above 1GHz, according to 3GPP 36.521 Section 6.6.3.1.4, choose the lowest, 5MHz & highest channel bandwidth for final test.

LTE Band 7

EUT Configure Mode	Test item	Available channel	Tested channel	Channel Bandwidth	Modulation	Mode
-	EIRP	20775 to 21425	20775 (2502.5MHz), 21100 (2535.0MHz), 21425 (2567.5MHz)	5 MHz	256QAM	1 RB / 0 RB Offset 1 RB / 12 RB Offset 1 RB / 24 RB Offset 12 RB / 0 RB Offset 12 RB / 6 RB Offset 12 RB / 13 RB Offset 25 RB / 0 RB Offset
		20800 to 21400	20800 (2505.0MHz), 21100 (2535.0MHz), 21400 (2565.0MHz)	10 MHz	256QAM	1 RB / 0 RB Offset 1 RB / 24 RB Offset 1 RB / 49 RB Offset 25 RB / 0 RB Offset 25 RB / 12 RB Offset 25 RB / 25 RB Offset 50 RB / 0 RB Offset
		20825 to 21375	20825 (2507.5MHz), 21100 (2535.0MHz), 21375 (2562.5MHz)	15 MHz	256QAM	1 RB / 0 RB Offset 1 RB / 37 RB Offset 1 RB / 74 RB Offset 36 RB / 0 RB Offset 36 RB / 19 RB Offset 36 RB / 39 RB Offset 75 RB / 0 RB Offset
		20850 to 21350	20850 (2510.0MHz), 21100 (2535.0MHz), 21350 (2560.0MHz)	20 MHz	256QAM	1 RB / 0 RB Offset 1 RB / 50 RB Offset 1 RB / 99 RB Offset 50 RB / 0 RB Offset 50 RB / 25 RB Offset 50 RB / 50 RB Offset 100 RB / 0 RB Offset
-	Frequency Stability	20775 to 21425	20775 (2502.5MHz), 21425 (2567.5MHz)	5 MHz	256QAM	25 RB / 0 RB Offset
		20800 to 21400	20800 (2505.0MHz), 21400 (2565.0MHz)	10 MHz	256QAM	50 RB / 0 RB Offset
		20825 to 21375	20825 (2507.5MHz), 21375 (2562.5MHz)	15 MHz	256QAM	75 RB / 0 RB Offset
		20850 to 21350	20850 (2510.0MHz), 21350 (2560.0MHz)	20 MHz	256QAM	100 RB / 0 RB Offset
-	Emission Bandwidth	20775 to 21425	20775 (2502.5MHz), 21100 (2535.0MHz), 21425 (2567.5MHz)	5 MHz	256QAM	25 RB / 0 RB Offset
		20800 to 21400	20800 (2505.0MHz), 21100 (2535.0MHz), 21400 (2565.0MHz)	10 MHz	256QAM	50 RB / 0 RB Offset
		20825 to 21375	20825 (2507.5MHz), 21100 (2535.0MHz), 21375 (2562.5MHz)	15 MHz	256QAM	75 RB / 0 RB Offset
		20850 to 21350	20850 (2510.0MHz), 21100 (2535.0MHz), 21350 (2560.0MHz)	20 MHz	256QAM	100 RB / 0 RB Offset
-	Emission Mask	20775 to 21425	20775 (2502.5MHz), 21100 (2535.0MHz), 21425 (2567.5MHz)	5 MHz	256QAM	1 RB / 0 RB Offset 1 RB / 24 RB Offset 25 RB / 0 RB Offset
		20800 to 21400	20800 (2505.0MHz), 21100 (2535.0MHz), 21400 (2565.0MHz)	10 MHz	256QAM	1 RB / 0 RB Offset 1 RB / 49 RB Offset 50 RB / 0 RB Offset
		20825 to 21375	20825 (2507.5MHz), 21100 (2535.0MHz), 21375 (2562.5MHz)	15 MHz	256QAM	1 RB / 0 RB Offset 1 RB / 74 RB Offset 75 RB / 0 RB Offset
		20850 to 21350	20850 (2510.0MHz), 21100 (2535.0MHz), 21350 (2560.0MHz)	20 MHz	256QAM	1 RB / 0 RB Offset 1 RB / 99 RB Offset 100 RB / 0 RB Offset

EUT Configure Mode	Test item	Available channel	Tested channel	Channel Bandwidth	Modulation	Mode
-	Peak to Average Ratio	20775 to 21425	20775 (2502.5MHz), 21100 (2535.0MHz), 21425 (2567.5MHz)	5 MHz	256QAM	1 RB / 0 RB Offset
		20800 to 21400	20800 (2505.0MHz), 21100 (2535.0MHz), 21400 (2565.0MHz)	10 MHz	256QAM	1 RB / 0 RB Offset
		20825 to 21375	20825 (2507.5MHz), 21100 (2535.0MHz), 21375 (2562.5MHz)	15 MHz	256QAM	1 RB / 0 RB Offset
		20850 to 21350	20850 (2510.0MHz), 21100 (2535.0MHz), 21350 (2560.0MHz)	20 MHz	256QAM	1 RB / 0 RB Offset
-	Conducted Emission	20775 to 21425	20775 (2502.5MHz), 21100 (2535.0MHz), 21425 (2567.5MHz)	5 MHz	256QAM	1 RB / 0 RB Offset
		20800 to 21400	20800 (2505.0MHz), 21100 (2535.0MHz), 21400 (2565.0MHz)	10 MHz	256QAM	1 RB / 0 RB Offset
		20825 to 21375	20825 (2507.5MHz), 21100 (2535.0MHz), 21375 (2562.5MHz)	15 MHz	256QAM	1 RB / 0 RB Offset
		20850 to 21350	20850 (2510.0MHz), 21100 (2535.0MHz), 21350 (2560.0MHz)	20 MHz	256QAM	1 RB / 0 RB Offset
-	Radiated Emission Below 1GHz	20850 to 21350	21350 (2560.0MHz)	20MHz	256QAM	1 RB / 0 RB Offset
-	Radiated Emission Above 1GHz	20775 to 21425	20775 (2502.5MHz), 21100 (2535.0MHz), 21425 (2567.5MHz)	5MHz	256QAM	1 RB / 0 RB Offset
		20850 to 21350	20850 (2510.0MHz), 21100 (2535.0MHz), 21350 (2560.0MHz)	20MHz	256QAM	1 RB / 0 RB Offset

Note: For radiated emission above 1GHz, according to 3GPP 36.521 Section 6.6.3.1.4, choose the 5MHz & highest channel bandwidth for final test.

LTE Band 66

EUT Configure Mode	Test Item	Available Channel	Tested Channel	Channel Bandwidth	Modulation	Mode
-	EIRP	131979 to 132665	131979 (1710.7MHz), 132322 (1745.0MHz), 132665 (1779.3MHz)	1.4MHz	256QAM	1 RB / 0 RB Offset 1 RB / 2 RB Offset 1 RB / 5 RB Offset 3 RB / 0 RB Offset 3 RB / 1 RB Offset 3 RB / 3 RB Offset 6 RB / 0 RB Offset
		131987 to 132657	131987 (1711.5MHz), 132322 (1745.0MHz), 132657 (1778.5MHz)	3MHz	256QAM	1 RB / 0 RB Offset 1 RB / 7 RB Offset 1 RB / 14 RB Offset 8 RB / 0 RB Offset 8 RB / 3 RB Offset 8 RB / 7 RB Offset 15 RB / 0 RB Offset
		131997 to 132647	131997 (1712.5MHz), 132322 (1745.0MHz), 132647 (1777.5MHz)	5MHz	256QAM	1 RB / 0 RB Offset 1 RB / 12 RB Offset 1 RB / 24 RB Offset 12 RB / 0 RB Offset 12 RB / 6 RB Offset 12 RB / 13 RB Offset 25 RB / 0 RB Offset
		132022 to 132622	132022 (1715.0MHz), 132322 (1745.0MHz), 132622 (1775.0MHz)	10MHz	256QAM	1 RB / 0 RB Offset 1 RB / 24 RB Offset 1 RB / 49 RB Offset 25 RB / 0 RB Offset 25 RB / 12 RB Offset 25 RB / 25 RB Offset 50 RB / 0 RB Offset
		132047 to 132597	132047 (1717.5MHz), 132322 (1745.0MHz), 132597 (1772.5MHz)	15MHz	256QAM	1 RB / 0 RB Offset 1 RB / 37 RB Offset 1 RB / 74 RB Offset 36 RB / 0 RB Offset 36 RB / 19 RB Offset 36 RB / 39 RB Offset 75 RB / 0 RB Offset
		132072 to 132572	132072 (1720.0MHz), 132322 (1745.0MHz), 132572 (1770.0MHz)	20MHz	256QAM	1 RB / 0 RB Offset 1 RB / 50 RB Offset 1 RB / 99 RB Offset 50 RB / 0 RB Offset 50 RB / 25 RB Offset 50 RB / 50 RB Offset 100 RB / 0 RB Offset
-	Frequency Stability	131979 to 132665	131979 (1710.7MHz), 132665 (1779.3MHz)	1.4MHz	256QAM	6 RB / 0 RB Offset
		131987 to 132657	131987 (1711.5MHz), 132657 (1778.5MHz)	3MHz	256QAM	15 RB / 0 RB Offset
		131997 to 132647	131997 (1712.5MHz), 132647 (1777.5MHz)	5MHz	256QAM	25 RB / 0 RB Offset
		132022 to 132622	132022 (1715.0MHz), 132622 (1775.0MHz)	10MHz	256QAM	50 RB / 0 RB Offset
		132047 to 132597	132047 (1717.5MHz), 132597 (1772.5MHz)	15MHz	256QAM	75 RB / 0 RB Offset
		132072 to 132572	132072 (1720.0MHz), 132572 (1770.0MHz)	20MHz	256QAM	100 RB / 0 RB Offset

EUT Configure Mode	Test Item	Available Channel	Tested Channel	Channel Bandwidth	Modulation	Mode
-	Emission Bandwidth	131979 to 132665	131979 (1710.7MHz), 132322 (1745.0MHz), 132665 (1779.3MHz)	1.4MHz	256QAM	6 RB / 0 RB Offset
		131987 to 132657	131987 (1711.5MHz), 132322 (1745.0MHz), 132657 (1778.5MHz)	3MHz	256QAM	15 RB / 0 RB Offset
		131997 to 132647	131997 (1712.5MHz), 132322 (1745.0MHz), 132647 (1777.5MHz)	5MHz	256QAM	25 RB / 0 RB Offset
		132022 to 132622	132022 (1715.0MHz), 132322 (1745.0MHz), 132622 (1775.0MHz)	10MHz	256QAM	50 RB / 0 RB Offset
		132047 to 132597	132047 (1717.5MHz), 132322 (1745.0MHz), 132597 (1772.5MHz)	15MHz	256QAM	75 RB / 0 RB Offset
		132072 to 132572	132072 (1720.0MHz), 132322 (1745.0MHz), 132572 (1770.0MHz)	20MHz	256QAM	100 RB / 0 RB Offset
-	Band Edge	131979 to 132665	131979 (1710.7MHz), 132665 (1779.3MHz)	1.4MHz	256QAM	1 RB / 0 RB Offset 1 RB / 5 RB Offset 6 RB / 0 RB Offset
		131987 to 132657	131987 (1711.5MHz), 132657 (1778.5MHz)	3MHz	256QAM	1 RB / 0 RB Offset 1 RB / 14 RB Offset 15 RB / 0 RB Offset
		131997 to 132647	131997 (1712.5MHz), 132647 (1777.5MHz)	5MHz	256QAM	1 RB / 0 RB Offset 1 RB / 24 RB Offset 25 RB / 0 RB Offset
		132022 to 132622	132022 (1715.0MHz), 132622 (1775.0MHz)	10MHz	256QAM	1 RB / 0 RB Offset 1 RB / 49 RB Offset 50 RB / 0 RB Offset
		132047 to 132597	132047 (1717.5MHz), 132597 (1772.5MHz)	15MHz	256QAM	1 RB / 0 RB Offset 1 RB / 74 RB Offset 75 RB / 0 RB Offset
		132072 to 132572	132072 (1720.0MHz), 132572 (1770.0MHz)	20MHz	256QAM	1 RB / 0 RB Offset 1 RB / 99 RB Offset 100 RB / 0 RB Offset
-	Peak to Average Ratio	131979 to 132665	131979 (1710.7MHz), 132322 (1745.0MHz), 132665 (1779.3MHz)	1.4MHz	256QAM	1 RB / 0 RB Offset
		131987 to 132657	131987 (1711.5MHz), 132322 (1745.0MHz), 132657 (1778.5MHz)	3MHz	256QAM	1 RB / 0 RB Offset
		131997 to 132647	131997 (1712.5MHz), 132322 (1745.0MHz), 132647 (1777.5MHz)	5MHz	256QAM	1 RB / 0 RB Offset
		132022 to 132622	132022 (1715.0MHz), 132322 (1745.0MHz), 132622 (1775.0MHz)	10MHz	256QAM	1 RB / 0 RB Offset
		132047 to 132597	132047 (1717.5MHz), 132322 (1745.0MHz), 132597 (1772.5MHz)	15MHz	256QAM	1 RB / 0 RB Offset
		132072 to 132572	132072 (1720.0MHz), 132322 (1745.0MHz), 132572 (1770.0MHz)	20MHz	256QAM	1 RB / 0 RB Offset

EUT Configure Mode	Test Item	Available Channel	Tested Channel	Channel Bandwidth	Modulation	Mode
-	Conducted Emission	131979 to 132665	131979 (1710.7MHz), 132322 (1745.0MHz), 132665 (1779.3MHz)	1.4MHz	256QAM	1 RB / 0 RB Offset
		131987 to 132657	131987 (1711.5MHz), 132322 (1745.0MHz), 132657 (1778.5MHz)	3MHz	256QAM	1 RB / 0 RB Offset
		131997 to 132647	131997 (1712.5MHz), 132322 (1745.0MHz), 132647 (1777.5MHz)	5MHz	256QAM	1 RB / 0 RB Offset
		132022 to 132622	132022 (1715.0MHz), 132322 (1745.0MHz), 132622 (1775.0MHz)	10MHz	256QAM	1 RB / 0 RB Offset
		132047 to 132597	132047 (1717.5MHz), 132322 (1745.0MHz), 132597 (1772.5MHz)	15MHz	256QAM	1 RB / 0 RB Offset
		132072 to 132572	132072 (1720.0MHz), 132322 (1745.0MHz), 132572 (1770.0MHz)	20MHz	256QAM	1 RB / 0 RB Offset
-	Radiated Emission Below 1GHz	132072 to 132572	132572 (1770.0MHz)	20MHz	256QAM	1 RB / 0 RB Offset
-	Radiated Emission Above 1GHz	131979 to 132665	131979 (1710.7MHz), 132322 (1745.0MHz), 132665 (1779.3MHz)	1.4MHz	256QAM	1 RB / 0 RB Offset
		131997 to 132647	131997 (1712.5MHz), 132322 (1745.0MHz), 132647 (1777.5MHz)	5MHz	256QAM	1 RB / 0 RB Offset
		132072 to 132572	132072 (1720.0MHz), 132322 (1745.0MHz), 132572 (1770.0MHz)	20MHz	256QAM	1 RB / 0 RB Offset

Note: For radiated emission above 1GHz, according to 3GPP 36.521 Section 6.6.3.1.4, choose the lowest, 5MHz & highest channel bandwidth for final test.

Test Condition:

Test Item	Environmental Conditions	Input Power (system)	Tested By
ERP / EIRP	25deg. C, 70%RH	5Vdc	James Yang
Modulation characteristics	24deg. C, 64%RH	5Vdc	James Yang
Frequency Stability	24deg. C, 64%RH	5Vdc	James Yang
Occupied Bandwidth	24deg. C, 64%RH	5Vdc	James Yang
Band Edge	24deg. C, 64%RH	5Vdc	James Yang
Peak To Average Ratio	24deg. C, 64%RH	5Vdc	James Yang
Conducted Emission	24deg. C, 64%RH	5Vdc	James Yang
Radiated Emission	22deg. C, 68%RH 24deg. C, 64%RH	120Vac, 60Hz	Greg Lin Match Tsui

3.4 EUT Operating Conditions

The EUT makes a call to the communication simulator. The communication simulator station system controlled a EUT to export maximum output power under transmission mode and specific channel frequency

3.5 General Description of Applied Standards and References

The EUT is a RF Product. According to the specifications of the manufacturer, it must comply with the requirements of the following standards and References:

Test Standard:

FCC 47 CFR Part 2

FCC 47 CFR Part 24

FCC 47 CFR Part 27

ANSI/TIA/EIA-603-D-2010

ANSI/TIA/EIA-603-E 2016

ANSI 63.26-2015

All test items have been performed and recorded as per the above standards.

References Test Guidance:

KDB 971168 D01 Power Meas License Digital Systems v03r01

KDB 971168 D02 Misc Rev Approv License Devices v02r01

All test items have been performed as a reference to the above KDB test guidance.

4 Test Types and Results

4.1 Output Power Measurement

4.1.1 Limits of Output Power Measurement

For n71:

Control and mobile stations in the 698-746 MHz, 746-757 MHz, 787-788 MHz and 805-806 MHz band are limited to 30 watts ERP.

Portable stations (hand-held devices) in the 600 MHz uplink band and the 698-746 MHz band, and fixed and mobile stations in the 600 MHz uplink, 746-757 MHz, 787-788 MHz and 805-806 MHz band are limited to 3 watts ERP.

For LTE Band 2:

Mobile / Portable station are limited to 2 watts e.r.p.

For LTE Band 7:

Mobile stations are limited to 2.0 watts EIRP. All user stations are limited to 2.0 watts transmitter output power.

For LTE Band 66:

Mobile / Portable station are limited to 1 watts e.i.r.p.

4.1.2 Test Procedures

Conducted Power Measurement:

The EUT was set up for the maximum power with 5GNR link data modulation and link up with simulator. Set the EUT to transmit under low, middle and high channel and record the power level shown on simulator.

Maximum EIRP

The relevant equation for determining the maximum ERP or EIRP from the measured RF output power is given in Equation as follows:

$$\text{ERP or EIRP} = P_{\text{Meas}} + G_{\text{T}}$$

where

ERP or EIRP effective radiated power or equivalent isotropically radiated power, respectively (expressed in the same units as P_{Meas} , e.g., dBm or dBW)

P_{Meas} measured transmitter output power or PSD, in dBm or dBW

G_{T} gain of the transmitting antenna, in dBd (ERP) or dBi (EIRP)

4.1.3 Test Setup

Conducted Power Measurement:

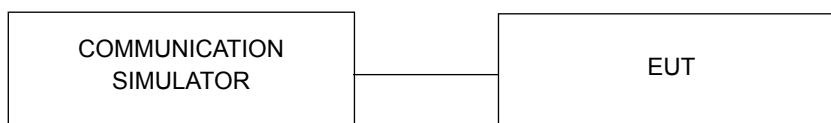

For the actual test configuration, please refer to the attached file (Test Setup Photo).

4.1.4 Test Results

Conducted Output Power (dBm)

n71						
BW	MCS Index	Channel		133100	136100	139100
		Frequency (MHz)		665.5	680.5	695.5
5M	$\pi/2$ BPSK	1	0	22.86	22.87	22.91
		1	12	23.13	23.05	23.01
		1	24	22.73	23.05	23.16
		12	0	22.87	22.54	22.97
		12	6	22.87	22.93	22.56
		12	13	22.55	22.53	22.90
		25	0	22.63	22.95	22.59
	QPSK	1	0	22.82	22.90	22.94
		1	12	22.85	22.88	22.93
		1	24	23.00	22.91	22.89
		12	0	22.61	22.70	22.87
		12	6	22.80	22.83	22.77
		12	13	22.83	22.68	22.78
		25	0	22.70	22.77	22.76
	16QAM	1	0	22.87	22.82	22.82
		1	12	22.51	22.53	22.65
		1	24	22.82	22.62	22.66
		12	0	22.50	22.68	22.37
		12	6	22.51	22.35	22.31
		12	13	22.70	22.68	22.61
		25	0	22.35	22.61	22.44
	64QAM	1	0	22.41	22.29	22.43
		1	12	22.39	22.17	22.16
		1	24	22.22	22.60	22.46
		12	0	22.38	22.04	22.25
		12	6	21.90	22.01	22.19
		12	13	22.34	21.94	22.14
		25	0	22.30	22.29	22.03
	256QAM	1	0	20.18	19.62	19.85
		1	12	20.13	20.23	20.13
		1	24	20.11	20.14	19.77
		12	0	19.24	19.12	19.79
		12	6	19.28	19.60	19.81
		12	13	19.63	19.89	19.88
		25	0	19.89	19.90	19.85

n71						
BW	MCS Index	Channel		133600	136100	138600
		Frequency (MHz)		668	680.5	693
10M	$\pi/2$ BPSK	1	0	22.72	23.01	23.13
		1	26	23.10	23.07	23.00
		1	51	22.85	22.99	22.90
		26	0	22.83	22.52	22.89
		26	13	22.83	22.50	22.81
		26	26	22.55	22.78	22.84
		52	0	22.78	22.86	22.58
	QPSK	1	0	22.92	23.08	22.96
		1	26	22.96	22.92	23.06
		1	51	22.91	23.10	22.95
		26	0	22.67	22.60	22.61
		26	13	22.68	22.69	22.64
		26	26	22.67	22.87	22.78
		52	0	22.81	22.81	22.70
	16QAM	1	0	22.51	22.74	22.67
		1	26	22.51	22.57	22.51
		1	51	22.66	22.89	22.53
		26	0	22.32	22.47	22.55
		26	13	22.64	22.54	22.31
		26	26	22.39	22.52	22.61
		52	0	22.68	22.33	22.46
	64QAM	1	0	22.59	22.28	22.11
		1	26	22.55	22.22	22.14
		1	51	22.13	22.36	22.33
		26	0	22.23	22.19	22.37
		26	13	22.05	22.31	22.00
		26	26	22.07	22.14	22.15
		52	0	22.37	22.11	22.11
	256QAM	1	0	19.67	19.70	20.26
		1	26	19.60	19.71	20.29
		1	51	19.95	20.07	19.86
		26	0	19.56	19.50	19.70
		26	13	20.00	19.32	19.40
		26	26	19.18	19.17	19.60
		52	0	19.14	19.43	19.78

n71						
BW	MCS Index	Channel		134100	136100	138100
		Frequency (MHz)		670.5	680.5	690.5
15M	$\pi/2$ BPSK	1	0	22.86	23.03	23.17
		1	39	23.10	22.94	22.91
		1	78	22.73	22.70	23.00
		39	0	22.65	22.76	22.57
		39	19	22.94	22.99	22.96
		39	40	22.78	22.64	22.89
		79	0	22.52	22.67	22.87
	QPSK	1	0	23.02	22.98	22.98
		1	39	23.03	22.88	22.85
		1	78	23.10	23.03	23.02
		39	0	22.89	22.63	22.86
		39	19	22.84	22.87	22.74
		39	40	22.79	22.85	22.77
		79	0	22.79	22.70	22.90
	16QAM	1	0	22.59	22.79	22.78
		1	39	22.90	22.57	22.75
		1	78	22.54	22.71	22.55
		39	0	22.52	22.50	22.63
		39	19	22.40	22.32	22.67
		39	40	22.66	22.61	22.58
		79	0	22.35	22.40	22.61
	64QAM	1	0	22.14	22.16	22.31
		1	39	22.38	22.52	22.23
		1	78	22.38	22.30	22.46
		39	0	22.10	21.91	21.96
		39	19	22.30	22.02	21.99
		39	40	22.04	22.17	22.03
		79	0	22.23	22.10	21.96
	256QAM	1	0	20.28	19.97	20.27
		1	39	20.20	19.75	19.60
		1	78	19.81	20.17	19.75
		39	0	19.32	19.38	19.83
		39	19	19.50	19.70	19.79
		39	40	19.69	19.94	19.80
		79	0	19.97	19.43	19.37

n71						
BW	MCS Index	Channel		134600	136100	137600
		Frequency (MHz)		673	680.5	688
20M	$\pi/2$ BPSK	1	0	23.00	22.73	23.16
		1	53	23.03	23.19	22.79
		1	105	23.03	22.89	23.03
		50	0	22.65	22.95	22.79
		50	25	22.97	22.51	22.95
		50	50	22.56	22.97	22.52
		100	0	23.00	22.93	23.00
	QPSK	1	0	22.90	22.99	23.02
		1	53	23.08	22.85	22.86
		1	105	22.93	22.91	22.84
		50	0	22.60	22.74	22.81
		50	25	22.88	22.60	22.63
		50	50	22.87	22.68	22.72
		100	0	22.85	22.72	22.88
	16QAM	1	0	22.85	22.87	22.52
		1	53	22.51	22.80	22.69
		1	105	22.78	22.89	22.65
		50	0	22.61	22.68	22.45
		50	25	22.57	22.31	22.45
		50	50	22.47	22.64	22.37
		100	0	22.40	22.69	22.64
	64QAM	1	0	22.42	22.29	22.35
		1	53	22.44	22.60	22.38
		1	105	22.20	22.30	22.58
		50	0	22.34	22.33	22.11
		50	25	22.19	22.36	22.13
		50	50	22.37	21.98	22.11
		100	0	22.23	21.96	22.40
	256QAM	1	0	20.06	19.79	19.95
		1	53	20.15	19.86	20.30
		1	105	19.71	19.95	20.22
		50	0	19.59	19.47	19.87
		50	25	19.23	19.67	19.25
		50	50	19.80	19.89	19.37
		100	0	19.99	19.21	19.31

LTE Band 2						
BW	MCS Index	RB Size	RB Offset	Low	Mid	High
		Channel		18607	18900	19193
		Frequency (MHz)		1850.7	1880	1909.3
1.4M	256QAM	1	0	19.76	19.75	19.91
		1	2	19.89	20.55	19.97
		1	5	20.20	20.04	19.98
		3	0	20.04	19.93	19.69
		3	1	19.70	20.24	19.68
		3	3	19.82	19.73	19.79
		6	0	19.91	20.21	19.92
BW	MCS Index	Channel		18615	18900	19185
		Frequency (MHz)		1851.5	1880	1908.5
3M	256QAM	1	0	19.71	20.44	19.91
		1	7	19.80	19.83	20.02
		1	14	19.62	19.87	19.96
		8	0	19.68	20.20	19.76
		8	3	20.23	20.12	19.81
		8	7	20.11	19.94	19.79
		15	0	19.93	20.03	19.82
BW	MCS Index	Channel		18625	18900	19175
		Frequency (MHz)		1852.5	1880	1907.5
5M	256QAM	1	0	20.27	19.77	20.08
		1	12	19.81	19.83	20.09
		1	24	19.62	19.92	19.85
		12	0	20.28	20.20	20.11
		12	6	20.02	20.25	19.72
		12	13	19.64	20.12	19.70
		25	0	19.87	19.74	19.84
BW	MCS Index	Channel		18650	18900	19150
		Frequency (MHz)		1855	1880	1905
10M	256QAM	1	0	20.23	19.76	19.69
		1	24	20.10	19.96	20.08
		1	49	19.78	20.09	19.67
		25	0	20.51	19.81	19.78
		25	12	20.06	19.76	20.08
		25	25	20.13	20.24	20.03
		50	0	19.74	19.90	19.87

LTE Band 2						
BW	MCS Index	Channel		18675	18900	19125
		Frequency (MHz)		1857.5	1880	1902.5
15M	256QAM	1	0	20.26	20.01	20.03
		1	37	20.26	20.02	19.75
		1	74	19.89	20.08	19.98
		36	0	19.70	20.00	19.78
		36	19	19.75	19.75	19.76
		36	39	19.87	20.01	19.79
		75	0	20.00	19.81	19.90
BW	MCS Index	Channel		18700	18900	19100
		Frequency (MHz)		1860	1880	1900
20M	256QAM	1	0	19.98	20.01	19.83
		1	50	19.82	20.08	19.71
		1	99	19.62	20.04	19.86
		50	0	19.61	20.21	19.68
		50	25	20.19	19.72	19.81
		50	50	19.63	19.82	19.98
		100	0	19.98	20.13	19.88

LTE Band 7						
BW	MCS Index	Channel		20775	21100	21425
		Frequency (MHz)		2502.5	2535	2567.5
5M	256QAM	1	0	19.61	19.72	19.63
		1	12	19.88	20.66	20.24
		1	24	20.11	19.65	19.92
		12	0	20.04	19.53	19.94
		12	6	20.08	19.78	19.54
		12	13	19.81	20.12	19.82
		25	0	20.10	19.72	19.87
BW	MCS Index	Channel		20800	21100	21400
		Frequency (MHz)		2505	2535	2565
10M	256QAM	1	0	20.17	19.79	19.51
		1	24	19.77	19.96	19.61
		1	49	20.04	19.61	19.69
		25	0	19.84	19.70	20.15
		25	12	20.16	20.00	20.11
		25	25	20.03	19.84	20.17
		50	0	19.74	19.51	19.79
BW	MCS Index	Channel		20825	21100	21375
		Frequency (MHz)		2507.5	2535	2562.5
15M	256QAM	1	0	20.17	19.68	20.02
		1	37	19.96	19.85	19.91
		1	74	19.78	20.10	19.90
		36	0	19.90	19.57	19.83
		36	19	19.64	20.10	19.98
		36	39	19.80	19.63	20.04
		75	0	19.69	19.97	20.18
BW	MCS Index	Channel		20850	21100	21350
		Frequency (MHz)		2510	2535	2560
20M	256QAM	1	0	19.77	19.58	19.87
		1	50	19.89	20.08	19.96
		1	99	19.70	19.99	19.51
		50	0	19.87	19.78	19.68
		50	25	19.85	19.79	19.67
		50	50	20.16	20.02	19.74
		100	0	20.16	20.08	19.57

LTE Band 66						
BW	MCS Index	Channel		131979	132322	132665
		Frequency (MHz)		1710.7	1745	1779.3
1.4M	256QAM	1	0	19.51	19.84	19.95
		1	2	19.82	19.57	19.68
		1	5	20.15	19.64	19.68
		3	0	20.12	19.65	19.79
		3	1	19.98	19.49	20.16
		3	3	19.56	19.90	19.97
		6	0	19.61	20.06	20.15
BW	MCS Index	Channel		131987	132322	132657
		Frequency (MHz)		1711.5	1745	1778.5
3M	256QAM	1	0	19.81	19.88	20.07
		1	7	19.91	19.74	20.11
		1	14	19.56	19.87	20.20
		8	0	19.80	19.73	19.80
		8	3	20.19	19.77	20.17
		8	7	20.24	19.59	19.98
		15	0	19.81	19.80	19.97
BW	MCS Index	Channel		131997	132322	132647
		Frequency (MHz)		1712.5	1745	1777.5
5M	256QAM	1	0	19.91	19.92	20.11
		1	12	20.20	19.69	19.72
		1	24	20.01	19.76	20.13
		12	0	19.95	19.97	19.83
		12	6	19.96	19.79	19.71
		12	13	19.76	19.89	19.71
		25	0	20.04	19.52	20.20

LTE Band 66						
BW	MCS Index	Channel		132022	132322	132622
		Frequency (MHz)		1715	1745	1775
10M	256QAM	1	0	19.65	19.52	19.68
		1	24	20.13	19.67	20.07
		1	49	20.22	20.09	19.88
		25	0	20.20	19.50	19.96
		25	12	20.20	19.69	20.21
		25	25	19.99	19.73	20.00
		50	0	19.68	19.85	20.14
BW	MCS Index	Channel		132047	132322	132597
		Frequency (MHz)		1717.5	1745	1772.5
15M	256QAM	1	0	20.01	20.26	19.95
		1	37	19.64	19.80	20.03
		1	74	20.22	19.79	19.73
		36	0	19.94	19.96	19.94
		36	19	20.04	19.82	19.73
		36	39	20.10	19.67	19.94
		75	0	19.77	20.00	20.17
BW	MCS Index	Channel		132072	132322	132575
		Frequency (MHz)		1720	1745	1770
20M	256QAM	1	0	20.25	20.03	19.70
		1	50	19.62	19.81	19.80
		1	99	19.66	20.12	19.70
		50	0	19.67	19.54	19.78
		50	25	19.63	19.96	20.03
		50	50	19.97	20.01	19.88
		100	0	20.15	20.01	19.95

ERP Power (dBm)

n71						
BW	MCS Index	Channel		133100	136100	139100
		Frequency (MHz)		665.5	680.5	695.5
5M	$\pi/2$ BPSK	1	0	25.12	25.13	25.17
		1	12	25.39	25.31	25.27
		1	24	24.99	25.31	25.42
		12	0	25.13	24.80	25.23
		12	6	25.13	25.19	24.82
		12	13	24.81	24.79	25.16
		25	0	24.89	25.21	24.85
	QPSK	1	0	25.08	25.16	25.20
		1	12	25.11	25.14	25.19
		1	24	25.26	25.17	25.15
		12	0	24.87	24.96	25.13
		12	6	25.06	25.09	25.03
		12	13	25.09	24.94	25.04
		25	0	24.96	25.03	25.02
	16QAM	1	0	25.13	25.08	25.08
		1	12	24.77	24.79	24.91
		1	24	25.08	24.88	24.92
		12	0	24.76	24.94	24.63
		12	6	24.77	24.61	24.57
		12	13	24.96	24.94	24.87
		25	0	24.61	24.87	24.70
	64QAM	1	0	24.67	24.55	24.69
		1	12	24.65	24.43	24.42
		1	24	24.48	24.86	24.72
		12	0	24.64	24.30	24.51
		12	6	24.16	24.27	24.45
		12	13	24.60	24.20	24.40
		25	0	24.56	24.55	24.29
	256QAM	1	0	22.44	21.88	22.11
		1	12	22.39	22.49	22.39
		1	24	22.37	22.40	22.03
		12	0	21.50	21.38	22.05
		12	6	21.54	21.86	22.07
		12	13	21.89	22.15	22.14
		25	0	22.15	22.16	22.11

*ERP = Conducted + antenna gain (4.41dBi)-2.15

n71						
BW	MCS Index	Channel		133600	136100	138600
		Frequency (MHz)		668	680.5	693
10M	$\pi/2$ BPSK	1	0	24.98	25.27	25.39
		1	26	25.36	25.33	25.26
		1	51	25.11	25.25	25.16
		26	0	25.09	24.78	25.15
		26	13	25.09	24.76	25.07
		26	26	24.81	25.04	25.10
		52	0	25.04	25.12	24.84
	QPSK	1	0	25.18	25.34	25.22
		1	26	25.22	25.18	25.32
		1	51	25.17	25.36	25.21
		26	0	24.93	24.86	24.87
		26	13	24.94	24.95	24.90
		26	26	24.93	25.13	25.04
		52	0	25.07	25.07	24.96
	16QAM	1	0	24.77	25.00	24.93
		1	26	24.77	24.83	24.77
		1	51	24.92	25.15	24.79
		26	0	24.58	24.73	24.81
		26	13	24.90	24.80	24.57
		26	26	24.65	24.78	24.87
		52	0	24.94	24.59	24.72
	64QAM	1	0	24.85	24.54	24.37
		1	26	24.81	24.48	24.40
		1	51	24.39	24.62	24.59
		26	0	24.49	24.45	24.63
		26	13	24.31	24.57	24.26
		26	26	24.33	24.40	24.41
		52	0	24.63	24.37	24.37
	256QAM	1	0	21.93	21.96	22.52
		1	26	21.86	21.97	22.55
		1	51	22.21	22.33	22.12
		26	0	21.82	21.76	21.96
		26	13	22.26	21.58	21.66
		26	26	21.44	21.43	21.86
		52	0	21.40	21.69	22.04

*ERP = Conducted + antenna gain (4.41dBi)-2.15

n71						
BW	MCS Index	Channel		134100	136100	138100
		Frequency (MHz)		670.5	680.5	690.5
15M	$\pi/2$ BPSK	1	0	25.12	25.29	25.43
		1	39	25.36	25.20	25.17
		1	78	24.99	24.96	25.26
		39	0	24.91	25.02	24.83
		39	19	25.20	25.25	25.22
		39	40	25.04	24.90	25.15
		79	0	24.78	24.93	25.13
	QPSK	1	0	25.28	25.24	25.24
		1	39	25.29	25.14	25.11
		1	78	25.36	25.29	25.28
		39	0	25.15	24.89	25.12
		39	19	25.10	25.13	25.00
		39	40	25.05	25.11	25.03
		79	0	25.05	24.96	25.16
	16QAM	1	0	24.85	25.05	25.04
		1	39	25.16	24.83	25.01
		1	78	24.80	24.97	24.81
		39	0	24.78	24.76	24.89
		39	19	24.66	24.58	24.93
		39	40	24.92	24.87	24.84
		79	0	24.61	24.66	24.87
	64QAM	1	0	24.40	24.42	24.57
		1	39	24.64	24.78	24.49
		1	78	24.64	24.56	24.72
		39	0	24.36	24.17	24.22
		39	19	24.56	24.28	24.25
		39	40	24.30	24.43	24.29
		79	0	24.49	24.36	24.22
	256QAM	1	0	22.54	22.23	22.53
		1	39	22.46	22.01	21.86
		1	78	22.07	22.43	22.01
		39	0	21.58	21.64	22.09
		39	19	21.76	21.96	22.05
		39	40	21.95	22.20	22.06
		79	0	22.23	21.69	21.63

*ERP = Conducted + antenna gain (4.41dBi)-2.15

n71						
BW	MCS Index	Channel		134600	136100	137600
		Frequency (MHz)		673	680.5	688
20M	$\pi/2$ BPSK	1	0	25.26	24.99	25.42
		1	53	25.29	25.45	25.05
		1	105	25.29	25.15	25.29
		50	0	24.91	25.21	25.05
		50	25	25.23	24.77	25.21
		50	50	24.82	25.23	24.78
		106	0	25.26	25.19	25.26
	QPSK	1	0	25.16	25.25	25.28
		1	53	25.34	25.11	25.12
		1	105	25.19	25.17	25.10
		50	0	24.86	25.00	25.07
		50	25	25.14	24.86	24.89
		50	50	25.13	24.94	24.98
		106	0	25.11	24.98	25.14
	16QAM	1	0	25.11	25.13	24.78
		1	53	24.77	25.06	24.95
		1	105	25.04	25.15	24.91
		50	0	24.87	24.94	24.71
		50	25	24.83	24.57	24.71
		50	50	24.73	24.90	24.63
		106	0	24.66	24.95	24.90
	64QAM	1	0	24.68	24.55	24.61
		1	53	24.70	24.86	24.64
		1	105	24.46	24.56	24.84
		50	0	24.60	24.59	24.37
		50	25	24.45	24.62	24.39
		50	50	24.63	24.24	24.37
		106	0	24.49	24.22	24.66
	256QAM	1	0	22.32	22.05	22.21
		1	53	22.41	22.12	22.56
1		105	21.97	22.21	22.48	
50		0	21.85	21.73	22.13	
50		25	21.49	21.93	21.51	
50		50	22.06	22.15	21.63	
106		0	22.25	21.47	21.57	

*ERP = Conducted + antenna gain (4.41dBi)-2.15

EIRP

LTE Band 2						
BW	MCS Index	RB Size	RB Offset	Low	Mid	High
		Channel		18607	18900	19193
		Frequency (MHz)		1850.7	1880	1909.3
1.4M	256QAM	1	0	24.03	24.02	24.18
		1	2	24.16	24.82	24.24
		1	5	24.47	24.31	24.25
		3	0	24.31	24.20	23.96
		3	1	23.97	24.51	23.95
		3	3	24.09	24.00	24.06
		6	0	24.18	24.48	24.19
BW	MCS Index	Channel		18615	18900	19185
		Frequency (MHz)		1851.5	1880	1908.5
3M	256QAM	1	0	23.98	24.71	24.18
		1	7	24.07	24.10	24.29
		1	14	23.89	24.14	24.23
		8	0	23.95	24.47	24.03
		8	3	24.50	24.39	24.08
		8	7	24.38	24.21	24.06
		15	0	24.20	24.30	24.09
BW	MCS Index	Channel		18625	18900	19175
		Frequency (MHz)		1852.5	1880	1907.5
5M	256QAM	1	0	24.54	24.04	24.35
		1	12	24.08	24.10	24.36
		1	24	23.89	24.19	24.12
		12	0	24.55	24.47	24.38
		12	6	24.29	24.52	23.99
		12	13	23.91	24.39	23.97
		25	0	24.14	24.01	24.11
BW	MCS Index	Channel		18650	18900	19150
		Frequency (MHz)		1855	1880	1905
10M	256QAM	1	0	24.50	24.03	23.96
		1	24	24.37	24.23	24.35
		1	49	24.05	24.36	23.94
		25	0	24.78	24.08	24.05
		25	12	24.33	24.03	24.35
		25	25	24.40	24.51	24.30
		50	0	24.01	24.17	24.14

*EIRP = Conducted + antenna gain (4.27dBi)

LTE Band 2						
BW	MCS Index	Channel		18675	18900	19125
		Frequency (MHz)		1857.5	1880	1902.5
15M	256QAM	1	0	24.53	24.28	24.30
		1	37	24.53	24.29	24.02
		1	74	24.16	24.35	24.25
		36	0	23.97	24.27	24.05
		36	19	24.02	24.02	24.03
		36	39	24.14	24.28	24.06
		75	0	24.27	24.08	24.17
BW	MCS Index	Channel		18700	18900	19100
		Frequency (MHz)		1860	1880	1900
20M	256QAM	1	0	24.25	24.28	24.10
		1	50	24.09	24.35	23.98
		1	99	23.89	24.31	24.13
		50	0	23.88	24.48	23.95
		50	25	24.46	23.99	24.08
		50	50	23.90	24.09	24.25
		100	0	24.25	24.40	24.15

*EIRP = Conducted + antenna gain (4.27dBi)

LTE Band 7						
BW	MCS Index	Channel		20775	21100	21425
		Frequency (MHz)		2502.5	2535	2567.5
5M	256QAM	1	0	24.92	25.03	24.94
		1	12	25.19	25.97	25.55
		1	24	25.42	24.96	25.23
		12	0	25.35	24.84	25.25
		12	6	25.39	25.09	24.85
		12	13	25.12	25.43	25.13
		25	0	25.41	25.03	25.18
BW	MCS Index	Channel		20800	21100	21400
		Frequency (MHz)		2505	2535	2565
10M	256QAM	1	0	25.48	25.10	24.82
		1	24	25.08	25.27	24.92
		1	49	25.35	24.92	25.00
		25	0	25.15	25.01	25.46
		25	12	25.47	25.31	25.42
		25	25	25.34	25.15	25.48
		50	0	25.05	24.82	25.10
BW	MCS Index	Channel		20825	21100	21375
		Frequency (MHz)		2507.5	2535	2562.5
15M	256QAM	1	0	25.48	24.99	25.33
		1	37	25.27	25.16	25.22
		1	74	25.09	25.41	25.21
		36	0	25.21	24.88	25.14
		36	19	24.95	25.41	25.29
		36	39	25.11	24.94	25.35
		75	0	25.00	25.28	25.49
BW	MCS Index	Channel		20850	21100	21350
		Frequency (MHz)		2510	2535	2560
20M	256QAM	1	0	25.08	24.89	25.18
		1	50	25.20	25.39	25.27
		1	99	25.01	25.30	24.82
		50	0	25.18	25.09	24.99
		50	25	25.16	25.10	24.98
		50	50	25.47	25.33	25.05
		100	0	25.47	25.39	24.88

*EIRP = Conducted + antenna gain (5.31dBi)

LTE Band 66						
BW	MCS Index	Channel		131979	132322	132665
		Frequency (MHz)		1710.7	1745	1779.3
1.4M	256QAM	1	0	23.78	24.11	24.22
		1	2	24.09	23.84	23.95
		1	5	24.42	23.91	23.95
		3	0	24.39	23.92	24.06
		3	1	24.25	23.76	24.43
		3	3	23.83	24.17	24.24
		6	0	23.88	24.33	24.42
BW	MCS Index	Channel		131987	132322	132657
		Frequency (MHz)		1711.5	1745	1778.5
3M	256QAM	1	0	24.08	24.15	24.34
		1	7	24.18	24.01	24.38
		1	14	23.83	24.14	24.47
		8	0	24.07	24.00	24.07
		8	3	24.46	24.04	24.44
		8	7	24.51	23.86	24.25
		15	0	24.08	24.07	24.24
BW	MCS Index	Channel		131997	132322	132647
		Frequency (MHz)		1712.5	1745	1777.5
5M	256QAM	1	0	24.18	24.19	24.38
		1	12	24.47	23.96	23.99
		1	24	24.28	24.03	24.40
		12	0	24.22	24.24	24.10
		12	6	24.23	24.06	23.98
		12	13	24.03	24.16	23.98
		25	0	24.31	23.79	24.47

*EIRP = Conducted + antenna gain (4.27dBi)

LTE Band 66						
BW	MCS Index	Channel		132022	132322	132622
		Frequency (MHz)		1715	1745	1775
10M	256QAM	1	0	23.92	23.79	23.95
		1	24	24.40	23.94	24.34
		1	49	24.49	24.36	24.15
		25	0	24.47	23.77	24.23
		25	12	24.47	23.96	24.48
		25	25	24.26	24.00	24.27
		50	0	23.95	24.12	24.41
BW	MCS Index	Channel		132047	132322	132597
		Frequency (MHz)		1717.5	1745	1772.5
15M	256QAM	1	0	24.28	24.53	24.22
		1	37	23.91	24.07	24.30
		1	74	24.49	24.06	24.00
		36	0	24.21	24.23	24.21
		36	19	24.31	24.09	24.00
		36	39	24.37	23.94	24.21
		75	0	24.04	24.27	24.44
BW	MCS Index	Channel		132072	132322	132575
		Frequency (MHz)		1720	1745	1770
20M	256QAM	1	0	24.52	24.30	23.97
		1	50	23.89	24.08	24.07
		1	99	23.93	24.39	23.97
		50	0	23.94	23.81	24.05
		50	25	23.90	24.23	24.30
		50	50	24.24	24.28	24.15
		100	0	24.42	24.28	24.22

*EIRP = Conducted + antenna gain (4.27dBi)

4.2 Modulation Characteristics Measurement

4.2.1 Limits of Modulation Characteristics

N/A

4.2.2 Test Procedure

Connect the EUT to Communication Simulator via the antenna connector, The frequency band is set as EUT supported Modulation and Channels, the EUT output is matched with 50 ohm load, the waveform quality and constellation of the EUT was tested.

4.2.3 Test Setup



4.2.4 Test Results



4.3 Frequency Stability Measurement

4.3.1 Limits of Frequency Stability Measurement

1.5 ppm is for base and fixed station. 2.5 ppm is for mobile station.

4.3.2 Test Procedure

- Device is placed at the oven room. The oven room could control the temperatures and humidity. Power warm up is at least 15 min and power applied should perform before recording frequency error.
- EUT is connected the external power supply to control the DC input power. The test voltage range is from minimum to maximum working voltage. Each step shall be record the frequency error rate.
- The temperature range step is 10 degrees in this test items. All temperature levels shall be hold the ± 0.5 °C during the measurement testing. The each temperature step shall be at least 0.5 hours, consider the EUT could be test under the stability condition.

Note: The frequency error was recorded frequency error from the communication simulator.

4.3.3 Test Setup

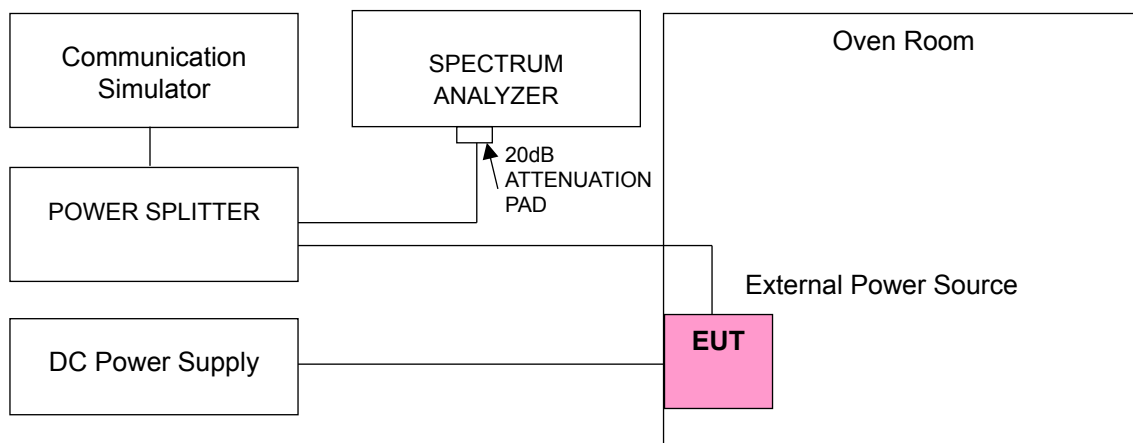

4.3.4 Test Results

Frequency Error vs. Voltage

Voltage (Volts)	n71			
	Channel Bandwidth: 5 MHz			
	Low Channel		High Channel	
	Frequency (MHz)	Frequency Error (ppm)	Frequency (MHz)	Frequency Error (ppm)
4.25	665.500003	0.004	695.500002	0.003
5	665.500001	0.002	695.500003	0.004
5.75	665.500004	0.006	695.500003	0.004

Note: The applicant defined the normal working voltage is from 4.25Vdc to 5.75Vdc.

Frequency Error vs. Temperature

Temp. (°C)	n71			
	Channel Bandwidth: 5 MHz			
	Low Channel		High Channel	
	Frequency (MHz)	Frequency Error (ppm)	Frequency (MHz)	Frequency Error (ppm)
-30	665.500001	0.002	695.500004	0.006
-20	665.500003	0.004	695.500001	0.002
-10	665.500004	0.006	695.500003	0.004
0	665.500002	0.004	695.500002	0.003
10	665.500003	0.005	695.500003	0.004
20	665.499997	-0.005	695.499997	-0.005
30	665.499996	-0.006	695.499997	-0.005
40	665.499998	-0.003	695.499998	-0.003
50	665.499997	-0.005	695.499999	-0.002

Frequency Error vs. Voltage

Voltage (Volts)	n71			
	Channel Bandwidth: 10 MHz			
	Low Channel		High Channel	
	Frequency (MHz)	Frequency Error (ppm)	Frequency (MHz)	Frequency Error (ppm)
4.25	668.000004	0.005	693.000003	0.004
5	668.000002	0.003	693.000001	0.002
5.75	668.000004	0.006	693.000002	0.003

Note: The applicant defined the normal working voltage is from 4.25Vdc to 5.75Vdc.

Frequency Error vs. Temperature

Temp. (°C)	n71			
	Channel Bandwidth: 10 MHz			
	Low Channel		High Channel	
	Frequency (MHz)	Frequency Error (ppm)	Frequency (MHz)	Frequency Error (ppm)
-30	668.000003	0.004	693.000001	0.001
-20	668.000004	0.006	693.000003	0.004
-10	668.000004	0.006	693.000002	0.002
0	668.000003	0.004	693.000001	0.001
10	668.000001	0.002	693.000004	0.006
20	667.999997	-0.004	692.999998	-0.003
30	667.999996	-0.006	692.999997	-0.004
40	667.999999	-0.002	692.999998	-0.003
50	667.999998	-0.003	692.999999	-0.002

Frequency Error vs. Voltage

Voltage (Volts)	n71			
	Channel Bandwidth: 15 MHz			
	Low Channel		High Channel	
	Frequency (MHz)	Frequency Error (ppm)	Frequency (MHz)	Frequency Error (ppm)
4.25	670.500002	0.003	690.500004	0.006
5	670.500003	0.005	690.500002	0.002
5.75	670.500004	0.005	690.500004	0.006

Note: The applicant defined the normal working voltage is from 4.25Vdc to 5.75Vdc.

Frequency Error vs. Temperature

Temp. (°C)	n71			
	Channel Bandwidth: 15 MHz			
	Low Channel		High Channel	
	Frequency (MHz)	Frequency Error (ppm)	Frequency (MHz)	Frequency Error (ppm)
-30	670.500003	0.004	690.500003	0.004
-20	670.500001	0.002	690.500002	0.003
-10	670.500003	0.005	690.500001	0.001
0	670.500002	0.002	690.500003	0.004
10	670.500001	0.002	690.500003	0.004
20	670.499997	-0.004	690.499997	-0.005
30	670.499997	-0.005	690.499998	-0.003
40	670.499997	-0.005	690.499997	-0.005
50	670.499998	-0.004	690.499998	-0.003

Frequency Error vs. Voltage

Voltage (Volts)	n71			
	Channel Bandwidth: 20 MHz			
	Low Channel		High Channel	
	Frequency (MHz)	Frequency Error (ppm)	Frequency (MHz)	Frequency Error (ppm)
4.25	673.000002	0.003	688.000003	0.004
5	673.000001	0.002	688.000003	0.005
5.75	673.000001	0.001	688.000003	0.004

Note: The applicant defined the normal working voltage is from 4.25Vdc to 5.75Vdc.

Frequency Error vs. Temperature

Temp. (°C)	n71			
	Channel Bandwidth: 20 MHz			
	Low Channel		High Channel	
	Frequency (MHz)	Frequency Error (ppm)	Frequency (MHz)	Frequency Error (ppm)
-30	673.000002	0.003	688.000004	0.005
-20	673.000003	0.005	688.000001	0.002
-10	673.000003	0.004	688.000002	0.002
0	673.000002	0.003	688.000003	0.005
10	673.000003	0.004	688.000003	0.004
20	672.999997	-0.005	687.999997	-0.005
30	672.999997	-0.004	687.999999	-0.002
40	672.999997	-0.005	687.999997	-0.005
50	672.999997	-0.005	687.999996	-0.005

Frequency Error vs. Voltage

Voltage (Volts)	LTE Band 2			
	Channel Bandwidth: 1.4 MHz			
	Low Channel		High Channel	
	Frequency (MHz)	Frequency Error (ppm)	Frequency (MHz)	Frequency Error (ppm)
4.25	1850.700001	0.001	1909.300000	0.001
5	1850.700003	0.002	1909.300002	0.001
5.75	1850.700003	0.002	1909.300001	0.001

Note: The applicant defined the normal working voltage is from 4.25Vdc to 5.75Vdc.

Frequency Error vs. Temperature

Temp. (°C)	LTE Band 2			
	Channel Bandwidth: 1.4 MHz			
	Low Channel		High Channel	
	Frequency (MHz)	Frequency Error (ppm)	Frequency (MHz)	Frequency Error (ppm)
-30	1850.700001	0.001	1909.300004	0.002
-20	1850.700003	0.002	1909.300003	0.002
-10	1850.700002	0.001	1909.300004	0.002
0	1850.700001	0.001	1909.300003	0.002
10	1850.700002	0.001	1909.300003	0.001
20	1850.699999	-0.001	1909.299998	-0.001
30	1850.699996	-0.002	1909.299997	-0.002
40	1850.699997	-0.001	1909.299997	-0.001
50	1850.699998	-0.001	1909.299997	-0.002

Frequency Error vs. Voltage

Voltage (Volts)	LTE Band 2			
	Channel Bandwidth: 3 MHz			
	Low Channel		High Channel	
	Frequency (MHz)	Frequency Error (ppm)	Frequency (MHz)	Frequency Error (ppm)
4.25	1851.500001	0.001	1908.500004	0.002
5	1851.500003	0.001	1908.500001	0.001
5.75	1851.500002	0.001	1908.500002	0.001

Note: The applicant defined the normal working voltage is from 4.25Vdc to 5.75Vdc.

Frequency Error vs. Temperature

Temp. (°C)	LTE Band 2			
	Channel Bandwidth: 3 MHz			
	Low Channel		High Channel	
	Frequency (MHz)	Frequency Error (ppm)	Frequency (MHz)	Frequency Error (ppm)
-30	1851.500002	0.001	1908.500004	0.002
-20	1851.500002	0.001	1908.500003	0.002
-10	1851.500002	0.001	1908.500001	0.001
0	1851.500001	0.001	1908.500003	0.002
10	1851.500003	0.002	1908.500002	0.001
20	1851.499997	-0.001	1908.499997	-0.002
30	1851.499999	-0.001	1908.499998	-0.001
40	1851.499998	-0.001	1908.499997	-0.002
50	1851.499998	-0.001	1908.499998	-0.001

Frequency Error vs. Voltage

Voltage (Volts)	LTE Band 2			
	Channel Bandwidth: 5 MHz			
	Low Channel		High Channel	
	Frequency (MHz)	Frequency Error (ppm)	Frequency (MHz)	Frequency Error (ppm)
4.25	1852.500003	0.002	1907.500003	0.002
5	1852.500004	0.002	1907.500001	0.001
5.75	1852.500003	0.002	1907.500004	0.002

Note: The applicant defined the normal working voltage is from 4.25Vdc to 5.75Vdc.

Frequency Error vs. Temperature

Temp. (°C)	LTE Band 2			
	Channel Bandwidth: 5 MHz			
	Low Channel		High Channel	
	Frequency (MHz)	Frequency Error (ppm)	Frequency (MHz)	Frequency Error (ppm)
-30	1852.500003	0.002	1907.500002	0.001
-20	1852.500003	0.002	1907.500002	0.001
-10	1852.500003	0.002	1907.500003	0.001
0	1852.500002	0.001	1907.500002	0.001
10	1852.500003	0.002	1907.500004	0.002
20	1852.499999	-0.001	1907.499999	-0.001
30	1852.499996	-0.002	1907.499996	-0.002
40	1852.499999	-0.001	1907.499997	-0.002
50	1852.499997	-0.002	1907.499998	-0.001

Frequency Error vs. Voltage

Voltage (Volts)	LTE Band 2			
	Channel Bandwidth: 10 MHz			
	Low Channel		High Channel	
	Frequency (MHz)	Frequency Error (ppm)	Frequency (MHz)	Frequency Error (ppm)
4.25	1855.000003	0.002	1905.000002	0.001
5	1855.000003	0.001	1905.000002	0.001
5.75	1855.000002	0.001	1905.000004	0.002

Note: The applicant defined the normal working voltage is from 4.25Vdc to 5.75Vdc.

Frequency Error vs. Temperature

Temp. (°C)	LTE Band 2			
	Channel Bandwidth: 10 MHz			
	Low Channel		High Channel	
	Frequency (MHz)	Frequency Error (ppm)	Frequency (MHz)	Frequency Error (ppm)
-30	1855.000004	0.002	1905.000002	0.001
-20	1855.000004	0.002	1905.000001	0.001
-10	1855.000002	0.001	1905.000002	0.001
0	1855.000002	0.001	1905.000002	0.001
10	1855.000004	0.002	1905.000004	0.002
20	1854.999998	-0.001	1904.999999	-0.001
30	1854.999997	-0.002	1904.999997	-0.001
40	1854.999998	-0.001	1904.999999	-0.001
50	1854.999999	-0.001	1904.999997	-0.001

Frequency Error vs. Voltage

Voltage (Volts)	LTE Band 2			
	Channel Bandwidth: 15 MHz			
	Low Channel		High Channel	
	Frequency (MHz)	Frequency Error (ppm)	Frequency (MHz)	Frequency Error (ppm)
4.25	1857.500003	0.001	1902.500003	0.001
5	1857.500002	0.001	1902.500002	0.001
5.75	1857.500003	0.002	1902.500003	0.001

Note: The applicant defined the normal working voltage is from 4.25Vdc to 5.75Vdc.

Frequency Error vs. Temperature

Temp. (°C)	LTE Band 2			
	Channel Bandwidth: 15 MHz			
	Low Channel		High Channel	
	Frequency (MHz)	Frequency Error (ppm)	Frequency (MHz)	Frequency Error (ppm)
-30	1857.500001	0.001	1902.500003	0.002
-20	1857.500004	0.002	1902.500002	0.001
-10	1857.500001	0.001	1902.500002	0.001
0	1857.500004	0.002	1902.500003	0.001
10	1857.500003	0.002	1902.500003	0.001
20	1857.499998	-0.001	1902.499997	-0.001
30	1857.499997	-0.001	1902.499997	-0.002
40	1857.499997	-0.002	1902.499996	-0.002
50	1857.499998	-0.001	1902.499996	-0.002

Frequency Error vs. Voltage

Voltage (Volts)	LTE Band 2			
	Channel Bandwidth: 20 MHz			
	Low Channel		High Channel	
	Frequency (MHz)	Frequency Error (ppm)	Frequency (MHz)	Frequency Error (ppm)
4.25	1860.000002	0.001	1900.000003	0.002
5	1860.000002	0.001	1900.000003	0.002
5.75	1860.000002	0.001	1900.000001	0.001

Note: The applicant defined the normal working voltage is from 4.25Vdc to 5.75Vdc.

Frequency Error vs. Temperature

Temp. (°C)	LTE Band 2			
	Channel Bandwidth: 20 MHz			
	Low Channel		High Channel	
	Frequency (MHz)	Frequency Error (ppm)	Frequency (MHz)	Frequency Error (ppm)
-30	1860.000002	0.001	1900.000003	0.001
-20	1860.000002	0.001	1900.000002	0.001
-10	1860.000002	0.001	1900.000003	0.002
0	1860.000002	0.001	1900.000004	0.002
10	1860.000004	0.002	1900.000002	0.001
20	1859.999999	-0.001	1899.999999	-0.001
30	1859.999997	-0.001	1899.999998	-0.001
40	1859.999999	-0.001	1899.999999	-0.001
50	1859.999997	-0.001	1899.999996	-0.002

Frequency Error vs. Voltage

Voltage (Volts)	LTE Band 7			
	Channel Bandwidth: 5 MHz			
	Low Channel		High Channel	
	Frequency (MHz)	Frequency Error (ppm)	Frequency (MHz)	Frequency Error (ppm)
4.25	2502.500003	0.001	2567.500003	0.001
5	2502.500001	0.001	2567.500002	0.001
5.75	2502.500002	0.001	2567.500002	0.001

Note: The applicant defined the normal working voltage is from 4.25Vdc to 5.75Vdc.

Frequency Error vs. Temperature

Temp. (°C)	LTE Band 7			
	Channel Bandwidth: 5 MHz			
	Low Channel		High Channel	
	Frequency (MHz)	Frequency Error (ppm)	Frequency (MHz)	Frequency Error (ppm)
-30	2502.500004	0.002	2567.500002	0.001
-20	2502.500002	0.001	2567.500004	0.002
-10	2502.500003	0.001	2567.500001	0.000
0	2502.500002	0.001	2567.500003	0.001
10	2502.500002	0.001	2567.500003	0.001
20	2502.499999	-0.001	2567.499999	-0.001
30	2502.499997	-0.001	2567.499999	0.000
40	2502.499997	-0.001	2567.499997	-0.001
50	2502.499997	-0.001	2567.499997	-0.001

Frequency Error vs. Voltage

Voltage (Volts)	LTE Band 7			
	Channel Bandwidth: 10 MHz			
	Low Channel		High Channel	
	Frequency (MHz)	Frequency Error (ppm)	Frequency (MHz)	Frequency Error (ppm)
4.25	2505.000002	0.001	2565.000003	0.001
5	2505.000001	0.000	2565.000003	0.001
5.75	2505.000004	0.002	2565.000003	0.001

Note: The applicant defined the normal working voltage is from 4.25Vdc to 5.75Vdc.

Frequency Error vs. Temperature

Temp. (°C)	LTE Band 7			
	Channel Bandwidth: 10 MHz			
	Low Channel		High Channel	
	Frequency (MHz)	Frequency Error (ppm)	Frequency (MHz)	Frequency Error (ppm)
-30	2505.000003	0.001	2565.000002	0.001
-20	2505.000004	0.002	2565.000001	0.000
-10	2505.000001	0.001	2565.000004	0.001
0	2505.000004	0.002	2565.000001	0.001
10	2505.000003	0.001	2565.000003	0.001
20	2504.999999	-0.001	2564.999996	-0.001
30	2504.999996	-0.001	2564.999999	0.000
40	2504.999998	-0.001	2564.999997	-0.001
50	2504.999998	-0.001	2564.999999	0.000

Frequency Error vs. Voltage

Voltage (Volts)	LTE Band 7			
	Channel Bandwidth: 15 MHz			
	Low Channel		High Channel	
	Frequency (MHz)	Frequency Error (ppm)	Frequency (MHz)	Frequency Error (ppm)
4.25	2507.500002	0.001	2562.500004	0.002
5	2507.500002	0.001	2562.500003	0.001
5.75	2507.500003	0.001	2562.500001	0.000

Note: The applicant defined the normal working voltage is from 4.25Vdc to 5.75Vdc.

Frequency Error vs. Temperature

Temp. (°C)	LTE Band 7			
	Channel Bandwidth: 15 MHz			
	Low Channel		High Channel	
	Frequency (MHz)	Frequency Error (ppm)	Frequency (MHz)	Frequency Error (ppm)
-30	2507.500004	0.002	2562.500004	0.002
-20	2507.500001	0.000	2562.500001	0.000
-10	2507.500001	0.001	2562.500002	0.001
0	2507.500001	0.000	2562.500004	0.001
10	2507.500001	0.000	2562.500001	0.001
20	2507.499997	-0.001	2562.499997	-0.001
30	2507.499999	0.000	2562.499998	-0.001
40	2507.499998	-0.001	2562.499999	0.000
50	2507.499998	-0.001	2562.499997	-0.001

Frequency Error vs. Voltage

Voltage (Volts)	LTE Band 7			
	Channel Bandwidth: 20 MHz			
	Low Channel		High Channel	
	Frequency (MHz)	Frequency Error (ppm)	Frequency (MHz)	Frequency Error (ppm)
4.25	2510.000001	0.000	2560.000004	0.002
5	2510.000002	0.001	2560.000001	0.001
5.75	2510.000002	0.001	2560.000002	0.001

Note: The applicant defined the normal working voltage is from 4.25Vdc to 5.75Vdc.

Frequency Error vs. Temperature

Temp. (°C)	LTE Band 7			
	Channel Bandwidth: 20 MHz			
	Low Channel		High Channel	
	Frequency (MHz)	Frequency Error (ppm)	Frequency (MHz)	Frequency Error (ppm)
-30	2510.000002	0.001	2560.000001	0.000
-20	2510.000002	0.001	2560.000001	0.001
-10	2510.000001	0.001	2560.000001	0.000
0	2510.000004	0.001	2560.000002	0.001
10	2510.000001	0.000	2560.000003	0.001
20	2509.999997	-0.001	2559.999998	-0.001
30	2509.999997	-0.001	2559.999996	-0.001
40	2509.999998	-0.001	2559.999996	-0.001
50	2509.999998	-0.001	2559.999998	-0.001

Frequency Error vs. Voltage

Voltage (Volts)	LTE Band 66			
	Channel Bandwidth: 1.4 MHz			
	Low Channel		High Channel	
	Frequency (MHz)	Frequency Error (ppm)	Frequency (MHz)	Frequency Error (ppm)
4.25	1710.700002	0.001	1779.300003	0.002
5	1710.700002	0.001	1779.300004	0.002
5.75	1710.700001	0.001	1779.300001	0.001

Note: The applicant defined the normal working voltage is from 4.25Vdc to 5.75Vdc.

Frequency Error vs. Temperature

Temp. (°C)	LTE Band 66			
	Channel Bandwidth: 1.4 MHz			
	Low Channel		High Channel	
	Frequency (MHz)	Frequency Error (ppm)	Frequency (MHz)	Frequency Error (ppm)
-30	1710.700001	0.001	1779.300003	0.002
-20	1710.700002	0.001	1779.300001	0.001
-10	1710.700001	0.001	1779.300003	0.002
0	1710.700002	0.001	1779.300001	0.001
10	1710.700002	0.001	1779.300001	0.001
20	1710.699998	-0.001	1779.299996	-0.002
30	1710.699998	-0.001	1779.299998	-0.001
40	1710.699999	-0.001	1779.299998	-0.001
50	1710.699997	-0.002	1779.299997	-0.001

Frequency Error vs. Voltage

Voltage (Volts)	LTE Band 66			
	Channel Bandwidth: 3 MHz			
	Low Channel		High Channel	
	Frequency (MHz)	Frequency Error (ppm)	Frequency (MHz)	Frequency Error (ppm)
4.25	1711.500002	0.001	1778.500003	0.002
5	1711.500004	0.002	1778.500001	0.001
5.75	1711.500002	0.001	1778.500003	0.002

Note: The applicant defined the normal working voltage is from 4.25Vdc to 5.75Vdc.

Frequency Error vs. Temperature

Temp. (°C)	LTE Band 66			
	Channel Bandwidth: 3 MHz			
	Low Channel		High Channel	
	Frequency (MHz)	Frequency Error (ppm)	Frequency (MHz)	Frequency Error (ppm)
-30	1711.500002	0.001	1778.500003	0.001
-20	1711.500003	0.002	1778.500002	0.001
-10	1711.500002	0.001	1778.500004	0.002
0	1711.500003	0.002	1778.500003	0.002
10	1711.500004	0.002	1778.500003	0.002
20	1711.499997	-0.002	1778.499996	-0.002
30	1711.499996	-0.002	1778.499998	-0.001
40	1711.499998	-0.001	1778.499998	-0.001
50	1711.499998	-0.001	1778.499997	-0.002

Frequency Error vs. Voltage

Voltage (Volts)	LTE Band 66			
	Channel Bandwidth: 5 MHz			
	Low Channel		High Channel	
	Frequency (MHz)	Frequency Error (ppm)	Frequency (MHz)	Frequency Error (ppm)
4.25	1712.500003	0.002	1777.500001	0.001
5	1712.500001	0.001	1777.500003	0.002
5.75	1712.500002	0.001	1777.500004	0.002

Note: The applicant defined the normal working voltage is from 4.25Vdc to 5.75Vdc.

Frequency Error vs. Temperature

Temp. (°C)	LTE Band 66			
	Channel Bandwidth: 5 MHz			
	Low Channel		High Channel	
	Frequency (MHz)	Frequency Error (ppm)	Frequency (MHz)	Frequency Error (ppm)
-30	1712.500001	0.001	1777.500003	0.002
-20	1712.500004	0.002	1777.500002	0.001
-10	1712.500002	0.001	1777.500001	0.001
0	1712.500002	0.001	1777.500003	0.002
10	1712.500003	0.002	1777.500003	0.002
20	1712.499998	-0.001	1777.499996	-0.002
30	1712.499998	-0.001	1777.499998	-0.001
40	1712.499997	-0.002	1777.499998	-0.001
50	1712.499998	-0.001	1777.499997	-0.002

Frequency Error vs. Voltage

Voltage (Volts)	LTE Band 66			
	Channel Bandwidth: 10 MHz			
	Low Channel		High Channel	
	Frequency (MHz)	Frequency Error (ppm)	Frequency (MHz)	Frequency Error (ppm)
4.25	1715.000002	0.001	1775.000003	0.002
5	1715.000002	0.001	1775.000003	0.002
5.75	1715.000001	0.001	1775.000002	0.001

Note: The applicant defined the normal working voltage is from 4.25Vdc to 5.75Vdc.

Frequency Error vs. Temperature

Temp. (°C)	LTE Band 66			
	Channel Bandwidth: 10 MHz			
	Low Channel		High Channel	
	Frequency (MHz)	Frequency Error (ppm)	Frequency (MHz)	Frequency Error (ppm)
-30	1715.000001	0.001	1775.000004	0.002
-20	1715.000002	0.001	1775.000003	0.002
-10	1715.000003	0.002	1775.000002	0.001
0	1715.000003	0.002	1775.000001	0.001
10	1715.000003	0.002	1775.000002	0.001
20	1714.999996	-0.002	1774.999997	-0.002
30	1714.999997	-0.002	1774.999998	-0.001
40	1714.999997	-0.002	1774.999997	-0.002
50	1714.999999	-0.001	1774.999999	-0.001

Frequency Error vs. Voltage

Voltage (Volts)	LTE Band 66			
	Channel Bandwidth: 15 MHz			
	Low Channel		High Channel	
	Frequency (MHz)	Frequency Error (ppm)	Frequency (MHz)	Frequency Error (ppm)
4.25	1717.500003	0.002	1772.500003	0.002
5	1717.500003	0.002	1772.500004	0.002
5.75	1717.500001	0.001	1772.500002	0.001

Note: The applicant defined the normal working voltage is from 4.25Vdc to 5.75Vdc.

Frequency Error vs. Temperature

Temp. (°C)	LTE Band 66			
	Channel Bandwidth: 15 MHz			
	Low Channel		High Channel	
	Frequency (MHz)	Frequency Error (ppm)	Frequency (MHz)	Frequency Error (ppm)
-30	1717.500004	0.002	1772.500003	0.002
-20	1717.500004	0.002	1772.500004	0.002
-10	1717.500004	0.002	1772.500002	0.001
0	1717.500001	0.001	1772.500003	0.002
10	1717.500002	0.001	1772.500002	0.001
20	1717.499998	-0.001	1772.499998	-0.001
30	1717.499997	-0.002	1772.499996	-0.002
40	1717.499998	-0.001	1772.499998	-0.001
50	1717.499997	-0.002	1772.499997	-0.002

Frequency Error vs. Voltage

Voltage (Volts)	LTE Band 66			
	Channel Bandwidth: 20 MHz			
	Low Channel		High Channel	
	Frequency (MHz)	Frequency Error (ppm)	Frequency (MHz)	Frequency Error (ppm)
4.25	1720.000002	0.001	1770.000002	0.001
5	1720.000003	0.002	1770.000002	0.001
5.75	1720.000004	0.002	1770.000002	0.001

Note: The applicant defined the normal working voltage is from 4.25Vdc to 5.75Vdc.

Frequency Error vs. Temperature

Temp. (°C)	LTE Band 66			
	Channel Bandwidth: 20 MHz			
	Low Channel		High Channel	
	Frequency (MHz)	Frequency Error (ppm)	Frequency (MHz)	Frequency Error (ppm)
-30	1720.000002	0.001	1770.000003	0.002
-20	1720.000002	0.001	1770.000003	0.002
-10	1720.000002	0.001	1770.000001	0.001
0	1720.000003	0.001	1770.000004	0.002
10	1720.000002	0.001	1770.000003	0.002
20	1719.999997	-0.002	1769.999998	-0.001
30	1719.999999	-0.001	1769.999997	-0.001
40	1719.999997	-0.002	1769.999998	-0.001
50	1719.999997	-0.002	1769.999996	-0.002

4.4 Occupied Bandwidth Measurement

4.4.1 Test Procedure

For LTB Band 2:

The EUT makes a call to the communication simulator. All measurements were done at low, middle and high operational frequency range. The communication simulator station system controlled a EUT to export maximum output power under transmission mode and specific channel frequency. Use OBW measurement function of Spectrum analyzer to measure 99 % occupied bandwidth.

For LTB Band 7, LTB Band 66:

The occupied bandwidth (OBW), that is the frequency bandwidth such that, below its lower and above its upper frequency limits, the mean powers radiated are each equal to 0.5 % of the total mean power radiated by a given emission.

4.4.2 Test Setup

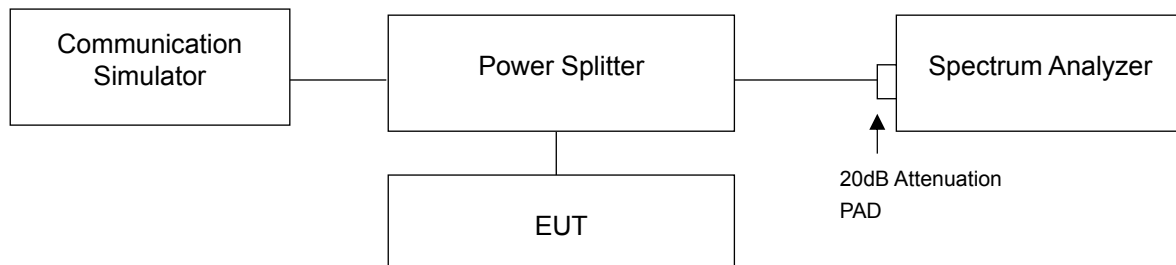

4.4.3 Test Result

Occupied Bandwidth

n71

n71, Channel Bandwidth 5MHz						
Channel	Frequency (MHz)	99% Occupied Bandwidth (MHz)				
		$\pi/2$ BPSK	QPSK	16QAM	64QAM	256QAM
133100	665.5	4.4856	4.4860	4.4870	4.4911	4.4887
136100	680.5	4.4883	4.4881	4.4856	4.4967	4.4882
139100	695.5	4.4882	4.4880	4.4891	4.4976	4.4889
n71, Channel Bandwidth 10MHz						
Channel	Frequency (MHz)	99% Occupied Bandwidth (MHz)				
		$\pi/2$ BPSK	QPSK	16QAM	64QAM	256QAM
133600	668	8.9630	8.9628	8.9677	8.9645	8.9653
136100	680.5	8.9616	8.9525	8.9557	8.9576	8.9591
138600	693	8.9525	8.9558	8.9550	8.9565	8.9525
n71, Channel Bandwidth 15MHz						
Channel	Frequency (MHz)	99% Occupied Bandwidth (MHz)				
		$\pi/2$ BPSK	QPSK	16QAM	64QAM	256QAM
134100	670.5	13.454	13.460	13.445	13.441	13.446
136100	680.5	13.464	13.456	13.447	13.440	13.450
138100	690.5	13.446	13.441	13.432	13.431	13.435
n71, Channel Bandwidth 20MHz						
Channel	Frequency (MHz)	99% Occupied Bandwidth (MHz)				
		$\pi/2$ BPSK	QPSK	16QAM	64QAM	256QAM
134600	673	17.901	17.894	17.917	17.909	17.914
136100	680.5	17.927	17.914	17.927	17.924	17.929
137600	688	17.903	17.902	17.923	17.922	17.921

Spectrum Plot of Worst Value

5MHz / 64QAM

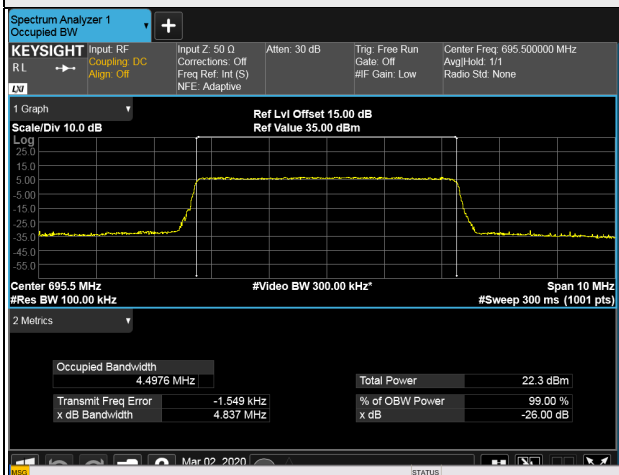

10MHz / 16QAM

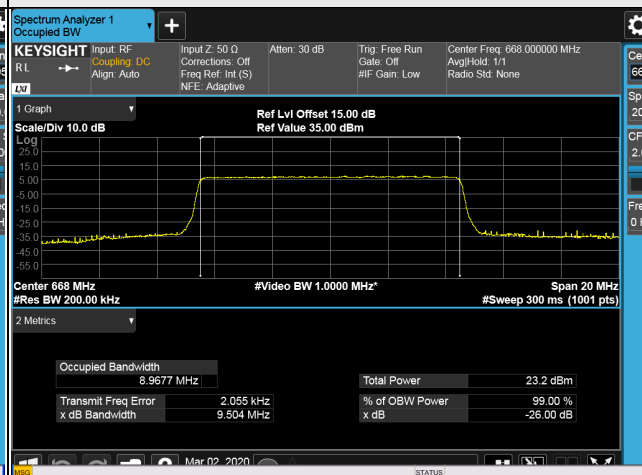

15MHz / QPSK

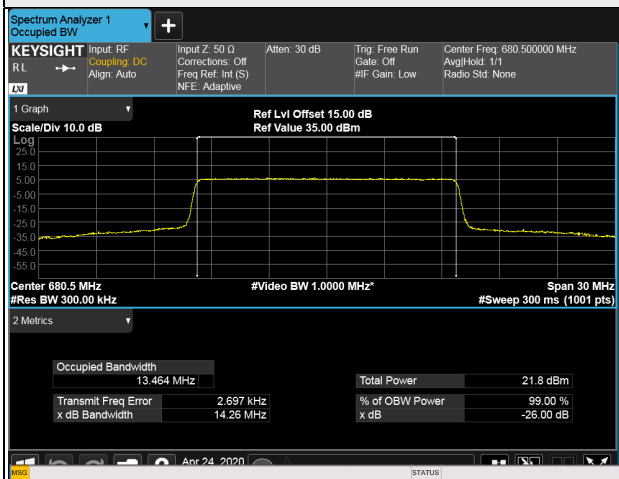

20MHz / 256QAM

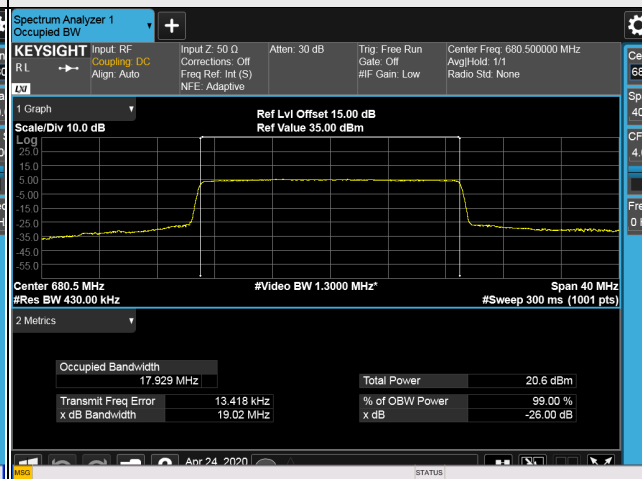

LTE Band 2

LTE Band 2, Channel Bandwidth 1.4MHz		
Channel	Frequency (MHz)	99% Occupied Bandwidth (MHz)
		256QAM
18607	1850.7	1.09
18900	1880.0	1.09
19193	1909.3	1.09
LTE Band 2, Channel Bandwidth 3MHz		
Channel	Frequency (MHz)	99% Occupied Bandwidth (MHz)
		256QAM
18615	1851.5	2.70
18900	1880.0	2.70
19185	1908.5	2.70
LTE Band 2, Channel Bandwidth 5MHz		
Channel	Frequency (MHz)	99% Occupied Bandwidth (MHz)
		256QAM
18625	1852.5	4.49
18900	1880.0	4.49
19175	1907.5	4.49
LTE Band 2, Channel Bandwidth 10MHz		
Channel	Frequency (MHz)	99% Occupied Bandwidth (MHz)
		256QAM
18650	1855.0	8.95
18900	1880.0	8.96
19150	1905.0	8.96
LTE Band 2, Channel Bandwidth 15MHz		
Channel	Frequency (MHz)	99% Occupied Bandwidth (MHz)
		256QAM
18675	1857.5	13.43
18900	1880.0	13.46
19125	1902.5	13.48

LTE Band 2, Channel Bandwidth 20MHz		
Channel	Frequency (MHz)	99% Occupied Bandwidth (MHz)
		256QAM
18700	1860.0	17.92
18900	1880.0	17.94
19100	1900.0	17.98

Spectrum Plot of Worst Value

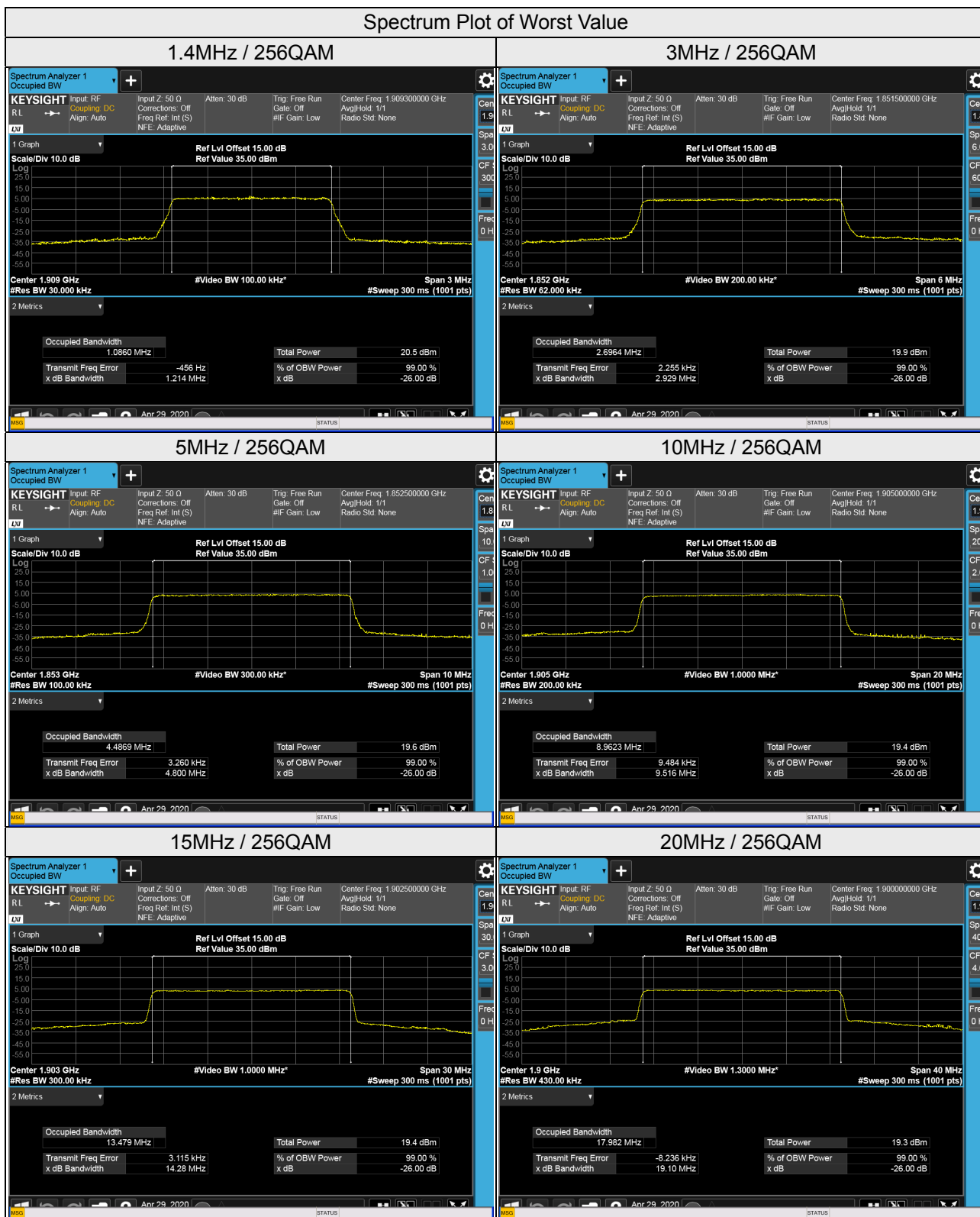

LTE Band 7

LTE Band 7, Channel Bandwidth 5MHz		
Channel	Frequency (MHz)	99% Occupied Bandwidth (MHz)
		256QAM
20775	2502.5	4.49
21100	2535.0	4.49
21425	2567.5	4.48
LTE Band 7, Channel Bandwidth 10MHz		
Channel	Frequency (MHz)	99% Occupied Bandwidth (MHz)
		256QAM
20800	2505.0	8.95
21100	2535.0	8.95
21400	2565.0	8.95
LTE Band 7, Channel Bandwidth 15MHz		
Channel	Frequency (MHz)	99% Occupied Bandwidth (MHz)
		256QAM
20825	2507.5	13.44
21100	2535.0	13.45
21375	2562.5	13.43
LTE Band 7, Channel Bandwidth 20MHz		
Channel	Frequency (MHz)	99% Occupied Bandwidth (MHz)
		256QAM
20850	2510.0	17.91
21100	2535.0	17.96
21350	2560.0	17.93

Spectrum Plot of Worst Value

5MHz / 256QAM

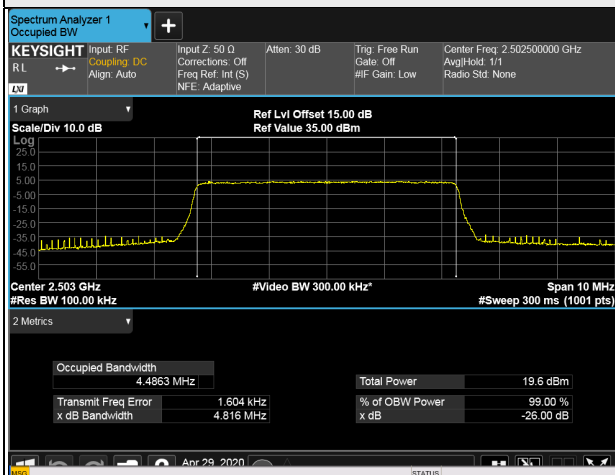

10MHz / 256QAM

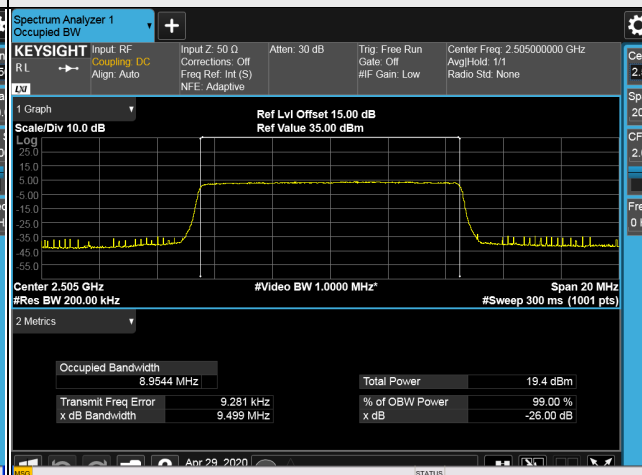

15MHz / 256QAM

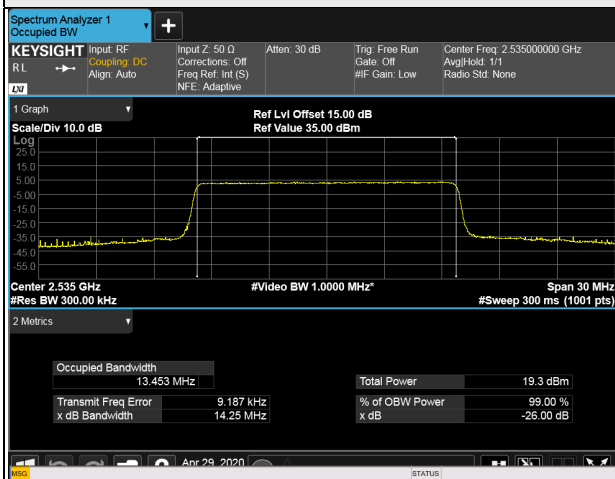

20MHz / 256QAM

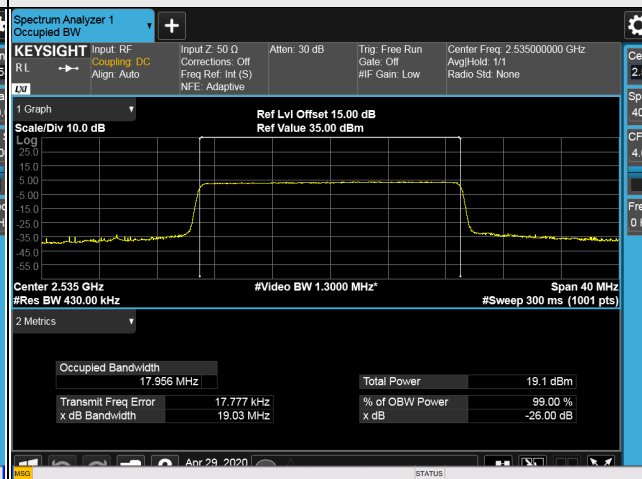

LTE Band 66

LTE Band 66, Channel Bandwidth 1.4MHz		
Channel	Frequency (MHz)	99% Occupied Bandwidth (MHz)
		256QAM
131979	1710.7	1.08
132322	1745.0	1.08
132665	1779.3	1.09
LTE Band 66, Channel Bandwidth 3MHz		
Channel	Frequency (MHz)	99% Occupied Bandwidth (MHz)
		256QAM
131987	1711.5	2.70
132322	1745.0	2.69
132657	1778.5	2.70
LTE Band 66, Channel Bandwidth 5MHz		
Channel	Frequency (MHz)	99% Occupied Bandwidth (MHz)
		256QAM
131997	1712.5	4.49
132322	1745.0	4.49
132647	1777.5	4.48
LTE Band 66, Channel Bandwidth 10MHz		
Channel	Frequency (MHz)	99% Occupied Bandwidth (MHz)
		256QAM
132022	1715.0	8.96
132322	1745.0	8.96
132622	1775.0	8.97
LTE Band 66, Channel Bandwidth 15MHz		
Channel	Frequency (MHz)	99% Occupied Bandwidth (MHz)
		256QAM
132047	1717.5	13.45
132322	1745.0	13.46
132597	1772.5	13.49

LTE Band 66, Channel Bandwidth 20MHz		
Channel	Frequency (MHz)	99% Occupied Bandwidth (MHz)
		256QAM
132072	1720.0	17.92
132322	1745.0	17.98
132572	1770.0	18.00

Spectrum Plot of Worst Value

1.4MHz / 256QAM

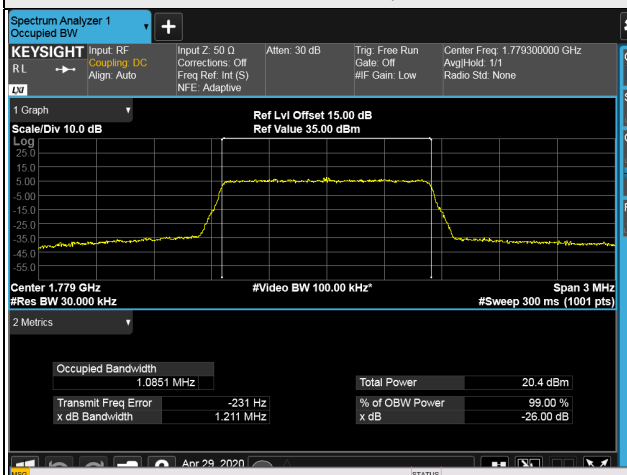

3MHz / 256QAM

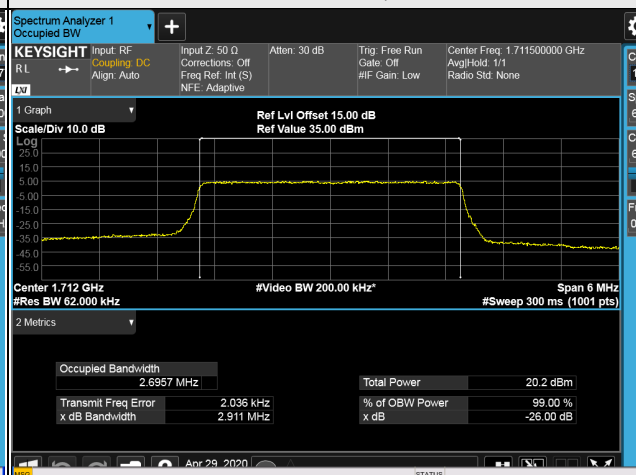

5MHz / 256QAM

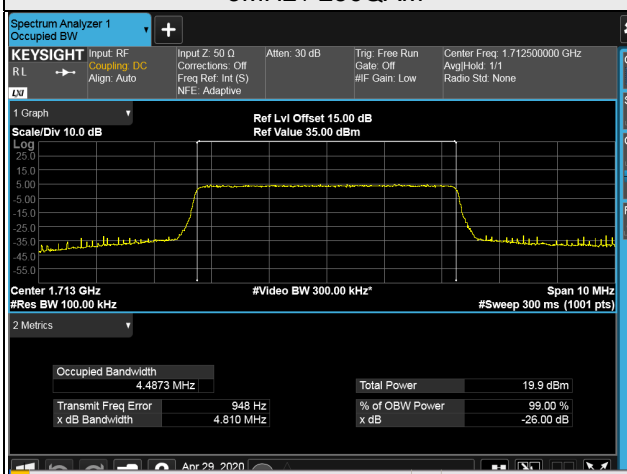

10MHz / 256QAM

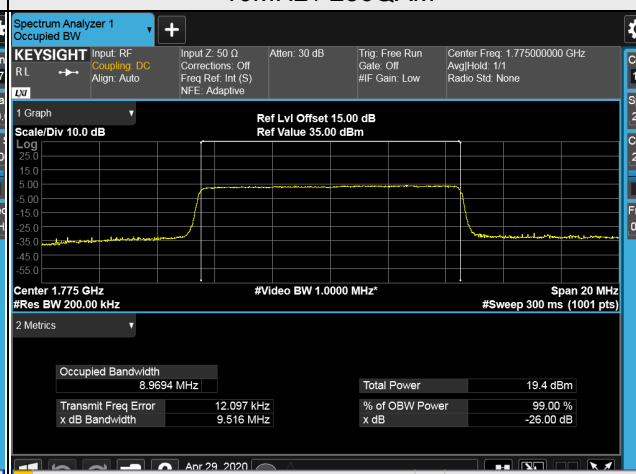

15MHz / 256QAM

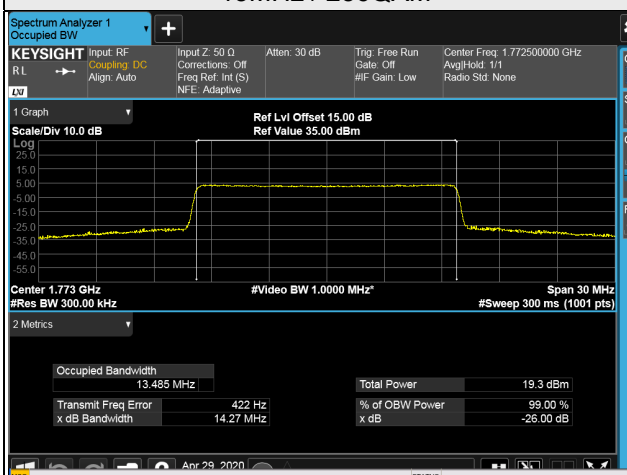

20MHz / 256QAM

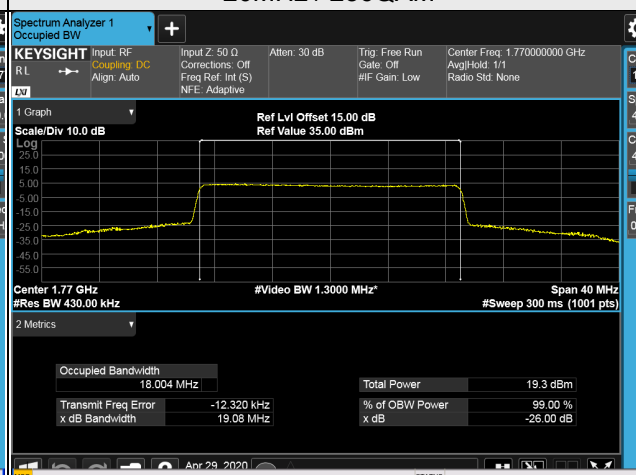

26dB Bandwidth
n71

n71, Channel Bandwidth 5MHz						
Channel	Frequency (MHz)	26dB Bandwidth (MHz)				
		$\pi/2$ BPSK	QPSK	16QAM	64QAM	256QAM
133100	665.5	4.808	4.801	4.793	4.832	4.806
136100	680.5	4.775	4.794	4.798	4.848	4.810
139100	695.5	4.798	4.812	4.795	4.837	4.808
n71, Channel Bandwidth 10MHz						
Channel	Frequency (MHz)	26dB Bandwidth (MHz)				
		$\pi/2$ BPSK	QPSK	16QAM	64QAM	256QAM
133600	668	9.502	9.499	9.504	9.506	9.508
136100	680.5	9.500	9.504	9.503	9.504	9.514
138600	693	9.503	9.501	9.506	9.507	9.496
n71, Channel Bandwidth 15MHz						
Channel	Frequency (MHz)	26dB Bandwidth (MHz)				
		$\pi/2$ BPSK	QPSK	16QAM	64QAM	256QAM
134100	670.5	14.25	14.25	14.24	14.25	14.24
136100	680.5	14.26	14.26	14.25	14.25	14.25
138100	690.5	14.25	14.23	14.23	14.24	14.23
n71, Channel Bandwidth 20MHz						
Channel	Frequency (MHz)	26dB Bandwidth (MHz)				
		$\pi/2$ BPSK	QPSK	16QAM	64QAM	256QAM
134600	673	19.00	19.01	19.01	19.00	19.01
136100	680.5	19.06	19.02	19.03	19.02	19.02
137600	688	19.01	19.02	18.99	19.01	19.01

Spectrum Plot of Worst Value

5MHz / 64QAM



10MHz / 256QAM

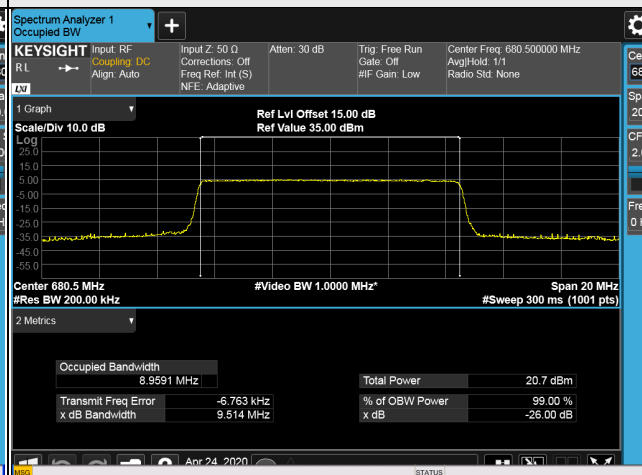

15MHz / QPSK

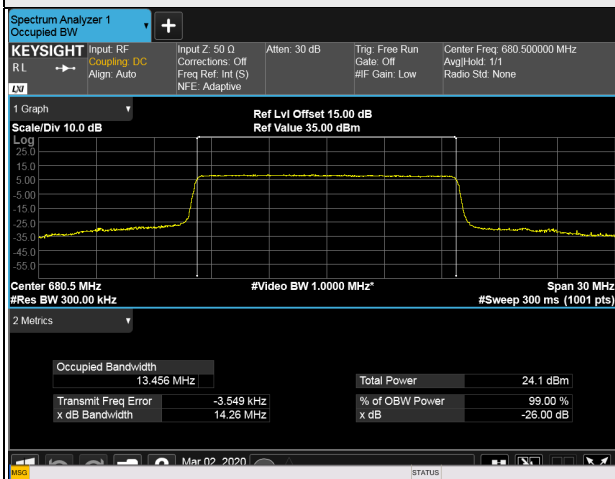

20MHz / $\pi/2$ BPSK

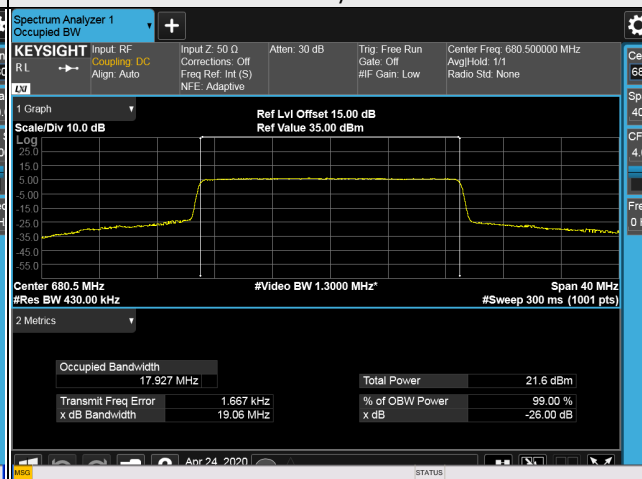

LTE Band 2, Channel Bandwidth 1.4MHz		
Channel	Frequency (MHz)	26dBc Bandwidth (MHz)
		256QAM
18607	1850.7	1.22
18900	1880.0	1.21
19193	1909.3	1.21
LTE Band 2, Channel Bandwidth 3MHz		
Channel	Frequency (MHz)	26dBc Bandwidth (MHz)
		256QAM
18615	1851.5	2.93
18900	1880.0	2.93
19185	1908.5	2.92
LTE Band 2, Channel Bandwidth 5MHz		
Channel	Frequency (MHz)	26dBc Bandwidth (MHz)
		256QAM
18625	1852.5	4.80
18900	1880.0	4.82
19175	1907.5	4.79
LTE Band 2, Channel Bandwidth 10MHz		
Channel	Frequency (MHz)	26dBc Bandwidth (MHz)
		256QAM
18650	1855.0	9.51
18900	1880.0	9.51
19150	1905.0	9.52
LTE Band 2, Channel Bandwidth 15MHz		
Channel	Frequency (MHz)	26dBc Bandwidth (MHz)
		256QAM
18675	1857.5	14.24
18900	1880.0	14.24
19125	1902.5	14.28

LTE Band 2, Channel Bandwidth 20MHz

Channel	Frequency (MHz)	26dBc Bandwidth (MHz)
		256QAM
18700	1860.0	19.02
18900	1880.0	19.01
19100	1900.0	19.10

Spectrum Plot of Worst Value

1.4MHz / 256QAM

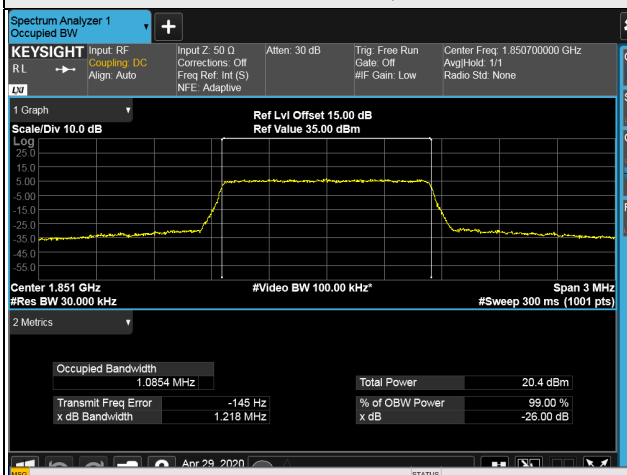

3MHz / 256QAM

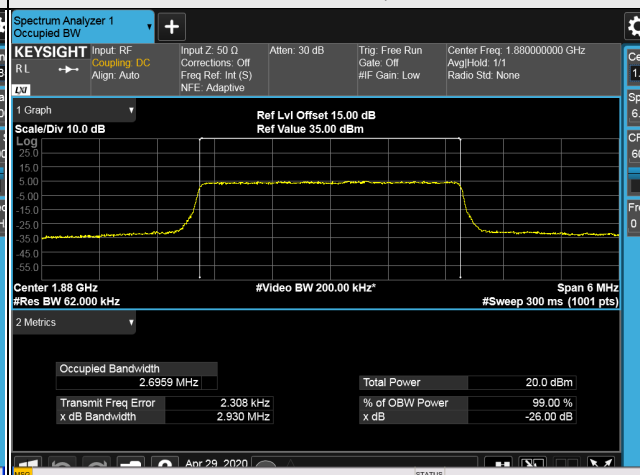

5MHz / 256QAM

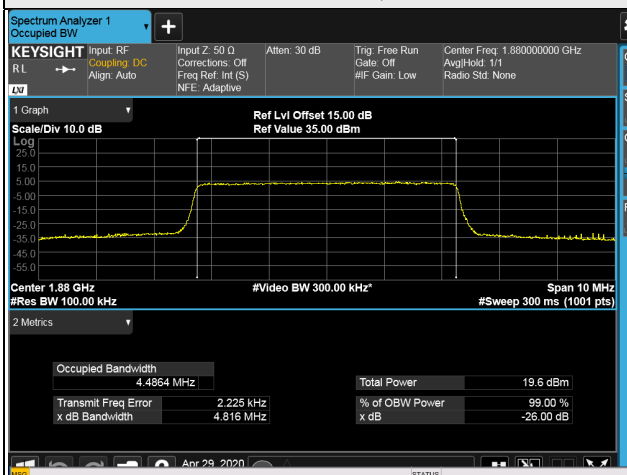

10MHz / 256QAM

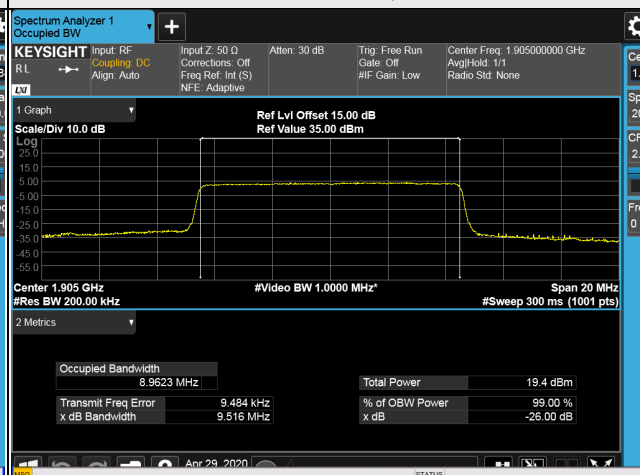

15MHz / 256QAM

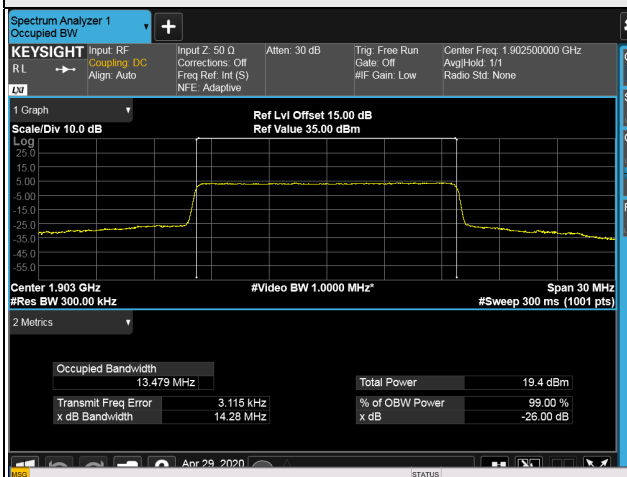

20MHz / 256QAM

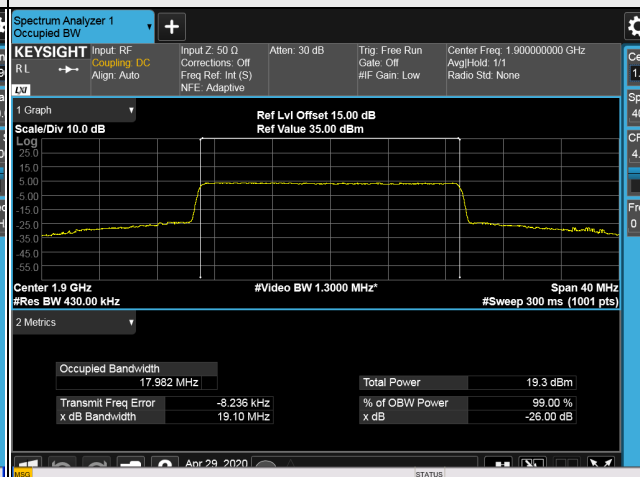

LTE Band 7

LTE Band 7, Channel Bandwidth 5MHz		
Channel	Frequency (MHz)	26dB Bandwidth (MHz)
		256QAM
20775	2502.5	4.82
21100	2535.0	4.80
21425	2567.5	4.81
LTE Band 7, Channel Bandwidth 10MHz		
Channel	Frequency (MHz)	26dB Bandwidth (MHz)
		256QAM
20800	2505.0	9.50
21100	2535.0	9.50
21400	2565.0	9.50
LTE Band 7, Channel Bandwidth 15MHz		
Channel	Frequency (MHz)	26dB Bandwidth (MHz)
		256QAM
20825	2507.5	14.24
21100	2535.0	14.25
21375	2562.5	14.20
LTE Band 7, Channel Bandwidth 20MHz		
Channel	Frequency (MHz)	26dB Bandwidth (MHz)
		256QAM
20850	2510.0	19.00
21100	2535.0	19.03
21350	2560.0	19.00

Spectrum Plot of Worst Value

5MHz / 256QAM

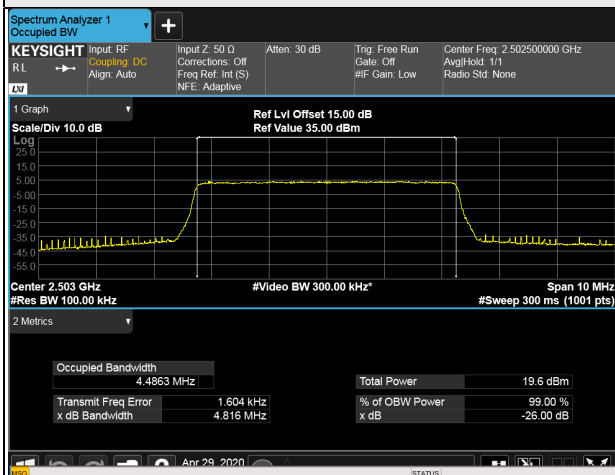

10MHz / 256QAM

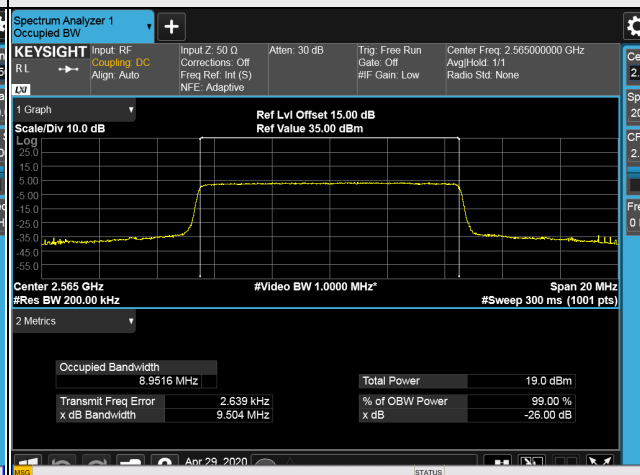

15MHz / 256QAM

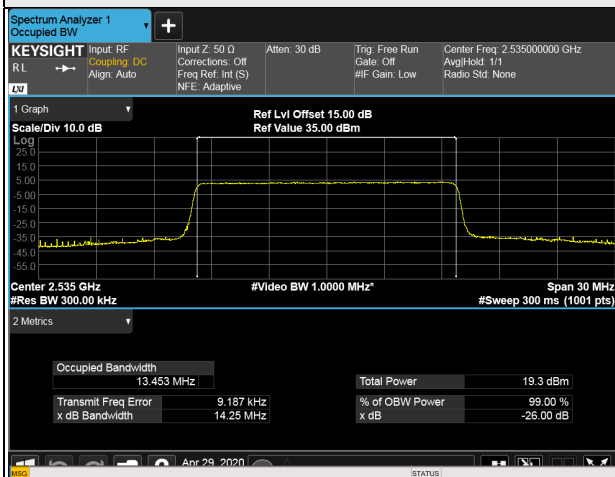

20MHz / 256QAM

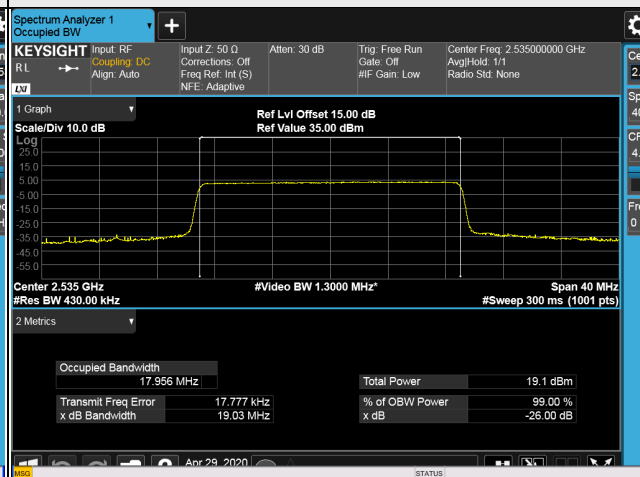

LTE Band 66

LTE Band 66, Channel Bandwidth 1.4MHz		
Channel	Frequency (MHz)	26dB Bandwidth (MHz)
		256QAM
131979	1710.7	1.21
132322	1745.0	1.20
132665	1779.3	1.21
LTE Band 66, Channel Bandwidth 3MHz		
Channel	Frequency (MHz)	26dB Bandwidth (MHz)
		256QAM
131987	1711.5	2.91
132322	1745.0	2.91
132657	1778.5	2.92
LTE Band 66, Channel Bandwidth 5MHz		
Channel	Frequency (MHz)	26dB Bandwidth (MHz)
		256QAM
131997	1712.5	4.81
132322	1745.0	4.81
132647	1777.5	4.78
LTE Band 66, Channel Bandwidth 10MHz		
Channel	Frequency (MHz)	26dB Bandwidth (MHz)
		256QAM
132022	1715.0	9.51
132322	1745.0	9.50
132622	1775.0	9.52
LTE Band 66, Channel Bandwidth 15MHz		
Channel	Frequency (MHz)	26dB Bandwidth (MHz)
		256QAM
132047	1717.5	14.23
132322	1745.0	14.24
132597	1772.5	14.27

LTE Band 66, Channel Bandwidth 20MHz		
Channel	Frequency (MHz)	26dB Bandwidth (MHz)
		256QAM
132072	1720.0	19.00
132322	1745.0	19.03
132572	1770.0	19.08

Spectrum Plot of Worst Value

1.4MHz / 256QAM

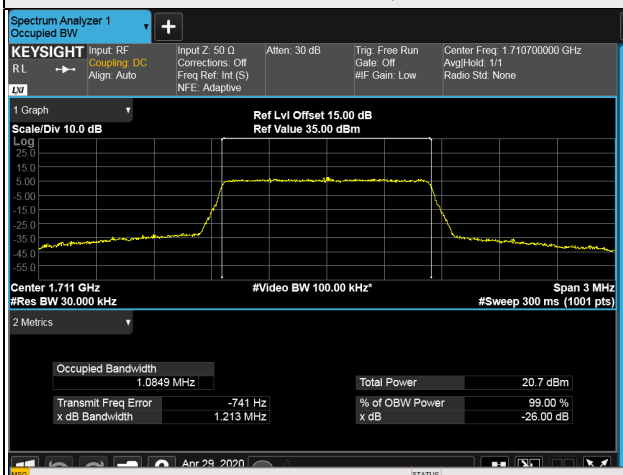

3MHz / 256QAM

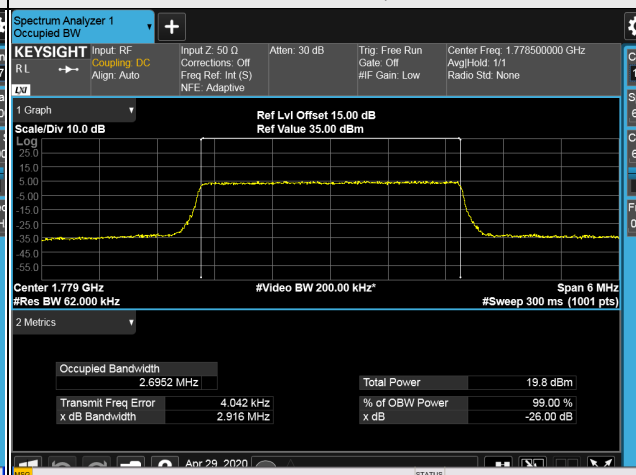

5MHz / 256QAM

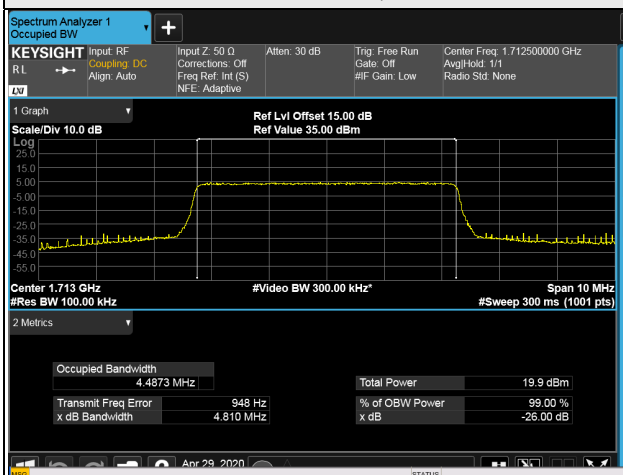

10MHz / 256QAM

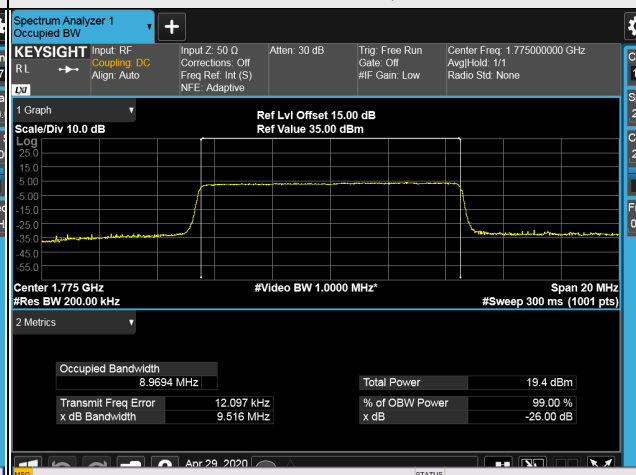

15MHz / 256QAM

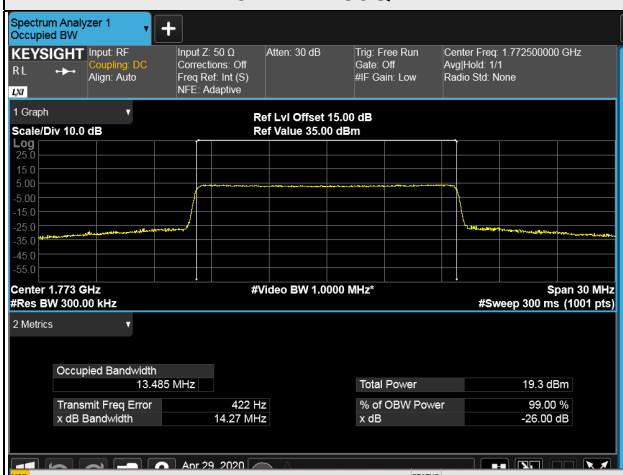

20MHz / 256QAM

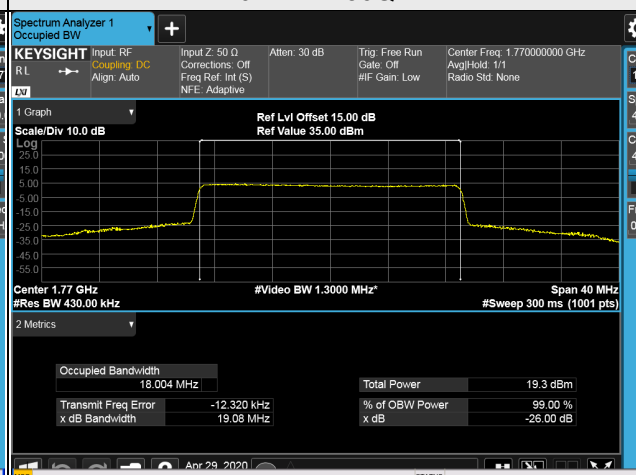

4.5 Band Edge Measurement

4.5.1 Limits of Band Edge Measurement

For LTE Band 2

Power of any emission outside of the authorized operating frequency ranges must be attenuated below the transmitting power (P) by a factor of at least $43 + 10 \log(P)$ dB. In the 1 MHz bands immediately outside and adjacent to the frequency block a resolution bandwidth of at least one percent of the emission bandwidth of the fundamental emission of the transmitter may be employed.

For LTE Band 7

According to FCC 27.53(m)(4) specified that power of any emission outside of the channel edge must be attenuated below the transmitting power (P) by a factor shall be not less than $40 + 10 \log(P)$ dB on all frequencies between the channel edge and 5 megahertz from the channel edge, $43 + 10 \log(P)$ dB on all frequencies between 5 megahertz and X megahertz from the channel edge, and $55 + 10 \log(P)$ dB on all frequencies more than X megahertz from the channel edge, where X is the greater of 6 megahertz or the actual emission bandwidth. In addition, the attenuation factor shall not be less that $43 + 10 \log(P)$ dB on all frequencies between 2490.5 MHz and 2496 MHz and $55 + 10 \log(P)$ dB at or below 2490.5 MHz. In the 1 MHz bands immediately outside and adjacent to the frequency block a resolution bandwidth of at least two percent may be employed, except when the 1 megahertz band is 2495-2496 MHz, in which case a resolution bandwidth of at least one percent may be employed.

For LTE Band 66

According to FCC 27.53(h) for operations in the 1695-1710 MHz, 1710-1755 MHz, 1755-1780 MHz, 1915-1920 MHz, 1995-2000 MHz, 2000-2020 MHz, 2110-2155 MHz, 2155-2180 MHz, and 2180-2200 bands, the power of any emission outside a licensee's frequency block shall be attenuated below the transmitter power (P) in watts by at least $43 + 10 \log(P)$ dB.

4.5.2 Test Setup

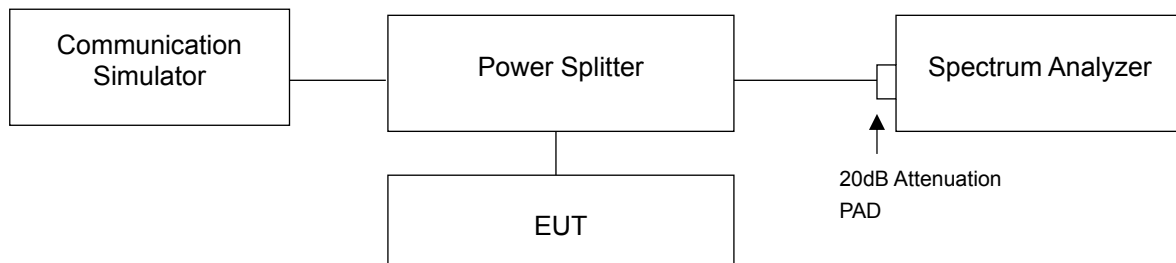

4.5.3 Test Procedures

- All measurements were done at low and high operational frequency range.
- The center frequency of spectrum is the band edge frequency and span is 1MHz. RB of the spectrum is 51kHz and VB of the spectrum is 160kHz (Channel Bandwidth 5MHz).
- The center frequency of spectrum is the band edge frequency and span is 1MHz. RB of the spectrum is 100kHz and VB of the spectrum is 300kHz (Channel Bandwidth 10MHz).
- The center frequency of spectrum is the band edge frequency and span is 1MHz. RB of the spectrum is 150kHz and VB of the spectrum is 470kHz (Channel Bandwidth 15MHz).
- The center frequency of spectrum is the band edge frequency and span is 1MHz. RB of the spectrum is 200kHz and VB of the spectrum is 1MHz (Channel Bandwidth 20MHz).
- Record the max trace plot into the test report.

4.5.4 Test Results

n71

Band edge:

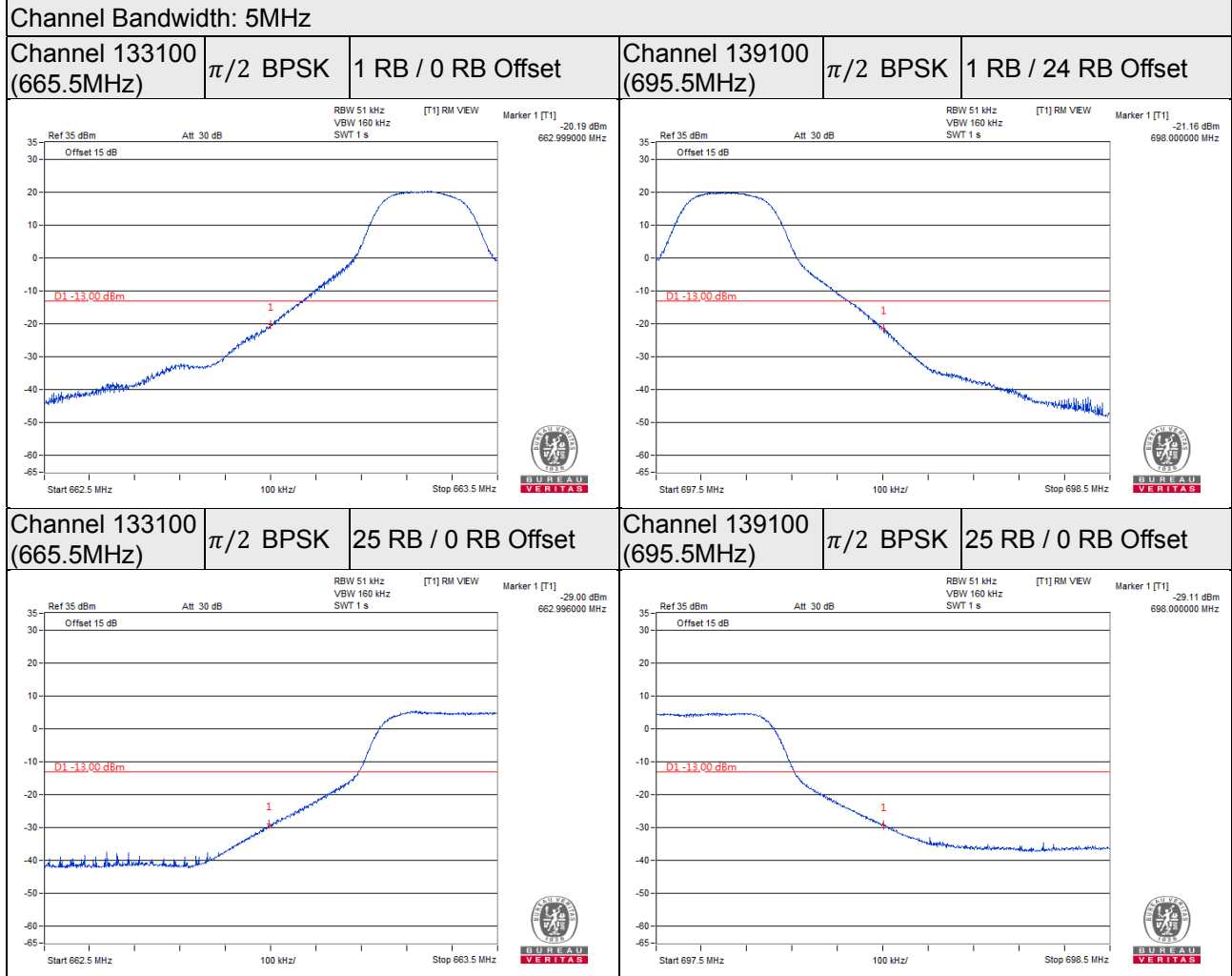

Channel Bandwidth: 10MHz

Channel 133600 (668.0MHz)	$\pi/2$ BPSK	1 RB / 0 RB Offset	Channel 138600 (693.0MHz)	$\pi/2$ BPSK	1 RB / 49 RB Offset
--------------------------------------	--------------	---------------------------	--------------------------------------	--------------	----------------------------

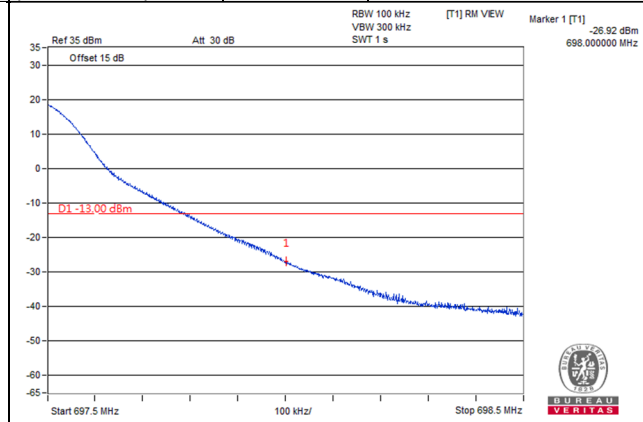
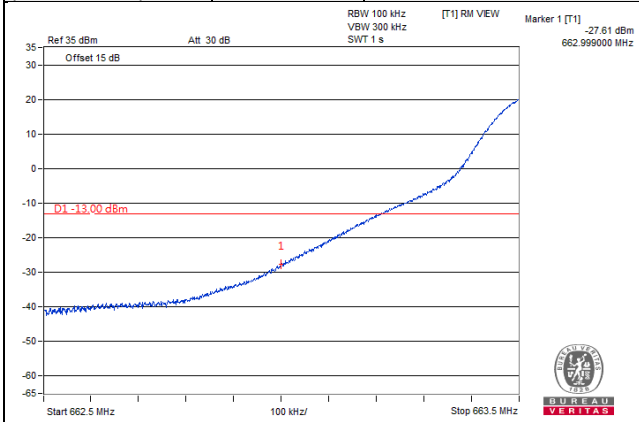

Channel 133600 (668.0MHz)	$\pi/2$ BPSK	50 RB / 0 RB Offse	Channel 138600 (693.0MHz)	$\pi/2$ BPSK	50 RB / 0 RB Offset
--------------------------------------	--------------	---------------------------	--------------------------------------	--------------	----------------------------

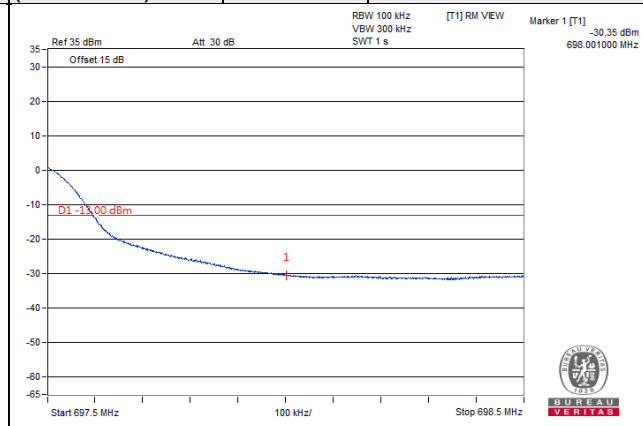
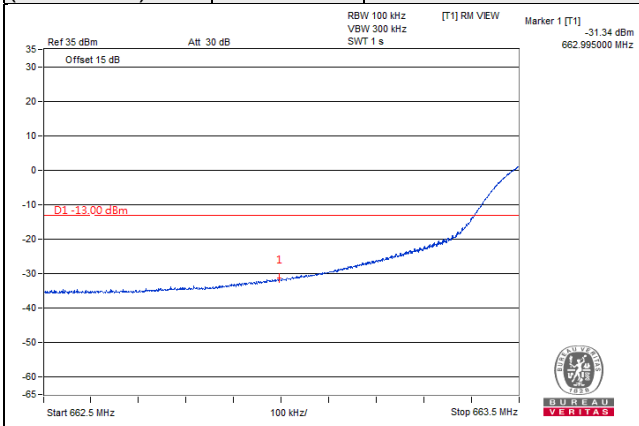

Channel Bandwidth: 15MHz

**Channel 134100
(670.5MHz)**

$\pi/2$ BPSK

1 RB / 0 RB Offset

**Channel 138100
(690.5MHz)**

$\pi/2$ BPSK

1 RB / 74 RB Offset

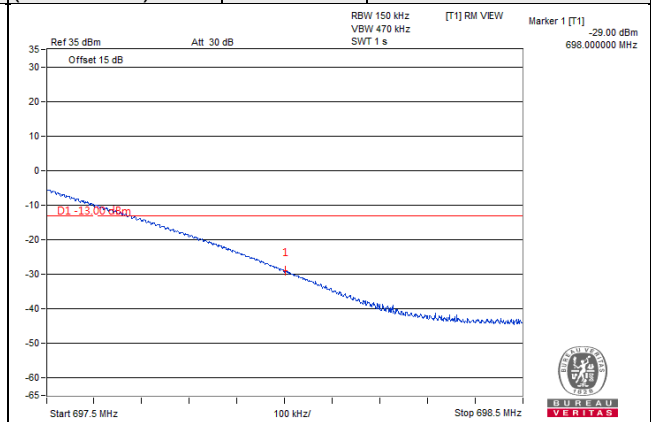
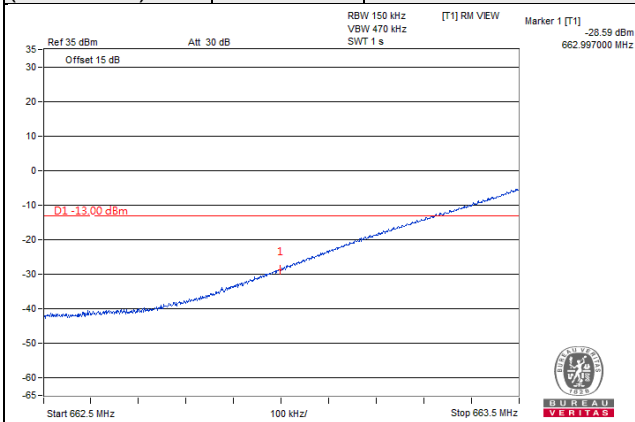

**Channel 134100
(670.5MHz)**

$\pi/2$ BPSK

75 RB / 0 RB Offset

**Channel 138100
(690.5MHz)**

$\pi/2$ BPSK

75 RB / 0 RB Offset

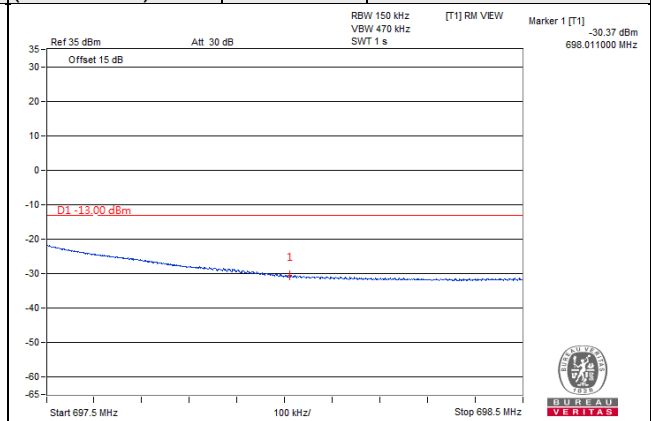
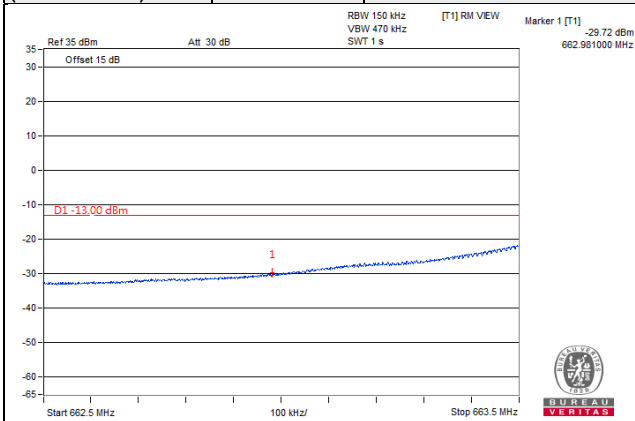

Channel Bandwidth: 20MHz

Channel 134600
(673.0MHz)

$\pi/2$ BPSK

1 RB / 0 RB Offset

Channel 137600
(688.0MHz)

$\pi/2$ BPSK

1 RB / 99 RB Offset

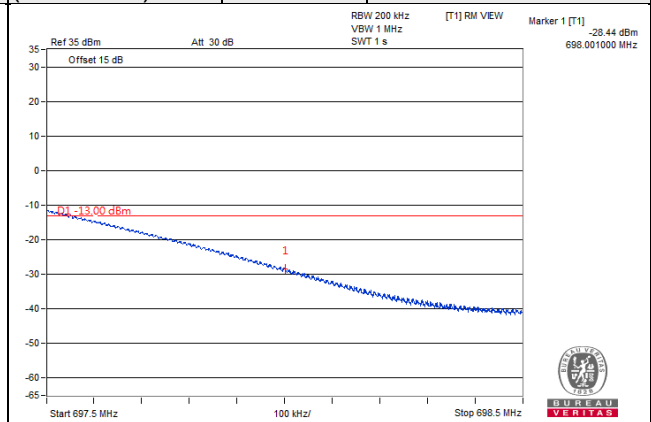
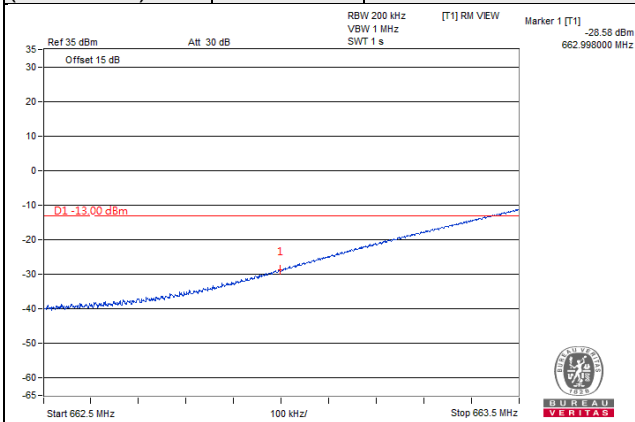

Channel 134600
(673.0MHz)

$\pi/2$ BPSK

100 RB / 0 RB Offset

Channel 137600
(688.0MHz)

$\pi/2$ BPSK

100 RB / 0 RB Offset

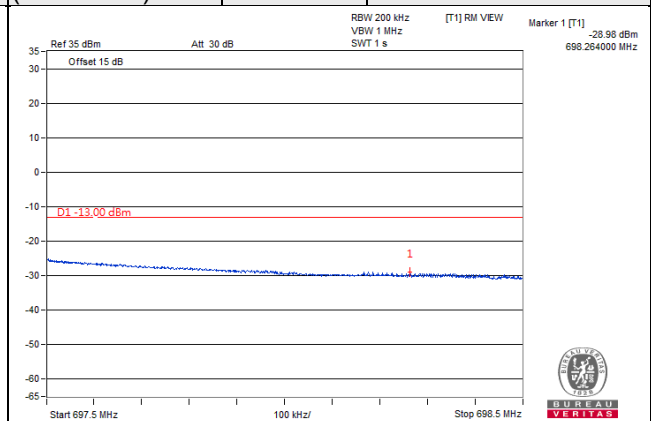
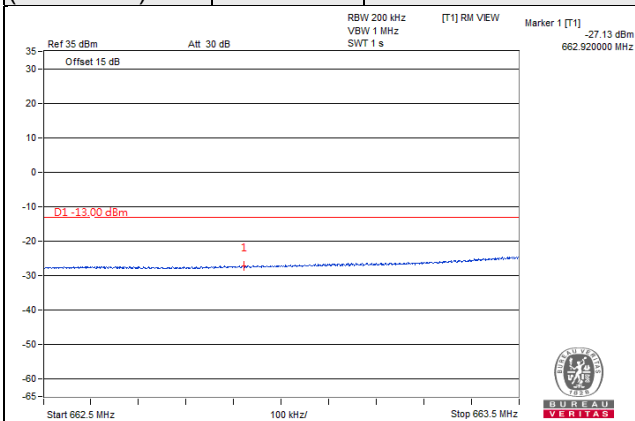

LTE Band 2

Channel Bandwidth 1.4MHz

Channel 18607
(1850.70MHz)

256QAM

1 RB / 0 RB Offset

Channel 19193
(1909.30MHz)

256QAM

1 RB / 5 RB Offset

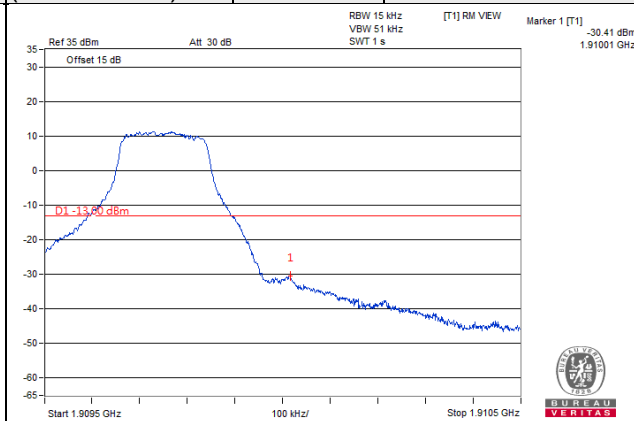
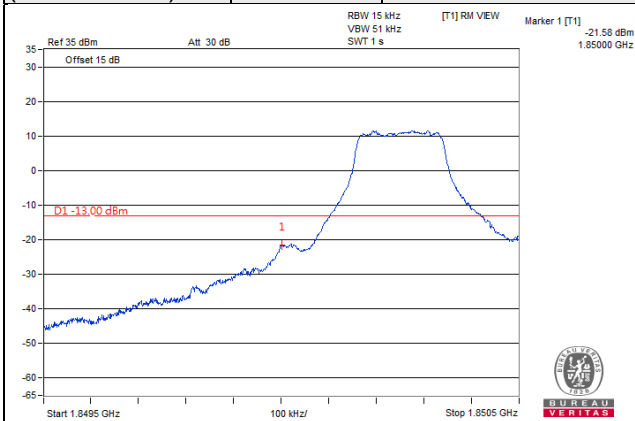

Channel 18607
(1850.70MHz)

256QAM

6 RB / 0 RB Offset

Channel 19193
(1909.30MHz)

256QAM

6 RB / 0 RB Offset

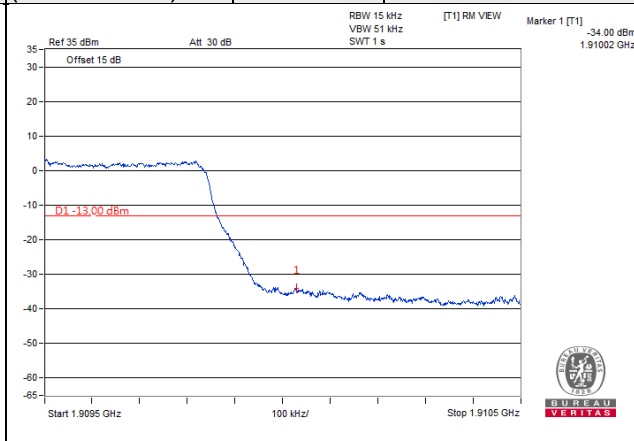
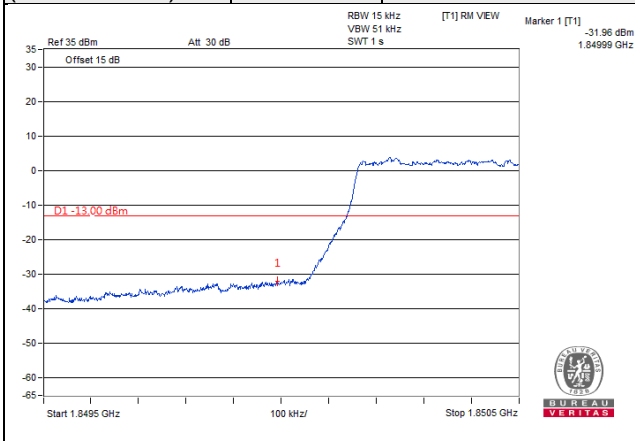

Channel Bandwidth 3MHz

**Channel 18615
(1851.50MHz)**

256QAM

1 RB / 0 RB Offset

**Channel 19185
(1908.50MHz)**

256QAM

1 RB / 14 RB Offset

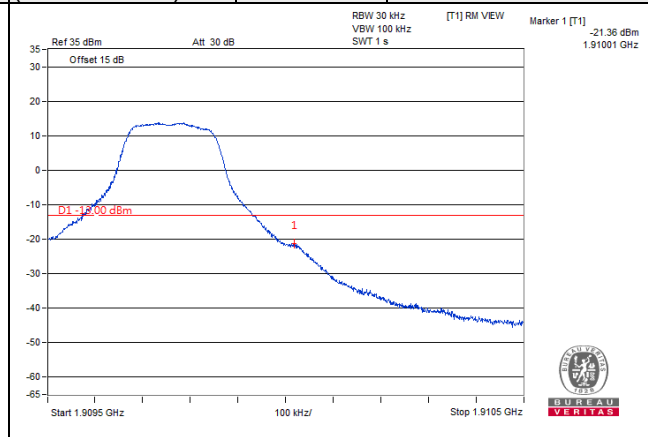
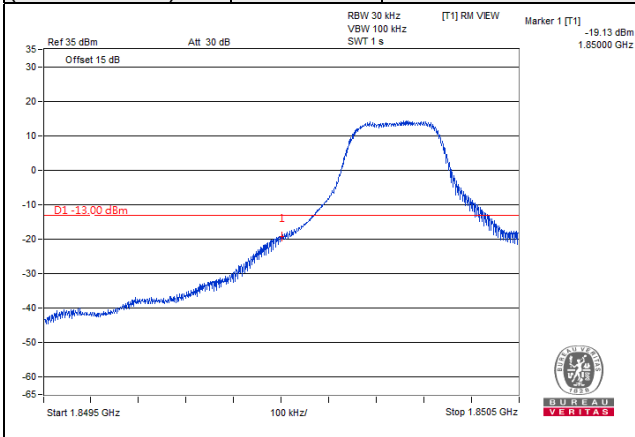

**Channel 18615
(1851.50MHz)**

256QAM

15 RB / 0 RB Offset

**Channel 19185
(1908.50MHz)**

256QAM

15 RB / 0 RB Offset

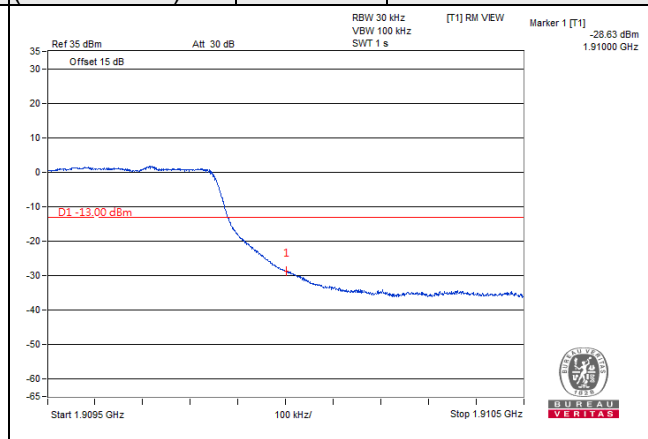
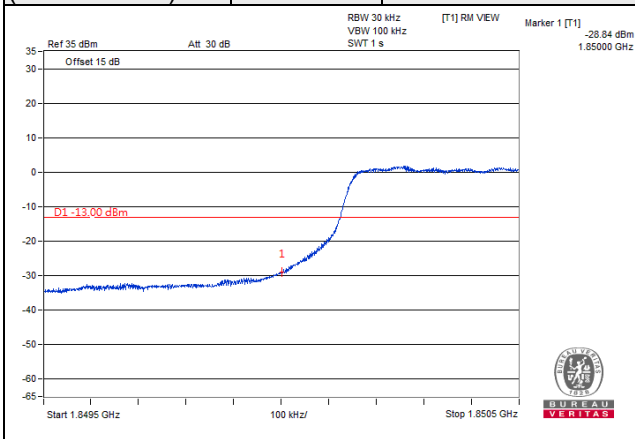

Channel Bandwidth 5MHz

**Channel 18625
(1852.50MHz)**

256QAM

1 RB / 0 RB Offset

**Channel 19175
(1907.50MHz)**

256QAM

1 RB / 24 RB Offset

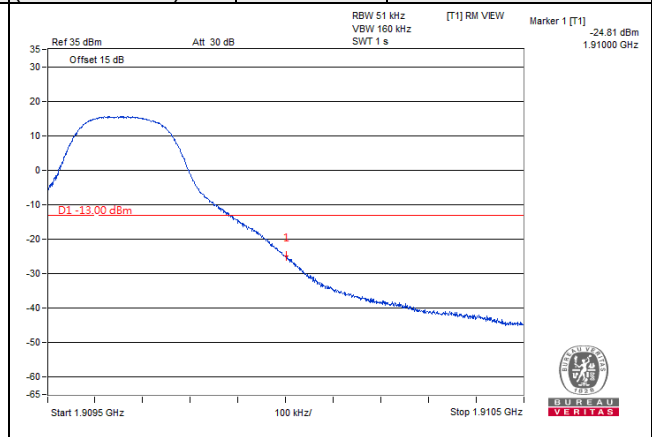
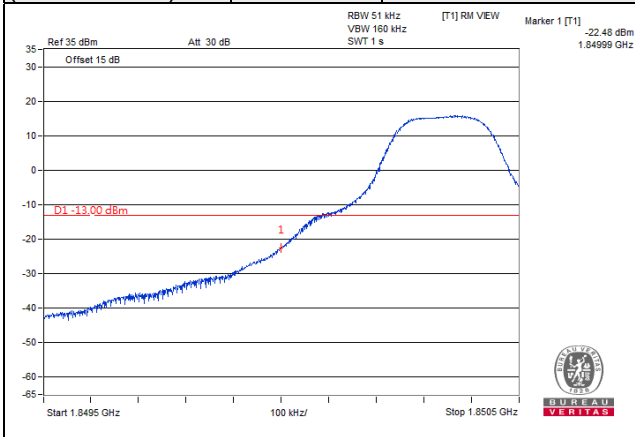

**Channel 18625
(1852.50MHz)**

256QAM

25 RB / 0 RB Offset

**Channel 19175
(1907.50MHz)**

256QAM

25 RB / 0 RB Offset

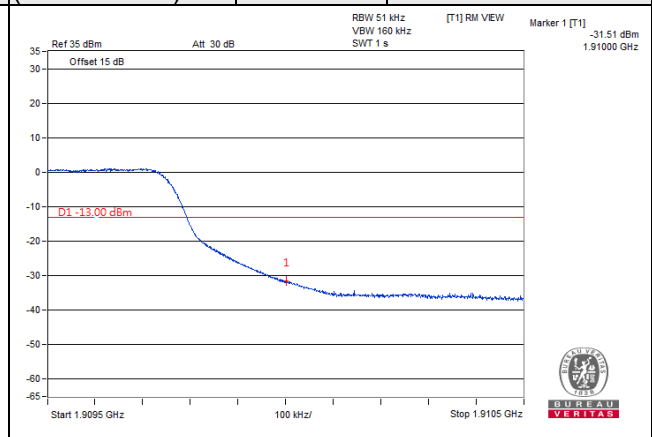
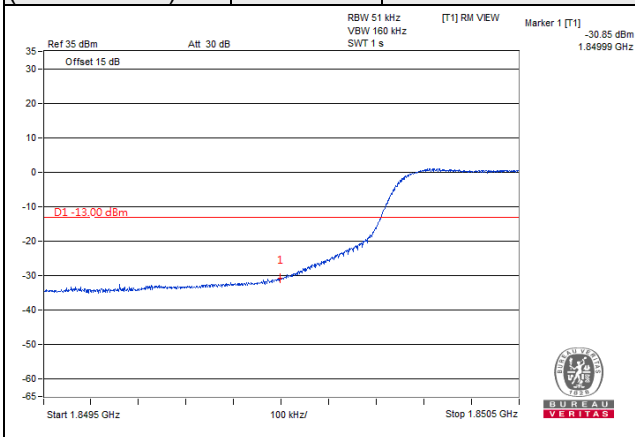

Channel Bandwidth 10MHz

**Channel 18650
(1855.00MHz)**

256QAM

1 RB / 0 RB Offset

**Channel 19150
(1905.00MHz)**

256QAM

1 RB / 49 RB Offset

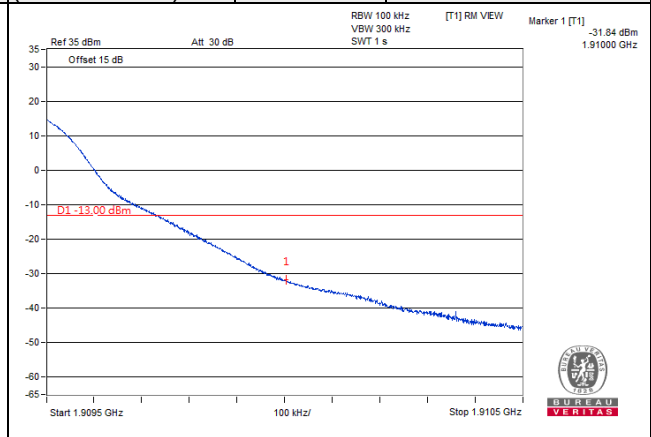
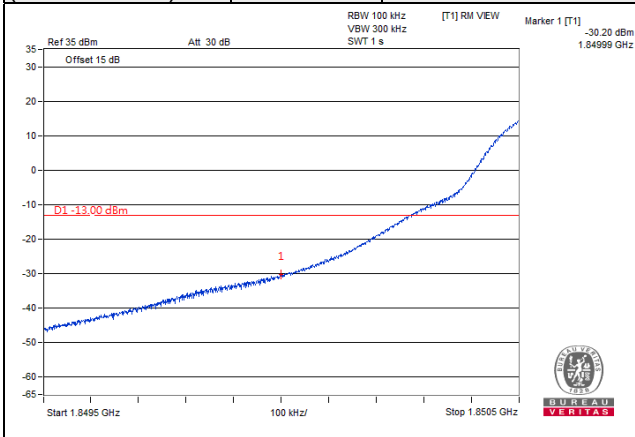

**Channel 18650
(1855.00MHz)**

256QAM

50 RB / 0 RB Offset

**Channel 19150
(1905.00MHz)**

256QAM

50 RB / 0 RB Offset

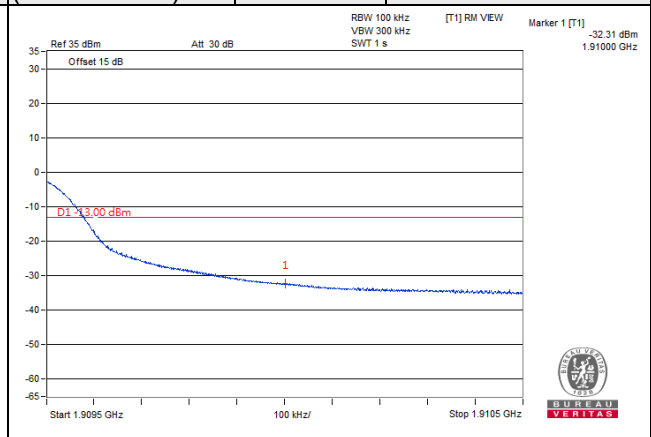
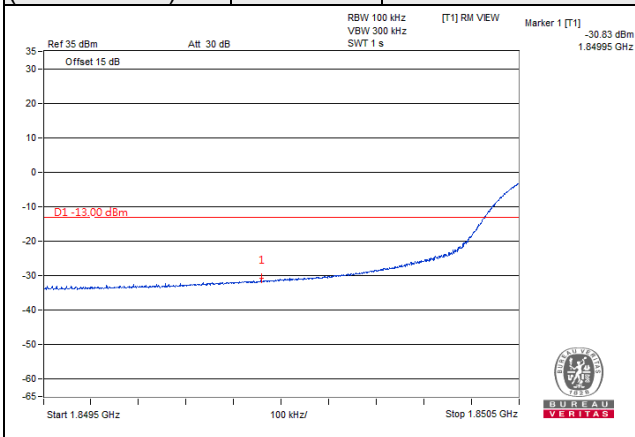

Channel Bandwidth 15MHz

**Channel 18675
(1857.50MHz)**

256QAM

1 RB / 0 RB Offset

**Channel 19125
(1902.50MHz)**

256QAM

1 RB / 74 RB Offset

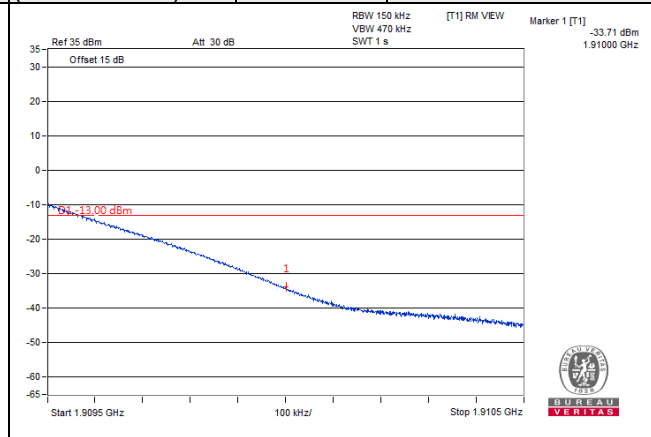
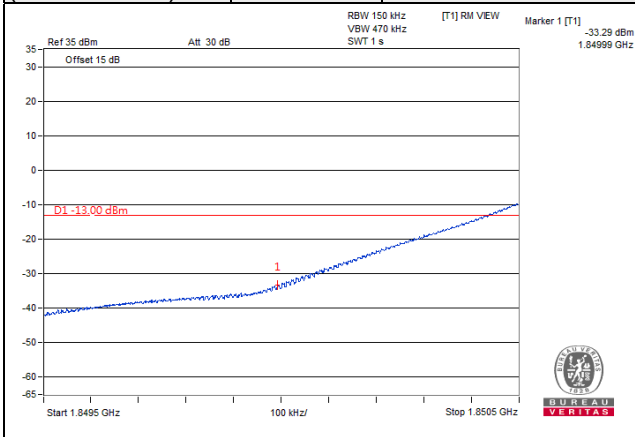

**Channel 18675
(1857.50MHz)**

256QAM

75 RB / 0 RB Offset

**Channel 19125
(1902.50MHz)**

256QAM

75 RB / 0 RB Offset

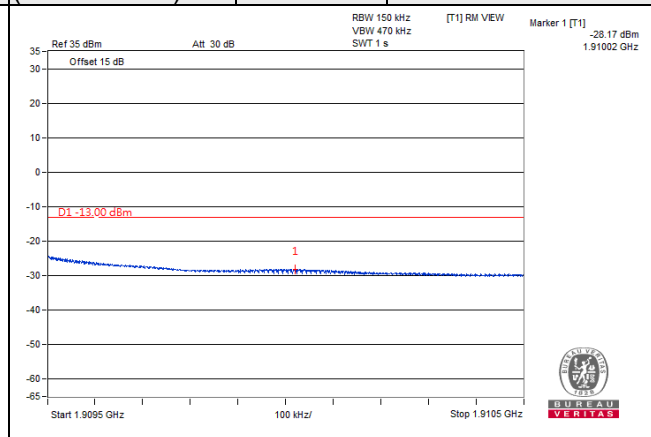
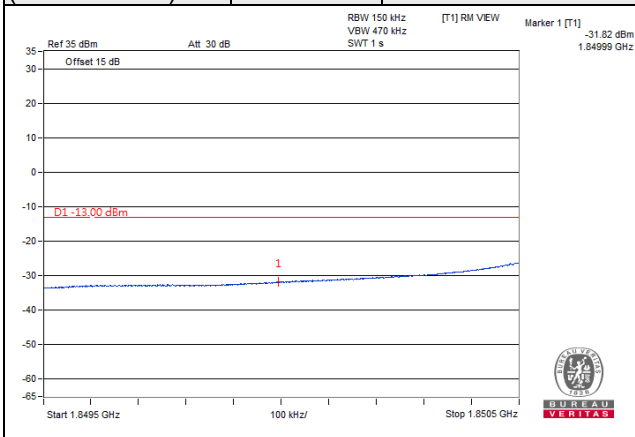

Channel Bandwidth 20MHz

**Channel 18700
(1860.00MHz)**

256QAM

1 RB / 0 RB Offset

**Channel 19100
(1900.00 MHz)**

256QAM

1 RB / 99 RB Offset

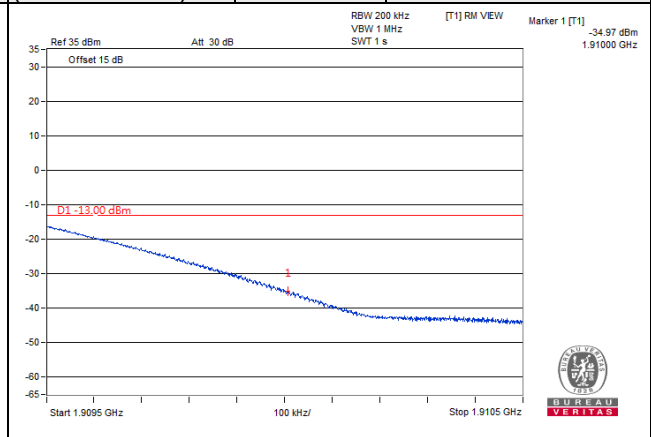
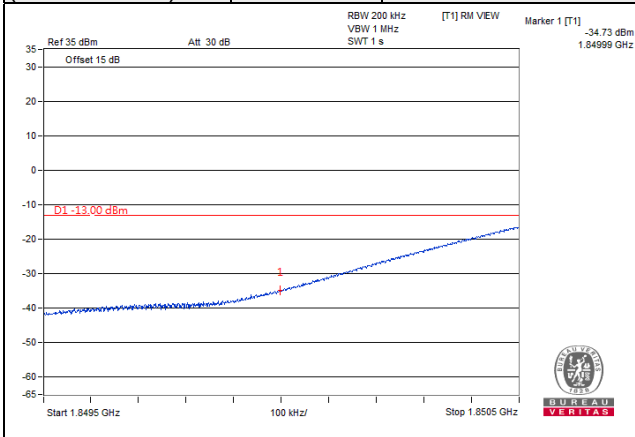

**Channel 18700
(1860.00MHz)**

256QAM

100 RB / 0 RB Offset

**Channel 19100
(1900.00 MHz)**

256QAM

100 RB / 0 RB Offset

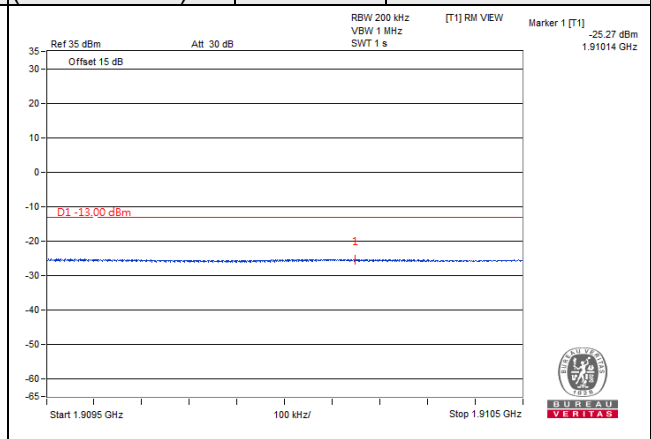
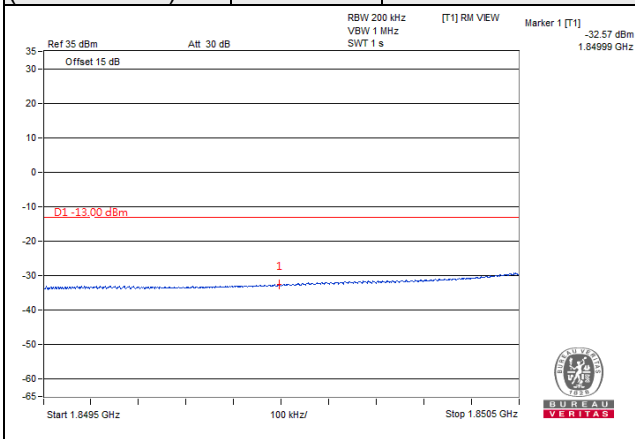

LTE Band 7
Emission Mask:

Channel Bandwidth: 5MHz

Channel 20775 (2502.5MHz) 256QAM 1 RB / 0 RB Offset Channel 21100 (2535.0MHz) 256QAM 1 RB / 0 RB Offset



Channel 20775 (2502.5MHz) 256QAM 1 RB / 24 RB Offset Channel 21100 (2535.0MHz) 256QAM 1 RB / 24 RB Offset

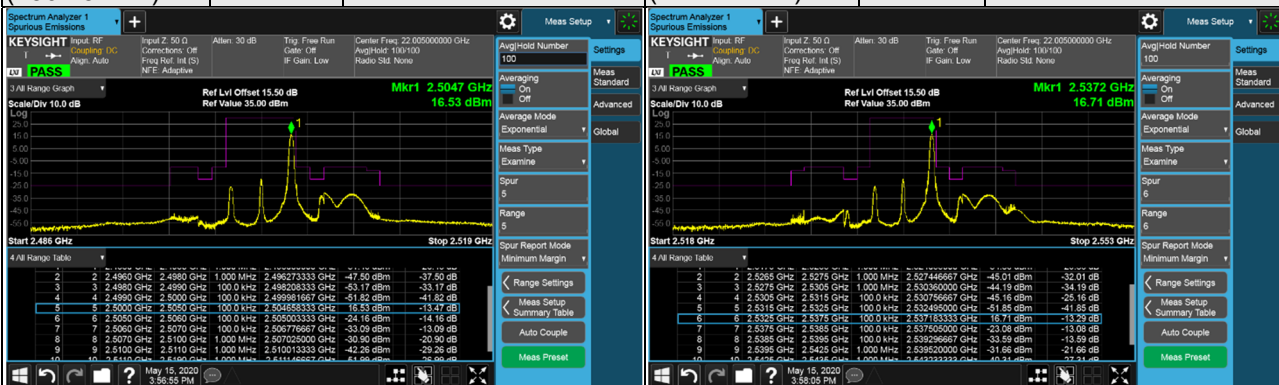

Channel 20775 (2502.5MHz) 256QAM 25 RB / 0 RB Offset Channel 21100 (2535.0MHz) 256QAM 25 RB / 0 RB Offset



Channel Bandwidth: 5MHz

Channel 21425 (2567.5MHz) 256QAM 1 RB / 0 RB Offset

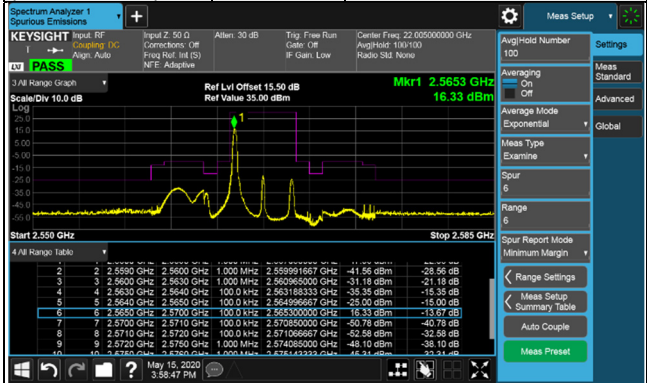

Meas Setup

Settings

Avg/Hold Number: 100

Averaging: On

Average Mode: Exponential

Meas Type: Examine

Spur: 6

Range: 6

Spur Report Mode: Minimum Margin

Range Settings

Meas Setup

Summary Table

Auto Couple

Meas Preset

Channel 21425 (2567.5MHz) 256QAM 1 RB / 24 RB Offset

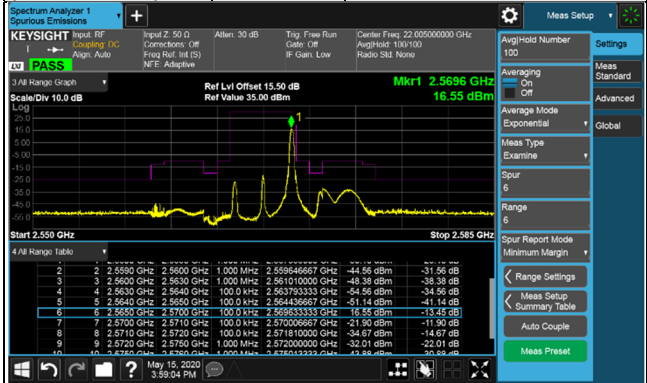

Meas Setup

Settings

Avg/Hold Number: 100

Averaging: On

Average Mode: Exponential

Meas Type: Examine

Spur: 6

Range: 6

Spur Report Mode: Minimum Margin

Range Settings

Meas Setup

Summary Table

Auto Couple

Meas Preset

Channel 21425 (2567.5MHz) 256QAM 25 RB / 0 RB Offset

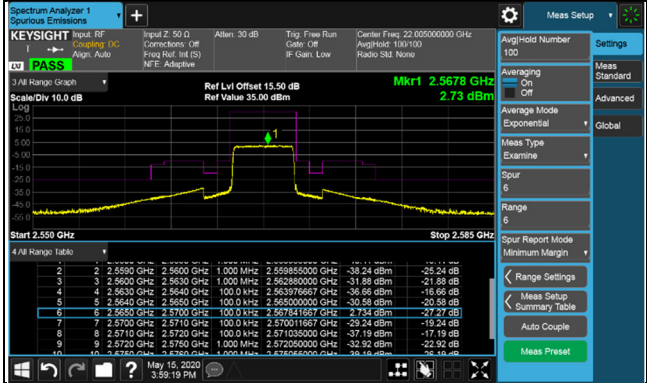

Meas Setup

Settings

Avg/Hold Number: 100

Averaging: On

Average Mode: Exponential

Meas Type: Examine

Spur: 6

Range: 6

Spur Report Mode: Minimum Margin

Range Settings

Meas Setup

Summary Table

Auto Couple

Meas Preset