



FCC RF Test Report

APPLICANT : Fibocom Wireless Inc.
EQUIPMENT : LTE Module
BRAND NAME : Fibocom
MODEL NAME : L860-GL-16
FCC ID : ZMOL860GL16
STANDARD : 47 CFR Part 2, 27(F), 27(H), 27(M), 27(N)
CLASSIFICATION : PCS Licensed Transmitter (PCB)

The product was received on Oct. 30, 2020 and completely tested on Feb. 02, 2021. We, Sporton International (Kunshan) Inc., would like to declare that the tested sample has been evaluated in accordance with the procedures given in ANSI C63.26-2015 and shown compliance with the applicable technical standards.

The test results in this report apply exclusively to the tested model / sample. Without written approval of Sporton International (Kunshan) Inc., the test report shall not be reproduced except in full.

Jason Jia

Reviewed by: Jason Jia / Supervisor

James Huang

Approved by: James Huang / Manager



Sporton International (Kunshan) Inc.

**No. 1098, Pengxi North Road, Kunshan Economic Development Zone Jiangsu Province 215300
People's Republic of China**



TABLE OF CONTENTS

REVISION HISTORY 3
SUMMARY OF TEST RESULT 4
1 GENERAL DESCRIPTION 5
1.1 Applicant 5
1.2 Manufacturer 5
1.3 Product Feature of Equipment Under Test 5
1.4 Product Specification of Equipment Under Test 5
1.5 Modification of EUT 6
1.6 Maximum Conducted Power, Frequency Tolerance, and Emission Designator 6
1.7 Testing Location 8
1.8 Test Software 8
1.9 Applicable Standards 8
2 TEST CONFIGURATION OF EQUIPMENT UNDER TEST 9
2.1 Test Mode 9
2.2 Connection Diagram of Test System 12
2.3 Support Unit used in test configuration and system 12
2.4 Measurement Results Explanation Example 12
2.5 Frequency List of Low/Middle/High Channels 13
3 CONDUCTED TEST ITEMS 19
3.1 Measuring Instruments 19
3.2 Test Setup 19
3.3 Test Result of Conducted Test 19
3.4 Conducted Output Power and ERP/EIRP 20
3.5 Peak-to-Average Ratio 21
3.6 Occupied Bandwidth 22
3.7 Conducted Band Edge 23
3.8 Conducted Spurious Emission 25
3.9 Frequency Stability 26
4 RADIATED TEST ITEMS 27
4.1 Measuring Instruments 27
4.2 Test Setup 27
4.3 Test Result of Radiated Test 27
4.4 Radiated Spurious Emission 28
5 LIST OF MEASURING EQUIPMENT 29
6 UNCERTAINTY OF EVALUATION 30
APPENDIX A. TEST RESULTS OF CONDUCTED TEST
APPENDIX B. TEST RESULTS OF RADIATED TEST
APPENDIX C. TEST SETUP PHOTOGRAPHS



REVISION HISTORY

REPORT NO.	VERSION	DESCRIPTION	ISSUED DATE
FG003022C	Rev. 01	Initial issue of report	Feb. 07, 2021



SUMMARY OF TEST RESULT

Report Section	FCC Rule	Description	Limit	Result	Remark
3.4	§2.1046	Conducted Output Power	Reporting Only	PASS	-
	§27.50(b)(10) §27.50(c)(10)	Effective Radiated Power (Band 12) (Band 13) (Band 17) (Band 71)	ERP < 3 Watt	PASS	
	§27.50(h)(2)	Equivalent Isotropic Radiated Power (Band 7) (Band 38) (Band 41)	EIRP < 2Watt	PASS	
3.5	N/A	Peak-to-Average Ratio	<13 dB	PASS	-
3.6	§2.1049	Occupied Bandwidth	Reporting Only	PASS	-
3.7	§2.1051 §27.53(c)(2)(4) §27.53(g)	Conducted Band Edge Measurement (Band 12) (Band 13) (Band 17) (Band 71)	< 43+10log ₁₀ (P[Watts])	PASS	-
	§27.53(m)(4)	Conducted Band Edge Measurement (Band 7) (Band 38) (Band 41)	§27.53(m)(4)		
3.8	§2.1051 §27.53(c)(2) §27.53(g)	Conducted Spurious Emission (Band 12) (Band 13) (Band 17) (Band 71)	< 43+10log ₁₀ (P[Watts])	PASS	-
	§2.1051 §27.53(m)(4)	Conducted Spurious Emission (Band 7) (Band 38) (Band 41)	< 55+10log ₁₀ (P[Watts])		
3.9	§2.1055 §27.54	Frequency Stability Temperature & Voltage	Within Authorized Band	PASS	-
4.4	§2.1053 §27.53(c)(2) §27.53(f) §27.53(g)	Radiated Spurious Emission (Band 12) (Band 13) (Band 17) (Band 71)	< 43+10log ₁₀ (P[Watts])	PASS	Under limit 20.52 dB at 17505.000 MHz
	§2.1053 §27.53(m)(4)	Radiated Spurious Emission (Band 7) (Band 38) (Band 41)	< 55+10log ₁₀ (P[Watts])		

Declaration of Conformity:

The test results with all measurement uncertainty excluded are presented in accordance with the regulation limits or requirements declared by manufacturers.

Comments and Explanations:

The declared of product specification for EUT presented in the report are provided by the manufacturer, and the manufacturer takes all the responsibilities for the accuracy of product specification.



1 General Description

1.1 Applicant

Fibocom Wireless Inc.

1101, Tower A, Building 6, Shenzhen International Innovation Valley, Dashi 1st Rd, Nanshan, Shenzhen, China

1.2 Manufacturer

Fibocom Wireless Inc.

1101, Tower A, Building 6, Shenzhen International Innovation Valley, Dashi 1st Rd, Nanshan, Shenzhen, China

1.3 Product Feature of Equipment Under Test

Product Feature	
Equipment	LTE Module
Brand Name	Fibocom
Model Name	L860-GL-16
FCC ID	ZMOL860GL16
EUT supports Radios application	WCDMA/LTE/GNSS
HW Version	V1.3
SW Version	18601.5001.00.01.01.01
EUT Stage	Identical Prototype

1.4 Product Specification of Equipment Under Test

Standards-related Product Specification	
Tx Frequency	LTE Band 7 : 2500 MHz ~ 2570 MHz LTE Band 12 : 699 MHz ~ 716 MHz LTE Band 13 : 777 MHz ~ 787 MHz LTE Band 17 : 704 MHz ~ 716 MHz LTE Band 38 : 2570 MHz ~ 2620 MHz LTE Band 41 : 2496 MHz ~ 2690 MHz LTE Band 71: 663 MHz ~ 698 MHz
Rx Frequency	LTE Band 7 : 2620 MHz ~ 2690 MHz LTE Band 12 : 729 MHz ~ 746 MHz LTE Band 13 : 746 MHz ~ 756 MHz LTE Band 17 : 734 MHz ~ 746 MHz LTE Band 38: 2570 MHz ~ 2620 MHz LTE Band 41 : 2496 MHz ~ 2690 MHz LTE Band 71: 617 MHz ~ 652 MHz
Bandwidth	LTE Band 7 : 5MHz/ 10MHz / 15MHz / 20MHz LTE Band 12 : 1.4MHz / 3MHz / 5MHz / 10MHz LTE Band 13 : 5MHz / 10MHz LTE Band 17 : 5MHz / 10MHz



	LTE Band 38 : 5MHz / 10MHz / 15MHz / 20MHz LTE Band 41 : 5MHz / 10MHz / 15MHz / 20MHz LTE Band 71 : 5MHz / 10MHz / 15MHz / 20MHz
Maximum Output Power to Antenna	LTE Band 7 : 23.26 dBm; LTE Band 7C : 23.95 dBm LTE Band 12 : 22.86 dBm LTE Band 13 : 22.73 dBm LTE Band 17 : 22.85 dBm LTE Band 38 : 23.46 dBm LTE Band 41 : 25.35 dBm LTE Band 41C : 23.63 dBm LTE Band 71 : 22.87 dBm
Antenna Gain	LTE Band 7 : 4.00 dBi LTE Band 12 : 3.00 dBi LTE Band 13 : 3.00 dBi LTE Band 17 : 3.00 dBi LTE Band 38 : 4.00 dBi LTE Band 41 : 4.00 dBi LTE Band 71 : 3.00 dBi
Type of Modulation	QPSK / 16QAM / 64QAM

1.5 Modification of EUT

No modifications are made to the EUT during all test items.

1.6 Maximum Conducted Power, Frequency Tolerance, and Emission Designator

LTE Band 7		QPSK			16QAM		
BW (MHz)	Frequency Range (MHz)	Emission Designator (99%OBW)	Frequency Tolerance (ppm)	Maximum Conducted power (W)	Emission Designator (99%OBW)	Frequency Tolerance (ppm)	Maximum Conducted power (W)
20	2510.0 ~ 2560.0	18M4G7D	0.0023	0.2118	18M6W7D	-	0.1888
LTE Band 12		QPSK			16QAM		
BW (MHz)	Frequency Range (MHz)	Emission Designator (99%OBW)	Frequency Tolerance (ppm)	Maximum Conducted power (W)	Emission Designator (99%OBW)	Frequency Tolerance (ppm)	Maximum Conducted power (W)
10	704.0 ~ 711.0	9M05G7D	0.0022	0.1932	8M99W7D	-	0.1663
LTE Band 13		QPSK			16QAM		
BW (MHz)	Frequency Range (MHz)	Emission Designator (99%OBW)	Frequency Tolerance (ppm)	Maximum Conducted power (W)	Emission Designator (99%OBW)	Frequency Tolerance (ppm)	Maximum Conducted power (W)
10	782.0	8M99G7D	0.0102	0.1875	9M07W7D	-	0.1449



LTE Band 17		QPSK			16QAM		
BW (MHz)	Frequency Range (MHz)	Emission Designator (99%OBW)	Frequency Tolerance (ppm)	Maximum Conducted power (W)	Emission Designator (99%OBW)	Frequency Tolerance (ppm)	Maximum Conducted power (W)
10	709.0 ~ 711.0	9M05G7D	0.0022	0.1932	8M99W7D	-	0.1663
LTE Band 38		QPSK			16QAM		
BW (MHz)	Frequency Range (MHz)	Emission Designator (99%OBW)	Frequency Tolerance (ppm)	Maximum Conducted power (W)	Emission Designator (99%OBW)	Frequency Tolerance (ppm)	Maximum Conducted power (W)
20	2580.0 ~ 2610.0	17M9G7D	0.0020	0.2218	17M9W7D	-	0.1932
LTE Band 41 HPUE		QPSK			16QAM		
BW (MHz)	Frequency Range (MHz)	Emission Designator (99%OBW)	Frequency Tolerance (ppm)	Maximum Conducted power (W)	Emission Designator (99%OBW)	Frequency Tolerance (ppm)	Maximum Conducted power (W)
20	2506.0 ~ 2680.0	17M9G7D	0.0020	0.3428	17M9W7D	-	0.2897
LTE Band 71		QPSK			16QAM		
BW (MHz)	Frequency Range (MHz)	Emission Designator (99%OBW)	Frequency Tolerance (ppm)	Maximum Conducted power (W)	Emission Designator (99%OBW)	Frequency Tolerance (ppm)	Maximum Conducted power (W)
20	673.0 ~ 688.0	18M0G7D	0.0046	0.1936	17M9W7D	-	0.1368
LTE Band 7 CA		QPSK			16QAM		
BW (MHz)		Emission Designator (99%OBW)	Frequency Tolerance (ppm)	Maximum Conducted power (W)	Emission Designator (99%OBW)	Frequency Tolerance (ppm)	Maximum Conducted power (W)
20MHz+20MHz		37M6G7D	-	0.2483	37M7W7D	-	0.2323
LTE Band 41 CA		QPSK			16QAM		
BW (MHz)		Emission Designator (99%OBW)	Frequency Tolerance (ppm)	Maximum Conducted power (W)	Emission Designator (99%OBW)	Frequency Tolerance (ppm)	Maximum Conducted power (W)
20MHz+20MHz		37M6G7D	-	0.2307	37M6W7D	-	0.2046

Note:

1. LTE Band 12 overlaps the entire frequency range of LTE Band 17. Therefore, the test results provided in this report covers Band 12 as well as Band 17.
2. LTE Band 41 overlaps the entire frequency range of LTE Band 38. Therefore, the test results provided in this report covers Band 41 as well as Band 38.
3. Based on engineering evaluation, only the maximum bandwidth and the worst modulation test results are shown in the report.



1.7 Testing Location

Sporton International (Kunshan) Inc. is accredited to ISO/IEC 17025:2017 by American Association for Laboratory Accreditation with Certificate Number 5145.02.

Test Firm	Sporton International (Kunshan) Inc.		
Test Site Location	No. 1098, Pengxi North Road, Kunshan Economic Development Zone Jiangsu Province 215300 People's Republic of China TEL : +86-512-57900158 FAX : +86-512-57900958		
Test Site No.	Sporton Site No.	FCC Designation No.	FCC Test Firm Registration No.
	03CH06-KS TH01-KS	CN1257	314309

1.8 Test Software

Item	Site	Manufacturer	Name	Version
1.	03CH06-KS	AUDIX	E3	6.2009-8-24al

1.9 Applicable Standards

According to the specifications of the manufacturer, the EUT must comply with the requirements of the following standards:

- ♦ 47 CFR Part 2, 27(F), 27(H), 27(M),27(N)
- ♦ ANSI C63.26-2015
- ♦ FCC KDB 971168 D01 Power Meas License Digital Systems v03r01
- ♦ FCC KDB 412172 D01 Determining ERP and EIRP v01r01

Remark:

1. All test items were verified and recorded according to the standards and without any deviation during the test.
2. This EUT has also been tested and complied with the requirements of FCC Part 15, Subpart B, recorded in a separate test report.



2 Test Configuration of Equipment Under Test

2.1 Test Mode

Antenna port conducted and radiated test items listed below are performed according to KDB 971168 D01 Power Meas License Digital Systems v03r01 with maximum output power.

Radiated measurements are performed by rotating the EUT in three different orthogonal test planes to find the maximum emission.

Test Items	Band	Bandwidth (MHz)						Modulation			RB #			Test Channel		
		1.4	3	5	10	15	20	QPSK	16QAM	64QAM	1	Half	Full	L	M	H
Max. Output Power	7	-	-	v	v	v	v	v	v	v	v	v	v	v	v	v
	12	v	v	v	v	-	-	v	v	v	v	v	v	v	v	v
	13	-	-	v	v	-	-	v	v	v	v	v	v	v	v	v
	17	-	-	v	v	-	-	v	v	v	v	v	v	v	v	v
	38	-	-	v	v	v	v	v	v	v	v	v	v	v	v	v
	41	-	-	v	v	v	v	v	v	v	v	v	v	v	v	v
	71	-	-	v	v	v	v	v	v	v	v	v	v	v	v	v
Peak-to-Average Ratio	7	-	-				v	v	v				v		v	
	12				v	-	-	v	v				v		v	
	13	-	-		v	-	-	v	v				v		v	
	41	-	-				v	v	v				v		v	
	71	-	-				v	v	v				v		v	
26dB and 99% Bandwidth	7	-	-				v	v	v				v		v	
	12				v	-	-	v	v				v		v	
	13	-	-		v	-	-	v	v				v		v	
	41	-	-				v	v	v				v		v	
	71	-	-				v	v	v				v		v	
Conducted Band Edge	7	-	-	v	v	v	v	v	v		v		v	v		v
	12	v	v	v	v	-	-	v	v		v		v	v		v
	13	-	-	v	v	-	-	v	v		v		v	v		v
	41	-	-	v	v	v	v	v	v		v		v	v		v
	71	-	-	v	v	v	v	v	v		v		v	v		v



Test Items	Band	Bandwidth (MHz)						Modulation			RB #			Test Channel		
		1.4	3	5	10	15	20	QPSK	16QAM	64QAM	1	Half	Full	L	M	H
Conducted Spurious Emission	7	-	-	v	v	v	v	v			v			v	v	v
	12	v	v	v	v	-	-	v			v			v	v	v
	13	-	-	v	v	-	-	v			v			v	v	v
	41	-	-	v	v	v	v	v			v			v	v	v
	71	-	-	v	v	v	v	v			v			v	v	v
Frequency Stability	7	-	-				v	v					v		v	
	12				v	-	-	v					v		v	
	13	-	-		v	-	-	v					v		v	
	41	-	-				v	v					v		v	
	71	-	-				v	v					v		v	
E.R.P / E.I.R.P	7	-	-	v	v	v	v	v	v		v			v	v	v
	12	v	v	v	v	-	-	v	v		v			v	v	v
	13	-	-	v	v	-	-	v	v		v			v	v	v
	41	-	-	v	v	v	v	v	v		v			v	v	v
	71	-	-	v	v	v	v	v	v		v			v	v	v
Radiated Spurious Emission	7	Worst Case											v	v	v	
	12	Worst Case											v	v	v	
	13	Worst Case											v	v	v	
	41	Worst Case											v	v	v	
	71	Worst Case											v	v	v	
Note	<ol style="list-style-type: none"> The mark "v" means that this configuration is chosen for testing The mark "- " means that this bandwidth is not supported. The device is investigated from 30MHz to 10 times of fundamental signal for radiated spurious emission test under different RB size/offset and modulations in exploratory test. Subsequently, only the worst case emissions are reported. LTE Band 12 overlaps the entire frequency range of LTE Band 17. Therefore, the test results provided in this report covers Band 12 as well as Band 17. LTE Band 41 overlaps the entire frequency range of LTE Band 38. Therefore, the test results provided in this report covers Band 41 as well as Band 38. LTE Band 41 support HPUE. 															



Test Items	Band	Bandwidth (MHz)										Modulation			RB #			Test Channel		
		20+20	20+15	15+20	20+10	10+20	20+5	5+20	15+15	15+10	10+15	QPSK	16QAM	64QAM	1	Half	Full	L	M	H
Max. Output Power	7C_CA	v	v	v	v	v	-	-	v	v	-	v	v	v	v	v	v	v	v	v
	41C_CA	v	v	v	v	v	v	v	v	v	v	v	v	v	v	v	v	v	v	v
26dB and 99% Bandwidth	7C_CA	v					-	-			-	v	v				v		v	
	41C_CA	v										v	v				v		v	
Conducted Band Edge	7C_CA	v	v	v	v	v	-	-	v	v	-	v	v		v		v	v	v	
	41C_CA	v	v	v	v	v	v	v	v	v	v	v	v		v		v	v	v	
Conducted Spurious Emission	7C_CA	v	v	v	v	v	-	-	v	v	-	v	v		v			v	v	v
	41C_CA	v	v	v	v	v	v	v	v	v	v	v	v		v			v	v	v
E.I.R.P.	7C_CA	v	v	v	v	v	-	-	v	v	-	v	v	v	v			v	v	v
	41C_CA	v	v	v	v	v	v	v	v	v	v	v	v	v	v			v	v	v
Radiated Spurious Emission	7C_CA	Worst Case																v	v	v
	41C_CA	Worst Case																v	v	v
Note	<ol style="list-style-type: none"> The mark "v" means that this configuration is chosen for testing The mark "-" means that this bandwidth is not supported. The device is investigated from 30MHz to 10 times of fundamental signal for radiated spurious emission test under different RB size/offset and modulations in exploratory test. Subsequently, only the worst case emissions are reported. 																			

2.2 Connection Diagram of Test System

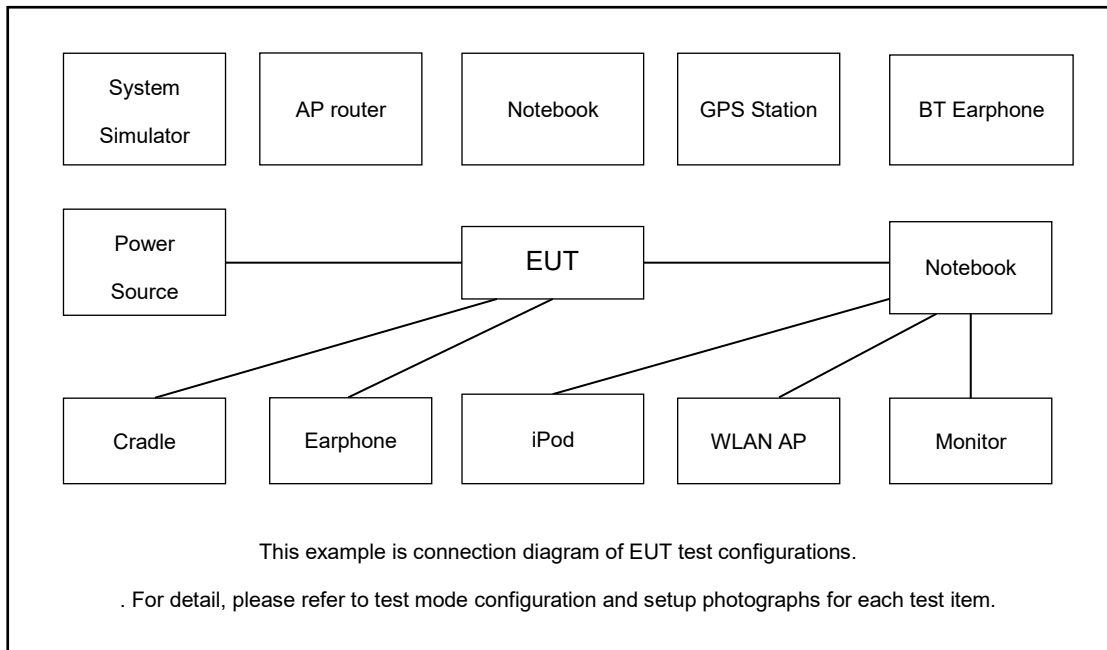

2.3 Support Unit used in test configuration and system

Item	Equipment	Trade Name	Model No.	FCC ID	Data Cable	Power Cord
1.	Power Supply	GWINSTEK	PSS-2002	N/A	N/A	Unshielded, 1.8 m
2.	LTE Base Station	Anritsu	MT8820C	N/A	N/A	Unshielded, 1.8 m

2.4 Measurement Results Explanation Example

For all conducted test items:

The offset level is set in the spectrum analyzer to compensate the RF cable loss and attenuator factor between EUT conducted output port and spectrum analyzer. With the offset compensation, the spectrum analyzer reading level is exactly the EUT RF output level.

The spectrum analyzer offset is derived from RF cable loss and attenuator factor.

Offset = RF cable loss.

Following shows an offset computation example with cable loss 5.8 dB.

Example :

$$\begin{aligned} \text{Offset(dB)} &= \text{RF cable loss(dB)}. \\ &= 5.8 \text{ (dB)} \end{aligned}$$



2.5 Frequency List of Low/Middle/High Channels

LTE Band 7 Channel and Frequency List				
BW [MHz]	Channel/Frequency(MHz)	Lowest	Middle	Highest
20	Channel	20850	21100	21350
	Frequency	2510	2535	2560
15	Channel	20825	21100	21375
	Frequency	2507.5	2535	2562.5
10	Channel	20800	21100	21400
	Frequency	2505	2535	2565
5	Channel	20775	21100	21425
	Frequency	2502.5	2535	2567.5

LTE Band 12 Channel and Frequency List				
BW [MHz]	Channel/Frequency(MHz)	Lowest	Middle	Highest
10	Channel	23060	23095	23130
	Frequency	704	707.5	711
5	Channel	23035	23095	23155
	Frequency	701.5	707.5	713.5
3	Channel	23025	23095	23165
	Frequency	700.5	707.5	714.5
1.4	Channel	23017	23095	23173
	Frequency	699.7	707.5	715.3

LTE Band 13 Channel and Frequency List				
BW [MHz]	Channel/Frequency(MHz)	Lowest	Middle	Highest
10	Channel	-	23230	-
	Frequency	-	782	-
5	Channel	23205	23230	23255
	Frequency	779.5	782	784.5



LTE Band 17 Channel and Frequency List				
BW [MHz]	Channel/Frequency(MHz)	Lowest	Middle	Highest
10	Channel	23780	23790	23800
	Frequency	709	710	711
5	Channel	23755	23790	23825
	Frequency	706.5	710	713.5

LTE Band 38 Channel and Frequency List				
BW [MHz]	Channel/Frequency(MHz)	Lowest	Middle	Highest
20	Channel	37850	38000	38150
	Frequency	2580	2595	2610
15	Channel	37825	38000	38175
	Frequency	2577.5	2595	2612.5
10	Channel	37800	38000	38200
	Frequency	2575	2595	2615
5	Channel	37775	38000	38225
	Frequency	2572.5	2595	2617.5

LTE Band 41 Channel and Frequency List				
BW [MHz]	Channel/Frequency(MHz)	Lowest	Middle	Highest
20	Channel	39750	40620	41490
	Frequency	2506	2593	2680
15	Channel	39725	40620	41515
	Frequency	2503.5	2593	2682.5
10	Channel	39700	40620	41540
	Frequency	2501	2593	2685
5	Channel	39675	40620	41565
	Frequency	2498.5	2593	2687.5



LTE Band 71 Channel and Frequency List				
BW [MHz]	Channel/Frequency(MHz)	Lowest	Middle	Highest
20	Channel	133222	133322	133372
	Frequency	673.0	680.5	688.0
15	Channel	133197	133297	133397
	Frequency	670.5	680.5	690.5
10	Channel	133172	133272	133422
	Frequency	668.0	678.0	693.0
5	Channel	133147	133247	133447
	Frequency	665.5	675.5	695.5



LTE Band 7C_CA Channel and Frequency List					
BW [MHz]	Channel/Frequency(MHz)		Lowest	Middle	Highest
20 + 20	PCC	Channel	20850	21001	21152
		Frequency	2510.0	2525.1	2540.2
	SCC	Channel	21048	21199	21350
		Frequency	2529.8	2544.9	2560.0
20 + 15	PCC	Channel	20850	21026	21201
		Frequency	2510.0	2527.6	2545.1
	SCC	Channel	21021	21197	21372
		Frequency	2527.1	2544.7	2562.2
15 + 20	PCC	Channel	20828	21003	21179
		Frequency	2507.8	2525.3	2542.9
	SCC	Channel	20999	21174	21350
		Frequency	2524.9	2542.4	2560.0
20 + 10	PCC	Channel	20850	21051	21251
		Frequency	2510.0	2530.1	2550.1
	SCC	Channel	20994	21195	21395
		Frequency	2524.4	2544.5	2564.5
10 + 20	PCC	Channel	20805	21006	21206
		Frequency	2505.5	2525.6	2545.6
	SCC	Channel	20949	21150	21350
		Frequency	2519.9	2540.0	2560.0
15 + 15	PCC	Channel	20825	21025	21225
		Frequency	2507.5	2527.5	2547.5
	SCC	Channel	20975	21175	21375
		Frequency	2522.5	2542.5	2562.5
15 + 10	PCC	Channel	20825	21051	21277
		Frequency	2507.5	2530.1	2552.7
	SCC	Channel	20945	21171	21397
		Frequency	2519.5	2542.1	2564.7



LTE Band 41C_CA Channel and Frequency List					
BW [MHz]	Channel/Frequency(MHz)		Lowest	Middle	Highest
20 + 20	PCC	Channel	39750	40521	41292
		Frequency	2506.0	2583.1	2660.2
	SCC	Channel	39948	40719	41490
		Frequency	2525.8	2602.9	2680.0
20 + 15	PCC	Channel	39750	40546	41341
		Frequency	2506.0	2585.6	2665.1
	SCC	Channel	39921	40717	41512
		Frequency	2523.1	2602.7	2682.2
15 + 20	PCC	Channel	39728	40523	41319
		Frequency	2503.8	2593.3	2662.9
	SCC	Channel	39899	40694	41490
		Frequency	2520.9	2600.4	2680.0
20 + 10	PCC	Channel	39750	40571	41391
		Frequency	2506.0	2588.1	2670.1
	SCC	Channel	39894	40715	41535
		Frequency	2520.4	2602.5	2684.5
10 + 20	PCC	Channel	39705	40526	41346
		Frequency	2501.5	2583.6	2665.6
	SCC	Channel	39849	40670	41490
		Frequency	2515.9	2598.0	2680.0



LTE Band 41C_CA Channel and Frequency List					
20 + 5	PCC	Channel	39750	40595	41440
		Frequency	2506.0	2590.5	2675.0
	SCC	Channel	39867	40712	41557
		Frequency	2517.7	2602.2	2686.7
5 + 20	PCC	Channel	39683	40528	41373
		Frequency	2499.3	2583.8	2668.3
	SCC	Channel	39800	40645	41490
		Frequency	2511.0	2595.5	2680.0
15 + 15	PCC	Channel	39725	40545	41365
		Frequency	2503.5	2585.5	2667.5
	SCC	Channel	39875	40695	41515
		Frequency	2518.5	2600.5	2682.5
10 + 15	PCC	Channel	39703	40549	41395
		Frequency	2501.3	2585.9	2670.5
	SCC	Channel	39823	40669	41515
		Frequency	2513.3	2597.9	2682.5
15 + 10	PCC	Channel	39725	40571	41417
		Frequency	2503.5	2588.1	2672.7
	SCC	Channel	39845	40691	41537
		Frequency	2515.5	2600.1	2684.7

3 Conducted Test Items

3.1 Measuring Instruments

See list of measuring instruments of this test report.

3.2 Test Setup

3.2.1 Conducted Output Power

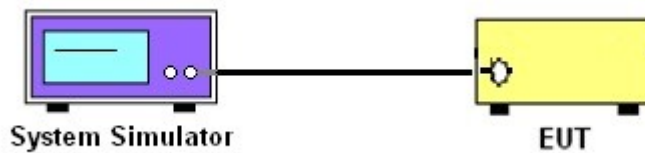

3.2.2 Peak-to-Average Ratio, Occupied Bandwidth ,Conducted Band-Edge and Conducted Spurious Emission



3.2.3 Frequency Stability

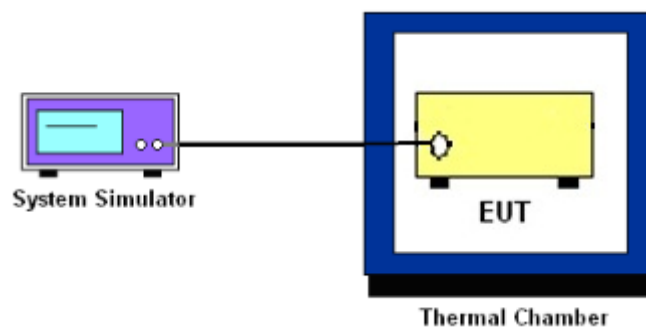

3.3 Test Result of Conducted Test

Please refer to Appendix A.



3.4 Conducted Output Power and ERP/EIRP

3.4.1 Description of the Conducted Output Power Measurement and ERP/EIRP Measurement

A system simulator was used to establish communication with the EUT. Its parameters were set to force the EUT transmitting at maximum output power. The measured power in the radio frequency on the transmitter output terminals shall be reported.

The ERP of mobile transmitters must not exceed 3 Watts for LTE Band 12, Band 13 and Band 17 and Band 71.

The EIRP of mobile transmitters must not exceed 2 Watts for LTE Band 7 and Band 38 and Band 41.

According to KDB 412172 D01 Power Approach,

$EIRP = P_T + G_T - L_C$, $ERP = EIRP - 2.15$, where

P_T = transmitter output power in dBm

G_T = gain of the transmitting antenna in dBi

L_C = signal attenuation in the connecting cable between the transmitter and antenna in dB

3.4.2 Test Procedures

1. The testing follows ANSI C63.26 Section 5.2
2. The transmitter output port was connected to the system simulator.
3. Set EUT at maximum power through the system simulator.
4. Select lowest, middle, and highest channels for each band and different modulation.
5. Measure and record the power level from the system simulator.



3.5 Peak-to-Average Ratio

3.5.1 Description of the PAR Measurement

Power Complementary Cumulative Distribution Function (CCDF) curves provide a means for characterizing the power peaks of a digitally modulated signal on a statistical basis. A CCDF curve depicts the probability of the peak signal amplitude exceeding the average power level. Most contemporary measurement instrumentation include the capability to produce CCDF curves for an input signal provided that the instrument's resolution bandwidth can be set wide enough to accommodate the entire input signal bandwidth. In measuring transmissions in this band using an average power technique, the peak-to-average ratio (PAR) of the transmission may not exceed 13 dB.

3.5.2 Test Procedures

1. The testing follows ANSI C63.26 Section 5.2.3.4 (CCDF).
2. The EUT was connected to spectrum and system simulator via a power divider.
3. Set the CCDF (Complementary Cumulative Distribution Function) option in spectrum analyzer.
4. The highest RF powers were measured and recorded the maximum PAPR level associated with a probability of 0.1 %.
5. Record the deviation as Peak to Average Ratio.



3.6 Occupied Bandwidth

3.6.1 Description of Occupied Bandwidth Measurement

The occupied bandwidth is the width of a frequency band such that, below the lower and above the upper frequency limits, the mean powers emitted are each equal to a specified percentage 0.5% of the total mean transmitted power.

The 26 dB emission bandwidth is defined as the frequency range between two points, one above and one below the carrier frequency, at which the spectral density of the emission is attenuated 26 dB below the maximum in-band spectral density of the modulated signal. Spectral density (power per unit bandwidth) is to be measured with a detector of resolution bandwidth equal to approximately 1.0% of the emission bandwidth.

3.6.2 Test Procedures

1. The testing follows ANSI C63.26 Section 5.4
2. The EUT was connected to spectrum analyzer and system simulator via a power divider.
3. The spectrum analyzer center frequency is set to the nominal EUT channel center frequency. The span range for the spectrum analyzer shall be between two and five times the anticipated OBW.
4. The nominal resolution bandwidth (RBW) shall be in the range of 1 to 5 % of the anticipated OBW, and the VBW shall be at least 3 times the RBW.
5. Set the detection mode to peak, and the trace mode to max hold.
6. Determine the reference value: Set the EUT to transmit a modulated signal. Allow the trace to stabilize. Set the spectrum analyzer marker to the highest level of the displayed trace.
(this is the reference value)
7. Determine the “-26 dB down amplitude” as equal to (Reference Value – X).
8. Place two markers, one at the lowest and the other at the highest frequency of the envelope of the spectral display such that each marker is at or slightly below the “-X dB down amplitude” determined in step 6. If a marker is below this “-X dB down amplitude” value it shall be placed as close as possible to this value. The OBW is the positive frequency difference between the two markers.
9. Use the 99 % power bandwidth function of the spectrum analyzer and report the measured bandwidth.



3.7 Conducted Band Edge

3.7.1 Description of Conducted Band Edge Measurement

27.53 (c)

For operations in the 776-788 MHz band, the FCC limit is $43 + 10\log_{10}(P[\text{Watts}])$ dB below the transmitter power P(Watts) in a 100 kHz bandwidth. However, in the 100 kHz bands immediately outside and adjacent to the frequency block, a resolution bandwidth of at least 30 kHz may be employed. In addition, the power of any unwanted emissions in any 6.25 kHz bandwidth for all frequencies between 763-775 MHz and 793-806 MHz shall be attenuated below the transmitter power, P (dBW), by at least $65 + 10 \log_{10} p(\text{watts})$, dB, for mobile and portable equipment.

27.53 (g)

For operations in the 600MHz band and 698 -746 MHz band, the FCC limit is $43 + 10\log_{10}(P[\text{Watts}])$ dB below the transmitter power P(Watts) in a 100 kHz bandwidth. However, in the 100 kilohertz bands immediately outside and adjacent to a licensee's frequency block, a resolution bandwidth of at least 30 kHz may be employed.

27.53(m)(4)

For mobile digital stations, the attenuation factor shall be not less than $40 + 10 \log (P)$ dB on all frequencies between the channel edge and 5 megahertz from the channel edge, $43 + 10 \log (P)$ dB on all frequencies between 5 megahertz and X megahertz from the channel edge, and $55 + 10 \log (P)$ dB on all frequencies more than X megahertz from the channel edge, where X is the greater of 6 megahertz or the actual emission bandwidth as defined in paragraph (m)(6) of this section. In addition, the attenuation factor shall not be less that $43 + 10 \log (P)$ dB on all frequencies between 2490.5 MHz and 2496 MHz and $55 + 10 \log (P)$ dB at or below 2490.5 MHz. Mobile Satellite Service licensees operating on frequencies below 2495 MHz may also submit a documented interference complaint against BRS licensees operating on channel BRS Channel 1 on the same terms and conditions as adjacent channel BRS or EBS licensees.



3.7.2 Test Procedures

1. The testing follows ANSI C63.26 section 5.7
2. The EUT was connected to spectrum analyzer and system simulator via a power divider.
3. The band edges of low and high channels for the highest RF powers were measured.
4. Set RBW \geq 1% EBW in the 1MHz band immediately outside and adjacent to the band edge.
5. Beyond the 1 MHz band from the band edge, RBW=1MHz was used
6. Set spectrum analyzer with RMS detector.
7. The RF fundamental frequency should be excluded against the limit line in the operating frequency band.
8. Checked that all the results comply with the emission limit line.

Example:

The limit line is derived from $43 + 10\log(P)$ dB below the transmitter power P(Watts)

$$= P(W) - [43 + 10\log(P)] \text{ (dB)}$$

$$= [30 + 10\log(P)] \text{ (dBm)} - [43 + 10\log(P)] \text{ (dB)} = -13\text{dBm}.$$

9. For LTE Band 7, 38, 41, the other 40 dB, and 55 dB have additionally applied same calculation above.



3.8 Conducted Spurious Emission

3.8.1 Description of Conducted Spurious Emission Measurement

The power of any emission outside of the authorized operating frequency ranges must be lower than the transmitter power (P) by a factor of at least $43 + 10 \log (P)$ dB.

For Band 7,38,41:

The power of any emission outside of the authorized operating frequency ranges must be lower than the transmitter power (P) by a factor of at least $55 + 10 \log (P)$ dB.

It is measured by means of a calibrated spectrum analyzer and scanned from 30 MHz up to a frequency including its 10th harmonic.

3.8.2 Test Procedures

1. The testing follows ANSI C63.26 section 5.7
2. The EUT was connected to spectrum analyzer and system simulator via a power divider.
3. The RF output of EUT was connected to the spectrum analyzer by RF cable and attenuator. The path loss was compensated to the results for each measurement.
4. The middle channel for the highest RF power within the transmitting frequency was measured.
5. The conducted spurious emission for the whole frequency range was taken.
6. Make the measurement with the spectrum analyzer's RBW = 1MHz, VBW = 3MHz.
7. Set spectrum analyzer with RMS detector.
8. Taking the record of maximum spurious emission.
9. The RF fundamental frequency should be excluded against the limit line in the operating frequency band.
10. The limit line is derived from $43 + 10\log(P)$ dB below the transmitter power P(Watts)
 $= P(W) - [43 + 10\log(P)]$ (dB)
 $= [30 + 10\log(P)]$ (dBm) - $[43 + 10\log(P)]$ (dB)
 $= -13$ dBm.
11. For Band 7, 38, 41
The limit line is derived from $55 + 10\log(P)$ dB below the transmitter power P(Watts)
 $= P(W) - [55 + 10\log(P)]$ (dB)
 $= [30 + 10\log(P)]$ (dBm) - $[55 + 10\log(P)]$ (dB)
 $= -25$ dBm.



3.9 Frequency Stability

3.9.1 Description of Frequency Stability Measurement

The frequency stability shall be measured by variation of ambient temperature and variation of primary supply voltage to ensure that the fundamental emission stays within the authorized frequency block. The frequency stability of the transmitter shall be maintained within $\pm 0.00025\%$ ($\pm 2.5\text{ppm}$) of the center frequency.

3.9.2 Test Procedures for Temperature Variation

1. The testing follows ANSI C63.26 section 5.6.4
2. The EUT was set up in the thermal chamber and connected with the system simulator.
3. With power OFF, the temperature was decreased to -30°C and the EUT was stabilized before testing. Power was applied and the maximum change in frequency was recorded within one minute.
4. With power OFF, the temperature was raised in 10°C step up to 50°C . The EUT was stabilized at each step for at least half an hour. Power was applied and the maximum frequency change was recorded within one minute.

3.9.3 Test Procedures for Voltage Variation

1. The testing follows ANSI C63.26 section 5.6.5
2. The EUT was placed in a temperature chamber at $20\pm 5^{\circ}\text{C}$ and connected with the system simulator.
3. The power supply voltage to the EUT was varied from 85% to 115% of the nominal value for other than hand carried battery equipment.
4. For hand carried, battery powered equipment, reduce the primary ac or dc supply voltage to the battery operating end point, which shall be specified by the manufacturer.
5. The variation in frequency was measured for the worst case.

4 Radiated Test Items

4.1 Measuring Instruments

See list of measuring instruments of this test report.

4.2 Test Setup

4.2.1 For radiated test from 30MHz to 1GHz

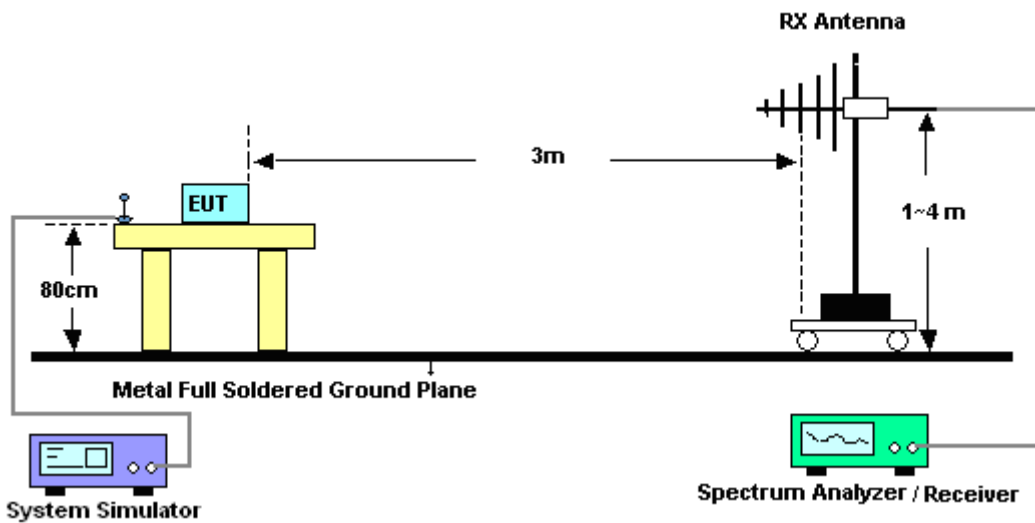

4.2.2 For radiated test above 1GHz

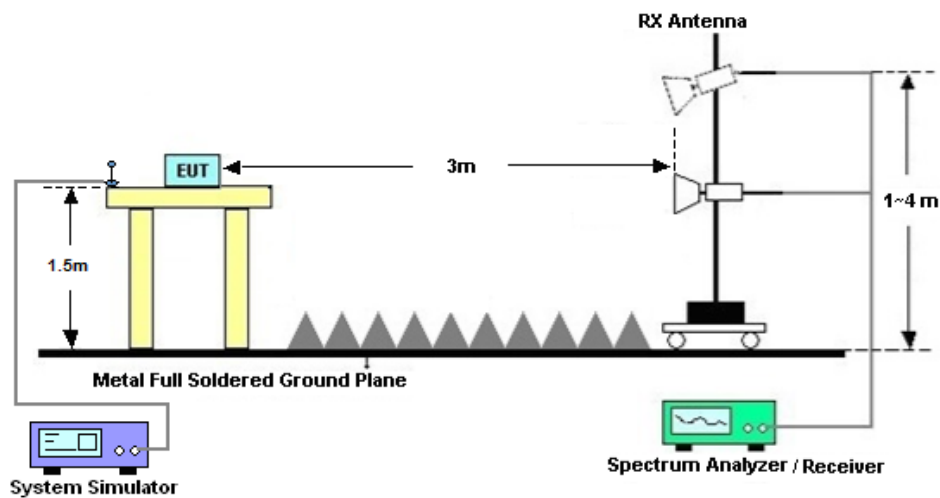

4.3 Test Result of Radiated Test

Please refer to Appendix B.



4.4 Radiated Spurious Emission

4.4.1 Description of Radiated Spurious Emission

The radiated spurious emission was measured by substitution method according to ANSI C63.26. The power of any emission outside of the authorized operating frequency ranges must be attenuated below the transmitter power (P) by a factor of at least $43 + 10 \log (P)$ dB.

For Band 7, 38, 41

The power of any emission outside of the authorized operating frequency ranges must be attenuated below the transmitter power (P) by a factor of at least $55 + 10 \log (P)$ dB.

For LTE Band 13

For operations in the 746-758 MHz, 775-788 MHz, and 805-806 MHz bands, emissions in the band 1559-1610 MHz shall be limited to -70 dBW/MHz equivalent isotropically radiated power (EIRP) for wideband signals, and -80 dBW EIRP for discrete emissions of less than 700 Hz bandwidth.

The spectrum is scanned from 30 MHz up to a frequency including its 10th harmonic.

4.4.2 Test Procedures

1. The testing follows ANSI C63.26 Section 5.5
2. The EUT was placed on a turntable with 0.8 meter height for frequency below 1GHz and 1.5 meter height for frequency above 1GHz respectively above ground.
3. The EUT was set 3 meters from the receiving antenna mounted on the antenna tower.
4. The table was rotated 360 degrees to determine the position of the highest spurious emission.
5. The height of the receiving antenna is varied between 1m to 4m to search the maximum spurious emission for both horizontal and vertical polarizations.
6. During the measurement, the system simulator parameters were set to force the EUT transmitting at maximum output power.
7. Make the measurement with the spectrum analyzer's RBW = 1MHz, VBW = 3MHz, taking the record of maximum spurious emission.
8. A horn antenna was substituted in place of the EUT and was driven by a signal generator.
9. Tune the output power of signal generator to the same emission level with EUT maximum spurious emission.
10. $EIRP (dBm) = S.G. Power - Tx Cable Loss + Tx Antenna Gain$
11. $ERP (dBm) = EIRP - 2.15$
12. The RF fundamental frequency should be excluded against the limit line in the operating frequency band.

The limit line is derived from $43 + 10\log(P)$ dB below the transmitter power P(Watts)
 $= P(W) - [43 + 10\log(P)] (dB)$
 $= [30 + 10\log(P)] (dBm) - [43 + 10\log(P)] (dB)$
 $= -13dBm.$

13. For Band 7, 38, 41:

The limit line is derived from $55 + 10\log(P)$ dB below the transmitter power P(Watts)



5 List of Measuring Equipment

Instrument	Manufacturer	Model No.	Serial No.	Characteristics	Calibration Date	Test Date	Due Date	Remark
Spectrum Analyzer	R&S	FSV40	101040	10Hz~40GHz	Nov. 01, 2020	Nov. 27, 2020~ Feb. 02, 2021	Oct. 31, 2021	Conducted (TH01-KS)
Temperature & humidity chamber	Hongzhan	LP-150U	H2014011440	-40~+150°C 20%~95%RH	Jul. 03, 2020	Nov. 27, 2020~ Feb. 02, 2021	Jul. 02, 2021	Conducted (TH01-KS)
EXA Spectrum Analyzer	Keysight	N9010A	MY55150208	10Hz-44GHz	Apr. 14, 2020	Jan. 10, 2021	Apr. 13, 2021	Radiation (03CH06-KS)
Bilog Antenna	TeseQ	CBL6111D	49921	30MHz-1GHz	May 29, 2020	Jan. 10, 2021	May 28, 2021	Radiation (03CH06-KS)
Double Ridge Horn Antenna	ETS-Lindgren	3117	00218652	1GHz~18GHz	Apr. 27, 2020	Jan. 10, 2021	Apr. 26, 2021	Radiation (03CH06-KS)
SHF-EHF Horn	Com-power	AH-840	101115	18GHz~40GHz	Nov. 06, 2020	Jan. 10, 2021	Nov. 05, 2021	Radiation (03CH06-KS)
Amplifier	SONOMA	310N	187289	9KHz ~1GHZ	Apr. 14, 2020	Jan. 10, 2021	Apr. 13, 2021	Radiation (03CH06-KS)
Amplifier	MITEQ	EM18G40G GA	060728	18~40GHz	Jan. 07, 2021	Jan. 10, 2021	Jan. 06, 2022	Radiation (03CH06-KS)
high gain Amplifier	MITEQ	AMF-7D-00 101800-30-1 0P	2025788	1Ghz-18Ghz	Jan. 06, 2021	Jan. 10, 2021	Jan.05, 2022	Radiation (03CH06-KS)
Amplifier	Keysight	83017A	MY53270203	500MHz~26.5GHz	Apr. 15, 2020	Jan. 10, 2021	Apr. 14, 2021	Radiation (03CH06-KS)
AC Power Source	Chroma	61601	F104090004	N/A	NCR	Jan. 10, 2021	NCR	Radiation (03CH06-KS)
Turn Table	ChamPro	EM 1000-T	060762-T	0~360 degree	NCR	Jan. 10, 2021	NCR	Radiation (03CH06-KS)
Antenna Mast	ChamPro	EM 1000-A	060762-A	1 m~4 m	NCR	Jan. 10, 2021	NCR	Radiation (03CH06-KS)

NCR: No Calibration Required



6 Uncertainty of Evaluation

The measurement uncertainties shown below were calculated in accordance with the requirements of ANSI 63.26-2015. All the measurement uncertainty value were shown with a coverage K=2 to indicate 95% level of confidence. The measurement data show herein meets or exceeds the CISPR measurement uncertainty values specified in CISPR 16-4-2 and can be compared directly to specified limit to determine compliance.

Uncertainty of Radiated Emission Measurement (30 MHz ~ 1000 MHz)

Measuring Uncertainty for a Level of Confidence of 95% (U = 2Uc(y))	2.5dB
---	-------

Uncertainty of Radiated Emission Measurement (1 GHz ~ 40 GHz)

Measuring Uncertainty for a Level of Confidence of 95% (U = 2Uc(y))	2.1dB
---	-------



Appendix A. Test Results of Conducted Test

Conducted Output Power(Average power)

LTE Band 7

BW [MHz]	Modulation	RB Size	RB Offset	Power Low Ch. / Freq.	Power Middle Ch. / Freq.	Power High Ch. / Freq.
Channel				20850	21100	21350
Frequency (MHz)				2510	2535	2560
20	QPSK	1	0	23.12	23.26	22.77
20	QPSK	1	99	23.03	22.86	23.26
20	QPSK	100	0	22.12	22.44	22.13
20	16QAM	1	0	22.56	22.76	21.87
20	64QAM	1	0	21.22	21.59	20.86
Channel				20825	21100	21375
Frequency (MHz)				2507.5	2535	2562.5
15	QPSK	1	0	23.13	23.22	22.89
15	16QAM	1	0	22.56	22.58	22.12
15	64QAM	1	0	21.58	21.36	21.23
Channel				20800	21100	21400
Frequency (MHz)				2505	2535	2565
10	QPSK	1	0	23.23	23.23	23.13
10	16QAM	1	0	22.58	22.52	22.52
10	64QAM	1	0	21.21	21.62	21.52
Channel				20775	21100	21425
Frequency (MHz)				2502.5	2535	2567.5
5	QPSK	1	0	23.06	23.23	23.12
5	16QAM	1	0	22.55	22.44	22.56
5	64QAM	1	0	21.85	21.56	21.52



LTE Band 12

BW [MHz]	Modulation	RB Size	RB Offset	Power Low Ch. / Freq.	Power Middle Ch. / Freq.	Power High Ch. / Freq.
Channel				23060	23095	23130
Frequency (MHz)				704	707.5	711
10	QPSK	1	0	22.58	22.86	22.72
10	QPSK	1	49	22.62	22.56	22.63
10	QPSK	50	0	21.72	21.58	21.68
10	16QAM	1	0	21.65	22.21	21.85
10	64QAM	1	0	20.75	21.97	20.65
Channel				23035	23095	23155
Frequency (MHz)				701.5	707.5	713.5
5	QPSK	1	0	22.63	22.69	22.63
5	16QAM	1	0	21.86	21.86	21.75
5	64QAM	1	0	20.96	20.96	21.13
Channel				23025	23095	23165
Frequency (MHz)				700.5	707.5	714.5
3	QPSK	1	0	22.63	22.63	22.66
3	16QAM	1	0	21.86	21.85	21.86
3	64QAM	1	0	20.75	20.96	20.96
Channel				23017	23095	23173
Frequency (MHz)				699.7	707.5	715.3
1.4	QPSK	1	0	22.56	22.68	22.69
1.4	16QAM	1	0	21.87	21.86	22.20
1.4	64QAM	1	0	21.86	20.96	20.98

LTE Band 13

BW [MHz]	Modulation	RB Size	RB Offset	Power Low Ch. / Freq.	Power Middle Ch. / Freq.	Power High Ch. / Freq.
Channel				23230		
Frequency (MHz)				782		
10	QPSK	1	0		22.73	
10	QPSK	1	49		22.56	
10	QPSK	50	0		21.65	
10	16QAM	1	0		21.86	
10	64QAM	1	0		20.97	
Channel				23205	23230	23255
Frequency (MHz)				779.5	782	784.5
5	QPSK	1	0	22.52	22.65	22.72
5	16QAM	1	0	21.52	21.85	21.36
5	64QAM	1	0	20.96	20.96	20.56



LTE Band 17

BW [MHz]	Modulation	RB Size	RB Offset	Power Low Ch. / Freq.	Power Middle Ch. / Freq.	Power High Ch. / Freq.
Channel				23780	23790	23800
Frequency (MHz)				709	710	711
10	QPSK	1	0	22.85	22.63	22.75
10	QPSK	1	49	22.72	22.69	22.32
10	QPSK	50	0	21.62	21.65	21.82
10	16QAM	1	0	21.87	21.36	21.65
10	64QAM	1	0	21.32	20.85	21.12
Channel				23755	23790	23825
Frequency (MHz)				706.5	710	713.5
5	QPSK	1	0	22.82	22.72	22.63
5	16QAM	1	0	21.86	21.69	21.71
5	64QAM	1	0	20.86	20.78	20.65

LTE Band 71

BW [MHz]	Modulation	RB Size	RB Offset	Power Low Ch. / Freq.	Power Middle Ch. / Freq.	Power High Ch. / Freq.
Channel				133222	133322	133372
Frequency (MHz)				673	683	688
20	QPSK	1	0	22.87	22.63	22.63
20	QPSK	1	99	22.56	22.32	22.02
20	QPSK	100	0	21.58	21.96	21.63
20	16QAM	1	0	21.32	21.36	21.97
20	64QAM	1	0	20.36	20.97	20.69
Channel				133197	133297	133397
Frequency (MHz)				670.5	680.5	690.5
15	QPSK	1	0	22.44	22.74	22.77
15	16QAM	1	0	21.56	21.58	21.96
15	64QAM	1	0	20.96	20.74	20.58
Channel				133172	133272	133422
Frequency (MHz)				668	678	693
10	QPSK	1	0	22.36	22.82	22.86
10	16QAM	1	0	21.86	21.65	21.54
10	64QAM	1	0	20.66	20.69	20.38
Channel				133147	133247	133447
Frequency (MHz)				665.5	675.5	695.5
5	QPSK	1	0	22.58	22.58	22.39
5	16QAM	1	0	21.52	21.63	21.85
5	64QAM	1	0	20.36	20.71	20.36



LTE Band 38

BW [MHz]	Modulation	RB Size	RB Offset	Power Low Ch. / Freq.	Power Middle Ch. / Freq.	Power High Ch. / Freq.
Channel				37850	38000	38150
Frequency (MHz)				2580	2595	2610
20	QPSK	1	0	23.44	23.46	23.26
20	QPSK	1	99	23.39	23.21	23.13
20	QPSK	100	0	23.35	22.25	22.15
20	16QAM	1	0	22.32	22.86	22.36
20	64QAM	1	0	21.36	21.58	21.52
Channel				37825	38000	38175
Frequency (MHz)				2577.5	2595	2612.5
15	QPSK	1	0	23.44	23.36	23.21
15	16QAM	1	0	22.56	22.52	22.39
15	64QAM	1	0	21.36	21.23	21.82
Channel				37800	38000	38200
Frequency (MHz)				2575	2595	2615
10	QPSK	1	0	23.13	23.25	23.13
10	16QAM	1	0	22.52	22.36	22.03
10	64QAM	1	0	21.63	21.32	21.29
Channel				37775	38000	38225
Frequency (MHz)				2572.5	2595	2617.5
5	QPSK	1	0	23.36	23.26	23.13
5	16QAM	1	0	22.63	22.56	22.36
5	64QAM	1	0	21.58	21.63	21.36



LTE Band 41

BW [MHz]	Modulation	RB Size	RB Offset	Power Low Ch. / Freq.	Power Middle Ch. / Freq.	Power High Ch. / Freq.
Channel				39750	40620	41490
Frequency (MHz)				2506	2593	2680
20	QPSK	1	0	25.35	25.32	24.85
20	QPSK	1	99	25.03	25.09	24.87
20	QPSK	100	0	24.26	24.32	24.36
20	16QAM	1	0	24.56	24.62	24.52
20	64QAM	1	0	23.69	23.58	23.55
Channel				39725	40620	41515
Frequency (MHz)				2503.5	2593	2682.5
15	QPSK	1	0	25.33	25.32	24.96
15	16QAM	1	0	24.69	24.44	24.32
15	64QAM	1	0	23.75	23.51	23.36
Channel				39700	40620	41540
Frequency (MHz)				2501	2593	2685
10	QPSK	1	0	25.35	25.33	24.96
10	16QAM	1	0	24.77	24.86	24.25
10	64QAM	1	0	23.63	23.63	23.25
Channel				39675	40620	41565
Frequency (MHz)				2498.5	2593	2687.5
5	QPSK	1	0	25.26	25.22	24.96
5	16QAM	1	0	24.32	24.23	24.32
5	64QAM	1	0	23.36	23.63	23.63



CA Power

CA_7C								
Combination 20MHz+20MHz (100RB+100RB)								
PCC Channel	SCC Channel	Modulation	PCC		SCC		Total RB Size	Measured Power (dBm)
			RB Size	RB offset	RB Size	RB offset		
20850	21048	QPSK	1	0	1	99	2	15.12
			1	99	1	0	2	23.91
			100	0	100	0	101	21.86
		16QAM	1	0	1	99	2	15.32
			1	99	1	0	101	23.66
			1	0	1	99	2	15.13
21001	21199	QPSK	1	0	1	99	2	14.96
			1	99	1	0	2	23.79
			100	0	100	0	101	21.85
		16QAM	1	0	1	99	2	15.55
			1	99	1	0	101	23.26
			1	0	1	99	2	15.12
21152	21350	QPSK	1	0	1	99	2	15.03
			1	99	1	0	2	23.95
			100	0	100	0	101	22.13
		16QAM	1	0	1	99	2	15.65
			1	99	1	0	101	23.36
			1	0	1	99	2	15.52
		64QAM	1	99	1	0	101	22.22



CA_7C								
Combination 20MHz+15MHz (100RB+75RB)								
PCC Channel	SCC Channel	Modulation	PCC		SCC		Total RB Size	Measured Power (dBm)
			RB Size	RB offset	RB Size	RB offset		
20850	21021	QPSK	100	0	75	0	175	20.4
		QPSK	1	0	1	74	2	13.93
		QPSK	1	99	1	0	2	22.36
		16QAM	1	0	1	74	2	14.26
		16QAM	1	99	1	0	2	22.2
21026	21197	QPSK	100	0	75	0	175	20.23
		QPSK	1	0	1	74	2	13.36
		QPSK	1	99	1	0	2	22.38
		16QAM	1	0	1	74	2	13.96
		16QAM	1	99	1	0	2	21.8
21201	21372	QPSK	100	0	75	0	175	20.37
		QPSK	1	0	1	74	2	13.81
		QPSK	1	99	1	0	2	22.13
		16QAM	1	0	1	74	2	13.64
		16QAM	1	99	1	0	2	21.83
Combination 15MHz+20MHz (75RB+100RB)								
PCC Channel	SCC Channel	Modulation	PCC		SCC		Total RB Size	Measured Power (dBm)
			RB Size	RB offset	RB Size	RB offset		
20828	20999	QPSK	75	0	100	0	175	20.41
		QPSK	1	0	1	99	2	13.46
		QPSK	1	74	1	0	2	22.82
		16QAM	1	0	1	99	2	13.7
		16QAM	1	74	1	0	2	21.6
21003	21174	QPSK	75	0	100	0	175	20.34
		QPSK	1	0	1	99	2	13.05
		QPSK	1	74	1	0	2	22.19
		16QAM	1	0	1	99	2	13.83
		16QAM	1	74	1	0	2	21.66
21179	21350	QPSK	75	0	100	0	175	20.33
		QPSK	1	0	1	99	2	13.75
		QPSK	1	74	1	0	2	22.36
		16QAM	1	0	1	99	2	14.3
		16QAM	1	74	1	0	2	21.85



Combination 20MHz+10MHz (100RB+50RB)								
PCC Channel	SCC Channel	Modulation	PCC		SCC		Total RB Size	Measured Power (dBm)
			RB Size	RB offset	RB Size	RB offset		
20850	20994	QPSK	100	0	50	0	150	20.34
		QPSK	1	0	1	49	2	13.71
		QPSK	1	99	1	0	2	22.31
		16QAM	1	0	1	49	2	14.31
		16QAM	1	99	1	0	2	21.74
21051	21195	QPSK	100	0	50	0	150	20.22
		QPSK	1	0	1	49	2	13.7
		QPSK	1	99	1	0	2	22.18
		16QAM	1	0	1	49	2	13.98
		16QAM	1	99	1	0	2	21.42
21251	21395	QPSK	100	0	50	0	150	20.31
		QPSK	1	0	1	49	2	13.76
		QPSK	1	99	1	0	2	22.39
		16QAM	1	0	1	49	2	14.21
		16QAM	1	99	1	0	2	22.28
Combination 10MHz+20MHz (50RB+100RB)								
PCC Channel	SCC Channel	Modulation	PCC		SCC		Total RB Size	Measured Power (dBm)
			RB Size	RB offset	RB Size	RB offset		
20805	20949	QPSK	50	0	100	0	150	20.31
		QPSK	1	0	1	99	2	13.58
		QPSK	1	49	1	0	2	22.35
		16QAM	1	0	1	99	2	14.49
		16QAM	1	49	1	0	2	21.28
21006	21150	QPSK	50	0	100	0	150	20.24
		QPSK	1	0	1	99	2	13.7
		QPSK	1	49	1	0	2	22.19
		16QAM	1	0	1	99	2	13.92
		16QAM	1	49	1	0	2	21.49
21206	21350	QPSK	50	0	100	0	150	20.12
		QPSK	1	0	1	99	2	13.71
		QPSK	1	49	1	0	2	22.35
		16QAM	1	0	1	99	2	13.52
		16QAM	1	49	1	0	2	21.54



Combination 15MHz+15MHz (75RB+75RB)								
PCC Channel	SCC Channel	Modulation	PCC		SCC		Total RB Size	Measured Power (dBm)
			RB Size	RB offset	RB Size	RB offset		
20825	20975	QPSK	75	0	75	0	150	20.35
		QPSK	1	0	1	74	2	13.64
		QPSK	1	74	1	0	2	22.36
		16QAM	1	0	1	74	2	14.06
		16QAM	1	74	1	0	2	22.01
21025	21175	QPSK	75	0	75	0	150	20.24
		QPSK	1	0	1	74	2	13.67
		QPSK	1	74	1	0	2	22.1
		16QAM	1	0	1	74	2	13.82
		16QAM	1	74	1	0	2	21.49
21225	21375	QPSK	75	0	75	0	150	20.3
		QPSK	1	0	1	74	2	13.67
		QPSK	1	74	1	0	2	22.31
		16QAM	1	0	1	74	2	13.83
		16QAM	1	74	1	0	2	21.39
Combination 15MHz+10MHz (75RB+50RB)								
PCC Channel	SCC Channel	Modulation	PCC		SCC		Total RB Size	Measured Power (dBm)
			RB Size	RB offset	RB Size	RB offset		
20825	20945	QPSK	75	0	50	0	125	20.34
		QPSK	1	0	1	49	2	13.8
		QPSK	1	74	1	0	2	22.31
		16QAM	1	0	1	49	2	13.78
		16QAM	1	74	1	0	2	21.4
21051	21171	QPSK	75	0	50	0	125	20.15
		QPSK	1	0	1	49	2	20.32
		QPSK	1	74	1	0	2	22.23
		16QAM	1	0	1	49	2	19.36
		16QAM	1	74	1	0	2	21.94
21277	21397	QPSK	75	0	50	0	125	20.31
		QPSK	1	0	1	49	2	13.94
		QPSK	1	74	1	0	2	22.27
		16QAM	1	0	1	49	2	14.28
		16QAM	1	74	1	0	2	21.69



CA_41C								
Combination 20MHz+20MHz (100RB+100RB)								
PCC Channel	SCC Channel	Modulation	PCC		SCC		Total RB Size	Measured Power (dBm)
			RB Size	RB offset	RB Size	RB offset		
39750	39948	QPSK	1	0	1	99	2	15.03
			1	99	1	0	2	23.63
			100	0	100	0	101	21.59
		16QAM	1	0	1	99	2	15.22
			1	99	1	0	101	23.11
			64QAM	1	0	1	99	2
1	99	1		0	101	22.03		
40521	40719	QPSK	1	0	1	99	2	14.42
			1	99	1	0	2	23.18
			100	0	100	0	101	21.19
		16QAM	1	0	1	99	2	14.77
			1	99	1	0	101	22.81
			64QAM	1	0	1	99	2
1	99	1		0	101	21.63		
41292	41490	QPSK	1	0	1	99	2	14.62
			1	99	1	0	2	23.14
			100	0	100	0	101	21.31
		16QAM	1	0	1	99	2	15.29
			1	99	1	0	101	22.47
			64QAM	1	0	1	99	2
1	99	1		0	101	21.58		



CA_41C								
Combination 20MHz+15MHz (100RB+75RB)								
PCC Channel	SCC Channel	Modulation	PCC		SCC		Total RB Size	Measured Power (dBm)
			RB Size	RB offset	RB Size	RB offset		
39750	39921	QPSK	100	0	75	0	175	21.49
		QPSK	1	0	1	74	2	14.88
		QPSK	1	99	1	0	2	23.51
		16QAM	1	0	1	74	2	15.44
		16QAM	1	99	1	0	2	23.09
40546	40717	QPSK	100	0	75	0	175	21.13
		QPSK	1	0	1	74	2	14.47
		QPSK	1	99	1	0	2	23.22
		16QAM	1	0	1	74	2	15.09
		16QAM	1	99	1	0	2	22.91
41341	41512	QPSK	100	0	75	0	175	21.16
		QPSK	1	0	1	74	2	14.72
		QPSK	1	99	1	0	2	22.96
		16QAM	1	0	1	74	2	14.88
		16QAM	1	99	1	0	2	22.82
Combination 20MHz+10MHz (100RB+50RB)								
PCC Channel	SCC Channel	Modulation	PCC		SCC		Total RB Size	Measured Power (dBm)
			RB Size	RB offset	RB Size	RB offset		
39750	39894	QPSK	100	0	50	0	175	21.41
		QPSK	1	0	1	49	2	14.89
		QPSK	1	99	1	0	2	23.5
		16QAM	1	0	1	49	2	15.44
		16QAM	1	99	1	0	2	23.26
40571	40715	QPSK	100	0	50	0	175	21.14
		QPSK	1	0	1	49	2	14.55
		QPSK	1	99	1	0	2	23.32
		16QAM	1	0	1	49	2	15.17
		16QAM	1	99	1	0	2	22.61
41391	41535	QPSK	100	0	50	0	175	21.11
		QPSK	1	0	1	49	2	14.78
		QPSK	1	99	1	0	2	22.95
		16QAM	1	0	1	49	2	15.14
		16QAM	1	99	1	0	2	22.24



Combination 20MHz+5MHz (100RB+25RB)								
PCC Channel	SCC Channel	Modulation	PCC		SCC		Total RB Size	Measured Power (dBm)
			RB Size	RB offset	RB Size	RB offset		
39750	39867	QPSK	100	0	25	0	175	21.54
		QPSK	1	0	1	24	2	14.98
		QPSK	1	99	1	0	2	22.68
		16QAM	1	0	1	24	2	15.47
		16QAM	1	99	1	0	2	23.19
40595	40712	QPSK	100	0	25	0	175	21.21
		QPSK	1	0	1	24	2	14.62
		QPSK	1	99	1	0	2	23.22
		16QAM	1	0	1	24	2	15.32
		16QAM	1	99	1	0	2	22.79
41440	41557	QPSK	100	0	25	0	175	20.99
		QPSK	1	0	1	24	2	14.67
		QPSK	1	99	1	0	2	22.72
		16QAM	1	0	1	24	2	15.41
		16QAM	1	99	1	0	2	22.56
Combination 15MHz+20MHz (75RB+100RB)								
PCC Channel	SCC Channel	Modulation	PCC		SCC		Total RB Size	Measured Power (dBm)
			RB Size	RB offset	RB Size	RB offset		
39728	39899	QPSK	75	0	100	0	150	21.48
		QPSK	1	0	1	99	2	14.79
		QPSK	1	74	1	0	2	22.41
		16QAM	1	0	1	99	2	15.38
		16QAM	1	74	1	0	2	22.39
40523	40649	QPSK	75	0	100	0	150	21.28
		QPSK	1	0	1	99	2	14.59
		QPSK	1	74	1	0	2	23.33
		16QAM	1	0	1	99	2	15.28
		16QAM	1	74	1	0	2	22.81
41319	41490	QPSK	75	0	100	0	150	21.08
		QPSK	1	0	1	99	2	14.57
		QPSK	1	74	1	0	2	23.01
		16QAM	1	0	1	99	2	14.64
		16QAM	1	74	1	0	2	22.55



Combination 15MHz+15MHz (75RB+75RB)								
PCC Channel	SCC Channel	Modulation	PCC		SCC		Total RB Size	Measured Power (dBm)
			RB Size	RB offset	RB Size	RB offset		
39725	39875	QPSK	75	0	75	0	175	20.76
		QPSK	1	0	1	74	2	14.88
		QPSK	1	74	1	0	2	23.46
		16QAM	1	0	1	74	2	15.36
		16QAM	1	74	1	0	2	23.11
40545	40695	QPSK	75	0	75	0	150	21.08
		QPSK	1	0	1	74	2	14.43
		QPSK	1	74	1	0	2	23.26
		16QAM	1	0	1	74	2	14.96
		16QAM	1	74	1	0	2	22.61
41365	41515	QPSK	75	0	75	0	150	21.07
		QPSK	1	0	1	74	2	14.61
		QPSK	1	74	1	0	2	22.97
		16QAM	1	0	1	74	2	14.78
		16QAM	1	74	1	0	2	22.47
Combination 15MHz+10MHz (75RB+50RB)								
PCC Channel	SCC Channel	Modulation	PCC		SCC		Total RB Size	Measured Power (dBm)
			RB Size	RB offset	RB Size	RB offset		
39725	39845	QPSK	75	0	50	0	175	21.44
		QPSK	1	0	1	49	2	14.85
		QPSK	1	74	1	0	2	23.59
		16QAM	1	0	1	49	2	15.36
		16QAM	1	74	1	0	2	23.08
40571	40691	QPSK	75	0	50	0	125	21.11
		QPSK	1	0	1	49	2	14.52
		QPSK	1	74	1	0	2	23.09
		16QAM	1	0	1	49	2	15.05
		16QAM	1	74	1	0	2	22.64
41417	41537	QPSK	75	0	50	0	125	20.99
		QPSK	1	0	1	49	2	14.71
		QPSK	1	74	1	0	2	22.88
		16QAM	1	0	1	49	125	15.32
		16QAM	1	74	1	0	2	21.83



Combination 10MHz+20MHz (50RB+100RB)								
PCC Channel	SCC Channel	Modulation	PCC		SCC		Total RB Size	Measured Power (dBm)
			RB Size	RB offset	RB Size	RB offset		
39705	39849	QPSK	50	0	100	0	175	21.32
		QPSK	1	0	1	99	2	14.85
		QPSK	1	49	1	0	2	23.55
		16QAM	1	0	1	99	175	15.36
		16QAM	1	49	1	0	2	23.38
40526	40670	QPSK	50	0	100	0	125	21.17
		QPSK	1	0	1	99	2	14.45
		QPSK	1	49	1	0	2	23.12
		16QAM	1	0	1	99	125	14.94
		16QAM	1	49	1	0	2	22.67
41346	41490	QPSK	50	0	100	0	125	21.1
		QPSK	1	0	1	99	2	14.61
		QPSK	1	49	1	0	2	23.06
		16QAM	1	0	1	99	125	15.24
		16QAM	1	49	1	0	2	22.68
Combination 10MHz+15MHz (50RB+75RB)								
PCC Channel	SCC Channel	Modulation	PCC		SCC		Total RB Size	Measured Power (dBm)
			RB Size	RB offset	RB Size	RB offset		
39703	39823	QPSK	50	0	75	0	125	21.41
		QPSK	1	0	1	74	2	14.87
		QPSK	1	49	1	0	2	23.45
		16QAM	1	0	1	74	125	15.28
		16QAM	1	49	1	0	2	23.13
40549	40669	QPSK	50	0	75	0	175	21.16
		QPSK	1	0	1	74	2	14.64
		QPSK	1	49	1	0	2	23.25
		16QAM	1	0	1	74	175	14.95
		16QAM	1	49	1	0	2	22.44
41395	41515	QPSK	50	0	75	0	125	21.11
		QPSK	1	0	1	74	2	14.57
		QPSK	1	49	1	0	2	23.02
		16QAM	1	0	1	74	125	14.9
		16QAM	1	49	1	0	2	22.59



Combination 5MHz+20MHz (25RB+100RB)								
PCC Channel	SCC Channel	Modulation	PCC		SCC		Total RB Size	Measured Power (dBm)
			RB Size	RB offset	RB Size	RB offset		
39683	39800	QPSK	25	0	100	0	125	21.47
		QPSK	1	0	1	99	2	14.82
		QPSK	1	24	1	0	2	22.13
		16QAM	1	0	1	99	125	22.86
		16QAM	1	24	1	0	2	22.51
40528	40645	QPSK	25	0	100	0	125	21.18
		QPSK	1	0	1	99	2	14.47
		QPSK	1	24	1	0	2	22.64
		16QAM	1	0	1	99	125	15.05
		16QAM	1	24	1	0	2	22.39
41373	41490	QPSK	25	0	100	0	175	21.06
		QPSK	1	0	1	99	2	14.61
		QPSK	1	24	1	0	2	22.58
		16QAM	1	0	1	99	175	15.07
		16QAM	1	24	1	0	2	22.29



ERP/EIRP

LTE Band 7 (GT - LC = 4.00 dB) QPSK			
Bandwidth	5M		
Channel	20775	21100	21425
	(Low)	(Mid)	(High)
Frequency (MHz)	2502.5	2535	2567.5
	Conducted Power (dBm)	23.06	23.23
Conducted Power (Watts)	0.2023	0.2104	0.2051
EIRP(dBm)	27.06	27.23	27.12
EIRP(Watts)	0.5082	0.5284	0.5152

LTE Band 7 (GT - LC = 4.00 dB) QPSK									
Bandwidth	10M			15M			20M		
Channel	20800	21100	21400	20825	21100	21375	20850	21100	21350
	(Low)	(Mid)	(High)	(Low)	(Mid)	(High)	(Low)	(Mid)	(High)
Frequency (MHz)	2505	2535	2565	2507.5	2535	2562.5	2510	2535	2560
	Conducted Power (dBm)	23.23	23.23	23.13	23.13	23.22	22.89	23.12	23.26
Conducted Power (Watts)	0.2104	0.2104	0.2056	0.2056	0.2099	0.1945	0.2051	0.2118	0.1892
EIRP(dBm)	27.23	27.23	27.13	27.13	27.22	26.89	27.12	27.26	26.77
EIRP(Watts)	0.5284	0.5284	0.5164	0.5164	0.5272	0.4887	0.5152	0.5321	0.4753



LTE Band 7 (GT - LC = 4.00 dB) 16QAM			
Bandwidth	5M		
Channel	20775	21100	21425
	(Low)	(Mid)	(High)
Frequency	2502.5	2535	2567.5
(MHz)			
Conducted Power (dBm)	22.55	22.44	22.56
Conducted Power (Watts)	0.1799	0.1754	0.1803
EIRP(dBm)	26.55	26.44	26.56
EIRP(Watts)	0.4519	0.4406	0.4529

LTE Band 7 (GT - LC = 4.00 dB) 16QAM									
Bandwidth	10M			15M			20M		
Channel	20800	21100	21400	20825	21100	21375	20850	21100	21350
	(Low)	(Mid)	(High)	(Low)	(Mid)	(High)	(Low)	(Mid)	(High)
Frequency	2505	2535	2565	2507.5	2535	2562.5	2510	2535	2560
(MHz)									
Conducted Power (dBm)	22.58	22.52	22.52	22.56	22.58	22.12	22.56	22.76	21.87
Conducted Power (Watts)	0.1811	0.1786	0.1786	0.1803	0.1811	0.1629	0.1803	0.1888	0.1538
EIRP(dBm)	26.58	26.52	26.52	26.56	26.58	26.12	26.56	26.76	25.87
EIRP(Watts)	0.4550	0.4487	0.4487	0.4529	0.4550	0.4093	0.4529	0.4742	0.3864



LTE Band 12 (GT - LC = 3.00 dB) QPSK									
Bandwidth	1.4M			3M			5M		
Channel	23017	23095	23173	23025	23095	23165	23035	23095	23155
	(Low)	(Mid)	(High)	(Low)	(Mid)	(High)	(Low)	(Mid)	(High)
Frequency (MHz)	699.7	707.5	715.3	700.5	707.5	714.5	701.5	707.5	713.5
Conducted Power (dBm)	22.56	22.68	22.69	22.63	22.63	22.66	22.63	22.69	22.63
Conducted Power (Watts)	0.1803	0.1854	0.1858	0.1832	0.1832	0.1845	0.1832	0.1858	0.1832
ERP(dBm)	23.41	23.53	23.54	23.48	23.48	23.51	23.48	23.54	23.48
ERP(Watts)	0.2193	0.2254	0.2259	0.2228	0.2228	0.2244	0.2228	0.2259	0.2228

LTE Band 12 (GT - LC = 3.00 dB) QPSK			
Bandwidth	10M		
Channel	23060	23095	23130
	(Low)	(Mid)	(High)
Frequency (MHz)	704	707.5	711
Conducted Power (dBm)	22.58	22.86	22.72
Conducted Power (Watts)	0.1811	0.1932	0.1871
ERP(dBm)	23.43	23.71	23.57
ERP(Watts)	0.2203	0.2350	0.2275



LTE Band 12 (GT - LC = 3.00 dB) 16QAM									
Bandwidth	1.4M			3M			5M		
Channel	23017	23095	23173	23025	23095	23165	23035	23095	23155
	(Low)	(Mid)	(High)	(Low)	(Mid)	(High)	(Low)	(Mid)	(High)
Frequency	699.7	707.5	715.3	700.5	707.5	714.5	701.5	707.5	713.5
(MHz)									
Conducted Power (dBm)	21.87	21.86	22.20	21.86	21.85	21.86	21.86	21.86	21.75
Conducted Power (Watts)	0.1538	0.1535	0.1660	0.1535	0.1531	0.1535	0.1535	0.1535	0.1496
ERP(dBm)	22.72	22.71	23.05	22.71	22.70	22.71	22.71	22.71	22.60
ERP(Watts)	0.1871	0.1866	0.2018	0.1866	0.1862	0.1866	0.1866	0.1866	0.1820

LTE Band 12 (GT - LC = 3.00 dB) 16QAM			
Bandwidth	10M		
Channel	23060	23095	23130
	(Low)	(Mid)	(High)
Frequency	704	707.5	711
(MHz)			
Conducted Power (dBm)	21.65	22.21	21.85
Conducted Power (Watts)	0.1462	0.1663	0.1531
ERP(dBm)	22.50	23.06	22.70
ERP(Watts)	0.1778	0.2023	0.1862



LTE Band 13 (GT - LC = 3.00 dB) QPSK						
Bandwidth	5M			10M		
Channel	23205	23230	23255	23230		
	(Low)	(Mid)	(High)	-	(Mid)	-
Frequency	779.5	782	784.5	-	782	-
(MHz)						
Conducted Power (dBm)	22.52	22.65	22.72		22.73	-
Conducted Power (Watts)	0.1786	0.1841	0.1871		0.1875	-
ERP(dBm)	23.37	23.50	23.57		23.58	-
ERP(Watts)	0.2173	0.2239	0.2275		0.2280	-

LTE Band 13 (GT - LC = 3.00 dB) 16QAM						
Bandwidth	5M			10M		
Channel	23205	23230	23255	23230		
	(Low)	(Mid)	(High)	-	(Mid)	-
Frequency	779.5	782	784.5	-	782	-
(MHz)						
Conducted Power (dBm)	21.52	21.86	21.36		21.61	-
Conducted Power (Watts)	0.1419	0.1535	0.1368		0.1449	-
ERP(dBm)	22.37	22.71	22.21		22.46	-
ERP(Watts)	0.1726	0.1866	0.1663		0.1762	-



LTE Band 41 (G _T - L _C = 4.00 dB) QPSK									
Bandwidth	5M			10M			15M		
Channel	39675	40620	41565	39700	40620	41540	39725	40620	41515
	(Low)	(Mid)	(High)	(Low)	(Mid)	(High)	(Low)	(Mid)	(High)
Frequency (MHz)	2498.5	2593	2687.5	2501	2593	2685	2503.5	2593	2682.5
Conducted Power (dBm)	25.26	25.22	24.96	25.35	25.33	24.96	25.33	25.32	24.96
Conducted Power (Watts)	0.3357	0.3327	0.3133	0.3428	0.3412	0.3133	0.3412	0.3404	0.3133
EIRP(dBm)	29.26	29.22	28.96	29.35	29.33	28.96	29.33	29.32	28.96
EIRP(Watts)	0.8433	0.8356	0.7870	0.8610	0.8570	0.7870	0.8570	0.8551	0.7870

LTE Band 41 (G _T - L _C = 4.00 dB) QPSK			
Bandwidth	20M		
Channel	39750	40620	41490
	(Low)	(Mid)	(High)
Frequency (MHz)	2506	2593	2680
Conducted Power (dBm)	25.35	25.32	24.85
Conducted Power (Watts)	0.3428	0.3404	0.3055
EIRP(dBm)	29.35	29.32	28.85
EIRP(Watts)	0.8610	0.8551	0.7674



LTE Band 41 (G _T - L _C = 4.00 dB) 16QAM									
Bandwidth	5M			10M			15M		
Channel	39675	40620	41565	39700	40620	41540	39725	40620	41515
	(Low)	(Mid)	(High)	(Low)	(Mid)	(High)	(Low)	(Mid)	(High)
Frequency (MHz)	2498.5	2593	2687.5	2501	2593	2685	2503.5	2593	2682.5
Conducted Power (dBm)	24.32	24.23	24.32	24.77	24.86	24.25	24.69	24.44	24.32
Conducted Power (Watts)	0.2704	0.2649	0.2704	0.2999	0.3062	0.2661	0.2944	0.2780	0.2704
EIRP(dBm)	28.32	28.23	28.32	28.77	28.86	28.25	28.69	28.44	28.32
EIRP(Watts)	0.6792	0.6653	0.6792	0.7534	0.7691	0.6683	0.7396	0.6982	0.6792

LTE Band 41 (G _T - L _C = 4.00 dB) 16QAM			
Bandwidth	20M		
Channel	39750	40620	41490
	(Low)	(Mid)	(High)
Frequency (MHz)	2506	2593	2680
Conducted Power (dBm)	24.56	24.62	24.52
Conducted Power (Watts)	0.2858	0.2897	0.2831
EIRP(dBm)	28.56	28.62	28.52
EIRP(Watts)	0.7178	0.7278	0.7112



LTE Band 71 (GT - LC = 3.00 dB) QPSK									
Bandwidth	5M			10M			15M		
Channel	133147	133297	133447	133172	133297	133422	133197	133297	133397
	(Low)	(Mid)	(High)	(Low)	(Mid)	(High)	(Low)	(Mid)	(High)
Frequency (MHz)	665.5	680.5	695.5	668	680.5	693	670.5	680.5	690.5
Conducted Power (dBm)	22.58	22.58	22.39	22.36	22.82	22.86	22.44	22.74	22.77
Conducted Power (Watts)	0.1811	0.1811	0.1734	0.1722	0.1914	0.1932	0.1754	0.1879	0.1892
ERP(dBm)	23.43	23.43	23.24	23.21	23.67	23.71	23.29	23.59	23.62
ERP(Watts)	0.2203	0.2203	0.2109	0.2094	0.2328	0.2350	0.2133	0.2286	0.2301

LTE Band 71 (GT - LC = 3.00 dB) QPSK			
Bandwidth	20M		
Channel	133222	133297	133372
	(Low)	(Mid)	(High)
Frequency (MHz)	673	680.5	688
Conducted Power (dBm)	22.87	22.63	22.63
Conducted Power (Watts)	0.1936	0.1832	0.1832
ERP(dBm)	23.72	23.48	23.48
ERP(Watts)	0.2355	0.2228	0.2228



LTE Band 71 (GT - LC = 3.00 dB) 16QAM									
Bandwidth	5M			10M			15M		
Channel	133147	133297	133447	133172	133297	133422	133197	133297	133397
	(Low)	(Mid)	(High)	(Low)	(Mid)	(High)	(Low)	(Mid)	(High)
Frequency	665.5	680.5	695.5	668	680.5	693	670.5	680.5	690.5
(MHz)									
Conducted Power (dBm)	21.52	21.63	21.85	21.86	21.65	21.54	21.56	21.58	21.96
Conducted Power (Watts)	0.1419	0.1455	0.1531	0.1535	0.1462	0.1426	0.1432	0.1439	0.1570
ERP(dBm)	22.37	22.48	22.70	22.71	22.50	22.39	22.41	22.43	22.81
ERP(Watts)	0.1726	0.1770	0.1862	0.1866	0.1778	0.1734	0.1742	0.1750	0.1910

LTE Band 71 (GT - LC = 3.00 dB) 16QAM			
Bandwidth	20M		
Channel	133222	133297	133372
	(Low)	(Mid)	(High)
Frequency	673	680.5	688
(MHz)			
Conducted Power (dBm)	21.32	21.36	21.97
Conducted Power (Watts)	0.1355	0.1368	0.1574
ERP(dBm)	22.17	22.21	22.82
ERP(Watts)	0.1648	0.1663	0.1914



CA EIRP

LTE Band 7 CA (GT - LC = 4.00 dB) QPSK									
Bandwidth	15M + 15M			10M + 20M			20M+10M		
Channel PCC	20825	21025	21225	20805	21006	21206	20850	21051	21251
	(Low)	(Mid)	(High)	(Low)	(Mid)	(High)	(Low)	(Mid)	(High)
Channel SCC	20975	21175	21375	20949	21150	21350	20994	21195	21395
	(Low)	(Mid)	(High)	(Low)	(Mid)	(High)	(Low)	(Mid)	(High)
Conducted Power (dBm)	22.36	22.1	22.31	22.35	22.19	22.35	22.31	22.18	22.39
Conducted Power (Watts)	0.1722	0.1622	0.1702	0.1718	0.1656	0.1718	0.1702	0.1652	0.1734
EIRP(dBm)	26.36	26.10	26.31	26.35	26.19	26.35	26.31	26.18	26.39
EIRP(Watts)	0.4325	0.4074	0.4276	0.4315	0.4159	0.4315	0.4276	0.4150	0.4355

LTE Band 7 CA (GT - LC = 4.00 dB) QPSK									
Bandwidth	15M+20M			20M+15M			20M + 20M		
Channel PCC	20828	21003	21179	20850	21026	21201	20850	21001	21152
	(Low)	(Mid)	(High)	(Low)	(Mid)	(High)	(Low)	(Mid)	(High)
Channel SCC	20999	21174	21350	21021	21197	21372	21048	21199	21350
	(Low)	(Mid)	(High)	(Low)	(Mid)	(High)	(Low)	(Mid)	(High)
Conducted Power (dBm)	22.82	22.19	22.36	22.36	22.38	22.13	23.91	23.79	23.95
Conducted Power (Watts)	0.1914	0.1656	0.1722	0.1722	0.1730	0.1633	0.2460	0.2393	0.2483
EIRP(dBm)	26.82	26.19	26.36	26.36	26.38	26.13	27.91	27.79	27.95
EIRP(Watts)	0.4808	0.4159	0.4325	0.4325	0.4345	0.4102	0.6180	0.6012	0.6237



LTE Band 7 CA (GT - LC = 4.00 dB) 16QAM									
Bandwidth	15M + 15M			10M + 20M			20M+10M		
Channel PCC	20825	21025	21225	20805	21006	21206	20850	21051	21251
	(Low)	(Mid)	(High)	(Low)	(Mid)	(High)	(Low)	(Mid)	(High)
Channel SCC	20975	21175	21375	20949	21150	21350	20994	21195	21395
	(Low)	(Mid)	(High)	(Low)	(Mid)	(High)	(Low)	(Mid)	(High)
Conducted Power (dBm)	22.01	21.49	21.39	21.28	21.49	21.54	21.74	21.42	22.28
Conducted Power (Watts)	0.1589	0.1409	0.1377	0.1343	0.1409	0.1426	0.1493	0.1387	0.1690
EIRP(dBm)	26.01	25.49	25.39	25.28	25.49	25.54	25.74	25.42	26.28
EIRP(Watts)	0.3990	0.3540	0.3459	0.3373	0.3540	0.3581	0.3750	0.3483	0.4246

LTE Band 7 CA (GT - LC = 4.00 dB) 16QAM									
Bandwidth	15M+20M			20M+15M			20M + 20M		
Channel PCC	20828	21003	21179	20850	21026	21201	20850	21001	21152
	(Low)	(Mid)	(High)	(Low)	(Mid)	(High)	(Low)	(Mid)	(High)
Channel SCC	20999	21174	21350	21021	21197	21372	21048	21199	21350
	(Low)	(Mid)	(High)	(Low)	(Mid)	(High)	(Low)	(Mid)	(High)
Conducted Power (dBm)	21.60	21.66	21.85	22.20	21.8	21.83	23.66	23.26	23.36
Conducted Power (Watts)	0.1445	0.1466	0.1531	0.1660	0.1514	0.1524	0.2323	0.2118	0.2168
EIRP(dBm)	25.60	25.66	25.85	26.20	25.80	25.83	27.66	27.26	27.36
EIRP(Watts)	0.3631	0.3681	0.3846	0.4169	0.3802	0.3828	0.5834	0.5321	0.5445



LTE Band 7 CA (GT - LC = 4.00 dB) QPSK			
Bandwidth	15M + 10M		
Channel PCC	20825	21025	21225
	(Low)	(Mid)	(High)
Channel SCC	20975	21175	21375
	(Low)	(Mid)	(High)
Conducted Power (dBm)	22.31	22.23	22.27
Conducted Power (Watts)	0.1702	0.1671	0.1687
EIRP(dBm)	26.31	26.23	26.27
EIRP(Watts)	0.4276	0.4198	0.4236

LTE Band 7 CA (GT - LC = 4.00 dB) 16QAM			
Bandwidth	15M + 10M		
Channel PCC	20825	21025	21225
	(Low)	(Mid)	(High)
Channel SCC	20975	21175	21375
	(Low)	(Mid)	(High)
Conducted Power (dBm)	21.40	21.94	21.69
Conducted Power (Watts)	0.1380	0.1563	0.1476
EIRP(dBm)	25.40	25.94	25.69
EIRP(Watts)	0.3467	0.3926	0.3707



LTE Band 41 CA (GT - LC = 4.00 dB) QPSK									
Bandwidth	15M + 15M			5M + 20M			20M + 5M		
Channel PCC	39725	40545	41365	39683	40528	41373	39750	40595	41440
	(Low)	(Mid)	(High)	(Low)	(Mid)	(High)	(Low)	(Mid)	(High)
Channel SCC	39875	40695	41515	39800	40645	41490	39867	40712	41557
	(Low)	(Mid)	(High)	(Low)	(Mid)	(High)	(Low)	(Mid)	(High)
Conducted Power (dBm)	23.46	23.26	22.97	22.13	22.64	22.58	22.68	23.22	22.72
Conducted Power (Watts)	0.2218	0.2118	0.1982	0.1633	0.1837	0.1811	0.1854	0.2099	0.1871
EIRP(dBm)	27.46	27.26	26.97	26.13	26.64	26.58	26.68	27.22	26.72
EIRP(Watts)	0.5572	0.5321	0.4977	0.4102	0.4613	0.4550	0.4656	0.5272	0.4699

LTE Band 41 CA (GT - LC = 4.00 dB) QPSK									
Bandwidth	10M + 20M			20M + 10M			15M + 20M		
Channel PCC	39705	40526	41346	39750	40571	41391	39728	40523	41319
	(Low)	(Mid)	(High)	(Low)	(Mid)	(High)	(Low)	(Mid)	(High)
Channel SCC	39849	40670	41490	39894	40715	41535	39899	40694	41490
	(Low)	(Mid)	(High)	(Low)	(Mid)	(High)	(Low)	(Mid)	(High)
Conducted Power (dBm)	23.55	23.12	23.06	23.26	23.32	22.95	22.41	23.33	23.01
Conducted Power (Watts)	0.2265	0.2051	0.2023	0.2118	0.2148	0.1972	0.1742	0.2153	0.2000
EIRP(dBm)	27.55	27.12	27.06	27.26	27.32	26.95	26.41	27.33	27.01
EIRP(Watts)	0.5689	0.5152	0.5082	0.5321	0.5395	0.4955	0.4375	0.5408	0.5023



LTE Band 41 CA (GT - LC = 4.00 dB) QPSK						
Bandwidth	20M+15M			20M+20M		
Channel PCC	39750	40546	41341	39750	40521	41292
	(Low)	(Mid)	(High)	(Low)	(Mid)	(High)
Channel SCC	39921	40717	41512	39948	40719	41490
	(Low)	(Mid)	(High)	(Low)	(Mid)	(High)
Conducted Power (dBm)	23.51	23.22	22.96	23.63	23.18	23.14
Conducted Power (Watts)	0.2244	0.2099	0.1977	0.2307	0.2080	0.2061
EIRP(dBm)	27.51	27.22	26.96	27.63	27.18	27.14
EIRP(Watts)	0.5636	0.5272	0.4966	0.5794	0.5224	0.5176

LTE Band 41 CA (GT - LC = 4.00 dB) QPSK						
Bandwidth	15M+10M			10M+15M		
Channel PCC	39725	40571	41417	39703	40549	41395
	(Low)	(Mid)	(High)	(Low)	(Mid)	(High)
Channel SCC	39845	40691	41537	39823	40669	41490
	(Low)	(Mid)	(High)	(Low)	(Mid)	(High)
Conducted Power (dBm)	23.59	23.09	22.88	23.45	23.25	23.02
Conducted Power (Watts)	0.2286	0.2037	0.1941	0.2213	0.2113	0.2004
EIRP(dBm)	27.59	27.09	26.88	27.45	27.25	27.02
EIRP(Watts)	0.5741	0.5117	0.4875	0.5559	0.5309	0.5035



LTE Band 41 CA (GT - LC = 4.00 dB) 16QAM									
Bandwidth	15M + 15M			5M + 20M			20M + 5M		
Channel PCC	39725	40545	41365	39683	40528	41373	39750	40595	41440
	(Low)	(Mid)	(High)	(Low)	(Mid)	(High)	(Low)	(Mid)	(High)
Channel SCC	39875	40695	41515	39800	40645	41490	39867	40712	41557
	(Low)	(Mid)	(High)	(Low)	(Mid)	(High)	(Low)	(Mid)	(High)
Conducted Power (dBm)	23.11	22.61	22.47	22.86	22.39	22.29	23.19	22.79	22.56
Conducted Power (Watts)	0.2046	0.1824	0.1766	0.1932	0.1734	0.1694	0.2084	0.1901	0.1803
EIRP(dBm)	27.11	26.61	26.47	26.86	26.39	26.29	27.19	26.79	26.56
EIRP(Watts)	0.5140	0.4581	0.4436	0.4853	0.4355	0.4256	0.5236	0.4775	0.4529

LTE Band 41 CA (GT - LC = 4.00 dB) 16QAM									
Bandwidth	10M + 20M			20M + 10M			15M + 20M		
Channel PCC	39705	40526	41346	39750	40571	41391	39728	40523	41319
	(Low)	(Mid)	(High)	(Low)	(Mid)	(High)	(Low)	(Mid)	(High)
Channel SCC	39849	40670	41490	39894	40715	41535	39899	40694	41490
	(Low)	(Mid)	(High)	(Low)	(Mid)	(High)	(Low)	(Mid)	(High)
Conducted Power (dBm)	23.38	22.67	22.68	23.26	22.61	22.24	23.39	22.81	22.55
Conducted Power (Watts)	0.2178	0.1849	0.1854	0.2118	0.1824	0.1675	0.2183	0.1910	0.1799
EIRP(dBm)	27.38	26.67	26.68	27.26	26.61	26.24	27.39	26.81	26.55
EIRP(Watts)	0.5470	0.4645	0.4656	0.5321	0.4581	0.4207	0.5483	0.4797	0.4519



LTE Band 41 CA (GT - LC = 4.00 dB) 16QAM						
Bandwidth	20M+15M			20M+20M		
Channel PCC	39750	40546	41341	39750	40521	41292
	(Low)	(Mid)	(High)	(Low)	(Mid)	(High)
Channel SCC	39921	40717	41512	39948	40719	41490
	(Low)	(Mid)	(High)	(Low)	(Mid)	(High)
Conducted Power (dBm)	23.09	22.91	22.82	23.11	22.81	22.47
Conducted Power (Watts)	0.2037	0.1954	0.1914	0.2046	0.1910	0.1766
EIRP(dBm)	27.09	26.91	26.82	27.11	26.81	26.47
EIRP(Watts)	0.5117	0.4909	0.4808	0.5140	0.4797	0.4436

LTE Band 41 CA (GT - LC = 4.00 dB) 16QAM						
Bandwidth	15M+10M			10M+15M		
Channel PCC	39725	40571	41417	39703	40549	41395
	(Low)	(Mid)	(High)	(Low)	(Mid)	(High)
Channel SCC	39845	40691	41537	39823	40669	41490
	(Low)	(Mid)	(High)	(Low)	(Mid)	(High)
Conducted Power (dBm)	23.08	22.64	21.83	23.13	22.44	22.59
Conducted Power (Watts)	0.2032	0.1837	0.1524	0.2056	0.1754	0.1816
EIRP(dBm)	27.08	26.64	25.83	27.13	26.44	26.59
EIRP(Watts)	0.5105	0.4613	0.3828	0.5164	0.4406	0.4560



LTE Band 7

Peak-to-Average Ratio

Mode	LTE Band 7 / 20MHz		
Mod.	QPSK	16QAM	Limit: 13dB
RB Size	Full RB	Full RB	Result
Middle CH	4.67	5.48	PASS

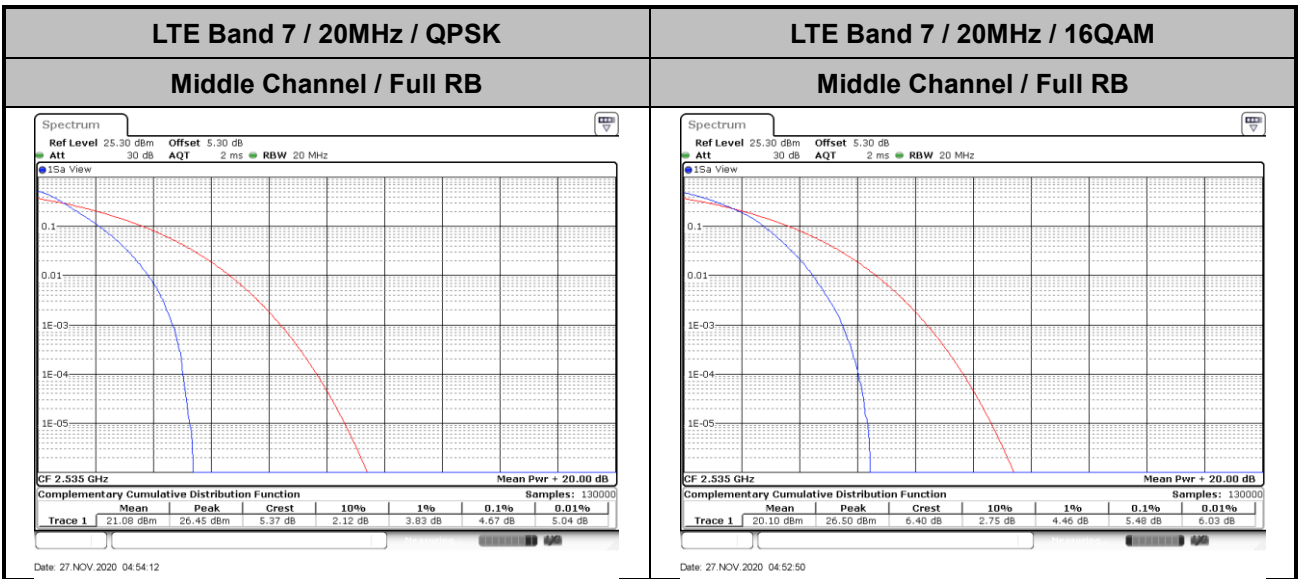



26dB Bandwidth

Mode	LTE Band 7 : 26dB BW(MHz)	
BW	20MHz	
Mod.	QPSK	16QAM
Middle CH	20.74	20.34

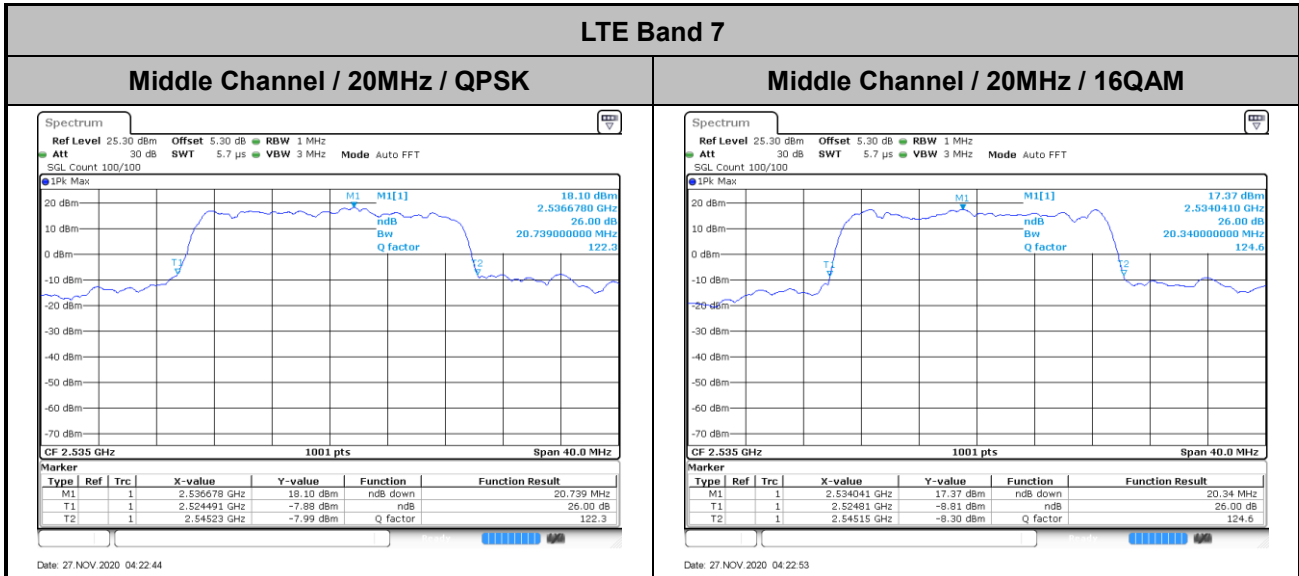



Occupied Bandwidth

Mode	LTE Band 7 : 99%OBW(MHz)	
BW	20MHz	
Mod.	QPSK	16QAM
Middle CH	18.42	18.50

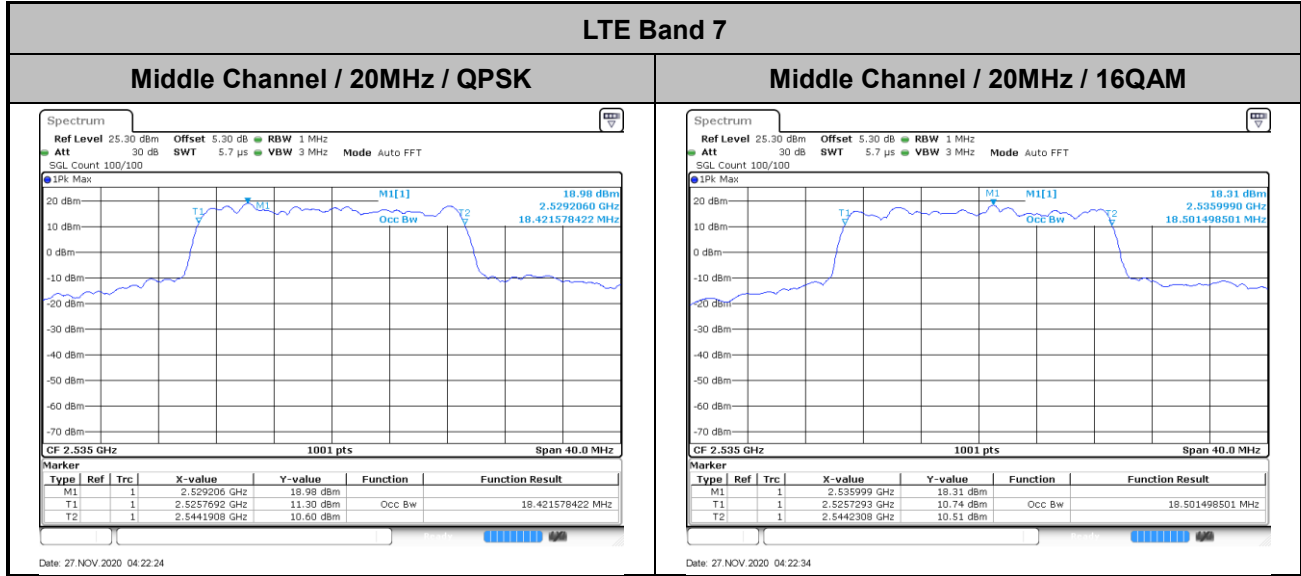



Conducted Band Edge

LTE Band 7 / 5MHz / QPSK

Lowest Band Edge / 1 RB

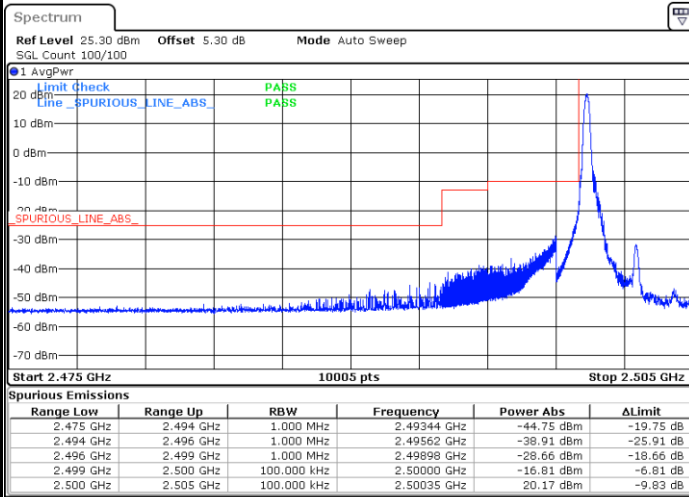

Highest Band Edge / 1 RB

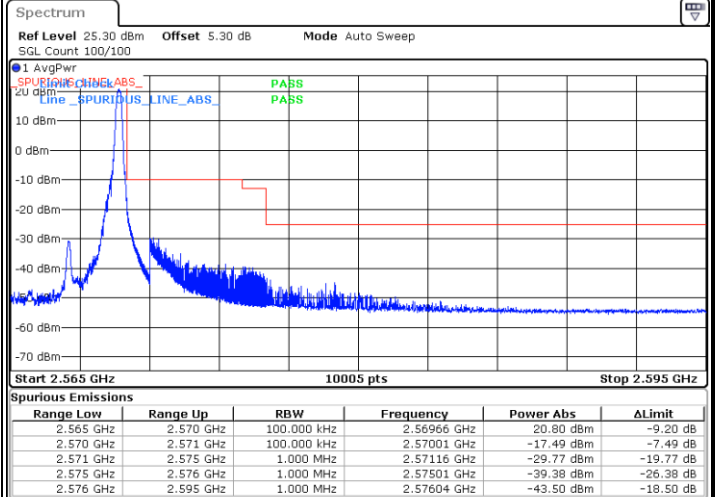

Lowest Band Edge / Full RB

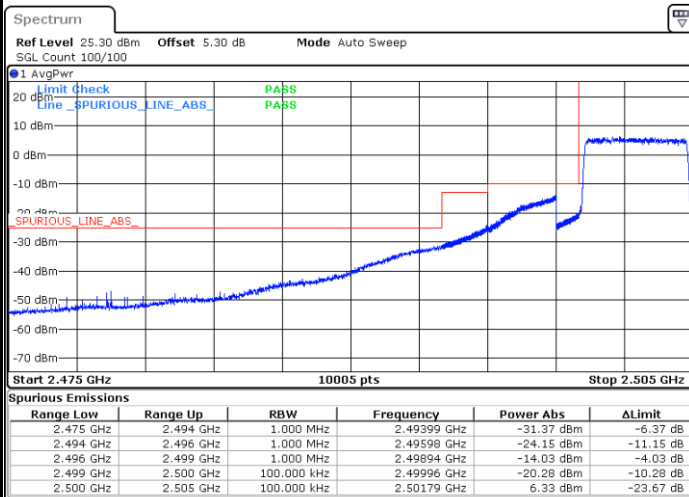

Highest Band Edge / Full RB

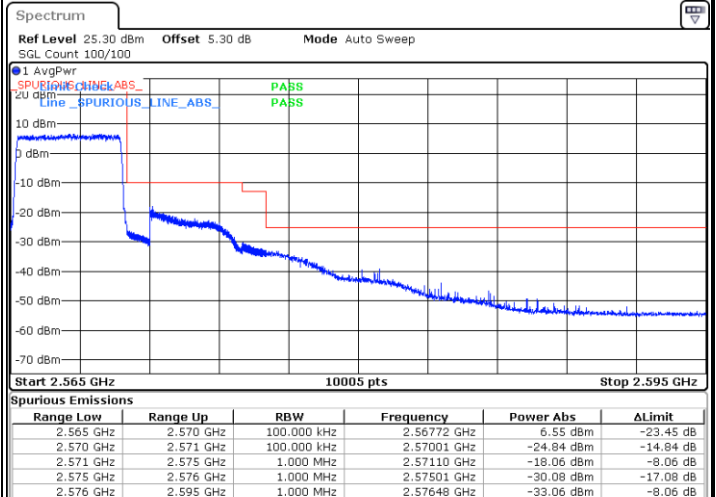



LTE Band 7 / 5MHz / 16QAM

Lowest Band Edge / 1 RB

Highest Band Edge / 1 RB

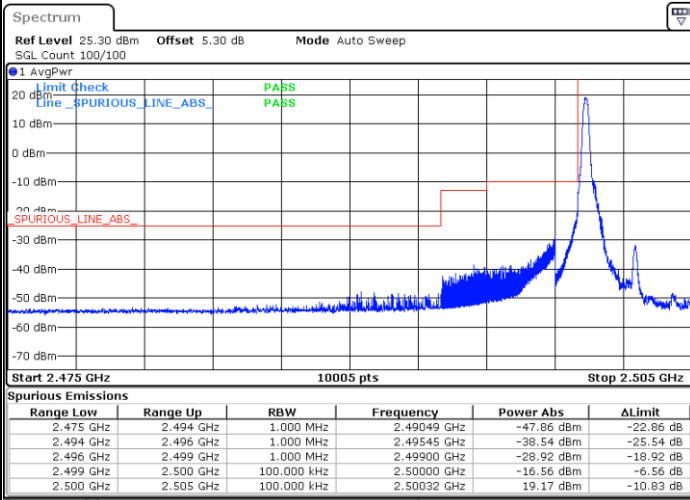

Date: 27.NOV.2020 03:01:27

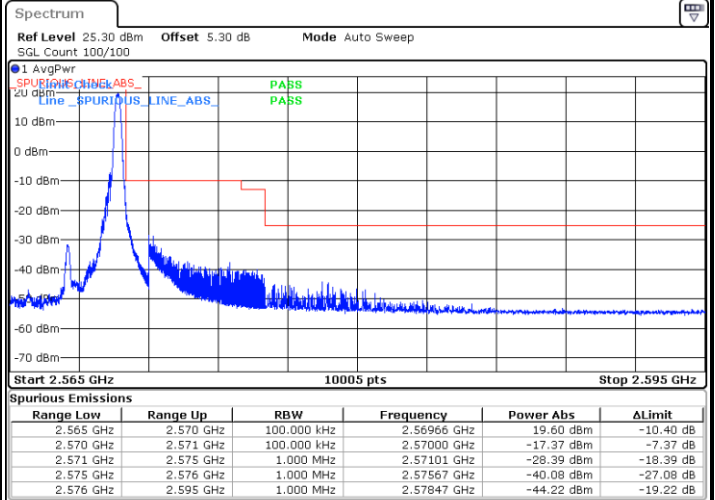

Date: 27.NOV.2020 03:10:55

Lowest Band Edge / Full RB

Highest Band Edge / Full RB

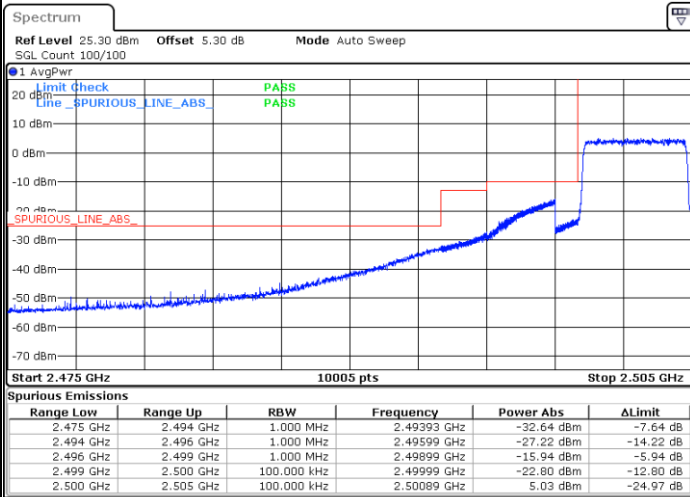

Date: 27.NOV.2020 03:03:44

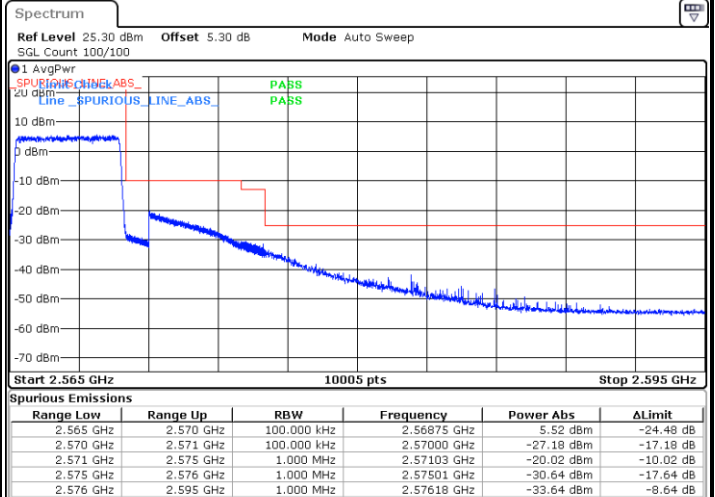

Date: 27.NOV.2020 03:13:11