

# FCC SAR Test Report

APPLICANT : Wistron Corporation  
EQUIPMENT : Tablet PC  
BRAND NAME : Lenovo  
MODEL NAME : TP00082AUC  
FCC ID : PU5-TP00082AUC  
STANDARD : FCC 47 CFR Part 2 (2.1093)  
ANSI/IEEE C95.1-1992  
IEEE 1528-2013

Equipment: AriPrime EM7455 and Intel 8260D2W tested inside of Lenovo Tablet PC.

We, SPORTON INTERNATIONAL INC., would like to declare that the tested sample has been evaluated in accordance with the procedures and had been in compliance with the applicable technical standards.

The test results in this report apply exclusively to the tested model / sample. Without written approval of SPORTON INTERNATIONAL INC., the test report shall not be reproduced except in full.

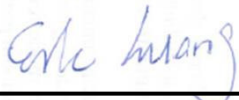

Reviewed by: Eric Huang / Deputy Manager



Approved by: Jones Tsai / Manager



## SPORTON INTERNATIONAL INC.

No.52, Hwa Ya 1st Rd., Hwa Ya Technology Park, Kwei-Shan District, Taoyuan City, Taiwan (R.O.C.)



Table of Contents

1. Statement of Compliance ..... 4
2. Administration Data ..... 5
3. Guidance Standard ..... 5
4. Equipment Under Test (EUT) Information ..... 6
4.1 General Information ..... 6
4.2 General LTE SAR Test and Reporting Considerations ..... 8
5. Proximity Sensor Triggering Test ..... 12
6. RF Exposure Limits ..... 17
6.1 Uncontrolled Environment ..... 17
6.2 Controlled Environment ..... 17
7. Specific Absorption Rate (SAR) ..... 18
7.1 Introduction ..... 18
7.2 SAR Definition ..... 18
8. System Description and Setup ..... 19
8.1 E-Field Probe ..... 20
8.2 Data Acquisition Electronics (DAE) ..... 20
8.3 Phantom ..... 21
8.4 Device Holder ..... 22
9. Measurement Procedures ..... 23
9.1 Spatial Peak SAR Evaluation ..... 23
9.2 Power Reference Measurement ..... 24
9.3 Area Scan ..... 24
9.4 Zoom Scan ..... 25
9.5 Volume Scan Procedures ..... 26
9.6 Power Drift Monitoring ..... 26
10. Test Equipment List ..... 27
11. System Verification ..... 28
11.1 Tissue Verification ..... 28
11.2 System Performance Check Results ..... 29
12. RF Exposure Positions ..... 29
12.1 SAR Testing for Tablet ..... 29
13. Conducted RF Output Power (Unit: dBm) ..... 30
14. Test Exclusion Applied ..... 72
15. SAR Test Results ..... 73
15.1 Body SAR ..... 74
15.2 Repeated SAR Measurement ..... 79
16. Simultaneous Transmission Analysis ..... 80
16.1 Body Exposure Conditions ..... 81
16.2 SPLSR Evaluation and Analysis ..... 91
17. Uncertainty Assessment ..... 122
18. References ..... 125
Appendix A. Plots of System Performance Check
Appendix B. Plots of High SAR Measurement
Appendix C. DASYS Calibration Certificate
Appendix D. Antenna Location & Test Setup Photos



### Revision History

REPORT NO.	VERSION	DESCRIPTION	ISSUED DATE
FA5N2711-01	Rev. 01	Initial issue of report	Jan. 25, 2016



**1. Statement of Compliance**

The maximum results of Specific Absorption Rate (SAR) found during testing for Wistron Corporation, Tablet PC, TP00082AUC, are as follows.

Equipment Class	Frequency Band		Highest SAR Summary	Highest Simultaneous Transmission 1g SAR (W/kg)
			Body 1g SAR (W/kg)	
Licensed	WCDMA	WCDMA II	1.02	1.59
		WCDMA IV	1.30	
		WCDMA V	1.14	
	LTE	LTE Band 2		
		LTE Band 4	1.29	
		LTE Band 5		
		LTE Band 7	1.26	
		LTE Band 12	1.02	
		LTE Band 13	1.23	
		LTE Band 25	1.11	
		LTE Band 26	1.03	
		LTE Band 41	1.27	
Date of Testing:			2015/12/24 ~ 2016/01/01	

This device is in compliance with Specific Absorption Rate (SAR) for general population/uncontrolled exposure limits (1.6 W/kg) specified in FCC 47 CFR part 2 (2.1093) and ANSI/IEEE C95.1-1992, and had been tested in accordance with the measurement methods and procedures specified in IEEE 1528-2013 and FCC KDB publications

**2. Administration Data**

Testing Laboratory	
Test Site	SPORTON INTERNATIONAL INC.
Test Site Location	No.52, Hwa Ya 1st Rd., Hwa Ya Technology Park, Kwei-Shan District, Taoyuan City, Taiwan (R.O.C.) TEL: +886-3-327-3456 FAX: +886-3-328-4978

Applicant	
Company Name	Wistron Corporation
Address	21F, No. 88, Sec. 1, Hsin Tai Wu Rd., Hsichih Dist, New Taipei City 221, Taiwan R.O.C.

Manufacturer	
Company Name	Wistron Corporation
Address	21F, No. 88, Sec. 1, Hsin Tai Wu Rd., Hsichih Dist, New Taipei City 221, Taiwan R.O.C.

**3. Guidance Standard**

The Specific Absorption Rate (SAR) testing specification, method, and procedure for this device is in accordance with the following standards:

- FCC 47 CFR Part 2 (2.1093)
- ANSI/IEEE C95.1-1992
- IEEE 1528-2013
- FCC KDB 865664 D01 SAR Measurement 100 MHz to 6 GHz v01r04
- FCC KDB 865664 D02 SAR Reporting v01r02
- FCC KDB 447498 D01 General RF Exposure Guidance v06
- FCC KDB 616217 D04 SAR for laptop and tablets v01r02
- FCC KDB 941225 D01 3G SAR Procedures v03r01
- FCC KDB 941225 D05 SAR for LTE Devices v02r05
- FCC KDB 941225 D05A Rel.10 LTE SAR Test Guidance v01r02



**4. Equipment Under Test (EUT) Information**

**4.1 General Information**

Product Feature & Specification	
Equipment Name	Tablet PC
Brand Name	Lenovo
Model Name	TP00082AUC
FCC ID	PU5-TP00082AUC
Integrated WWAN Module	Brand name : AriPrime Model name : EM7455
Integrated WLAN Module	Brand name : Intel Model name : 8260D2W
Integrated NFC Module	Brand name : Foxconn Model name : T77H519
IMEI Code	359073060059874
Wireless Technology and Frequency Range	WCDMA Band II: 1852.4 MHz ~ 1907.6 MHz WCDMA Band IV: 1712.4 MHz ~ 1752.6 MHz WCDMA Band V: 826.4 MHz ~ 846.6 MHz LTE Band 2: 1850.7 MHz ~ 1909.3 MHz LTE Band 4: 1710.7 MHz ~ 1754.3 MHz LTE Band 5: 824.7 MHz ~ 848.3 MHz LTE Band 7: 2502.5 MHz ~ 2567.5 MHz LTE Band 12: 699.7 MHz ~ 715.3 MHz LTE Band 13: 779.5 MHz ~ 784.5 MHz LTE Band 25: 1850.7 MHz ~ 1914.3 MHz LTE Band 26: 814.7 MHz ~ 848.3 MHz LTE Band 41: 2498.5 MHz ~ 2687.5 MHz WLAN 2.4GHz Band: 2412 MHz ~ 2472 MHz WLAN 5.2GHz Band: 5180 MHz ~ 5240 MHz WLAN 5.3GHz Band: 5260 MHz ~ 5320 MHz WLAN 5.5GHz Band: 5500 MHz ~ 5720MHz WLAN 5.8GHz Band: 5745 MHz ~ 5825 MHz Bluetooth: 2402 MHz ~ 2480 MHz NFC : 13.56 MHz
Mode	· RMC 12.2Kbps · HSDPA · HSUPA · DC-HSDPA · LTE: QPSK, 16QAM · 802.11a/b/g/n/ac HT20/HT40/VHT20/VHT40/VHT80 · Bluetooth v3.0+EDR , Bluetooth v4.1-LE · NFC:ASK
EUT Stage	Production Unit
<b>Remark:</b>	
1. The Intel 8260D2W WLAN / Bluetooth module is also integrated into this host, WLAN /Bluetooth power and WLAN SAR testing results which can be referred to Sporton FCC SAR Test Report, FCC ID : PU5-TP00082A, Report No.: FA5N2711-05.	



WWAN Antenna Information		
Manufacturer	PULSE	
Parts Number	025.900FA.0001	
Ant. Type	Monopole	
Peak Gain (dBi)	UE-UTRA, Band 12	-0.90
	UE-UTRA, Band 13	-0.37
	UMTS 850, Band 5 UE-UTRA, Band 5	-0.56
	UE-UTRA, Band 26	-0.53
	UMTS, Band 4 UE-UTRA, Band 4	3.11
	UMTS1900, Band 2 UE-UTRA, Band 2	3.01
	UE-UTRA, Band 25	3.22
	UE-UTRA, Band 7	-0.08
	UE-UTRA, Band 41	-0.41

WLAN Antenna Information		
Manufacturer	PULSE	
Antenna Type	Main: dipole Antenna	Aux: dipole Antenna
Part number	025.900FC.0001	025.900FD.0001
Peak gain(dBi)	Main Antenna :	Aux Antenna :
	WLAN(2.4G):-0.82	WLAN(2.4G):1.39 BT :1.39
	WLAN(5G):2.31	WLAN(5G):3.13



4.2 General LTE SAR Test and Reporting Considerations

Summarized necessary items addressed in KDB 941225 D05 v02r05																																																										
FCC ID	PU5-TP00082AUC																																																									
Equipment Name	Tablet PC																																																									
Operating Frequency Range of each LTE transmission band	LTE Band 02: 1850.7 MHz ~ 1909.3 MHz LTE Band 04: 1710.7 MHz ~ 1754.3 MHz LTE Band 05: 824.7 MHz ~ 848.3 MHz LTE Band 07: 2502.5 MHz ~ 2567.5 MHz LTE Band 12: 699.7 MHz ~ 715.3 MHz LTE Band 13: 779.5 MHz ~ 784.5 MHz LTE Band 25: 1850.7 MHz ~ 1914.3 MHz LTE Band 26: 814.7 MHz ~ 848.3 MHz LTE Band 41: 2498.5 MHz ~ 2687.5 MHz																																																									
Channel Bandwidth	LTE Band 02: 1.4MHz, 3MHz, 5MHz, 10MHz, 15MHz, 20MHz LTE Band 04: 1.4MHz, 3MHz, 5MHz, 10MHz, 15MHz, 20MHz LTE Band 05: 1.4MHz, 3MHz, 5MHz, 10MHz LTE Band 07: 5MHz, 10MHz, 15MHz, 20MHz LTE Band 12: 1.4MHz, 3MHz, 5MHz, 10MHz LTE Band 13: 5MHz, 10MHz LTE Band 25: 1.4MHz, 3MHz, 5MHz, 10MHz, 15MHz, 20MHz LTE Band 26: 1.4MHz, 3MHz, 5MHz, 10MHz, 15MHz LTE Band 41: 5MHz, 10MHz, 15MHz, 20MHz																																																									
uplink modulations used	QPSK, and 16QAM																																																									
LTE Voice / Data requirements	Data only																																																									
LTE MPR permanently built-in by design	<table border="1"> <thead> <tr> <th colspan="8">Table 6.2.3-1: Maximum Power Reduction (MPR) for Power Class 3</th> </tr> <tr> <th rowspan="2">Modulation</th> <th colspan="6">Channel bandwidth / Transmission bandwidth (RB)</th> <th rowspan="2">MPR (dB)</th> </tr> <tr> <th>1.4 MHz</th> <th>3.0 MHz</th> <th>5 MHz</th> <th>10 MHz</th> <th>15 MHz</th> <th>20 MHz</th> </tr> </thead> <tbody> <tr> <td>QPSK</td> <td>&gt; 5</td> <td>&gt; 4</td> <td>&gt; 8</td> <td>&gt; 12</td> <td>&gt; 16</td> <td>&gt; 18</td> <td>≤ 1</td> </tr> <tr> <td>16 QAM</td> <td>≤ 5</td> <td>≤ 4</td> <td>≤ 8</td> <td>≤ 12</td> <td>≤ 16</td> <td>≤ 18</td> <td>≤ 1</td> </tr> <tr> <td>16 QAM</td> <td>&gt; 5</td> <td>&gt; 4</td> <td>&gt; 8</td> <td>&gt; 12</td> <td>&gt; 16</td> <td>&gt; 18</td> <td>≤ 2</td> </tr> </tbody> </table>												Table 6.2.3-1: Maximum Power Reduction (MPR) for Power Class 3								Modulation	Channel bandwidth / Transmission bandwidth (RB)						MPR (dB)	1.4 MHz	3.0 MHz	5 MHz	10 MHz	15 MHz	20 MHz	QPSK	> 5	> 4	> 8	> 12	> 16	> 18	≤ 1	16 QAM	≤ 5	≤ 4	≤ 8	≤ 12	≤ 16	≤ 18	≤ 1	16 QAM	> 5	> 4	> 8	> 12	> 16	> 18	≤ 2
Table 6.2.3-1: Maximum Power Reduction (MPR) for Power Class 3																																																										
Modulation	Channel bandwidth / Transmission bandwidth (RB)						MPR (dB)																																																			
	1.4 MHz	3.0 MHz	5 MHz	10 MHz	15 MHz	20 MHz																																																				
QPSK	> 5	> 4	> 8	> 12	> 16	> 18	≤ 1																																																			
16 QAM	≤ 5	≤ 4	≤ 8	≤ 12	≤ 16	≤ 18	≤ 1																																																			
16 QAM	> 5	> 4	> 8	> 12	> 16	> 18	≤ 2																																																			
LTE A-MPR	In the base station simulator configuration, Network Setting value is set to NS_01 to disable A-MPR during SAR testing and the LTE SAR tests was transmitting on all TTI frames (Maximum TTI)																																																									
Spectrum plots for RB configuration	A properly configured base station simulator was used for the SAR and power measurement; therefore, spectrum plots for each RB allocation and offset configuration are not included in the SAR report.																																																									
Power reduction applied to satisfy SAR compliance	Yes, Proximity Sensor.																																																									
LTE Carrier Aggregation Combinations	Inter-Band and Intra-Band possible combinations as below page and the detail power verification please referred to page 71.																																																									
LTE Carrier Aggregation Additional Information	This device does not support full CA features on 3GPP Release 10. It supports a maximum of 2 carriers in the downlink only. All uplink communications are identical to the Release 8 Specifications. Uplink communications are done on the PCC. Due to carrier capability, only the combinations listed above are supported. The following LTE Release features are not supported: Relay, HetNet, Enhanced MIMO, eICI, WiFi Offloading, MDH, eMBMA, Cross-Carrier Scheduling, Enhanced SC-FDMA.																																																									
Transmission (H, M, L) channel numbers and frequencies in each LTE band																																																										
LTE Band 2																																																										
	Bandwidth 1.4 MHz		Bandwidth 3 MHz		Bandwidth 5 MHz		Bandwidth 10 MHz		Bandwidth 15 MHz		Bandwidth 20 MHz																																															
	Ch. #	Freq. (MHz)	Ch. #	Freq. (MHz)	Ch. #	Freq. (MHz)	Ch. #	Freq. (MHz)	Ch. #	Freq. (MHz)	Ch. #	Freq. (MHz)																																														
L	18607	1850.7	18615	1851.5	18625	1852.5	18650	1855	18675	1857.5	18700	1860																																														
M	18900	1880	18900	1880	18900	1880	18900	1880	18900	1880	18900	1880																																														
H	19193	1909.3	19185	1908.5	19175	1907.5	19150	1905	19125	1902.5	19100	1900																																														





LTE Band 4																
	Bandwidth 1.4 MHz		Bandwidth 3 MHz		Bandwidth 5 MHz		Bandwidth 10 MHz		Bandwidth 15 MHz		Bandwidth 20 MHz					
	Ch. #	Freq. (MHz)	Ch. #	Freq. (MHz)	Ch. #	Freq. (MHz)	Ch. #	Freq. (MHz)	Ch. #	Freq. (MHz)	Ch. #	Freq. (MHz)				
L	19957	1710.7	19965	1711.5	19975	1712.5	20000	1715	20025	1717.5	20050	1720				
M	20175	1732.5	20175	1732.5	20175	1732.5	20175	1732.5	20175	1732.5	20175	1732.5				
H	20393	1754.3	20385	1753.5	20375	1752.5	20350	1750	20325	1747.5	20300	1745				
LTE Band 5																
	Bandwidth 1.4 MHz		Bandwidth 3 MHz		Bandwidth 5 MHz		Bandwidth 10 MHz		Bandwidth 15 MHz		Bandwidth 20 MHz					
	Ch. #	Freq. (MHz)	Ch. #	Freq. (MHz)	Ch. #	Freq. (MHz)	Ch. #	Freq. (MHz)	Ch. #	Freq. (MHz)	Ch. #	Freq. (MHz)				
L	20407	824.7	20415	825.5	20425	826.5	20450	829	20450	829	20450	829				
M	20525	836.5	20525	836.5	20525	836.5	20525	836.5	20525	836.5	20525	836.5				
H	20643	848.3	20635	847.5	20625	846.5	20600	844	20600	844	20600	844				
LTE Band 7																
	Bandwidth 5 MHz		Bandwidth 10 MHz		Bandwidth 15 MHz		Bandwidth 20 MHz		Bandwidth 15 MHz		Bandwidth 20 MHz					
	Ch. #	Freq. (MHz)	Ch. #	Freq. (MHz)	Ch. #	Freq. (MHz)	Ch. #	Freq. (MHz)	Ch. #	Freq. (MHz)	Ch. #	Freq. (MHz)				
L	20775	2502.5	20800	2505	20825	2507.5	20850	2510	20850	2510	20850	2510				
M	21100	2535	21100	2535	21100	2535	21100	2535	21100	2535	21100	2535				
H	21425	2567.5	21400	2565	21375	2562.5	21350	2560	21350	2560	21350	2560				
LTE Band 12																
	Bandwidth 1.4 MHz		Bandwidth 3 MHz		Bandwidth 5 MHz		Bandwidth 10 MHz		Bandwidth 15 MHz		Bandwidth 20 MHz					
	Ch. #	Freq. (MHz)	Ch. #	Freq. (MHz)	Ch. #	Freq. (MHz)	Ch. #	Freq. (MHz)	Ch. #	Freq. (MHz)	Ch. #	Freq. (MHz)				
L	23017	699.7	23025	700.5	23035	701.5	23060	704	23060	704	23060	704				
M	23095	707.5	23095	707.5	23095	707.5	23095	707.5	23095	707.5	23095	707.5				
H	23173	715.3	23165	714.5	23155	713.5	23130	711	23130	711	23130	711				
LTE Band 13																
	Bandwidth 5 MHz				Bandwidth 10 MHz				Bandwidth 15 MHz				Bandwidth 20 MHz			
	Channel #		Freq.(MHz)		Channel #		Freq.(MHz)		Channel #		Freq.(MHz)		Channel #		Freq.(MHz)	
L	23205		779.5		23230		782		23230		782		23230		782	
M	23230		782		23230		782		23230		782		23230		782	
H	23255		784.5		23230		782		23230		782		23230		782	
LTE Band 25																
	Bandwidth 1.4 MHz		Bandwidth 3 MHz		Bandwidth 5 MHz		Bandwidth 10 MHz		Bandwidth 15 MHz		Bandwidth 20 MHz					
	Ch. #	Freq. (MHz)	Ch. #	Freq. (MHz)	Ch. #	Freq. (MHz)	Ch. #	Freq. (MHz)	Ch. #	Freq. (MHz)	Ch. #	Freq. (MHz)				
L	26047	1850.7	26055	1851.5	26065	1852.5	26090	1855	26115	1857.5	26140	1860				
M	26340	1880	26340	1880	26340	1880	26340	1880	26340	1880	26340	1880				
H	26683	1914.3	26675	1913.5	26665	1912.5	26640	1910	26615	1907.5	26590	1905				
LTE Band 26																
	Bandwidth 1.4 MHz		Bandwidth 3 MHz		Bandwidth 5 MHz		Bandwidth 10 MHz		Bandwidth 15 MHz		Bandwidth 20 MHz					
	Ch. #	Freq. (MHz)	Ch. #	Freq. (MHz)	Ch. #	Freq. (MHz)	Ch. #	Freq. (MHz)	Ch. #	Freq. (MHz)	Ch. #	Freq. (MHz)				
L	26697	814.7	26705	815.5	26715	816.5	26740	819	26765	821.5	26765	821.5				
M	26865	831.5	26865	831.5	26865	831.5	26865	831.5	26865	831.5	26865	831.5				
H	27033	848.3	27025	847.5	27015	846.5	26990	844	26965	841.5	26965	841.5				
LTE Band 41																
	Bandwidth 5 MHz		Bandwidth 10 MHz		Bandwidth 15 MHz		Bandwidth 20 MHz		Bandwidth 15 MHz		Bandwidth 20 MHz					
	Ch. #	Freq. (MHz)	Ch. #	Freq. (MHz)	Ch. #	Freq. (MHz)	Ch. #	Freq. (MHz)	Ch. #	Freq. (MHz)	Ch. #	Freq. (MHz)				
L	39675	2498.5	39700	2501	39725	2503.5	39750	2506	39750	2506	39750	2506				
L	40148	2545.8	40160	2547	40173	2548.3	40185	2549.5	40185	2549.5	40185	2549.5				
M	40620	2593	40620	2590	40620	2593	40620	2593	40620	2593	40620	2593				
H	41093	2640.3	41080	2639	41068	2637.8	41055	2636.5	41055	2636.5	41055	2636.5				
H	41565	2687.5	41540	2685	41515	2682.5	41490	2680	41490	2680	41490	2680				



Inter-Band Combination																				
PCC		SCC		PCC		SCC		PCC		SCC		PCC		SCC		PCC		SCC		
LTE B2	+	LTE B5	LTE B5	+	LTE B2	LTE B2	+	LTE 12	LTE B12	+	LTE B2	LTE B2	+	LTE B13	LTE B13	+	LTE B2	LTE B2	+	LTE B29
BW (MHz)	+	BW (MHz)	BW (MHz)	+	BW (MHz)	BW (MHz)	+	BW (MHz)	BW (MHz)	+	BW (MHz)	BW (MHz)	+	BW (MHz)	BW (MHz)	+	BW (MHz)	BW (MHz)	+	BW (MHz)
20	+	10	10	+	20	20	+	10	10	+	20	20	+	10	10	+	20	20	+	10
20	+	5	10	+	15	20	+	5	10	+	15	20	+	5	10	+	15	20	+	5
15	+	10	10	+	10	20	+	3	10	+	10	15	+	10	10	+	10	20	+	3
15	+	5	10	+	5	15	+	10	10	+	5	15	+	5	10	+	5	15	+	10
10	+	10	5	+	20	15	+	5	5	+	20	10	+	10	5	+	20	15	+	5
10	+	5	5	+	15	15	+	3	5	+	15	10	+	5	5	+	15	15	+	3
5	+	10	5	+	10	10	+	10	5	+	10	5	+	10	5	+	10	10	+	10
5	+	5	5	+	5	10	+	5	5	+	5	5	+	5	5	+	5	10	+	5
						10	+	3	3	+	20							10	+	3
						5	+	10	3	+	15							5	+	10
						5	+	5	3	+	10							5	+	5
						5	+	3	3	+	5							5	+	3

Inter-Band Combination																				
PCC		SCC		PCC		SCC		PCC		SCC		PCC		SCC		PCC		SCC		
LTE B4	+	LTE B5	LTE B5	+	LTE B4	LTE B4	+	LTE B12	LTE B12	+	LTE B4	LTE B4	+	LTE B13	LTE B13	+	LTE B4	LTE B4	+	LTE B29
BW (MHz)	+	BW (MHz)	BW (MHz)	+	BW (MHz)	BW (MHz)	+	BW (MHz)	BW (MHz)	+	BW (MHz)	BW (MHz)	+	BW (MHz)	BW (MHz)	+	BW (MHz)	BW (MHz)	+	BW (MHz)
20	+	10	10	+	20	20	+	10	10	+	20	20	+	10	10	+	20	20	+	10
20	+	5	10	+	15	20	+	5	10	+	15	15	+	10	10	+	15	20	+	5
15	+	10	10	+	10	20	+	3	10	+	10	10	+	10	10	+	10	20	+	3
15	+	5	10	+	5	15	+	10	10	+	5	5	+	10	10	+	5	15	+	10
10	+	10	5	+	20	15	+	5	10	+	3							15	+	5
10	+	5	5	+	15	15	+	3	10	+	1.4							15	+	3
5	+	10	5	+	10	10	+	10	5	+	20							10	+	10
5	+	5	5	+	5	10	+	5	5	+	15							10	+	5
						10	+	3	5	+	10							10	+	3
						5	+	10	5	+	5							5	+	10
						5	+	5	5	+	3							5	+	5
						5	+	3	5	+	1.4							5	+	1.4
						3	+	10	3	+	20							3	+	20
						3	+	5	3	+	15							3	+	15
						3	+	3	3	+	10							3	+	10
						1.4	+	10	3	+	5							1.4	+	5
						1.4	+	5	3	+	3							1.4	+	3
						1.4	+	3	3	+	1.4							1.4	+	1.4



Intra-Band Combination																							
Contiguous									Non-Contiguous														
PCC			SCC			PCC			SCC			PCC			SCC			PCC			SCC		
LTE B2	+	LTE B2	LTE B7	+	LTE B7	LTE B41	+	LTE 41	LTE B2	+	LTE B2	LTE B7	+	LTE B7	LTE B41	+	LTE 41						
BW (MHz)	+	BW (MHz)	BW (MHz)	+	BW (MHz)	BW (MHz)	+	BW (MHz)	BW (MHz)	+	BW (MHz)	BW (MHz)	+	BW (MHz)	BW (MHz)	+	BW (MHz)						
20	+	20	20	+	20	20	+	20	20	+	20	20	+	20	20	+	20						
20	+	15	20	+	15	20	+	15	20	+	15	15	+	20	20	+	15						
20	+	10	20	+	10	20	+	10	20	+	10	15	+	15	20	+	10						
20	+	5	15	+	20	20	+	5	20	+	5	10	+	15	15	+	20						
15	+	20	15	+	15	15	+	20	15	+	20	10	+	10	15	+	15						
15	+	15	10	+	20	15	+	15	15	+	15	5	+	15	15	+	10						
15	+	10				10	+	20	15	+	10	20	+	15	10	+	20						
10	+	20				5	+	20	15	+	5	15	+	10	10	+	15						
10	+	15							10	+	20	15	+	5	10	+	10						
5	+	20							10	+	15												
									10	+	10												
									10	+	5												
									5	+	20												
									5	+	15												
									5	+	10												
									5	+	5												

## 5. Proximity Sensor Triggering Test

### <Proximity Sensor Triggering Distance (KDB 616217 D04 section 6.2)>:

Proximity sensor triggering distance testing was performed according to the procedures outlined in KDB 616217 D04 section 6.2, and EUT moving further away from the flat phantom and EUT moving toward the flat phantom were both assessed. The details are illustrated in the exhibit “P-Sensor operational description”, and the shortest triggering distances were reported and used for SAR assessment.

In the preliminary triggering distance testing, the tissue-equivalent medium for different frequency bands were used for verification; no other frequency bands tissue-equivalent medium was found to result in shortest triggering distance than that for 1900MHz, and the tissue-equivalent medium for 1900MHz was used for formal proximity sensor triggering testing.

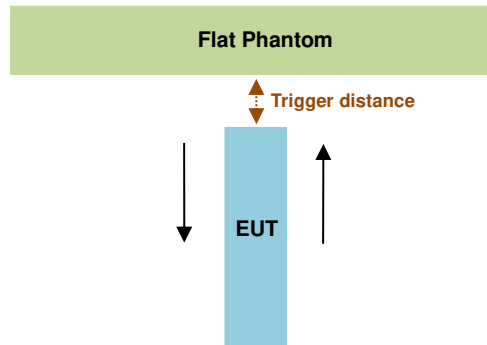

Proximity Sensor Trigger Distance (mm)			
Position	Bottom Face	Edge 1	Edge 2
Minimum	12	10	16

### <Proximity Sensor Triggering Coverage (KDB 616217 D04 section 6.3)>:

If a sensor is spatially offset from the antenna(s), it is necessary to verify sensor triggering for conditions where the antenna is next to the user but the sensor is laterally further away to ensure sensor coverage is sufficient for reducing the power to maintain compliance. For p-sensor coverage testing, the device is moved and “along the direction of maximum antenna and sensor offset”.

Illustrated in the internal photo exhibit, although the sensor is spatially offset, there is no trigger condition where the antenna is next to the user but the sensor is laterally further away, therefore proximity sensor coverage testing is not required.

This procedure is not required because antenna and sensor are collocated and the peak SAR location is overlapping with the sensor.

**<Tablet Tilt angle influences to proximity sensor triggering (KDB 616217 D04 section 6.4)>:**

The influence of table tilt angles to proximity sensor triggering was determined by positioning each tablet edge that contains a transmitting antenna, perpendicular to the flat phantom, Edge1 at 10mm and Edge2 at 16 mm separation. Rotating the tablet around the edge next to the phantom in  $\leq 10^\circ$  increments until the tablet is  $\pm 45^\circ$  from the vertical position at  $0^\circ$ , and the maximum output power remains in the reduced mode.

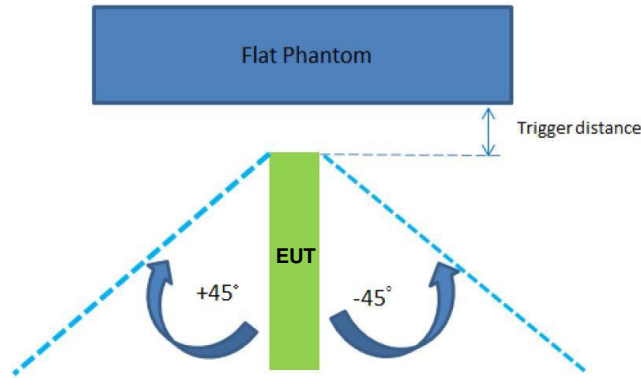

The Sensor Trigger Distance (mm)		
Position	Edge 1	Edge 2
Minimum	10	16

**Proximity sensor power reduction**

Exposure Position / wireless mode	Bottom Face <sup>(1)</sup>	Edge 1 <sup>(1)</sup>	Edge 2 <sup>(1)</sup>	Edge 3	Edge 4
WCDMA Band II	7.0 dB	7.0 dB	7.0 dB	0 dB	0 dB
WCDMA Band IV	7.0 dB	7.0 dB	7.0 dB		
WCDMA Band V	2.5 dB	2.5 dB	2.5 dB		
LTE Band 2	6.5 dB	6.5 dB	6.5 dB		
LTE Band 4	6.5 dB	6.5 dB	6.5 dB		
LTE Band 5	3.0 dB	3.0 dB	3.0 dB		
LTE Band 7	5.0 dB	5.0 dB	5.0 dB		
LTE Band 12	3.5 dB	3.5 dB	3.5 dB		
LTE Band 13	3.0 dB	3.0 dB	3.0 dB		
LTE Band 25	6.5 dB	6.5 dB	6.5 dB		
LTE Band 26	3.0 dB	3.0 dB	3.0 dB		
LTE Band 41	5.0 dB	5.0 dB	5.0 dB		

**Remark:**

1. <sup>(1)</sup>: Reduced maximum limit applied by activation of proximity sensor.
2. Power reduction is not applicable for WLAN and Bluetooth.
3. Tests were performed in accordance with KDB 616217 D04 section 6.1, 6.2, 6.3, 6.4 and 6.5 and compliant results are shown and described in exhibit "P-Sensor operational description"
4. For verification of compliance of power reduction scheme, additional SAR testing with EUT transmitting at full RF power at a conservative trigger distance was performed:
  - Bottom Face: [11 mm](#)
  - Edge1: [9 mm](#)
  - Edge2: [15 mm](#)



Power Measurement during Sensor Trigger distance testing

Band/Mode	Ch #	Measured power reduction (dBm)		Reduction Levels (dB)
		w/o power back-off	w/ power back-off	
WCDMA Band II	9400	22.88	16.30	6.58
WCDMA Band IV	1413	22.83	16.11	6.72
WCDMA Band V	4233	22.97	20.17	2.80
LTE Band 2	18900	23.23	16.64	6.59
LTE Band 4	20175	23.30	16.61	6.69
LTE Band 5	20525	22.52	20.12	2.40
LTE Band 7	21100	21.22	17.62	3.60
LTE Band 12	23095	22.72	19.28	3.44
LTE Band 13	23230	23.77	19.84	3.93
LTE Band 25	26340	23.37	16.74	6.63
LTE Band 26	26865	22.58	19.90	2.68
LTE Band 41	41490	21.17	17.36	3.81

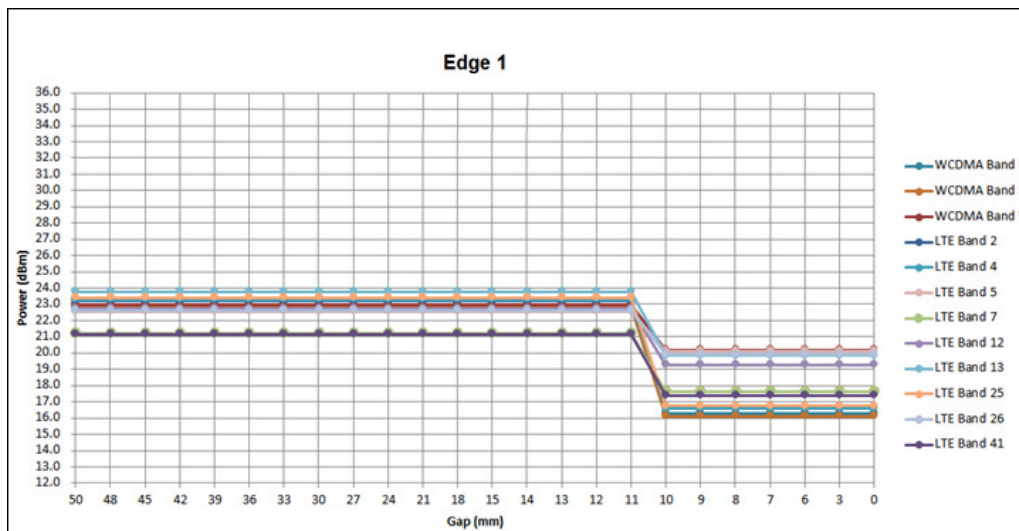
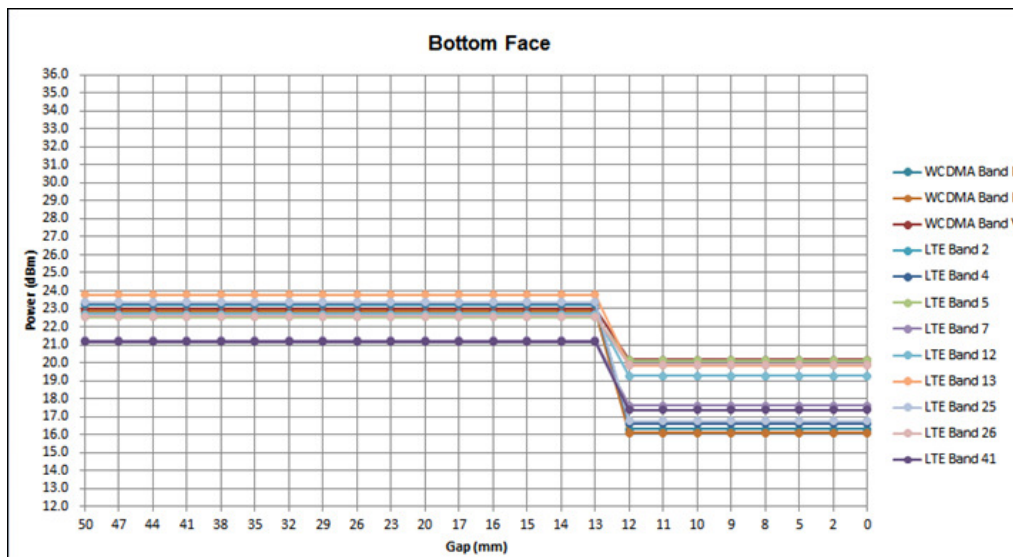

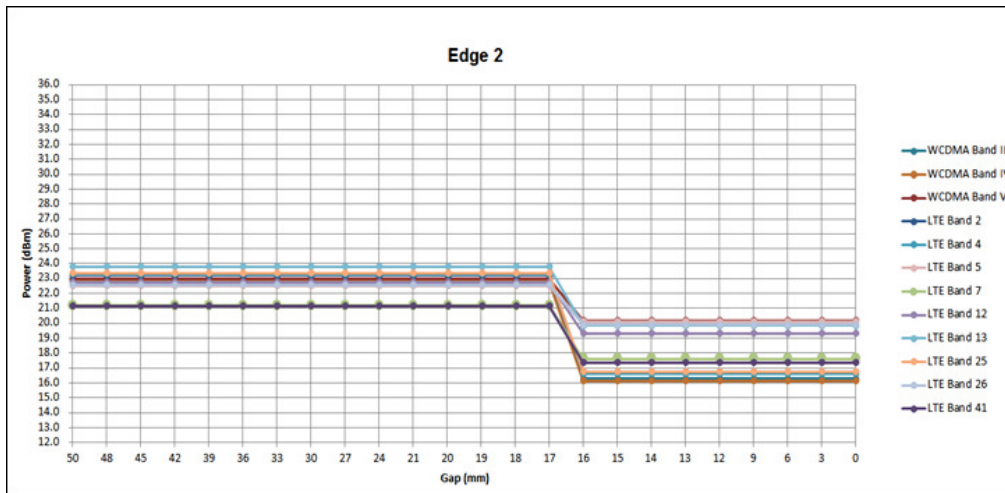



**6. RF Exposure Limits**

**6.1 Uncontrolled Environment**

Uncontrolled Environments are defined as locations where there is the exposure of individuals who have no knowledge or control of their exposure. The general population/uncontrolled exposure limits are applicable to situations in which the general public may be exposed or in which persons who are exposed as a consequence of their employment may not be made fully aware of the potential for exposure or cannot exercise control over their exposure. Members of the general public would come under this category when exposure is not employment-related; for example, in the case of a wireless transmitter that exposes persons in its vicinity.

**6.2 Controlled Environment**

Controlled Environments are defined as locations where there is exposure that may be incurred by persons who are aware of the potential for exposure, (i.e. as a result of employment or occupation). In general, occupational/controlled exposure limits are applicable to situations in which persons are exposed as a consequence of their employment, who have been made fully aware of the potential for exposure and can exercise control over their exposure. The exposure category is also applicable when the exposure is of a transient nature due to incidental passage through a location where the exposure levels may be higher than the general population/uncontrolled limits, but the exposed person is fully aware of the potential for exposure and can exercise control over his or her exposure by leaving the area or by some other appropriate means.

**Limits for Occupational/Controlled Exposure (W/kg)**

Whole-Body	Partial-Body	Hands, Wrists, Feet and Ankles
0.4	8.0	20.0

**Limits for General Population/Uncontrolled Exposure (W/kg)**

Whole-Body	Partial-Body	Hands, Wrists, Feet and Ankles
0.08	1.6	4.0

1. Whole-Body SAR is averaged over the entire body, partial-body SAR is averaged over any 1gram of tissue defined as a tissue volume in the shape of a cube. SAR for hands, wrists, feet and ankles is averaged over any 10 grams of tissue defined as a tissue volume in the shape of a cube.

## **7. Specific Absorption Rate (SAR)**

### **7.1 Introduction**

SAR is related to the rate at which energy is absorbed per unit mass in an object exposed to a radio field. The SAR distribution in a biological body is complicated and is usually carried out by experimental techniques or numerical modeling. The standard recommends limits for two tiers of groups, occupational/controlled and general population/uncontrolled, based on a person's awareness and ability to exercise control over his or her exposure. In general, occupational/controlled exposure limits are higher than the limits for general population/uncontrolled.

### **7.2 SAR Definition**

The SAR definition is the time derivative (rate) of the incremental energy (dW) absorbed by (dissipated in) an incremental mass (dm) contained in a volume element (dv) of a given density ( $\rho$ ). The equation description is as below:

$$SAR = \frac{d}{dt} \left( \frac{dW}{dm} \right) = \frac{d}{dt} \left( \frac{dW}{\rho dv} \right)$$

SAR is expressed in units of Watts per kilogram (W/kg)

$$SAR = \frac{\sigma |E|^2}{\rho}$$

Where:  $\sigma$  is the conductivity of the tissue,  $\rho$  is the mass density of the tissue and E is the RMS electrical field strength.

## 8. System Description and Setup

The DASY system used for performing compliance tests consists of the following items:

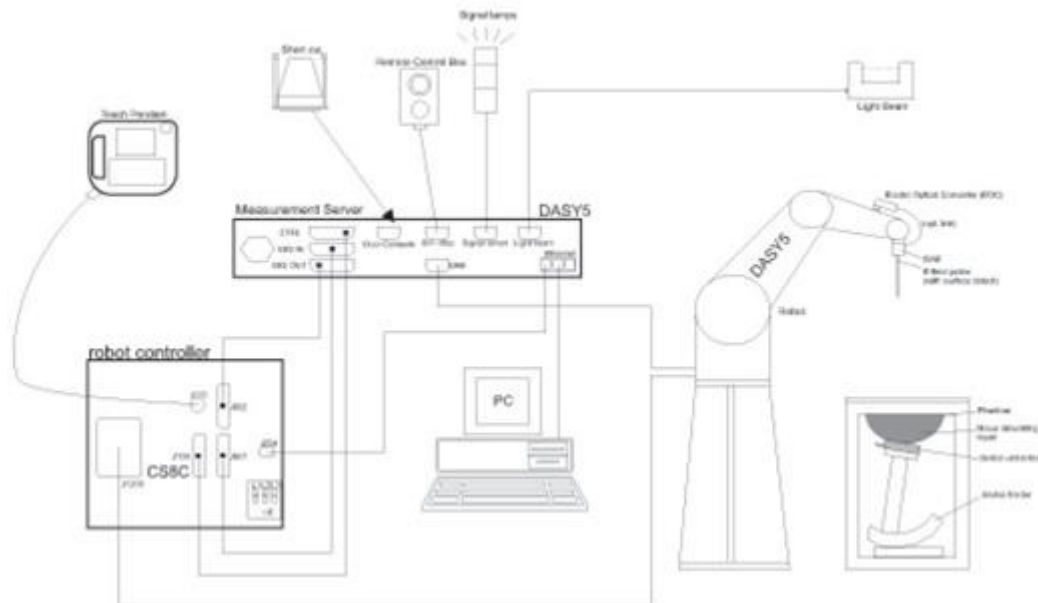

- A standard high precision 6-axis robot with controller, teach pendant and software. An arm extension for accommodating the data acquisition electronics (DAE).
- An isotropic Field probe optimized and calibrated for the targeted measurement.
- A data acquisition electronics (DAE) which performs the signal amplification, signal multiplexing, AD-conversion, offset measurements, mechanical surface detection, collision detection, etc. The unit is battery powered with standard or rechargeable batteries. The signal is optically transmitted to the EOC.
- The Electro-optical converter (EOC) performs the conversion from optical to electrical signals for the digital communication to the DAE. To use optical surface detection, a special version of the EOC is required. The EOC signal is transmitted to the measurement server.
- The function of the measurement server is to perform the time critical tasks such as signal filtering, control of the robot operation and fast movement interrupts.
- The Light Beam used is for probe alignment. This improves the (absolute) accuracy of the probe positioning.
- A computer running WinXP or Win7 and the DASY5 software.
- Remote control and teach pendant as well as additional circuitry for robot safety such as warning lamps, etc.
- The phantom, the device holder and other accessories according to the targeted measurement.

**8.1 E-Field Probe**

The SAR measurement is conducted with the dosimetric probe (manufactured by SPEAG).The probe is specially designed and calibrated for use in liquid with high permittivity. The dosimetric probe has special calibration in liquid at different frequency. This probe has a built in optical surface detection system to prevent from collision with phantom.

**<ES3DV3 Probe>**

<b>Construction</b>	Symmetric design with triangular core Interleaved sensors Built-in shielding against static charges PEEK enclosure material (resistant to organic solvents, e.g., DGBE)	
<b>Frequency</b>	10 MHz – 4 GHz; Linearity: ±0.2 dB (30 MHz – 4 GHz)	
<b>Directivity</b>	±0.2 dB in TSL (rotation around probe axis) ±0.3 dB in TSL (rotation normal to probe axis)	
<b>Dynamic Range</b>	5 µW/g – >100 mW/g; Linearity: ±0.2 dB	
<b>Dimensions</b>	Overall length: 337 mm (tip: 20 mm) Tip diameter: 3.9 mm (body: 12 mm) Distance from probe tip to dipole centers: 2.0 mm	

**<EX3DV4 Probe>**

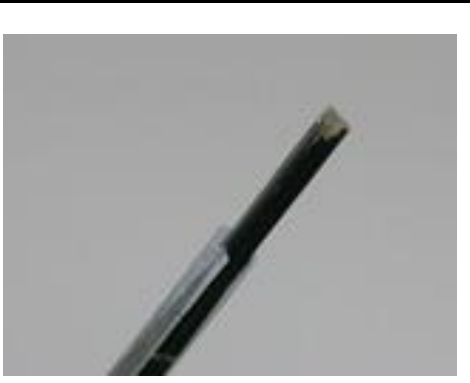
<b>Construction</b>	Symmetric design with triangular core Built-in shielding against static charges PEEK enclosure material (resistant to organic solvents, e.g., DGBE)	
<b>Frequency</b>	10 MHz – >6 GHz Linearity: ±0.2 dB (30 MHz – 6 GHz)	
<b>Directivity</b>	±0.3 dB in TSL (rotation around probe axis) ±0.5 dB in TSL (rotation normal to probe axis)	
<b>Dynamic Range</b>	10 µW/g – >100 mW/g Linearity: ±0.2 dB (noise: typically <1 µW/g)	
<b>Dimensions</b>	Overall length: 337 mm (tip: 20 mm) Tip diameter: 2.5 mm (body: 12 mm) Typical distance from probe tip to dipole centers: 1 mm	

**8.2 Data Acquisition Electronics (DAE)**

The data acquisition electronics (DAE) consists of a highly sensitive electrometer-grade preamplifier with auto-zeroing, a channel and gain-switching multiplexer, a fast 16 bit AD-converter and a command decoder and control logic unit. Transmission to the measurement server is accomplished through an optical downlink for data and status information as well as an optical uplink for commands and the clock.

The input impedance of the DAE is 200 MOhm; the inputs are symmetrical and floating. Common mode rejection is above 80 dB.



**Fig 5.1 Photo of DAE**

**8.3 Phantom**

**<SAM Twin Phantom>**

<b>Shell Thickness</b>	2 ± 0.2 mm; Center ear point: 6 ± 0.2 mm	
<b>Filling Volume</b>	Approx. 25 liters	
<b>Dimensions</b>	Length: 1000 mm; Width: 500 mm; Height: adjustable feet	
<b>Measurement Areas</b>	Left Hand, Right Hand, Flat Phantom	

The bottom plate contains three pair of bolts for locking the device holder. The device holder positions are adjusted to the standard measurement positions in the three sections. A white cover is provided to tap the phantom during off-periods to prevent water evaporation and changes in the liquid parameters. On the phantom top, three reference markers are provided to identify the phantom position with respect to the robot.

**<ELI Phantom>**

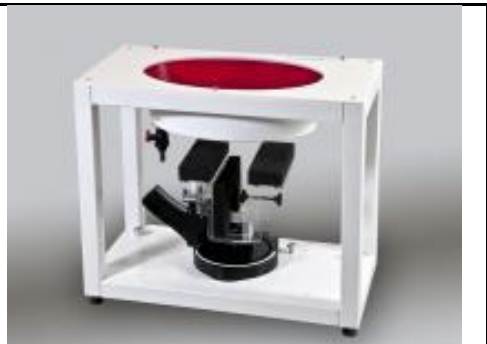
<b>Shell Thickness</b>	2 ± 0.2 mm (sagging: <1%)	
<b>Filling Volume</b>	Approx. 30 liters	
<b>Dimensions</b>	Major ellipse axis: 600 mm Minor axis: 400 mm	

The ELI phantom is intended for compliance testing of handheld and body-mounted wireless devices in the frequency range of 30 MHz to 6 GHz. ELI4 is fully compatible with standard and all known tissue simulating liquids.

### **8.4 Device Holder**

#### **<Mounting Device for Hand-Held Transmitter>**

In combination with the Twin SAM V5.0/V5.0c or ELI phantoms, the Mounting Device for Hand-Held Transmitters enables rotation of the mounted transmitter device to specified spherical coordinates. At the heads, the rotation axis is at the ear opening. Transmitter devices can be easily and accurately positioned according to IEC 62209-1, IEEE 1528, FCC, or other specifications. The device holder can be locked for positioning at different phantom sections (left head, right head, flat). And upgrade kit to Mounting Device to enable easy mounting of wider devices like big smart-phones, e-books, small tablets, etc. It holds devices with width up to 140 mm.



Mounting Device for Hand-Held Transmitters



Mounting Device Adaptor for Wide-Phones

#### **<Mounting Device for Laptops and other Body-Worn Transmitters>**

The extension is lightweight and made of POM, acrylic glass and foam. It fits easily on the upper part of the mounting device in place of the phone positioned. The extension is fully compatible with the SAM Twin and ELI phantoms.



Mounting Device for Laptops

## **9. Measurement Procedures**

The measurement procedures are as follows:

### <Conducted power measurement>

- (a) For WWAN power measurement, use base station simulator to configure EUT WWAN transmission in conducted connection with RF cable, at maximum power in each supported wireless interface and frequency band.
- (b) Read the WWAN RF power level from the base station simulator.
- (c) For WLAN/BT power measurement, use engineering software to configure EUT WLAN/BT continuously transmission, at maximum RF power in each supported wireless interface and frequency band
- (d) Connect EUT RF port through RF cable to the power meter, and measure WLAN/BT output power

### <SAR measurement>

- (a) Use base station simulator to configure EUT WWAN transmission in radiated connection, and engineering software to configure EUT WLAN/BT continuously transmission, at maximum RF power, in the highest power channel.
- (b) Place the EUT in the positions as Appendix D demonstrates.
- (c) Set scan area, grid size and other setting on the DASY software.
- (d) Measure SAR results for the highest power channel on each testing position.
- (e) Find out the largest SAR result on these testing positions of each band
- (f) Measure SAR results for other channels in worst SAR testing position if the reported SAR of highest power channel is larger than 0.8 W/kg

According to the test standard, the recommended procedure for assessing the peak spatial-average SAR value consists of the following steps:

- (a) Power reference measurement
- (b) Area scan
- (c) Zoom scan
- (d) Power drift measurement

### **9.1 Spatial Peak SAR Evaluation**

The procedure for spatial peak SAR evaluation has been implemented according to the test standard. It can be conducted for 1g and 10g, as well as for user-specific masses. The DASY software includes all numerical procedures necessary to evaluate the spatial peak SAR value.

The base for the evaluation is a "cube" measurement. The measured volume must include the 1g and 10g cubes with the highest averaged SAR values. For that purpose, the center of the measured volume is aligned to the interpolated peak SAR value of a previously performed area scan.

The entire evaluation of the spatial peak values is performed within the post-processing engine (SEMCAD). The system always gives the maximum values for the 1g and 10g cubes. The algorithm to find the cube with highest averaged SAR is divided into the following stages:

- (a) Extraction of the measured data (grid and values) from the Zoom Scan
- (b) Calculation of the SAR value at every measurement point based on all stored data (A/D values and measurement parameters)
- (c) Generation of a high-resolution mesh within the measured volume
- (d) Interpolation of all measured values from the measurement grid to the high-resolution grid
- (e) Extrapolation of the entire 3-D field distribution to the phantom surface over the distance from sensor to surface
- (f) Calculation of the averaged SAR within masses of 1g and 10g

**9.2 Power Reference Measurement**

The Power Reference Measurement and Power Drift Measurements are for monitoring the power drift of the device under test in the batch process. The minimum distance of probe sensors to surface determines the closest measurement point to phantom surface. This distance cannot be smaller than the distance of sensor calibration points to probe tip as defined in the probe properties.

**9.3 Area Scan**

The area scan is used as a fast scan in two dimensions to find the area of high field values, before doing a fine measurement around the hot spot. The sophisticated interpolation routines implemented in DASY software can find the maximum found in the scanned area, within a range of the global maximum. The range (in dB0 is specified in the standards for compliance testing. For example, a 2 dB range is required in IEEE standard 1528 and IEC 62209 standards, whereby 3 dB is a requirement when compliance is assessed in accordance with the ARIB standard (Japan), if only one zoom scan follows the area scan, then only the absolute maximum will be taken as reference. For cases where multiple maximums are detected, the number of zoom scans has to be increased accordingly.

Area scan parameters extracted from FCC KDB 865664 D01v01r04 SAR measurement 100 MHz to 6 GHz.

	≤ 3 GHz	> 3 GHz
Maximum distance from closest measurement point (geometric center of probe sensors) to phantom surface	5 ± 1 mm	$\frac{1}{2} \cdot \delta \cdot \ln(2) \pm 0.5$ mm
Maximum probe angle from probe axis to phantom surface normal at the measurement location	30° ± 1°	20° ± 1°
Maximum area scan spatial resolution: $\Delta x_{Area}, \Delta y_{Area}$	≤ 2 GHz: ≤ 15 mm 2 – 3 GHz: ≤ 12 mm	3 – 4 GHz: ≤ 12 mm 4 – 6 GHz: ≤ 10 mm
	When the x or y dimension of the test device, in the measurement plane orientation, is smaller than the above, the measurement resolution must be ≤ the corresponding x or y dimension of the test device with at least one measurement point on the test device.	



**9.4 Zoom Scan**

Zoom scans are used assess the peak spatial SAR values within a cubic averaging volume containing 1 gram and 10 gram of simulated tissue. The zoom scan measures points (refer to table below) within a cube shoes base faces are centered on the maxima found in a preceding area scan job within the same procedure. When the measurement is done, the zoom scan evaluates the averaged SAR for 1 gram and 10 gram and displays these values next to the job's label.

Zoom scan parameters extracted from FCC KDB 865664 D01v01r04 SAR measurement 100 MHz to 6 GHz.

		≤ 3 GHz	> 3 GHz	
Maximum zoom scan spatial resolution: $\Delta x_{Zoom}, \Delta y_{Zoom}$		$\leq 2$ GHz: $\leq 8$ mm $2 - 3$ GHz: $\leq 5$ mm*	$3 - 4$ GHz: $\leq 5$ mm* $4 - 6$ GHz: $\leq 4$ mm*	
Maximum zoom scan spatial resolution, normal to phantom surface	uniform grid: $\Delta z_{Zoom}(n)$	$\leq 5$ mm	$3 - 4$ GHz: $\leq 4$ mm $4 - 5$ GHz: $\leq 3$ mm $5 - 6$ GHz: $\leq 2$ mm	
	graded grid	$\Delta z_{Zoom}(1)$ : between 1 <sup>st</sup> two points closest to phantom surface	$\leq 4$ mm	$3 - 4$ GHz: $\leq 3$ mm $4 - 5$ GHz: $\leq 2.5$ mm $5 - 6$ GHz: $\leq 2$ mm
		$\Delta z_{Zoom}(n>1)$ : between subsequent points	$\leq 1.5 \cdot \Delta z_{Zoom}(n-1)$	
Minimum zoom scan volume	x, y, z	$\geq 30$ mm	$3 - 4$ GHz: $\geq 28$ mm $4 - 5$ GHz: $\geq 25$ mm $5 - 6$ GHz: $\geq 22$ mm	
Note: $\delta$ is the penetration depth of a plane-wave at normal incidence to the tissue medium; see draft standard IEEE P1528-2011 for details. * When zoom scan is required and the <i>reported</i> SAR from the <i>area scan based 1-g SAR estimation</i> procedures of KDB 447498 is $\leq 1.4$ W/kg, $\leq 8$ mm, $\leq 7$ mm and $\leq 5$ mm zoom scan resolution may be applied, respectively, for 2 GHz to 3 GHz, 3 GHz to 4 GHz and 4 GHz to 6 GHz.				



### **9.5 Volume Scan Procedures**

The volume scan is used for assess overlapping SAR distributions for antennas transmitting in different frequency bands. It is equivalent to an oversized zoom scan used in standalone measurements. The measurement volume will be used to enclose all the simultaneous transmitting antennas. For antennas transmitting simultaneously in different frequency bands, the volume scan is measured separately in each frequency band. In order to sum correctly to compute the 1g aggregate SAR, the EUT remain in the same test position for all measurements and all volume scan use the same spatial resolution and grid spacing. When all volume scan were completed, the software, SEMCAD postprocessor can combine and subsequently superpose these measurement data to calculating the multiband SAR.

### **9.6 Power Drift Monitoring**

All SAR testing is under the EUT install full charged battery and transmit maximum output power. In DASYS measurement software, the power reference measurement and power drift measurement procedures are used for monitoring the power drift of EUT during SAR test. Both these procedures measure the field at a specified reference position before and after the SAR testing. The software will calculate the field difference in dB. If the power drifts more than 5%, the SAR will be retested.



**10. Test Equipment List**

Manufacturer	Name of Equipment	Type/Model	Serial Number	Calibration	
				Last Cal.	Due Date
SPEAG	750MHz System Validation Kit	D750V3	1012	May. 28, 2015	May. 27, 2016
SPEAG	835MHz System Validation Kit	D835V2	499	Mar. 20, 2015	Mar. 19, 2016
SPEAG	1750MHz System Validation Kit	D1750V2	1068	Nov. 23, 2015	Nov. 22, 2016
SPEAG	1900MHz System Validation Kit	D1900V2	5d041	Oct. 22, 2015	Oct. 21, 2016
SPEAG	2600MHz System Validation Kit	D2600V2	1008	Aug. 19, 2015	Aug. 18, 2016
SPEAG	Data Acquisition Electronics	DAE4	778	Aug. 25, 2015	Aug. 24, 2016
SPEAG	Data Acquisition Electronics	DAE4	1399	Nov. 23, 2015	Nov. 22, 2016
SPEAG	Dosimetric E-Field Probe	EX3DV4	3697	Sep. 28, 2015	Sep. 27, 2016
SPEAG	Dosimetric E-Field Probe	EX3DV4	3578	Mar. 31, 2015	Mar. 30, 2016
SPEAG	Dosimetric E-Field Probe	ES3DV3	3270	Sep. 28, 2015	Sep. 27, 2016
WonDer	Thermometer	WD-5015	TM685	Oct. 16, 2015	Oct. 15, 2016
WonDer	Thermometer	WD-5015	TM642	Oct. 16, 2015	Oct. 15, 2016
WonDer	Thermometer	WD-5015	TM281	Oct. 16, 2015	Oct. 15, 2016
Anritsu	Radio Communication Analyzer	MT8820C	6201074414	Feb. 06, 2015	Feb. 05, 2016
Agilent	Wireless Communication Test Set	E5515C	MY50266977	May. 14, 2015	May. 13, 2016
SPEAG	Device Holder	N/A	N/A	N/A	N/A
R&S	Signal Generator	MG3710A	6201502524	May. 25, 2015	May. 24, 2016
Agilent	ENA Network Analyzer	E5071C	MY46316648	Feb. 11, 2015	Feb. 10, 2016
SPEAG	Dielectric Probe Kit	DAK-3.5	1126	Jul. 21, 2015	Jul. 20, 2016
LINE SEIKI	Digital Thermometer	LKMelectronic	DTM3000SPEZIAL	Jul. 17, 2015	Jul. 16, 2016
Anritsu	Power Meter	ML2495A	1419002	May. 13, 2015	May. 12, 2016
Anritsu	Power Sensor	MA2411B	1339124	May. 13, 2015	May. 12, 2016
Anritsu	Spectrum Analyzer	MS2830A	6201396378	Jun. 17, 2015	Jun. 16, 2016
ATM	Dual Directional Coupler	C122H-10	P610410z-02	Note 1	
Woken	Attenuator 1	WK0602-XX	N/A	Note 1	
PE	Attenuator 2	PE7005-10	N/A	Note 1	
PE	Attenuator 3	PE7005- 3	N/A	Note 1	
AR	Power Amplifier	5S1G4M2	0328767	Note 1	
Mini-Circuits	Power Amplifier	ZVE-3W	162601250	Note 1	

**General Note:**

1. Prior to system verification and validation, the path loss from the signal generator to the system check source and the power meter, which includes the amplifier, cable, attenuator and directional coupler, was measured by the network analyzer. The reading of the power meter was offset by the path loss difference between the path to the power meter and the path to the system check source to monitor the actual power level fed to the system check source.



## 11. System Verification

### 11.1 Tissue Verification

The following tissue formulations are provided for reference only as some of the parameters have not been thoroughly verified. The composition of ingredients may be modified accordingly to achieve the desired target tissue parameters required for routine SAR evaluation.

Frequency (MHz)	Water (%)	Sugar (%)	Cellulose (%)	Salt (%)	Preventol (%)	DGBE (%)	Conductivity ( $\sigma$ )	Permittivity ( $\epsilon_r$ )
For Head								
750	41.1	57.0	0.2	1.4	0.2	0	0.89	41.9
835	40.3	57.9	0.2	1.4	0.2	0	0.90	41.5
900	40.3	57.9	0.2	1.4	0.2	0	0.97	41.5
1800, 1900, 2000	55.2	0	0	0.3	0	44.5	1.40	40.0
2450	55.0	0	0	0	0	45.0	1.80	39.2
2600	54.8	0	0	0.1	0	45.1	1.96	39.0
For Body								
750	51.7	47.2	0	0.9	0.1	0	0.96	55.5
835	50.8	48.2	0	0.9	0.1	0	0.97	55.2
900	50.8	48.2	0	0.9	0.1	0	1.05	55.0
1800, 1900, 2000	70.2	0	0	0.4	0	29.4	1.52	53.3
2450	68.6	0	0	0	0	31.4	1.95	52.7
2600	68.1	0	0	0.1	0	31.8	2.16	52.5

#### Simulating Liquid for 5GHz, Manufactured by SPEAG

Ingredients	(% by weight)
Water	64~78%
Mineral oil	11~18%
Emulsifiers	9~15%
Additives and Salt	2~3%

#### <Tissue Dielectric Parameter Check Results>

Frequency (MHz)	Tissue Type	Liquid Temp. (°C)	Conductivity ( $\sigma$ )	Permittivity ( $\epsilon_r$ )	Conductivity Target ( $\sigma$ )	Permittivity Target ( $\epsilon_r$ )	Delta ( $\sigma$ ) (%)	Delta ( $\epsilon_r$ ) (%)	Limit (%)	Date
750	MSL	22.5	0.963	55.933	0.96	55.50	0.31	0.78	±5	2015/12/29
750	MSL	22.5	0.970	54.699	0.96	55.50	1.04	-1.44	±5	2015/12/31
835	MSL	22.5	0.972	55.117	0.97	55.20	0.21	-0.15	±5	2015/12/29
835	MSL	22.5	0.966	56.435	0.97	55.20	-0.41	2.24	±5	2015/12/31
1750	MSL	22.4	1.477	54.431	1.49	53.40	-0.87	1.93	±5	2015/12/25
1900	MSL	22.4	1.580	54.709	1.52	53.30	3.95	2.64	±5	2015/12/25
1900	MSL	22.4	1.570	53.024	1.52	53.30	3.29	-0.52	±5	2016/1/1
2600	MSL	22.4	2.224	51.037	2.16	52.50	2.96	-2.79	±5	2015/12/24

**11.2 System Performance Check Results**

Comparing to the original SAR value provided by SPEAG, the verification data should be within its specification of 10 %. Below table shows the target SAR and measured SAR after normalized to 1W input power. The table below indicates the system performance check can meet the variation criterion and the plots can be referred to Appendix A of this report.

Date	Frequency (MHz)	Tissue Type	Input Power (mW)	Dipole S/N	Probe S/N	DAE S/N	Measured 1g SAR (W/kg)	Targeted 1g SAR (W/kg)	Normalized 1g SAR (W/kg)	Deviation (%)
2015/12/29	750	MSL	250	D750V3-1012	EX3DV4 - SN3697	DAE4 Sn1399	1.99	8.61	7.96	-7.55
2015/12/31	750	MSL	250	D750V3-1012	EX3DV4 - SN3578	DAE4 Sn1399	2.06	8.61	8.24	-4.30
2015/12/29	835	MSL	250	D835V2-499	EX3DV4 - SN3697	DAE4 Sn1399	2.43	9.30	9.72	4.52
2015/12/31	835	MSL	250	D835V2-499	EX3DV4 - SN3578	DAE4 Sn1399	2.36	9.30	9.44	1.51
2015/12/25	1750	MSL	250	D1750V2_1068	EX3DV4 - SN3697	DAE4 Sn1399	9.44	35.70	37.76	5.77
2015/12/25	1900	MSL	250	D1900V2_5d041	EX3DV4 - SN3697	DAE4 Sn1399	9.93	40.00	39.72	-0.70
2016/1/1	1900	MSL	250	D1900V2_5d041	EX3DV4 - SN3578	DAE4 Sn1399	9.68	40.00	38.72	-3.20
2015/12/24	2600	MSL	250	D2600V2-1008	ES3DV3 - SN3270	DAE4 Sn778	13.50	55.80	54.00	-3.23

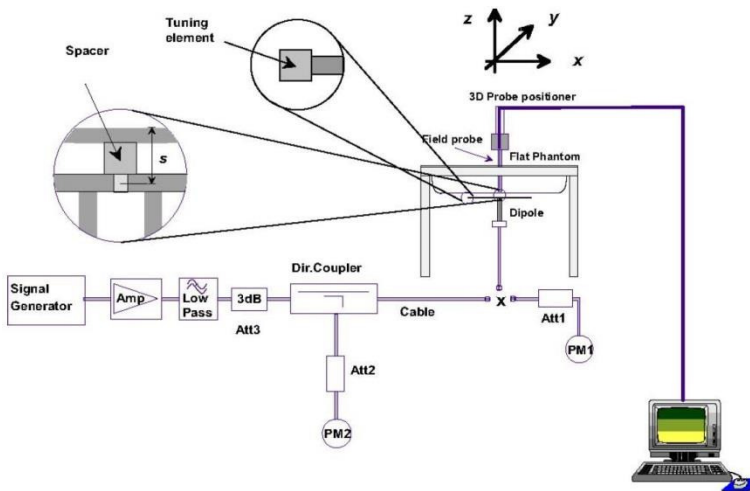

**Fig 8.3.1 System Performance Check Setup**

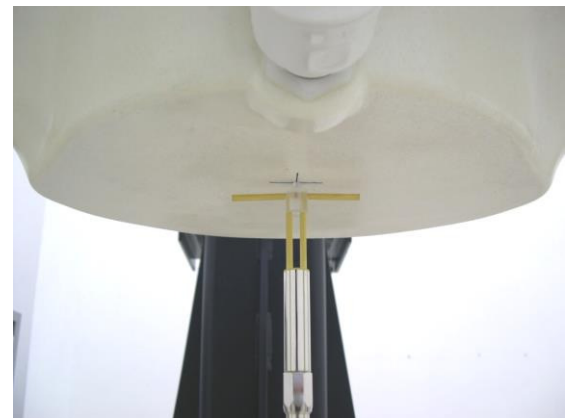

**Fig 8.3.2 Setup Photo**

**12. RF Exposure Positions**

**12.1 SAR Testing for Tablet**

This device can be used also in full sized tablet exposure conditions, due to its size. Per FCC KDB 616217, the back surface and edges of the tablet should be tested for SAR compliance with the tablet touching the phantom. The SAR exclusion threshold in KDB 447498 D01v06 can be applied to determine SAR test exclusion for adjacent edge configurations. The closest distance from the antenna to an adjacent tablet edge is used to determine if SAR testing is required for the adjacent edges, with the adjacent edge positioned against the phantom and the edge containing the antenna positioned perpendicular to the phantom.

### 13. Conducted RF Output Power (Unit: dBm)

**<WCDMA Conducted Power>**

1. The following tests were conducted according to the test requirements outlines in 3GPP TS 34.121 specification.
2. The procedures in KDB 941225 D01v03r01 are applied for 3GPP Rel. 6 HSPA to configure the device in the required sub-test mode(s) to determine SAR test exclusion.
3. For DC-HSDPA, the device was configured according to the H-Set 12, Fixed Reference Channel (FRC) configuration in Table C.8.1.12 of 3GPP TS 34.121-1, with the primary and the secondary serving HS-DSCH Cell enabled during the power measurement.

A summary of these settings are illustrated below:

**HSDPA Setup Configuration:**

- a. The EUT was connected to Base Station Agilent E5515C referred to the Setup Configuration.
- b. The RF path losses were compensated into the measurements.
- c. A call was established between EUT and Base Station with following setting:
  - i. Set Gain Factors ( $\beta_c$  and  $\beta_d$ ) and parameters were set according to each
  - ii. Specific sub-test in the following table, C10.1.4, quoted from the TS 34.121
  - iii. Set RMC 12.2Kbps + HSDPA mode.
  - iv. Set Cell Power = -86 dBm
  - v. Set HS-DSCH Configuration Type to FRC (H-set 1, QPSK)
  - vi. Select HSDPA Uplink Parameters
  - vii. Set Delta ACK, Delta NACK and Delta CQI = 8
  - viii. Set Ack-Nack Repetition Factor to 3
  - ix. Set CQI Feedback Cycle (k) to 4 ms
  - x. Set CQI Repetition Factor to 2
  - xi. Power Ctrl Mode = All Up bits
- d. The transmitted maximum output power was recorded.

**Table C.10.1.4:  $\beta$  values for transmitter characteristics tests with HS-DPCCH**

Sub-test	$\beta_c$	$\beta_d$	$\beta_d$ (SF)	$\beta_c/\beta_d$	$\beta_{HS}$ (Note 1, Note 2)	CM (dB) (Note 3)	MPR (dB) (Note 3)
1	2/15	15/15	64	2/15	4/15	0.0	0.0
2	12/15 (Note 4)	15/15 (Note 4)	64	12/15 (Note 4)	24/15	1.0	0.0
3	15/15	8/15	64	15/8	30/15	1.5	0.5
4	15/15	4/15	64	15/4	30/15	1.5	0.5

Note 1:  $\Delta_{ACK}, \Delta_{NACK}$  and  $\Delta_{CQI} = 30/15$  with  $\beta_{HS} = 30/15 * \beta_c$ .

Note 2: For the HS-DPCCH power mask requirement test in clause 5.2C, 5.7A, and the Error Vector Magnitude (EVM) with HS-DPCCH test in clause 5.13.1A, and HSDPA EVM with phase discontinuity in clause 5.13.1AA,  $\Delta_{ACK}$  and  $\Delta_{NACK} = 30/15$  with  $\beta_{HS} = 30/15 * \beta_c$ , and  $\Delta_{CQI} = 24/15$  with  $\beta_{HS} = 24/15 * \beta_c$ .

Note 3: CM = 1 for  $\beta_c/\beta_d = 12/15, \beta_{HS}/\beta_c = 24/15$ . For all other combinations of DPDCCH, DPCCH and HS-DPCCH the MPR is based on the relative CM difference. This is applicable for only UEs that support HSDPA in release 6 and later releases.

Note 4: For subtest 2 the  $\beta_c/\beta_d$  ratio of 12/15 for the TFC during the measurement period (TF1, TF0) is achieved by setting the signalled gain factors for the reference TFC (TF1, TF1) to  $\beta_c = 11/15$  and  $\beta_d = 15/15$ .

**Setup Configuration**

**HSUPA Setup Configuration:**

- a. The EUT was connected to Base Station Agilent E5515C referred to the Setup Configuration.
- b. The RF path losses were compensated into the measurements.
- c. A call was established between EUT and Base Station with following setting \* :
  - i. Call Configs = 5.2B, 5.9B, 5.10B, and 5.13.2B with QPSK
  - ii. Set the Gain Factors ( $\beta_c$  and  $\beta_d$ ) and parameters (AG Index) were set according to each specific sub-test in the following table, C11.1.3, quoted from the TS 34.121
  - iii. Set Cell Power = -86 dBm
  - iv. Set Channel Type = 12.2k + HSPA
  - v. Set UE Target Power
  - vi. Power Ctrl Mode= Alternating bits
  - vii. Set and observe the E-TFCl
  - viii. Confirm that E-TFCl is equal to the target E-TFCl of 75 for sub-test 1, and other subtest's E-TFCl
- d. The transmitted maximum output power was recorded.

**Table C.11.1.3:  $\beta$  values for transmitter characteristics tests with HS-DPCCH and E-DCH**

Sub-test	$\beta_c$	$\beta_d$	$\beta_d$ (SF)	$\beta_c/\beta_d$	$\beta_{HS}$ (Note 1)	$\beta_{ec}$	$\beta_{ed}$ (Note 5) (Note 6)	$\beta_{ed}$ (SF)	$\beta_{ed}$ (Codes)	CM (dB) (Note 2)	MPR (dB) (Note 2)	AG Index (Note 6)	E-TFCl
1	11/15 (Note 3)	15/15 (Note 3)	64	11/15 (Note 3)	22/15	209/25	1309/225	4	1	1.0	0.0	20	75
2	6/15	15/15	64	6/15	12/15	12/15	94/75	4	1	3.0	2.0	12	67
3	15/15	9/15	64	15/9	30/15	30/15	$\beta_{ed1}$ : 47/15 $\beta_{ed2}$ : 47/15	4 4	2	2.0	1.0	15	92
4	2/15	15/15	64	2/15	4/15	2/15	56/75	4	1	3.0	2.0	17	71
5	15/15 (Note 4)	15/15 (Note 4)	64	15/15 (Note 4)	30/15	24/15	134/15	4	1	1.0	0.0	21	81

Note 1:  $\Delta_{ACK}, \Delta_{NACK}$  and  $\Delta_{CQI} = 30/15$  with  $\beta_{hs} = 30/15 * \beta_c$ .

Note 2: CM = 1 for  $\beta_c/\beta_d = 12/15$ ,  $\beta_{hs}/\beta_c = 24/15$ . For all other combinations of DPDCH, DPCCH, HS-DPCCH, E-DPDCH and E-DPCCH the MPR is based on the relative CM difference.

Note 3: For subtest 1 the  $\beta_c/\beta_d$  ratio of 11/15 for the TFC during the measurement period (TF1, TF0) is achieved by setting the signalled gain factors for the reference TFC (TF1, TF1) to  $\beta_c = 10/15$  and  $\beta_d = 15/15$ .

Note 4: For subtest 5 the  $\beta_c/\beta_d$  ratio of 15/15 for the TFC during the measurement period (TF1, TF0) is achieved by setting the signalled gain factors for the reference TFC (TF1, TF1) to  $\beta_c = 14/15$  and  $\beta_d = 15/15$ .

Note 5: In case of testing by UE using E-DPDCH Physical Layer category 1, Sub-test 3 is omitted according to TS25.306 Table 5.1g.

Note 6:  $\beta_{ed}$  can not be set directly, it is set by Absolute Grant Value.

**Setup Configuration**

**DC-HSDPA 3GPP release 8 Setup Configuration:**

- a. The EUT was connected to Base Station Agilent E5515C referred to the Setup Configuration below
- b. The RF path losses were compensated into the measurements.
- c. A call was established between EUT and Base Station with following setting:
  - i. Set RMC 12.2Kbps + HSDPA mode.
  - ii. Set Cell Power = -25 dBm
  - iii. Set HS-DSCH Configuration Type to FRC (H-set 12, QPSK)
  - iv. Select HSDPA Uplink Parameters
  - v. Set Gain Factors ( $\beta_c$  and  $\beta_d$ ) and parameters were set according to each Specific sub-test in the following table, C10.1.4, quoted from the TS 34.121
    - a). Subtest 1:  $\beta_c/\beta_d=2/15$
    - b). Subtest 2:  $\beta_c/\beta_d=12/15$
    - c). Subtest 3:  $\beta_c/\beta_d=15/8$
    - d). Subtest 4:  $\beta_c/\beta_d=15/4$
  - vi. Set Delta ACK, Delta NACK and Delta CQI = 8
  - vii. Set Ack-Nack Repetition Factor to 3
  - viii. Set CQI Feedback Cycle (k) to 4 ms
  - ix. Set CQI Repetition Factor to 2
  - x. Power Ctrl Mode = All Up bits
- d. The transmitted maximum output power was recorded.

The following tests were conducted according to the test requirements outlines in 3GPP TS 34.121 specification. A summary of these settings are illustrated below:

**C.8.1.12 Fixed Reference Channel Definition H-Set 12**

**Table C.8.1.12: Fixed Reference Channel H-Set 12**

Parameter	Unit	Value
Nominal Avg. Inf. Bit Rate	kbps	60
Inter-TTI Distance	TTI's	1
Number of HARQ Processes	Processes	6
Information Bit Payload ( $N_{INF}$ )	Bits	120
Number Code Blocks	Blocks	1
Binary Channel Bits Per TTI	Bits	960
Total Available SML's in UE	SML's	19200
Number of SML's per HARQ Proc.	SML's	3200
Coding Rate		0.15
Number of Physical Channel Codes	Codes	1
Modulation		QPSK
Note 1: The RMC is intended to be used for DC-HSDPA mode and both cells shall transmit with identical parameters as listed in the table. Note 2: Maximum number of transmission is limited to 1, i.e., retransmission is not allowed. The redundancy and constellation version 0 shall be used.		

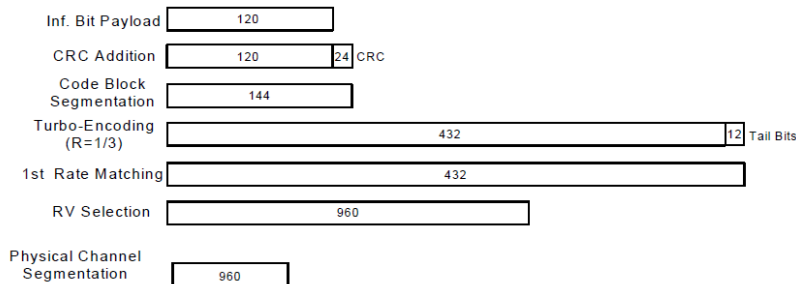

**Figure C.8.19: Coding rate for Fixed reference Channel H-Set 12 (QPSK)**

**Setup Configuration**





**<WCDMA Conducted Power>**

**General Note:**

1. Per KDB 941225 D01v03r01, SAR for Body exposure is measured using a 12.2 kbps RMC with TPC bits configured to all "1's".
2. Per KDB 941225 D01v03r01, RMC 12.2kbps setting is used to evaluate SAR. If the maximum output power and tune-up tolerance specified for production units in HSDPA / HSUPA / DC-HSDPA is  $\leq \frac{1}{4}$  dB higher than RMC 12.2Kbps or when the highest reported SAR of the RMC12.2Kbps is scaled by the ratio of specified maximum output power and tune-up tolerance of HSDPA / HSUPA / DC-HSDPA to RMC12.2Kbps and the adjusted SAR is  $\leq 1.2$  W/kg, SAR measurement is not required for HSDPA / HSUPA / DC-HSDPA.

**<Full Power Mode>**

Band		WCDMA V			Tune-up Limit (dBm)	WCDMA II			Tune-up Limit (dBm)	WCDMA IV			Tune-up Limit (dBm)
TX Channel		4132	4182	4233		9262	9400	9538		1312	1413	1513	
Rx Channel		4357	4407	4458	9662	9800	9938	1537	1638	1738			
Frequency (MHz)		826.4	836.4	846.6	1852.4	1880	1907.6	1712.4	1732.6	1752.6			
3GPP Rel 99	RMC 12.2Kbps	22.70	22.75	22.97	24.00	22.83	22.88	22.68	24.00	22.62	22.83	22.76	24.00
3GPP Rel 6	HSDPA Subtest-1	22.32	22.52	22.58	24.00	22.56	22.48	22.29	24.00	22.01	22.22	22.23	24.00
3GPP Rel 6	HSDPA Subtest-2	22.33	22.47	22.56	24.00	22.41	22.46	22.28	24.00	22.02	22.24	22.20	24.00
3GPP Rel 6	HSDPA Subtest-3	21.85	21.92	22.36	23.50	22.06	21.88	21.74	23.50	21.57	22.10	21.72	23.50
3GPP Rel 6	HSDPA Subtest-4	21.83	21.94	22.27	23.50	21.95	21.98	21.79	23.50	21.56	22.08	21.66	23.50
3GPP Rel 8	DC-HSDPA Subtest-1	22.43	22.37	22.57	24.00	22.36	22.43	22.33	24.00	22.01	22.50	22.13	24.00
3GPP Rel 8	DC-HSDPA Subtest-2	22.42	22.40	22.65	24.00	22.43	22.44	22.35	24.00	22.10	22.54	22.18	24.00
3GPP Rel 8	DC-HSDPA Subtest-3	21.81	22.07	22.06	23.50	21.87	21.89	21.74	23.50	21.59	22.08	21.65	23.50
3GPP Rel 8	DC-HSDPA Subtest-4	21.85	21.87	22.05	23.50	22.04	21.94	21.90	23.50	21.59	22.10	21.74	23.50
3GPP Rel 6	HSUPA Subtest-1	22.37	22.63	22.52	24.00	22.44	22.55	22.32	24.00	22.12	22.45	22.19	24.00
3GPP Rel 6	HSUPA Subtest-2	21.20	21.23	21.25	22.00	21.79	21.86	21.61	22.00	20.67	21.13	20.56	22.00
3GPP Rel 6	HSUPA Subtest-3	21.31	21.39	21.91	23.00	21.38	21.52	21.26	23.00	21.19	21.66	21.35	23.00
3GPP Rel 6	HSUPA Subtest-4	21.52	21.41	21.98	22.00	21.77	21.81	21.68	22.00	20.77	21.17	20.66	22.00
3GPP Rel 6	HSUPA Subtest-5	22.43	22.62	22.90	24.00	22.40	22.47	22.29	24.00	22.01	22.68	22.34	24.00

**<Reduced Power Mode>**

Band		WCDMA V			Tune-up Limit (dBm)	WCDMA II			Tune-up Limit (dBm)	WCDMA IV			Tune-up Limit (dBm)
TX Channel		4132	4182	4233		9262	9400	9538		1312	1413	1513	
Rx Channel		4357	4407	4458	9662	9800	9938	1537	1638	1738			
Frequency (MHz)		826.4	836.4	846.6	1852.4	1880	1907.6	1712.4	1732.6	1752.6			
3GPP Rel 99	RMC 12.2Kbps	20.11	20.00	20.17	21.50	16.28	16.30	16.19	17.00	16.05	16.11	16.10	17.00
3GPP Rel 6	HSDPA Subtest-1	18.95	18.90	19.05	19.50	15.29	15.20	15.36	17.00	15.02	15.14	15.06	17.00
3GPP Rel 6	HSDPA Subtest-2	19.00	18.93	19.09	19.50	15.31	15.22	15.36	17.00	15.01	15.11	15.07	17.00
3GPP Rel 6	HSDPA Subtest-3	18.50	18.46	18.58	19.00	14.80	14.71	14.89	16.50	14.53	14.60	14.55	16.50
3GPP Rel 6	HSDPA Subtest-4	18.48	18.45	18.57	19.00	14.79	14.70	14.87	16.50	14.50	14.57	14.53	16.50
3GPP Rel 8	DC-HSDPA Subtest-1	18.93	18.88	19.02	19.50	15.26	15.16	15.35	17.00	15.00	15.11	15.05	17.00
3GPP Rel 8	DC-HSDPA Subtest-2	18.98	18.91	19.04	19.50	15.27	15.20	15.36	17.00	15.00	15.08	15.05	17.00
3GPP Rel 8	DC-HSDPA Subtest-3	18.48	18.44	18.51	19.00	14.79	14.70	14.86	16.50	14.52	14.55	14.51	16.50
3GPP Rel 8	DC-HSDPA Subtest-4	18.45	18.41	18.52	19.00	14.76	14.65	14.86	16.50	14.50	14.56	14.53	16.50
3GPP Rel 6	HSUPA Subtest-1	17.52	17.53	17.58	19.50	13.69	13.55	13.75	15.50	13.80	13.54	13.50	15.50
3GPP Rel 6	HSUPA Subtest-2	17.71	17.63	17.66	18.50	13.98	13.91	14.04	15.50	14.02	13.96	14.11	15.50
3GPP Rel 6	HSUPA Subtest-3	18.02	17.93	18.00	18.50	14.27	14.19	14.36	14.50	14.31	14.17	14.20	15.50
3GPP Rel 6	HSUPA Subtest-4	18.18	18.00	18.11	18.50	14.25	14.20	14.42	15.50	14.35	14.21	14.40	15.50
3GPP Rel 6	HSUPA Subtest-5	19.04	18.87	19.00	19.50	15.29	15.18	15.29	15.50	14.99	15.15	15.05	15.50



**<LTE Conducted Power>**

**General Note:**

1. Anritsu MT8820C base station simulator was used to setup the connection with EUT; the frequency band, channel bandwidth, RB allocation configuration, modulation type are set in the base station simulator to configure EUT transmitting at maximum power and at different configurations which are requested to be reported to FCC, for conducted power measurement and SAR testing.
2. Per KDB 941225 D05v02r05, when a properly configured base station simulator is used for the SAR and power measurements, spectrum plots for each RB allocation and offset configuration is not required.
3. Per KDB 941225 D05v02r05, start with the largest channel bandwidth and measure SAR for QPSK with 1 RB allocation, using the RB offset and required test channel combination with the highest maximum output power for RB offsets at the upper edge, middle and lower edge of each required test channel.
4. Per KDB 941225 D05v02r05, 50% RB allocation for QPSK SAR testing follows 1RB QPSK allocation procedure.
5. Per KDB 941225 D05v02r05, For QPSK with 100% RB allocation, SAR is not required when the highest maximum output power for 100 % RB allocation is less than the highest maximum output power in 50% and 1 RB allocations and the highest reported SAR for 1 RB and 50% RB allocation are  $\leq 0.8$  W/kg. Otherwise, SAR is measured for the highest output power channel; and if the reported SAR is  $> 1.45$  W/kg, the remaining required test channels must also be tested.
6. Per KDB 941225 D05v02r05, 16QAM output power for each RB allocation configuration is  $>$  not  $\frac{1}{2}$  dB higher than the same configuration in QPSK and the reported SAR for the QPSK configuration is  $\leq 1.45$  W/kg; Per KDB 941225 D05v02r05, 16QAM SAR testing is not required.
7. Per KDB 941225 D05v02r05, Smaller bandwidth output power for each RB allocation configuration is  $>$  not  $\frac{1}{2}$  dB higher than the same configuration in the largest supported bandwidth, and the reported SAR for the largest supported bandwidth is  $\leq 1.45$  W/kg; Per KDB 941225 D05v02r05, smaller bandwidth SAR testing is not required.
8. For LTE B26 / B13 / B12 / B4 the maximum bandwidth does not support three non-overlapping channels, per KDB 941225 D05v02r05, when a device supports overlapping channel assignment in a channel bandwidth configuration, the middle channel of the group of overlapping channels should be selected for testing.
9. LTE band 2 / 5 SAR test was covered by Band 25 / 26; according to April 2015 TCB workshop, SAR test for overlapping LTE bands can be reduced if
  - a. the maximum output power, including tolerance, for the smaller band is  $\leq$  the larger band to qualify for the SAR test exclusion
  - b. the channel bandwidth and other operating parameters for the smaller band are fully supported by the larger band



**Full Power Mode**

**<LTE Band 2>**

BW [MHz]	Modulation	RB Size	RB Offset	Power Low Ch. / Freq.	Power Middle Ch. / Freq.	Power High Ch. / Freq.	Tune-up limit (dBm)	MPR (dB)
Channel				18700	18900	19100		
Frequency (MHz)				1860	1880	1900		
20	QPSK	1	0	23.14	23.23	23.11	24	0
20	QPSK	1	49	22.84	22.84	22.72		
20	QPSK	1	99	23.06	22.96	22.78		
20	QPSK	50	0	22.20	22.29	22.20	23	1
20	QPSK	50	24	22.01	21.93	21.88		
20	QPSK	50	50	21.94	21.90	21.72		
20	QPSK	100	0	22.14	22.15	21.99	23	1
20	16QAM	1	0	22.29	22.30	22.14		
20	16QAM	1	49	22.12	22.10	21.93		
20	16QAM	1	99	22.27	22.22	22.03	22	2
20	16QAM	50	0	21.33	21.19	21.14		
20	16QAM	50	24	20.97	20.94	20.81		
20	16QAM	50	50	20.95	20.88	20.72	22	2
20	16QAM	100	0	21.14	21.09	20.95		
Channel				18675	18900	19125		
Frequency (MHz)				1857.5	1880	1902.5		
15	QPSK	1	0	23.21	23.22	23.02	24	0
15	QPSK	1	37	22.79	22.78	22.65		
15	QPSK	1	74	23.03	22.95	22.68		
15	QPSK	36	0	22.13	22.27	22.12	23	1
15	QPSK	36	20	21.98	21.85	21.82		
15	QPSK	36	39	21.87	21.86	21.68		
15	QPSK	75	0	22.14	22.12	21.93	23	1
15	16QAM	1	0	22.26	22.28	22.04		
15	16QAM	1	37	22.11	22.06	21.83		
15	16QAM	1	74	22.24	22.21	22.00	22	2
15	16QAM	36	0	21.25	21.11	21.08		
15	16QAM	36	20	20.87	20.90	20.78		
15	16QAM	36	39	20.91	20.86	20.64	22	2
15	16QAM	75	0	21.06	21.08	20.90		
Channel				18650	18900	19150		
Frequency (MHz)				1855	1880	1905		
10	QPSK	1	0	23.21	23.22	22.95	24	0
10	QPSK	1	25	22.74	22.73	22.59		
10	QPSK	1	49	22.96	22.86	22.66		
10	QPSK	25	0	22.10	22.22	22.07	23	1
10	QPSK	25	12	21.96	21.79	21.78		
10	QPSK	25	25	21.84	21.85	21.65		
10	QPSK	50	0	22.14	22.02	21.90	23	1
10	16QAM	1	0	22.20	22.24	22.04		
10	16QAM	1	25	22.06	22.06	21.77		
10	16QAM	1	49	22.17	22.14	21.99	22	2
10	16QAM	25	0	21.20	21.10	21.08		
10	16QAM	25	12	20.85	20.80	20.70		
10	16QAM	25	25	20.81	20.81	20.61	22	2
10	16QAM	50	0	21.04	21.02	20.87		



Channel				18625	18900	19175	Tune-up limit (dBm)	MPR (dB)
Frequency (MHz)				1852.5	1880	1907.5		
5	QPSK	1	0	23.03	23.09	22.94	24	0
5	QPSK	1	12	22.63	22.70	22.50		
5	QPSK	1	24	22.89	22.77	22.67		
5	QPSK	12	0	21.96	22.17	22.12	23	1
5	QPSK	12	7	21.82	21.73	21.76		
5	QPSK	12	13	21.71	21.77	21.63		
5	QPSK	25	0	21.98	22.09	21.88		
5	16QAM	1	0	22.12	22.18	21.99	23	1
5	16QAM	1	12	21.98	21.89	21.73		
5	16QAM	1	24	22.09	22.12	21.85		
5	16QAM	12	0	21.23	21.09	20.90	22	2
5	16QAM	12	7	20.80	20.80	20.63		
5	16QAM	12	13	20.82	20.75	20.60		
5	16QAM	25	0	21.01	20.98	20.76		
Channel				18615	18900	19185	Tune-up limit (dBm)	MPR (dB)
Frequency (MHz)				1851.5	1880	1908.5		
3	QPSK	1	0	23.02	23.03	22.99	24	0
3	QPSK	1	8	22.63	22.61	22.48		
3	QPSK	1	14	22.84	22.74	22.59		
3	QPSK	8	0	21.97	22.18	21.98	23	1
3	QPSK	8	4	21.74	21.62	21.80		
3	QPSK	8	7	21.60	21.75	21.53		
3	QPSK	15	0	21.93	22.05	21.77		
3	16QAM	1	0	22.11	22.10	21.91	23	1
3	16QAM	1	8	21.96	21.84	21.62		
3	16QAM	1	14	22.01	22.12	21.85		
3	16QAM	8	0	21.10	21.07	20.90	22	2
3	16QAM	8	4	20.75	20.65	20.66		
3	16QAM	8	7	20.75	20.78	20.51		
3	16QAM	15	0	20.93	20.96	20.73		
Channel				18607	18900	19193	Tune-up limit (dBm)	MPR (dB)
Frequency (MHz)				1850.7	1880	1909.3		
1.4	QPSK	1	0	22.96	22.97	22.92	24	0
1.4	QPSK	1	3	22.56	22.49	22.36		
1.4	QPSK	1	5	22.82	22.79	22.58		
1.4	QPSK	3	0	22.36	22.28	22.33		
1.4	QPSK	3	1	22.74	22.45	22.39		
1.4	QPSK	3	3	22.75	22.50	22.35	23	1
1.4	QPSK	6	0	21.97	22.04	21.75		
1.4	16QAM	1	0	22.09	22.11	21.95	23	1
1.4	16QAM	1	3	21.96	21.80	21.66		
1.4	16QAM	1	5	21.91	21.94	21.79		
1.4	16QAM	3	0	21.36	21.33	21.33		
1.4	16QAM	3	1	21.83	21.38	21.28		
1.4	16QAM	3	3	21.87	21.53	21.30		
1.4	16QAM	6	0	20.76	20.83	20.63		



<LTE Band 4>

BW [MHz]	Modulation	RB Size	RB Offset	Power Low Ch. / Freq.	Power Middle Ch. / Freq.	Power High Ch. / Freq.	Tune-up limit (dBm)	MPR (dB)
Channel				20050	20175	20300		
Frequency (MHz)				1720	1732.5	1745		
20	QPSK	1	0	23.28	23.30	23.29	24	0
20	QPSK	1	49	22.78	22.84	22.61		
20	QPSK	1	99	22.95	22.94	22.91		
20	QPSK	50	0	22.15	22.31	22.14	23	1
20	QPSK	50	24	21.89	21.82	21.74		
20	QPSK	50	50	21.81	21.69	21.76		
20	QPSK	100	0	22.05	22.22	21.96		
20	16QAM	1	0	22.22	22.40	22.36	23	1
20	16QAM	1	49	22.11	22.00	21.87		
20	16QAM	1	99	22.22	22.11	22.15		
20	16QAM	50	0	21.12	21.13	21.14	22	2
20	16QAM	50	24	20.81	20.83	20.74		
20	16QAM	50	50	20.75	20.67	20.74		
20	16QAM	100	0	21.00	21.01	20.95		
Channel				20025	20175	20325		
Frequency (MHz)				1717.5	1732.5	1747.5		
15	QPSK	1	0	23.21	23.25	23.17	24	0
15	QPSK	1	37	22.78	22.74	22.58		
15	QPSK	1	74	22.91	22.94	22.85		
15	QPSK	36	0	22.14	22.26	22.07	23	1
15	QPSK	36	20	21.83	21.76	21.65		
15	QPSK	36	39	21.75	21.65	21.74		
15	QPSK	75	0	21.99	22.15	21.90		
15	16QAM	1	0	22.16	22.32	22.31	23	1
15	16QAM	1	37	22.11	21.98	21.87		
15	16QAM	1	74	22.22	22.08	22.12		
15	16QAM	36	0	21.04	21.09	21.13	22	2
15	16QAM	36	20	20.77	20.74	20.65		
15	16QAM	36	39	20.68	20.61	20.73		
15	16QAM	75	0	20.91	20.98	20.86		
Channel				20000	20175	20350		
Frequency (MHz)				1715	1732.5	1750		
10	QPSK	1	0	23.20	23.29	23.28	24	0
10	QPSK	1	25	22.77	22.66	22.58		
10	QPSK	1	49	22.90	22.93	22.85		
10	QPSK	25	0	22.12	22.16	22.07	23	1
10	QPSK	25	12	21.79	21.70	21.63		
10	QPSK	25	25	21.75	21.63	21.65		
10	QPSK	50	0	21.89	22.05	21.81		
10	16QAM	1	0	22.14	22.31	22.10	23	1
10	16QAM	1	25	22.02	21.90	21.78		
10	16QAM	1	49	22.17	22.06	22.09		
10	16QAM	25	0	21.03	21.05	21.05	22	2
10	16QAM	25	12	20.73	20.74	20.59		
10	16QAM	25	25	20.65	20.58	20.69		
10	16QAM	50	0	20.81	20.94	20.79		



Channel				19975	20175	20375	Tune-up limit (dBm)	MPR (dB)
Frequency (MHz)				1712.5	1732.5	1752.5		
5	QPSK	1	0	23.14	23.25	23.22	24	0
5	QPSK	1	12	22.73	22.66	22.56		
5	QPSK	1	24	22.90	22.84	22.80		
5	QPSK	12	0	22.12	22.13	22.01	23	1
5	QPSK	12	7	21.75	21.64	21.57		
5	QPSK	12	13	21.75	21.63	21.60		
5	QPSK	25	0	21.84	21.96	21.80	23	1
5	16QAM	1	0	22.08	22.26	22.22		
5	16QAM	1	12	21.96	21.87	21.73		
5	16QAM	1	24	22.14	21.96	22.06	22	2
5	16QAM	12	0	20.95	21.03	21.05		
5	16QAM	12	7	20.63	20.67	20.59		
5	16QAM	12	13	20.55	20.52	20.67	22	2
5	16QAM	12	13	20.55	20.52	20.67		
5	16QAM	25	0	20.71	20.88	20.73		
Channel				19965	20175	20385	Tune-up limit (dBm)	MPR (dB)
Frequency (MHz)				1711.5	1732.5	1753.5		
3	QPSK	1	0	23.14	23.18	23.16	24	0
3	QPSK	1	8	22.67	22.55	22.49		
3	QPSK	1	14	22.74	22.90	22.77		
3	QPSK	8	0	22.09	22.12	21.94	23	1
3	QPSK	8	4	21.77	21.56	21.53		
3	QPSK	8	7	21.64	21.59	21.59		
3	QPSK	15	0	21.72	22.02	21.77	23	1
3	16QAM	1	0	22.04	22.29	22.25		
3	16QAM	1	8	21.93	21.77	21.68		
3	16QAM	1	14	21.99	21.97	21.99	22	2
3	16QAM	8	0	20.91	21.01	21.00		
3	16QAM	8	4	20.58	20.64	20.59		
3	16QAM	8	7	20.54	20.46	20.62	22	2
3	16QAM	8	7	20.54	20.46	20.62		
3	16QAM	15	0	20.73	20.93	20.64		
Channel				19957	20175	20393	Tune-up limit (dBm)	MPR (dB)
Frequency (MHz)				1710.7	1732.5	1754.3		
1.4	QPSK	1	0	23.06	23.18	23.14	24	0
1.4	QPSK	1	3	22.60	22.45	22.39		
1.4	QPSK	1	5	22.72	22.88	22.74		
1.4	QPSK	3	0	22.78	22.46	22.39	24	0
1.4	QPSK	3	1	22.81	22.54	22.54		
1.4	QPSK	3	3	22.85	22.58	22.50		
1.4	QPSK	6	0	21.66	21.92	21.74	23	1
1.4	16QAM	1	0	21.97	22.27	22.24	23	1
1.4	16QAM	1	3	21.83	21.77	21.68		
1.4	16QAM	1	5	21.97	21.92	21.94		
1.4	16QAM	3	0	21.85	21.46	21.42	23	1
1.4	16QAM	3	1	21.82	21.49	21.44		
1.4	16QAM	3	3	21.94	21.59	21.47		
1.4	16QAM	6	0	20.64	20.86	20.59	22	2



<LTE Band 5>

BW [MHz]	Modulation	RB Size	RB Offset	Power Low Ch. / Freq.	Power Middle Ch. / Freq.	Power High Ch. / Freq.	Tune-up limit (dBm)	MPR (dB)
Channel				20450	20525	20600		
Frequency (MHz)				829	836.5	844		
10	QPSK	1	0	22.41	22.52	22.40	24	0
10	QPSK	1	25	22.32	22.34	22.34		
10	QPSK	1	49	22.22	22.18	22.18		
10	QPSK	25	0	21.27	21.38	21.38	23	1
10	QPSK	25	12	21.16	21.17	21.33		
10	QPSK	25	25	21.25	21.23	21.28		
10	QPSK	50	0	21.27	21.40	21.17		
10	16QAM	1	0	21.64	21.75	21.68	23	1
10	16QAM	1	25	21.64	21.69	21.56		
10	16QAM	1	49	21.46	21.34	21.32		
10	16QAM	25	0	20.27	20.19	20.21	22	2
10	16QAM	25	12	20.27	20.12	20.25		
10	16QAM	25	25	20.26	20.32	20.16		
10	16QAM	50	0	20.26	20.15	20.18		
Channel				20425	20525	20625	Tune-up limit (dBm)	MPR (dB)
Frequency (MHz)				826.5	836.5	846.5		
5	QPSK	1	0	22.31	22.44	22.41	24	0
5	QPSK	1	12	22.25	22.26	22.33		
5	QPSK	1	24	22.21	22.14	22.13		
5	QPSK	12	0	21.17	21.27	21.38	23	1
5	QPSK	12	7	21.09	21.17	21.25		
5	QPSK	12	13	21.24	21.13	21.18		
5	QPSK	25	0	21.25	21.23	21.28		
5	16QAM	1	0	21.54	21.56	21.63	23	1
5	16QAM	1	12	21.59	21.71	21.55		
5	16QAM	1	24	21.42	21.34	21.22		
5	16QAM	12	0	20.20	20.19	20.15	22	2
5	16QAM	12	7	20.25	20.32	20.21		
5	16QAM	12	13	20.18	20.27	20.27		
5	16QAM	25	0	20.17	20.12	20.17		
Channel				20415	20525	20635	Tune-up limit (dBm)	MPR (dB)
Frequency (MHz)				825.5	836.5	847.5		
3	QPSK	1	0	22.28	22.41	22.40	24	0
3	QPSK	1	8	22.13	22.18	22.21		
3	QPSK	1	14	22.17	22.30	22.24		
3	QPSK	8	0	21.22	21.24	21.28	23	1
3	QPSK	8	4	21.09	21.17	21.31		
3	QPSK	8	7	21.22	21.21	21.14		
3	QPSK	15	0	21.17	21.20	21.15		
3	16QAM	1	0	21.61	21.72	21.59	23	1
3	16QAM	1	8	21.56	21.68	21.47		
3	16QAM	1	14	21.33	21.25	21.20		
3	16QAM	8	0	20.25	20.24	20.15	22	2
3	16QAM	8	4	20.10	20.17	20.14		
3	16QAM	8	7	20.07	20.12	20.13		
3	16QAM	15	0	20.20	20.23	20.28		



Channel				20407	20525	20643	Tune-up limit (dBm)	MPR (dB)
Frequency (MHz)				824.7	836.5	848.3		
1.4	QPSK	1	0	22.28	22.42	22.40	24	0
1.4	QPSK	1	3	22.22	22.13	22.18		
1.4	QPSK	1	5	22.22	22.20	22.19		
1.4	QPSK	3	0	22.18	22.26	22.18		
1.4	QPSK	3	1	22.23	22.30	22.20		
1.4	QPSK	3	3	22.19	22.30	22.23		
1.4	QPSK	6	0	21.10	21.21	21.13	23	1
1.4	16QAM	1	0	21.52	21.67	21.46	23	1
1.4	16QAM	1	3	21.51	21.54	21.46		
1.4	16QAM	1	5	21.27	21.20	21.15		
1.4	16QAM	3	0	21.26	21.33	21.31		
1.4	16QAM	3	1	21.26	21.26	21.25		
1.4	16QAM	3	3	21.29	21.31	21.33		
1.4	16QAM	6	0	20.11	20.14	20.21	22	2





<LTE Band 7>

BW [MHz]	Modulation	RB Size	RB Offset	Power Low Ch. / Freq.	Power Middle Ch. / Freq.	Power High Ch. / Freq.	Tune-up limit (dBm)	MPR (dB)
Channel				20850	21100	21350		
Frequency (MHz)				2510	2535	2560		
20	QPSK	1	0	21.17	21.22	21.08	23	0
20	QPSK	1	49	21.11	21.15	21.03		
20	QPSK	1	99	21.10	21.13	21.02		
20	QPSK	50	0	20.19	20.20	20.09	22	1
20	QPSK	50	24	20.17	20.17	20.06		
20	QPSK	50	50	20.08	20.08	20.03		
20	QPSK	100	0	20.07	20.09	20.08		
20	16QAM	1	0	20.45	20.48	20.26	22	1
20	16QAM	1	49	20.39	20.38	20.20		
20	16QAM	1	99	20.04	20.02	20.03		
20	16QAM	50	0	19.23	19.26	19.12	21	2
20	16QAM	50	24	19.24	19.23	19.00		
20	16QAM	50	50	19.11	19.10	19.09		
20	16QAM	100	0	19.14	19.18	19.12		
Channel				20825	21100	21375		
Frequency (MHz)				2507.5	2535	2562.5		
15	QPSK	1	0	21.13	21.16	21.08	23	0
15	QPSK	1	37	21.06	21.15	21.06		
15	QPSK	1	74	21.03	21.09	21.04		
15	QPSK	36	0	20.13	20.18	20.01	22	1
15	QPSK	36	20	20.09	20.15	20.05		
15	QPSK	36	39	20.06	20.07	20.02		
15	QPSK	75	0	20.01	20.05	20.04		
15	16QAM	1	0	20.41	20.46	20.18	22	1
15	16QAM	1	37	20.37	20.38	20.13		
15	16QAM	1	74	20.06	20.05	20.01		
15	16QAM	36	0	19.16	19.17	19.02	21	2
15	16QAM	36	20	19.23	19.14	19.09		
15	16QAM	36	39	19.06	19.06	19.06		
15	16QAM	75	0	19.04	19.16	19.11		
Channel				20800	21100	21400		
Frequency (MHz)				2505	2535	2565		
10	QPSK	1	0	21.10	21.17	21.07	23	0
10	QPSK	1	25	21.03	21.14	21.00		
10	QPSK	1	49	21.06	21.06	21.00		
10	QPSK	25	0	20.10	20.19	20.01	22	1
10	QPSK	25	12	20.13	20.07	20.05		
10	QPSK	25	25	20.08	20.04	20.00		
10	QPSK	50	0	20.07	20.07	20.08		
10	16QAM	1	0	20.42	20.43	20.18	22	1
10	16QAM	1	25	20.36	20.35	20.11		
10	16QAM	1	49	20.05	20.09	20.07		
10	16QAM	25	0	19.20	19.21	19.02	21	2
10	16QAM	25	12	19.18	19.21	19.13		
10	16QAM	25	25	19.11	19.10	19.05		
10	16QAM	50	0	19.07	19.12	19.06		



Channel				20775	21100	21425	Tune-up limit (dBm)	MPR (dB)
Frequency (MHz)				2502.5	2535	2567.5		
5	QPSK	1	0	21.13	21.21	21.08	23	0
5	QPSK	1	12	21.10	21.13	21.07		
5	QPSK	1	24	21.04	21.08	21.04		
5	QPSK	12	0	20.15	20.17	20.06	22	1
5	QPSK	12	7	20.15	20.17	20.16		
5	QPSK	12	13	20.03	20.08	20.05		
5	QPSK	25	0	20.03	20.03	20.08		
5	16QAM	1	0	20.36	20.48	20.26	22	1
5	16QAM	1	12	20.29	20.28	20.14		
5	16QAM	1	24	20.08	20.09	20.07		
5	16QAM	12	0	19.17	19.16	19.06	21	2
5	16QAM	12	7	19.15	19.22	19.00		
5	16QAM	12	13	19.08	19.00	19.05		
5	16QAM	25	0	19.13	19.13	19.10		



<LTE Band 12>

BW [MHz]	Modulation	RB Size	RB Offset	Power Low Ch. / Freq.	Power Middle Ch. / Freq.	Power High Ch. / Freq.	Tune-up limit (dBm)	MPR (dB)
Channel				23060	23095	23130		
Frequency (MHz)				704	707.5	711		
10	QPSK	1	0	22.71	22.72	22.67	24	0
10	QPSK	1	25	22.33	22.38	22.27		
10	QPSK	1	49	22.32	22.38	22.17		
10	QPSK	25	0	21.33	21.38	21.26	23	1
10	QPSK	25	12	21.29	21.37	21.24		
10	QPSK	25	25	21.26	21.36	21.25		
10	QPSK	50	0	21.25	21.40	21.25		
10	16QAM	1	0	21.67	21.70	21.57	23	1
10	16QAM	1	25	21.63	21.65	21.56		
10	16QAM	1	49	21.59	21.54	21.49		
10	16QAM	25	0	20.28	20.29	20.34	22	2
10	16QAM	25	12	20.40	20.37	20.23		
10	16QAM	25	25	20.28	20.39	20.25		
10	16QAM	50	0	20.26	20.40	20.25		
Channel				23035	23095	23155	Tune-up limit (dBm)	MPR (dB)
Frequency (MHz)				701.5	707.5	713.5		
5	QPSK	1	0	22.37	22.39	22.28	24	0
5	QPSK	1	12	22.36	22.38	22.18		
5	QPSK	1	24	22.34	22.37	22.20		
5	QPSK	12	0	21.29	21.37	21.16	23	1
5	QPSK	12	7	21.29	21.36	21.24		
5	QPSK	12	13	21.33	21.41	21.24		
5	QPSK	25	0	21.30	21.42	21.20		
5	16QAM	1	0	21.65	21.76	21.52	23	1
5	16QAM	1	12	21.73	21.74	21.59		
5	16QAM	1	24	21.56	21.62	21.52		
5	16QAM	12	0	20.25	20.38	20.17	22	2
5	16QAM	12	7	20.24	20.31	20.24		
5	16QAM	12	13	20.30	20.40	20.26		
5	16QAM	25	0	20.32	20.31	20.18		
Channel				23025	23095	23165	Tune-up limit (dBm)	MPR (dB)
Frequency (MHz)				700.5	707.5	714.5		
3	QPSK	1	0	22.35	22.36	22.26	24	0
3	QPSK	1	8	22.34	22.34	22.17		
3	QPSK	1	14	22.27	22.30	22.16		
3	QPSK	8	0	21.34	21.39	21.24	23	1
3	QPSK	8	4	21.34	21.45	21.24		
3	QPSK	8	7	21.28	21.33	21.18		
3	QPSK	15	0	21.33	21.40	21.25		
3	16QAM	1	0	21.61	21.74	21.42	23	1
3	16QAM	1	8	21.72	21.67	21.64		
3	16QAM	1	14	21.52	21.56	21.44		
3	16QAM	8	0	20.45	20.42	20.32	22	2
3	16QAM	8	4	20.40	20.45	20.23		
3	16QAM	8	7	20.34	20.34	20.30		
3	16QAM	15	0	20.34	20.38	20.26		



Channel				23017	23095	23173	Tune-up limit (dBm)	MPR (dB)
Frequency (MHz)				699.7	707.5	715.3		
1.4	QPSK	1	0	22.38	22.39	22.29	24	0
1.4	QPSK	1	3	22.36	22.31	22.19		
1.4	QPSK	1	5	22.37	22.38	22.31		
1.4	QPSK	3	0	22.28	22.30	22.23		
1.4	QPSK	3	1	22.35	22.31	22.28		
1.4	QPSK	3	3	22.33	22.33	22.24		
1.4	QPSK	6	0	21.34	21.25	21.11	23	1
1.4	16QAM	1	0	21.73	21.82	21.61	23	1
1.4	16QAM	1	3	21.70	21.68	21.65		
1.4	16QAM	1	5	21.80	21.76	21.65		
1.4	16QAM	3	0	21.36	21.28	21.28		
1.4	16QAM	3	1	21.40	21.30	21.24		
1.4	16QAM	3	3	21.42	21.43	21.22		
1.4	16QAM	6	0	20.40	20.35	20.15	22	2



<LTE Band 13>

BW [MHz]	Modulation	RB Size	RB Offset	Power Low Ch. / Freq.	Power Middle Ch. / Freq.	Power High Ch. / Freq.	Tune-up limit (dBm)	MPR (dB)
Channel				23230				
Frequency (MHz)				782				
10	QPSK	1	0	22.22			24	0
10	QPSK	1	25	23.77				
10	QPSK	1	49	23.64				
10	QPSK	25	0	22.58			23	1
10	QPSK	25	12	22.55				
10	QPSK	25	25	22.48				
10	QPSK	50	0	22.53				
10	16QAM	1	0	21.45			23	1
10	16QAM	1	25	22.96				
10	16QAM	1	49	22.86				
10	16QAM	25	0	21.50			22	2
10	16QAM	25	12	21.51				
10	16QAM	25	25	21.49				
10	16QAM	50	0	21.43				
Channel				23205	23230	23255	Tune-up limit (dBm)	MPR (dB)
Frequency (MHz)				779.5	782	784.5		
5	QPSK	1	0	23.26	23.76	23.72	24	0
5	QPSK	1	12	23.30	23.62	23.59		
5	QPSK	1	24	23.74	23.75	23.71		
5	QPSK	12	0	22.58	22.74	22.96	23	1
5	QPSK	12	7	22.74	22.85	22.88		
5	QPSK	12	13	22.75	22.82	22.90		
5	QPSK	25	0	22.82	22.71	22.97		
5	16QAM	1	0	22.41	23.16	23.08	23	1
5	16QAM	1	12	22.92	22.96	22.92		
5	16QAM	1	24	23.00	23.00	23.04		
5	16QAM	12	0	21.43	21.72	21.97	22	2
5	16QAM	12	7	21.87	21.75	21.96		
5	16QAM	12	13	21.67	21.83	21.92		
5	16QAM	25	0	21.81	21.80	21.96		



<LTE Band 25>

BW [MHz]	Modulation	RB Size	RB Offset	Power Low Ch. / Freq.	Power Middle Ch. / Freq.	Power High Ch. / Freq.	Tune-up limit (dBm)	MPR (dB)
Channel				26140	26340	26590		
Frequency (MHz)				1860	1880	1905		
20	QPSK	1	0	23.17	23.37	23.29	24	0
20	QPSK	1	49	22.46	22.39	22.32		
20	QPSK	1	99	22.68	22.62	22.42		
20	QPSK	50	0	21.81	21.94	21.85	23	1
20	QPSK	50	24	21.69	21.50	21.47		
20	QPSK	50	50	21.52	21.50	21.36		
20	QPSK	100	0	21.59	21.74	21.66		
20	16QAM	1	0	22.43	22.66	22.47	23	1
20	16QAM	1	49	21.74	21.58	21.53		
20	16QAM	1	99	21.93	21.79	21.71		
20	16QAM	50	0	20.98	20.77	20.74	22	2
20	16QAM	50	24	20.64	20.54	20.44		
20	16QAM	50	50	20.48	20.49	20.37		
20	16QAM	100	0	20.74	20.62	20.65		
Channel				26115	26340	26615	Tune-up limit (dBm)	MPR (dB)
Frequency (MHz)				1857.5	1880	1907.5		
15	QPSK	1	0	23.29	23.36	23.30	24	0
15	QPSK	1	37	22.41	22.39	22.40		
15	QPSK	1	74	22.59	22.52	22.42		
15	QPSK	36	0	21.77	21.89	21.85	23	1
15	QPSK	36	20	21.66	21.43	21.43		
15	QPSK	36	39	21.47	21.43	21.43		
15	QPSK	75	0	21.58	21.64	21.62		
15	16QAM	1	0	22.34	22.50	22.45	23	1
15	16QAM	1	37	21.67	21.58	21.49		
15	16QAM	1	74	21.93	21.72	21.67		
15	16QAM	36	0	20.89	20.70	20.74	22	2
15	16QAM	36	20	20.54	20.53	20.41		
15	16QAM	36	39	20.38	20.47	20.36		
15	16QAM	75	0	20.69	20.58	20.59		
Channel				26090	26340	26640	Tune-up limit (dBm)	MPR (dB)
Frequency (MHz)				1855	1880	1910		
10	QPSK	1	0	23.16	23.36	23.21	24	0
10	QPSK	1	25	22.31	22.41	22.42		
10	QPSK	1	49	22.52	22.52	22.32		
10	QPSK	25	0	21.68	21.78	21.71	23	1
10	QPSK	25	12	21.62	21.34	21.35		
10	QPSK	25	25	21.39	21.49	21.50		
10	QPSK	50	0	21.58	21.56	21.65		
10	16QAM	1	0	22.35	22.59	22.37	23	1
10	16QAM	1	25	21.68	21.56	21.44		
10	16QAM	1	49	21.88	21.68	21.59		
10	16QAM	25	0	20.89	20.73	20.67	22	2
10	16QAM	25	12	20.51	20.53	20.53		
10	16QAM	25	25	20.45	20.48	20.44		
10	16QAM	50	0	20.55	20.45	20.54		



Channel				26065	26340	26665	Tune-up limit (dBm)	MPR (dB)
Frequency (MHz)				1852.5	1880	1912.5		
5	QPSK	1	0	23.14	23.27	23.15	24	0
5	QPSK	1	12	22.22	22.37	22.40		
5	QPSK	1	24	22.44	22.43	22.45		
5	QPSK	12	0	21.66	21.73	21.62	23	1
5	QPSK	12	7	21.59	21.67	21.67		
5	QPSK	12	13	21.29	21.48	21.41		
5	QPSK	25	0	21.51	21.56	21.61		
5	16QAM	1	0	22.35	22.56	22.27	23	1
5	16QAM	1	12	21.67	21.47	21.34		
5	16QAM	1	24	21.80	21.58	21.59		
5	16QAM	12	0	20.79	20.65	20.62	22	2
5	16QAM	12	7	20.47	20.51	20.43		
5	16QAM	12	13	20.42	20.44	20.42		
5	16QAM	25	0	20.48	20.42	20.54		
5	16QAM	25	0	20.48	20.42	20.54		
Channel				26055	26340	26675	Tune-up limit (dBm)	MPR (dB)
Frequency (MHz)				1851.5	1880	1913.5		
3	QPSK	1	0	23.09	23.25	23.14	24	0
3	QPSK	1	8	22.20	22.34	22.35		
3	QPSK	1	14	22.36	22.42	22.37		
3	QPSK	8	0	21.65	21.67	21.53	23	1
3	QPSK	8	4	21.54	21.63	21.64		
3	QPSK	8	7	21.27	21.45	21.39		
3	QPSK	15	0	21.50	21.51	21.54		
3	16QAM	1	0	22.32	22.47	22.22	23	1
3	16QAM	1	8	21.65	21.59	21.63		
3	16QAM	1	14	21.71	21.56	21.50		
3	16QAM	8	0	20.78	20.65	20.61	22	2
3	16QAM	8	4	20.37	20.43	20.36		
3	16QAM	8	7	20.37	20.38	20.39		
3	16QAM	8	7	20.37	20.38	20.39		
3	16QAM	15	0	20.48	20.40	20.44		
Channel				26047	26340	26683	Tune-up limit (dBm)	MPR (dB)
Frequency (MHz)				1850.7	1880	1914.3		
1.4	QPSK	1	0	23.04	23.23	23.00	24	0
1.4	QPSK	1	3	22.19	22.29	22.33		
1.4	QPSK	1	5	22.42	22.34	22.35		
1.4	QPSK	3	0	22.76	22.90	22.73		
1.4	QPSK	3	1	22.86	22.98	22.82		
1.4	QPSK	3	3	22.90	22.91	22.86		
1.4	QPSK	6	0	21.45	21.49	21.52	23	1
1.4	16QAM	1	0	22.14	22.29	22.23	23	1
1.4	16QAM	1	3	21.57	21.38	21.40		
1.4	16QAM	1	5	21.72	21.57	21.46		
1.4	16QAM	3	0	21.67	21.73	21.76		
1.4	16QAM	3	1	21.68	21.58	21.75		
1.4	16QAM	3	3	21.71	21.80	21.75		
1.4	16QAM	6	0	20.43	20.35	20.40		



<LTE Band 26>

BW [MHz]	Modulation	RB Size	RB Offset	Power Low Ch. / Freq.	Power Middle Ch. / Freq.	Power High Ch. / Freq.	Tune-up limit (dBm)	MPR (dB)
Channel				26765	26865	26965		
Frequency (MHz)				821.5	831.5	841.5		
15	QPSK	1	0	22.50	22.58	22.54		
15	QPSK	1	37	22.44	22.29	22.42	24	0
15	QPSK	1	74	22.38	22.23	22.32		
15	QPSK	36	0	21.52	21.55	21.54		
15	QPSK	36	20	21.50	21.43	21.53	23	1
15	QPSK	36	39	21.38	21.25	21.40		
15	QPSK	75	0	21.49	21.51	21.50		
15	16QAM	1	0	21.79	21.87	21.83	23	1
15	16QAM	1	37	21.73	21.59	21.68		
15	16QAM	1	74	21.63	21.49	21.60		
15	16QAM	36	0	20.53	20.47	20.51	22	2
15	16QAM	36	20	20.48	20.39	20.52		
15	16QAM	36	39	20.34	20.22	20.33		
15	16QAM	75	0	20.46	20.39	20.47		
Channel				26740	26865	26990		
Frequency (MHz)				819	831.5	844		
10	QPSK	1	0	22.57	22.57	22.55		
10	QPSK	1	25	22.39	22.25	22.40	24	0
10	QPSK	1	49	22.29	22.23	22.26		
10	QPSK	25	0	21.49	21.46	21.49		
10	QPSK	25	12	21.47	21.35	21.47	23	1
10	QPSK	25	25	21.35	21.20	21.39		
10	QPSK	50	0	21.45	21.44	21.51		
10	16QAM	1	0	21.74	21.87	21.83	23	1
10	16QAM	1	25	21.65	21.51	21.62		
10	16QAM	1	49	21.57	21.45	21.56		
10	16QAM	25	0	20.52	20.37	20.49	22	2
10	16QAM	25	12	20.38	20.31	20.43		
10	16QAM	25	25	20.34	20.12	20.27		
10	16QAM	50	0	20.45	20.29	20.41		
Channel				26715	26865	27015		
Frequency (MHz)				816.5	831.5	846.5		
5	QPSK	1	0	22.48	22.54	22.51		
5	QPSK	1	12	22.30	22.25	22.32	24	0
5	QPSK	1	24	22.24	22.15	22.17		
5	QPSK	12	0	21.42	21.42	21.49		
5	QPSK	12	7	21.41	21.28	21.46	23	1
5	QPSK	12	13	21.32	21.18	21.36		
5	QPSK	25	0	21.42	21.39	21.50		
5	16QAM	1	0	21.70	21.79	21.76	23	1
5	16QAM	1	12	21.56	21.51	21.62		
5	16QAM	1	24	21.49	21.44	21.49		
5	16QAM	12	0	20.49	20.29	20.42	22	2
5	16QAM	12	7	20.35	20.28	20.35		
5	16QAM	12	13	20.28	20.09	20.21		
5	16QAM	25	0	20.44	20.21	20.37		





Channel				26705	26865	27025	Tune-up limit (dBm)	MPR (dB)
Frequency (MHz)				815.5	831.5	847.5		
3	QPSK	1	0	22.43	22.48	22.45	24	0
3	QPSK	1	8	22.30	22.24	22.30		
3	QPSK	1	14	22.23	22.15	22.18		
3	QPSK	8	0	21.37	21.34	21.43	23	1
3	QPSK	8	4	21.34	21.24	21.38		
3	QPSK	8	7	21.28	21.10	21.31		
3	QPSK	15	0	21.35	21.31	21.40		
3	16QAM	1	0	21.69	21.77	21.73	23	1
3	16QAM	1	8	21.49	21.41	21.58		
3	16QAM	1	14	21.43	21.40	21.40		
3	16QAM	8	0	20.42	20.21	20.42	22	2
3	16QAM	8	4	20.26	20.27	20.30		
3	16QAM	8	7	20.26	20.26	20.21		
3	16QAM	15	0	20.43	20.19	20.29		
Channel				26697	26865	27033	Tune-up limit (dBm)	MPR (dB)
Frequency (MHz)				814.7	831.5	848.3		
1.4	QPSK	1	0	22.40	22.42	22.38	24	0
1.4	QPSK	1	3	22.21	22.21	22.23		
1.4	QPSK	1	5	22.14	22.10	22.13		
1.4	QPSK	3	0	22.33	22.32	22.39		
1.4	QPSK	3	1	22.27	22.14	22.34		
1.4	QPSK	3	3	22.26	22.08	22.21		
1.4	QPSK	6	0	21.33	21.24	21.31	23	1
1.4	16QAM	1	0	21.69	21.72	21.71	23	1
1.4	16QAM	1	3	21.42	21.34	21.49		
1.4	16QAM	1	5	21.39	21.34	21.35		
1.4	16QAM	3	0	21.35	21.18	21.40		
1.4	16QAM	3	1	21.23	21.17	21.25		
1.4	16QAM	3	3	21.20	21.25	21.20		
1.4	16QAM	6	0	20.33	20.10	20.29	22	2



**Reduced Power Mode**

**<LTE Band 2>**

BW [MHz]	Modulation	RB Size	RB Offset	Power Low Ch. / Freq.	Power Middle Ch. / Freq.	Power High Ch. / Freq.	Tune-up limit (dBm)	MPR (dB)		
Channel				18700	18900	19100				
Frequency (MHz)				1860	1880	1900				
20	QPSK	1	0	16.56	16.64	16.46	17.5	0		
20	QPSK	1	49	15.66	15.65	15.68				
20	QPSK	1	99	15.87	15.83	15.83				
20	QPSK	50	0	16.09	16.14	16.11	17.5	0		
20	QPSK	50	24	15.86	15.81	15.83				
20	QPSK	50	50	15.83	15.69	15.76				
20	QPSK	100	0	15.98	16.00	15.88	17.5	0		
20	16QAM	1	0	16.53	16.56	16.54				
20	16QAM	1	49	15.95	15.91	15.92				
20	16QAM	1	99	16.09	16.09	16.14	17.5	0		
20	16QAM	50	0	16.06	16.12	16.12				
20	16QAM	50	24	15.87	15.81	15.87				
20	16QAM	50	50	15.85	15.69	15.77	17.5	0		
20	16QAM	100	0	15.98	15.90	16.03				
Channel				18675	18900	19125			Tune-up limit (dBm)	MPR (dB)
Frequency (MHz)				1857.5	1880	1902.5				
15	QPSK	1	0	16.26	16.39	16.32				
15	QPSK	1	37	15.97	15.89	15.82	17.5	0		
15	QPSK	1	74	15.80	15.71	15.76				
15	QPSK	36	0	16.00	16.06	15.97				
15	QPSK	36	20	15.82	15.81	15.84	17.5	0		
15	QPSK	36	39	15.78	15.68	15.80				
15	QPSK	75	0	15.86	15.83	15.81				
15	16QAM	1	0	16.51	16.53	16.52	17.5	0		
15	16QAM	1	37	16.02	15.97	16.08				
15	16QAM	1	74	16.07	15.93	16.03				
15	16QAM	36	0	16.01	16.07	15.95	17.5	0		
15	16QAM	36	20	15.82	15.82	15.85				
15	16QAM	36	39	15.81	15.66	15.79				
15	16QAM	75	0	15.88	15.88	15.84	17.5	0		
Channel				18650	18900	19150			Tune-up limit (dBm)	MPR (dB)
Frequency (MHz)				1855	1880	1905				
10	QPSK	1	0	16.18	16.21	16.18				
10	QPSK	1	25	15.88	15.83	15.97	17.5	0		
10	QPSK	1	49	15.84	15.73	15.82				
10	QPSK	25	0	16.02	16.01	15.94				
10	QPSK	25	12	15.91	15.84	15.93	17.5	0		
10	QPSK	25	25	15.87	15.77	15.79				
10	QPSK	50	0	15.84	15.92	15.85				
10	16QAM	1	0	16.44	16.46	16.41	17.5	0		
10	16QAM	1	25	16.13	16.09	16.18				
10	16QAM	1	49	16.12	15.98	16.11				
10	16QAM	25	0	16.04	16.05	15.92	17.5	0		
10	16QAM	25	12	15.93	15.86	15.92				
10	16QAM	25	25	15.89	15.78	15.80				
10	16QAM	50	0	15.86	15.93	15.86	17.5	0		
Channel				18650	18900	19150			Tune-up limit (dBm)	MPR (dB)
Frequency (MHz)				1855	1880	1905				
10	QPSK	1	0	16.18	16.21	16.18				
10	QPSK	1	25	15.88	15.83	15.97	17.5	0		
10	QPSK	1	49	15.84	15.73	15.82				
10	QPSK	25	0	16.02	16.01	15.94				
10	QPSK	25	12	15.91	15.84	15.93	17.5	0		
10	QPSK	25	25	15.87	15.77	15.79				
10	QPSK	50	0	15.84	15.92	15.85				
10	16QAM	1	0	16.44	16.46	16.41	17.5	0		
10	16QAM	1	25	16.13	16.09	16.18				
10	16QAM	1	49	16.12	15.98	16.11				
10	16QAM	25	0	16.04	16.05	15.92	17.5	0		
10	16QAM	25	12	15.93	15.86	15.92				
10	16QAM	25	25	15.89	15.78	15.80				
10	16QAM	50	0	15.86	15.93	15.86	17.5	0		
Channel				18650	18900	19150			Tune-up limit (dBm)	MPR (dB)
Frequency (MHz)				1855	1880	1905				
10	QPSK	1	0	16.18	16.21	16.18				
10	QPSK	1	25	15.88	15.83	15.97	17.5	0		
10	QPSK	1	49	15.84	15.73	15.82				
10	QPSK	25	0	16.02	16.01	15.94				
10	QPSK	25	12	15.91	15.84	15.93	17.5	0		
10	QPSK	25	25	15.87	15.77	15.79				
10	QPSK	50	0	15.84	15.92	15.85				
10	16QAM	1	0	16.44	16.46	16.41	17.5	0		
10	16QAM	1	25	16.13	16.09	16.18				
10	16QAM	1	49	16.12	15.98	16.11				
10	16QAM	25	0	16.04	16.05	15.92	17.5	0		
10	16QAM	25	12	15.93	15.86	15.92				
10	16QAM	25	25	15.89	15.78	15.80				
10	16QAM	50	0	15.86	15.93	15.86	17.5	0		
Channel				18650	18900	19150			Tune-up limit (dBm)	MPR (dB)
Frequency (MHz)				1855	1880	1905				
10	QPSK	1	0	16.18	16.21	16.18				
10	QPSK	1	25	15.88	15.83	15.97	17.5	0		
10	QPSK	1	49	15.84	15.73	15.82				
10	QPSK	25	0	16.02	16.01	15.94				
10	QPSK	25	12	15.91	15.84	15.93	17.5	0		
10	QPSK	25	25	15.87	15.77	15.79				
10	QPSK	50	0	15.84	15.92	15.85				
10	16QAM	1	0	16.44	16.46	16.41	17.5	0		
10	16QAM	1	25	16.13	16.09	16.18				
10	16QAM	1	49	16.12	15.98	16.11				
10	16QAM	25	0	16.04	16.05	15.92	17.5	0		
10	16QAM	25	12	15.93	15.86	15.92				
10	16QAM	25	25	15.89	15.78	15.80				
10	16QAM	50	0	15.86	15.93	15.86	17.5	0		
Channel				18650	18900	19150			Tune-up limit (dBm)	MPR (dB)
Frequency (MHz)				1855	1880	1905				
10	QPSK	1	0	16.18	16.21	16.18				
10	QPSK	1	25	15.88	15.83	15.97	17.5	0		
10	QPSK	1	49	15.84	15.73	15.82				
10	QPSK	25	0	16.02	16.01	15.94				
10	QPSK	25	12	15.91	15.84	15.93	17.5	0		
10	QPSK	25	25	15.87	15.77	15.79				
10	QPSK	50	0	15.84	15.92	15.85				
10	16QAM	1	0	16.44	16.46	16.41	17.5	0		
10	16QAM	1	25	16.13	16.09	16.18				
10	16QAM	1	49	16.12	15.98	16.11				
10	16QAM	25	0	16.04	16.05	15.92	17.5	0		
10	16QAM	25	12	15.93	15.86	15.92				
10	16QAM	25	25	15.89	15.78	15.80				
10	16QAM	50	0	15.86	15.93	15.86	17.5	0		
Channel				18650	18900	19150			Tune-up limit (dBm)	MPR (dB)
Frequency (MHz)				1855	1880	1905				
10	QPSK	1	0	16.18	16.21	16.18				
10	QPSK	1	25	15.88	15.83	15.97	17.5	0		
10	QPSK	1	49	15.84	15.73	15.82				
10	QPSK	25	0	16.02	16.01	15.94				
10	QPSK	25	12	15.91	15.84	15.93	17.5	0		
10	QPSK	25	25	15.87	15.77	15.79				
10	QPSK	50	0	15.84	15.92	15.85				
10	16QAM	1	0	16.44	16.46	16.41	17.5	0		
10	16QAM	1	25	16.13	16.09	16.18				
10	16QAM	1	49	16.12	15.98	16.11				
10	16QAM	25	0	16.04	16.05	15.92	17.5	0		
10	16QAM	25	12	15.93	15.86	15.92				
10	16QAM	25	25	15.89	15.78	15.80				
10	16QAM	50	0	15.86	15.93	15.86	17.5	0		
Channel				18650	18900	19150			Tune-up limit (dBm)	MPR (dB)
Frequency (MHz)				1855	1880	1905				
10	QPSK	1	0	16.18	16.21	16.18				
10	QPSK	1	25	15.88	15.83	15.97	17.5	0		
10	QPSK	1	49	15.84	15.73	15.82				
10	QPSK	25	0	16.02	16.01	15.94				
10	QPSK	25	12	15.91	15.84	15.93	17.5	0		
10	QPSK	25	25	15.87	15.77	15.79				
10	QPSK	50	0	15.84	15.92	15.85				
10	16QAM	1	0	16.44	16.46	16.41	17.5	0		
10	16QAM	1	25	16.13	16.09	16.18				
10	16QAM	1	49	16.12	15.98	16.11				
10	16QAM	25	0	16.04	16.05	15.92	17.5	0		
10	16QAM	25	12	15.93	15.86	15.92				
10	16QAM	25	25	15.89	15.78	15.80				
10	16QAM	50	0	15.86	15.93	15.86	17.5	0		
Channel				18650	18900	19150			Tune-up limit (dBm)	MPR (dB)
Frequency (MHz)				1855	1880	1905				
10	QPSK	1	0	16.18	16.21	16.18				
10	QPSK	1	25	15.88	15.83	15.97	17.5	0		
10	QPSK	1	49	15.84	15.73	15.82				
10	QPSK	25	0	16.02	16.01	15.94				
10	QPSK	25	12	15.91	15.84	15.93	17.5	0		
10	QPSK	25	25	15.87	15.77	15.				



Channel				18625	18900	19175	Tune-up limit (dBm)	MPR (dB)
Frequency (MHz)				1852.5	1880	1907.5		
5	QPSK	1	0	15.98	15.99	15.92	17.5	0
5	QPSK	1	12	15.83	15.85	15.95		
5	QPSK	1	24	15.78	15.68	15.85		
5	QPSK	12	0	15.86	15.95	15.88	17.5	0
5	QPSK	12	7	15.88	15.88	15.88		
5	QPSK	12	13	15.92	15.85	15.87		
5	QPSK	25	0	15.90	15.84	15.87		
5	16QAM	1	0	16.26	16.33	16.19	17.5	0
5	16QAM	1	12	16.15	16.17	16.18		
5	16QAM	1	24	16.04	16.02	16.12		
5	16QAM	12	0	15.88	15.96	15.90	17.5	0
5	16QAM	12	7	15.92	15.93	15.94		
5	16QAM	12	13	15.95	15.85	15.90		
5	16QAM	25	0	15.92	15.89	15.88		
Channel				18615	18900	19185	Tune-up limit (dBm)	MPR (dB)
Frequency (MHz)				1851.5	1880	1908.5		
3	QPSK	1	0	15.95	15.99	15.90	17.5	0
3	QPSK	1	8	15.86	15.98	15.83		
3	QPSK	1	14	15.83	15.85	15.87		
3	QPSK	8	0	15.91	15.91	15.89	17.5	0
3	QPSK	8	4	15.91	15.95	15.93		
3	QPSK	8	7	15.90	15.88	15.87		
3	QPSK	15	0	15.88	15.90	15.86		
3	16QAM	1	0	16.26	16.28	16.27	17.5	0
3	16QAM	1	8	16.25	16.26	16.26		
3	16QAM	1	14	16.03	16.04	16.05		
3	16QAM	8	0	15.98	15.98	15.96	17.5	0
3	16QAM	8	4	15.96	16.00	15.95		
3	16QAM	8	7	15.99	15.97	15.92		
3	16QAM	15	0	15.91	15.94	15.93		
Channel				18607	18900	19193	Tune-up limit (dBm)	MPR (dB)
Frequency (MHz)				1850.7	1880	1909.3		
1.4	QPSK	1	0	15.95	16.02	15.97	17.5	0
1.4	QPSK	1	3	15.89	15.94	15.91		
1.4	QPSK	1	5	15.85	15.87	15.93		
1.4	QPSK	3	0	15.77	15.81	15.80		
1.4	QPSK	3	1	15.85	15.90	15.85		
1.4	QPSK	3	3	15.88	15.89	15.89		
1.4	QPSK	6	0	15.82	15.83	15.83	17.5	0
1.4	16QAM	1	0	16.22	16.23	16.15	17.5	0
1.4	16QAM	1	3	16.18	16.22	16.17		
1.4	16QAM	1	5	16.11	16.18	16.14		
1.4	16QAM	3	0	15.83	15.92	15.88		
1.4	16QAM	3	1	15.88	15.94	15.90		
1.4	16QAM	3	3	15.97	16.00	15.97		
1.4	16QAM	6	0	15.95	15.93	15.91	17.5	0



<LTE Band 4>

BW [MHz]	Modulation	RB Size	RB Offset	Power Low Ch. / Freq.	Power Middle Ch. / Freq.	Power High Ch. / Freq.	Tune-up limit (dBm)	MPR (dB)
Channel				20050	20175	20300		
Frequency (MHz)				1720	1732.5	1745		
20	QPSK	1	0	16.46	16.61	16.46	17.5	0
20	QPSK	1	49	15.71	15.65	15.68		
20	QPSK	1	99	15.92	15.89	15.78		
20	QPSK	50	0	16.09	16.30	16.12	17.5	0
20	QPSK	50	24	15.76	15.82	15.80		
20	QPSK	50	50	15.78	15.69	15.69		
20	QPSK	100	0	15.86	16.25	15.92		
20	16QAM	1	0	16.55	16.58	16.53	17.5	0
20	16QAM	1	49	16.01	15.97	15.98		
20	16QAM	1	99	16.23	16.15	16.10		
20	16QAM	50	0	16.01	16.15	16.09	17.5	0
20	16QAM	50	24	15.72	15.81	15.81		
20	16QAM	50	50	15.76	15.66	15.70		
20	16QAM	100	0	15.88	15.97	15.99		
Channel				20025	20175	20325		
Frequency (MHz)				1717.5	1732.5	1747.5		
15	QPSK	1	0	16.23	16.29	16.25	17.5	0
15	QPSK	1	37	15.73	15.70	15.68		
15	QPSK	1	74	15.72	15.82	15.72		
15	QPSK	36	0	15.88	15.92	15.97	17.5	0
15	QPSK	36	20	15.77	15.79	15.80		
15	QPSK	36	39	15.72	15.72	15.76		
15	QPSK	75	0	15.83	15.84	15.92		
15	16QAM	1	0	16.52	16.59	16.50	17.5	0
15	16QAM	1	37	15.90	15.91	15.99		
15	16QAM	1	74	15.96	16.07	15.98		
15	16QAM	36	0	15.89	15.91	15.94	17.5	0
15	16QAM	36	20	15.74	15.81	15.81		
15	16QAM	36	39	15.75	15.70	15.75		
15	16QAM	75	0	15.87	15.89	15.95		
Channel				20000	20175	20350		
Frequency (MHz)				1715	1732.5	1750		
10	QPSK	1	0	15.89	16.04	15.92	17.5	0
10	QPSK	1	25	15.88	15.77	15.78		
10	QPSK	1	49	15.63	15.57	15.57		
10	QPSK	25	0	15.88	15.65	15.79	17.5	0
10	QPSK	25	12	15.80	15.68	15.80		
10	QPSK	25	25	15.61	15.60	15.67		
10	QPSK	50	0	15.80	15.68	15.68		
10	16QAM	1	0	16.20	16.29	16.19	17.5	0
10	16QAM	1	25	16.12	15.93	15.96		
10	16QAM	1	49	15.89	15.79	15.85		
10	16QAM	25	0	15.88	15.69	15.82	17.5	0
10	16QAM	25	12	15.82	15.69	15.80		
10	16QAM	25	25	15.64	15.65	15.70		
10	16QAM	50	0	15.80	15.68	15.70		



Channel				19975	20175	20375	Tune-up limit (dBm)	MPR (dB)
Frequency (MHz)				1712.5	1732.5	1752.5		
5	QPSK	1	0	15.77	15.86	15.79	17.5	0
5	QPSK	1	12	15.68	15.76	15.74		
5	QPSK	1	24	15.75	15.62	15.65		
5	QPSK	12	0	15.74	15.73	15.74	17.5	0
5	QPSK	12	7	15.81	15.78	15.68		
5	QPSK	12	13	15.73	15.72	15.68		
5	QPSK	25	0	15.77	15.76	15.56		
5	16QAM	1	0	16.07	16.15	16.04	17.5	0
5	16QAM	1	12	16.06	16.13	16.02		
5	16QAM	1	24	16.02	15.95	15.96		
5	16QAM	12	0	15.76	15.75	15.76	17.5	0
5	16QAM	12	7	15.79	15.77	15.70		
5	16QAM	12	13	15.74	15.68	15.69		
5	16QAM	25	0	15.77	15.78	15.58		
5	16QAM	25	0	15.77	15.78	15.58		
Channel				19965	20175	20385	Tune-up limit (dBm)	MPR (dB)
Frequency (MHz)				1711.5	1732.5	1753.5		
3	QPSK	1	0	15.71	15.91	15.72	17.5	0
3	QPSK	1	8	15.83	15.74	15.69		
3	QPSK	1	14	15.72	15.53	15.61		
3	QPSK	8	0	15.75	15.65	15.71	17.5	0
3	QPSK	8	4	15.84	15.65	15.62		
3	QPSK	8	7	15.79	15.57	15.64		
3	QPSK	15	0	15.81	15.63	15.68		
3	16QAM	1	0	15.91	16.13	15.94		
3	16QAM	1	8	16.12	16.00	16.08	17.5	0
3	16QAM	1	14	15.93	15.75	15.78		
3	16QAM	8	0	15.81	15.72	15.76		
3	16QAM	8	4	15.91	15.69	15.68	17.5	0
3	16QAM	8	7	15.84	15.65	15.72		
3	16QAM	8	7	15.84	15.65	15.72		
3	16QAM	15	0	15.82	15.64	15.72		
Channel				19957	20175	20393	Tune-up limit (dBm)	MPR (dB)
Frequency (MHz)				1710.7	1732.5	1754.3		
1.4	QPSK	1	0	15.75	15.78	15.74	17.5	0
1.4	QPSK	1	3	15.73	15.66	15.68		
1.4	QPSK	1	5	15.67	15.62	15.57		
1.4	QPSK	3	0	15.69	15.55	15.61		
1.4	QPSK	3	1	15.76	15.59	15.70		
1.4	QPSK	3	3	15.74	15.62	15.70		
1.4	QPSK	6	0	15.62	15.57	15.62	17.5	0
1.4	16QAM	1	0	15.93	16.04	16.02	17.5	0
1.4	16QAM	1	3	15.96	15.88	16.01		
1.4	16QAM	1	5	15.95	15.90	15.89		
1.4	16QAM	3	0	15.74	15.68	15.65		
1.4	16QAM	3	1	15.77	15.63	15.68		
1.4	16QAM	3	3	15.80	15.68	15.75		
1.4	16QAM	6	0	15.74	15.66	15.72		



<LTE Band 5>

BW [MHz]	Modulation	RB Size	RB Offset	Power Low Ch. / Freq.	Power Middle Ch. / Freq.	Power High Ch. / Freq.	Tune-up limit (dBm)	MPR (dB)
Channel				20450	20525	20600		
Frequency (MHz)				829	836.5	844		
10	QPSK	1	0	20.02	20.12	19.95	21	0
10	QPSK	1	25	19.97	20.00	19.93		
10	QPSK	1	49	19.79	19.92	19.84		
10	QPSK	25	0	19.95	20.03	19.87	21	0
10	QPSK	25	12	19.89	20.02	19.85		
10	QPSK	25	25	19.78	19.94	19.84		
10	QPSK	50	0	19.91	20.05	19.86		
10	16QAM	1	0	20.02	20.04	19.95	21	0
10	16QAM	1	25	19.95	19.91	20.01		
10	16QAM	1	49	19.85	19.84	19.96	21	0
10	16QAM	25	0	19.92	19.94	19.89		
10	16QAM	25	12	19.95	20.03	19.88		
10	16QAM	25	25	19.80	19.99	19.84		
10	16QAM	50	0	19.90	19.84	19.88		
Channel				20425	20525	20625	Tune-up limit (dBm)	MPR (dB)
Frequency (MHz)				826.5	836.5	846.5		
5	QPSK	1	0	19.98	20.09	19.92	21	0
5	QPSK	1	12	19.91	19.99	19.87		
5	QPSK	1	24	19.96	20.01	19.83		
5	QPSK	12	0	19.87	19.97	19.87	21	0
5	QPSK	12	7	19.86	19.89	19.90		
5	QPSK	12	13	19.94	20.00	19.87		
5	QPSK	25	0	19.85	20.04	19.85		
5	16QAM	1	0	20.04	20.11	20.00	21	0
5	16QAM	1	12	20.02	20.03	19.98		
5	16QAM	1	24	19.82	19.81	19.92		
5	16QAM	12	0	19.95	20.03	19.91	21	0
5	16QAM	12	7	19.90	19.82	19.92		
5	16QAM	12	13	19.93	20.07	19.89		
5	16QAM	25	0	19.89	20.00	19.87		
Channel				20415	20525	20635	Tune-up limit (dBm)	MPR (dB)
Frequency (MHz)				825.5	836.5	847.5		
3	QPSK	1	0	19.98	20.04	19.91	21	0
3	QPSK	1	8	19.72	19.96	19.82		
3	QPSK	1	14	19.93	19.98	19.88		
3	QPSK	8	0	19.86	20.01	19.82	21	0
3	QPSK	8	4	19.91	20.03	19.91		
3	QPSK	8	7	19.83	19.86	19.78		
3	QPSK	15	0	19.91	20.00	19.86		
3	16QAM	1	0	19.95	20.05	20.03	21	0
3	16QAM	1	8	20.03	20.02	19.96		
3	16QAM	1	14	19.95	19.91	19.96		
3	16QAM	8	0	19.95	20.04	19.89	21	0
3	16QAM	8	4	19.95	19.85	19.96		
3	16QAM	8	7	19.91	19.82	19.83		
3	16QAM	15	0	19.93	20.03	19.91		



Channel				20407	20525	20643	Tune-up limit (dBm)	MPR (dB)
Frequency (MHz)				824.7	836.5	848.3		
1.4	QPSK	1	0	20.05	20.11	20.05	21	0
1.4	QPSK	1	3	19.98	20.09	19.98		
1.4	QPSK	1	5	20.01	20.07	19.89		
1.4	QPSK	3	0	19.83	19.98	19.82		
1.4	QPSK	3	1	19.87	20.05	19.88		
1.4	QPSK	3	3	19.88	20.10	19.89		
1.4	QPSK	6	0	19.81	19.98	19.82	21	0
1.4	16QAM	1	0	19.97	20.02	19.98	21	0
1.4	16QAM	1	3	19.85	20.01	19.85		
1.4	16QAM	1	5	19.91	19.97	19.91		
1.4	16QAM	3	0	19.94	19.92	19.94		
1.4	16QAM	3	1	19.92	19.93	19.90		
1.4	16QAM	3	3	19.99	19.87	19.98		
1.4	16QAM	6	0	19.92	19.70	19.92	21	0



<LTE Band 7>

BW [MHz]	Modulation	RB Size	RB Offset	Power Low Ch. / Freq.	Power Middle Ch. / Freq.	Power High Ch. / Freq.	Tune-up limit (dBm)	MPR (dB)
Channel				20850	21100	21350		
Frequency (MHz)				2510	2535	2560		
20	QPSK	1	0	17.36	17.62	17.40	18	0
20	QPSK	1	49	17.20	17.47	17.05		
20	QPSK	1	99	17.03	16.90	16.75		
20	QPSK	50	0	17.41	17.50	17.13	18	0
20	QPSK	50	24	17.37	17.45	17.11		
20	QPSK	50	50	17.31	17.34	17.04		
20	QPSK	100	0	17.33	17.38	17.03		
20	16QAM	1	0	17.46	17.59	17.35	18	0
20	16QAM	1	49	17.53	17.56	17.43		
20	16QAM	1	99	17.28	17.14	17.02		
20	16QAM	50	0	17.42	17.52	17.13	18	0
20	16QAM	50	24	17.38	17.51	17.12		
20	16QAM	50	50	17.29	17.34	17.07		
20	16QAM	100	0	17.37	17.38	17.00		
Channel				20825	21100	21375		
Frequency (MHz)				2507.5	2535	2562.5		
15	QPSK	1	0	17.29	17.56	17.09	18	0
15	QPSK	1	37	17.46	17.46	17.24		
15	QPSK	1	74	17.18	17.17	16.93		
15	QPSK	36	0	17.43	17.52	17.12	18	0
15	QPSK	36	20	17.44	17.52	17.11		
15	QPSK	36	39	17.31	17.36	17.09		
15	QPSK	75	0	17.34	17.47	17.05		
15	16QAM	1	0	17.46	17.54	17.39	18	0
15	16QAM	1	37	17.44	17.50	17.36		
15	16QAM	1	74	17.47	17.44	17.19		
15	16QAM	36	0	17.45	17.52	17.11	18	0
15	16QAM	36	20	17.48	17.44	17.12		
15	16QAM	36	39	17.32	17.38	17.11		
15	16QAM	75	0	17.40	17.45	17.07		
Channel				20800	21100	21400		
Frequency (MHz)				2505	2535	2565		
10	QPSK	1	0	17.30	17.59	17.09	18	0
10	QPSK	1	25	17.42	17.47	17.22		
10	QPSK	1	49	17.30	17.23	16.99		
10	QPSK	25	0	17.34	17.45	17.08	18	0
10	QPSK	25	12	17.44	17.55	17.18		
10	QPSK	25	25	17.25	17.45	17.11		
10	QPSK	50	0	17.36	17.39	17.12		
10	16QAM	1	0	17.52	17.60	17.42	18	0
10	16QAM	1	25	17.59	17.59	17.55		
10	16QAM	1	49	17.57	17.57	17.34		
10	16QAM	25	0	17.34	17.47	17.07	18	0
10	16QAM	25	12	17.42	17.59	17.18		
10	16QAM	25	25	17.28	17.49	17.14		
10	16QAM	50	0	17.34	17.41	17.13		





Channel				20775	21100	21425	Tune-up limit (dBm)	MPR (dB)
Frequency (MHz)				2502.5	2535	2567.5		
5	QPSK	1	0	17.28	17.56	17.20	18	0
5	QPSK	1	12	17.24	17.52	17.21		
5	QPSK	1	24	17.32	17.43	17.18		
5	QPSK	12	0	17.25	17.52	17.14	18	0
5	QPSK	12	7	17.31	17.55	17.20		
5	QPSK	12	13	17.36	17.53	17.18		
5	QPSK	25	0	17.26	17.52	17.16		
5	16QAM	1	0	17.57	17.59	17.47	18	0
5	16QAM	1	12	17.47	17.52	17.58		
5	16QAM	1	24	17.58	17.49	17.49		
5	16QAM	12	0	17.30	17.42	17.22	18	0
5	16QAM	12	7	17.31	17.40	17.27		
5	16QAM	12	13	17.33	17.57	17.22		
5	16QAM	25	0	17.29	17.55	17.18		



<LTE Band 12>

BW [MHz]	Modulation	RB Size	RB Offset	Power Low Ch. / Freq.	Power Middle Ch. / Freq.	Power High Ch. / Freq.	Tune-up limit (dBm)	MPR (dB)
Channel				23060	23095	23130		
Frequency (MHz)				704	707.5	711		
10	QPSK	1	0	19.26	19.28	19.26		
10	QPSK	1	25	19.17	19.16	19.21	20.5	0
10	QPSK	1	49	19.07	19.24	19.10		
10	QPSK	25	0	19.14	19.19	19.17		
10	QPSK	25	12	19.05	19.15	19.08	20.5	0
10	QPSK	25	25	18.85	19.08	19.07		
10	QPSK	50	0	19.12	19.20	19.10		
10	16QAM	1	0	19.13	19.18	19.17	20.5	0
10	16QAM	1	25	19.13	19.05	19.15		
10	16QAM	1	49	18.94	18.92	18.99		
10	16QAM	25	0	18.98	19.14	19.12	20.5	0
10	16QAM	25	12	19.15	19.16	19.15		
10	16QAM	25	25	18.92	19.12	19.06		
10	16QAM	50	0	18.89	19.13	19.11		
Channel				23035	23095	23155	Tune-up limit (dBm)	MPR (dB)
Frequency (MHz)				701.5	707.5	713.5		
5	QPSK	1	0	19.17	19.27	19.18	20.5	0
5	QPSK	1	12	19.26	19.21	19.09		
5	QPSK	1	24	19.26	19.13	19.10		
5	QPSK	12	0	19.17	19.26	19.05	20.5	0
5	QPSK	12	7	19.01	19.11	19.08		
5	QPSK	12	13	19.22	19.13	19.10		
5	QPSK	25	0	19.25	19.11	19.12	20.5	0
5	16QAM	1	0	19.21	19.24	19.23		
5	16QAM	1	12	19.14	19.19	19.13		
5	16QAM	1	24	19.02	19.05	19.09	20.5	0
5	16QAM	12	0	19.13	19.10	19.07		
5	16QAM	12	7	19.22	19.13	19.10		
5	16QAM	12	13	19.19	19.14	19.11	20.5	0
5	16QAM	12	13	19.19	19.14	19.11		
5	16QAM	25	0	19.16	19.13	19.07		
Channel				23025	23095	23165	Tune-up limit (dBm)	MPR (dB)
Frequency (MHz)				700.5	707.5	714.5		
3	QPSK	1	0	19.24	19.25	19.01	20.5	0
3	QPSK	1	8	19.06	19.13	19.07		
3	QPSK	1	14	19.17	19.09	19.06		
3	QPSK	8	0	19.18	19.15	19.15	20.5	0
3	QPSK	8	4	19.23	19.21	19.12		
3	QPSK	8	7	19.15	19.08	19.10		
3	QPSK	15	0	19.23	19.16	19.13	20.5	0
3	16QAM	1	0	19.12	19.17	19.11		
3	16QAM	1	8	19.07	19.05	19.03		
3	16QAM	1	14	18.92	18.94	18.92	20.5	0
3	16QAM	8	0	18.89	18.84	18.98		
3	16QAM	8	4	18.79	18.76	19.09		
3	16QAM	8	7	19.12	19.16	19.11	20.5	0
3	16QAM	15	0	19.04	18.87	19.10		



Channel				23017	23095	23173	Tune-up limit (dBm)	MPR (dB)
Frequency (MHz)				699.7	707.5	715.3		
1.4	QPSK	1	0	19.25	19.26	19.21	20.5	0
1.4	QPSK	1	3	19.18	19.21	19.18		
1.4	QPSK	1	5	19.19	19.21	19.17		
1.4	QPSK	3	0	19.17	19.03	19.04		
1.4	QPSK	3	1	19.20	19.11	19.11		
1.4	QPSK	3	3	19.20	19.19	19.16		
1.4	QPSK	6	0	19.16	19.01	18.98	20.5	0
1.4	16QAM	1	0	19.05	19.11	19.03	20.5	0
1.4	16QAM	1	3	19.09	19.00	19.03		
1.4	16QAM	1	5	19.07	18.98	19.04		
1.4	16QAM	3	0	19.08	19.02	19.05		
1.4	16QAM	3	1	19.04	18.92	19.10		
1.4	16QAM	3	3	19.09	19.06	19.03		
1.4	16QAM	6	0	18.94	18.95	19.10	20.5	0



<LTE Band 13>

BW [MHz]	Modulation	RB Size	RB Offset	Power Low Ch. / Freq.	Power Middle Ch. / Freq.	Power High Ch. / Freq.	Tune-up limit (dBm)	MPR (dB)
Channel				23230				
Frequency (MHz)				782				
10	QPSK	1	0	19.84			21	0
10	QPSK	1	25	19.83				
10	QPSK	1	49	19.82				
10	QPSK	25	0	19.83			21	0
10	QPSK	25	12	19.73				
10	QPSK	25	25	19.67				
10	QPSK	50	0	19.81				
10	16QAM	1	0	19.44			21	0
10	16QAM	1	25	20.11				
10	16QAM	1	49	20.03				
10	16QAM	25	0	19.93			21	0
10	16QAM	25	12	19.87				
10	16QAM	25	25	19.79				
10	16QAM	50	0	19.88				
Channel				23205	23230	23255	Tune-up limit (dBm)	MPR (dB)
Frequency (MHz)				779.5	782	784.5		
5	QPSK	1	0	19.76	19.82	19.75	21	0
5	QPSK	1	12	19.71	19.70	19.74		
5	QPSK	1	24	19.64	19.77	19.76		
5	QPSK	12	0	19.77	19.78	19.78	21	0
5	QPSK	12	7	19.72	19.64	19.73		
5	QPSK	12	13	19.75	19.74	19.61		
5	QPSK	25	0	19.79	19.74	19.76		
5	16QAM	1	0	19.22	19.80	19.74	21	0
5	16QAM	1	12	19.63	19.62	19.67		
5	16QAM	1	24	19.57	19.57	19.51		
5	16QAM	12	0	19.64	19.77	19.79	21	0
5	16QAM	12	7	19.69	19.71	19.78		
5	16QAM	12	13	19.61	19.78	19.76		
5	16QAM	25	0	19.64	19.79	19.70		



<LTE Band 25>

BW [MHz]	Modulation	RB Size	RB Offset	Power Low Ch. / Freq.	Power Middle Ch. / Freq.	Power High Ch. / Freq.	Tune-up limit (dBm)	MPR (dB)
Channel				26140	26340	26590		
Frequency (MHz)				1860	1880	1905		
20	QPSK	1	0	16.59	16.74	16.64	17.5	0
20	QPSK	1	49	15.82	15.73	15.75		
20	QPSK	1	99	15.76	15.91	15.88		
20	QPSK	50	0	16.44	16.50	16.49	17.5	0
20	QPSK	50	24	15.84	15.90	15.86		
20	QPSK	50	50	15.69	15.80	15.80		
20	QPSK	100	0	15.82	16.55	15.94		
20	16QAM	1	0	16.67	16.69	16.68	17.5	0
20	16QAM	1	49	16.06	15.91	15.84		
20	16QAM	1	99	15.98	16.05	16.15		
20	16QAM	50	0	16.12	16.10	16.17	17.5	0
20	16QAM	50	24	15.88	15.78	15.93		
20	16QAM	50	50	15.69	15.67	15.84		
20	16QAM	100	0	15.87	15.90	16.08		
Channel				26115	26340	26615	Tune-up limit (dBm)	MPR (dB)
Frequency (MHz)				1857.5	1880	1907.5		
15	QPSK	1	0	16.26	16.30	16.20	17.5	0
15	QPSK	1	37	16.09	16.04	15.93		
15	QPSK	1	74	15.66	15.69	15.75		
15	QPSK	36	0	15.92	15.97	15.93	17.5	0
15	QPSK	36	20	15.71	15.74	15.86		
15	QPSK	36	39	15.73	15.60	15.74		
15	QPSK	75	0	15.86	15.77	15.87		
15	16QAM	1	0	16.56	16.61	16.49	17.5	0
15	16QAM	1	37	16.04	15.91	16.07		
15	16QAM	1	74	15.95	16.16	16.04		
15	16QAM	36	0	15.93	16.06	16.06	17.5	0
15	16QAM	36	20	15.75	15.81	15.91		
15	16QAM	36	39	15.72	15.68	15.77		
15	16QAM	75	0	15.88	15.86	15.95		
Channel				26090	26340	26640	Tune-up limit (dBm)	MPR (dB)
Frequency (MHz)				1855	1880	1910		
10	QPSK	1	0	15.99	16.25	16.10	17.5	0
10	QPSK	1	25	15.88	15.74	15.98		
10	QPSK	1	49	15.92	15.62	15.82		
10	QPSK	25	0	15.85	15.88	15.96	17.5	0
10	QPSK	25	12	15.85	15.72	15.94		
10	QPSK	25	25	15.70	15.60	15.89		
10	QPSK	50	0	15.84	15.76	16.00		
10	16QAM	1	0	16.39	16.50	16.31	17.5	0
10	16QAM	1	25	16.15	15.98	16.22		
10	16QAM	1	49	16.06	15.89	16.12		
10	16QAM	25	0	15.90	15.93	15.99	17.5	0
10	16QAM	25	12	15.89	15.75	15.97		
10	16QAM	25	25	15.76	15.64	15.92		
10	16QAM	50	0	15.86	15.75	15.97		



Channel				26065	26340	26665	Tune-up limit (dBm)	MPR (dB)
Frequency (MHz)				1852.5	1880	1912.5		
5	QPSK	1	0	15.98	16.03	16.02	17.5	0
5	QPSK	1	12	15.87	15.87	16.02		
5	QPSK	1	24	15.75	15.64	15.81		
5	QPSK	12	0	15.82	15.79	15.93	17.5	0
5	QPSK	12	7	15.75	15.73	15.92		
5	QPSK	12	13	15.71	15.66	15.93		
5	QPSK	25	0	15.69	15.68	15.97	17.5	0
5	16QAM	1	0	16.21	16.34	16.26		
5	16QAM	1	12	15.99	16.33	16.00		
5	16QAM	1	24	16.01	15.93	16.13	17.5	0
5	16QAM	12	0	15.94	15.90	16.02		
5	16QAM	12	7	15.85	15.82	15.97		
5	16QAM	12	13	15.80	15.74	15.94	17.5	0
5	16QAM	25	0	15.72	15.74	15.97		
Channel				26055	26340	26675		
Frequency (MHz)				1851.5	1880	1913.5		
3	QPSK	1	0	15.83	16.04	15.81	17.5	0
3	QPSK	1	8	15.78	15.93	16.03		
3	QPSK	1	14	15.95	15.69	15.61		
3	QPSK	8	0	15.80	15.77	15.79	17.5	0
3	QPSK	8	4	15.79	15.77	15.86		
3	QPSK	8	7	15.72	15.70	15.78		
3	QPSK	15	0	15.65	15.66	15.83	17.5	0
3	16QAM	1	0	16.14	16.27	16.01		
3	16QAM	1	8	16.14	16.15	16.16		
3	16QAM	1	14	15.97	16.00	15.95	17.5	0
3	16QAM	8	0	15.91	15.82	15.87		
3	16QAM	8	4	15.82	15.85	15.89		
3	16QAM	8	7	15.78	15.75	15.83	17.5	0
3	16QAM	15	0	15.71	15.69	15.86		
Channel				26047	26340	26683		
Frequency (MHz)				1850.7	1880	1914.3		
1.4	QPSK	1	0	15.71	15.94	15.85	17.5	0
1.4	QPSK	1	3	15.93	15.80	15.84		
1.4	QPSK	1	5	15.60	15.71	15.72		
1.4	QPSK	3	0	15.77	15.68	15.77	17.5	0
1.4	QPSK	3	1	15.81	15.79	15.74		
1.4	QPSK	3	3	15.69	15.70	15.78		
1.4	QPSK	6	0	15.60	15.59	15.74	17.5	0
1.4	16QAM	1	0	16.00	16.17	16.15	17.5	0
1.4	16QAM	1	3	16.16	16.10	16.09		
1.4	16QAM	1	5	15.93	15.93	15.98		
1.4	16QAM	3	0	15.74	15.73	15.80	17.5	0
1.4	16QAM	3	1	15.89	15.86	15.77		
1.4	16QAM	3	3	15.80	15.80	15.84		
1.4	16QAM	6	0	15.74	15.74	15.84	17.5	0



<LTE Band 26>

BW [MHz]	Modulation	RB Size	RB Offset	Power Low Ch. / Freq.	Power Middle Ch. / Freq.	Power High Ch. / Freq.	Tune-up limit (dBm)	MPR (dB)
Channel				26765	26865	26965		
Frequency (MHz)				821.5	831.5	841.5		
15	QPSK	1	0	19.77	19.90	19.71		
15	QPSK	1	37	19.73	19.79	19.61	21	0
15	QPSK	1	74	19.65	19.64	19.70		
15	QPSK	36	0	19.70	19.82	19.72		
15	QPSK	36	20	19.69	19.79	19.70	21	0
15	QPSK	36	39	19.62	19.68	19.66		
15	QPSK	75	0	19.63	19.80	19.70		
15	16QAM	1	0	19.84	19.88	19.77	21	0
15	16QAM	1	37	19.81	19.82	19.75		
15	16QAM	1	74	19.73	19.82	19.85		
15	16QAM	36	0	19.70	19.79	19.72	21	0
15	16QAM	36	20	19.73	19.80	19.72		
15	16QAM	36	39	19.60	19.71	19.77		
15	16QAM	75	0	19.68	19.75	19.80		
Channel				26740	26865	26990		
Frequency (MHz)				819	831.5	844		
10	QPSK	1	0	19.63	19.72	19.66		
10	QPSK	1	25	19.60	19.65	19.71	21	0
10	QPSK	1	49	19.45	19.50	19.56		
10	QPSK	25	0	19.61	19.62	19.60		
10	QPSK	25	12	19.56	19.65	19.63	21	0
10	QPSK	25	25	19.52	19.66	19.61		
10	QPSK	50	0	19.58	19.69	19.67		
10	16QAM	1	0	19.81	19.85	19.80	21	0
10	16QAM	1	25	19.73	19.76	19.74		
10	16QAM	1	49	19.75	19.78	19.72		
10	16QAM	25	0	19.64	19.61	19.59	21	0
10	16QAM	25	12	19.58	19.66	19.62		
10	16QAM	25	25	19.51	19.68	19.60		
10	16QAM	50	0	19.57	19.64	19.65		
Channel				26715	26865	27015		
Frequency (MHz)				816.5	831.5	846.5		
5	QPSK	1	0	19.61	19.86	19.65		
5	QPSK	1	12	19.59	19.66	19.68	21	0
5	QPSK	1	24	19.53	19.67	19.66		
5	QPSK	12	0	19.43	19.74	19.61		
5	QPSK	12	7	19.58	19.83	19.66	21	0
5	QPSK	12	13	19.51	19.67	19.67		
5	QPSK	25	0	19.57	19.65	19.69		
5	16QAM	1	0	19.83	19.84	19.82	21	0
5	16QAM	1	12	19.77	19.76	19.78		
5	16QAM	1	24	19.78	19.68	19.80		
5	16QAM	12	0	19.47	19.77	19.67	21	0
5	16QAM	12	7	19.60	19.82	19.74		
5	16QAM	12	13	19.51	19.65	19.73		
5	16QAM	25	0	19.57	19.69	19.63		



Channel				26705	26865	27025	Tune-up limit (dBm)	MPR (dB)
Frequency (MHz)				815.5	831.5	847.5		
3	QPSK	1	0	19.59	19.84	19.72	21	0
3	QPSK	1	8	19.80	19.82	19.80		
3	QPSK	1	14	19.52	19.73	19.66		
3	QPSK	8	0	19.55	19.81	19.67	21	0
3	QPSK	8	4	19.62	19.81	19.73		
3	QPSK	8	7	19.50	19.74	19.68		
3	QPSK	15	0	19.60	19.77	19.68		
3	16QAM	1	0	19.80	19.86	19.82	21	0
3	16QAM	1	8	19.80	19.84	19.77		
3	16QAM	1	14	19.79	19.69	19.76		
3	16QAM	8	0	19.63	19.68	19.70	21	0
3	16QAM	8	4	19.66	19.67	19.74		
3	16QAM	8	7	19.54	19.81	19.74		
3	16QAM	15	0	19.59	19.82	19.70		
Channel				26697	26865	27033	Tune-up limit (dBm)	MPR (dB)
Frequency (MHz)				814.7	831.5	848.3		
1.4	QPSK	1	0	19.65	19.86	19.75	21	0
1.4	QPSK	1	3	19.70	19.84	19.81		
1.4	QPSK	1	5	19.56	19.74	19.73		
1.4	QPSK	3	0	19.48	19.68	19.68		
1.4	QPSK	3	1	19.57	19.77	19.68		
1.4	QPSK	3	3	19.60	19.77	19.75		
1.4	QPSK	6	0	19.52	19.72	19.60	21	0
1.4	16QAM	1	0	19.76	19.81	19.73	21	0
1.4	16QAM	1	3	19.73	19.79	19.78		
1.4	16QAM	1	5	19.71	19.75	19.63		
1.4	16QAM	3	0	19.57	19.75	19.67		
1.4	16QAM	3	1	19.62	19.77	19.71		
1.4	16QAM	3	3	19.69	19.62	19.75		
1.4	16QAM	6	0	19.62	19.62	19.69	21	0



**<TDD LTE SAR Measurement>**

TDD LTE configuration setup for SAR measurement

SAR was tested with a fixed periodic duty factor according to the highest transmission duty factor implemented for the device and supported by 3GPP.

- a. 3GPP TS 36.211 section 4.2 for Type 2 Frame Structure and Table 4.2-2 for uplink-downlink configurations
- b. "special subframe S" contains both uplink and downlink transmissions, it has been taken into consideration to determine the transmission duty factor according to the worst case uplink and downlink cyclic prefix requirements for UpPTS
- c. Establishing connections with base station simulators ensure a consistent means for testing SAR and recommended for evaluating SAR. The Anritsu MT8820C (firmware: #22.52#004) was used for LTE output power measurements and SAR testing.

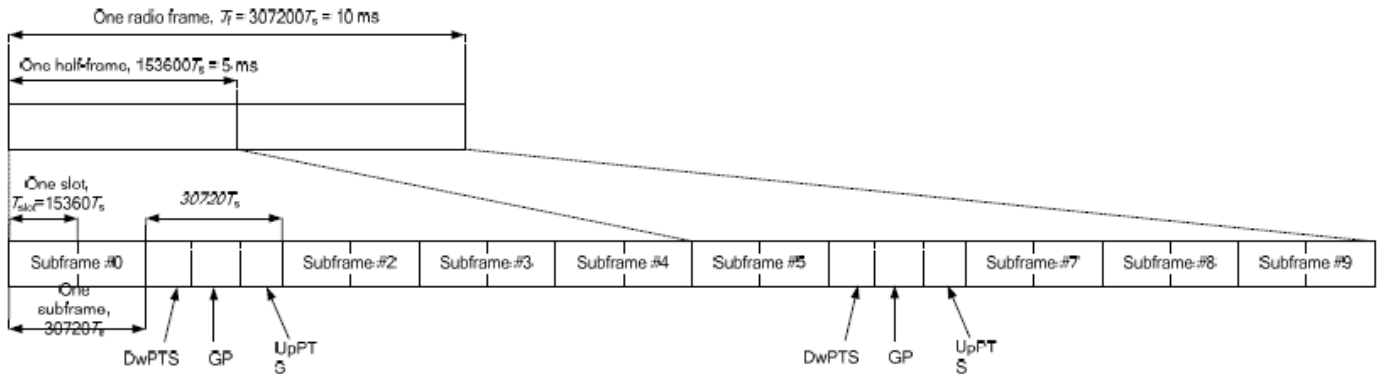

**Figure 4.2-1: Frame structure type 2 (for 5 ms switch-point periodicity).**

**Table 4.2-2: Uplink-downlink configurations.**

Uplink-downlink configuration	Downlink-to-Uplink Switch-point periodicity	Subframe number									
		0	1	2	3	4	5	6	7	8	9
0	5 ms	D	S	U	U	U	D	S	U	U	U
1	5 ms	D	S	U	U	D	D	S	U	U	D
2	5 ms	D	S	U	D	D	D	S	U	D	D
3	10 ms	D	S	U	U	U	D	D	D	D	D
4	10 ms	D	S	U	U	D	D	D	D	D	D
5	10 ms	D	S	U	D	D	D	D	D	D	D
6	5 ms	D	S	U	U	U	D	S	U	U	D

**Table 4.2-1: Configuration of special subframe (lengths of DwPTS/GP/UpPTS).**

Special subframe configuration	Normal cyclic prefix in downlink				Extended cyclic prefix in downlink			
	DwPTS	UpPTS		DwPTS	UpPTS			
		Normal cyclic prefix in uplink	Extended cyclic prefix in uplink		Normal cyclic prefix in uplink	Extended cyclic prefix in uplink		
0	6592 · Ts	2192 · Ts	2560 · Ts	7680 · Ts	2192 · Ts	2560 · Ts		
1	19760 · Ts			20480 · Ts				
2	21952 · Ts			23040 · Ts				
3	24144 · Ts			25600 · Ts				
4	26336 · Ts	7680 · Ts	4384 · Ts	5120 · Ts				
5	6592 · Ts	20480 · Ts						
6	19760 · Ts	23040 · Ts						
7	21952 · Ts	4384 · Ts	5120 · Ts	12800 · Ts	-	-		
8	24144 · Ts	-	-	-				
9	13168 · Ts	-	-	-				

<b>Special subframe (30720·T<sub>s</sub>): Normal cyclic prefix in downlink (UpPTS)</b>			
	<b>Special subframe configuration</b>	<b>Normal cyclic prefix in uplink</b>	<b>Extended cyclic prefix in uplink</b>
<b>Uplink duty factor in one special subframe</b>	<b>0~4</b>	7.13%	8.33%
	<b>5~9</b>	14.3%	16.7%

<b>Special subframe(30720·T<sub>s</sub>): Extended cyclic prefix in downlink (UpPTS)</b>			
	<b>Special subframe configuration</b>	<b>Normal cyclic prefix in uplink</b>	<b>Extended cyclic prefix in uplink</b>
<b>Uplink duty factor in one special subframe</b>	<b>0~3</b>	7.13%	8.33%
	<b>4~7</b>	14.3%	16.7%

The highest duty factor is resulted from:

- i. Uplink-downlink configuration: 0. In a half-frame consisted of 5 subframes, uplink operation is in 3 uplink subframes and 1 special subframe.
- ii. special subframe configuration: 5-9 for normal cyclic prefix in downlink, 4-7 for extended cyclic prefix in downlink
- iii. for special subframe with extended cyclic prefix in uplink, the total uplink duty factor in one half-frame is:  $(3+0.167)/5 = 63.3\%$
- iv. for special subframe with normal cyclic prefix in uplink, the total uplink duty factor in one half-frame is:  $(3+0.143)/5 = 62.9\%$
- v. For TDD LTE SAR measurement, the duty cycle 1:1.59 (62.9 %) was used perform testing and considering the theoretical duty cycle of 63.3% for extended cyclic prefix in the uplink, and the theoretical duty cycle of 62.9% for normal cyclic prefix in uplink, a scaling factor of extended cyclic prefix  $63.3\%/62.9\% = 1.006$  is applied to scale-up the measured SAR result. The scaled TDD LTE SAR = measured SAR (W/kg)\* Tune-up Scaling Factor\* scaling factor for extended cyclic prefix.



**Full Power Mode**

**<LTE Band 41>**

BW [MHz]	Modulation	RB Size	RB Offset	Power Low Ch. / Freq.	Power Low Middle Ch. / Freq.	Power Middle Ch. / Freq.	Power High Middle Ch. / Freq.	Power High Ch. / Freq.	Tune-up limit (dBm)	MPR (dB)
Channel				39750	40185	40620	41055	41490		
Frequency (MHz)				2506	2549.5	2593	2636.5	2680		
20	QPSK	1	0	21.14	21.12	21.13	21.09	21.17	23	0
20	QPSK	1	49	21.04	21.08	21.03	21.07	21.15		
20	QPSK	1	99	21.03	21.07	21.02	21.06	21.11		
20	QPSK	50	0	20.21	20.16	20.21	20.10	20.27	22	1
20	QPSK	50	24	20.12	20.15	20.13	20.06	20.22		
20	QPSK	50	50	20.08	20.00	20.01	20.00	20.10		
20	QPSK	100	0	20.08	20.08	20.12	20.00	20.16	22	1
20	16QAM	1	0	20.02	20.11	20.12	20.03	20.30		
20	16QAM	1	49	20.23	20.17	20.21	20.05	20.18		
20	16QAM	1	99	20.16	20.04	20.16	20.00	20.10	21	2
20	16QAM	50	0	19.10	19.19	19.14	19.09	19.29		
20	16QAM	50	24	19.15	19.18	19.20	19.05	19.23		
20	16QAM	50	50	19.07	19.04	19.01	19.00	19.14	21	2
20	16QAM	100	0	19.11	19.16	19.20	19.00	19.23		
Channel				39725	40173	40620	41068	41515		
Frequency (MHz)				2503.5	2548.3	2593	2637.8	2682.5		
15	QPSK	1	0	21.08	21.09	21.13	21.02	21.14	23	0
15	QPSK	1	37	21.00	21.02	21.06	21.02	21.11		
15	QPSK	1	74	21.04	21.01	21.02	21.01	21.03		
15	QPSK	36	0	20.11	20.12	20.21	20.08	20.24	22	1
15	QPSK	36	20	20.02	20.11	20.08	20.01	20.12		
15	QPSK	36	39	20.06	20.03	20.02	20.00	20.07		
15	QPSK	75	0	20.07	20.08	20.12	20.02	20.09	22	1
15	16QAM	1	0	20.08	20.09	20.07	20.06	20.22		
15	16QAM	1	37	20.13	20.11	20.11	20.07	20.17		
15	16QAM	1	74	20.07	20.04	20.11	20.09	20.02	21	2
15	16QAM	36	0	19.06	19.13	19.05	19.09	19.24		
15	16QAM	36	20	19.10	19.12	19.18	19.07	19.20		
15	16QAM	36	39	19.08	19.07	19.05	19.09	19.05	21	2
15	16QAM	75	0	19.03	19.10	19.14	19.04	19.19		
Channel				39700	40160	40620	41080	41540		
Frequency (MHz)				2501	2547	2593	2639	2685		
10	QPSK	1	0	21.13	21.09	21.07	21.09	21.15	23	0
10	QPSK	1	25	21.06	21.08	21.03	21.05	21.10		
10	QPSK	1	49	21.08	21.03	21.03	21.08	21.06		
10	QPSK	25	0	20.20	20.08	20.21	20.05	20.24	22	1
10	QPSK	25	12	20.08	20.12	20.12	21.07	20.20		
10	QPSK	25	25	20.00	20.03	20.04	21.00	20.09		
10	QPSK	50	0	20.02	20.06	20.06	20.00	20.14	22	1
10	16QAM	1	0	20.02	20.02	20.12	20.09	20.20		
10	16QAM	1	25	20.16	20.16	20.14	20.05	20.09		
10	16QAM	1	49	20.07	20.04	20.12	20.08	20.01	21	2
10	16QAM	25	0	19.01	19.18	19.07	19.05	19.28		
10	16QAM	25	12	19.10	19.13	19.12	19.04	19.15		
10	16QAM	25	25	19.02	19.04	19.03	19.06	19.05	21	2
10	16QAM	50	0	19.06	19.11	19.15	19.03	19.13		



Channel				39675	40148	40620	41093	41565	Tune-up limit (dBm)	MPR (dB)
Frequency (MHz)				2498.5	2545.8	2593	2640.30	2687.5		
5	QPSK	1	0	21.14	21.08	21.03	21.09	21.15	23	0
5	QPSK	1	12	21.07	21.00	21.03	21.07	21.10		
5	QPSK	1	24	21.06	21.03	21.07	21.02	21.04		
5	QPSK	12	0	20.12	20.11	20.16	20.07	20.21	22	1
5	QPSK	12	7	20.04	20.15	20.03	20.05	20.21		
5	QPSK	12	13	20.08	20.08	20.02	20.00	20.00		
5	QPSK	25	0	20.04	20.09	20.08	20.05	20.13		
5	16QAM	1	0	20.01	20.04	20.02	20.08	20.24	22	1
5	16QAM	1	12	20.18	20.11	20.21	20.05	20.15		
5	16QAM	1	24	20.16	20.03	20.08	20.03	20.02		
5	16QAM	12	0	19.01	19.11	19.13	19.09	19.20	21	2
5	16QAM	12	7	19.07	19.18	19.10	19.04	19.19		
5	16QAM	12	13	19.02	19.04	19.01	19.06	19.14		
5	16QAM	25	0	19.03	19.16	19.15	19.08	19.20		



**Reduced Power Mode**

**<LTE Band 41>**

BW [MHz]	Modulation	RB Size	RB Offset	Power Low Ch. / Freq.	Power Low Middle Ch. / Freq.	Power Middle Ch. / Freq.	Power High Middle Ch. / Freq.	Power High Ch. / Freq.	Tune-up limit (dBm)	MPR (dB)
Channel				39750	40185	40620	41055	41490		
Frequency (MHz)				2506	2549.5	2593	2636.5	2680		
20	QPSK	1	0	17.05	16.91	17.36	17.25	17.30	18	0
20	QPSK	1	49	16.96	16.81	16.82	16.84	17.09		
20	QPSK	1	99	16.73	16.46	16.61	16.62	16.77		
20	QPSK	50	0	17.24	17.07	17.30	17.29	17.25	18	0
20	QPSK	50	24	17.22	16.99	17.02	17.06	17.21		
20	QPSK	50	50	16.97	16.90	16.91	16.92	17.10		
20	16QAM	1	0	16.94	16.97	16.90	16.95	17.16	18	0
20	16QAM	1	49	17.28	17.07	17.08	17.13	17.35		
20	16QAM	1	99	16.73	16.61	16.64	16.67	16.81		
20	16QAM	50	0	17.28	17.14	17.06	17.10	17.35	18	0
20	16QAM	50	24	17.25	17.03	17.09	17.15	17.29		
20	16QAM	50	50	17.00	16.92	16.93	16.91	17.10		
20	16QAM	100	0	17.15	16.98	16.99	17.03	17.17		
Channel				39725	40173	40620	41068	41515	Tune-up limit (dBm)	MPR (dB)
Frequency (MHz)				2503.5	2548.3	2593	2637.8	2682.5		
15	QPSK	1	0	17.07	16.98	17.23	16.89	16.92	18	0
15	QPSK	1	37	17.05	17.11	17.16	17.10	17.01		
15	QPSK	1	74	16.82	16.73	16.82	16.59	16.59		
15	QPSK	36	0	17.22	17.01	16.94	16.93	17.01	18	0
15	QPSK	36	20	17.22	17.00	17.01	16.94	17.06		
15	QPSK	36	39	17.11	16.93	16.85	16.59	16.93		
15	16QAM	75	0	17.22	16.99	16.89	16.80	16.94	18	0
15	16QAM	1	0	17.10	17.15	17.17	16.82	17.15		
15	16QAM	1	37	17.16	17.09	17.01	16.89	17.14		
15	16QAM	1	74	17.06	16.83	16.83	16.58	16.81	18	0
15	16QAM	36	0	17.09	17.03	16.90	16.86	16.90		
15	16QAM	36	20	17.08	17.02	16.95	16.89	16.91		
15	16QAM	36	39	17.10	16.90	16.82	16.66	16.75	18	0
15	16QAM	36	0	17.05	16.95	16.94	16.93	16.80		
15	16QAM	75	0	17.05	16.95	16.94	16.93	16.80		
Channel				39700	40160	40620	41080	41540	Tune-up limit (dBm)	MPR (dB)
Frequency (MHz)				2501	2547	2593	2639	2685		
10	QPSK	1	0	16.63	16.62	16.85	16.58	16.54	18	0
10	QPSK	1	25	16.55	16.56	16.64	16.59	16.57		
10	QPSK	1	49	16.58	16.52	16.44	16.63	16.55		
10	QPSK	25	0	16.62	16.55	16.48	16.57	16.60	18	0
10	QPSK	25	12	16.59	16.58	16.53	16.50	16.55		
10	QPSK	25	25	16.52	16.48	16.41	16.64	16.64		
10	QPSK	50	0	16.63	16.48	16.46	16.61	16.64	18	0
10	16QAM	1	0	16.70	16.76	16.83	16.82	16.80		
10	16QAM	1	25	16.54	16.69	16.72	16.68	16.52		
10	16QAM	1	49	16.63	16.50	16.40	16.58	16.74	18	0
10	16QAM	25	0	16.70	16.76	16.53	16.76	16.75		
10	16QAM	25	12	16.50	16.65	16.57	16.81	16.79		
10	16QAM	25	25	16.80	16.48	16.42	16.61	16.69	18	0
10	16QAM	50	0	16.80	16.47	16.50	16.63	16.75		



Channel				39675	40148	40620	41093	41565	Tune-up limit (dBm)	MPR (dB)
Frequency (MHz)				2498.5	2545.8	2593	2640.30	2687.5		
5	QPSK	1	0	16.53	16.56	16.83	16.69	16.73	18	0
5	QPSK	1	12	16.37	16.52	16.42	16.56	16.64		
5	QPSK	1	24	16.42	16.38	16.32	16.55	16.61		
5	QPSK	12	0	16.35	16.57	16.47	16.60	16.67	18	0
5	QPSK	12	7	16.82	16.62	16.46	16.61	16.71		
5	QPSK	12	13	16.79	16.58	16.39	16.58	16.63		
5	QPSK	25	0	16.73	16.54	16.40	16.54	16.61	18	0
5	16QAM	1	0	16.72	16.67	16.82	16.69	16.81		
5	16QAM	1	12	16.78	16.66	16.57	16.66	16.76		
5	16QAM	1	24	16.77	16.54	16.47	16.60	16.78	18	0
5	16QAM	12	0	16.80	16.62	16.50	16.55	16.76		
5	16QAM	12	7	16.74	16.58	16.51	16.57	16.78		
5	16QAM	12	13	16.81	16.55	16.53	16.51	16.76	18	0
5	16QAM	25	0	16.75	16.65	16.55	16.57	16.73		



**LTE Carrier Aggregation Conducted Power**

**General Note:**

- i. According to KDB941225 D05A v01r02, Uplink maximum output power measurement with downlink carrier aggregation active should be measured, using the highest output channel measured without downlink carrier aggregation, to confirm that uplink maximum output power with downlink carrier aggregation active remains within the specified tune-up tolerance limits and not more than ¼ dB higher than the maximum output measured without downlink carrier aggregation active.
- ii. Uplink maximum output power with downlink carrier aggregation active does not show more than ¼ dB higher than the maximum output power without downlink carrier aggregation active, therefore SAR evaluation with downlink carrier aggregation active can be excluded.
- iii. The device only supports downlink carrier aggregation. Uplink carrier aggregation is not supported. Power measurements were performed with two DL carriers for the Release 8 configuration that had the highest output power across all bandwidths, channels and RB configuration for each band.
- iv. During the carrier aggregation conducted power measurements we have attention to throughput traffic to make sure all the power measurement is corrected.

Configure		PCC					SCC				Power		
		LTE Band	BW (MHz)	Freq. (MHz)	Channel	UL# RB	UL RB Offset	LTE Band	BW (MHz)	DL Freq. (MHz)	DL Channel	LTE Rel 10 Tx.Power(dBm)	LTE Rel 8 Tx.Power(dBm)
Inter-Band		Band 2	20M	1880	18900	1	0	Band 5	10M	881.5	2525	23.20	23.23
		Band 5	10M	836.5	20525	1	0	Band 2	20M	1960	900	23.50	23.52
		Band 2	20M	1880	18900	1	0	Band 12	10M	737.5	5095	23.22	23.22
		Band 12	10M	707.5	23095	1	0	Band 2	20M	1960	900	22.69	22.70
		Band 2	20M	1880	18900	1	0	Band 13	10M	751	5230	23.21	23.23
		Band 13	10M	782	23230	1	0	Band 2	20M	1960	900	22.18	22.20
		Band 2	20M	1880	18900	1	0	Band 29	10M	722.5	9715	23.25	23.25
		Band 4	20M	1732.5	20175	1	0	Band 5	10M	881.5	2525	23.28	23.29
		Band 5	10M	836.5	20525	1	0	Band 4	20M	2132.5	2175	23.48	23.50
		Band 4	20M	1732.5	20175	1	0	Band 12	10M	737.5	5095	23.30	23.33
		Band 12	10M	707.5	23095	1	0	Band 4	20M	2132.5	2175	22.69	22.69
		Band 4	20M	1732.5	20175	1	0	Band 13	10M	751	5230	23.35	23.35
		Band 13	10M	782	23230	1	0	Band 4	20M	2132.5	2175	22.25	22.25
		Band 4	20M	1732.5	20175	1	0	Band 29	10M	722.5	9715	23.27	23.30
Intra-Band	Contiguous	Band 2	20M	1880	18900	1	0	Band 2	20M	1980	1100	23.20	23.25
		Band 7	20M	2535	21100	1	0	Band 7	20M	2635	2900	21.15	21.20
		Band 41	20M	2593	40620	1	0	Band 41	20M	2573	40420	21.08	21.10
	Non-Contiguous	Band 2	20M	1860	18700	1	0	Band 2	20M	1980	1100	23.26	23.26
		Band 7	20M	2535	21100	1	0	Band 7	20M	2680	3350	21.17	21.19
		Band 41	20M	2506	39750	1	0	Band 41	20M	2680	41490	21.05	21.09



### 14. Test Exclusion Applied

**General Note:**

1. The below table, when the distance is < 50 mm exclusion threshold is "Ratio", when the distance is > 50 mm exclusion threshold is "mW"
2. Maximum power is the source-based time-average power and represents the maximum RF output power among production units
3. Per KDB 447498 D01v06, for larger devices, the test separation distance of adjacent edge configuration is determined by the closest separation between the antenna and the user.
4. Per KDB 447498 D01v06, standalone SAR test exclusion threshold is applied; If the test separation distance is < 5mm, 5mm is used to determine SAR exclusion threshold.
5. Per KDB 447498 D01v06, the 1-g and 10-g SAR test exclusion thresholds for 100 MHz to 6 GHz at *test separation distances* ≤ 50 mm are determined by:
  - $[(max. power of channel, including tune-up tolerance, mW)/(min. test separation distance, mm)] \cdot [\sqrt{f(GHz)}] \leq 3.0$  for 1-g SAR and ≤ 7.5 for 10-g extremity SAR
  - f(GHz) is the RF channel transmit frequency in GHz
  - Power and distance are rounded to the nearest mW and mm before calculation
  - The result is rounded to one decimal place for comparison
6. Per KDB 447498 D01v06, at 100 MHz to 6 GHz and for *test separation distances* > 50 mm, the SAR test exclusion threshold is determined according to the following
  - a) [Threshold at 50 mm in step 1) + (test separation distance - 50 mm) · ( f(MHz)/150)] mW, at 100 MHz to 1500 MHz
  - b) [Threshold at 50 mm in step 1) + (test separation distance - 50 mm) · 10] mW at > 1500 MHz and ≤ 6 GHz
7. The detail antenna location please refers to Appendix D.

Exposure Position	Wireless Interface	WCDMA Band V	WCDMA Band IV	WCDMA Band II	LTE Band 12	LTE Band 13	LTE Band 5/26	LTE Band 4	LTE Band 2	LTE Band 25	LTE Band 7	LTE Band 41
	Calculated Frequency	846MHz	1750MHz	1907MHz	715MHz	784MHz	848MHz	1754MHz	1909MHz	1914MHz	2570MHz	2688MHz
	Maximum power (dBm)	24.0	24.0	24.0	24.0	24.0	24.0	24.0	24.0	24.0	23.0	23.0
	Maximum rated power(mW)	251.0	251.0	251.0	251.0	251.0	251.0	251.0	251.0	251.0	200.0	200.0
Bottom Face	Separation distance(mm)	5.0										
	exclusion threshold	46.2	66.4	69.3	42.5	44.5	46.2	66.5	69.4	69.5	64.1	65.6
	Testing required?	Yes	Yes	Yes	Yes	Yes	Yes	Yes	Yes	Yes	Yes	Yes
Edge 1	Separation distance(mm)	5.0										
	exclusion threshold	46.2	66.4	69.3	42.5	44.5	46.2	66.5	69.4	69.5	64.1	65.6
	Testing required?	Yes	Yes	Yes	Yes	Yes	Yes	Yes	Yes	Yes	Yes	Yes
Edge 2	Separation distance(mm)	5.0										
	exclusion threshold	46.2	66.4	69.3	42.5	44.5	46.2	66.5	69.4	69.5	64.1	65.6
	Testing required?	Yes	Yes	Yes	Yes	Yes	Yes	Yes	Yes	Yes	Yes	Yes
Edge 3	Separation distance(mm)	144.5										
	exclusion threshold	696.0	1058.0	1054.0	628.0	663.0	697.0	1058.0	1054.0	1053.0	1039.0	1036.0
	Testing required?	No	No	No	No	No	No	No	No	No	No	No
Edge 4	Separation distance(mm)	277.0										
	exclusion threshold	1443.0	2383.0	2379.0	1259.0	1356.0	1446.0	2383.0	2379.0	2378.0	2364.0	2361.0
	Testing required?	No	No	No	No	No	No	No	No	No	No	No





## **15. SAR Test Results**

### **General Note:**

1. Per KDB 447498 D01v06, the reported SAR is the measured SAR value adjusted for maximum tune-up tolerance.
  - a. Tune-up scaling Factor = tune-up limit power (mW) / EUT RF power (mW), where tune-up limit is the maximum rated power among all production units.
  - b. For WWAN: Reported SAR(W/kg)= Measured SAR(W/kg)\*Tune-up Scaling Factor
  - c. For TDD LTE SAR measurement, the duty cycle 1:1.59 (62.9 %) was used perform testing and considering the theoretical duty cycle of 63.3% for extended cyclic prefix in the uplink, and the theoretical duty cycle of 62.9% for normal cyclic prefix in uplink, a scaling factor of extended cyclic prefix 63.3%/62.9% = 1.006 is applied to scale-up the measured SAR result. The Reported TDD LTE SAR = measured SAR (W/kg)\* Tune-up Scaling Factor\* scaling factor for extended cyclic prefix.
2. Per KDB 447498 D01v06, for each exposure position, testing of other required channels within the operating mode of a frequency band is not required when the *reported* 1-g or 10-g SAR for the mid-band or highest output power channel is:
  - $\leq 0.8$  W/kg or 2.0 W/kg, for 1-g or 10-g respectively, when the transmission band is  $\leq 100$  MHz
  - $\leq 0.6$  W/kg or 1.5 W/kg, for 1-g or 10-g respectively, when the transmission band is between 100 MHz and 200 MHz
  - $\leq 0.4$  W/kg or 1.0 W/kg, for 1-g or 10-g respectively, when the transmission band is  $\geq 200$  MHz

### **Tablet Note:**

1. For the exposure positions that proximity sensor power reduction is applied for SAR compliance, additional SAR testing with EUT transmitting full power in normal mode was performed; 11mm for bottom face, 9mm for edge1, 15mm for edge 2.

### **UMTS Note:**

1. Per KDB 941225 D01v03r01, SAR for Body exposure is measured using a 12.2 kbps RMC with TPC bits configured to all "1's".
2. Per KDB 941225 D01v03r01, RMC 12.2kbps setting is used to evaluate SAR. If the maximum output power and tune-up tolerance specified for production units in HSDPA / HSUPA / DC-HSDPA is  $\leq 1/4$  dB higher than RMC 12.2Kbps or when the highest reported SAR of the RMC12.2Kbps is scaled by the ratio of specified maximum output power and tune-up tolerance of HSDPA / HSUPA / DC-HSDPA to RMC12.2Kbps and the adjusted SAR is  $\leq 1.2$  W/kg, SAR measurement is not required for HSDPA / HSUPA / DC-HSDPA.

### **LTE Note:**

1. Per KDB 941225 D05v02r05, start with the largest channel bandwidth and measure SAR for QPSK with 1 RB allocation, using the RB offset and required test channel combination with the highest maximum output power for RB offsets at the upper edge, middle and lower edge of each required test channel.
2. Per KDB 941225 D05v02r05, 50% RB allocation for QPSK SAR testing follows 1RB QPSK allocation procedure.
3. Per KDB 941225 D05v02r05, For QPSK with 100% RB allocation, SAR is not required when the highest maximum output power for 100 % RB allocation is less than the highest maximum output power in 50% and 1 RB allocations and the highest reported SAR for 1 RB and 50% RB allocation are  $\leq 0.8$  W/kg. Otherwise, SAR is measured for the highest output power channel; and if the reported SAR is  $> 1.45$  W/kg, the remaining required test channels must also be tested.
4. Per KDB 941225 D05v02r05, 16QAM output power for each RB allocation configuration is  $> \text{not } 1/2$  dB higher than the same configuration in QPSK and the reported SAR for the QPSK configuration is  $\leq 1.45$  W/kg; Per KDB 941225 D05v02r05, 16QAM SAR testing is not required.
5. Per KDB 941225 D05v02r05, Smaller bandwidth output power for each RB allocation configuration is  $> \text{not } 1/2$  dB higher than the same configuration in the largest supported bandwidth, and the reported SAR for the largest supported bandwidth is  $\leq 1.45$  W/kg; Per KDB 941225 D05v02r05, smaller bandwidth SAR testing is not required.
6. For LTE B26 / B13 / B12 / B4 the maximum bandwidth does not support three non-overlapping channels, per KDB 941225 D05v02r05, when a device supports overlapping channel assignment in a channel bandwidth configuration, the middle channel of the group of overlapping channels should be selected for testing.
7. LTE band 2 / 5 SAR test was covered by Band 25 / 26; according to April 2015 TCB workshop, SAR test for overlapping LTE bands can be reduced if
  - a. the maximum output power, including tolerance, for the smaller band is  $\leq$  the larger band to qualify for the SAR test exclusion
  - b. the channel bandwidth and other operating parameters for the smaller band are fully supported by the larger band



15.1 Body SAR

<WCDMA SAR>

Plot No.	Band	Mode	Test Position	Gap (mm)	Power Reduction	Ch.	Freq. (MHz)	Average Power (dBm)	Tune-Up Limit (dBm)	Tune-up Scaling Factor	Power Drift (dB)	Measured 1g SAR (W/kg)	Reported 1g SAR (W/kg)
	WCDMA II	RMC 12.2Kbps	Bottom Face	0mm	ON	9400	1880	16.30	17.00	1.175	-0.18	0.638	0.750
	WCDMA II	RMC 12.2Kbps	Edge 1	0mm	ON	9400	1880	16.30	17.00	1.175	-0.14	0.425	0.499
	WCDMA II	RMC 12.2Kbps	Edge 2	0mm	ON	9400	1880	16.30	17.00	1.175	-0.1	0.782	0.919
	WCDMA II	RMC 12.2Kbps	Edge 2	0mm	ON	9262	1852.4	16.28	17.00	1.180	-0.13	0.811	0.957
	WCDMA II	RMC 12.2Kbps	Edge 2	0mm	ON	9538	1907.6	16.19	17.00	1.205	-0.13	0.739	0.891
	WCDMA II	RMC 12.2Kbps	Bottom Face	11mm	OFF	9400	1880	22.88	24.00	1.294	-0.03	0.749	0.969
01	WCDMA II	RMC 12.2Kbps	Bottom Face	11mm	OFF	9262	1852.4	22.83	24.00	1.309	-0.05	0.778	1.019
	WCDMA II	RMC 12.2Kbps	Bottom Face	11mm	OFF	9538	1907.6	22.68	24.00	1.355	-0.06	0.704	0.954
	WCDMA II	RMC 12.2Kbps	Edge 1	9mm	OFF	9400	1880	22.88	24.00	1.294	-0.05	0.466	0.603
	WCDMA II	RMC 12.2Kbps	Edge 2	15mm	OFF	9400	1880	22.88	24.00	1.294	0.12	0.503	0.651
	WCDMA IV	RMC 12.2Kbps	Bottom Face	0mm	ON	1413	1732.6	16.11	17.00	1.227	-0.08	0.904	1.110
	WCDMA IV	RMC 12.2Kbps	Bottom Face	0mm	ON	1312	1712.4	16.05	17.00	1.245	-0.18	0.922	1.147
	WCDMA IV	RMC 12.2Kbps	Bottom Face	0mm	ON	1513	1752.6	16.10	17.00	1.230	-0.12	0.819	1.008
	WCDMA IV	RMC 12.2Kbps	Edge 1	0mm	ON	1413	1732.6	16.11	17.00	1.227	-0.14	0.370	0.454
	WCDMA IV	RMC 12.2Kbps	Edge 2	0mm	ON	1413	1732.6	16.11	17.00	1.227	-0.1	0.907	1.113
	WCDMA IV	RMC 12.2Kbps	Edge 2	0mm	ON	1312	1712.4	16.05	17.00	1.245	-0.1	0.867	1.079
	WCDMA IV	RMC 12.2Kbps	Edge 2	0mm	ON	1513	1752.6	16.10	17.00	1.230	-0.09	0.896	1.102
	WCDMA IV	RMC 12.2Kbps	Bottom Face	11mm	OFF	1413	1732.6	22.83	24.00	1.309	-0.16	0.937	1.227
	WCDMA IV	RMC 12.2Kbps	Bottom Face	11mm	OFF	1312	1712.4	22.62	24.00	1.374	-0.03	0.929	1.276
02	WCDMA IV	RMC 12.2Kbps	Bottom Face	11mm	OFF	1513	1752.6	22.76	24.00	1.330	-0.06	0.975	1.297
	WCDMA IV	RMC 12.2Kbps	Edge 1	9mm	OFF	1413	1732.6	22.83	24.00	1.309	-0.08	0.472	0.618
	WCDMA IV	RMC 12.2Kbps	Edge 2	15mm	OFF	1413	1732.6	22.83	24.00	1.309	0	0.408	0.534
	WCDMA V	RMC 12.2Kbps	Bottom Face	0mm	ON	4233	846.6	20.17	21.50	1.358	0.05	0.788	1.070
	WCDMA V	RMC 12.2Kbps	Bottom Face	0mm	ON	4132	826.4	20.11	21.50	1.377	0.06	0.771	1.062
03	WCDMA V	RMC 12.2Kbps	Bottom Face	0mm	ON	4182	836.4	20.00	21.50	1.413	0	0.804	1.136
	WCDMA V	RMC 12.2Kbps	Edge 1	0mm	ON	4233	846.6	20.17	21.50	1.358	0.02	0.147	0.200
	WCDMA V	RMC 12.2Kbps	Edge 2	0mm	ON	4233	846.6	20.17	21.50	1.358	-0.12	0.494	0.671
	WCDMA V	RMC 12.2Kbps	Bottom Face	11mm	OFF	4233	846.6	22.97	24.00	1.268	-0.07	0.397	0.503
	WCDMA V	RMC 12.2Kbps	Edge 1	9mm	OFF	4233	846.6	22.97	24.00	1.268	-0.14	0.143	0.181
	WCDMA V	RMC 12.2Kbps	Edge 2	15mm	OFF	4233	846.6	22.97	24.00	1.268	-0.04	0.198	0.251
	WCDMA V	RMC 12.2Kbps	Edge 3	0mm	OFF	4233	846.6	22.97	24.00	1.268	0	0.058	0.074
	WCDMA V	RMC 12.2Kbps	Edge 4	0mm	OFF	4233	846.6	22.97	24.00	1.268	-0.05	0.017	0.022



<FDD LTE SAR>

Plot No.	Band	BW (MHz)	Modulation	RB Size	RB offset	Test Position	Gap (mm)	Power Reduction	Ch.	Freq. (MHz)	Average Power (dBm)	Tune-Up Limit (dBm)	Tune-up Scaling Factor	Power Drift (dB)	Measured 1g SAR (W/kg)	Reported 1g SAR (W/kg)
	LTE Band 4	20M	QPSK	1	0	Bottom Face	0mm	ON	20175	1732.5	16.61	17.50	1.227	-0.13	1.000	1.227
	LTE Band 4	20M	QPSK	50	0	Bottom Face	0mm	ON	20175	1732.5	16.30	17.50	1.318	-0.14	0.914	1.205
	LTE Band 4	20M	QPSK	100	0	Bottom Face	0mm	ON	20175	1732.5	16.25	17.50	1.334	-0.02	0.895	1.194
	LTE Band 4	20M	QPSK	1	0	Edge 1	0mm	ON	20175	1732.5	16.61	17.50	1.227	-0.1	0.383	0.470
	LTE Band 4	20M	QPSK	50	0	Edge 1	0mm	ON	20175	1732.5	16.30	17.50	1.318	-0.1	0.362	0.477
04	LTE Band 4	20M	QPSK	1	0	Edge 2	0mm	ON	20175	1732.5	16.61	17.50	1.227	0.15	1.050	1.289
	LTE Band 4	20M	QPSK	50	0	Edge 2	0mm	ON	20175	1732.5	16.30	17.50	1.318	-0.1	0.965	1.272
	LTE Band 4	20M	QPSK	100	0	Edge 2	0mm	ON	20175	1732.5	16.25	17.50	1.334	-0.05	0.947	1.263
	LTE Band 4	20M	QPSK	1	0	Bottom Face	11mm	OFF	20175	1732.5	23.30	24.00	1.175	-0.05	1.030	1.210
	LTE Band 4	20M	QPSK	50	0	Bottom Face	11mm	OFF	20175	1732.5	22.31	23.00	1.172	-0.15	0.702	0.823
	LTE Band 4	20M	QPSK	100	0	Bottom Face	11mm	OFF	20175	1732.5	22.22	23.00	1.197	-0.09	0.684	0.819
	LTE Band 4	20M	QPSK	1	0	Edge 1	9mm	OFF	20175	1732.5	23.30	24.00	1.175	0.01	0.449	0.528
	LTE Band 4	20M	QPSK	50	0	Edge 1	9mm	OFF	20175	1732.5	22.31	23.00	1.172	-0.02	0.337	0.395
	LTE Band 4	20M	QPSK	1	0	Edge 2	15mm	OFF	20175	1732.5	23.30	24.00	1.175	-0.05	0.431	0.506
	LTE Band 4	20M	QPSK	50	0	Edge 2	15mm	OFF	20175	1732.5	22.31	23.00	1.172	-0.05	0.328	0.384
	LTE Band 7	20M	QPSK	1	0	Bottom Face	0mm	ON	21100	2535	17.62	18.00	1.091	-0.11	1.030	1.124
	LTE Band 7	20M	QPSK	1	0	Bottom Face	0mm	ON	20850	2510	17.36	18.00	1.159	-0.08	0.967	1.121
05	LTE Band 7	20M	QPSK	1	0	Bottom Face	0mm	ON	21350	2560	17.40	18.00	1.148	-0.11	1.100	1.263
	LTE Band 7	20M	QPSK	50	0	Bottom Face	0mm	ON	21100	2535	17.50	18.00	1.122	-0.1	0.999	1.121
	LTE Band 7	20M	QPSK	50	0	Bottom Face	0mm	ON	20850	2510	17.41	18.00	1.146	-0.05	0.916	1.049
	LTE Band 7	20M	QPSK	50	0	Bottom Face	0mm	ON	21100	2535	17.13	18.00	1.222	0.04	0.993	1.213
	LTE Band 7	20M	QPSK	100	0	Bottom Face	0mm	ON	21100	2535	17.38	18.00	1.153	0.07	0.993	1.145
	LTE Band 7	20M	QPSK	1	0	Edge 1	0mm	ON	21100	2535	17.62	18.00	1.091	-0.01	0.270	0.295
	LTE Band 7	20M	QPSK	50	0	Edge 1	0mm	ON	21100	2535	17.50	18.00	1.122	0.03	0.271	0.304
	LTE Band 7	20M	QPSK	1	0	Edge 2	0mm	ON	21100	2535	17.62	18.00	1.091	0.1	0.592	0.646
	LTE Band 7	20M	QPSK	50	0	Edge 2	0mm	ON	21100	2535	17.50	18.00	1.122	0.05	0.620	0.696
	LTE Band 7	20M	QPSK	1	0	Bottom Face	11mm	OFF	21100	2535	21.22	23.00	1.507	0.07	0.255	0.384
	LTE Band 7	20M	QPSK	50	0	Bottom Face	11mm	OFF	21100	2535	20.20	22.00	1.514	0.03	0.195	0.295
	LTE Band 7	20M	QPSK	1	0	Edge 1	9mm	OFF	21100	2535	21.22	23.00	1.507	0.12	0.271	0.408
	LTE Band 7	20M	QPSK	50	0	Edge 1	9mm	OFF	21100	2535	20.20	22.00	1.514	0.07	0.186	0.282
	LTE Band 7	20M	QPSK	1	0	Edge 2	15mm	OFF	21100	2535	21.22	23.00	1.507	0.08	0.124	0.187
	LTE Band 7	20M	QPSK	50	0	Edge 2	15mm	OFF	21100	2535	20.20	22.00	1.514	0.12	0.102	0.154



Plot No.	Band	BW (MHz)	Modulation	RB Size	RB offset	Test Position	Gap (mm)	Power Reduction	Ch.	Freq. (MHz)	Average Power (dBm)	Tune-Up Limit (dBm)	Tune-up Scaling Factor	Power Drift (dB)	Measured 1g SAR (W/kg)	Reported 1g SAR (W/kg)
06	LTE Band 12	10M	QPSK	1	0	Bottom Face	0mm	ON	23095	707.5	19.28	20.50	1.324	0.16	0.768	1.017
	LTE Band 12	10M	QPSK	25	0	Bottom Face	0mm	ON	23095	707.5	19.19	20.50	1.352	0.1	0.712	0.963
	LTE Band 12	10M	QPSK	50	0	Bottom Face	0mm	ON	23095	707.5	19.20	20.50	1.349	-0.12	0.695	0.938
	LTE Band 12	10M	QPSK	1	0	Edge 1	0mm	ON	23095	707.5	19.28	20.50	1.324	-0.01	0.075	0.099
	LTE Band 12	10M	QPSK	25	0	Edge 1	0mm	ON	23095	707.5	19.19	20.50	1.352	0.06	0.083	0.112
	LTE Band 12	10M	QPSK	1	0	Edge 2	0mm	ON	23095	707.5	19.28	20.50	1.324	-0.02	0.465	0.616
	LTE Band 12	10M	QPSK	25	0	Edge 2	0mm	ON	23095	707.5	19.19	20.50	1.352	-0.14	0.441	0.596
	LTE Band 12	10M	QPSK	1	0	Bottom Face	11mm	OFF	23095	707.5	22.72	24.00	1.343	-0.14	0.368	0.494
	LTE Band 12	10M	QPSK	25	0	Bottom Face	11mm	OFF	23095	707.5	21.38	23.00	1.452	-0.03	0.329	0.478
	LTE Band 12	10M	QPSK	1	0	Edge 1	9mm	OFF	23095	707.5	22.72	24.00	1.343	0.04	0.066	0.089
	LTE Band 12	10M	QPSK	25	0	Edge 1	9mm	OFF	23095	707.5	21.38	23.00	1.452	0.11	0.050	0.073
	LTE Band 12	10M	QPSK	1	0	Edge 2	15mm	OFF	23095	707.5	22.72	24.00	1.343	-0.04	0.163	0.219
	LTE Band 12	10M	QPSK	25	0	Edge 2	15mm	OFF	23095	707.5	21.38	23.00	1.452	-0.02	0.126	0.183
	LTE Band 12	10M	QPSK	1	0	Edge 3	0mm	OFF	23095	707.5	22.72	24.00	1.343	0.14	0.021	0.028
	LTE Band 12	10M	QPSK	25	0	Edge 3	0mm	OFF	23095	707.5	21.38	23.00	1.452	0.16	0.017	0.025
	LTE Band 12	10M	QPSK	1	0	Edge 4	0mm	OFF	23095	707.5	22.72	24.00	1.343	0.11	0.016	0.021
	LTE Band 12	10M	QPSK	25	0	Edge 4	0mm	OFF	23095	707.5	21.38	23.00	1.452	0.17	0.013	0.019
07	LTE Band 13	10M	QPSK	1	0	Bottom Face	0mm	ON	23230	782	19.84	21.00	1.306	-0.14	0.942	1.230
	LTE Band 13	10M	QPSK	25	0	Bottom Face	0mm	ON	23230	782	19.83	21.00	1.309	-0.11	0.916	1.199
	LTE Band 13	10M	QPSK	50	0	Bottom Face	0mm	ON	23230	782	19.81	21.00	1.315	-0.07	0.924	1.215
	LTE Band 13	10M	QPSK	1	0	Edge 1	0mm	ON	23230	782	19.84	21.00	1.306	0	0.151	0.197
	LTE Band 13	10M	QPSK	25	0	Edge 1	0mm	ON	23230	782	19.83	21.00	1.309	-0.17	0.145	0.190
	LTE Band 13	10M	QPSK	1	0	Edge 2	0mm	ON	23230	782	19.84	21.00	1.306	-0.03	0.574	0.750
	LTE Band 13	10M	QPSK	25	0	Edge 2	0mm	ON	23230	782	19.83	21.00	1.309	-0.11	0.601	0.787
	LTE Band 13	10M	QPSK	1	25	Bottom Face	11mm	OFF	23230	782	23.77	24.00	1.054	-0.09	0.638	0.673
	LTE Band 13	10M	QPSK	25	0	Bottom Face	11mm	OFF	23230	782	22.58	23.00	1.102	0.01	0.495	0.545
	LTE Band 13	10M	QPSK	1	25	Edge 1	9mm	OFF	23230	782	23.77	24.00	1.054	0.17	0.213	0.225
	LTE Band 13	10M	QPSK	25	0	Edge 1	9mm	OFF	23230	782	22.58	23.00	1.102	0.01	0.158	0.174
	LTE Band 13	10M	QPSK	1	25	Edge 2	15mm	OFF	23230	782	23.77	24.00	1.054	0.13	0.225	0.237
	LTE Band 13	10M	QPSK	25	0	Edge 2	15mm	OFF	23230	782	22.58	23.00	1.102	-0.03	0.175	0.193
	LTE Band 13	10M	QPSK	1	25	Edge 3	0mm	OFF	23230	782	23.77	24.00	1.054	-0.08	0.053	0.056
	LTE Band 13	10M	QPSK	25	0	Edge 3	0mm	OFF	23230	782	22.58	23.00	1.102	0.1	0.039	0.043
	LTE Band 13	10M	QPSK	1	25	Edge 4	0mm	OFF	23230	782	23.77	24.00	1.054	-0.19	0.029	0.031
	LTE Band 13	10M	QPSK	25	0	Edge 4	0mm	OFF	23230	782	22.58	23.00	1.102	0	0.023	0.025



Plot No.	Band	BW (MHz)	Modulation	RB Size	RB offset	Test Position	Gap (mm)	Power Reduction	Ch.	Freq. (MHz)	Average Power (dBm)	Tune-Up Limit (dBm)	Tune-up Scaling Factor	Power Drift (dB)	Measured 1g SAR (W/kg)	Reported 1g SAR (W/kg)
	LTE Band 25	20M	QPSK	1	0	Bottom Face	0mm	ON	26340	1880	16.74	17.50	1.191	0	0.688	0.820
	LTE Band 25	20M	QPSK	1	0	Bottom Face	0mm	ON	26140	1860	16.59	17.50	1.233	-0.04	0.758	0.935
	LTE Band 25	20M	QPSK	1	0	Bottom Face	0mm	ON	26590	1905	16.64	17.50	1.219	-0.04	0.714	0.870
	LTE Band 25	20M	QPSK	50	0	Bottom Face	0mm	ON	26340	1880	16.50	17.50	1.259	-0.11	0.645	0.812
	LTE Band 25	20M	QPSK	50	0	Bottom Face	0mm	ON	26140	1860	16.44	17.50	1.276	-0.1	0.677	0.864
	LTE Band 25	20M	QPSK	50	0	Bottom Face	0mm	ON	26590	1905	16.49	17.50	1.262	-0.17	0.622	0.785
	LTE Band 25	20M	QPSK	100	0	Bottom Face	0mm	ON	26340	1880	16.55	17.50	1.245	-0.1	0.640	0.796
	LTE Band 25	20M	QPSK	1	0	Edge 1	0mm	ON	26340	1880	16.74	17.50	1.191	-0.18	0.418	0.498
	LTE Band 25	20M	QPSK	50	0	Edge 1	0mm	ON	26340	1880	16.50	17.50	1.259	-0.15	0.400	0.504
	LTE Band 25	20M	QPSK	1	0	Edge 2	0mm	ON	26340	1880	16.74	17.50	1.191	-0.19	0.841	1.002
08	LTE Band 25	20M	QPSK	1	0	Edge 2	0mm	ON	26140	1860	16.59	17.50	1.233	-0.04	0.896	1.105
	LTE Band 25	20M	QPSK	1	0	Edge 2	0mm	ON	26590	1905	16.64	17.50	1.219	-0.08	0.857	1.045
	LTE Band 25	20M	QPSK	50	0	Edge 2	0mm	ON	26340	1880	16.50	17.50	1.259	-0.15	0.743	0.935
	LTE Band 25	20M	QPSK	50	0	Edge 2	0mm	ON	26140	1860	16.44	17.50	1.276	-0.1	0.803	1.025
	LTE Band 25	20M	QPSK	50	0	Edge 2	0mm	ON	26590	1905	16.49	17.50	1.262	-0.13	0.717	0.905
	LTE Band 25	20M	QPSK	100	0	Edge 2	0mm	ON	26340	1880	16.55	17.50	1.245	-0.06	0.780	0.971
	LTE Band 25	20M	QPSK	1	0	Bottom Face	11mm	OFF	26340	1880	23.37	24.00	1.156	0	0.743	0.859
	LTE Band 25	20M	QPSK	1	0	Bottom Face	11mm	OFF	26140	1860	23.17	24.00	1.211	-0.15	0.802	0.971
	LTE Band 25	20M	QPSK	1	0	Bottom Face	11mm	OFF	26590	1905	23.29	24.00	1.178	-0.07	0.757	0.891
	LTE Band 25	20M	QPSK	50	0	Bottom Face	11mm	OFF	26340	1880	21.94	23.00	1.276	-0.16	0.572	0.730
	LTE Band 25	20M	QPSK	100	0	Bottom Face	11mm	OFF	26340	1880	21.74	23.00	1.337	-0.1	0.504	0.674
	LTE Band 25	20M	QPSK	1	0	Edge 1	9mm	OFF	26340	1880	23.37	24.00	1.156	-0.19	0.431	0.498
	LTE Band 25	20M	QPSK	50	0	Edge 1	9mm	OFF	26340	1880	21.94	23.00	1.276	-0.07	0.368	0.470
	LTE Band 25	20M	QPSK	1	0	Edge 2	15mm	OFF	26340	1880	23.37	24.00	1.156	0.08	0.563	0.651
	LTE Band 25	20M	QPSK	50	0	Edge 2	15mm	OFF	26340	1880	21.94	23.00	1.276	0	0.427	0.545
09	LTE Band 26	15M	QPSK	1	0	Bottom Face	0mm	ON	26865	831.5	19.90	21.00	1.288	-0.14	0.803	1.034
	LTE Band 26	15M	QPSK	36	0	Bottom Face	0mm	ON	26865	831.5	19.82	21.00	1.312	-0.1	0.788	1.034
	LTE Band 26	15M	QPSK	75	0	Bottom Face	0mm	ON	26865	831.5	19.80	21.00	1.318	-0.09	0.781	1.030
	LTE Band 26	15M	QPSK	1	0	Edge 1	0mm	ON	26865	831.5	19.90	21.00	1.288	-0.13	0.118	0.152
	LTE Band 26	15M	QPSK	36	0	Edge 1	0mm	ON	26865	831.5	19.82	21.00	1.312	0.05	0.112	0.147
	LTE Band 26	15M	QPSK	1	0	Edge 2	0mm	ON	26865	831.5	19.90	21.00	1.288	-0.1	0.508	0.654
	LTE Band 26	15M	QPSK	36	0	Edge 2	0mm	ON	26865	831.5	19.82	21.00	1.312	-0.17	0.501	0.657
	LTE Band 26	15M	QPSK	1	0	Bottom Face	11mm	OFF	26865	831.5	22.58	24.00	1.387	-0.15	0.385	0.534
	LTE Band 26	15M	QPSK	36	0	Bottom Face	11mm	OFF	26865	831.5	21.55	23.00	1.396	-0.14	0.308	0.430
	LTE Band 26	15M	QPSK	1	0	Edge 1	9mm	OFF	26865	831.5	22.58	24.00	1.387	-0.04	0.123	0.171
	LTE Band 26	15M	QPSK	36	0	Edge 1	9mm	OFF	26865	831.5	21.55	23.00	1.396	0.11	0.100	0.140
	LTE Band 26	15M	QPSK	1	0	Edge 2	15mm	OFF	26865	831.5	22.58	24.00	1.387	-0.01	0.165	0.229
	LTE Band 26	15M	QPSK	36	0	Edge 2	15mm	OFF	26865	831.5	21.55	23.00	1.396	0.11	0.140	0.195



<TDD LTE SAR>

Plot No.	Band	BW (MHz)	Modulation	RB Size	RB offset	Test Position	Gap (mm)	Power Reduction	Ch.	Freq. (MHz)	Average Power (dBm)	Tune-Up Limit (dBm)	Tune-up Scaling Factor	Power Drift (dB)	Duty Cycle %	Duty Cycle Scaling Factor	Measured 1g SAR (W/kg)	Reported 1g SAR (W/kg)
	LTE Band 41	20M	QPSK	1	0	Bottom Face	0mm	ON	40620	2593	17.36	18.00	1.159	-0.05	62.9	1.006	0.764	0.891
	LTE Band 41	20M	QPSK	1	0	Bottom Face	0mm	ON	39750	2506	17.05	18.00	1.245	-0.09	62.9	1.006	0.562	0.704
	LTE Band 41	20M	QPSK	1	0	Bottom Face	0mm	ON	40185	2549.5	16.91	18.00	1.285	-0.09	62.9	1.006	0.615	0.795
10	LTE Band 41	20M	QPSK	1	0	Bottom Face	0mm	ON	41055	2636.5	17.25	18.00	1.189	-0.05	62.9	1.006	1.060	1.267
	LTE Band 41	20M	QPSK	1	0	Bottom Face	0mm	ON	41490	2680	17.30	18.00	1.175	-0.04	62.9	1.006	0.925	1.093
	LTE Band 41	20M	QPSK	50	0	Bottom Face	0mm	ON	40620	2593	17.30	18.00	1.175	0.03	62.9	1.006	0.741	0.876
	LTE Band 41	20M	QPSK	50	0	Bottom Face	0mm	ON	39750	2506	17.24	18.00	1.191	0.08	62.9	1.006	0.492	0.590
	LTE Band 41	20M	QPSK	50	0	Bottom Face	0mm	ON	40185	2549.5	17.07	18.00	1.239	0.03	62.9	1.006	0.576	0.718
	LTE Band 41	20M	QPSK	50	0	Bottom Face	0mm	ON	41055	2636.5	17.29	18.00	1.178	0.02	62.9	1.006	1.020	1.208
	LTE Band 41	20M	QPSK	50	0	Bottom Face	0mm	ON	41490	2680	17.25	18.00	1.189	0.01	62.9	1.006	0.827	0.989
	LTE Band 41	20M	QPSK	100	0	Bottom Face	0mm	ON	40620	2593	17.20	18.00	1.202	0.13	62.9	1.006	0.793	0.959
	LTE Band 41	20M	QPSK	1	0	Edge 1	0mm	ON	40620	2593	17.36	18.00	1.159	-0.01	62.9	1.006	0.125	0.146
	LTE Band 41	20M	QPSK	50	0	Edge 1	0mm	ON	40620	2593	17.30	18.00	1.175	0.04	62.9	1.006	0.102	0.121
	LTE Band 41	20M	QPSK	1	0	Edge 2	0mm	ON	40620	2593	17.36	18.00	1.159	0.06	62.9	1.006	0.442	0.515
	LTE Band 41	20M	QPSK	50	0	Edge 2	0mm	ON	40620	2593	17.30	18.00	1.175	0.09	62.9	1.006	0.431	0.509
	LTE Band 41	20M	QPSK	1	0	Bottom Face	11mm	OFF	41490	2680	21.17	23.00	1.524	0.13	62.9	1.006	0.270	0.414
	LTE Band 41	20M	QPSK	50	0	Bottom Face	11mm	OFF	41490	2680	20.27	22.00	1.489	0.06	62.9	1.006	0.150	0.225
	LTE Band 41	20M	QPSK	1	0	Edge 1	9mm	OFF	41490	2680	21.17	23.00	1.524	0.1	62.9	1.006	0.098	0.150
	LTE Band 41	20M	QPSK	50	0	Edge 1	9mm	OFF	41490	2680	20.27	22.00	1.489	0.16	62.9	1.006	0.049	0.073
	LTE Band 41	20M	QPSK	1	0	Edge 2	15mm	OFF	41490	2680	21.17	23.00	1.524	0	62.9	1.006	0.082	0.126
	LTE Band 41	20M	QPSK	50	0	Edge 2	15mm	OFF	41490	2680	20.27	22.00	1.489	-0.01	62.9	1.006	0.065	0.097



**15.2 Repeated SAR Measurement**

No.	Band	BW (MHz)	Modulation	RB Size	RB offset	Mode	Test Position	Gap (mm)	Power Reduction	Ch.	Freq. (MHz)	Average Power (dBm)	Tune-Up Limit (dBm)	Tune-up Scaling Factor	Power Drift (dB)	Measured 1g SAR (W/kg)	Ratio	Reported 1g SAR (W/kg)
1st	WCDMA V					RMC 12.2Kbps	Bottom Face	0mm	ON	4182	836.4	20.00	21.50	1.413	0	0.804		1.136
2nd	WCDMA V					RMC 12.2Kbps	Bottom Face	0mm	ON	4182	836.4	20.00	21.50	1.413	0.02	0.787	1.02	1.112
1st	LTE Band 4	20M	QPSK	1	0		Edge 2	0mm	ON	20175	1732.5	16.61	17.50	1.227	0.15	1.050		1.289
2nd	LTE Band 4	20M	QPSK	1	0		Edge 2	0mm	ON	20175	1732.5	16.61	17.50	1.227	-0.19	1.040	1.01	1.277
1st	LTE Band 7	20M	QPSK	1	0		Bottom Face	0mm	ON	21350	2560	17.40	18.00	1.148	-0.11	1.100		1.263
2nd	LTE Band 7	20M	QPSK	1	0		Bottom Face	0mm	ON	21350	2560	17.40	18.00	1.148	0	1.060	1.04	1.217
1st	LTE Band 13	10M	QPSK	1	0		Bottom Face	0mm	ON	23230	782	19.84	21.00	1.306	-0.14	0.942		1.230
2nd	LTE Band 13	10M	QPSK	1	0		Bottom Face	0mm	ON	23230	782	19.84	21.00	1.306	-0.01	0.914	1.03	1.194
1st	LTE Band 25	20M	QPSK	1	0		Edge 2	0mm	ON	26140	1860	16.59	17.50	1.233	-0.04	0.896		1.105
2nd	LTE Band 25	20M	QPSK	1	0		Edge 2	0mm	ON	26140	1860	16.59	17.50	1.233	-0.13	0.894	1.00	1.102

**General Note:**

1. Per KDB 865664 D01v01r04, for each frequency band, repeated SAR measurement is required only when the measured SAR is  $\geq 0.8W/kg$ .
2. Per KDB 865664 D01v01r04, if the ratio among the repeated measurement is  $\leq 1.2$  and the measured SAR  $< 1.45W/kg$ , only one repeated measurement is required.
3. The ratio is the difference in percentage between original and repeated *measured SAR*.
4. All measurement SAR result is scaled-up to account for tune-up tolerance and is compliant.

**16. Simultaneous Transmission Analysis**

NO.	Simultaneous Transmission Configurations	Body
1.	WWAN + WLAN ANT1	Yes
2.	WWAN + WLAN ANT2	Yes
3.	WWAN + Bluetooth ANT2	Yes
4.	WLAN ANT1 + WLAN ANT2	Yes
5.	WLAN ANT1 + Bluetooth ANT2	Yes
6.	WWAN + WLAN ANT1 + WLAN ANT2	Yes
7.	WWAN + WLAN ANT1 + Bluetooth ANT2	Yes

**General Note:**

1. The Intel 8260D2W WLAN / Bluetooth module is also integrated into this host, WLAN /Bluetooth power and WLAN SAR testing results which can be referred to Sporton FCC SAR Test Report, FCC ID : PU5-TP00082A, Report No.: FA5N2711-05.
2. The worst case WLAN reported SAR for each configuration was used for SAR summation; therefore, the following summations represent the absolute worst cases for simultaneous transmission with WLAN.
3. For simultaneous transmission analysis for exposure position of 11mm for bottom face, 9mm for edge1, 15mm for edge2, WLAN SAR tested at 0mm separation is worse and the test data is used for conservative SAR summation.
4. The Scaled SAR summation is calculated based on the same configuration and test position.
5. For “no.4 and 5” simultaneous analysis please refers RF Exposure Report, Report No.: FA5N2711-05.
6. For “no.6 and 7” simultaneous transmission analysis exclusion was cover by “No.1 ~ No.5”, if each standalone SAR summation is < 1.6 or SPLSR analysis is < 0.04 according KDB 447498 D01v06, the additional analysis is not necessary.
7. Per KDB 447498 D01v06, simultaneous transmission SAR is compliant if,
  - i) Scalar SAR summation < 1.6W/kg.
  - ii)  $SPLSR = (SAR1 + SAR2)^{1.5} / (\text{min. separation distance, mm})$ , and the peak separation distance is determined from the square root of  $[(x1-x2)^2 + (y1-y2)^2 + (z1-z2)^2]$ , where (x1, y1, z1) and (x2, y2, z2) are the coordinates of the extrapolated peak SAR locations in the zoom scan.
  - iii) If  $SPLSR \leq 0.04$ , simultaneously transmission SAR measurement is not necessary.
  - iv) Simultaneously transmission SAR measurement, and the reported multi-band SAR < 1.6W/kg.
  - v) The SPLSR calculated results please refer to section 16.2.





**16.1 Body Exposure Conditions**

WWAN Band		Exposure Position	1	2	1+2 Summed 1g SAR (W/kg)	SPLSR	Case No
			WWAN 1g SAR (W/kg)	2.4GHz WLAN Ant 1 1g SAR (W/kg)			
WCDMA	WCDMA II	Bottom Face at 0mm	0.750	1.056	1.81	0.010	Case 1
		Edge 1 at 0mm	0.499		0.50		
		Edge 2 at 0mm	0.957		0.96		
		Bottom Face at 11mm	1.019	1.056	2.08	0.010	Case 2
		Edge 1 at 9mm	0.603		0.60		
		Edge 2 at 15mm	0.651		0.65		
	WCDMA IV	Bottom Face at 0mm	1.147	1.056	2.20	0.010	Case 3
		Edge 1 at 0mm	0.454		0.45		
		Edge 2 at 0mm	1.113		1.11		
		Bottom Face at 11mm	1.297	1.056	2.35	0.010	Case 4
		Edge 1 at 9mm	0.618		0.62		
		Edge 2 at 15mm	0.534		0.53		
	WCDMA V	Bottom Face at 0mm	1.136	1.056	2.19	0.010	Case 5
		Edge 1 at 0mm	0.200		0.20		
		Edge 2 at 0mm	0.671		0.67		
		Bottom Face at 11mm	0.503	1.056	1.56		
		Edge 1 at 9mm	0.181		0.18		
		Edge 2 at 15mm	0.251		0.25		
Edge 3 at 0mm		0.074		0.07			
Edge 4 at 0mm		0.022	0.436	0.46			
LTE	LTE Band 4	Bottom Face at 0mm	1.227	1.056	2.28	0.010	Case 6
		Edge 1 at 0mm	0.477		0.48		
		Edge 2 at 0mm	1.289		1.29		
		Bottom Face at 11mm	1.210	1.056	2.27	0.010	Case 7
		Edge 1 at 9mm	0.528		0.53		
		Edge 2 at 15mm	0.506		0.51		
	LTE Band 7	Bottom Face at 0mm	1.263	1.056	2.32	0.010	Case 8
		Edge 1 at 0mm	0.304		0.30		
		Edge 2 at 0mm	0.696		0.70		
		Bottom Face at 11mm	0.384	1.056	1.44		
		Edge 1 at 9mm	0.408		0.41		
		Edge 2 at 15mm	0.187		0.19		
	LTE Band 12	Bottom Face at 0mm	1.017	1.056	2.07	0.010	Case 9
		Edge 1 at 0mm	0.112		0.11		
		Edge 2 at 0mm	0.616		0.62		
		Bottom Face at 11mm	0.494	1.056	1.55		
		Edge 1 at 9mm	0.089		0.09		
		Edge 2 at 15mm	0.219		0.22		
Edge 3 at 0mm		0.028		0.03			
Edge 4 at 0mm		0.021	0.436	0.46			



WWAN Band		Exposure Position	1	2	1+2 Summed 1g SAR (W/kg)	SPLSR	Case No
			WWAN 1g SAR (W/kg)	2.4GHz WLAN Ant 1 1g SAR (W/kg)			
LTE	LTE Band 13	Bottom Face at 0mm	1.230	1.056	2.29	0.010	Case 10
		Edge 1 at 0mm	0.197		0.20		
		Edge 2 at 0mm	0.787		0.79		
		Bottom Face at 11mm	0.673	1.056	1.73	0.010	Case 11
		Edge 1 at 9mm	0.225		0.23		
		Edge 2 at 15mm	0.237		0.24		
		Edge 3 at 0mm	0.056		0.06		
	Edge 4 at 0mm	0.031	0.436	0.47			
	LTE Band 25	Bottom Face at 0mm	0.935	1.056	1.99	0.010	Case 12
		Edge 1 at 0mm	0.504		0.50		
		Edge 2 at 0mm	1.105		1.11		
		Bottom Face at 11mm	0.971	1.056	2.03	0.010	Case 13
		Edge 1 at 9mm	0.498		0.50		
	LTE Band 26	Edge 2 at 15mm	0.651		0.65		
		Bottom Face at 0mm	1.034	1.056	2.09	0.010	Case 14
		Edge 1 at 0mm	0.152		0.15		
		Edge 2 at 0mm	0.657		0.66		
		Bottom Face at 11mm	0.534	1.056	1.59		
	LTE Band 41	Edge 1 at 9mm	0.171		0.17		
		Edge 2 at 15mm	0.229		0.23		
		Bottom Face at 0mm	1.267	1.056	2.32	0.010	Case 15
Edge 1 at 0mm		0.146		0.15			
Edge 2 at 0mm		0.515		0.52			
Bottom Face at 11mm		0.414	1.056	1.47			
Edge 1 at 9mm	0.150		0.15				
Edge 2 at 15mm	0.126		0.13				



WWAN Band		Exposure Position	1	3	1+3 Summed 1g SAR (W/kg)	SPLSR	Case No
			WWAN 1g SAR (W/kg)	2.4GHz WLAN Ant 2 1g SAR (W/kg)			
WCDMA	WCDMA II	Bottom Face at 0mm	0.750	0.874	1.62	0.010	Case 16
		Edge 1 at 0mm	0.499	0.670	1.17		
		Edge 2 at 0mm	0.957		0.96		
		Bottom Face at 11mm	1.019	0.874	1.89	0.020	Case 17
		Edge 1 at 9mm	0.603	0.670	1.27		
		Edge 2 at 15mm	0.651		0.65		
	WCDMA IV	Bottom Face at 0mm	1.147	0.874	2.02	0.020	Case 18
		Edge 1 at 0mm	0.454	0.670	1.12		
		Edge 2 at 0mm	1.113		1.11		
		Bottom Face at 11mm	1.297	0.874	2.17	0.020	Case 19
		Edge 1 at 9mm	0.618	0.670	1.29		
	WCDMA V	Edge 2 at 15mm	0.534		0.53		
		Bottom Face at 0mm	1.136	0.874	2.01	0.020	Case 20
		Edge 1 at 0mm	0.200	0.670	0.87		
		Edge 2 at 0mm	0.671		0.67		
		Bottom Face at 11mm	0.503	0.874	1.38		
		Edge 1 at 9mm	0.181	0.670	0.85		
		Edge 2 at 15mm	0.251		0.25		
LTE	LTE Band 4	Edge 3 at 0mm	0.074		0.07		
		Edge 4 at 0mm	0.022		0.02		
		Bottom Face at 0mm	1.227	0.874	2.10	0.020	Case 21
		Edge 1 at 0mm	0.477	0.670	1.15		
		Edge 2 at 0mm	1.289		1.29		
		Bottom Face at 11mm	1.210	0.874	2.08	0.020	Case 22
	LTE Band 7	Edge 1 at 9mm	0.528	0.670	1.20		
		Edge 2 at 15mm	0.506		0.51		
		Bottom Face at 0mm	1.263	0.874	2.14	0.020	Case 23
		Edge 1 at 0mm	0.304	0.670	0.97		
		Edge 2 at 0mm	0.696		0.70		
		Bottom Face at 11mm	0.384	0.874	1.26		
Edge 1 at 9mm	0.408	0.670	1.08				
Edge 2 at 15mm	0.187		0.19				



WWAN Band		Exposure Position	1	3	1+3 Summed 1g SAR (W/kg)	SPLSR	Case No
			WWAN 1g SAR (W/kg)	2.4GHz WLAN Ant 2 1g SAR (W/kg)			
LTE	LTE Band 12	Bottom Face at 0mm	1.017	0.874	1.89	0.020	Case 24
		Edge 1 at 0mm	0.112	0.670	0.78		
		Edge 2 at 0mm	0.616		0.62		
		Bottom Face at 11mm	0.494	0.874	1.37		
		Edge 1 at 9mm	0.089	0.670	0.76		
		Edge 2 at 15mm	0.219		0.22		
		Edge 3 at 0mm	0.028		0.03		
		Edge 4 at 0mm	0.021		0.02		
	LTE Band 13	Bottom Face at 0mm	1.230	0.874	2.10	0.020	Case 25
		Edge 1 at 0mm	0.197	0.670	0.87		
		Edge 2 at 0mm	0.787		0.79		
		Bottom Face at 11mm	0.673	0.874	1.55		
		Edge 1 at 9mm	0.225	0.670	0.90		
		Edge 2 at 15mm	0.237		0.24		
		Edge 3 at 0mm	0.056		0.06		
		Edge 4 at 0mm	0.031		0.03		
	LTE Band 25	Bottom Face at 0mm	0.935	0.874	1.81	0.010	Case 26
		Edge 1 at 0mm	0.504	0.670	1.17		
		Edge 2 at 0mm	1.105		1.11		
		Bottom Face at 11mm	0.971	0.874	1.85	0.010	Case 27
		Edge 1 at 9mm	0.498	0.670	1.17		
		Edge 2 at 15mm	0.651		0.65		
	LTE Band 26	Bottom Face at 0mm	1.034	0.874	1.91	0.020	Case 28
		Edge 1 at 0mm	0.152	0.670	0.82		
		Edge 2 at 0mm	0.657		0.66		
		Bottom Face at 11mm	0.534	0.874	1.41		
		Edge 1 at 9mm	0.171	0.670	0.84		
		Edge 2 at 15mm	0.229		0.23		
	LTE Band 41	Bottom Face at 0mm	1.267	0.874	2.14	0.020	Case 29
		Edge 1 at 0mm	0.146	0.670	0.82		
Edge 2 at 0mm		0.515		0.52			
Bottom Face at 11mm		0.414	0.874	1.29			
Edge 1 at 9mm		0.150	0.670	0.82			
	Edge 2 at 15mm	0.126		0.13			



WWAN Band		Exposure Position	1	4	1+4 Summed 1g SAR (W/kg)	SPLSR(1+4)	Case No(1+4)
			WWAN 1g SAR (W/kg)	5GHz WLAN Ant 1 1g SAR (W/kg)			
WCDMA	WCDMA II	Bottom Face at 0mm	0.750	0.699	1.45		
		Edge 1 at 0mm	0.499		0.50		
		Edge 2 at 0mm	0.957		0.96		
		Bottom Face at 11mm	1.019	0.699	1.72	0.010	Case 30
		Edge 1 at 9mm	0.603		0.60		
		Edge 2 at 15mm	0.651		0.65		
	WCDMA IV	Bottom Face at 0mm	1.147	0.699	1.85	0.010	Case 31
		Edge 1 at 0mm	0.454		0.45		
		Edge 2 at 0mm	1.113		1.11		
		Bottom Face at 11mm	1.297	0.699	2.00	0.010	Case 32
		Edge 1 at 9mm	0.618		0.62		
		Edge 2 at 15mm	0.534		0.53		
	WCDMA V	Bottom Face at 0mm	1.136	0.699	1.84	0.010	Case 33
		Edge 1 at 0mm	0.200		0.20		
		Edge 2 at 0mm	0.671		0.67		
		Bottom Face at 11mm	0.503	0.699	1.20		
		Edge 1 at 9mm	0.181		0.18		
		Edge 2 at 15mm	0.251		0.25		
LTE	LTE Band 4	Bottom Face at 0mm	1.227	0.699	1.93	0.010	Case 34
		Edge 1 at 0mm	0.477		0.48		
		Edge 2 at 0mm	1.289		1.29		
		Bottom Face at 11mm	1.210	0.699	1.91	0.010	Case 35
		Edge 1 at 9mm	0.528		0.53		
		Edge 2 at 15mm	0.506		0.51		
	LTE Band 7	Bottom Face at 0mm	1.263	0.699	1.96	0.010	Case 36
		Edge 1 at 0mm	0.304		0.30		
		Edge 2 at 0mm	0.696		0.70		
		Bottom Face at 11mm	0.384	0.699	1.08		
		Edge 1 at 9mm	0.408		0.41		
		Edge 2 at 15mm	0.187		0.19		



WWAN Band		Exposure Position	1	4	1+4 Summed 1g SAR (W/kg)	SPLSR	Case No
			WWAN 1g SAR (W/kg)	5GHz WLAN Ant 1 1g SAR (W/kg)			
LTE	LTE Band 12	Bottom Face at 0mm	1.017	0.699	1.72	0.010	Case 37
		Edge 1 at 0mm	0.112		0.11		
		Edge 2 at 0mm	0.616		0.62		
		Bottom Face at 11mm	0.494	0.699	1.19		
		Edge 1 at 9mm	0.089		0.09		
		Edge 2 at 15mm	0.219		0.22		
		Edge 3 at 0mm	0.028		0.03		
		Edge 4 at 0mm	0.021	0.640	0.66		
	LTE Band 13	Bottom Face at 0mm	1.230	0.699	1.93	0.010	Case 38
		Edge 1 at 0mm	0.197		0.20		
		Edge 2 at 0mm	0.787		0.79		
		Bottom Face at 11mm	0.673	0.699	1.37		
		Edge 1 at 9mm	0.225		0.23		
		Edge 2 at 15mm	0.237		0.24		
		Edge 3 at 0mm	0.056		0.06		
		Edge 4 at 0mm	0.031	0.640	0.67		
	LTE Band 25	Bottom Face at 0mm	0.935	0.699	1.63	0.010	Case 39
		Edge 1 at 0mm	0.504		0.50		
		Edge 2 at 0mm	1.105		1.11		
		Bottom Face at 11mm	0.971	0.699	1.67	0.010	Case 40
		Edge 1 at 9mm	0.498		0.50		
		Edge 2 at 15mm	0.651		0.65		
	LTE Band 26	Bottom Face at 0mm	1.034	0.699	1.73	0.010	Case 41
		Edge 1 at 0mm	0.152		0.15		
		Edge 2 at 0mm	0.657		0.66		
		Bottom Face at 11mm	0.534	0.699	1.23		
		Edge 1 at 9mm	0.171		0.17		
		Edge 2 at 15mm	0.229		0.23		
LTE Band 41	Bottom Face at 0mm	1.267	0.699	1.97	0.010	Case 42	
	Edge 1 at 0mm	0.146		0.15			
	Edge 2 at 0mm	0.515		0.52			
	Bottom Face at 11mm	0.414	0.699	1.11			
	Edge 1 at 9mm	0.150		0.15			
	Edge 2 at 15mm	0.126		0.13			



WWAN Band		Exposure Position	1	5	1+5 Summed 1g SAR (W/kg)	SPLSR	Case No
			WWAN 1g SAR (W/kg)	5GHz WLAN Ant 2 1g SAR (W/kg)			
WCDMA	WCDMA II	Bottom Face at 0mm	0.750	0.766	1.52		
		Edge 1 at 0mm	0.499	1.122	1.62	0.010	Case 43
		Edge 2 at 0mm	0.957		0.96		
		Bottom Face at 11mm	1.019	0.766	1.79	0.010	Case 44
		Edge 1 at 9mm	0.603	1.122	1.73	0.020	Case 45
		Edge 2 at 15mm	0.651		0.65		
	WCDMA IV	Bottom Face at 0mm	1.147	0.766	1.91	0.020	Case 46
		Edge 1 at 0mm	0.454	1.122	1.58		
		Edge 2 at 0mm	1.113		1.11		
		Bottom Face at 11mm	1.297	0.766	2.06	0.020	Case 47
		Edge 1 at 9mm	0.618	1.122	1.74	0.020	Case 48
		Edge 2 at 15mm	0.534		0.53		
	WCDMA V	Bottom Face at 0mm	1.136	0.766	1.90	0.020	Case 49
		Edge 1 at 0mm	0.200	1.122	1.32		
		Edge 2 at 0mm	0.671		0.67		
		Bottom Face at 11mm	0.503	0.766	1.27		
		Edge 1 at 9mm	0.181	1.122	1.30		
		Edge 2 at 15mm	0.251		0.25		
LTE	LTE Band 4	Bottom Face at 0mm	1.227	0.766	1.99	0.020	Case 50
		Edge 1 at 0mm	0.477	1.122	1.60	0.010	Case 51
		Edge 2 at 0mm	1.289		1.29		
		Bottom Face at 11mm	1.210	0.766	1.98	0.020	Case 52
		Edge 1 at 9mm	0.528	1.122	1.65	0.010	Case 53
		Edge 2 at 15mm	0.506		0.51		
	LTE Band 7	Bottom Face at 0mm	1.263	0.766	2.03	0.020	Case 54
		Edge 1 at 0mm	0.304	1.122	1.43		
		Edge 2 at 0mm	0.696		0.70		
		Bottom Face at 11mm	0.384	0.766	1.15		
		Edge 1 at 9mm	0.408	1.122	1.53		
		Edge 2 at 15mm	0.187		0.19		



WWAN Band		Exposure Position	1	5	1+5 Summed 1g SAR (W/kg)	SPLSR	Case No
			WWAN 1g SAR (W/kg)	5GHz WLAN Ant 2 1g SAR (W/kg)			
LTE	LTE Band 12	Bottom Face at 0mm	1.017	0.766	1.78	0.010	Case 55
		Edge 1 at 0mm	0.112	1.122	1.23		
		Edge 2 at 0mm	0.616		0.62		
		Bottom Face at 11mm	0.494	0.766	1.26		
		Edge 1 at 9mm	0.089	1.122	1.21		
		Edge 2 at 15mm	0.219		0.22		
		Edge 3 at 0mm	0.028		0.03		
		Edge 4 at 0mm	0.021		0.02		
	LTE Band 13	Bottom Face at 0mm	1.230	0.766	2.00	0.020	Case 56
		Edge 1 at 0mm	0.197	1.122	1.32		
		Edge 2 at 0mm	0.787		0.79		
		Bottom Face at 11mm	0.673	0.766	1.44		
		Edge 1 at 9mm	0.225	1.122	1.35		
		Edge 2 at 15mm	0.237		0.24		
		Edge 3 at 0mm	0.056		0.06		
		Edge 4 at 0mm	0.031		0.03		
	LTE Band 25	Bottom Face at 0mm	0.935	0.766	1.70	0.010	Case 57
		Edge 1 at 0mm	0.504	1.122	1.63	0.010	Case 58
		Edge 2 at 0mm	1.105		1.11		
		Bottom Face at 11mm	0.971	0.766	1.74	0.010	Case 59
		Edge 1 at 9mm	0.498	1.122	1.62	0.020	Case 60
		Edge 2 at 15mm	0.651		0.65		
	LTE Band 26	Bottom Face at 0mm	1.034	0.766	1.80	0.010	Case 61
		Edge 1 at 0mm	0.152	1.122	1.27		
		Edge 2 at 0mm	0.657		0.66		
		Bottom Face at 11mm	0.534	0.766	1.30		
		Edge 1 at 9mm	0.171	1.122	1.29		
		Edge 2 at 15mm	0.229		0.23		
	LTE Band 41	Bottom Face at 0mm	1.267	0.766	2.03	0.020	Case 62
		Edge 1 at 0mm	0.146	1.122	1.27		
Edge 2 at 0mm		0.515		0.52			
Bottom Face at 11mm		0.414	0.766	1.18			
Edge 1 at 9mm		0.150	1.122	1.27			
	Edge 2 at 15mm	0.126		0.13			





WWAN Band		Exposure Position	1	6	1+6 Summed 1g SAR (W/kg)	SPLSR	Case No
			WWAN	Bluetooth Ant 2			
			1g SAR (W/kg)	1g SAR (W/kg)			
WCDMA	WCDMA II	Bottom Face at 0mm	0.750	0.001	<b>0.75</b>		
		Edge 1 at 0mm	0.499	0.032	<b>0.53</b>		
		Edge 2 at 0mm	0.957		<b>0.96</b>		
		Bottom Face at 11mm	1.019	0.001	<b>1.02</b>		
		Edge 1 at 9mm	0.603	0.032	<b>0.64</b>		
		Edge 2 at 15mm	0.651		<b>0.65</b>		
	WCDMA IV	Bottom Face at 0mm	1.147	0.001	<b>1.15</b>		
		Edge 1 at 0mm	0.454	0.032	<b>0.49</b>		
		Edge 2 at 0mm	1.113		<b>1.11</b>		
		Bottom Face at 11mm	1.297	0.001	<b>1.30</b>		
		Edge 1 at 9mm	0.618	0.032	<b>0.65</b>		
		Edge 2 at 15mm	0.534		<b>0.53</b>		
	WCDMA V	Bottom Face at 0mm	1.136	0.001	<b>1.14</b>		
		Edge 1 at 0mm	0.200	0.032	<b>0.23</b>		
		Edge 2 at 0mm	0.671		<b>0.67</b>		
		Bottom Face at 11mm	0.503	0.001	<b>0.50</b>		
		Edge 1 at 9mm	0.181	0.032	<b>0.21</b>		
		Edge 2 at 15mm	0.251		<b>0.25</b>		
Edge 3 at 0mm		0.074		<b>0.07</b>			
Edge 4 at 0mm	0.022		<b>0.02</b>				
LTE	LTE Band 4	Bottom Face at 0mm	1.227	0.001	<b>1.23</b>		
		Edge 1 at 0mm	0.477	0.032	<b>0.51</b>		
		Edge 2 at 0mm	1.289		<b>1.29</b>		
		Bottom Face at 11mm	1.210	0.001	<b>1.21</b>		
		Edge 1 at 9mm	0.528	0.032	<b>0.56</b>		
		Edge 2 at 15mm	0.506		<b>0.51</b>		
	LTE Band 7	Bottom Face at 0mm	1.263	0.001	<b>1.26</b>		
		Edge 1 at 0mm	0.304	0.032	<b>0.34</b>		
		Edge 2 at 0mm	0.696		<b>0.70</b>		
		Bottom Face at 11mm	0.384	0.001	<b>0.39</b>		
		Edge 1 at 9mm	0.408	0.032	<b>0.44</b>		
Edge 2 at 15mm	0.187		<b>0.19</b>				



WWAN Band		Exposure Position	1	6	1+6 Summed 1g SAR (W/kg)	SPLSR	Case No
			WWAN	Bluetooth Ant 2			
			1g SAR (W/kg)	1g SAR (W/kg)			
LTE	LTE Band 12	Bottom Face at 0mm	1.017	0.001	<b>1.02</b>		
		Edge 1 at 0mm	0.112	0.032	<b>0.14</b>		
		Edge 2 at 0mm	0.616		<b>0.62</b>		
		Bottom Face at 11mm	0.494	0.001	<b>0.50</b>		
		Edge 1 at 9mm	0.089	0.032	<b>0.12</b>		
		Edge 2 at 15mm	0.219		<b>0.22</b>		
		Edge 3 at 0mm	0.028		<b>0.03</b>		
	Edge 4 at 0mm	0.021		<b>0.02</b>			
	LTE Band 13	Bottom Face at 0mm	1.230	0.001	<b>1.23</b>		
		Edge 1 at 0mm	0.197	0.032	<b>0.23</b>		
		Edge 2 at 0mm	0.787		<b>0.79</b>		
		Bottom Face at 11mm	0.673	0.001	<b>0.67</b>		
		Edge 1 at 9mm	0.225	0.032	<b>0.26</b>		
		Edge 2 at 15mm	0.237		<b>0.24</b>		
		Edge 3 at 0mm	0.056		<b>0.06</b>		
	Edge 4 at 0mm	0.031		<b>0.03</b>			
	LTE Band 25	Bottom Face at 0mm	0.935	0.001	<b>0.94</b>		
		Edge 1 at 0mm	0.504	0.032	<b>0.54</b>		
		Edge 2 at 0mm	1.105		<b>1.11</b>		
		Bottom Face at 11mm	0.971	0.001	<b>0.97</b>		
		Edge 1 at 9mm	0.498	0.032	<b>0.53</b>		
	Edge 2 at 15mm	0.651		<b>0.65</b>			
	LTE Band 26	Bottom Face at 0mm	1.034	0.001	<b>1.04</b>		
		Edge 1 at 0mm	0.152	0.032	<b>0.18</b>		
		Edge 2 at 0mm	0.657		<b>0.66</b>		
		Bottom Face at 11mm	0.534	0.001	<b>0.54</b>		
		Edge 1 at 9mm	0.171	0.032	<b>0.20</b>		
	Edge 2 at 15mm	0.229		<b>0.23</b>			
	LTE Band 41	Bottom Face at 0mm	1.267	0.001	<b>1.27</b>		
		Edge 1 at 0mm	0.146	0.032	<b>0.18</b>		
Edge 2 at 0mm		0.515		<b>0.52</b>			
Bottom Face at 11mm		0.414	0.001	<b>0.42</b>			
Edge 1 at 9mm		0.150	0.032	<b>0.18</b>			
Edge 2 at 15mm	0.126		<b>0.13</b>				

**16.2 SPLSR Evaluation and Analysis**

**General Note:**

- SPLSR =  $(SAR_1 + SAR_2)^{1.5} / (\text{min. separation distance, mm})$ . If  $SPLSR \leq 0.04$ , simultaneously transmission SAR measurement is not necessary

Case 1	Band	Position	SAR (W/kg)	Gap	SAR peak location (m)			3D distance (mm)	Summed SAR (W/kg)	SPLSR Results	Simultaneous SAR
	WCDMA II			(cm)	X	Y	Z				
	WCDMA II	Bottom Face	0.75	0mm	0.075	0.142	-0.175	285.1	1.81	0.01	Not required
	WLAN2.4GHz Ant 1		1.056	0mm	0.0116	-0.136	-0.177				

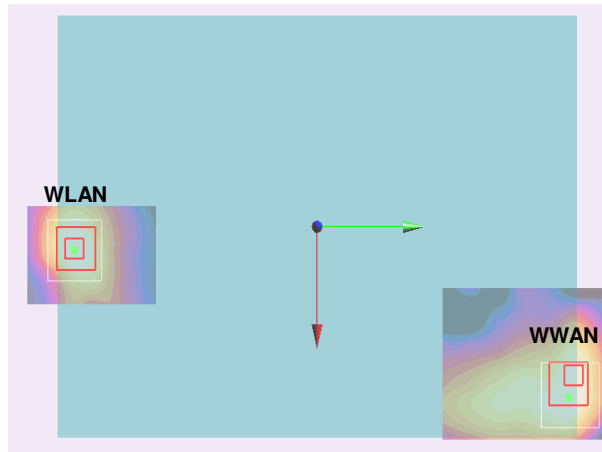

Case 2	Band	Position	SAR (W/kg)	Gap	SAR peak location (m)			3D distance (mm)	Summed SAR (W/kg)	SPLSR Results	Simultaneous SAR
	WCDMA II			(cm)	X	Y	Z				
	WCDMA II	Bottom Face	1.019	11mm	0.074	0.143	-0.177	285.9	2.08	0.01	Not required
	WLAN2.4GHz Ant 1		1.056	0mm	0.0116	-0.136	-0.177				

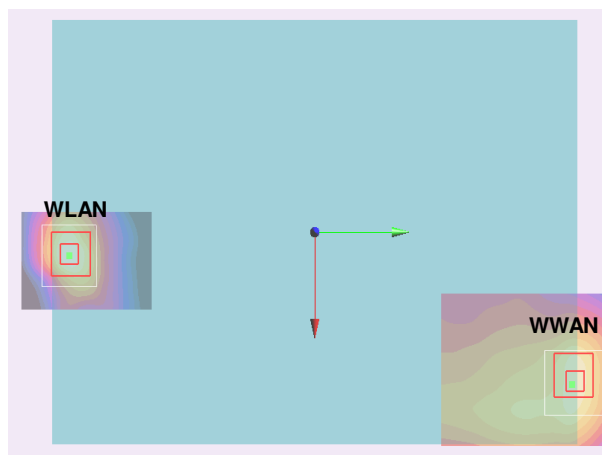

Case 3	Band	Position	SAR (W/kg)	Gap (cm)	SAR peak location (m)			3D distance (mm)	Summed SAR (W/kg)	SPLSR Results	Simultaneous SAR
	WCDMA IV				X	Y	Z				
	WLAN2.4GHz Ant 1	Bottom Face	1.147	0mm	0.0725	0.145	-0.176	287.5	2.20	0.01	Not required
	WLAN2.4GHz Ant 1		1.056	0mm	0.0116	-0.136	-0.177				

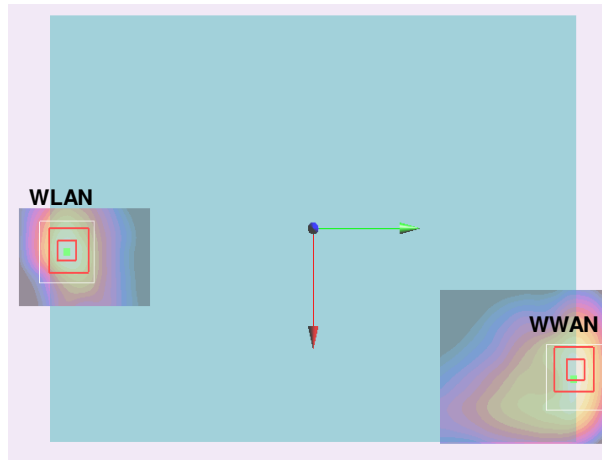

Case 4	Band	Position	SAR (W/kg)	Gap (cm)	SAR peak location (m)			3D distance (mm)	Summed SAR (W/kg)	SPLSR Results	Simultaneous SAR
	WCDMA IV				X	Y	Z				
	WLAN2.4GHz Ant 1	Bottom Face	1.297	11mm	0.074	0.143	-0.176	285.9	2.35	0.01	Not required
	WLAN2.4GHz Ant 1		1.056	0mm	0.0116	-0.136	-0.177				

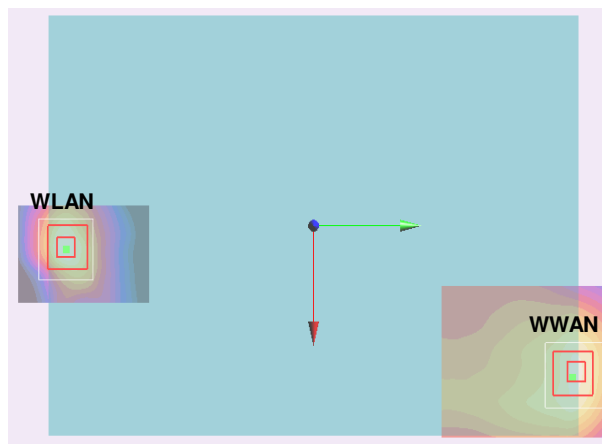

Case 5	Band	Position	SAR (W/kg)	Gap (cm)	SAR peak location (m)			3D distance (mm)	Summed SAR (W/kg)	SPLSR Results	Simultaneous SAR
	WCDMA V				X	Y	Z				
	WLAN2.4GHz Ant 1	Bottom Face	1.136	0mm	0.07	0.142	-0.176	284.1	2.19	0.01	Not required
			1.056	0mm	0.0116	-0.136	-0.177				

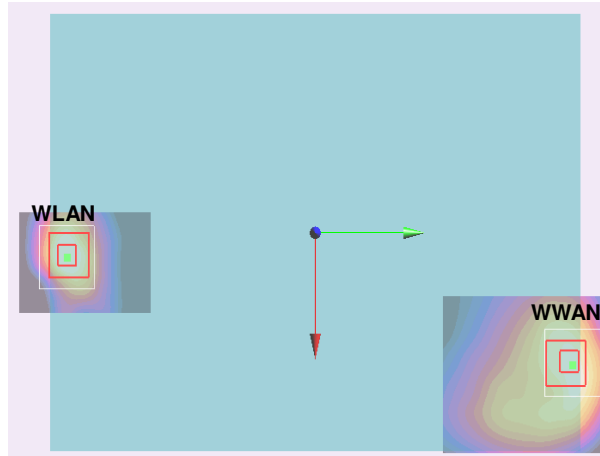

Case 6	Band	Position	SAR (W/kg)	Gap (cm)	SAR peak location (m)			3D distance (mm)	Summed SAR (W/kg)	SPLSR Results	Simultaneous SAR
	LTE Band 4				X	Y	Z				
	WLAN2.4GHz Ant 1	Bottom Face	1.227	0mm	0.0725	0.145	-0.176	287.5	2.28	0.01	Not required
			1.056	0mm	0.0116	-0.136	-0.177				

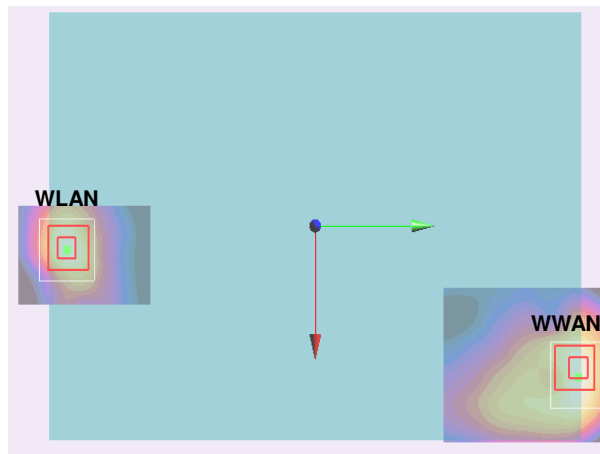

Case 7	Band	Position	SAR (W/kg)	Gap (cm)	SAR peak location (m)			3D distance (mm)	Summed SAR (W/kg)	SPLSR Results	Simultaneous SAR
					X	Y	Z				
	LTE Band 4	Bottom Face	1.21	11mm	0.0665	0.143	-0.177	284.4	2.27	0.01	Not required
	WLAN2.4GHz Ant 1		1.056	0mm	0.0116	-0.136	-0.177				

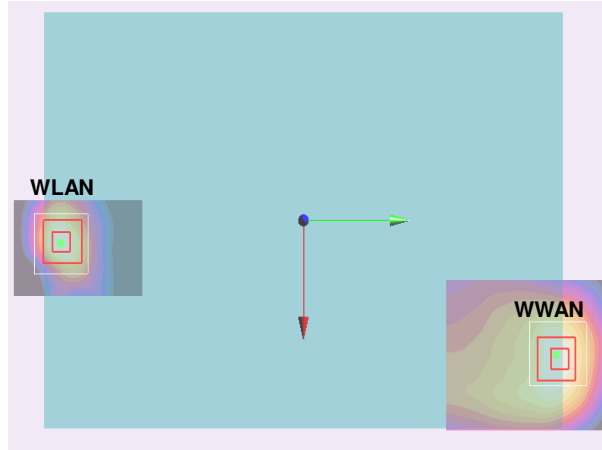

Case 8	Band	Position	SAR (W/kg)	Gap (cm)	SAR peak location (m)			3D distance (mm)	Summed SAR (W/kg)	SPLSR Results	Simultaneous SAR
					X	Y	Z				
	LTE Band 7	Bottom Face	1.263	0mm	0.078	0.137	-0.175	281.0	2.32	0.01	Not required
	WLAN2.4GHz Ant 1		1.056	0mm	0.0116	-0.136	-0.177				

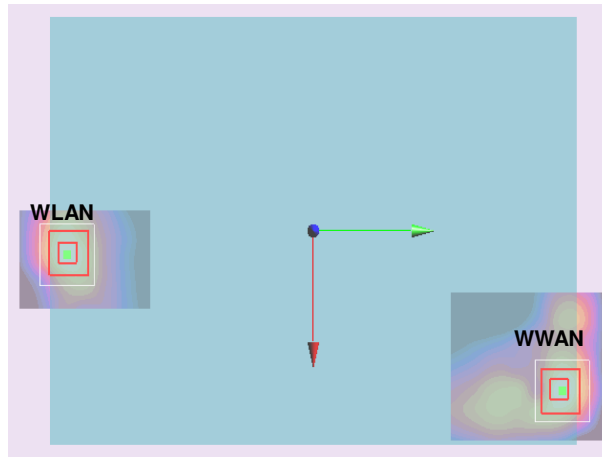

Case 9	Band	Position	SAR (W/kg)	Gap (cm)	SAR peak location (m)			3D distance (mm)	Summed SAR (W/kg)	SPLSR Results	Simultaneous SAR
					X	Y	Z				
	LTE Band 12	Bottom Face	1.017	0mm	0.059	0.143	-0.176	283.0	2.07	0.01	Not required
	WLAN2.4GHz Ant 1		1.056	0mm	0.0116	-0.136	-0.177				

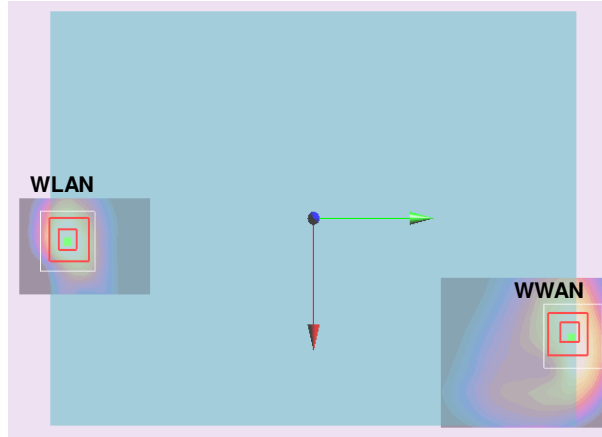

Case 10	Band	Position	SAR (W/kg)	Gap (cm)	SAR peak location (m)			3D distance (mm)	Summed SAR (W/kg)	SPLSR Results	Simultaneous SAR
					X	Y	Z				
	LTE Band 13	Bottom Face	1.23	0mm	0.07	0.143	-0.176	285.0	2.29	0.01	Not required
	WLAN2.4GHz Ant 1		1.056	0mm	0.0116	-0.136	-0.177				

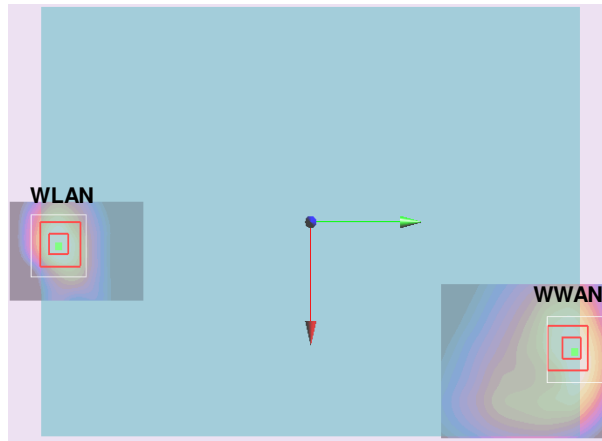

Case	Band	Position	SAR (W/kg)	Gap (cm)	SAR peak location (m)			3D distance (mm)	Summed SAR (W/kg)	SPLSR Results	Simultaneous SAR
					X	Y	Z				
11	LTE Band 13	Bottom Face	0.673	11mm	0.0725	0.145	-0.177	287.5	1.73	0.01	Not required
	WLAN2.4GHz Ant 1		1.056	0mm	0.0116	-0.136	-0.177				

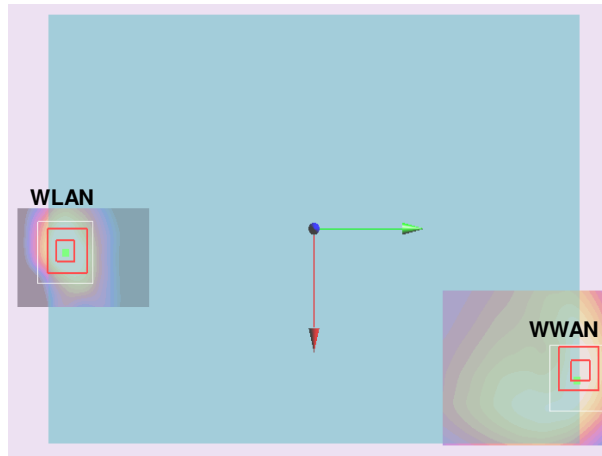

Case	Band	Position	SAR (W/kg)	Gap (cm)	SAR peak location (m)			3D distance (mm)	Summed SAR (W/kg)	SPLSR Results	Simultaneous SAR
					X	Y	Z				
12	LTE Band 25	Bottom Face	0.935	0mm	0.075	0.142	-0.175	285.1	1.99	0.01	Not required
	WLAN2.4GHz Ant 1		1.056	0mm	0.0116	-0.136	-0.177				

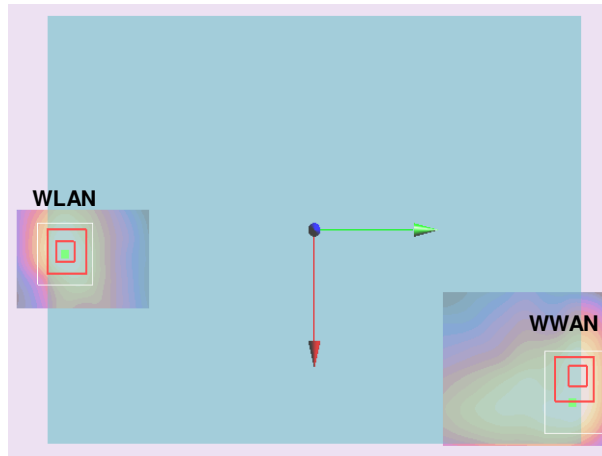



Case	Band	Position	SAR (W/kg)	Gap (cm)	SAR peak location (m)			3D distance (mm)	Summed SAR (W/kg)	SPLSR Results	Simultaneous SAR
					X	Y	Z				
13	LTE Band 25	Bottom Face	0.971	11mm	0.0635	0.145	-0.177	285.8	2.03	0.01	Not required
	WLAN2.4GHz Ant 1		1.056	0mm	0.0116	-0.136	-0.177				

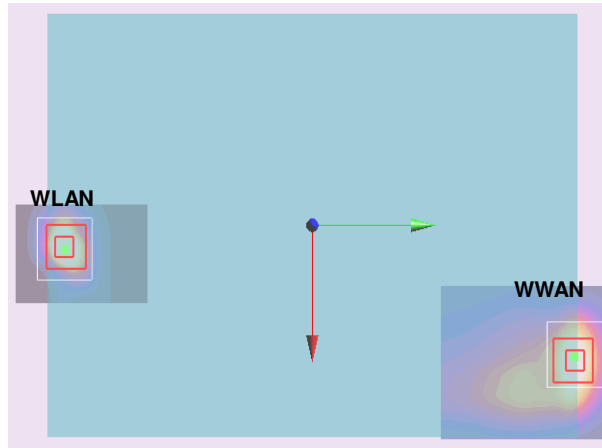

Case	Band	Position	SAR (W/kg)	Gap (cm)	SAR peak location (m)			3D distance (mm)	Summed SAR (W/kg)	SPLSR Results	Simultaneous SAR
					X	Y	Z				
14	LTE Band 26	Bottom Face	1.034	0mm	0.071	0.143	-0.176	285.3	2.09	0.01	Not required
	WLAN2.4GHz Ant 1		1.056	0mm	0.0116	-0.136	-0.177				

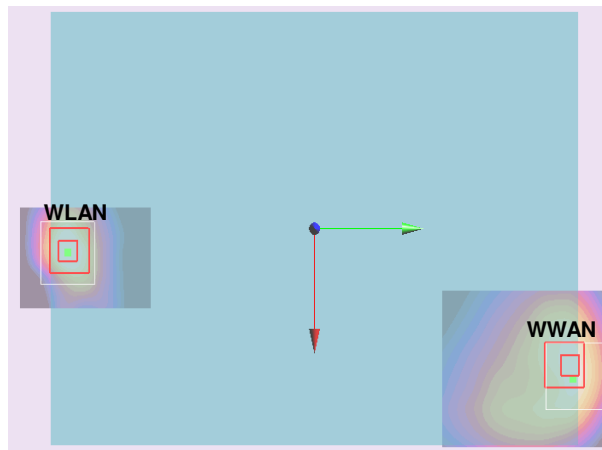

Case	Band	Position	SAR (W/kg)	Gap (cm)	SAR peak location (m)			3D distance (mm)	Summed SAR (W/kg)	SPLSR Results	Simultaneous SAR
					X	Y	Z				
15	LTE Band 41	Bottom Face	1.267	0mm	0.0796	0.14	-0.176	284.3	2.32	0.01	Not required
	WLAN2.4GHz Ant 1		1.056	0mm	0.0116	-0.136	-0.177				

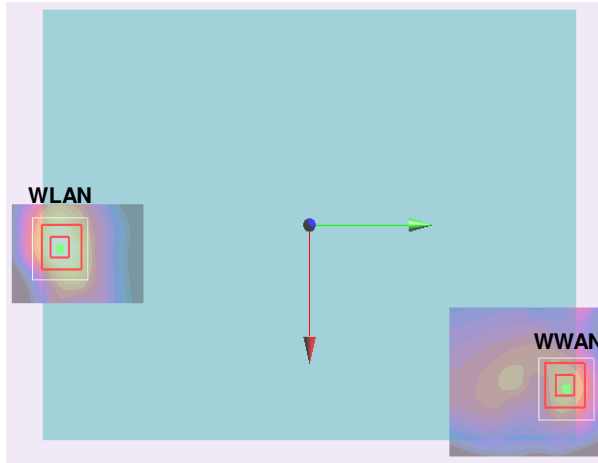

Case	Band	Position	SAR (W/kg)	Gap (cm)	SAR peak location (m)			3D distance (mm)	Summed SAR (W/kg)	SPLSR Results	Simultaneous SAR
					X	Y	Z				
16	WCDMA II	Bottom Face	0.75	0mm	0.075	0.142	-0.175	168.1	1.62	0.01	Not required
	WLAN2.4GHz Ant 2		0.874	0mm	0.0974	-0.0246	-0.176				

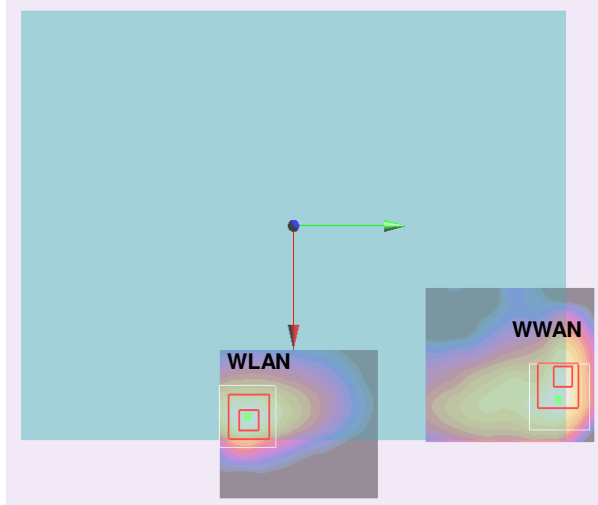

Case	Band	Position	SAR (W/kg)	Gap (cm)	SAR peak location (m)			3D distance (mm)	Summed SAR (W/kg)	SPLSR Results	Simultaneous SAR
					X	Y	Z				
17	WCDMA II	Bottom Face	1.019	11mm	0.074	0.143	-0.177	169.2	1.89	0.02	Not required
	WLAN2.4GHz Ant 2		0.874	0mm	0.0974	-0.0246	-0.176				

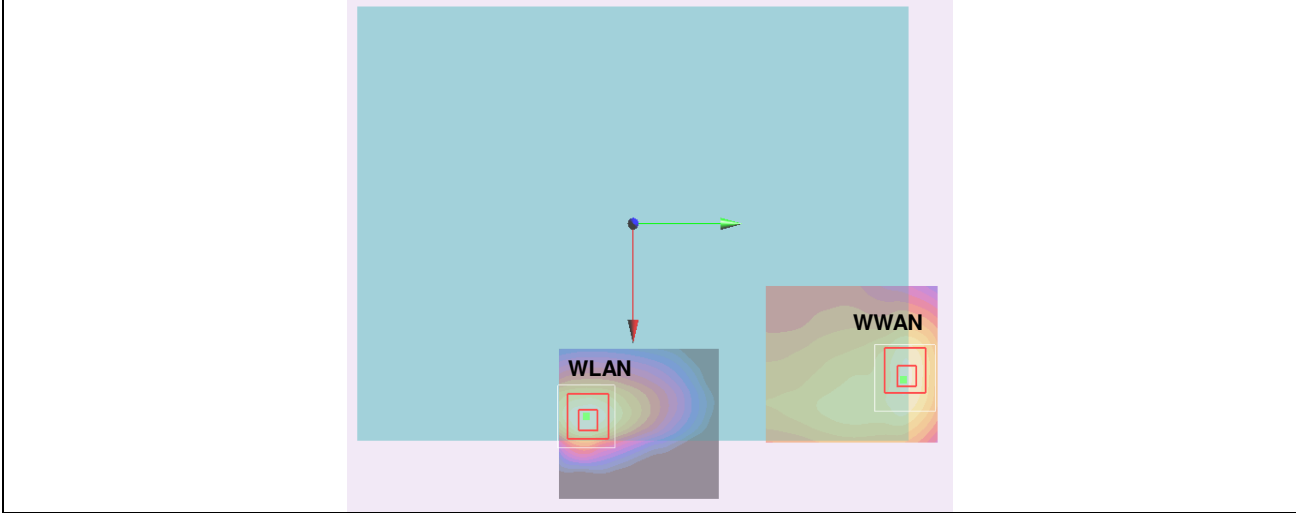

Case	Band	Position	SAR (W/kg)	Gap (cm)	SAR peak location (m)			3D distance (mm)	Summed SAR (W/kg)	SPLSR Results	Simultaneous SAR
					X	Y	Z				
18	WCDMA IV	Bottom Face	1.147	0mm	0.0725	0.145	-0.176	171.4	2.02	0.02	Not required
	WLAN2.4GHz Ant 2		0.874	0mm	0.0974	-0.0246	-0.176				

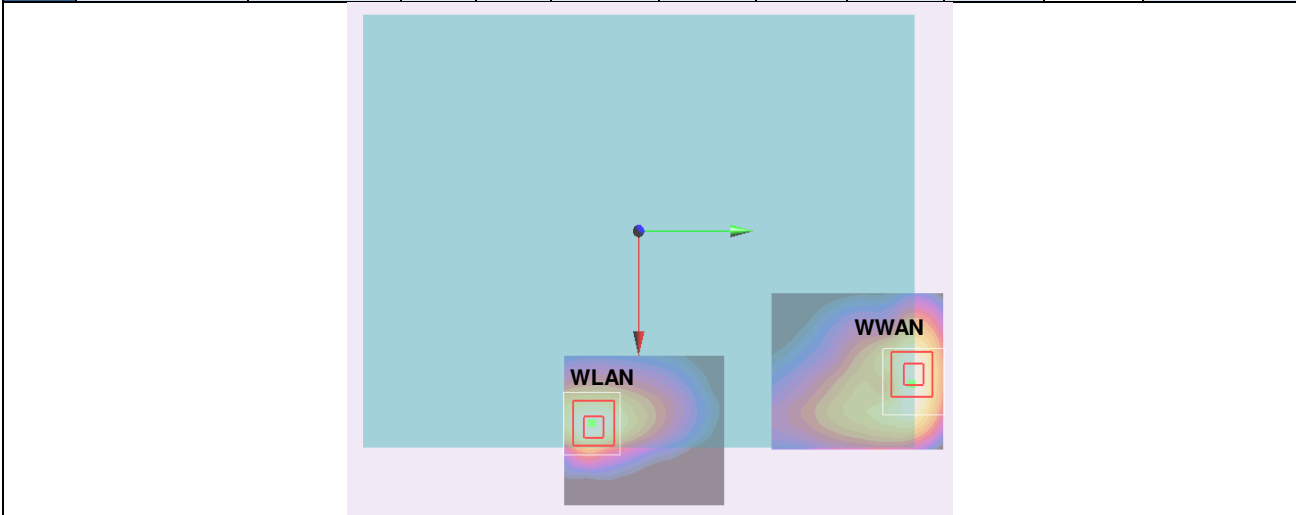

Case 19	Band	Position	SAR (W/kg)	Gap (cm)	SAR peak location (m)			3D distance (mm)	Summed SAR (W/kg)	SPLSR Results	Simultaneous SAR
	WCDMA IV				X	Y	Z				
	WLAN2.4GHz Ant 2				0.074	0.143	-0.176				
		Bottom Face	0.874	0mm	0.0974	-0.0246	-0.176	169.2	2.17	0.02	Not required

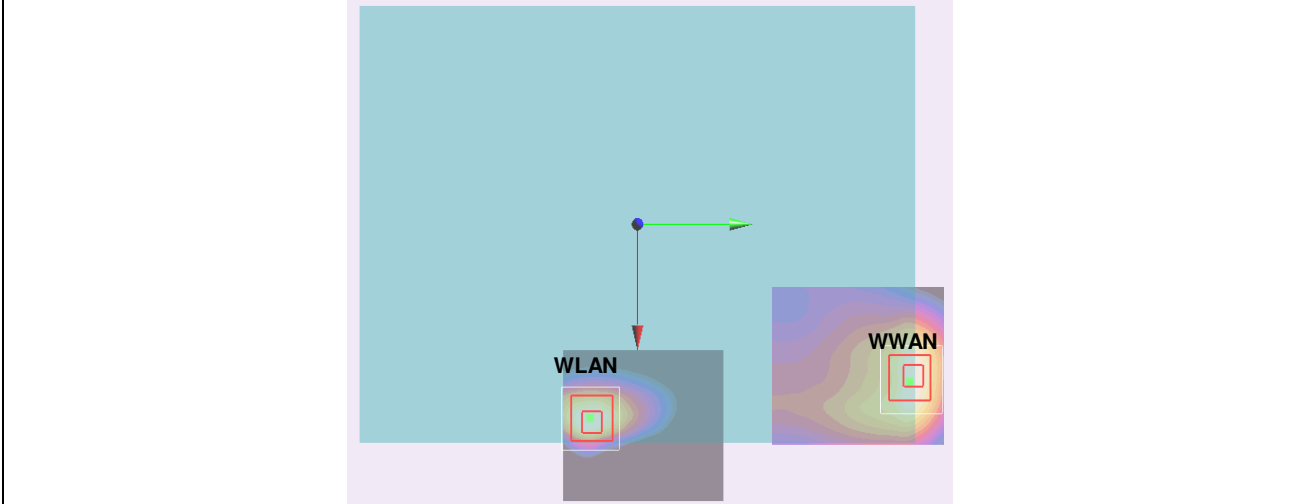

Case 20	Band	Position	SAR (W/kg)	Gap (cm)	SAR peak location (m)			3D distance (mm)	Summed SAR (W/kg)	SPLSR Results	Simultaneous SAR
	WCDMA V				X	Y	Z				
	WLAN2.4GHz Ant 2				0.07	0.142	-0.176				
		Bottom Face	0.874	0mm	0.0974	-0.0246	-0.176	168.8	2.01	0.02	Not required

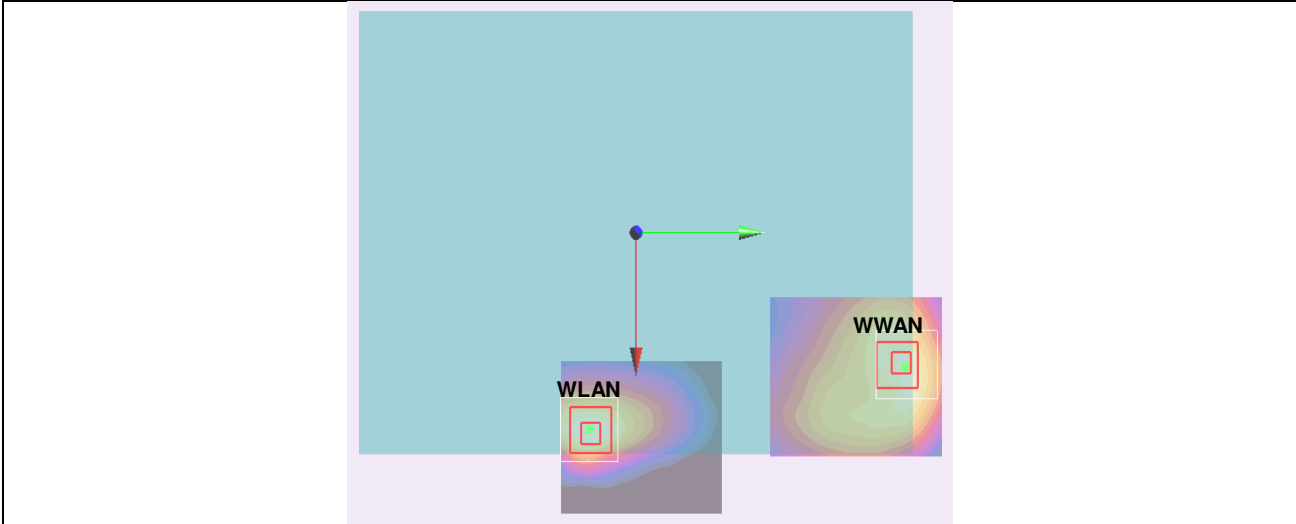

Case	Band	Position	SAR (W/kg)	Gap (cm)	SAR peak location (m)			3D distance (mm)	Summed SAR (W/kg)	SPLSR Results	Simultaneous SAR
					X	Y	Z				
21	LTE Band 4	Bottom Face	1.227	0mm	0.0725	0.145	-0.176	171.4	2.10	0.02	Not required
	WLAN2.4GHz Ant 2		0.874	0mm	0.0974	-0.0246	-0.176				

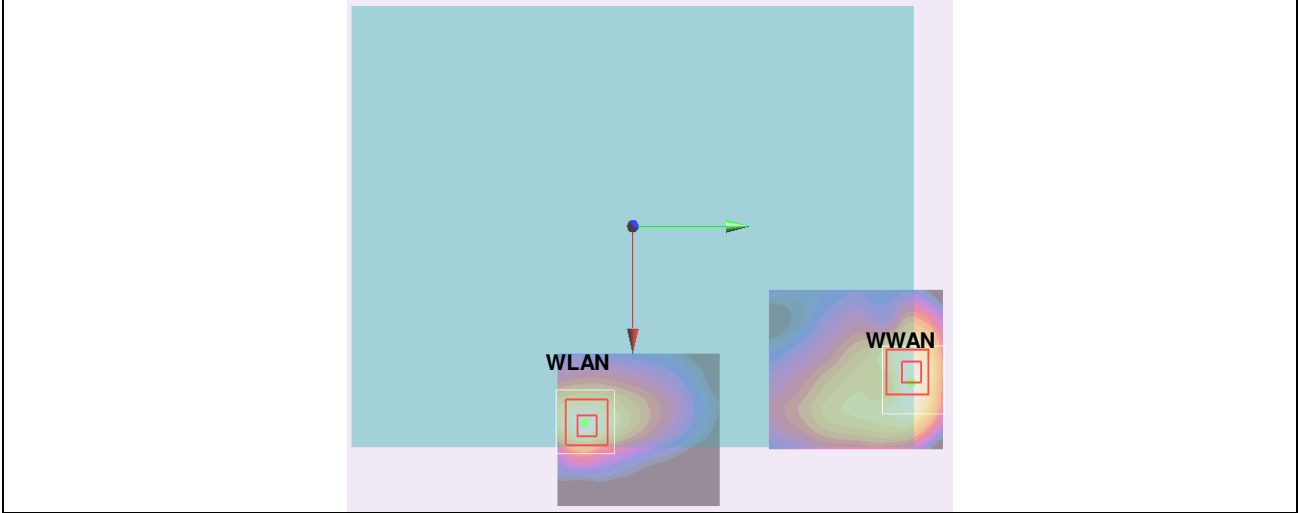

Case	Band	Position	SAR (W/kg)	Gap (cm)	SAR peak location (m)			3D distance (mm)	Summed SAR (W/kg)	SPLSR Results	Simultaneous SAR
					X	Y	Z				
22	LTE Band 4	Bottom Face	1.21	11mm	0.0665	0.143	-0.177	170.4	2.08	0.02	Not required
	WLAN2.4GHz Ant 2		0.874	0mm	0.0974	-0.0246	-0.176				

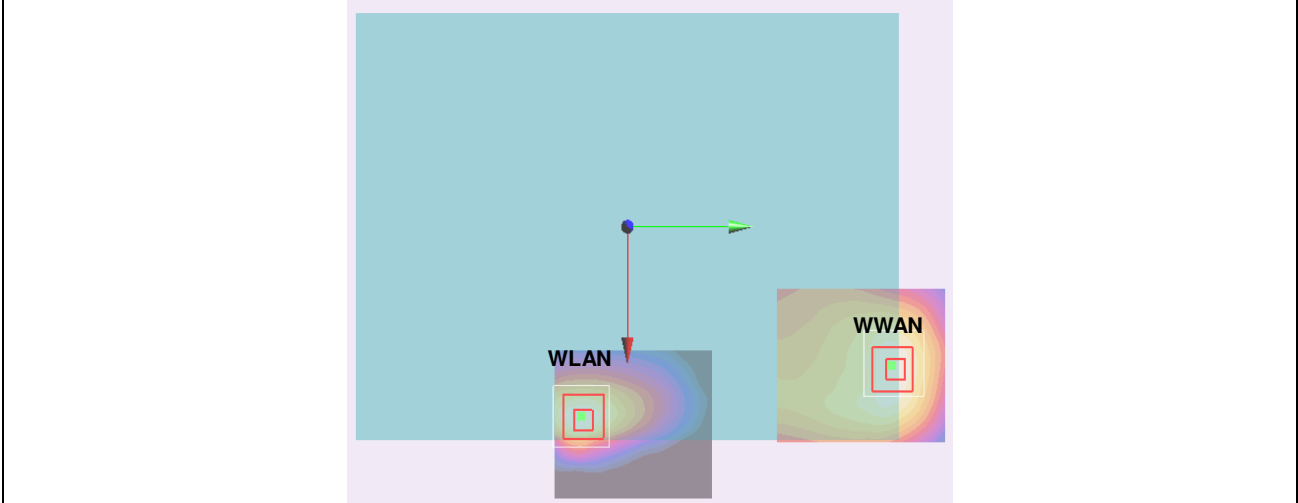

Case	Band	Position	SAR (W/kg)	Gap (cm)	SAR peak location (m)			3D distance (mm)	Summed SAR (W/kg)	SPLSR Results	Simultaneous SAR
					X	Y	Z				
23	LTE Band 7	Bottom Face	1.263	0mm	0.078	0.137	-0.175	162.8	2.14	0.02	Not required
	WLAN2.4GHz Ant 2		0.874	0mm	0.0974	-0.0246	-0.176				

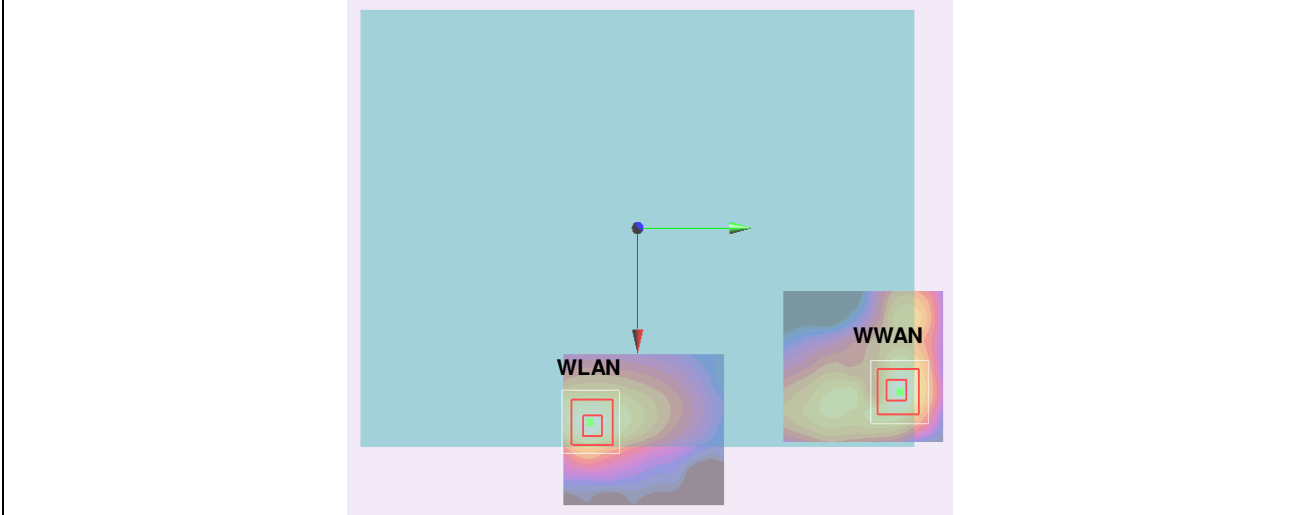

Case	Band	Position	SAR (W/kg)	Gap (cm)	SAR peak location (m)			3D distance (mm)	Summed SAR (W/kg)	SPLSR Results	Simultaneous SAR
					X	Y	Z				
24	LTE Band 12	Bottom Face	1.017	0mm	0.059	0.143	-0.176	171.9	1.89	0.02	Not required
	WLAN2.4GHz Ant 2		0.874	0mm	0.0974	-0.0246	-0.176				

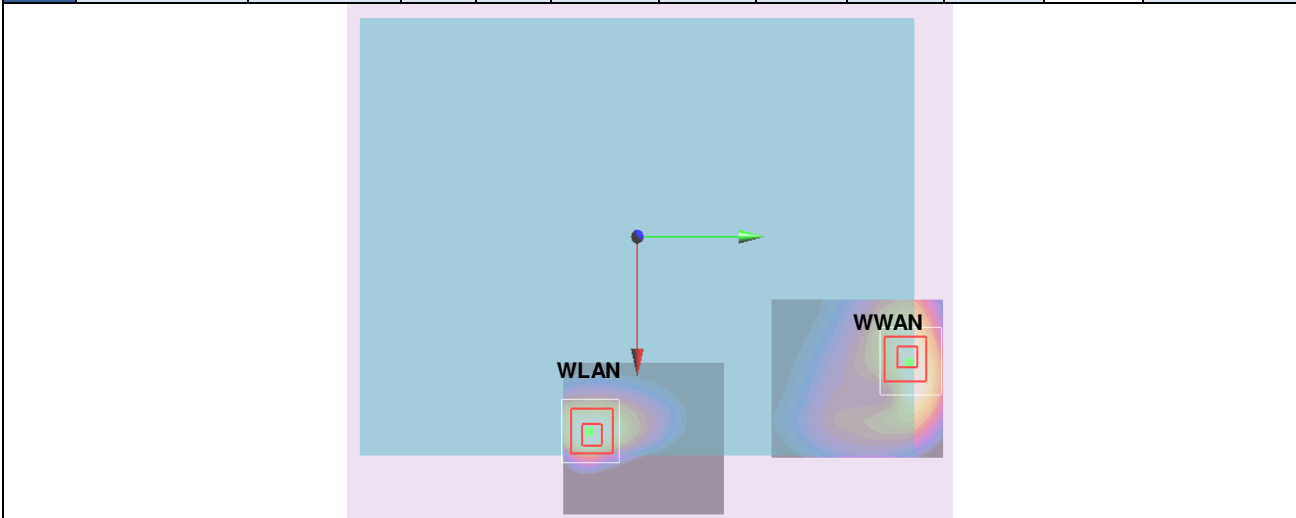

Case	Band	Position	SAR (W/kg)	Gap (cm)	SAR peak location (m)			3D distance (mm)	Summed SAR (W/kg)	SPLSR Results	Simultaneous SAR
					X	Y	Z				
25	LTE Band 13	Bottom Face	1.23	0mm	0.07	0.143	-0.176	169.8	2.10	0.02	Not required
	WLAN2.4GHz Ant 2		0.874	0mm	0.0974	-0.0246	-0.176				

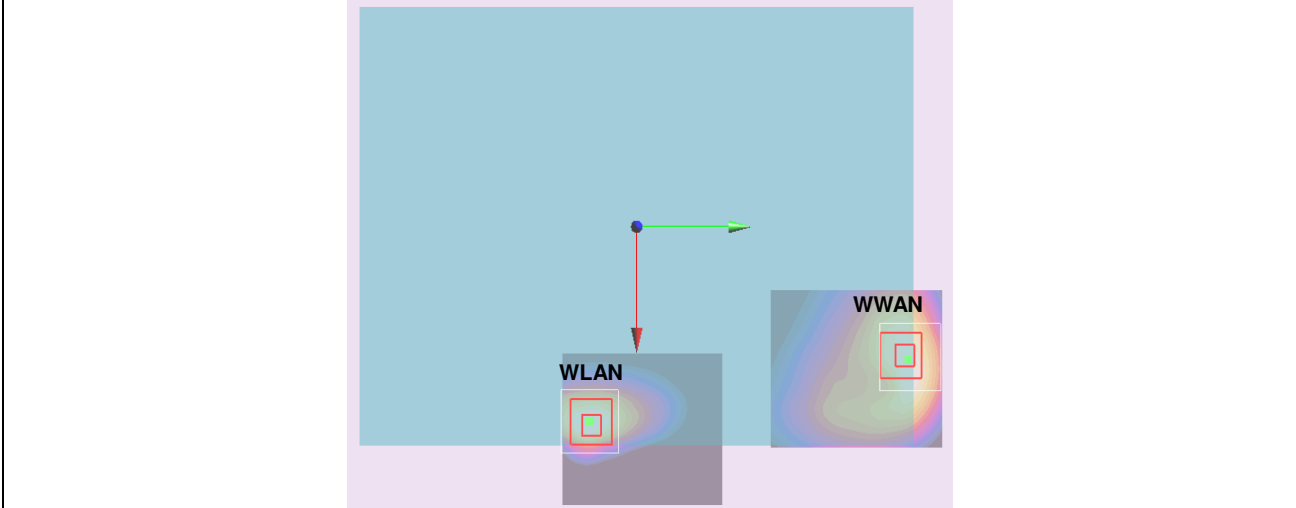

Case	Band	Position	SAR (W/kg)	Gap (cm)	SAR peak location (m)			3D distance (mm)	Summed SAR (W/kg)	SPLSR Results	Simultaneous SAR
					X	Y	Z				
26	LTE Band 25	Bottom Face	0.935	0mm	0.075	0.142	-0.175	168.1	1.81	0.01	Not required
	WLAN2.4GHz Ant 2		0.874	0mm	0.0974	-0.0246	-0.176				

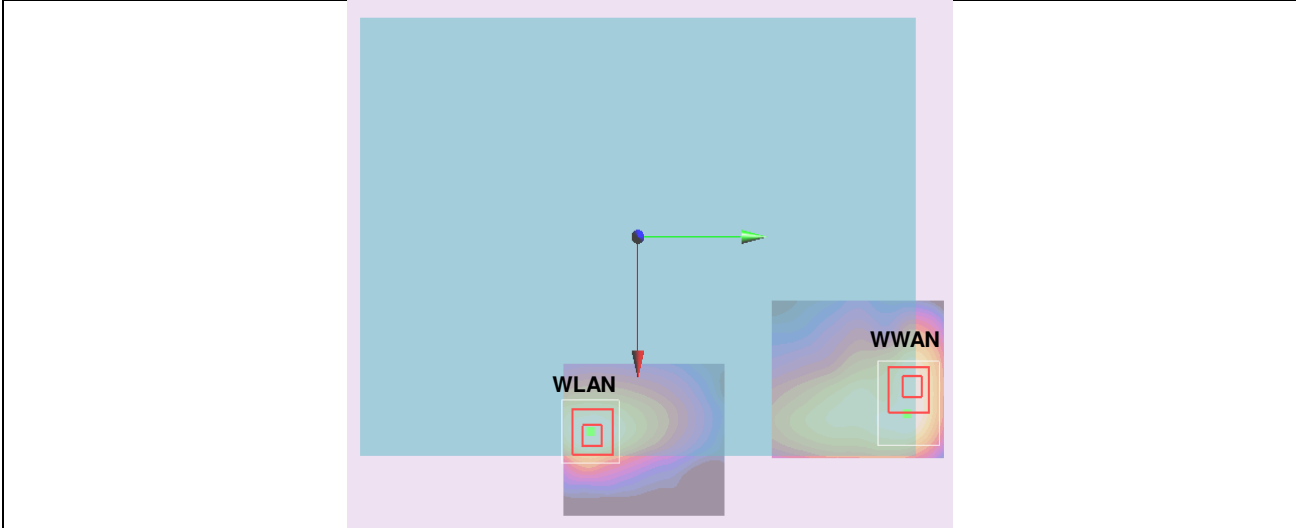

Case	Band	Position	SAR (W/kg)	Gap (cm)	SAR peak location (m)			3D distance (mm)	Summed SAR (W/kg)	SPLSR Results	Simultaneous SAR
					X	Y	Z				
27	LTE Band 25	Bottom Face	0.971	11mm	0.0635	0.145	-0.177	173.0	1.85	0.01	Not required
	WLAN2.4GHz Ant 2		0.874	0mm	0.0974	-0.0246	-0.176				

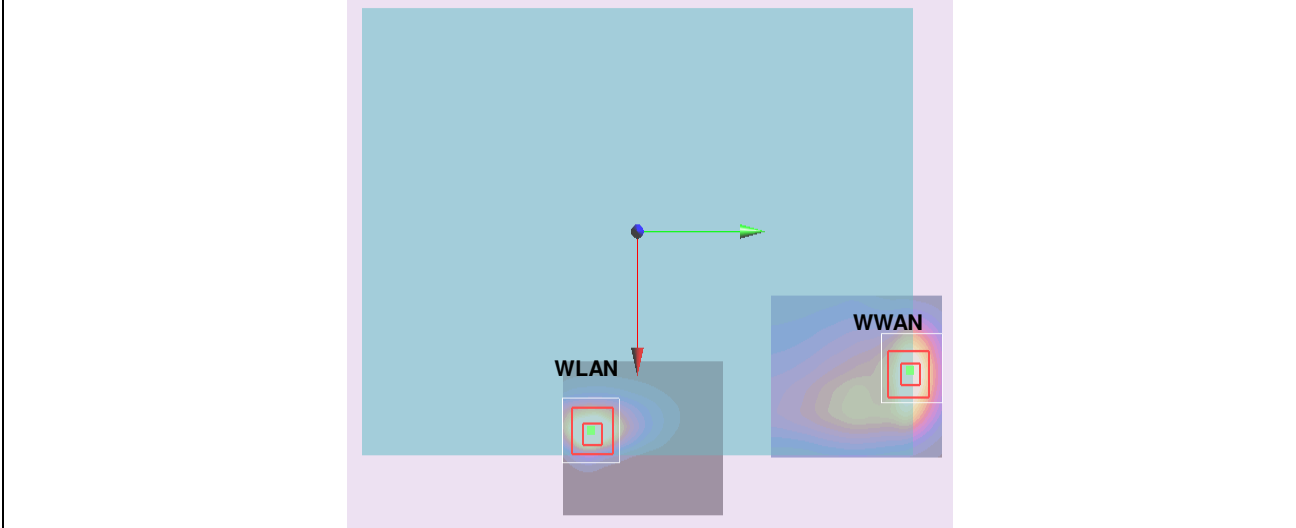

Case	Band	Position	SAR (W/kg)	Gap (cm)	SAR peak location (m)			3D distance (mm)	Summed SAR (W/kg)	SPLSR Results	Simultaneous SAR
					X	Y	Z				
28	LTE Band 26	Bottom Face	1.034	0mm	0.071	0.143	-0.176	169.7	1.91	0.02	Not required
	WLAN2.4GHz Ant 2		0.874	0mm	0.0974	-0.0246	-0.176				

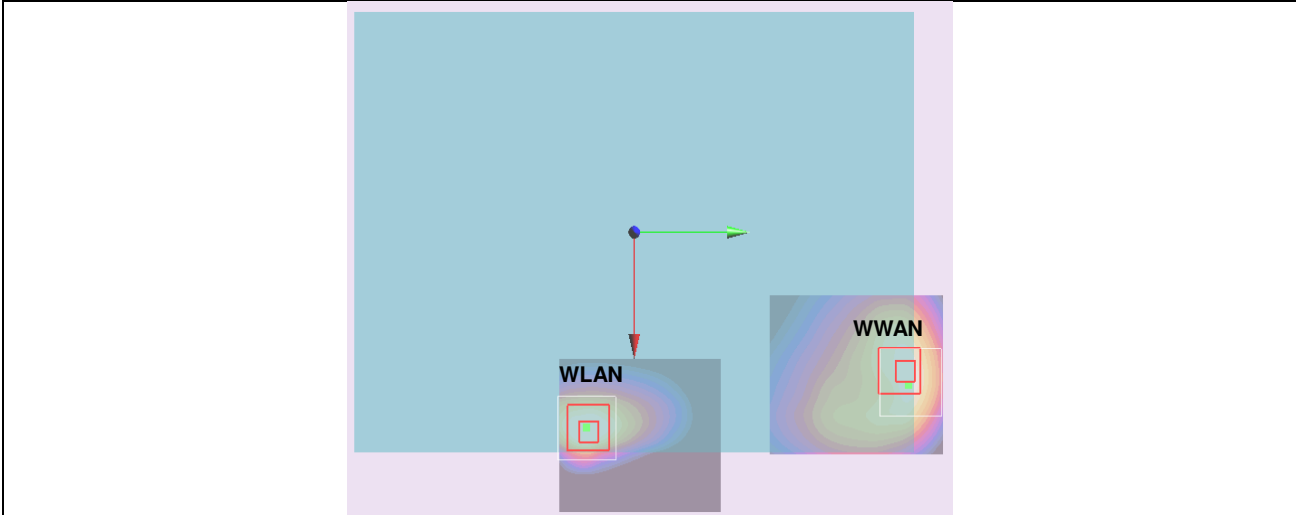



Case	Band	Position	SAR (W/kg)	Gap (cm)	SAR peak location (m)			3D distance (mm)	Summed SAR (W/kg)	SPLSR Results	Simultaneous SAR
					X	Y	Z				
29	LTE Band 41	Bottom Face	1.267	0mm	0.0796	0.14	-0.176	165.6	2.14	0.02	Not required
	WLAN2.4GHz Ant 2		0.874	0mm	0.0974	-0.0246	-0.176				

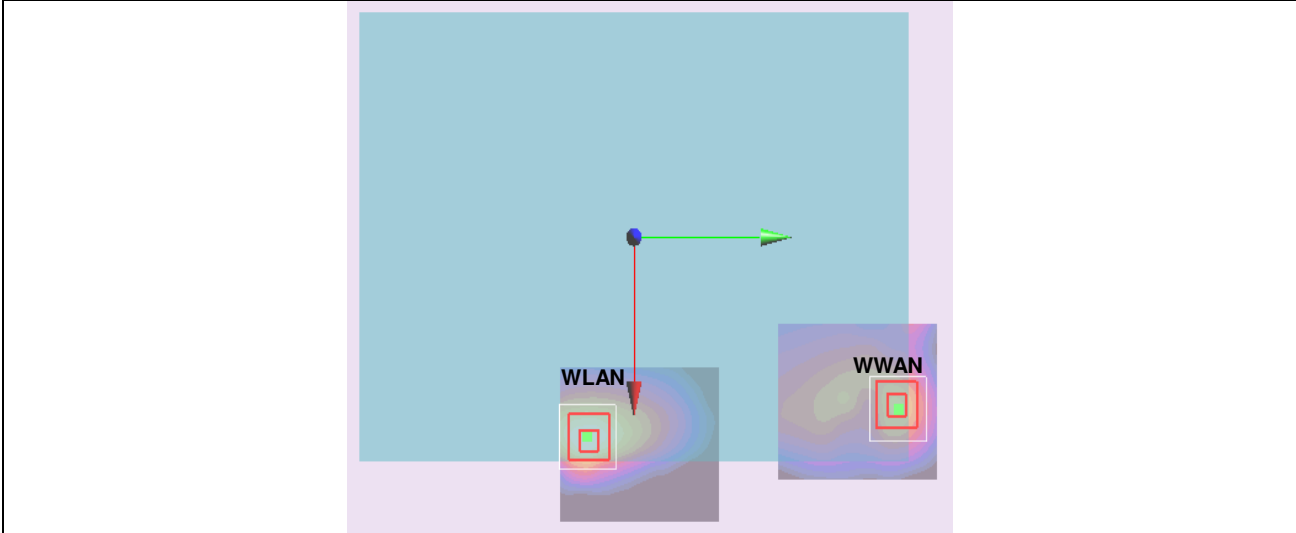

Case	Band	Position	SAR (W/kg)	Gap (cm)	SAR peak location (m)			3D distance (mm)	Summed SAR (W/kg)	SPLSR Results	Simultaneous SAR
					X	Y	Z				
30	WCDMA II	Bottom Face	1.019	11mm	0.074	0.143	-0.177	285.7	1.72	0.01	Not required
	WLAN5GHz Ant 1		0.699	0mm	0.017	-0.137	-0.176				

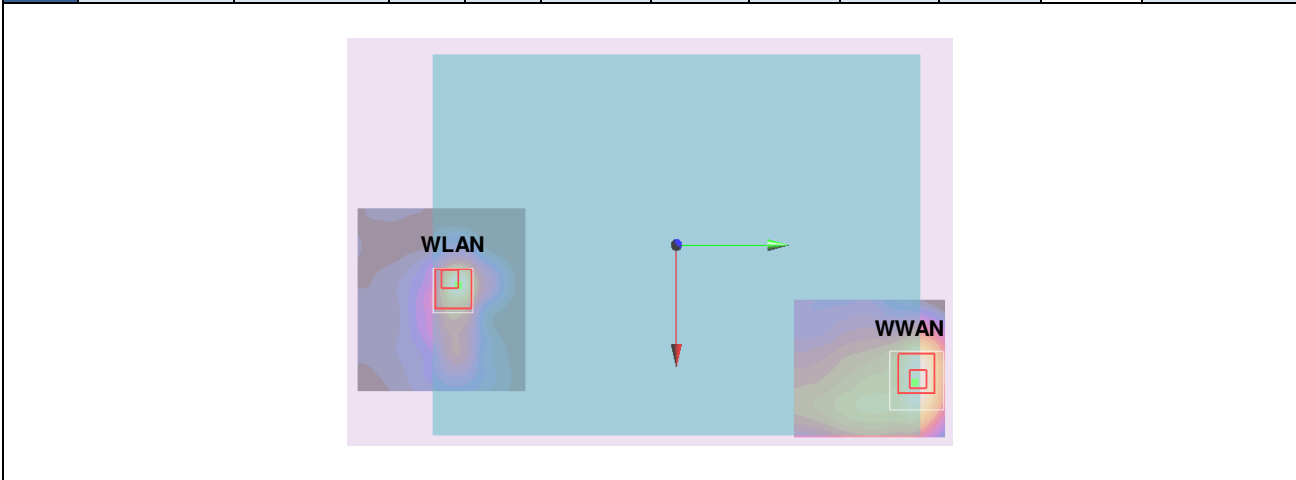

Case 31	Band	Position	SAR (W/kg)	Gap (cm)	SAR peak location (m)			3D distance (mm)	Summed SAR (W/kg)	SPLSR Results	Simultaneous SAR
					X	Y	Z				
	WCDMA IV	Bottom Face	1.147	0mm	0.0725	0.145	-0.176	287.4	1.85	0.01	Not required
	WLAN5GHz Ant 1		0.699	0mm	0.017	-0.137	-0.176				

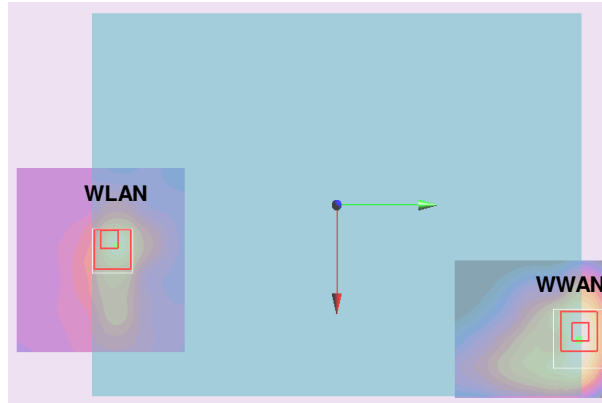

Case 32	Band	Position	SAR (W/kg)	Gap (cm)	SAR peak location (m)			3D distance (mm)	Summed SAR (W/kg)	SPLSR Results	Simultaneous SAR
					X	Y	Z				
	WCDMA IV	Bottom Face	1.297	11mm	0.074	0.143	-0.176	285.7	2.00	0.01	Not required
	WLAN5GHz Ant 1		0.699	0mm	0.017	-0.137	-0.176				

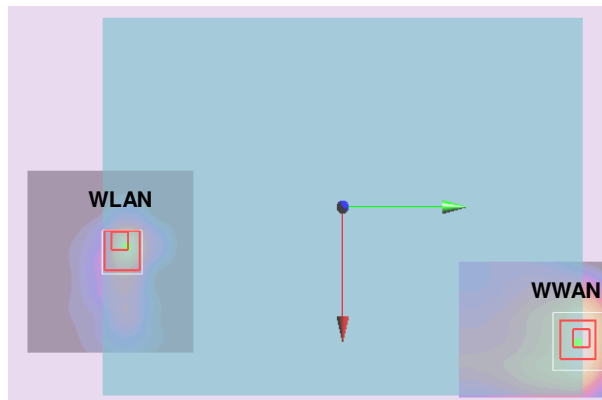

Case	Band	Position	SAR (W/kg)	Gap (cm)	SAR peak location (m)			3D distance (mm)	Summed SAR (W/kg)	SPLSR Results	Simultaneous SAR
					X	Y	Z				
33	WCDMA V	Bottom Face	1.136	0mm	0.07	0.142	-0.176	284.0	1.84	0.01	Not required
	WLAN5GHz Ant 1		0.699	0mm	0.017	-0.137	-0.176				

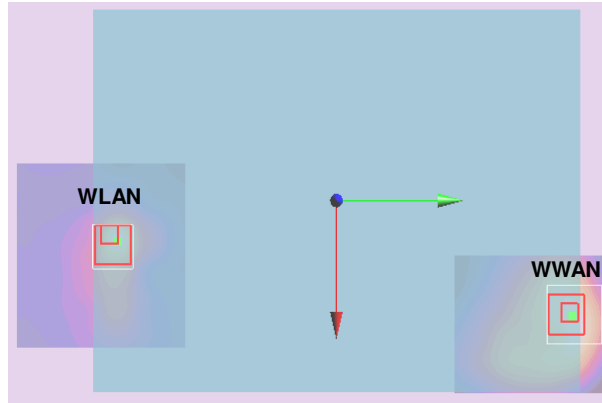

Case	Band	Position	SAR (W/kg)	Gap (cm)	SAR peak location (m)			3D distance (mm)	Summed SAR (W/kg)	SPLSR Results	Simultaneous SAR
					X	Y	Z				
34	LTE Band 4	Bottom Face	1.227	0mm	0.0725	0.145	-0.176	287.4	1.93	0.01	Not required
	WLAN5GHz Ant 1		0.699	0mm	0.017	-0.137	-0.176				

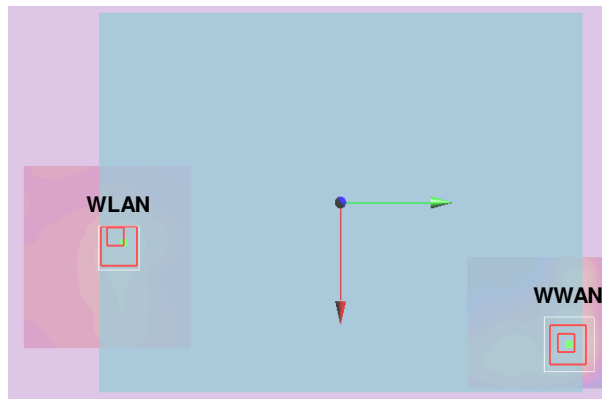

Case	Band	Position	SAR (W/kg)	Gap (cm)	SAR peak location (m)			3D distance (mm)	Summed SAR (W/kg)	SPLSR Results	Simultaneous SAR
					X	Y	Z				
35	LTE Band 4	Bottom Face	1.21	11mm	0.0665	0.143	-0.177	284.3	1.91	0.01	Not required
	WLAN5GHz Ant 1		0.699	0mm	0.017	-0.137	-0.176				

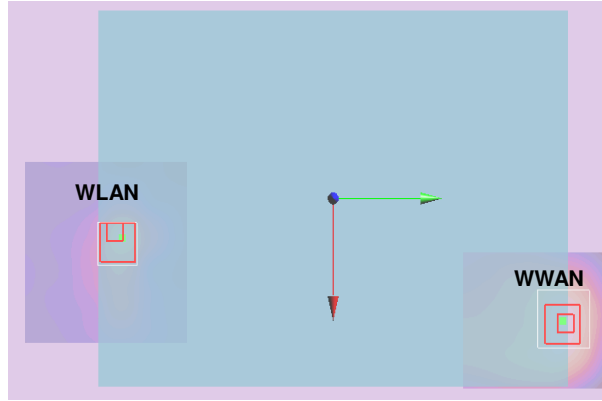

Case	Band	Position	SAR (W/kg)	Gap (cm)	SAR peak location (m)			3D distance (mm)	Summed SAR (W/kg)	SPLSR Results	Simultaneous SAR
					X	Y	Z				
36	LTE Band 7	Bottom Face	1.263	0mm	0.078	0.137	-0.175	280.7	1.96	0.01	Not required
	WLAN5GHz Ant 1		0.699	0mm	0.017	-0.137	-0.176				

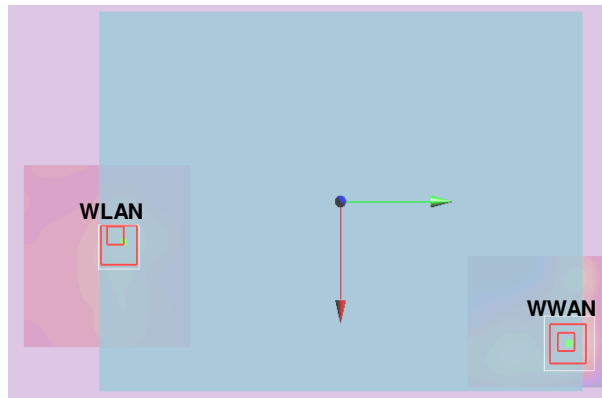

Case 37	Band	Position	SAR (W/kg)	Gap (cm)	SAR peak location (m)			3D distance (mm)	Summed SAR (W/kg)	SPLSR Results	Simultaneous SAR
					X	Y	Z				
	LTE Band 12	Bottom Face	1.017	0mm	0.059	0.143	-0.176	283.1	1.72	0.01	Not required
	WLAN5GHz Ant 1		0.699	0mm	0.017	-0.137	-0.176				

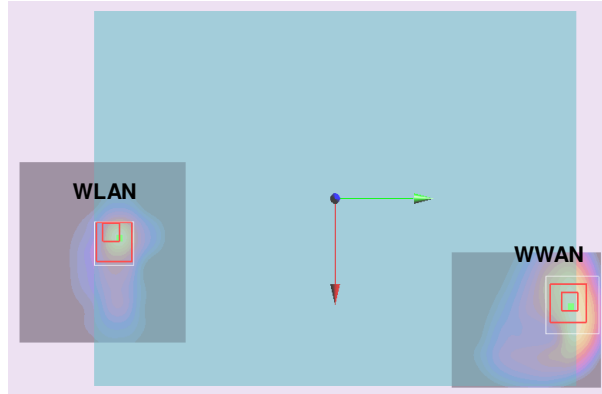

Case 38	Band	Position	SAR (W/kg)	Gap (cm)	SAR peak location (m)			3D distance (mm)	Summed SAR (W/kg)	SPLSR Results	Simultaneous SAR
					X	Y	Z				
	LTE Band 13	Bottom Face	1.23	0mm	0.07	0.143	-0.176	285.0	1.93	0.01	Not required
	WLAN5GHz Ant 1		0.699	0mm	0.017	-0.137	-0.176				

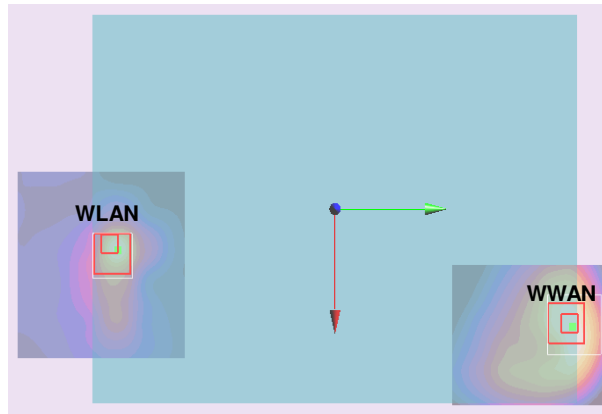

Case	Band	Position	SAR (W/kg)	Gap (cm)	SAR peak location (m)			3D distance (mm)	Summed SAR (W/kg)	SPLSR Results	Simultaneous SAR
					X	Y	Z				
39	LTE Band 25	Bottom Face	0.935	0mm	0.075	0.142	-0.175	285.0	1.63	0.01	Not required
	WLAN5GHz Ant 1		0.699	0mm	0.017	-0.137	-0.176				

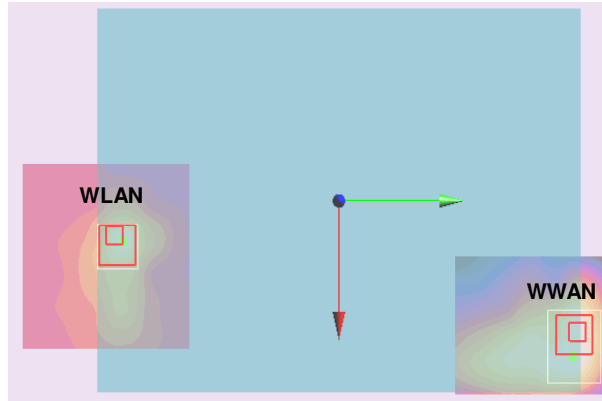

Case	Band	Position	SAR (W/kg)	Gap (cm)	SAR peak location (m)			3D distance (mm)	Summed SAR (W/kg)	SPLSR Results	Simultaneous SAR
					X	Y	Z				
40	LTE Band 25	Bottom Face	0.971	11mm	0.0635	0.145	-0.177	285.8	1.67	0.01	Not required
	WLAN5GHz Ant 1		0.699	0mm	0.017	-0.137	-0.176				

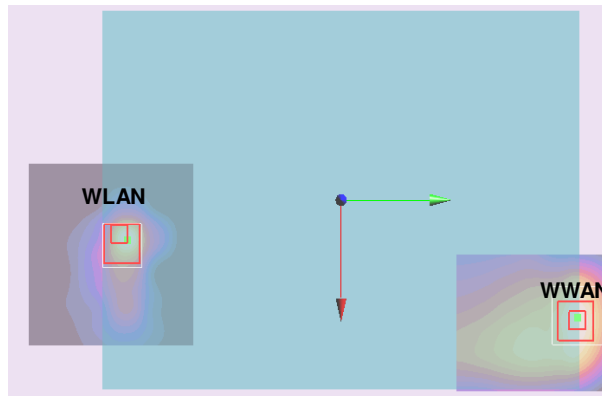

Case 41	Band	Position	SAR (W/kg)	Gap (cm)	SAR peak location (m)			3D distance (mm)	Summed SAR (W/kg)	SPLSR Results	Simultaneous SAR
					X	Y	Z				
	LTE Band 26	Bottom Face	1.034	0mm	0.071	0.143	-0.176	285.2	1.73	0.01	Not required
	WLAN5GHz Ant 1		0.699	0mm	0.017	-0.137	-0.176				

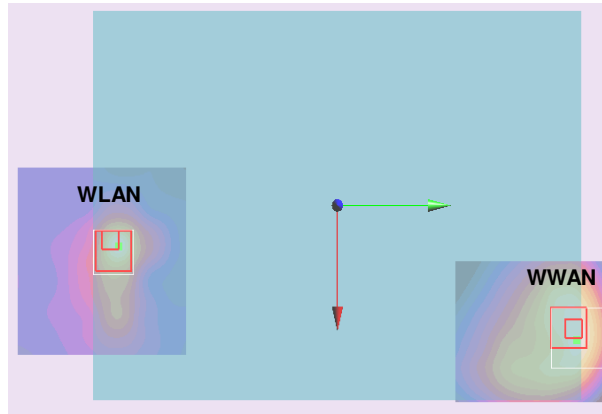

Case 42	Band	Position	SAR (W/kg)	Gap (cm)	SAR peak location (m)			3D distance (mm)	Summed SAR (W/kg)	SPLSR Results	Simultaneous SAR
					X	Y	Z				
	LTE Band 41	Bottom Face	1.267	0mm	0.0796	0.14	-0.176	284.0	1.97	0.01	Not required
	WLAN5GHz Ant 1		0.699	0mm	0.017	-0.137	-0.176				

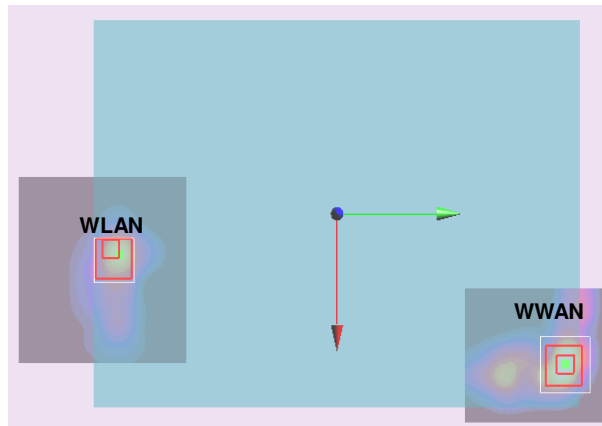

Case 43	Band	Position	SAR (W/kg)	Gap (cm)	SAR peak location (m)			3D distance (mm)	Summed SAR (W/kg)	SPLSR Results	Simultaneous SAR
					X	Y	Z				
	WCDMA II	Edge 1	0.499	0mm	-0.0075	0.122	-0.177	145.3	1.62	0.01	Not required
	WLAN5GHz Ant 2		1.122	0mm	0.001	-0.023	-0.178				

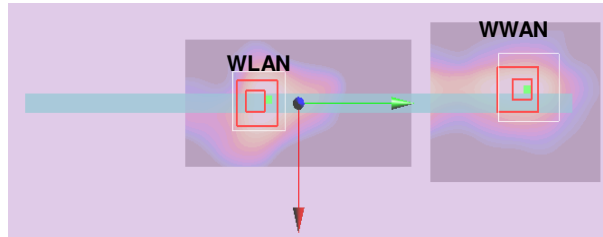

Case 44	Band	Position	SAR (W/kg)	Gap (cm)	SAR peak location (m)			3D distance (mm)	Summed SAR (W/kg)	SPLSR Results	Simultaneous SAR
					X	Y	Z				
	WCDMA II	Bottom Face	1.019	11mm	0.074	0.143	-0.177	165.3	1.79	0.01	Not required
	WLAN5GHz Ant 2		0.766	0mm	0.095	-0.021	-0.177				

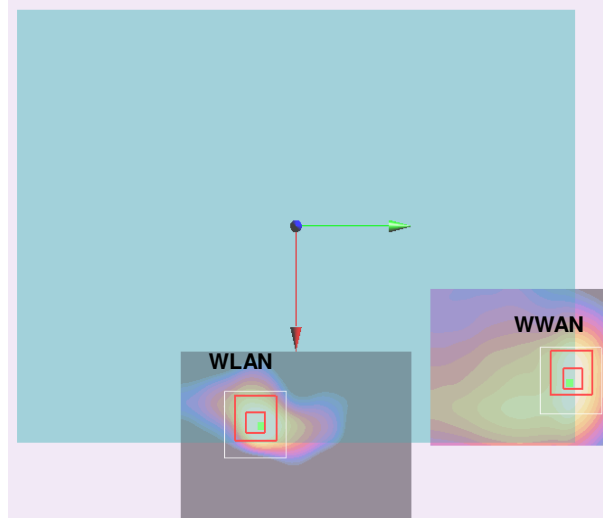



Case	Band	Position	SAR (W/kg)	Gap (cm)	SAR peak location (m)			3D distance (mm)	Summed SAR (W/kg)	SPLSR Results	Simultaneous SAR
					X	Y	Z				
45	WCDMA II	Edge 1	0.603	9mm	-0.003	0.115	-0.178	138.1	1.73	0.02	Not required
	WLAN5GHz Ant 2		1.122	0mm	0.001	-0.023	-0.178				

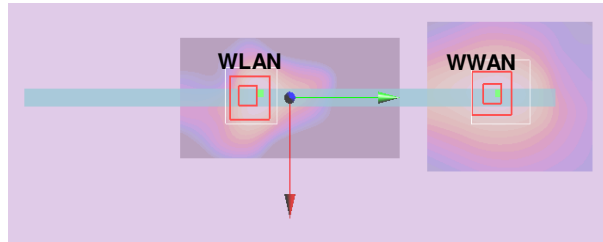

Case	Band	Position	SAR (W/kg)	Gap (cm)	SAR peak location (m)			3D distance (mm)	Summed SAR (W/kg)	SPLSR Results	Simultaneous SAR
					X	Y	Z				
46	WCDMA IV	Bottom Face	1.147	0mm	0.0725	0.145	-0.176	167.5	1.91	0.02	Not required
	WLAN5GHz Ant 2		0.766	0mm	0.095	-0.021	-0.177				

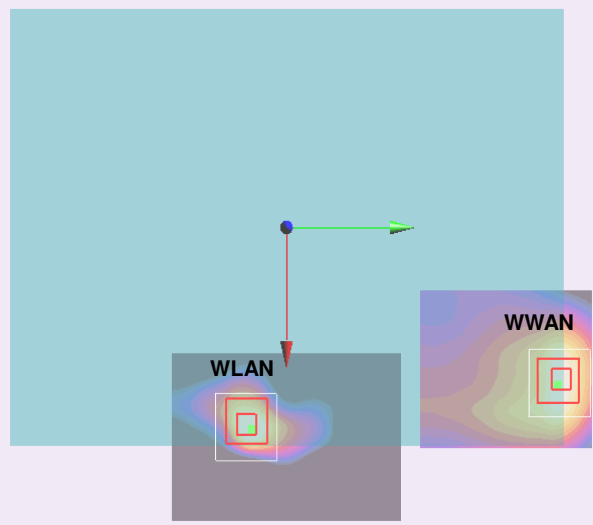

Case 47	Band	Position	SAR (W/kg)	Gap (cm)	SAR peak location (m)			3D distance (mm)	Summed SAR (W/kg)	SPLSR Results	Simultaneous SAR
					X	Y	Z				
	WCDMA IV	Bottom Face	1.297	11mm	0.074	0.143	-0.176	165.3	2.06	0.02	Not required
	WLAN5GHz Ant 2		0.766	0mm	0.095	-0.021	-0.177				

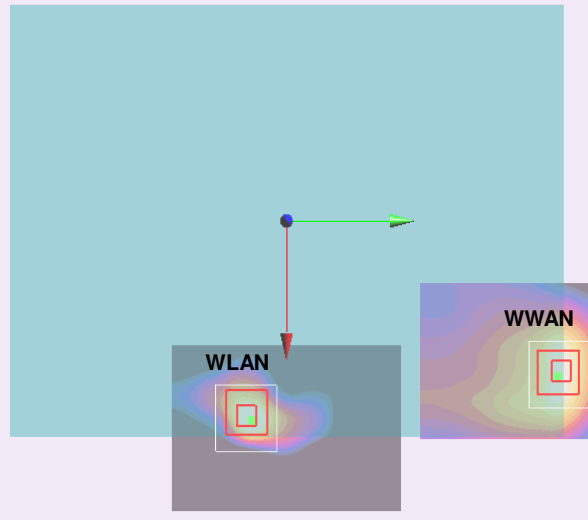

Case 48	Band	Position	SAR (W/kg)	Gap (cm)	SAR peak location (m)			3D distance (mm)	Summed SAR (W/kg)	SPLSR Results	Simultaneous SAR
					X	Y	Z				
	WCDMA IV	Edge 1	0.618	9mm	-0.003	0.124	-0.178	147.1	1.74	0.02	Not required
	WLAN5GHz Ant 2		1.122	0mm	0.001	-0.023	-0.178				

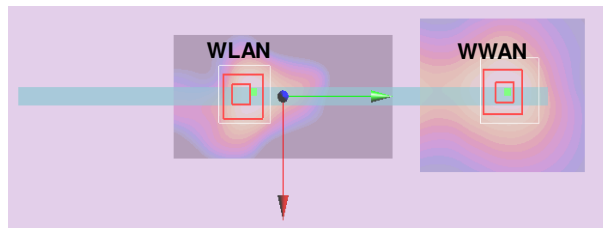

Case 49	Band	Position	SAR (W/kg)	Gap (cm)	SAR peak location (m)			3D distance (mm)	Summed SAR (W/kg)	SPLSR Results	Simultaneous SAR
	WCDMA V		1.136	0mm	X	Y	Z				
	WLAN5GHz Ant 2	Bottom Face	0.766	0mm	0.095	-0.021	-0.177	164.9	1.90	0.02	Not required

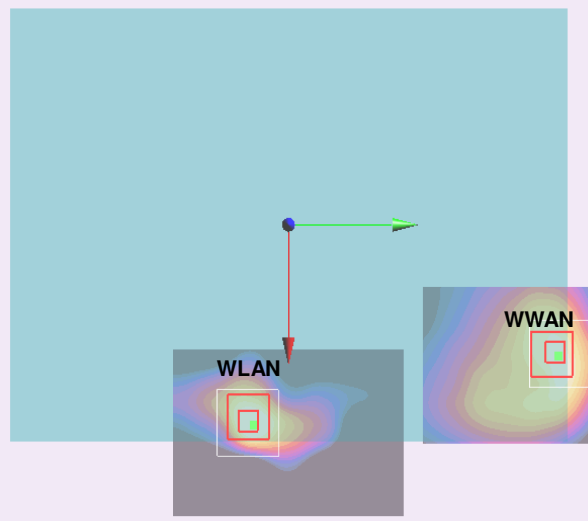

Case 50	Band	Position	SAR (W/kg)	Gap (cm)	SAR peak location (m)			3D distance (mm)	Summed SAR (W/kg)	SPLSR Results	Simultaneous SAR
	LTE Band 4		1.227	0mm	X	Y	Z				
	WLAN5GHz Ant 2	Bottom Face	0.766	0mm	0.095	-0.021	-0.177	167.5	1.99	0.02	Not required

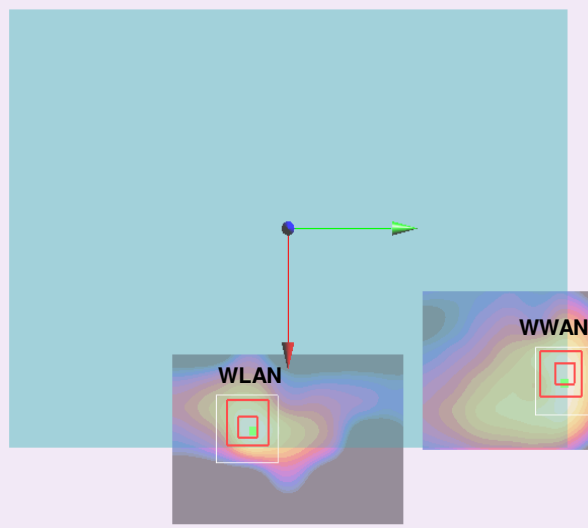

Case	Band	Position	SAR (W/kg)	Gap (cm)	SAR peak location (m)			3D distance (mm)	Summed SAR (W/kg)	SPLSR Results	Simultaneous SAR
					X	Y	Z				
51	LTE Band 4	Edge 1	0.477	0mm	-0.0045	0.124	-0.177	147.1	1.60	0.01	Not required
	WLAN5GHz Ant 2		1.122	0mm	0.001	-0.023	-0.178				

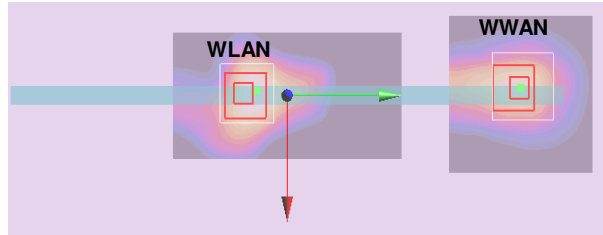

Case	Band	Position	SAR (W/kg)	Gap (cm)	SAR peak location (m)			3D distance (mm)	Summed SAR (W/kg)	SPLSR Results	Simultaneous SAR
					X	Y	Z				
52	LTE Band 4	Bottom Face	1.21	11mm	0.0665	0.143	-0.177	166.5	1.98	0.02	Not required
	WLAN5GHz Ant 2		0.766	0mm	0.095	-0.021	-0.177				

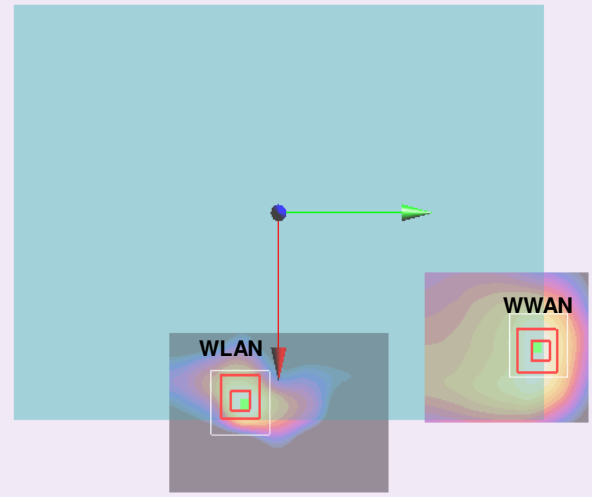

Case	Band	Position	SAR (W/kg)	Gap (cm)	SAR peak location (m)			3D distance (mm)	Summed SAR (W/kg)	SPLSR Results	Simultaneous SAR
					X	Y	Z				
53	LTE Band 4	Edge 1	0.528	9mm	-0.0075	0.125	-0.178	148.2	1.65	0.01	Not required
	WLAN5GHz Ant 2		1.122	0mm	0.001	-0.023	-0.178				

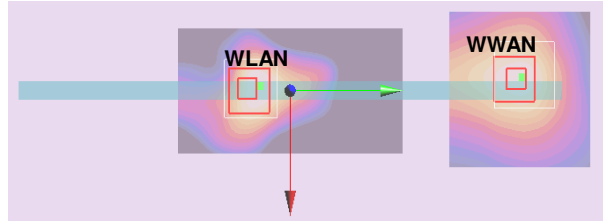

Case	Band	Position	SAR (W/kg)	Gap (cm)	SAR peak location (m)			3D distance (mm)	Summed SAR (W/kg)	SPLSR Results	Simultaneous SAR
					X	Y	Z				
54	LTE Band 7	Bottom Face	1.263	0mm	0.078	0.137	-0.175	158.9	2.03	0.02	Not required
	WLAN5GHz Ant 2		0.766	0mm	0.095	-0.021	-0.177				

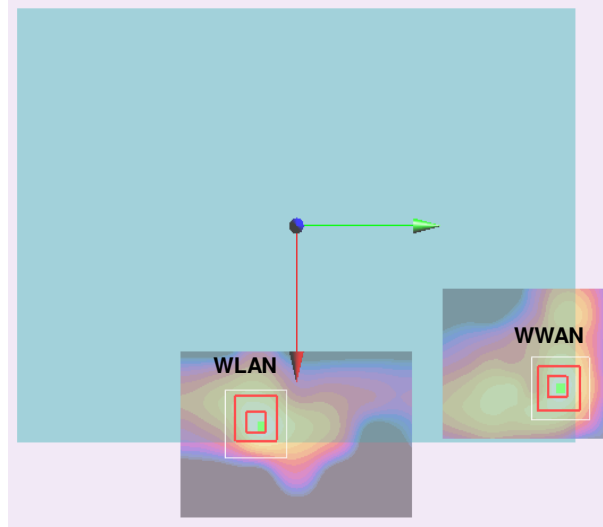

Case 55	Band	Position	SAR (W/kg)	Gap (cm)	SAR peak location (m)			3D distance (mm)	Summed SAR (W/kg)	SPLSR Results	Simultaneous SAR
					X	Y	Z				
	LTE Band 12	Bottom Face	1.017	0mm	0.059	0.143	-0.176	167.9	1.78	0.01	Not required
	WLAN5GHz Ant 2		0.766	0mm	0.095	-0.021	-0.177				

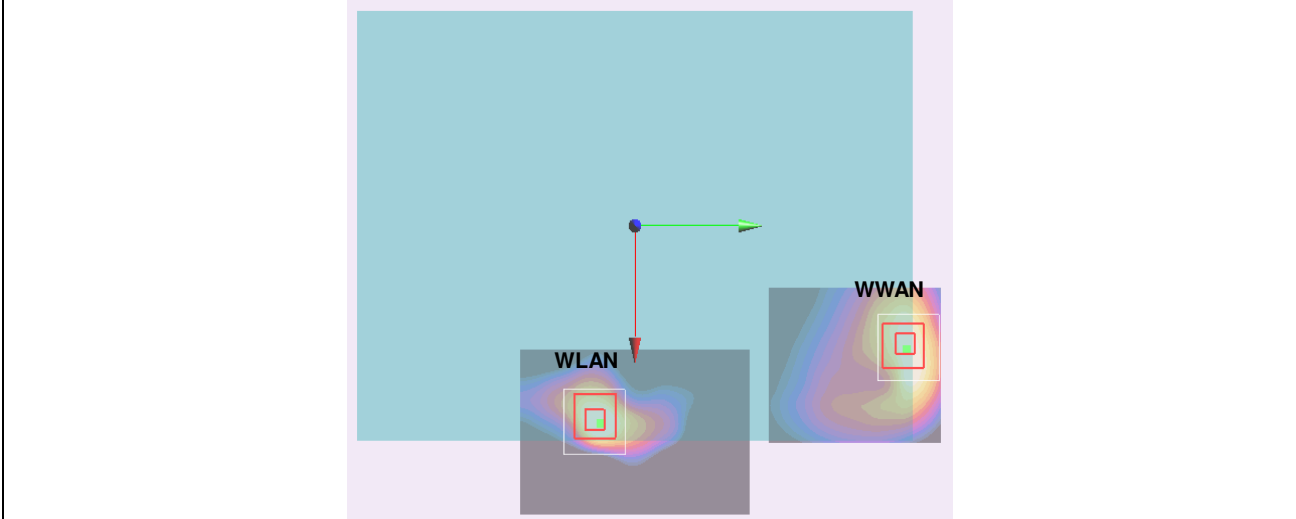

Case 56	Band	Position	SAR (W/kg)	Gap (cm)	SAR peak location (m)			3D distance (mm)	Summed SAR (W/kg)	SPLSR Results	Simultaneous SAR
					X	Y	Z				
	LTE Band 13	Bottom Face	1.23	0mm	0.07	0.143	-0.176	165.9	2.00	0.02	Not required
	WLAN5GHz Ant 2		0.766	0mm	0.095	-0.021	-0.177				

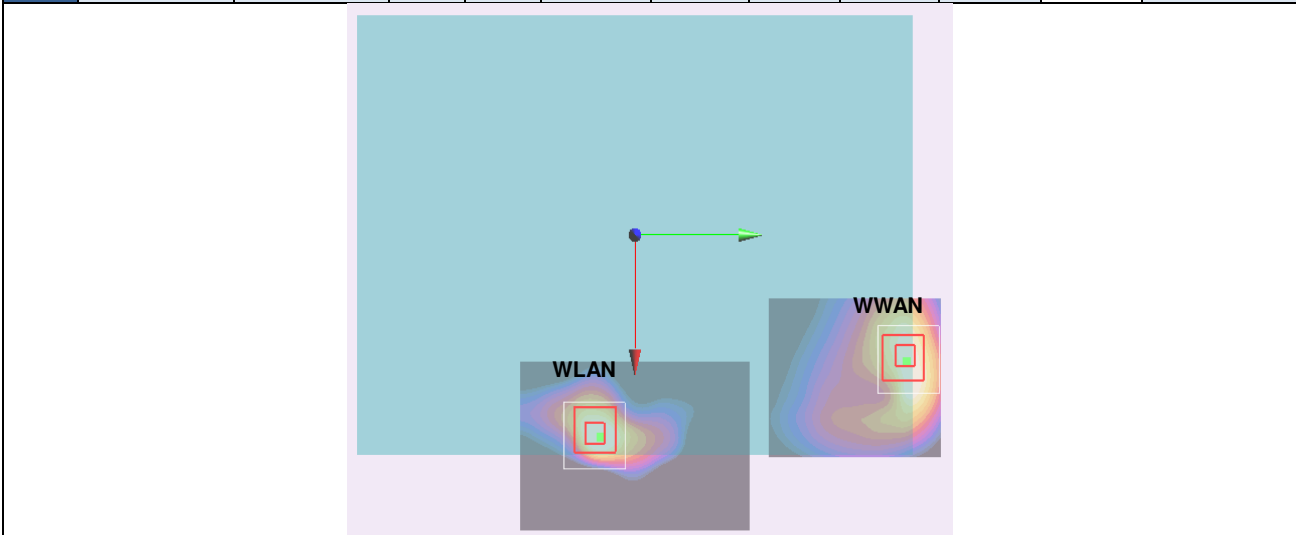

Case 57	Band	Position	SAR (W/kg)	Gap (cm)	SAR peak location (m)			3D distance (mm)	Summed SAR (W/kg)	SPLSR Results	Simultaneous SAR
					X	Y	Z				
	LTE Band 25	Bottom Face	0.935	0mm	0.075	0.142	-0.175	164.2	1.70	0.01	Not required
	WLAN5GHz Ant 2		0.766	0mm	0.095	-0.021	-0.177				

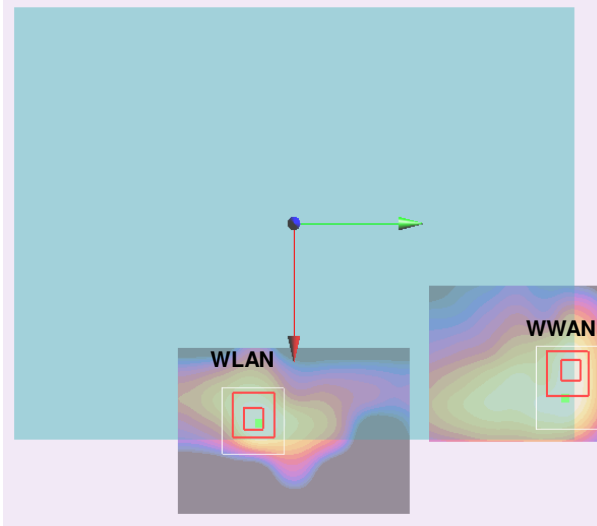

Case 58	Band	Position	SAR (W/kg)	Gap (cm)	SAR peak location (m)			3D distance (mm)	Summed SAR (W/kg)	SPLSR Results	Simultaneous SAR
					X	Y	Z				
	LTE Band 25	Edge 1	0.504	0mm	-0.0025	0.118	-0.178	141.0	1.63	0.01	Not required
	WLAN5GHz Ant 2		1.122	0mm	0.001	-0.023	-0.178				

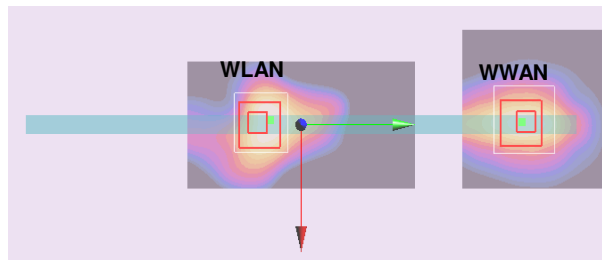

Case	Band	Position	SAR (W/kg)	Gap (cm)	SAR peak location (m)			3D distance (mm)	Summed SAR (W/kg)	SPLSR Results	Simultaneous SAR
					X	Y	Z				
59	LTE Band 25	Bottom Face	0.971	11mm	0.0635	0.145	-0.177	169.0	1.74	0.01	Not required
	WLAN5GHz Ant 2		0.766	0mm	0.095	-0.021	-0.177				

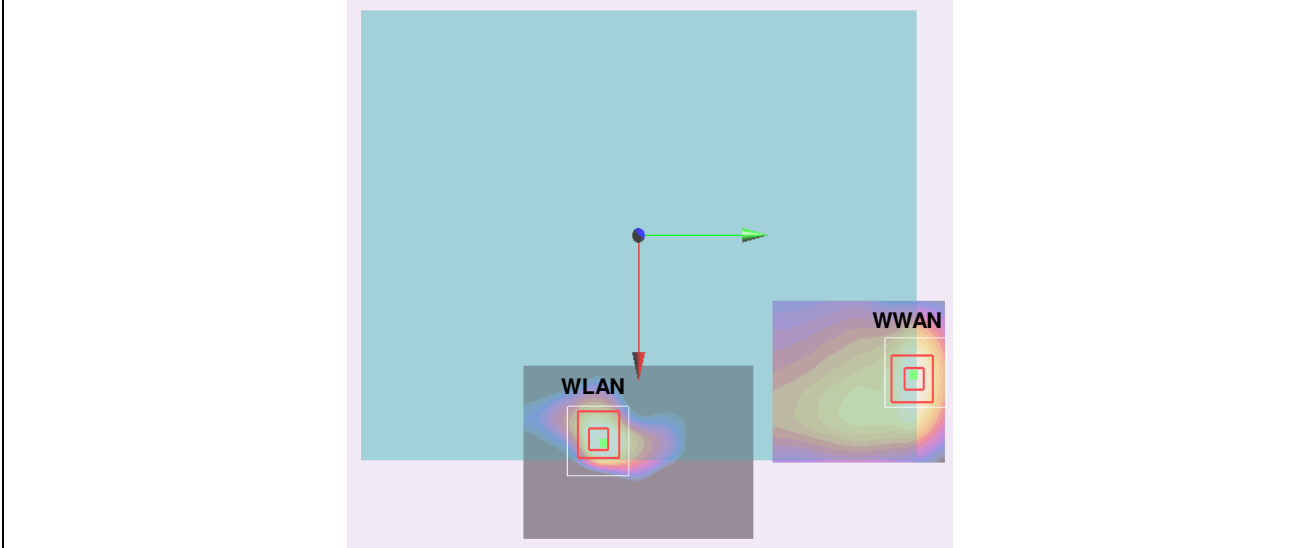

Case	Band	Position	SAR (W/kg)	Gap (cm)	SAR peak location (m)			3D distance (mm)	Summed SAR (W/kg)	SPLSR Results	Simultaneous SAR
					X	Y	Z				
60	LTE Band 25	Edge 1	0.498	9mm	-0.004	0.11	-0.178	133.1	1.62	0.02	Not required
	WLAN5GHz Ant 2		1.122	0mm	0.001	-0.023	-0.178				

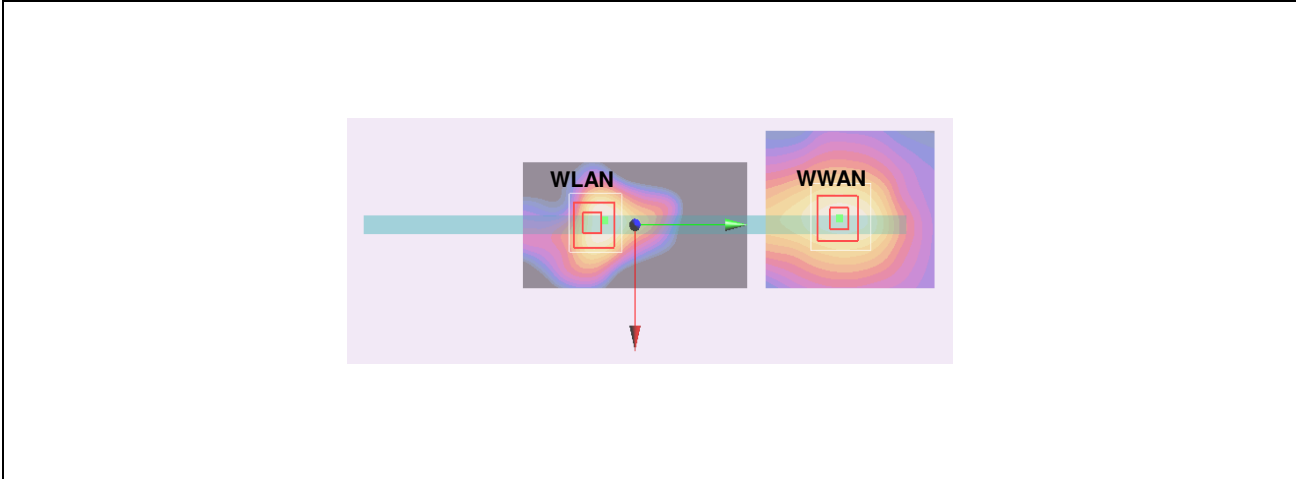



Case 61	Band	Position	SAR (W/kg)	Gap (cm)	SAR peak location (m)			3D distance (mm)	Summed SAR (W/kg)	SPLSR Results	Simultaneous SAR
					X	Y	Z				
	LTE Band 26	Bottom Face	1.034	0mm	0.071	0.143	-0.176	165.7	1.80	0.01	Not required
	WLAN5GHz Ant 2		0.766	0mm	0.095	-0.021	-0.177				

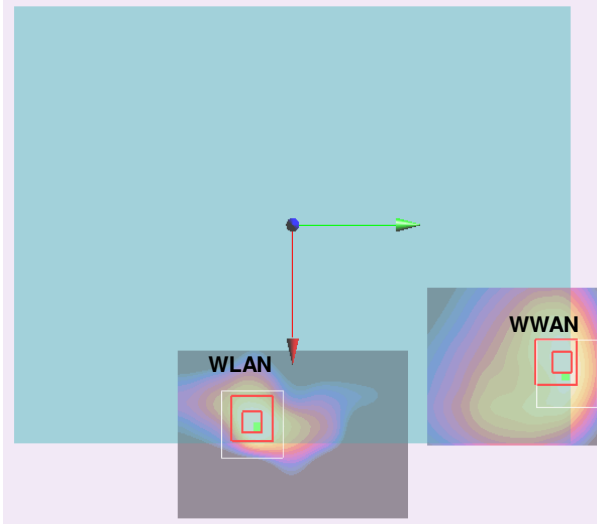

Case 62	Band	Position	SAR (W/kg)	Gap (cm)	SAR peak location (m)			3D distance (mm)	Summed SAR (W/kg)	SPLSR Results	Simultaneous SAR
					X	Y	Z				
	LTE Band 41	Bottom Face	1.267	0mm	0.0796	0.14	-0.176	161.7	2.03	0.02	Not required
	WLAN5GHz Ant 2		0.766	0mm	0.095	-0.021	-0.177				

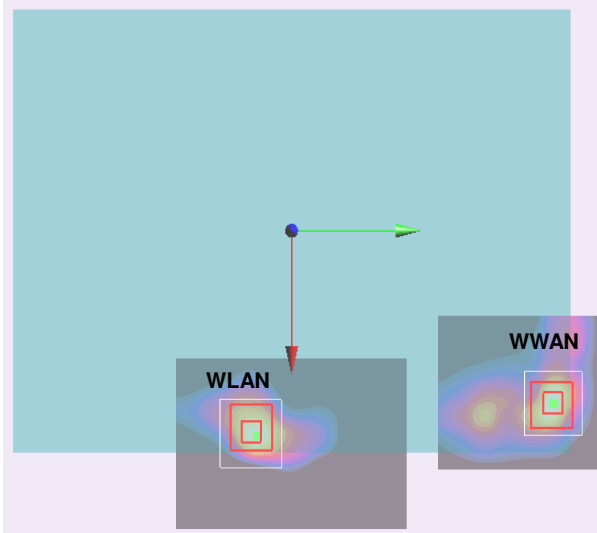

Test Engineer : Angelo Chang Tommy Chen Poa Pan and Ken Li

## **17. Uncertainty Assessment**

The component of uncertainty may generally be categorized according to the methods used to evaluate them. The evaluation of uncertainty by the statistical analysis of a series of observations is termed a Type A evaluation of uncertainty. The evaluation of uncertainty by means other than the statistical analysis of a series of observation is termed a Type B evaluation of uncertainty. Each component of uncertainty, however evaluated, is represented by an estimated standard deviation, termed standard uncertainty, which is determined by the positive square root of the estimated variance.

A Type A evaluation of standard uncertainty may be based on any valid statistical method for treating data. This includes calculating the standard deviation of the mean of a series of independent observations; using the method of least squares to fit a curve to the data in order to estimate the parameter of the curve and their standard deviations; or carrying out an analysis of variance in order to identify and quantify random effects in certain kinds of measurement.

A type B evaluation of standard uncertainty is typically based on scientific judgment using all of the relevant information available. These may include previous measurement data, experience, and knowledge of the behavior and properties of relevant materials and instruments, manufacture’s specification, data provided in calibration reports and uncertainties assigned to reference data taken from handbooks. Broadly speaking, the uncertainty is either obtained from an outdoor source or obtained from an assumed distribution, such as the normal distribution, rectangular or triangular distributions indicated in table below.

<b>Uncertainty Distributions</b>	<b>Normal</b>	<b>Rectangular</b>	<b>Triangular</b>	<b>U-Shape</b>
Multi-plying Factor <sup>(a)</sup>	1/k <sup>(b)</sup>	1/√3	1/√6	1/√2

(a) standard uncertainty is determined as the product of the multiplying factor and the estimated range of variations in the measured quantity

(b)  $\kappa$  is the coverage factor

**Table 17.1. Standard Uncertainty for Assumed Distribution**

The combined standard uncertainty of the measurement result represents the estimated standard deviation of the result. It is obtained by combining the individual standard uncertainties of both Type A and Type B evaluation using the usual “root-sum-squares” (RSS) methods of combining standard deviations by taking the positive square root of the estimated variances.

Expanded uncertainty is a measure of uncertainty that defines an interval about the measurement result within which the measured value is confidently believed to lie. It is obtained by multiplying the combined standard uncertainty by a coverage factor. Typically, the coverage factor ranges from 2 to 3. Using a coverage factor allows the true value of a measured quantity to be specified with a defined probability within the specified uncertainty range. For purpose of this document, a coverage factor two is used, which corresponds to confidence interval of about 95 %. The DASY uncertainty Budget is shown in the following tables.



Error Description	Uncertainty Value (±%)	Probability	Divisor	(Ci) 1g	(Ci) 10g	Standard Uncertainty (1g) (±%)	Standard Uncertainty (10g) (±%)
<b>Measurement System</b>							
Probe Calibration	6.0	N	1	1	1	6.0	6.0
Axial Isotropy	4.7	R	1.732	0.7	0.7	1.9	1.9
Hemispherical Isotropy	9.6	R	1.732	0.7	0.7	3.9	3.9
Boundary Effects	1.0	R	1.732	1	1	0.6	0.6
Linearity	4.7	R	1.732	1	1	2.7	2.7
System Detection Limits	1.0	R	1.732	1	1	0.6	0.6
Modulation Response	3.2	R	1.732	1	1	1.8	1.8
Readout Electronics	0.3	N	1	1	1	0.3	0.3
Response Time	0.0	R	1.732	1	1	0.0	0.0
Integration Time	2.6	R	1.732	1	1	1.5	1.5
RF Ambient Noise	3.0	R	1.732	1	1	1.7	1.7
RF Ambient Reflections	3.0	R	1.732	1	1	1.7	1.7
Probe Positioner	0.4	R	1.732	1	1	0.2	0.2
Probe Positioning	2.9	R	1.732	1	1	1.7	1.7
Max. SAR Eval.	2.0	R	1.732	1	1	1.2	1.2
<b>Test Sample Related</b>							
Device Positioning	3.0	N	1	1	1	3.0	3.0
Device Holder	3.6	N	1	1	1	3.6	3.6
Power Drift	5.0	R	1.732	1	1	2.9	2.9
Power Scaling	0.0	R	1.732	1	1	0.0	0.0
<b>Phantom and Setup</b>							
Phantom Uncertainty	6.1	R	1.732	1	1	3.5	3.5
SAR correction	0.0	R	1.732	1	0.84	0.0	0.0
Liquid Conductivity Repeatability	0.2	N	1	0.78	0.71	0.1	0.1
Liquid Conductivity (target)	5.0	R	1.732	0.78	0.71	2.3	2.0
Liquid Conductivity (mea.)	2.5	R	1.732	0.78	0.71	1.1	1.0
Temp. unc. - Conductivity	3.4	R	1.732	0.78	0.71	1.5	1.4
Liquid Permittivity Repeatability	0.15	N	1	0.23	0.26	0.0	0.0
Liquid Permittivity (target)	5.0	R	1.732	0.23	0.26	0.7	0.8
Liquid Permittivity (mea.)	2.5	R	1.732	0.23	0.26	0.3	0.4
Temp. unc. - Permittivity	0.83	R	1.732	0.23	0.26	0.1	0.1
<b>Combined Std. Uncertainty</b>						11.4%	11.4%
<b>Coverage Factor for 95 %</b>						K=2	K=2
<b>Expanded STD Uncertainty</b>						22.9%	22.7%

Table 17.2. Uncertainty Budget for frequency range 300 MHz to 3 GHz



Error Description	Uncertainty Value (±%)	Probability	Divisor	(Ci) 1g	(Ci) 10g	Standard Uncertainty (1g) (±%)	Standard Uncertainty (10g) (±%)
<b>Measurement System</b>							
Probe Calibration	6.55	N	1	1	1	6.6	6.6
Axial Isotropy	4.7	R	1.732	0.7	0.7	1.9	1.9
Hemispherical Isotropy	9.6	R	1.732	0.7	0.7	3.9	3.9
Boundary Effects	2.0	R	1.732	1	1	1.2	1.2
Linearity	4.7	R	1.732	1	1	2.7	2.7
System Detection Limits	1.0	R	1.732	1	1	0.6	0.6
Modulation Response	3.2	R	1.732	1	1	1.8	1.8
Readout Electronics	0.3	N	1	1	1	0.3	0.3
Response Time	0.0	R	1.732	1	1	0.0	0.0
Integration Time	2.6	R	1.732	1	1	1.5	1.5
RF Ambient Noise	3.0	R	1.732	1	1	1.7	1.7
RF Ambient Reflections	3.0	R	1.732	1	1	1.7	1.7
Probe Positioner	0.4	R	1.732	1	1	0.2	0.2
Probe Positioning	6.7	R	1.732	1	1	3.9	3.9
Max. SAR Eval.	4.0	R	1.732	1	1	2.3	2.3
<b>Test Sample Related</b>							
Device Positioning	3.0	N	1	1	1	3.0	3.0
Device Holder	3.6	N	1	1	1	3.6	3.6
Power Drift	5.0	R	1.732	1	1	2.9	2.9
Power Scaling	0.0	R	1.732	1	1	0.0	0.0
<b>Phantom and Setup</b>							
Phantom Uncertainty	6.6	R	1.732	1	1	3.8	3.8
SAR correction	0.0	R	1.732	1	0.84	0.0	0.0
Liquid Conductivity Repeatability	0.2	N	1	0.78	0.71	0.1	0.1
Liquid Conductivity (target)	5.0	R	1.732	0.78	0.71	2.3	2.0
Liquid Conductivity (mea.)	2.5	R	1.732	0.78	0.71	1.1	1.0
Temp. unc. - Conductivity	3.4	R	1.732	0.78	0.71	1.5	1.4
Liquid Permittivity Repeatability	0.15	N	1	0.23	0.26	0.0	0.0
Liquid Permittivity (target)	5.0	R	1.732	0.23	0.26	0.7	0.8
Liquid Permittivity (mea.)	2.5	R	1.732	0.23	0.26	0.3	0.4
Temp. unc. - Permittivity	0.83	R	1.732	0.23	0.26	0.1	0.1
<b>Combined Std. Uncertainty</b>						12.5%	12.5%
<b>Coverage Factor for 95 %</b>						K=2	K=2
<b>Expanded STD Uncertainty</b>						25.0%	24.9%

**Table 17.3. Uncertainty Budget for frequency range 3 GHz to 6 GHz**



## **18. References**

- [1] FCC 47 CFR Part 2 "Frequency Allocations and Radio Treaty Matters; General Rules and Regulations"
- [2] ANSI/IEEE Std. C95.1-1992, "IEEE Standard for Safety Levels with Respect to Human Exposure to Radio Frequency Electromagnetic Fields, 3 kHz to 300 GHz", September 1992
- [3] IEEE Std. 1528-2013, "IEEE Recommended Practice for Determining the Peak Spatial-Average Specific Absorption Rate (SAR) in the Human Head from Wireless Communications Devices: Measurement Techniques", Sep 2013
- [4] SPEAG DASY System Handbook
- [5] FCC KDB 447498 D01 v06, "Mobile and Portable Device RF Exposure Procedures and Equipment Authorization Policies", Oct 2015
- [6] FCC KDB 941225 D01 v03r01, "3G SAR MEAUREMENT PROCEDURES", Oct 2015
- [7] FCC KDB 941225 D05 v02r05, "SAR Evaluation Considerations for LTE Devices", Dec 2015
- [8] FCC KDB 941225 D05A v01r02, "Rel. 10 LTE SAR Test Guidance and KDB Inquiries", Oct 2015
- [9] FCC KDB 616217 D04 v01r02, "SAR Evaluation Considerations for Laptop, Notebook, Netbook and Tablet Computers", Oct 2015
- [10] FCC KDB 865664 D01 v01r04, "SAR Measurement Requirements for 100 MHz to 6 GHz", Aug 2015.
- [11] FCC KDB 865664 D02 v01r02, "RF Exposure Compliance Reporting and Documentation Considerations" Oct 2015.



---

**Appendix A. Plots of System Performance Check**

The plots are shown as follows.

## System Check\_Body\_750MHz\_151229

### DUT: D750V3-1012

Communication System: CW; Frequency: 750 MHz; Duty Cycle: 1:1  
Medium: MSL\_750\_151229 Medium parameters used:  $f = 750$  MHz;  $\sigma = 0.963$  mho/m;  $\epsilon_r = 55.933$ ;  
 $\rho = 1000$  kg/m<sup>3</sup>  
Ambient Temperature : 23.5 °C; Liquid Temperature : 22.5 °C

### DASY5 Configuration:

- Probe: EX3DV4 - SN3697; ConvF(8.96, 8.96, 8.96); Calibrated: 2015/9/28;
- Sensor-Surface: 1.4mm (Mechanical Surface Detection)
- Electronics: DAE4 Sn1399; Calibrated: 2015/11/23
- Phantom: ELI 4.0\_Left; Type: QDOVA001BB; Serial: 1026
- Measurement SW: DASY52, Version 52.8 (1); SEMCAD X Version 14.6.5 (6469)

**Configuration/Pin=250mW/Area Scan (61x61x1):** Measurement grid: dx=15mm, dy=15mm

Maximum value of SAR (interpolated) = 2.63 mW/g

**Configuration/Pin=250mW/Zoom Scan (5x5x7)/Cube 0:** Measurement grid: dx=8mm, dy=8mm, dz=5mm

Reference Value = 54.738 V/m; Power Drift = -0.06 dB

Peak SAR (extrapolated) = 2.901 mW/g

**SAR(1 g) = 1.99 mW/g; SAR(10 g) = 1.34 mW/g**

Maximum value of SAR (measured) = 2.60 mW/g

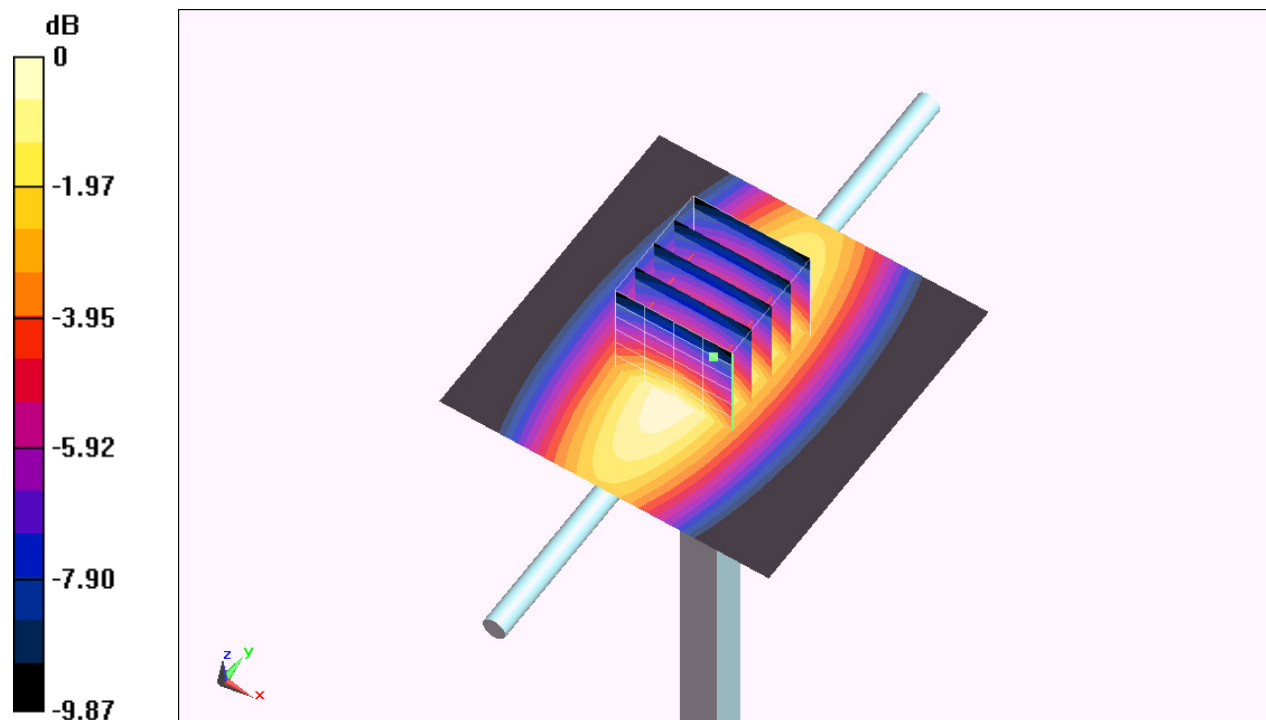

0 dB = 2.60 mW/g = 8.30 dB mW/g

## System Check\_Body\_750MHz\_151231

### DUT: D750V3-1012

Communication System: CW; Frequency: 750 MHz; Duty Cycle: 1:1

Medium: MSL\_750\_151231 Medium parameters used:  $f = 750 \text{ MHz}$ ;  $\sigma = 0.97 \text{ mho/m}$ ;  $\epsilon_r = 54.699$ ;  
 $\rho = 1000 \text{ kg/m}^3$

Ambient Temperature :  $23.5 \text{ }^\circ\text{C}$ ; Liquid Temperature :  $22.5 \text{ }^\circ\text{C}$

#### DASY5 Configuration:

- Probe: EX3DV4 - SN3578; ConvF(9.29, 9.29, 9.29); Calibrated: 2015/3/31;
- Sensor-Surface: 1.4mm (Mechanical Surface Detection)
- Electronics: DAE4 Sn1399; Calibrated: 2015/11/23
- Phantom: ELI 4.0\_Left; Type: QDOVA001BB; Serial: 1026
- Measurement SW: DASY52, Version 52.8 (1); SEMCAD X Version 14.6.5 (6469)

**Configuration/Pin=250mW/Area Scan (61x61x1):** Measurement grid:  $dx=15\text{mm}$ ,  
 $dy=15\text{mm}$

Maximum value of SAR (interpolated) =  $2.65 \text{ mW/g}$

**Configuration/Pin=250mW/Zoom Scan (5x5x7)/Cube 0:** Measurement grid:  $dx=8\text{mm}$ ,  
 $dy=8\text{mm}$ ,  $dz=5\text{mm}$

Reference Value =  $54.146 \text{ V/m}$ ; Power Drift =  $0.14 \text{ dB}$

Peak SAR (extrapolated) =  $2.908 \text{ mW/g}$

**SAR(1 g) =  $2.06 \text{ mW/g}$ ; SAR(10 g) =  $1.39 \text{ mW/g}$**

Maximum value of SAR (measured) =  $2.55 \text{ mW/g}$

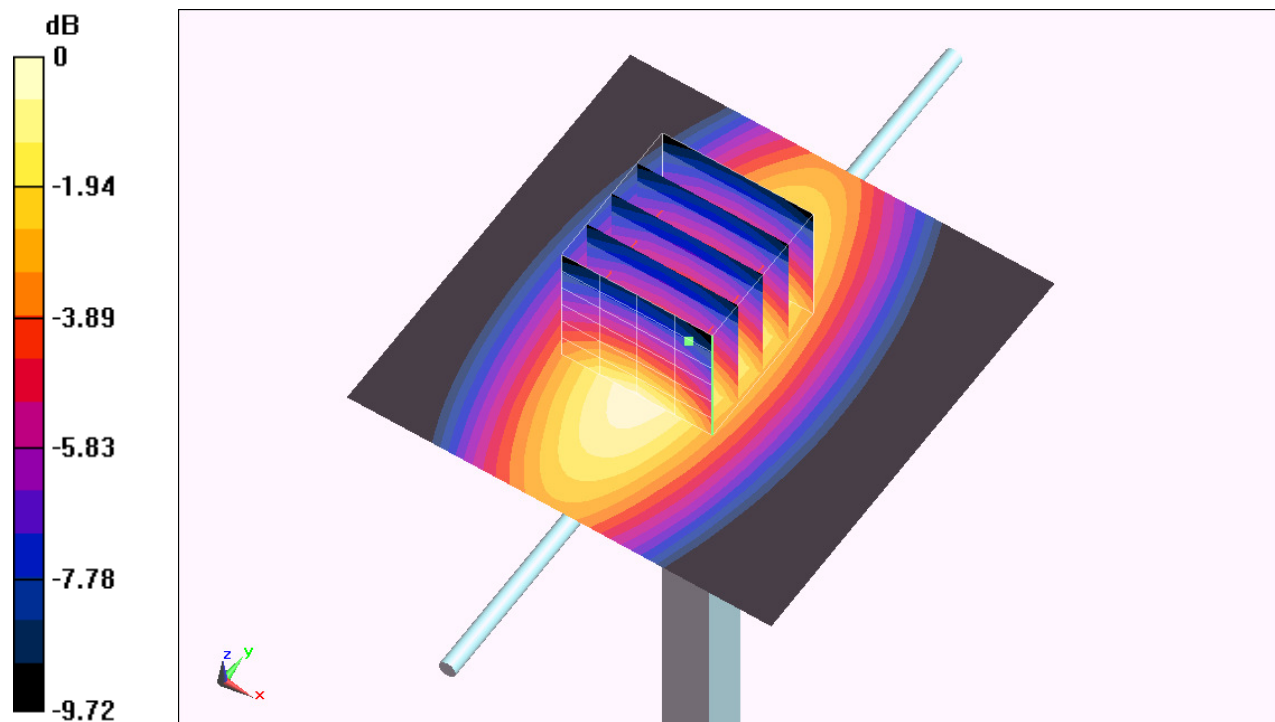

0 dB =  $2.55 \text{ mW/g}$  =  $8.13 \text{ dB mW/g}$



## System Check\_Body\_835MHz\_151229

### DUT: D835V2-499

Communication System: CW ; Frequency: 835 MHz;Duty Cycle: 1:1

Medium: MSL\_850\_151229 Medium parameters used:  $f = 835 \text{ MHz}$ ;  $\sigma = 0.972 \text{ mho/m}$ ;  $\epsilon_r = 55.117$ ;  
 $\rho = 1000 \text{ kg/m}^3$

Ambient Temperature :  $23.5 \text{ }^\circ\text{C}$ ; Liquid Temperature :  $22.5 \text{ }^\circ\text{C}$

### DASY5 Configuration:

- Probe: EX3DV4 - SN3697; ConvF(8.9, 8.9, 8.9); Calibrated: 2015/9/28;
- Sensor-Surface: 1.4mm (Mechanical Surface Detection)
- Electronics: DAE4 Sn1399; Calibrated: 2015/11/23
- Phantom: ELI 4.0\_Left; Type: QDOVA001BB; Serial: 1026
- Measurement SW: DASY52, Version 52.8 (1);SEMCAD X Version 14.6.5 (6469)

**Configuration/Pin=250mW/Area Scan (61x61x1):** Measurement grid:  $dx=15\text{mm}$ ,  
 $dy=15\text{mm}$

Maximum value of SAR (interpolated) =  $3.08 \text{ mW/g}$

**Configuration/Pin=250mW/Zoom Scan (5x5x7)/Cube 0:** Measurement grid:  $dx=8\text{mm}$ ,  
 $dy=8\text{mm}$ ,  $dz=5\text{mm}$

Reference Value =  $58.974 \text{ V/m}$ ; Power Drift =  $-0.14 \text{ dB}$

Peak SAR (extrapolated) =  $3.519 \text{ mW/g}$

**SAR(1 g) =  $2.43 \text{ mW/g}$ ; SAR(10 g) =  $1.61 \text{ mW/g}$**

Maximum value of SAR (measured) =  $3.02 \text{ mW/g}$

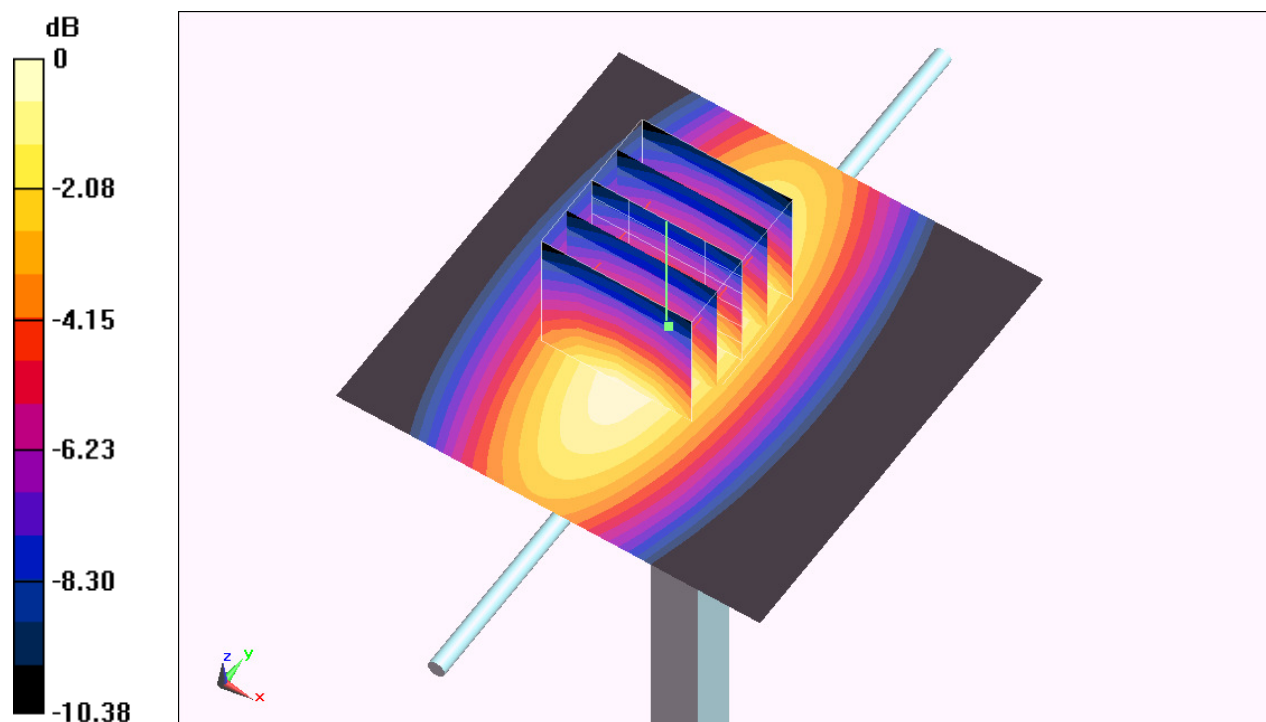

### System Check\_Body\_835MHz\_151231

#### DUT: D835V2-499

Communication System: CW; Frequency: 835 MHz; Duty Cycle: 1:1  
Medium: MSL\_850\_151231 Medium parameters used:  $f = 835 \text{ MHz}$ ;  $\sigma = 0.966 \text{ mho/m}$ ;  $\epsilon_r = 56.435$ ;  
 $\rho = 1000 \text{ kg/m}^3$   
Ambient Temperature :  $23.5 \text{ }^\circ\text{C}$ ; Liquid Temperature :  $22.5 \text{ }^\circ\text{C}$

#### DASY5 Configuration:

- Probe: EX3DV4 - SN3578; ConvF(9.27, 9.27, 9.27); Calibrated: 2015/3/31;
- Sensor-Surface: 1.4mm (Mechanical Surface Detection)
- Electronics: DAE4 Sn1399; Calibrated: 2015/11/23
- Phantom: ELI 4.0\_Left; Type: QDOVA001BB; Serial: 1026
- Measurement SW: DASY52, Version 52.8 (1); SEMCAD X Version 14.6.5 (6469)

**Configuration/Pin=250mW/Area Scan (61x61x1):** Measurement grid:  $dx=15\text{mm}$ ,  
 $dy=15\text{mm}$   
Maximum value of SAR (interpolated) =  $3.34 \text{ mW/g}$

**Configuration/Pin=250mW/Zoom Scan (5x5x7)/Cube 0:** Measurement grid:  $dx=8\text{mm}$ ,  
 $dy=8\text{mm}$ ,  $dz=5\text{mm}$   
Reference Value =  $60.753 \text{ V/m}$ ; Power Drift =  $-0.13 \text{ dB}$   
Peak SAR (extrapolated) =  $3.468 \text{ mW/g}$   
**SAR(1 g) =  $2.36 \text{ mW/g}$ ; SAR(10 g) =  $1.58 \text{ mW/g}$**   
Maximum value of SAR (measured) =  $3.08 \text{ mW/g}$

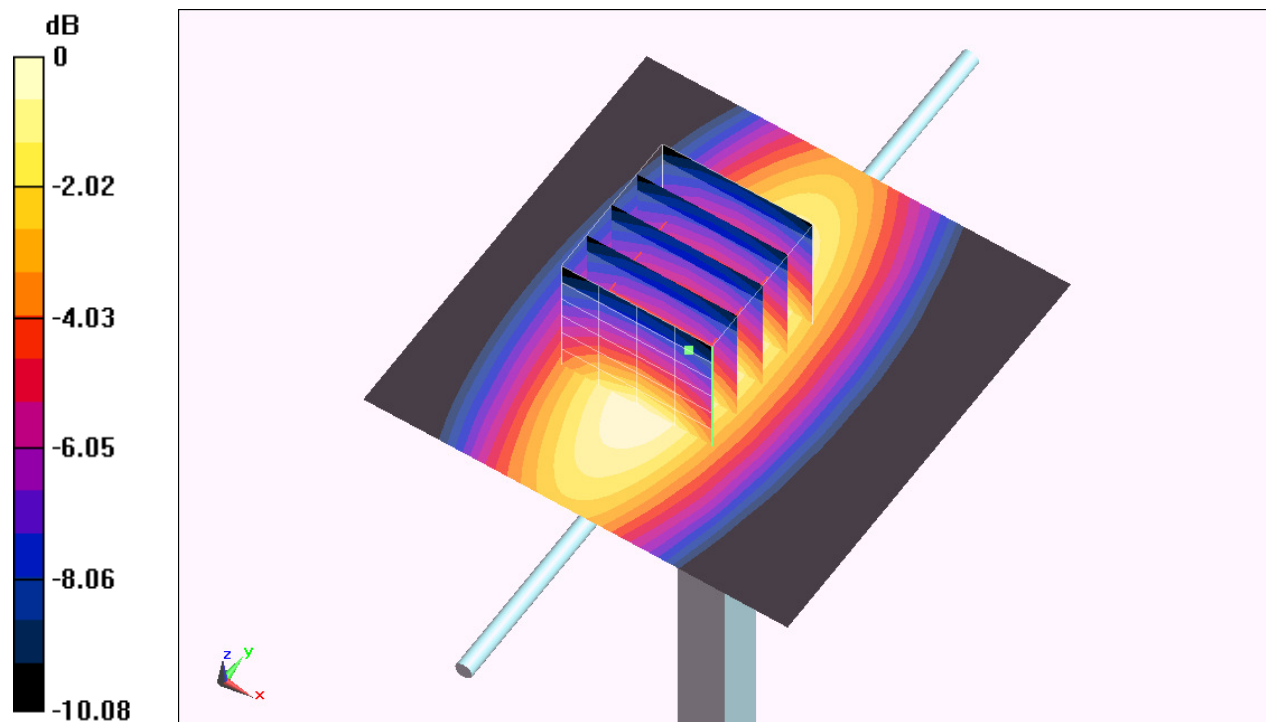

0 dB =  $3.08 \text{ mW/g} = 9.77 \text{ dB mW/g}$

### System Check\_Body\_1750MHz\_151225

#### DUT: D1750V2\_1068

Communication System: CW; Frequency: 1750 MHz; Duty Cycle: 1:1  
Medium: MSL\_1750\_151225 Medium parameters used:  $f = 1750$  MHz;  $\sigma = 1.477$  mho/m;  $\epsilon_r = 54.431$ ;  $\rho = 1000$  kg/m<sup>3</sup>  
Ambient Temperature : 23.4 °C ; Liquid Temperature : 22.4 °C

#### DASY5 Configuration:

- Probe: EX3DV4 - SN3697; ConvF(7.34, 7.34, 7.34); Calibrated: 2015/9/28;
- Sensor-Surface: 1.4mm (Mechanical Surface Detection)
- Electronics: DAE4 Sn1399; Calibrated: 2015/11/23
- Phantom: ELI 4.0\_Left; Type: QDOVA001BB; Serial: 1026
- Measurement SW: DASY52, Version 52.8 (1); SEMCAD X Version 14.6.5 (6469)

**Configuration/Pin=250mW/Area Scan (61x61x1):** Measurement grid: dx=15mm, dy=15mm

Maximum value of SAR (interpolated) = 14.3 mW/g

**Configuration/Pin=250mW/Zoom Scan (5x5x7)/Cube 0:** Measurement grid: dx=8mm, dy=8mm, dz=5mm

Reference Value = 95.016 V/m; Power Drift = -0.03 dB

Peak SAR (extrapolated) = 16.488 mW/g

**SAR(1 g) = 9.44 mW/g; SAR(10 g) = 5.07 mW/g**

Maximum value of SAR (measured) = 13.0 mW/g

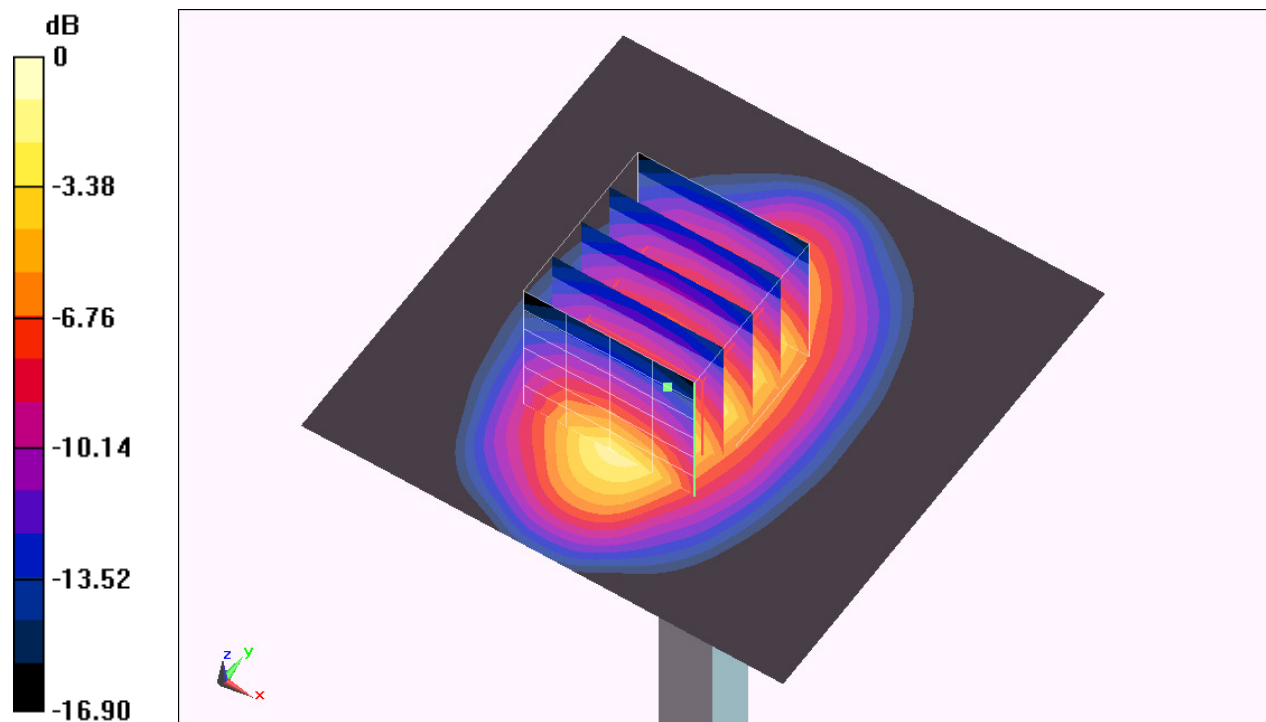

0 dB = 13.0 mW/g = 22.28 dB mW/g

## System Check\_Body\_1900MHz\_151225

### DUT: D1900V2\_5d041

Communication System: CW; Frequency: 1900 MHz; Duty Cycle: 1:1  
Medium: MSL\_1900\_151225 Medium parameters used:  $f = 1900$  MHz;  $\sigma = 1.58$  mho/m;  $\epsilon_r = 54.709$ ;  $\rho = 1000$  kg/m<sup>3</sup>  
Ambient Temperature : 23.4 °C; Liquid Temperature : 22.4 °C

#### DASY5 Configuration:

- Probe: EX3DV4 - SN3697; ConvF(7.17, 7.17, 7.17); Calibrated: 2015/9/28;
- Sensor-Surface: 1.4mm (Mechanical Surface Detection)
- Electronics: DAE4 Sn1399; Calibrated: 2015/11/23
- Phantom: ELI 4.0\_Left; Type: QDOVA001BB; Serial: 1026
- Measurement SW: DASY52, Version 52.8 (1); SEMCAD X Version 14.6.5 (6469)

**Configuration/Pin=250mW/Area Scan (61x61x1):** Measurement grid: dx=15mm, dy=15mm

Maximum value of SAR (interpolated) = 15.4 mW/g

**Configuration/Pin=250mW/Zoom Scan (5x5x7)/Cube 0:** Measurement grid: dx=8mm, dy=8mm, dz=5mm

Reference Value = 93.727 V/m; Power Drift = -0.06 dB

Peak SAR (extrapolated) = 17.491 mW/g

**SAR(1 g) = 9.93 mW/g; SAR(10 g) = 5.21 mW/g**

Maximum value of SAR (measured) = 15.1 mW/g

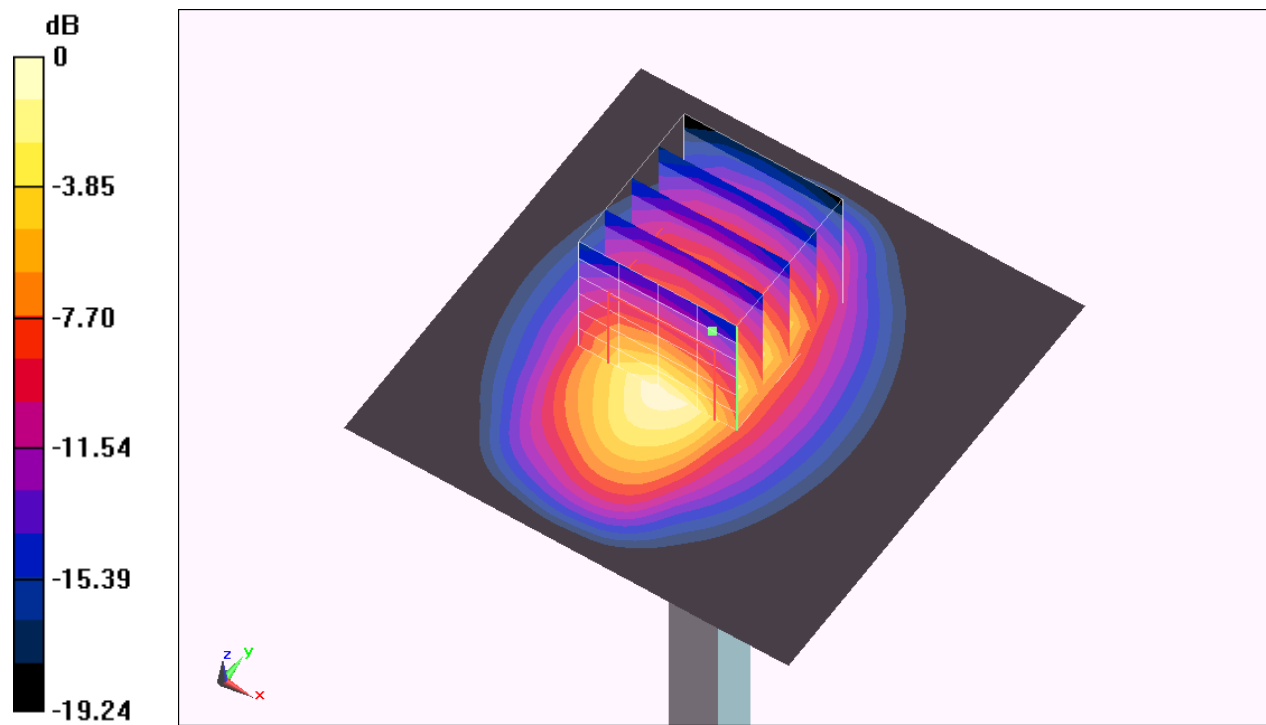

0 dB = 15.1 mW/g = 23.58 dB mW/g

## System Check\_Body\_1900MHz\_160101

### DUT: D1900V2\_5d041

Communication System: CW; Frequency: 1900 MHz; Duty Cycle: 1:1  
Medium: MSL\_1900\_160101 Medium parameters used:  $f = 1900$  MHz;  $\sigma = 1.57$  mho/m;  $\epsilon_r = 53.024$ ;  $\rho = 1000$  kg/m<sup>3</sup>  
Ambient Temperature : 23.4 °C; Liquid Temperature : 22.4 °C

#### DASY5 Configuration:

- Probe: EX3DV4 - SN3578; ConvF(7.28, 7.28, 7.28); Calibrated: 2015/3/31;
- Sensor-Surface: 1.4mm (Mechanical Surface Detection)
- Electronics: DAE4 Sn1399; Calibrated: 2015/11/23
- Phantom: ELI 4.0\_Left; Type: QDOVA001BB; Serial: 1026
- Measurement SW: DASY52, Version 52.8 (1); SEMCAD X Version 14.6.5 (6469)

**Configuration/Pin=250mW/Area Scan (61x61x1):** Measurement grid: dx=15mm, dy=15mm

Maximum value of SAR (interpolated) = 15.0 mW/g

**Configuration/Pin=250mW/Zoom Scan (5x5x7)/Cube 0:** Measurement grid: dx=8mm, dy=8mm, dz=5mm

Reference Value = 101.8 V/m; Power Drift = -0.00 dB

Peak SAR (extrapolated) = 17.636 mW/g

**SAR(1 g) = 9.68 mW/g; SAR(10 g) = 5 mW/g**

Maximum value of SAR (measured) = 15.0 mW/g

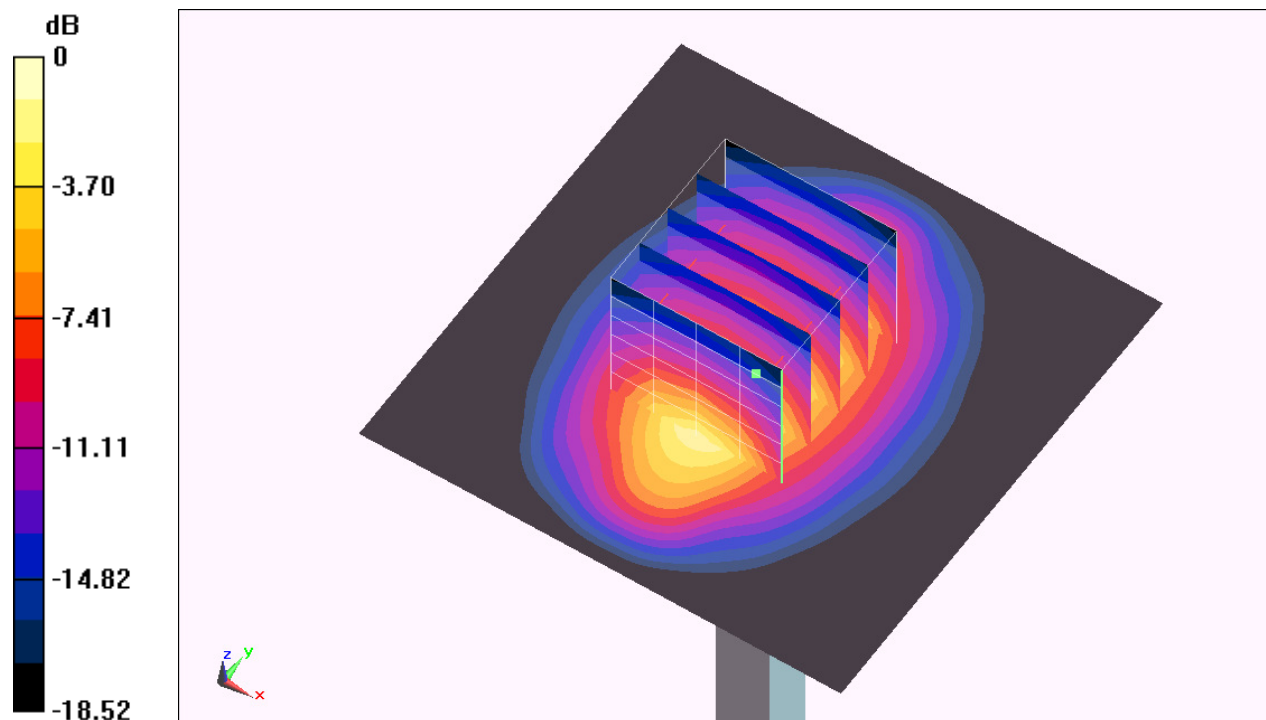

0 dB = 15.0 mW/g = 23.52 dB mW/g

## System Check\_Body\_2600MHz\_151224

### DUT: D2600V2-1008

Communication System: CW; Frequency: 2600 MHz; Duty Cycle: 1:1  
Medium: MSL\_2600\_151224 Medium parameters used:  $f = 2600 \text{ MHz}$ ;  $\sigma = 2.224 \text{ mho/m}$ ;  $\epsilon_r = 51.037$ ;  $\rho = 1000 \text{ kg/m}^3$   
Ambient Temperature :  $23.4 \text{ }^\circ\text{C}$ ; Liquid Temperature :  $22.4 \text{ }^\circ\text{C}$

### DASY5 Configuration:

- Probe: ES3DV3 - SN3270; ConvF(4.27, 4.27, 4.27); Calibrated: 2015/9/28;
- Sensor-Surface: 2mm (Mechanical Surface Detection)
- Electronics: DAE4 Sn778; Calibrated: 2015/8/25
- Phantom: ELI 4.0\_Left; Type: QDOVA001BB; Serial: 1026
- Measurement SW: DASY52, Version 52.8 (1); SEMCAD X Version 14.6.5 (6469)

**Configuration/Pin=250mW/Area Scan (71x71x1):** Measurement grid:  $dx=12\text{mm}$ ,  $dy=12\text{mm}$

Maximum value of SAR (interpolated) =  $20.6 \text{ mW/g}$

**Configuration/Pin=250mW/Zoom Scan (7x7x7)/Cube 0:** Measurement grid:  $dx=5\text{mm}$ ,  $dy=5\text{mm}$ ,  $dz=5\text{mm}$

Reference Value =  $104.6 \text{ V/m}$ ; Power Drift =  $0.01 \text{ dB}$

Peak SAR (extrapolated) =  $29.295 \text{ mW/g}$

**SAR(1 g) =  $13.5 \text{ mW/g}$ ; SAR(10 g) =  $6.05 \text{ mW/g}$**

Maximum value of SAR (measured) =  $21.1 \text{ mW/g}$

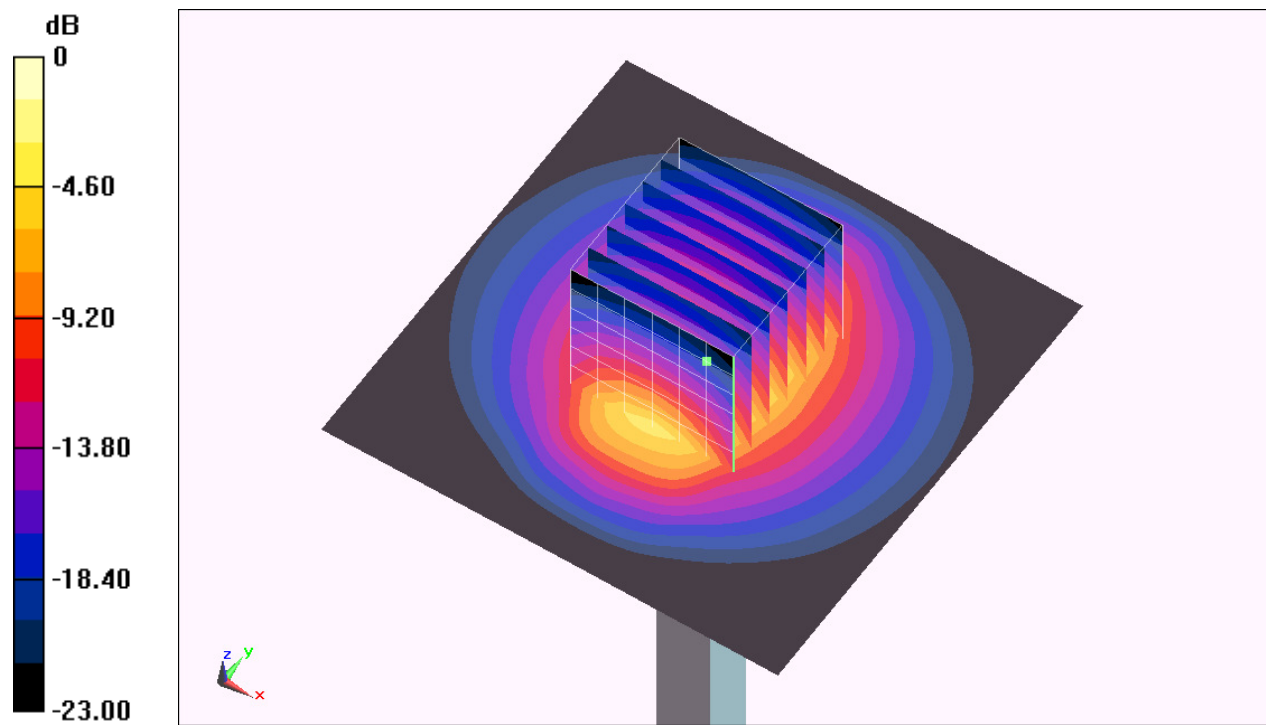

0 dB =  $21.1 \text{ mW/g} = 26.49 \text{ dB mW/g}$



---

**Appendix B. Plots of SAR Measurement**

The plots are shown as follows.

### #01\_WCDMA II\_RMC 12.2Kbps\_Bottom Face\_11mm\_Ch9262

Communication System: WCDMA; Frequency: 1852.4 MHz; Duty Cycle: 1:1  
Medium: MSL\_1900\_151225 Medium parameters used:  $f = 1852.4 \text{ MHz}$ ;  $\sigma = 1.527 \text{ mho/m}$ ;  $\epsilon_r = 54.885$ ;  $\rho = 1000 \text{ kg/m}^3$   
Ambient Temperature : 23.4 °C; Liquid Temperature : 22.4 °C

#### DASY5 Configuration:

- Probe: EX3DV4 - SN3697; ConvF(7.17, 7.17, 7.17); Calibrated: 2015/9/28;
- Sensor-Surface: 1.4mm (Mechanical Surface Detection)
- Electronics: DAE4 Sn1399; Calibrated: 2015/11/23
- Phantom: ELI 4.0\_Left; Type: QDOVA001BB; Serial: 1026
- Measurement SW: DASY52, Version 52.8 (1); SEMCAD X Version 14.6.5 (6469)

**Configuration/Ch9262/Area Scan (51x61x1):** Measurement grid:  $dx=15\text{mm}$ ,  $dy=15\text{mm}$   
Maximum value of SAR (interpolated) = 1.16 mW/g

**Configuration/Ch9262/Zoom Scan (5x5x7)/Cube 0:** Measurement grid:  $dx=8\text{mm}$ ,  
 $dy=8\text{mm}$ ,  $dz=5\text{mm}$

Reference Value = 20.790 V/m; Power Drift = -0.05 dB

Peak SAR (extrapolated) = 1.304 mW/g

**SAR(1 g) = 0.778 mW/g; SAR(10 g) = 0.455 mW/g**

Maximum value of SAR (measured) = 1.13 mW/g

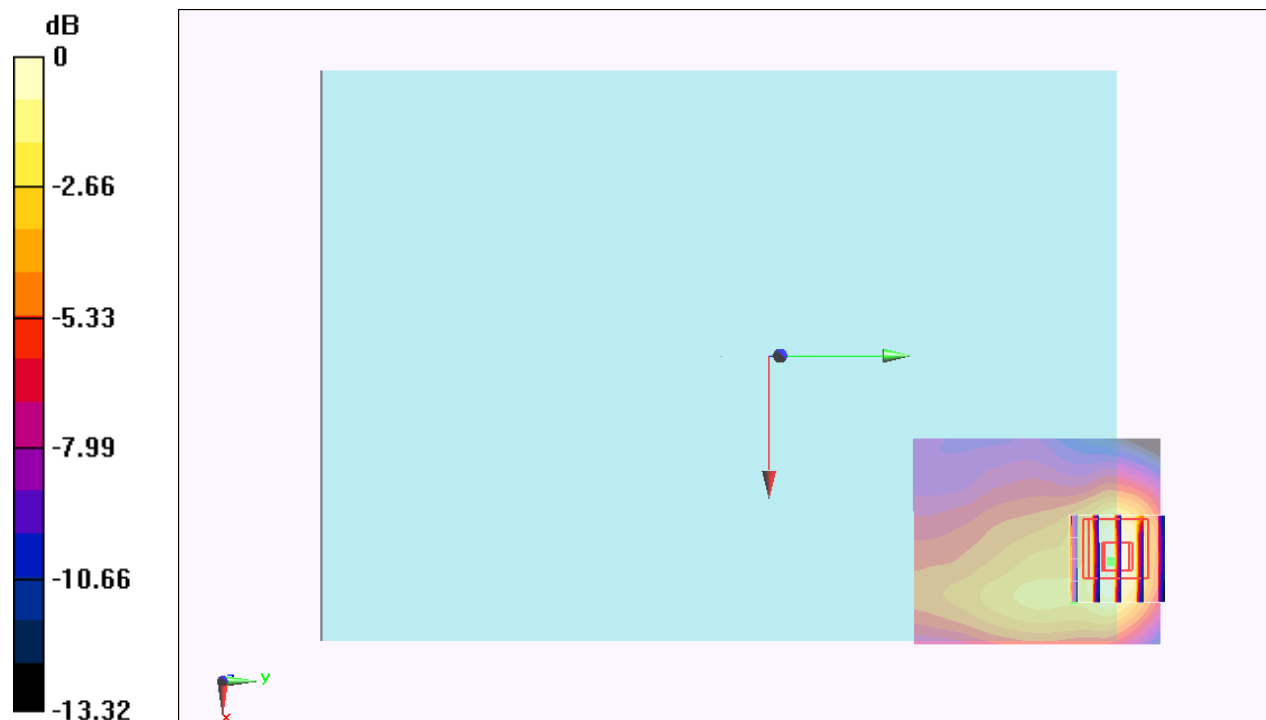

0 dB = 1.13 mW/g = 1.06 dB mW/g



### #02\_WCDMA IV\_RMC 12.2Kbps\_Bottom Face\_11mm\_Ch1513

Communication System: WCDMA; Frequency: 1752.6 MHz; Duty Cycle: 1:1  
Medium: MSL\_1750\_151225 Medium parameters used:  $f = 1753$  MHz;  $\sigma = 1.48$  mho/m;  $\epsilon_r = 54.427$ ;  $\rho = 1000$  kg/m<sup>3</sup>  
Ambient Temperature : 23.4 °C; Liquid Temperature : 22.4 °C

#### DASY5 Configuration:

- Probe: EX3DV4 - SN3697; ConvF(7.34, 7.34, 7.34); Calibrated: 2015/9/28;
- Sensor-Surface: 1.4mm (Mechanical Surface Detection)
- Electronics: DAE4 Sn1399; Calibrated: 2015/11/23
- Phantom: ELI 4.0\_Left; Type: QDOVA001BB; Serial: 1026
- Measurement SW: DASY52, Version 52.8 (1); SEMCAD X Version 14.6.5 (6469)

**Configuration/Ch1513/Area Scan (51x61x1):** Measurement grid: dx=15mm, dy=15mm  
Maximum value of SAR (interpolated) = 1.40 mW/g

**Configuration/Ch1513/Zoom Scan (5x5x7)/Cube 0:** Measurement grid: dx=8mm, dy=8mm, dz=5mm

Reference Value = 23.418 V/m; Power Drift = -0.06 dB

Peak SAR (extrapolated) = 1.620 mW/g

**SAR(1 g) = 0.975 mW/g; SAR(10 g) = 0.573 mW/g**

Maximum value of SAR (measured) = 1.40 mW/g

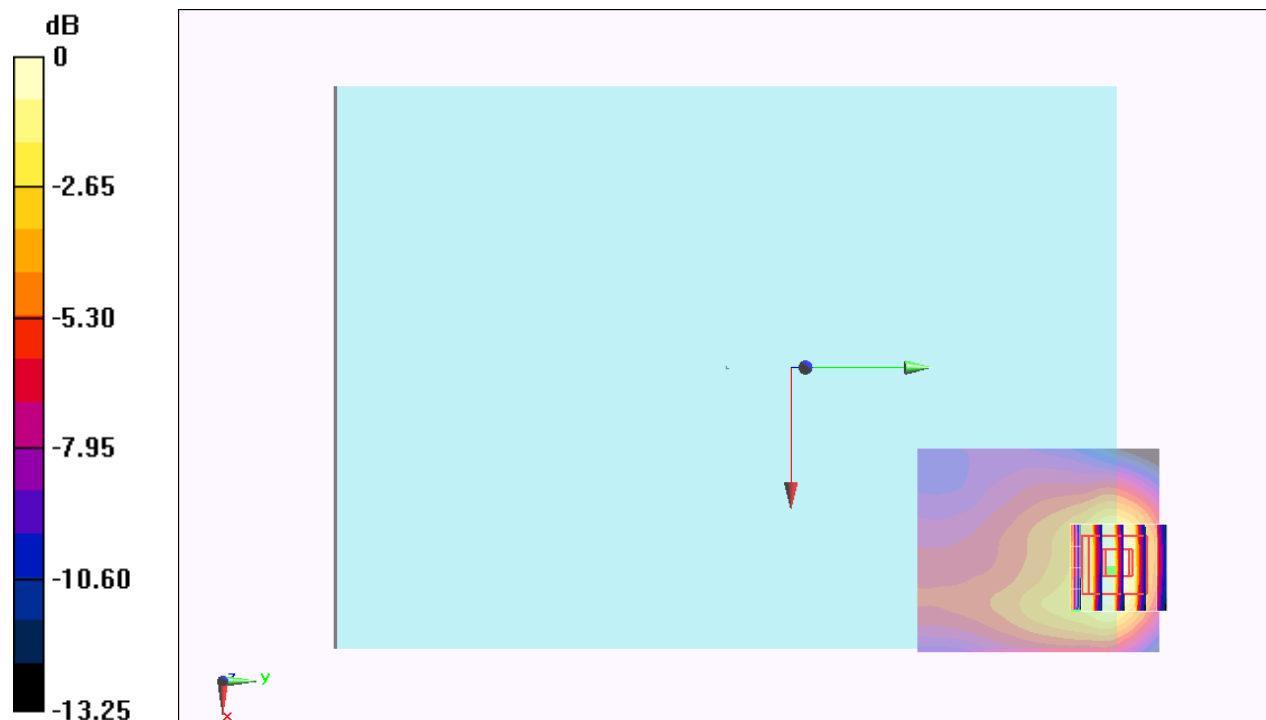

0 dB = 1.40 mW/g = 2.92 dB mW/g

### #03\_WCDMA V\_RMC 12.2Kbps\_Bottom Face\_0mm\_Ch4182

Communication System: WCDMA; Frequency: 836.4 MHz; Duty Cycle: 1:1  
Medium: MSL\_850\_151229 Medium parameters used :  $f = 836.4$  MHz;  $\sigma = 0.973$  mho/m;  $\epsilon_r = 55.1$ ;  
 $\rho = 1000$  kg/m<sup>3</sup>  
Ambient Temperature : 23.5 °C; Liquid Temperature : 22.5 °C

#### DASY5 Configuration:

- Probe: EX3DV4 - SN3697; ConvF(8.9, 8.9, 8.9); Calibrated: 2015/9/28;
- Sensor-Surface: 1.4mm (Mechanical Surface Detection)
- Electronics: DAE4 Sn1399; Calibrated: 2015/11/23
- Phantom: ELI 4.0\_Left; Type: QDOVA001BB; Serial: 1026
- Measurement SW: DASY52, Version 52.8 (1); SEMCAD X Version 14.6.5 (6469)

**Configuration/Ch4182/Area Scan (51x61x1):** Measurement grid: dx=15mm, dy=15mm  
Maximum value of SAR (interpolated) = 1.19 mW/g

**Configuration/Ch4182/Zoom Scan (5x5x7)/Cube 0:** Measurement grid: dx=8mm, dy=8mm, dz=5mm

Reference Value = 25.424 V/m; Power Drift = 0.00 dB

Peak SAR (extrapolated) = 1.477 mW/g

**SAR(1 g) = 0.804 mW/g; SAR(10 g) = 0.479 mW/g**

Maximum value of SAR (measured) = 1.23 mW/g

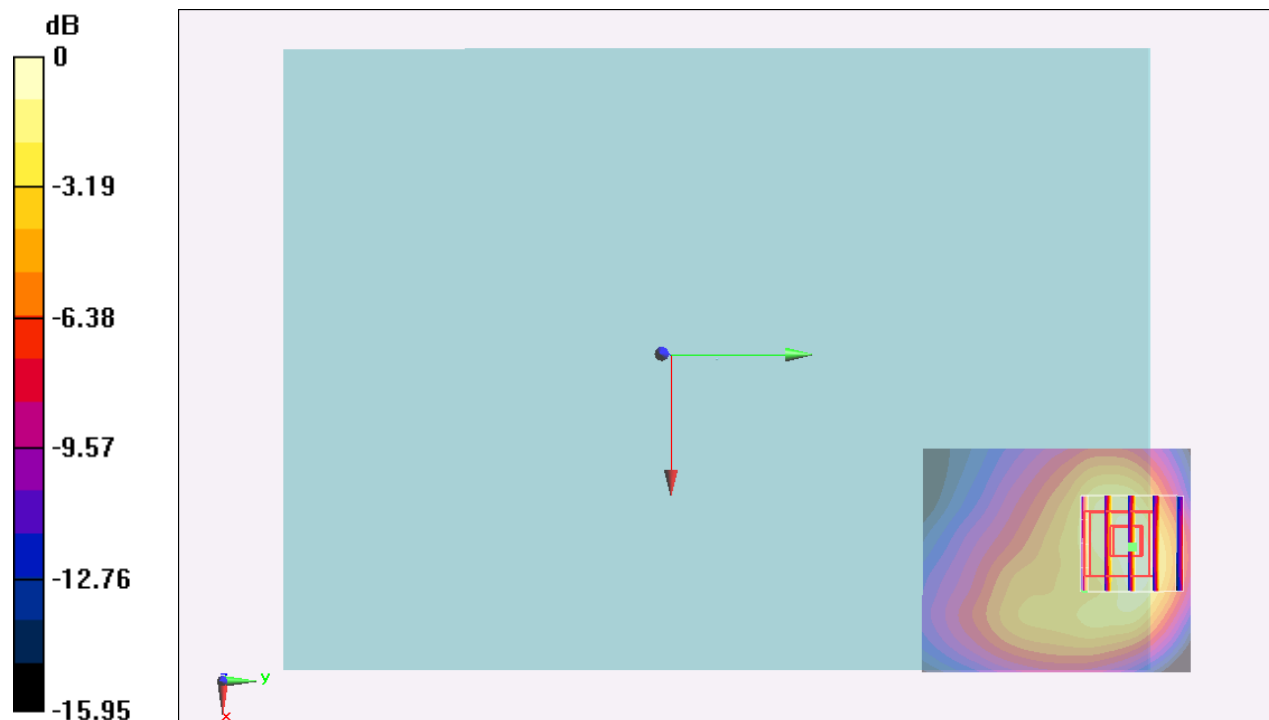

0 dB = 1.23 mW/g = 1.80 dB mW/g

### #04\_LTE Band 4\_20M\_QPSK\_1\_0\_Edge 2\_0mm\_Ch20175

Communication System: LTE; Frequency: 1732.5 MHz; Duty Cycle: 1:1  
Medium: MSL\_1750\_151225 Medium parameters used:  $f = 1732.5$  MHz;  $\sigma = 1.458$  mho/m;  $\epsilon_r = 54.475$ ;  $\rho = 1000$  kg/m<sup>3</sup>  
Ambient Temperature : 23.4 °C; Liquid Temperature : 22.4 °C

#### DASY5 Configuration:

- Probe: EX3DV4 - SN3697; ConvF(7.34, 7.34, 7.34); Calibrated: 2015/9/28;
- Sensor-Surface: 1.4mm (Mechanical Surface Detection)
- Electronics: DAE4 Sn1399; Calibrated: 2015/11/23
- Phantom: ELI 4.0\_Left; Type: QDOVA001BB; Serial: 1026
- Measurement SW: DASY52, Version 52.8 (1); SEMCAD X Version 14.6.5 (6469)

**Configuration/Ch20175/Area Scan (51x61x1):** Measurement grid: dx=15mm, dy=15mm  
Maximum value of SAR (interpolated) = 1.73 mW/g

**Configuration/Ch20175/Zoom Scan (5x5x7)/Cube 0:** Measurement grid: dx=8mm, dy=8mm, dz=5mm

Reference Value = 28.728 V/m; Power Drift = 0.15 dB

Peak SAR (extrapolated) = 2.015 mW/g

**SAR(1 g) = 1.05 mW/g; SAR(10 g) = 0.527 mW/g**

Maximum value of SAR (measured) = 1.65 mW/g

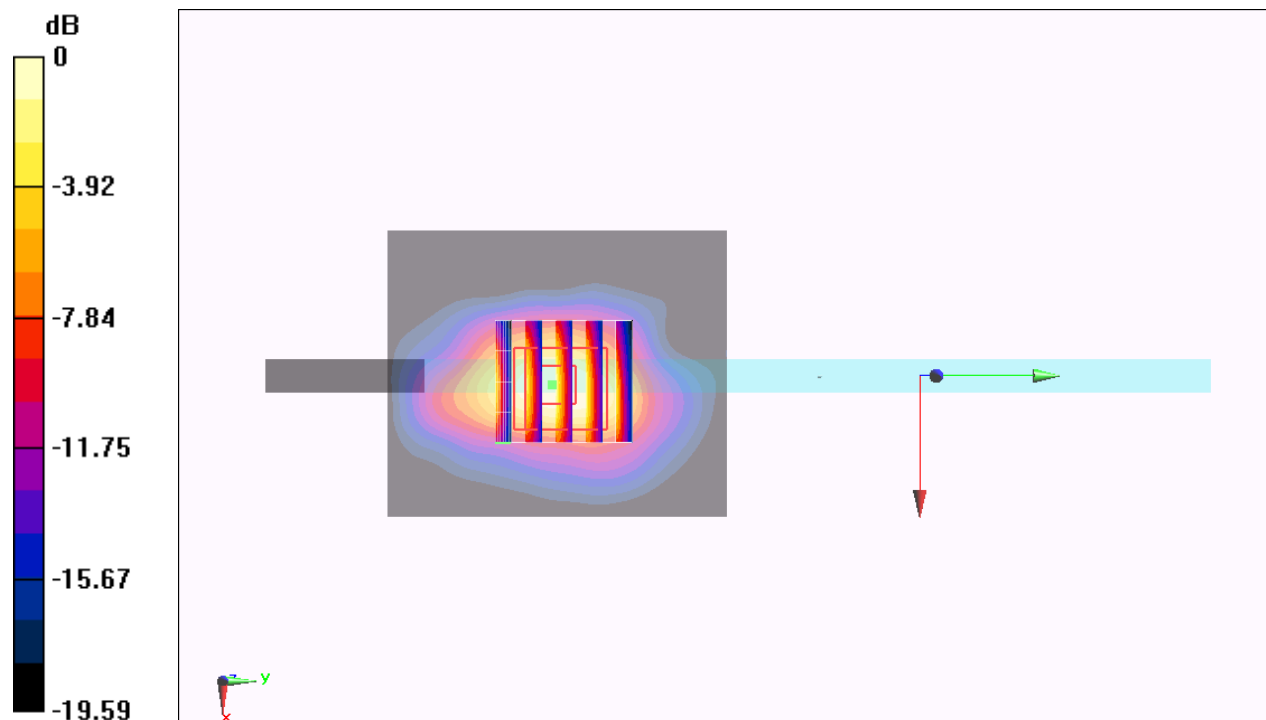

0 dB = 1.65 mW/g = 4.35 dB mW/g

### #05\_LTE Band 7\_20M\_QPSK\_1\_0\_Bottom Face\_0mm\_Ch21350

Communication System: LTE; Frequency: 2560 MHz; Duty Cycle: 1:1  
Medium: MSL\_2600\_151224 Medium parameters used:  $f = 2560$  MHz;  $\sigma = 2.168$  mho/m;  $\epsilon_r = 51.17$ ;  $\rho = 1000$  kg/m<sup>3</sup>  
Ambient Temperature : 23.4 °C; Liquid Temperature : 22.4 °C

#### DASY5 Configuration:

- Probe: ES3DV3 - SN3270; ConvF(4.27, 4.27, 4.27); Calibrated: 2015/9/28;
- Sensor-Surface: 2mm (Mechanical Surface Detection)
- Electronics: DAE4 Sn778; Calibrated: 2015/8/25
- Phantom: ELI 4.0\_Left; Type: QDOVA001BB; Serial: 1026
- Measurement SW: DASY52, Version 52.8 (1); SEMCAD X Version 14.6.5 (6469)

**Configuration/Ch21350/Area Scan (61x71x1):** Measurement grid: dx=12mm, dy=12mm  
Maximum value of SAR (interpolated) = 2.04 mW/g

**Configuration/Ch21350/Zoom Scan (7x7x7)/Cube 0:** Measurement grid: dx=5mm, dy=5mm, dz=5mm

Reference Value = 16.936 V/m; Power Drift = -0.11 dB

Peak SAR (extrapolated) = 2.878 mW/g

**SAR(1 g) = 1.1 mW/g; SAR(10 g) = 0.401 mW/g**

Maximum value of SAR (measured) = 1.86 mW/g

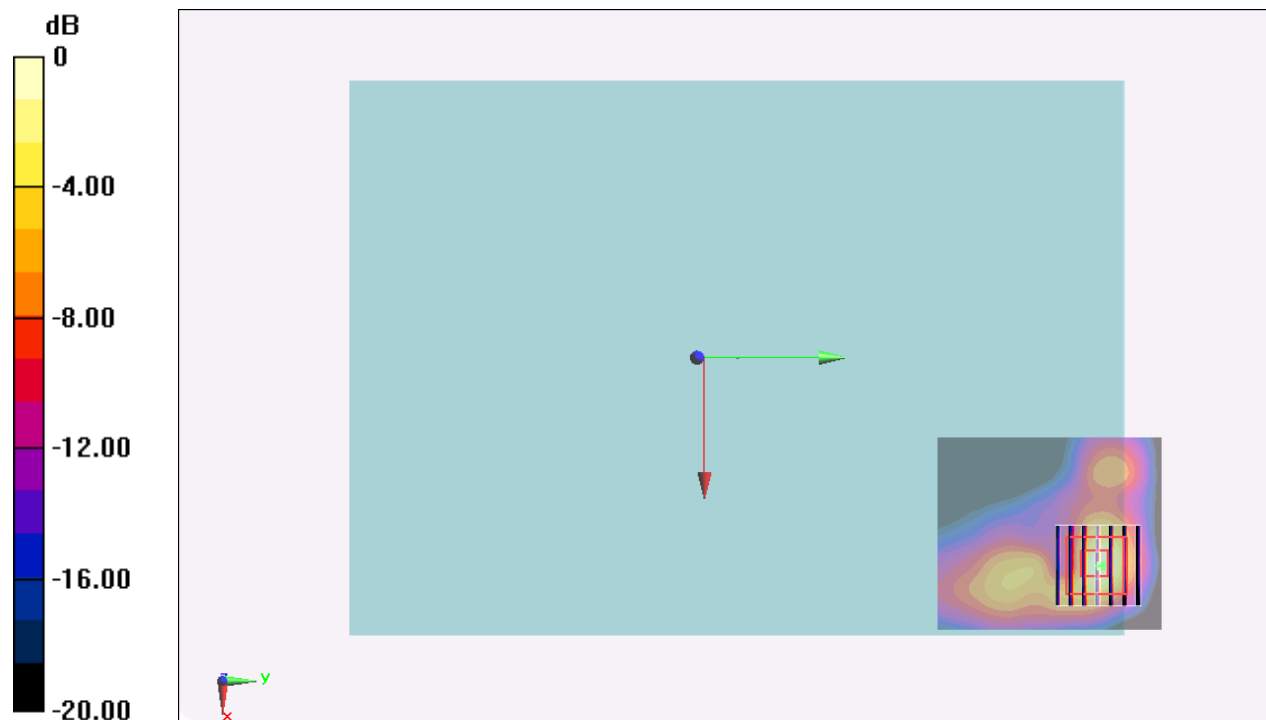

0 dB = 1.86 mW/g = 5.39 dB mW/g

### #06\_LTE Band 12\_10M\_QPSK\_1\_0\_Bottom Face\_0mm\_Ch23095

Communication System: LTE; Frequency: 782 MHz; Duty Cycle: 1:1  
Medium: MSL\_750\_151229 Medium parameters used:  $f = 782 \text{ MHz}$ ;  $\sigma = 0.995 \text{ mho/m}$ ;  $\epsilon_r = 55.608$ ;  
 $\rho = 1000 \text{ kg/m}^3$   
Ambient Temperature :  $23.5 \text{ }^\circ\text{C}$ ; Liquid Temperature :  $22.5 \text{ }^\circ\text{C}$

#### DASY5 Configuration:

- Probe: EX3DV4 - SN3697; ConvF(8.96, 8.96, 8.96); Calibrated: 2015/9/28;
- Sensor-Surface: 1.4mm (Mechanical Surface Detection)
- Electronics: DAE4 Sn1399; Calibrated: 2015/11/23
- Phantom: ELI 4.0\_Left; Type: QDOVA001BB; Serial: 1026
- Measurement SW: DASY52, Version 52.8 (1); SEMCAD X Version 14.6.5 (6469)

**Configuration/Ch23095/Area Scan (51x61x1):** Measurement grid:  $dx=15\text{mm}$ ,  $dy=15\text{mm}$   
Maximum value of SAR (interpolated) =  $1.23 \text{ mW/g}$

**Configuration/Ch23095/Zoom Scan (5x5x7)/Cube 0:** Measurement grid:  $dx=8\text{mm}$ ,  
 $dy=8\text{mm}$ ,  $dz=5\text{mm}$

Reference Value =  $16.780 \text{ V/m}$ ; Power Drift =  $0.16 \text{ dB}$

Peak SAR (extrapolated) =  $1.519 \text{ mW/g}$

**SAR(1 g) =  $0.768 \text{ mW/g}$ ; SAR(10 g) =  $0.436 \text{ mW/g}$**

Maximum value of SAR (measured) =  $1.21 \text{ mW/g}$

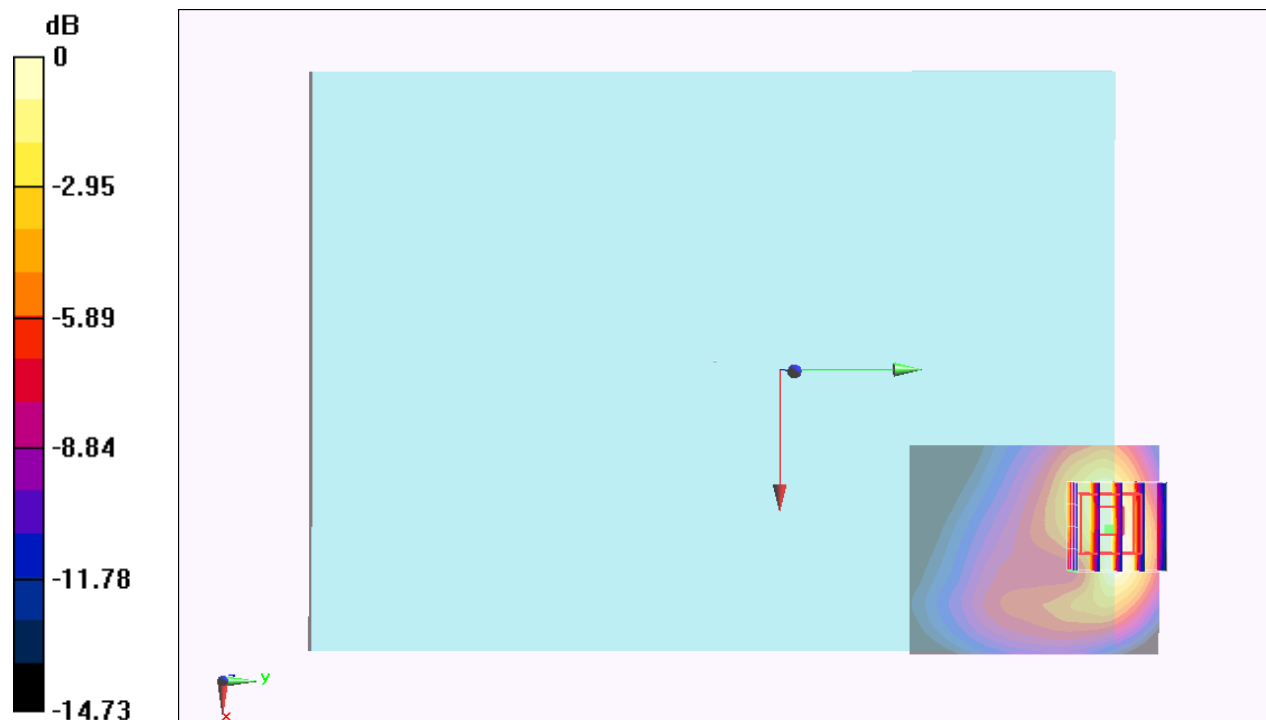

0 dB =  $1.21 \text{ mW/g} = 1.66 \text{ dB mW/g}$

### #07\_LTE Band 13\_10M\_QPSK\_1\_0\_Bottom Face\_0mm\_Ch23230

Communication System: LTE; Frequency: 782 MHz; Duty Cycle: 1:1  
Medium: MSL\_750\_151231 Medium parameters used:  $f = 782 \text{ MHz}$ ;  $\sigma = 1.001 \text{ mho/m}$ ;  $\epsilon_r = 54.397$ ;  
 $\rho = 1000 \text{ kg/m}^3$   
Ambient Temperature : 23.5 °C; Liquid Temperature : 22.5 °C

#### DASY5 Configuration:

- Probe: EX3DV4 - SN3578; ConvF(9.29, 9.29, 9.29); Calibrated: 2015/3/31;
- Sensor-Surface: 1.4mm (Mechanical Surface Detection)
- Electronics: DAE4 Sn1399; Calibrated: 2015/11/23
- Phantom: ELI 4.0\_Left; Type: QDOVA001BB; Serial: 1026
- Measurement SW: DASY52, Version 52.8 (1); SEMCAD X Version 14.6.5 (6469)

**Configuration/Ch23230/Area Scan (51x61x1):** Measurement grid: dx=15mm, dy=15mm  
Maximum value of SAR (interpolated) = 1.47 mW/g

**Configuration/Ch23230/Zoom Scan (5x5x7)/Cube 0:** Measurement grid: dx=8mm, dy=8mm, dz=5mm

Reference Value = 23.549 V/m; Power Drift = -0.14 dB

Peak SAR (extrapolated) = 1.752 mW/g

**SAR(1 g) = 0.942 mW/g; SAR(10 g) = 0.557 mW/g**

Maximum value of SAR (measured) = 1.43 mW/g

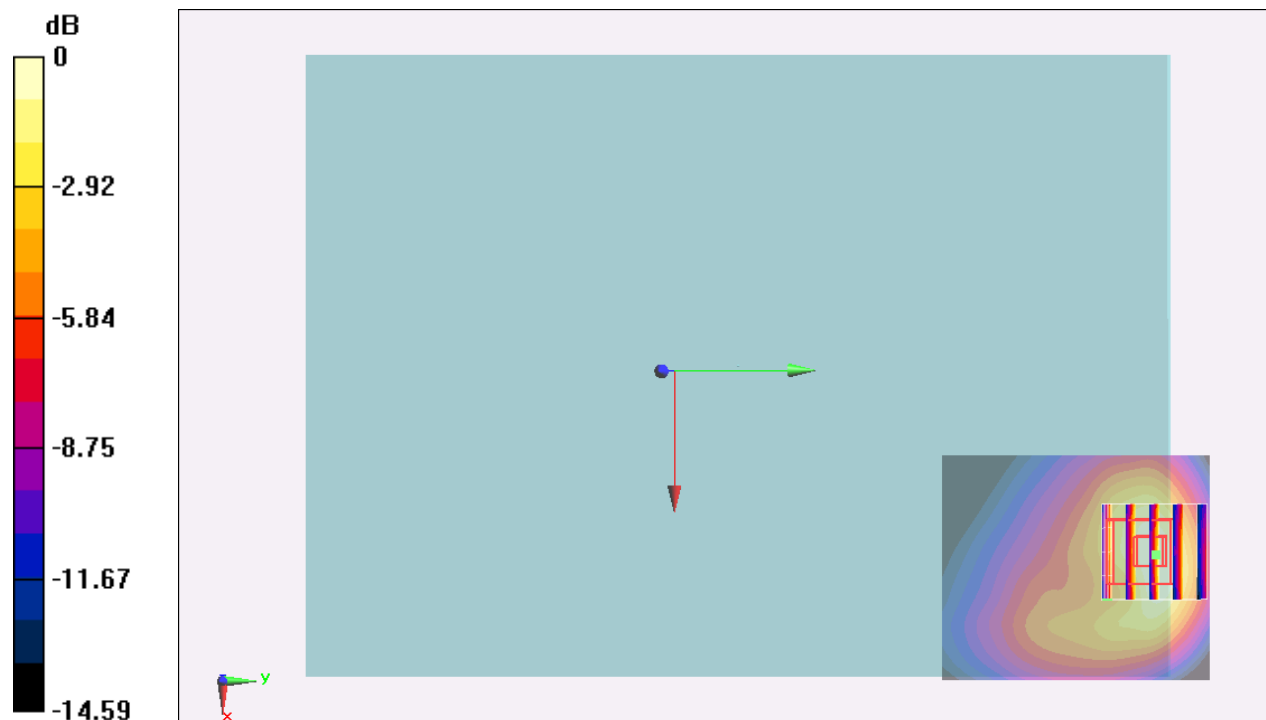

0 dB = 1.43 mW/g = 3.11 dB mW/g

### #08\_LTE Band 25\_20M\_QPSK\_1\_0\_Edge 2\_0mm\_Ch26140

Communication System: LTE; Frequency: 1860 MHz; Duty Cycle: 1:1  
Medium: MSL\_1900\_151225 Medium parameters used:  $f = 1860$  MHz;  $\sigma = 1.535$  mho/m;  $\epsilon_r = 54.861$ ;  $\rho = 1000$  kg/m<sup>3</sup>  
Ambient Temperature : 23.4 °C; Liquid Temperature : 22.4 °C

#### DASY5 Configuration:

- Probe: EX3DV4 - SN3697; ConvF(7.17, 7.17, 7.17); Calibrated: 2015/9/28;
- Sensor-Surface: 1.4mm (Mechanical Surface Detection)
- Electronics: DAE4 Sn1399; Calibrated: 2015/11/23
- Phantom: ELI 4.0\_Left; Type: QDOVA001BB; Serial: 1026
- Measurement SW: DASY52, Version 52.8 (1); SEMCAD X Version 14.6.5 (6469)

**Configuration/Ch26140/Area Scan (51x61x1):** Measurement grid: dx=15mm, dy=15mm  
Maximum value of SAR (interpolated) = 1.49 mW/g

**Configuration/Ch26140/Zoom Scan (5x5x7)/Cube 0:** Measurement grid: dx=8mm, dy=8mm, dz=5mm

Reference Value = 28.306 V/m; Power Drift = -0.04 dB

Peak SAR (extrapolated) = 1.715 mW/g

**SAR(1 g) = 0.896 mW/g; SAR(10 g) = 0.438 mW/g**

Maximum value of SAR (measured) = 1.38 mW/g

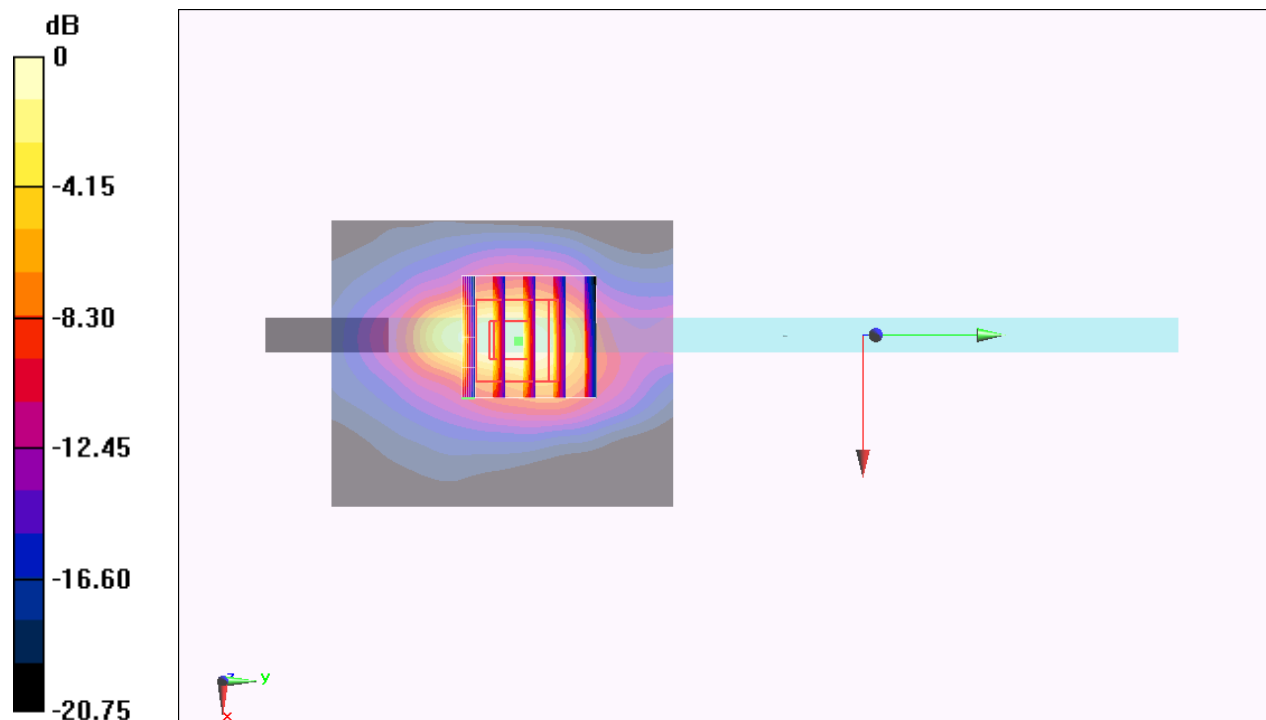

0 dB = 1.38 mW/g = 2.80 dB mW/g

### #09\_LTE Band 26\_15M\_QPSK\_1\_0\_Bottom Face\_0mm\_Ch26865

Communication System: LTE; Frequency: 831.5 MHz; Duty Cycle: 1:1  
Medium: MSL\_850\_151229 Medium parameters used:  $f = 831.5$  MHz;  $\sigma = 0.969$  mho/m;  $\epsilon_r = 55.149$ ;  $\rho = 1000$  kg/m<sup>3</sup>  
Ambient Temperature : 23.5 °C; Liquid Temperature : 22.5 °C

#### DASY5 Configuration:

- Probe: EX3DV4 - SN3697; ConvF(8.9, 8.9, 8.9); Calibrated: 2015/9/28;
- Sensor-Surface: 1.4mm (Mechanical Surface Detection)
- Electronics: DAE4 Sn1399; Calibrated: 2015/11/23
- Phantom: ELI 4.0\_Left; Type: QDOVA001BB; Serial: 1026
- Measurement SW: DASY52, Version 52.8 (1); SEMCAD X Version 14.6.5 (6469)

**Configuration/Ch26865/Area Scan (51x61x1):** Measurement grid: dx=15mm, dy=15mm  
Maximum value of SAR (interpolated) = 1.20 mW/g

**Configuration/Ch26865/Zoom Scan (5x5x7)/Cube 0:** Measurement grid: dx=8mm, dy=8mm, dz=5mm

Reference Value = 25.271 V/m; Power Drift = -0.14 dB

Peak SAR (extrapolated) = 1.473 mW/g

**SAR(1 g) = 0.803 mW/g; SAR(10 g) = 0.493 mW/g**

Maximum value of SAR (measured) = 1.17 mW/g

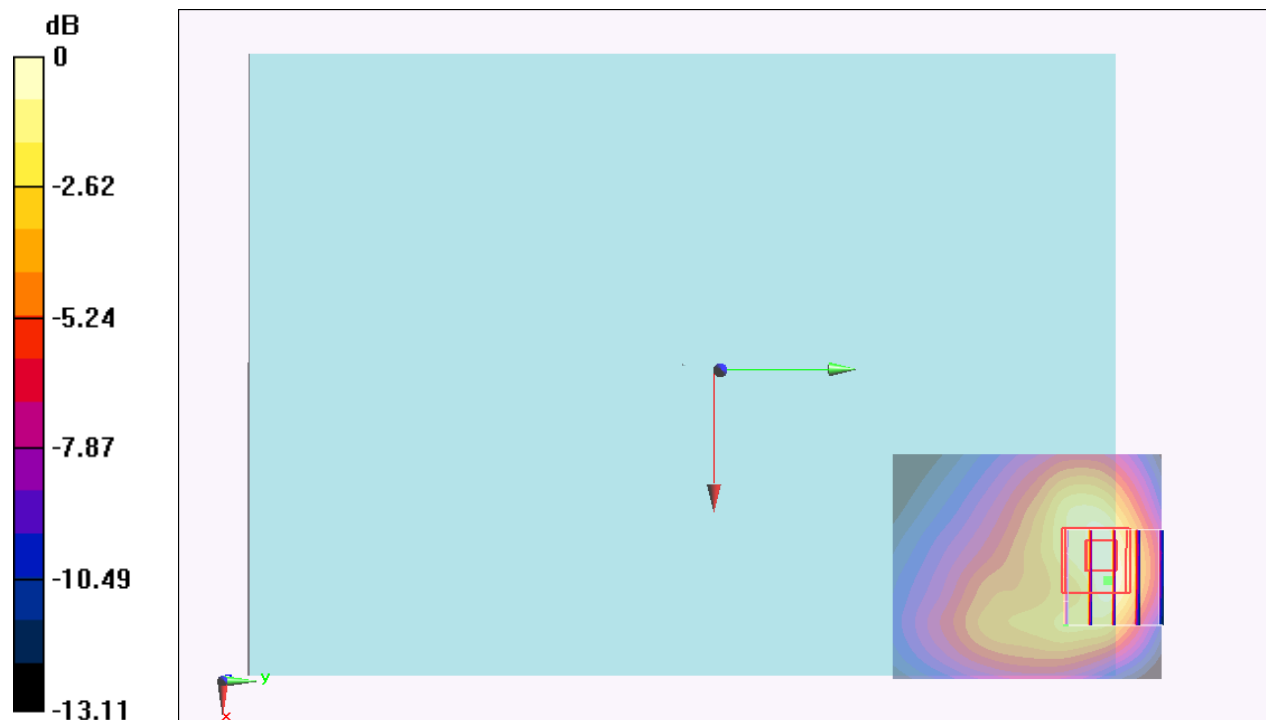

0 dB = 1.17 mW/g = 1.36 dB mW/g



### #10\_LTE Band 41\_20M\_QPSK\_1\_0\_Bottom Face\_0mm\_Ch41055

Communication System: LTE; Frequency: 2636.5 MHz; Duty Cycle: 1:1.59  
Medium: MSL\_2600\_151224 Medium parameters used:  $f = 2636.5$  MHz;  $\sigma = 2.275$  mho/m;  $\epsilon_r = 50.904$ ;  $\rho = 1000$  kg/m<sup>3</sup>  
Ambient Temperature : 23.4 °C; Liquid Temperature : 22.4 °C

#### DASY5 Configuration:

- Probe: ES3DV3 - SN3270; ConvF(4.27, 4.27, 4.27); Calibrated: 2015/9/28;
- Sensor-Surface: 2mm (Mechanical Surface Detection)
- Electronics: DAE4 Sn778; Calibrated: 2015/8/25
- Phantom: ELI 4.0\_Left; Type: QDOVA001BB; Serial: 1026
- Measurement SW: DASY52, Version 52.8 (1); SEMCAD X Version 14.6.5 (6469)

**Configuration/Ch41055/Area Scan (61x71x1):** Measurement grid: dx=12mm, dy=12mm  
Maximum value of SAR (interpolated) = 1.85 mW/g

**Configuration/Ch41055/Zoom Scan (7x7x7)/Cube 0:** Measurement grid: dx=5mm, dy=5mm, dz=5mm

Reference Value = 22.653 V/m; Power Drift = -0.05 dB

Peak SAR (extrapolated) = 2.906 mW/g

**SAR(1 g) = 1.06 mW/g; SAR(10 g) = 0.411 mW/g**

Maximum value of SAR (measured) = 1.91 mW/g

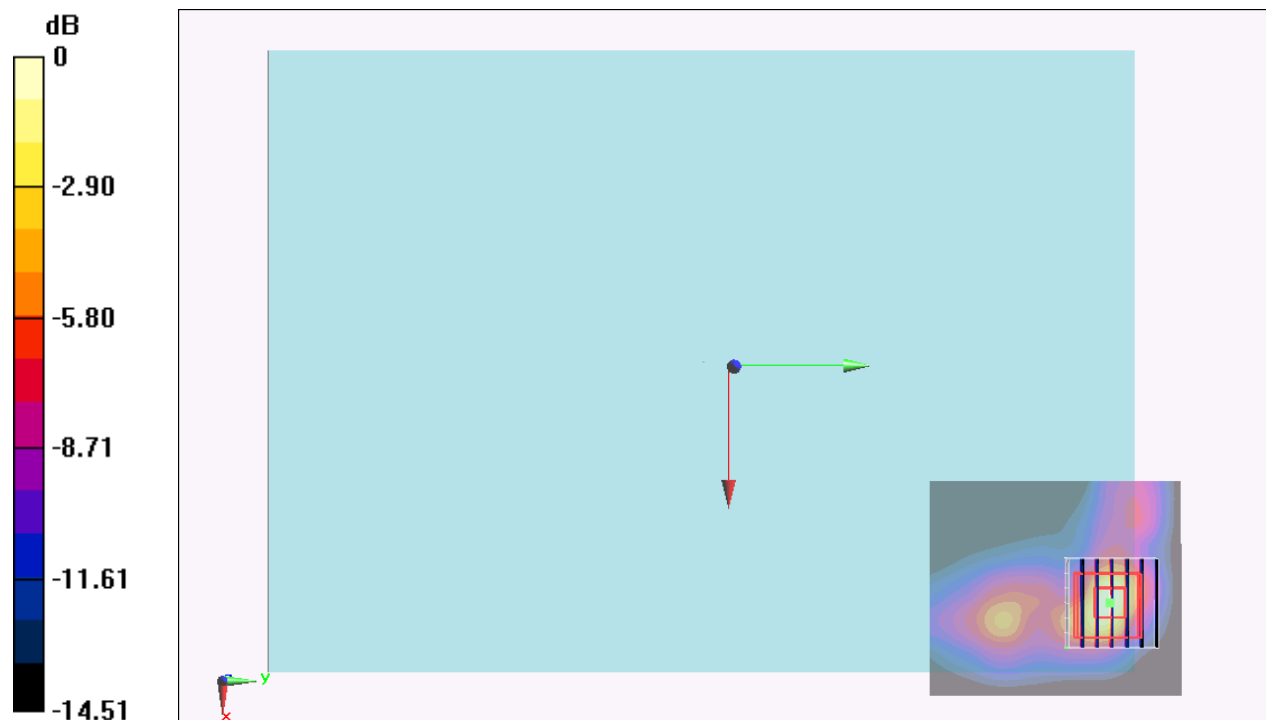

0 dB = 1.91 mW/g = 5.62 dB mW/g



---

**Appendix C. DASYS Calibration Certificate**

The DASYS calibration certificates are shown as follows.



Accredited by the Swiss Accreditation Service (SAS)  
The Swiss Accreditation Service is one of the signatories to the EA  
Multilateral Agreement for the recognition of calibration certificates

Accreditation No.: **SCS 0108**

Client **Sporton-TW (Auden)**

Certificate No: **D750V3-1012\_May15**

## CALIBRATION CERTIFICATE

Object **D750V3 - SN:1012**

Calibration procedure(s) **QA CAL-05.v9  
Calibration procedure for dipole validation kits above 700 MHz**

Calibration date: **May 28, 2015**

This calibration certificate documents the traceability to national standards, which realize the physical units of measurements (SI).  
The measurements and the uncertainties with confidence probability are given on the following pages and are part of the certificate.

All calibrations have been conducted in the closed laboratory facility: environment temperature ( $22 \pm 3$ )°C and humidity < 70%.

Calibration Equipment used (M&TE critical for calibration)

Primary Standards	ID #	Cal Date (Certificate No.)	Scheduled Calibration
Power meter EPM-442A	GB37480704	07-Oct-14 (No. 217-02020)	Oct-15
Power sensor HP 8481A	US37292783	07-Oct-14 (No. 217-02020)	Oct-15
Power sensor HP 8481A	MY41092317	07-Oct-14 (No. 217-02021)	Oct-15
Reference 20 dB Attenuator	SN: 5058 (20k)	01-Apr-15 (No. 217-02131)	Mar-16
Type-N mismatch combination	SN: 5047.2 / 06327	01-Apr-15 (No. 217-02134)	Mar-16
Reference Probe ES3DV3	SN: 3205	30-Dec-14 (No. ES3-3205_Dec14)	Dec-15
DAE4	SN: 601	18-Aug-14 (No. DAE4-601_Aug14)	Aug-15
Secondary Standards	ID #	Check Date (in house)	Scheduled Check
RF generator R&S SMT-06	100005	04-Aug-99 (in house check Oct-13)	In house check: Oct-16
Network Analyzer HP 8753E	US37390585 S4206	18-Oct-01 (in house check Oct-14)	In house check: Oct-15

	Name	Function	Signature
Calibrated by:	Jeton Kastrati	Laboratory Technician	
Approved by:	Katja Pokovic	Technical Manager	

Issued: May 28, 2015

This calibration certificate shall not be reproduced except in full without written approval of the laboratory.



Accredited by the Swiss Accreditation Service (SAS)

The Swiss Accreditation Service is one of the signatories to the EA Multilateral Agreement for the recognition of calibration certificates

Accreditation No.: **SCS 0108**

### Glossary:

TSL	tissue simulating liquid
ConvF	sensitivity in TSL / NORM x,y,z
N/A	not applicable or not measured

### Calibration is Performed According to the Following Standards:

- IEEE Std 1528-2013, "IEEE Recommended Practice for Determining the Peak Spatial-Averaged Specific Absorption Rate (SAR) in the Human Head from Wireless Communications Devices: Measurement Techniques", June 2013
- IEC 62209-1, "Procedure to measure the Specific Absorption Rate (SAR) for hand-held devices used in close proximity to the ear (frequency range of 300 MHz to 3 GHz)", February 2005
- KDB 865664, "SAR Measurement Requirements for 100 MHz to 6 GHz"

### Additional Documentation:

- DASY4/5 System Handbook

### Methods Applied and Interpretation of Parameters:

- Measurement Conditions:** Further details are available from the Validation Report at the end of the certificate. All figures stated in the certificate are valid at the frequency indicated.
- Antenna Parameters with TSL:** The dipole is mounted with the spacer to position its feed point exactly below the center marking of the flat phantom section, with the arms oriented parallel to the body axis.
- Feed Point Impedance and Return Loss:** These parameters are measured with the dipole positioned under the liquid filled phantom. The impedance stated is transformed from the measurement at the SMA connector to the feed point. The Return Loss ensures low reflected power. No uncertainty required.
- Electrical Delay:** One-way delay between the SMA connector and the antenna feed point. No uncertainty required.
- SAR measured:** SAR measured at the stated antenna input power.
- SAR normalized:** SAR as measured, normalized to an input power of 1 W at the antenna connector.
- SAR for nominal TSL parameters:** The measured TSL parameters are used to calculate the nominal SAR result.

The reported uncertainty of measurement is stated as the standard uncertainty of measurement multiplied by the coverage factor  $k=2$ , which for a normal distribution corresponds to a coverage probability of approximately 95%.

## Measurement Conditions

DASY system configuration, as far as not given on page 1.

<b>DASY Version</b>	DASY5	V52.8.8
<b>Extrapolation</b>	Advanced Extrapolation	
<b>Phantom</b>	Modular Flat Phantom	
<b>Distance Dipole Center - TSL</b>	15 mm	with Spacer
<b>Zoom Scan Resolution</b>	dx, dy, dz = 5 mm	
<b>Frequency</b>	750 MHz ± 1 MHz	

## Head TSL parameters

The following parameters and calculations were applied.

	Temperature	Permittivity	Conductivity
<b>Nominal Head TSL parameters</b>	22.0 °C	41.9	0.89 mho/m
<b>Measured Head TSL parameters</b>	(22.0 ± 0.2) °C	42.2 ± 6 %	0.90 mho/m ± 6 %
<b>Head TSL temperature change during test</b>	< 0.5 °C	----	----

## SAR result with Head TSL

<b>SAR averaged over 1 cm<sup>3</sup> (1 g) of Head TSL</b>	Condition	
SAR measured	250 mW input power	2.07 W/kg
SAR for nominal Head TSL parameters	normalized to 1W	<b>8.22 W/kg ± 17.0 % (k=2)</b>

<b>SAR averaged over 10 cm<sup>3</sup> (10 g) of Head TSL</b>	condition	
SAR measured	250 mW input power	1.36 W/kg
SAR for nominal Head TSL parameters	normalized to 1W	<b>5.41 W/kg ± 16.5 % (k=2)</b>

## Body TSL parameters

The following parameters and calculations were applied.

	Temperature	Permittivity	Conductivity
<b>Nominal Body TSL parameters</b>	22.0 °C	55.5	0.96 mho/m
<b>Measured Body TSL parameters</b>	(22.0 ± 0.2) °C	55.4 ± 6 %	0.97 mho/m ± 6 %
<b>Body TSL temperature change during test</b>	< 0.5 °C	----	----

## SAR result with Body TSL

<b>SAR averaged over 1 cm<sup>3</sup> (1 g) of Body TSL</b>	Condition	
SAR measured	250 mW input power	2.17 W/kg
SAR for nominal Body TSL parameters	normalized to 1W	<b>8.61 W/kg ± 17.0 % (k=2)</b>

<b>SAR averaged over 10 cm<sup>3</sup> (10 g) of Body TSL</b>	condition	
SAR measured	250 mW input power	1.44 W/kg
SAR for nominal Body TSL parameters	normalized to 1W	<b>5.72 W/kg ± 16.5 % (k=2)</b>

## Appendix (Additional assessments outside the scope of SCS 0108)

### Antenna Parameters with Head TSL

Impedance, transformed to feed point	53.4 $\Omega$ - 0.1 j $\Omega$
Return Loss	- 29.6 dB

### Antenna Parameters with Body TSL

Impedance, transformed to feed point	47.9 $\Omega$ - 2.6 j $\Omega$
Return Loss	- 29.3 dB

### General Antenna Parameters and Design

Electrical Delay (one direction)	1.035 ns
----------------------------------	----------

After long term use with 100W radiated power, only a slight warming of the dipole near the feedpoint can be measured.

The dipole is made of standard semirigid coaxial cable. The center conductor of the feeding line is directly connected to the second arm of the dipole. The antenna is therefore short-circuited for DC-signals. On some of the dipoles, small end caps are added to the dipole arms in order to improve matching when loaded according to the position as explained in the "Measurement Conditions" paragraph. The SAR data are not affected by this change. The overall dipole length is still according to the Standard.

No excessive force must be applied to the dipole arms, because they might bend or the soldered connections near the feedpoint may be damaged.

### Additional EUT Data

Manufactured by	SPEAG
Manufactured on	September 29, 2009

## DASY5 Validation Report for Head TSL

Date: 27.05.2015

Test Laboratory: SPEAG, Zurich, Switzerland

**DUT: Dipole 750 MHz; Type: D750V3; Serial: D750V3 - SN:1012**

Communication System: UID 0 - CW; Frequency: 750 MHz

Medium parameters used:  $f = 750$  MHz;  $\sigma = 0.9$  S/m;  $\epsilon_r = 42.2$ ;  $\rho = 1000$  kg/m<sup>3</sup>

Phantom section: Flat Section

Measurement Standard: DASY5 (IEEE/IEC/ANSI C63.19-2011)

DASY52 Configuration:

- Probe: ES3DV3 - SN3205; ConvF(6.44, 6.44, 6.44); Calibrated: 30.12.2014;
- Sensor-Surface: 3mm (Mechanical Surface Detection)
- Electronics: DAE4 Sn601; Calibrated: 18.08.2014
- Phantom: Flat Phantom 4.9L; Type: QD000P49AA; Serial: 1001
- DASY52 52.8.8(1222); SEMCAD X 14.6.10(7331)

### Dipole Calibration for Head Tissue/Pin=250 mW, d=15mm/Zoom Scan (7x7x7)/Cube 0:

Measurement grid: dx=5mm, dy=5mm, dz=5mm

Reference Value = 53.52 V/m; Power Drift = 0.01 dB

Peak SAR (extrapolated) = 3.08 W/kg

**SAR(1 g) = 2.07 W/kg; SAR(10 g) = 1.36 W/kg**

Maximum value of SAR (measured) = 2.42 W/kg

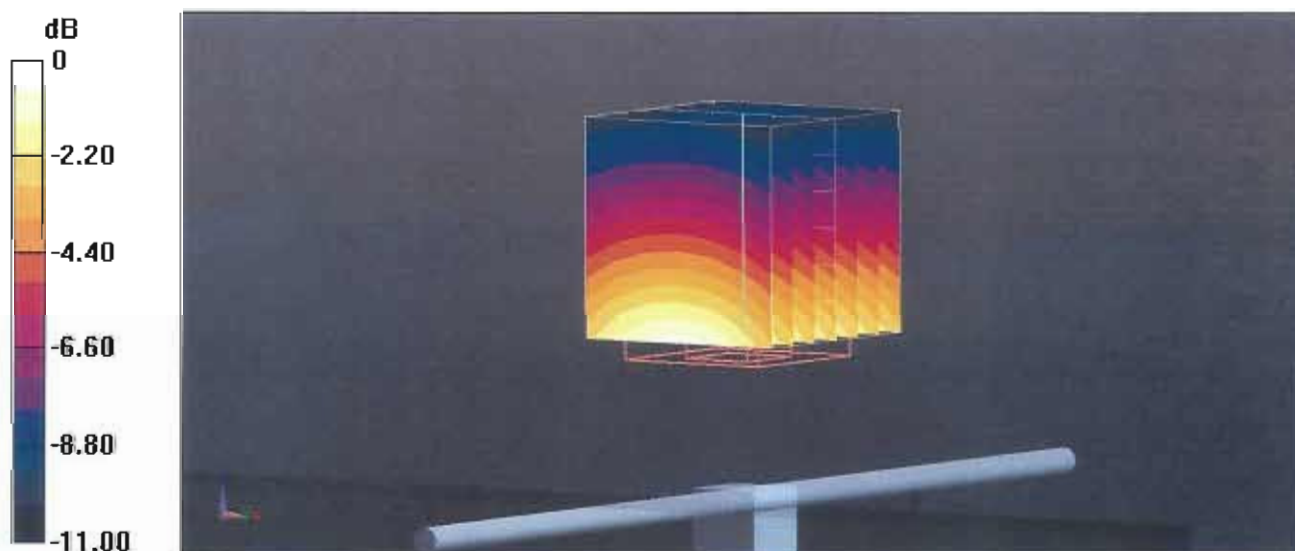

# Impedance Measurement Plot for Head TSL

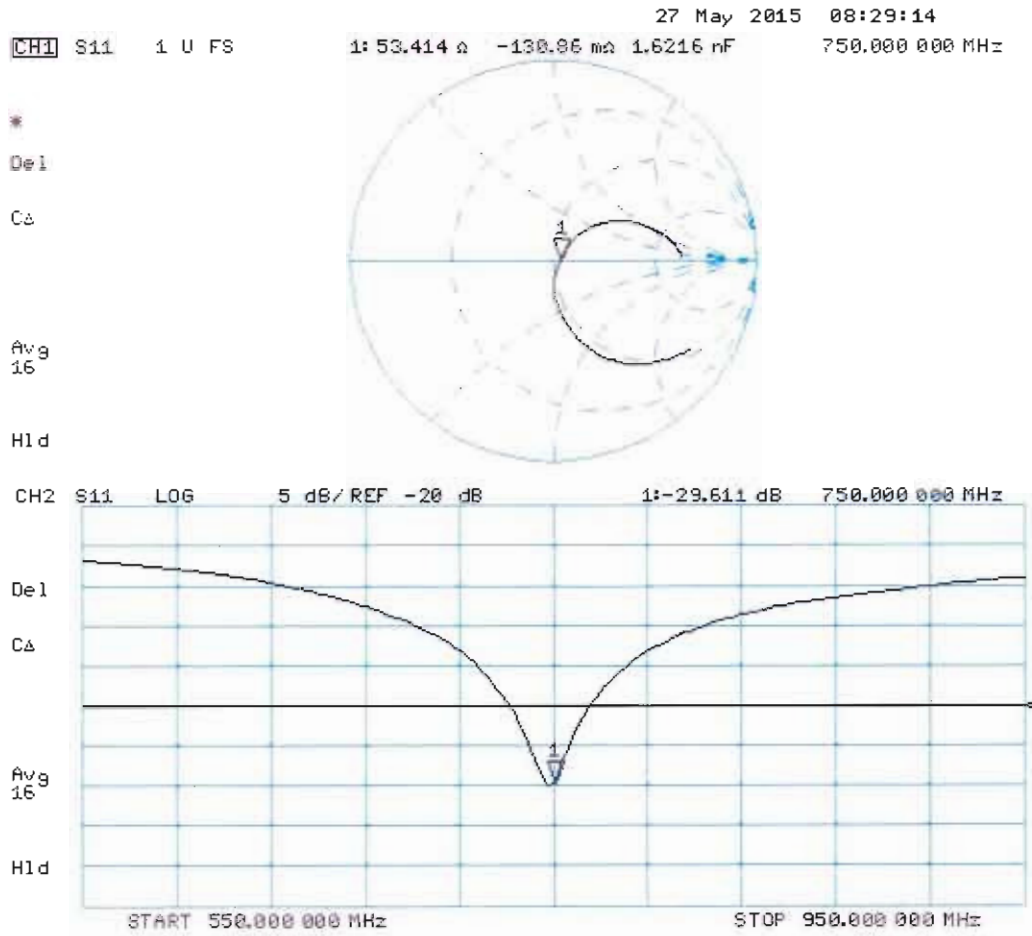



## DASY5 Validation Report for Body TSL

Date: 28.05.2015

Test Laboratory: SPEAG, Zurich, Switzerland

**DUT: Dipole 750 MHz; Type: D750V3; Serial: D750V3 - SN:1012**

Communication System: UID 0 - CW; Frequency: 750 MHz

Medium parameters used:  $f = 750$  MHz;  $\sigma = 0.97$  S/m;  $\epsilon_r = 55.4$ ;  $\rho = 1000$  kg/m<sup>3</sup>

Phantom section: Flat Section

Measurement Standard: DASY5 (IEEE/IEC/ANSI C63.19-2011)

DASY52 Configuration:

- Probe: ES3DV3 - SN3205; ConvF(6.21, 6.21, 6.21); Calibrated: 30.12.2014;
- Sensor-Surface: 3mm (Mechanical Surface Detection)
- Electronics: DAE4 Sn601; Calibrated: 18.08.2014
- Phantom: Flat Phantom 4.9L; Type: QD000P49AA; Serial: 1001
- DASY52 52.8.8(1222); SEMCAD X 14.6.10(7331)

### Dipole Calibration for Body Tissue/Pin=250 mW, d=15mm/Zoom Scan (7x7x7)/Cube 0:

Measurement grid: dx=5mm, dy=5mm, dz=5mm

Reference Value = 52.92 V/m; Power Drift = -0.01 dB

Peak SAR (extrapolated) = 3.16 W/kg

**SAR(1 g) = 2.17 W/kg; SAR(10 g) = 1.44 W/kg**

Maximum value of SAR (measured) = 2.53 W/kg

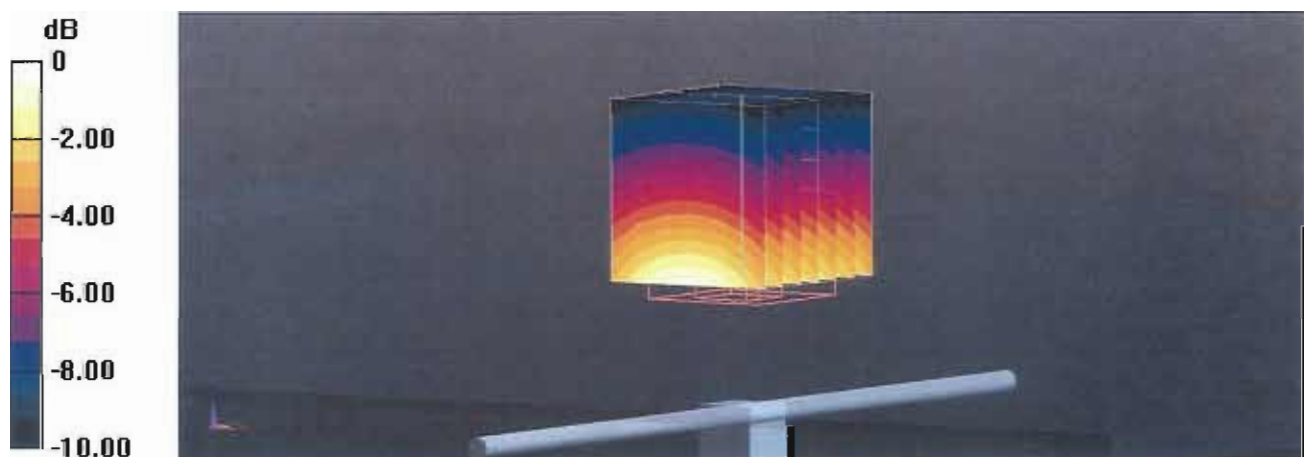

# Impedance Measurement Plot for Body TSL

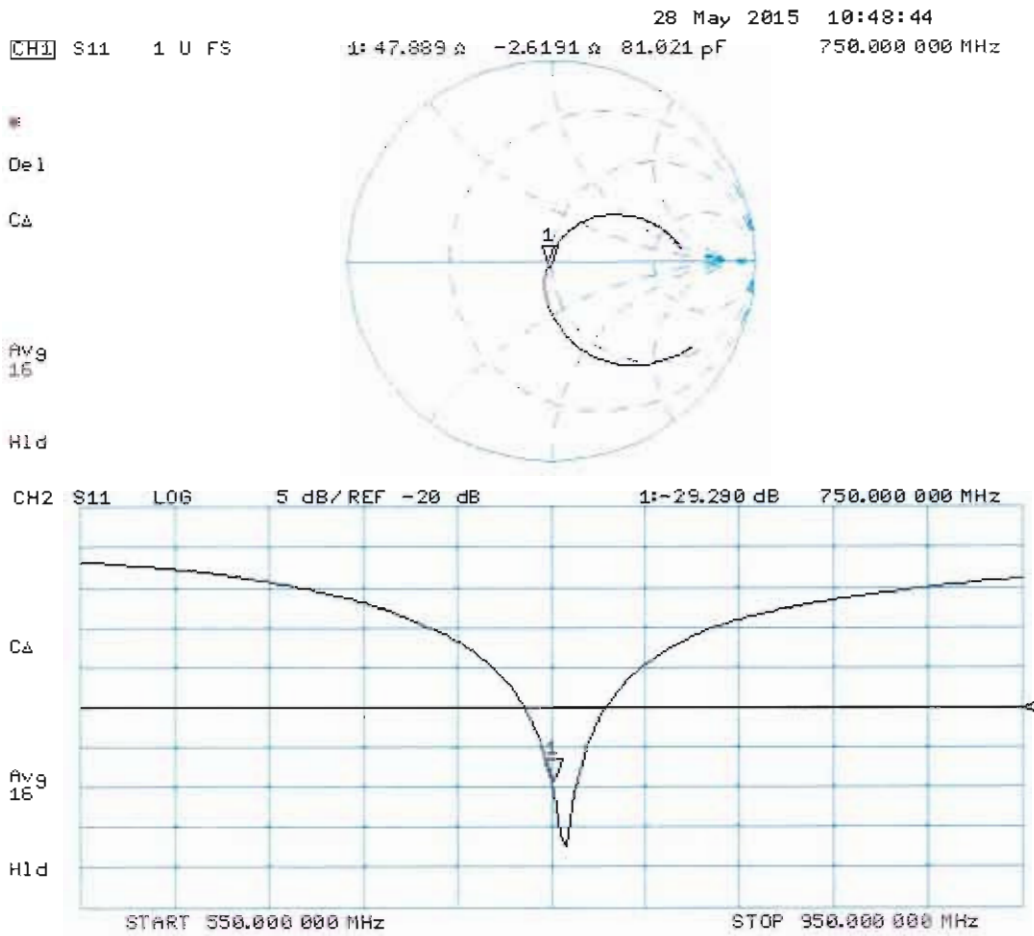



Accredited by the Swiss Accreditation Service (SAS)  
The Swiss Accreditation Service is one of the signatories to the EA  
Multilateral Agreement for the recognition of calibration certificates

Accreditation No.: **SCS 0108**

Client **Sporton-TW (Auden)**

Certificate No: **D835V2-499\_Mar15**

## CALIBRATION CERTIFICATE

Object **D835V2 - SN:499**

Calibration procedure(s) **QA CAL-05.v9**  
**Calibration procedure for dipole validation kits above 700 MHz**

Calibration date: **March 20, 2015**

This calibration certificate documents the traceability to national standards, which realize the physical units of measurements (SI).  
The measurements and the uncertainties with confidence probability are given on the following pages and are part of the certificate.

All calibrations have been conducted in the closed laboratory facility: environment temperature ( $22 \pm 3$ )°C and humidity < 70%.

Calibration Equipment used (M&TE critical for calibration)

Primary Standards	ID #	Cal Date (Certificate No.)	Scheduled Calibration
Power meter EPM-442A	GB37480704	07-Oct-14 (No. 217-02020)	Oct-15
Power sensor HP 8481A	US37292783	07-Oct-14 (No. 217-02020)	Oct-15
Power sensor HP 8481A	MY41092317	07-Oct-14 (No. 217-02021)	Oct-15
Reference 20 dB Attenuator	SN: 5058 (20k)	03-Apr-14 (No. 217-01918)	Apr-15
Type-N mismatch combination	SN: 5047.2 / 06327	03-Apr-14 (No. 217-01921)	Apr-15
Reference Probe ES3DV3	SN: 3205	30-Dec-14 (No. ES3-3205_Dec14)	Dec-15
DAE4	SN: 601	18-Aug-14 (No. DAE4-601_Aug14)	Aug-15
Secondary Standards	ID #	Check Date (in house)	Scheduled Check
RF generator R&S SMT-06	100005	04-Aug-99 (in house check Oct-13)	In house check: Oct-16
Network Analyzer HP 8753E	US37390585 S4206	18-Oct-01 (in house check Oct-14)	In house check: Oct-15

Calibrated by:	Name Israe Elnaouq	Function Laboratory Technician	Signature 
Approved by:	Katja Pokovic	Technical Manager	

Issued: March 20, 2015

This calibration certificate shall not be reproduced except in full without written approval of the laboratory.



Accredited by the Swiss Accreditation Service (SAS)

The Swiss Accreditation Service is one of the signatories to the EA  
Multilateral Agreement for the recognition of calibration certificates

Accreditation No.: **SCS 0108**

### Glossary:

TSL	tissue simulating liquid
ConvF	sensitivity in TSL / NORM x,y,z
N/A	not applicable or not measured

### Calibration is Performed According to the Following Standards:

- IEEE Std 1528-2013, "IEEE Recommended Practice for Determining the Peak Spatial-Averaged Specific Absorption Rate (SAR) in the Human Head from Wireless Communications Devices: Measurement Techniques", June 2013
- IEC 62209-1, "Procedure to measure the Specific Absorption Rate (SAR) for hand-held devices used in close proximity to the ear (frequency range of 300 MHz to 3 GHz)", February 2005
- KDB 865664, "SAR Measurement Requirements for 100 MHz to 6 GHz"

### Additional Documentation:

- DASY4/5 System Handbook

### Methods Applied and Interpretation of Parameters:

- Measurement Conditions:** Further details are available from the Validation Report at the end of the certificate. All figures stated in the certificate are valid at the frequency indicated.
- Antenna Parameters with TSL:** The dipole is mounted with the spacer to position its feed point exactly below the center marking of the flat phantom section, with the arms oriented parallel to the body axis.
- Feed Point Impedance and Return Loss:** These parameters are measured with the dipole positioned under the liquid filled phantom. The impedance stated is transformed from the measurement at the SMA connector to the feed point. The Return Loss ensures low reflected power. No uncertainty required.
- Electrical Delay:** One-way delay between the SMA connector and the antenna feed point. No uncertainty required.
- SAR measured:** SAR measured at the stated antenna input power.
- SAR normalized:** SAR as measured, normalized to an input power of 1 W at the antenna connector.
- SAR for nominal TSL parameters:** The measured TSL parameters are used to calculate the nominal SAR result.

The reported uncertainty of measurement is stated as the standard uncertainty of measurement multiplied by the coverage factor  $k=2$ , which for a normal distribution corresponds to a coverage probability of approximately 95%.

## Measurement Conditions

DASY system configuration, as far as not given on page 1.

<b>DASY Version</b>	DASY5	V52.8.8
<b>Extrapolation</b>	Advanced Extrapolation	
<b>Phantom</b>	Modular Flat Phantom	
<b>Distance Dipole Center - TSL</b>	15 mm	with Spacer
<b>Zoom Scan Resolution</b>	dx, dy, dz = 5 mm	
<b>Frequency</b>	835 MHz $\pm$ 1 MHz	

## Head TSL parameters

The following parameters and calculations were applied.

	Temperature	Permittivity	Conductivity
<b>Nominal Head TSL parameters</b>	22.0 °C	41.5	0.90 mho/m
<b>Measured Head TSL parameters</b>	(22.0 $\pm$ 0.2) °C	40.6 $\pm$ 6 %	0.92 mho/m $\pm$ 6 %
<b>Head TSL temperature change during test</b>	< 0.5 °C	----	----

## SAR result with Head TSL

<b>SAR averaged over 1 cm<sup>3</sup> (1 g) of Head TSL</b>	Condition	
SAR measured	250 mW input power	2.35 W/kg
SAR for nominal Head TSL parameters	normalized to 1W	<b>9.20 W/kg <math>\pm</math> 17.0 % (k=2)</b>

<b>SAR averaged over 10 cm<sup>3</sup> (10 g) of Head TSL</b>	condition	
SAR measured	250 mW input power	1.53 W/kg
SAR for nominal Head TSL parameters	normalized to 1W	<b>6.02 W/kg <math>\pm</math> 16.5 % (k=2)</b>

## Body TSL parameters

The following parameters and calculations were applied.

	Temperature	Permittivity	Conductivity
<b>Nominal Body TSL parameters</b>	22.0 °C	55.2	0.97 mho/m
<b>Measured Body TSL parameters</b>	(22.0 $\pm$ 0.2) °C	54.6 $\pm$ 6 %	1.02 mho/m $\pm$ 6 %
<b>Body TSL temperature change during test</b>	< 0.5 °C	----	----

## SAR result with Body TSL

<b>SAR averaged over 1 cm<sup>3</sup> (1 g) of Body TSL</b>	Condition	
SAR measured	250 mW input power	2.42 W/kg
SAR for nominal Body TSL parameters	normalized to 1W	<b>9.30 W/kg <math>\pm</math> 17.0 % (k=2)</b>

<b>SAR averaged over 10 cm<sup>3</sup> (10 g) of Body TSL</b>	condition	
SAR measured	250 mW input power	1.58 W/kg
SAR for nominal Body TSL parameters	normalized to 1W	<b>6.12 W/kg <math>\pm</math> 16.5 % (k=2)</b>

## Appendix (Additional assessments outside the scope of SCS 0108)

### Antenna Parameters with Head TSL

Impedance, transformed to feed point	51.3 $\Omega$ - 3.2 j $\Omega$
Return Loss	- 29.4 dB

### Antenna Parameters with Body TSL

Impedance, transformed to feed point	47.6 $\Omega$ - 5.2 j $\Omega$
Return Loss	- 24.7 dB

### General Antenna Parameters and Design

Electrical Delay (one direction)	1.390 ns
----------------------------------	----------

After long term use with 100W radiated power, only a slight warming of the dipole near the feedpoint can be measured.

The dipole is made of standard semirigid coaxial cable. The center conductor of the feeding line is directly connected to the second arm of the dipole. The antenna is therefore short-circuited for DC-signals. On some of the dipoles, small end caps are added to the dipole arms in order to improve matching when loaded according to the position as explained in the "Measurement Conditions" paragraph. The SAR data are not affected by this change. The overall dipole length is still according to the Standard.

No excessive force must be applied to the dipole arms, because they might bend or the soldered connections near the feedpoint may be damaged.

### Additional EUT Data

Manufactured by	SPEAG
Manufactured on	July 10, 2003

## DASY5 Validation Report for Head TSL

Date: 19.03.2015

Test Laboratory: SPEAG, Zurich, Switzerland

**DUT: Dipole 835 MHz; Type: D835V2; Serial: D835V2 - SN:499**

Communication System: UID 0 - CW; Frequency: 835 MHz

Medium parameters used:  $f = 835$  MHz;  $\sigma = 0.92$  S/m;  $\epsilon_r = 40.6$ ;  $\rho = 1000$  kg/m<sup>3</sup>

Phantom section: Flat Section

Measurement Standard: DASY5 (IEEE/IEC/ANSI C63.19-2011)

DASY52 Configuration:

- Probe: ES3DV3 - SN3205; ConvF(6.2, 6.2, 6.2); Calibrated: 30.12.2014;
- Sensor-Surface: 3mm (Mechanical Surface Detection)
- Electronics: DAE4 Sn601; Calibrated: 18.08.2014
- Phantom: Flat Phantom 4.9L; Type: QD000P49AA; Serial: 1001
- DASY52 52.8.8(1222); SEMCAD X 14.6.10(7331)

### Dipole Calibration for Head Tissue/Pin=250 mW, d=15mm/Zoom Scan (7x7x7)/Cube 0:

Measurement grid: dx=5mm, dy=5mm, dz=5mm

Reference Value = 56.43 V/m; Power Drift = 0.01 dB

Peak SAR (extrapolated) = 3.52 W/kg

**SAR(1 g) = 2.35 W/kg; SAR(10 g) = 1.53 W/kg**

Maximum value of SAR (measured) = 2.75 W/kg

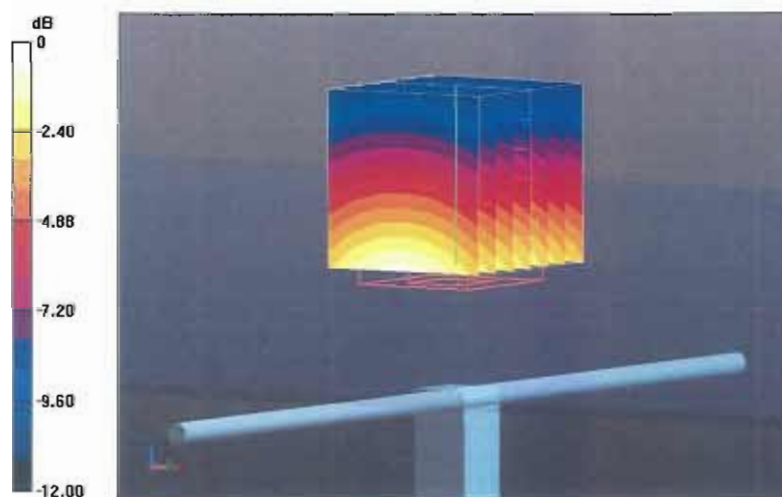

# Impedance Measurement Plot for Head TSL

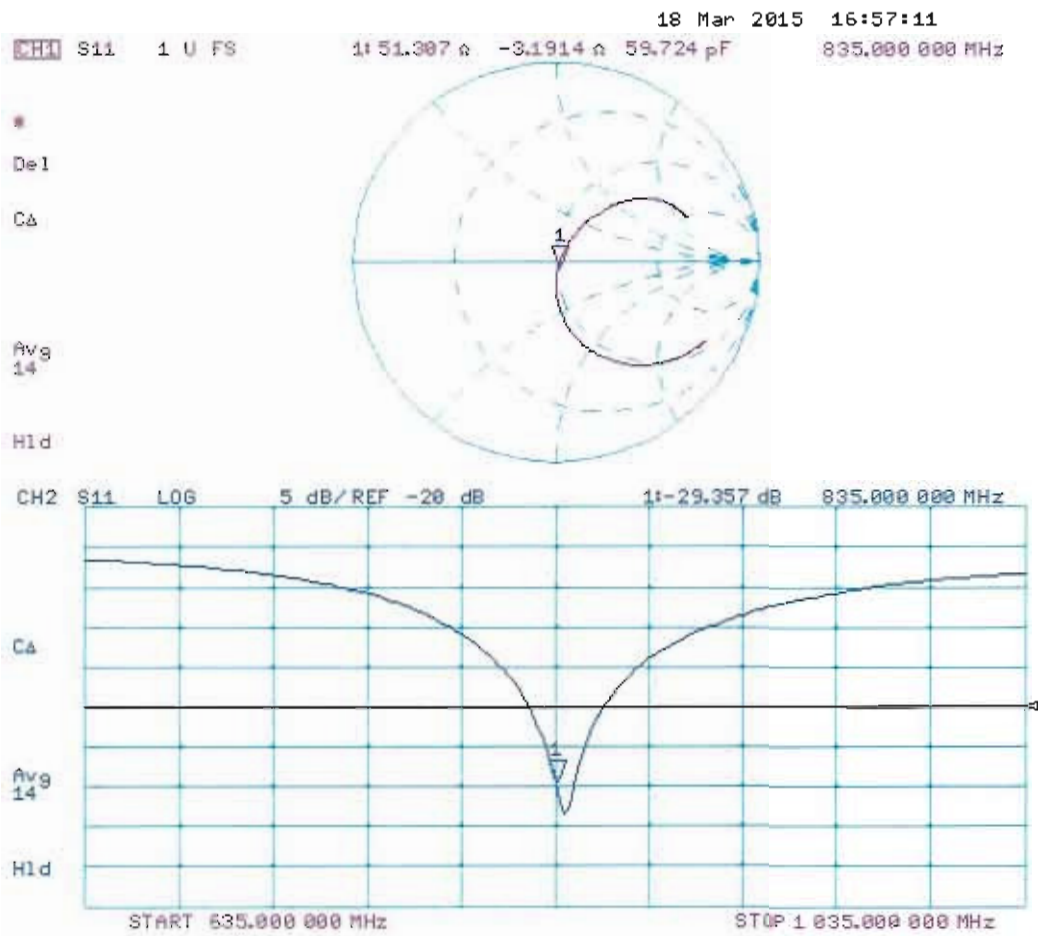



## DASY5 Validation Report for Body TSL

Date: 20.03.2015

Test Laboratory: SPEAG, Zurich, Switzerland

**DUT: Dipole 835 MHz; Type: D835V2; Serial: D835V2 - SN:499**

Communication System: UID 0 - CW; Frequency: 835 MHz

Medium parameters used:  $f = 835$  MHz;  $\sigma = 1.02$  S/m;  $\epsilon_r = 54.6$ ;  $\rho = 1000$  kg/m<sup>3</sup>

Phantom section: Flat Section

Measurement Standard: DASY5 (IEEE/IEC/ANSI C63.19-2011)

DASY52 Configuration:

- Probe: ES3DV3 - SN3205; ConvF(6.17, 6.17, 6.17); Calibrated: 30.12.2014;
- Sensor-Surface: 3mm (Mechanical Surface Detection)
- Electronics: DAE4 Sn601; Calibrated: 18.08.2014
- Phantom: Flat Phantom 4.9L; Type: QD000P49AA; Serial: 1001
- DASY52 52.8.8(1222); SEMCAD X 14.6.10(7331)

### Dipole Calibration for Body Tissue/Pin=250 mW, d=15mm/Zoom Scan (7x7x7)/Cube 0:

Measurement grid: dx=5mm, dy=5mm, dz=5mm

Reference Value = 54.57 V/m; Power Drift = -0.02 dB

Peak SAR (extrapolated) = 3.57 W/kg

**SAR(1 g) = 2.42 W/kg; SAR(10 g) = 1.58 W/kg**

Maximum value of SAR (measured) = 2.82 W/kg

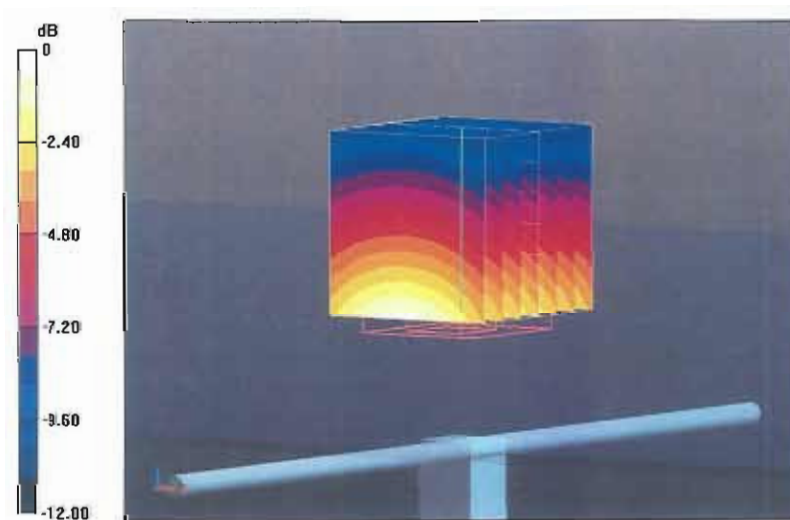

0 dB = 2.82 W/kg = 4.50 dBW/kg

# Impedance Measurement Plot for Body TSL

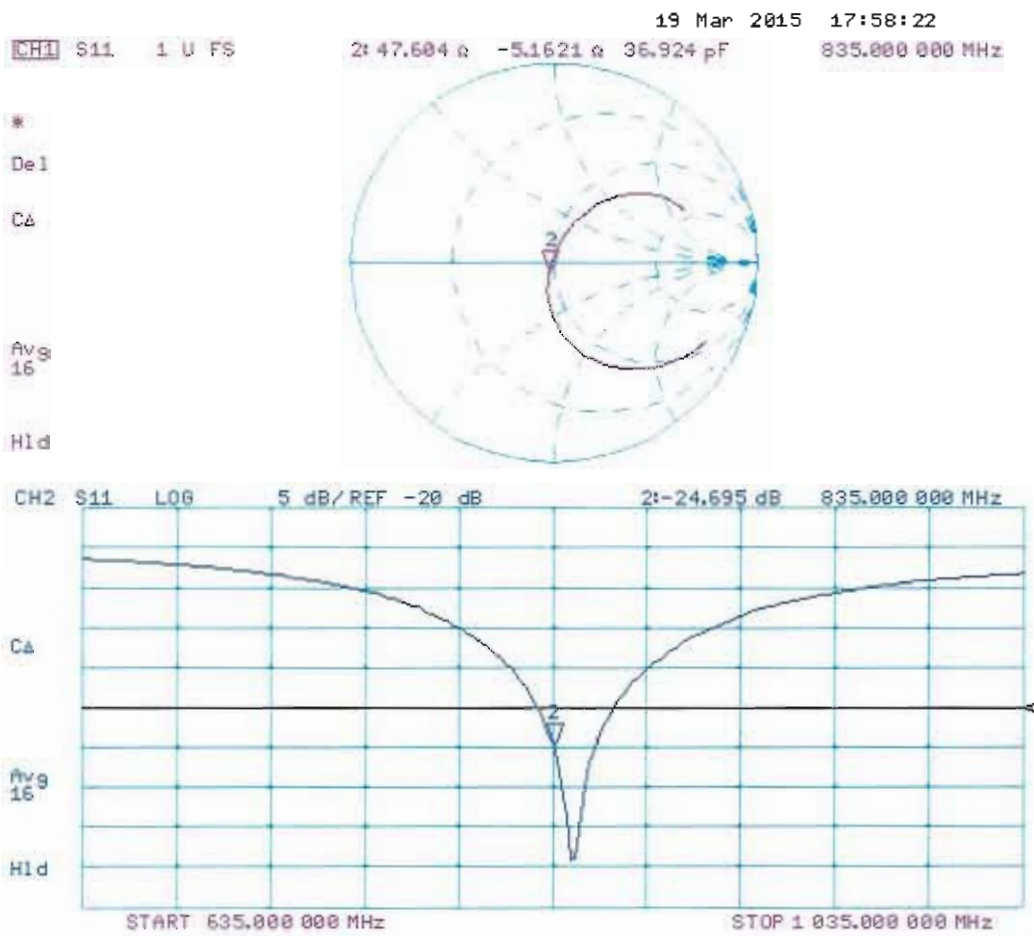



Accredited by the Swiss Accreditation Service (SAS)  
The Swiss Accreditation Service is one of the signatories to the EA  
Multilateral Agreement for the recognition of calibration certificates

Accreditation No.: **SCS 0108**

Client **Sporton-TW (Auden)**

Certificate No: **D1750V2-1068\_Nov15**

## CALIBRATION CERTIFICATE

Object **D1750V2 - SN: 1068**

Calibration procedure(s) **QA CAL-05.v9  
Calibration procedure for dipole validation kits above 700 MHz**

Calibration date: **November 23, 2015**

This calibration certificate documents the traceability to national standards, which realize the physical units of measurements (SI).  
The measurements and the uncertainties with confidence probability are given on the following pages and are part of the certificate.

All calibrations have been conducted in the closed laboratory facility: environment temperature (22 ± 3)°C and humidity < 70%.

Calibration Equipment used (M&TE critical for calibration)

Primary Standards	ID #	Cal Date (Certificate No.)	Scheduled Calibration
Power meter EPM-442A	GB37480704	07-Oct-15 (No. 217-02222)	Oct-16
Power sensor HP 8481A	US37292783	07-Oct-15 (No. 217-02222)	Oct-16
Power sensor HP 8481A	MY41092317	07-Oct-15 (No. 217-02223)	Oct-16
Reference 20 dB Attenuator	SN: 5058 (20k)	01-Apr-15 (No. 217-02131)	Mar-16
Type-N mismatch combination	SN: 5047.2 / 06327	01-Apr-15 (No. 217-02134)	Mar-16
Reference Probe EX3DV4	SN: 7349	30-Dec-14 (No. EX3-7349_Dec14)	Dec-15
DAE4	SN: 601	17-Aug-15 (No. DAE4-601_Aug15)	Aug-16
Secondary Standards	ID #	Check Date (in house)	Scheduled Check
RF generator R&S SMT-06	100972	15-Jun-15 (in house check Jun-15)	In house check: Jun-18
Network Analyzer HP 8753E	US37390585 S4206	18-Oct-01 (in house check Oct-15)	In house check: Oct-16

Calibrated by: **Name** Michael Weber **Function** Laboratory Technician

**Signature**  
*M. Weber*

Approved by: **Name** Katja Pokovic **Function** Technical Manager

*[Signature]*

Issued: November 24, 2015

This calibration certificate shall not be reproduced except in full without written approval of the laboratory.



Accredited by the Swiss Accreditation Service (SAS)  
The Swiss Accreditation Service is one of the signatories to the EA  
Multilateral Agreement for the recognition of calibration certificates

Accreditation No.: **SCS 0108**

### Glossary:

TSL	tissue simulating liquid
ConvF	sensitivity in TSL / NORM x,y,z
N/A	not applicable or not measured

### Calibration is Performed According to the Following Standards:

- IEEE Std 1528-2013, "IEEE Recommended Practice for Determining the Peak Spatial-Averaged Specific Absorption Rate (SAR) in the Human Head from Wireless Communications Devices: Measurement Techniques", June 2013
- IEC 62209-1, "Procedure to measure the Specific Absorption Rate (SAR) for hand-held devices used in close proximity to the ear (frequency range of 300 MHz to 3 GHz)", February 2005
- IEC 62209-2, "Procedure to determine the Specific Absorption Rate (SAR) for wireless communication devices used in close proximity to the human body (frequency range of 30 MHz to 6 GHz)", March 2010
- KDB 865664, "SAR Measurement Requirements for 100 MHz to 6 GHz"

### Additional Documentation:

- DASY4/5 System Handbook

### Methods Applied and Interpretation of Parameters:

- Measurement Conditions:** Further details are available from the Validation Report at the end of the certificate. All figures stated in the certificate are valid at the frequency indicated.
- Antenna Parameters with TSL:** The dipole is mounted with the spacer to position its feed point exactly below the center marking of the flat phantom section, with the arms oriented parallel to the body axis.
- Feed Point Impedance and Return Loss:** These parameters are measured with the dipole positioned under the liquid filled phantom. The impedance stated is transformed from the measurement at the SMA connector to the feed point. The Return Loss ensures low reflected power. No uncertainty required.
- Electrical Delay:** One-way delay between the SMA connector and the antenna feed point. No uncertainty required.
- SAR measured:** SAR measured at the stated antenna input power.
- SAR normalized:** SAR as measured, normalized to an input power of 1 W at the antenna connector.
- SAR for nominal TSL parameters:** The measured TSL parameters are used to calculate the nominal SAR result.

The reported uncertainty of measurement is stated as the standard uncertainty of measurement multiplied by the coverage factor  $k=2$ , which for a normal distribution corresponds to a coverage probability of approximately 95%.

## Measurement Conditions

DASY system configuration, as far as not given on page 1.

<b>DASY Version</b>	DASY5	V52.8.8
<b>Extrapolation</b>	Advanced Extrapolation	
<b>Phantom</b>	Modular Flat Phantom	
<b>Distance Dipole Center - TSL</b>	10 mm	with Spacer
<b>Zoom Scan Resolution</b>	dx, dy, dz = 5 mm	
<b>Frequency</b>	1750 MHz $\pm$ 1 MHz	

## Head TSL parameters

The following parameters and calculations were applied.

	Temperature	Permittivity	Conductivity
<b>Nominal Head TSL parameters</b>	22.0 °C	40.1	1.37 mho/m
<b>Measured Head TSL parameters</b>	(22.0 $\pm$ 0.2) °C	40.8 $\pm$ 6 %	1.35 mho/m $\pm$ 6 %
<b>Head TSL temperature change during test</b>	< 0.5 °C	----	----

## SAR result with Head TSL

<b>SAR averaged over 1 cm<sup>3</sup> (1 g) of Head TSL</b>	Condition	
SAR measured	250 mW input power	9.07 W/kg
SAR for nominal Head TSL parameters	normalized to 1W	<b>36.8 W/kg <math>\pm</math> 17.0 % (k=2)</b>

<b>SAR averaged over 10 cm<sup>3</sup> (10 g) of Head TSL</b>	condition	
SAR measured	250 mW input power	4.79 W/kg
SAR for nominal Head TSL parameters	normalized to 1W	<b>19.3 W/kg <math>\pm</math> 16.5 % (k=2)</b>

## Body TSL parameters

The following parameters and calculations were applied.

	Temperature	Permittivity	Conductivity
<b>Nominal Body TSL parameters</b>	22.0 °C	53.4	1.49 mho/m
<b>Measured Body TSL parameters</b>	(22.0 $\pm$ 0.2) °C	54.2 $\pm$ 6 %	1.48 mho/m $\pm$ 6 %
<b>Body TSL temperature change during test</b>	< 0.5 °C	----	----

## SAR result with Body TSL

<b>SAR averaged over 1 cm<sup>3</sup> (1 g) of Body TSL</b>	Condition	
SAR measured	250 mW input power	8.85 W/kg
SAR for nominal Body TSL parameters	normalized to 1W	<b>35.7 W/kg <math>\pm</math> 17.0 % (k=2)</b>

<b>SAR averaged over 10 cm<sup>3</sup> (10 g) of Body TSL</b>	condition	
SAR measured	250 mW input power	4.72 W/kg
SAR for nominal Body TSL parameters	normalized to 1W	<b>19.0 W/kg <math>\pm</math> 16.5 % (k=2)</b>

## Appendix (Additional assessments outside the scope of SCS 0108)

### Antenna Parameters with Head TSL

Impedance, transformed to feed point	48.8 $\Omega$ - 1.4 j $\Omega$
Return Loss	- 34.4 dB

### Antenna Parameters with Body TSL

Impedance, transformed to feed point	46.4 $\Omega$ - 1.2 j $\Omega$
Return Loss	- 28.1 dB

### General Antenna Parameters and Design

Electrical Delay (one direction)	1.221 ns
----------------------------------	----------

After long term use with 100W radiated power, only a slight warming of the dipole near the feedpoint can be measured.

The dipole is made of standard semirigid coaxial cable. The center conductor of the feeding line is directly connected to the second arm of the dipole. The antenna is therefore short-circuited for DC-signals. On some of the dipoles, small end caps are added to the dipole arms in order to improve matching when loaded according to the position as explained in the "Measurement Conditions" paragraph. The SAR data are not affected by this change. The overall dipole length is still according to the Standard.

No excessive force must be applied to the dipole arms, because they might bend or the soldered connections near the feedpoint may be damaged.

### Additional EUT Data

Manufactured by	SPEAG
Manufactured on	June 15, 2010

## DASY5 Validation Report for Head TSL

Date: 23.11.2015

Test Laboratory: SPEAG, Zurich, Switzerland

**DUT: Dipole 1750 MHz; Type: D1750V2; Serial: D1750V2 - SN: 1068**

Communication System: UID 0 - CW; Frequency: 1750 MHz

Medium parameters used:  $f = 1750$  MHz;  $\sigma = 1.35$  S/m;  $\epsilon_r = 40.8$ ;  $\rho = 1000$  kg/m<sup>3</sup>

Phantom section: Flat Section

Measurement Standard: DASY5 (IEEE/IEC/ANSI C63.19-2011)

DASY52 Configuration:

- Probe: EX3DV4 - SN7349; ConvF(8.38, 8.38, 8.38); Calibrated: 30.12.2014;
- Sensor-Surface: 1.4mm (Mechanical Surface Detection)
- Electronics: DAE4 Sn601; Calibrated: 17.08.2015
- Phantom: Flat Phantom 5.0 (front); Type: QD000P50AA; Serial: 1001
- DASY52 52.8.8(1222); SEMCAD X 14.6.10(7331)

### Dipole Calibration for Head Tissue/Pin=250 mW, d=10mm/Zoom Scan (7x7x7)/Cube 0:

Measurement grid: dx=5mm, dy=5mm, dz=5mm

Reference Value = 104.3 V/m; Power Drift = 0.03 dB

Peak SAR (extrapolated) = 16.9 W/kg

**SAR(1 g) = 9.07 W/kg; SAR(10 g) = 4.79 W/kg**

Maximum value of SAR (measured) = 13.8 W/kg

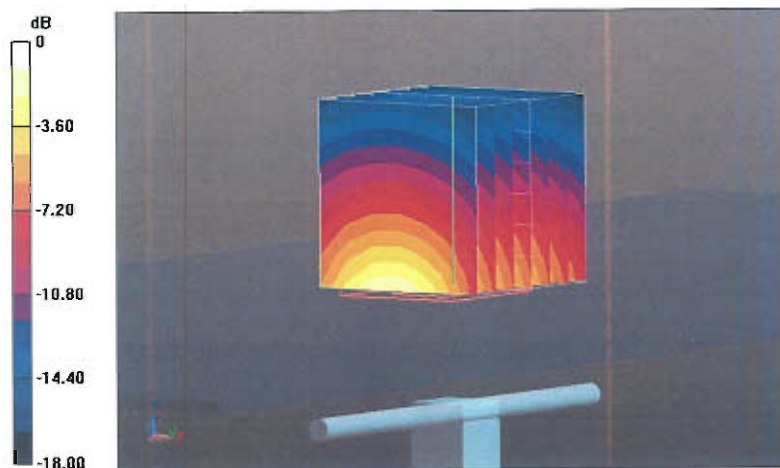

0 dB = 13.8 W/kg = 11.40 dBW/kg

# Impedance Measurement Plot for Head TSL

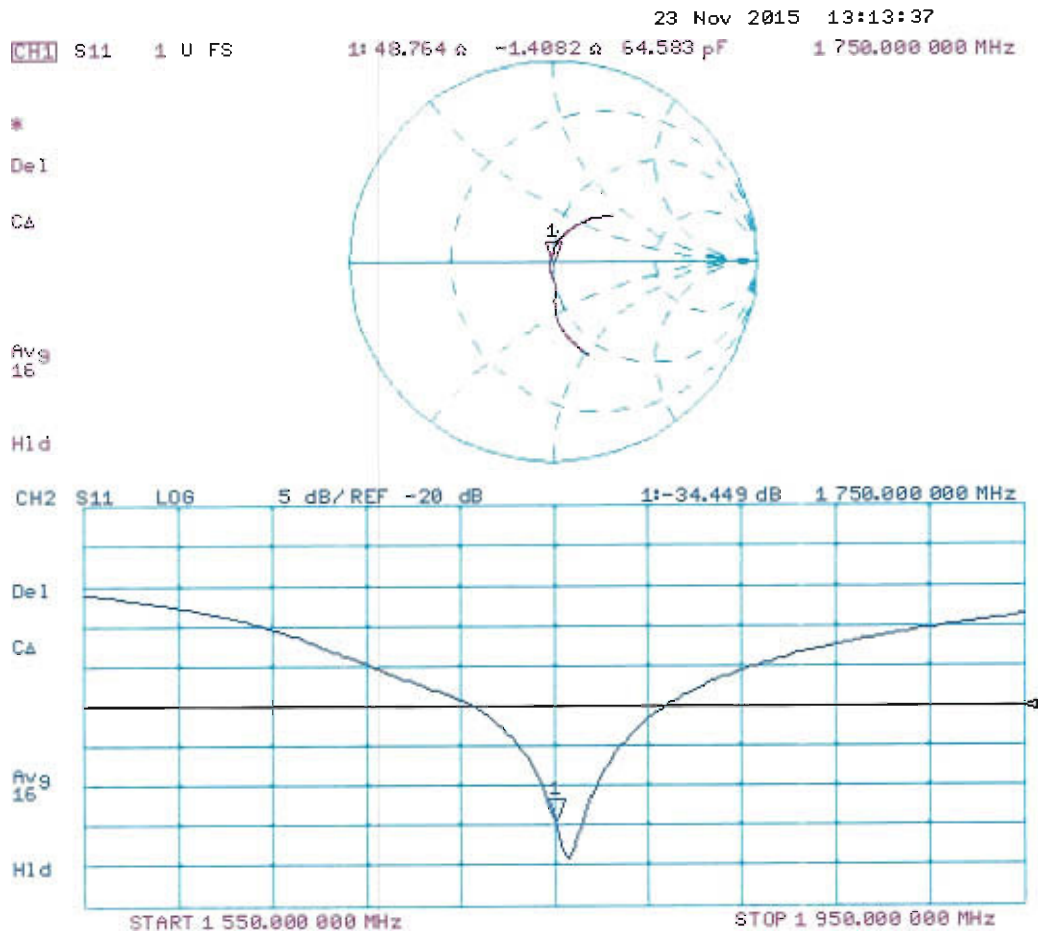



# DASY5 Validation Report for Body TSL

Date: 23.11.2015

Test Laboratory: SPEAG, Zurich, Switzerland

**DUT: Dipole 1750 MHz; Type: D1750V2; Serial: D1750V2 - SN: 1068**

Communication System: UID 0 - CW; Frequency: 1750 MHz

Medium parameters used:  $f = 1750$  MHz;  $\sigma = 1.48$  S/m;  $\epsilon_r = 54.2$ ;  $\rho = 1000$  kg/m<sup>3</sup>

Phantom section: Flat Section

Measurement Standard: DASY5 (IEEE/IEC/ANSI C63.19-2011)

DASY52 Configuration:

- Probe: EX3DV4 - SN7349; ConvF(8.25, 8.25, 8.25); Calibrated: 30.12.2014;
- Sensor-Surface: 1.4mm (Mechanical Surface Detection)
- Electronics: DAE4 Sn601; Calibrated: 17.08.2015
- Phantom: Flat Phantom 5.0 (back); Type: QD000P50AA; Serial: 1002
- DASY52 52.8.8(1222); SEMCAD X 14.6.10(7331)

## Dipole Calibration for Body Tissue/Pin=250 mW, d=10mm/Zoom Scan (7x7x7)/Cube 0:

Measurement grid: dx=5mm, dy=5mm, dz=5mm

Reference Value = 98.87 V/m; Power Drift = -0.01 dB

Peak SAR (extrapolated) = 15.7 W/kg

**SAR(1 g) = 8.85 W/kg; SAR(10 g) = 4.72 W/kg**

Maximum value of SAR (measured) = 13.3 W/kg

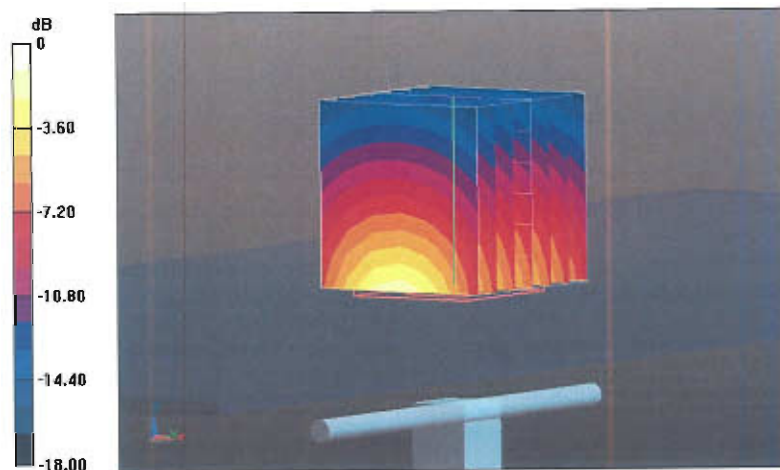

0 dB = 13.3 W/kg = 11.24 dBW/kg

# Impedance Measurement Plot for Body TSL

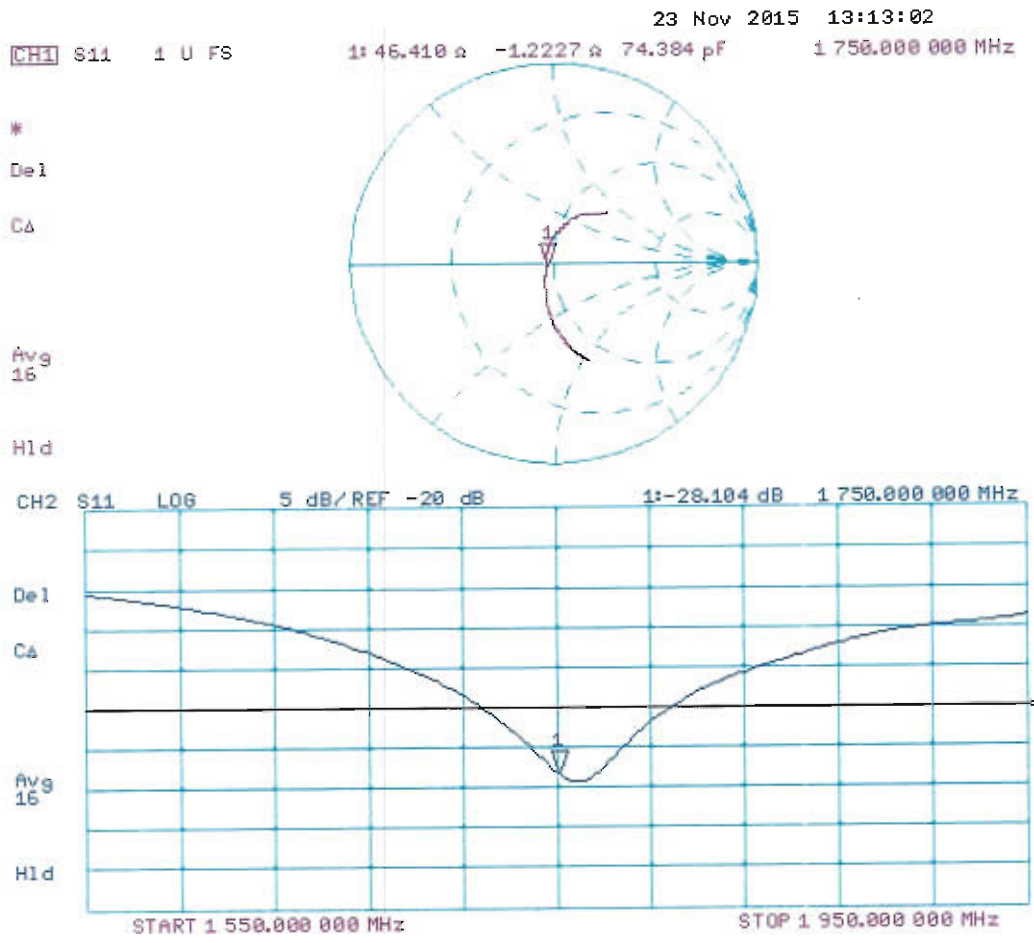



Accredited by the Swiss Accreditation Service (SAS)  
The Swiss Accreditation Service is one of the signatories to the EA  
Multilateral Agreement for the recognition of calibration certificates

Accreditation No.: **SCS 0108**

Client **Sporton-TW (Auden)**

Certificate No: **D1900V2-5d041\_Oct15**

## CALIBRATION CERTIFICATE

Object **D1900V2 - SN: 5d041**

Calibration procedure(s) **QA CAL-05.v9**  
**Calibration procedure for dipole validation kits above 700 MHz**

Calibration date: **October 22, 2015**

This calibration certificate documents the traceability to national standards, which realize the physical units of measurements (SI).  
The measurements and the uncertainties with confidence probability are given on the following pages and are part of the certificate.

All calibrations have been conducted in the closed laboratory facility: environment temperature ( $22 \pm 3$ )°C and humidity < 70%.

Calibration Equipment used (M&TE critical for calibration)

Primary Standards	ID #	Cal Date (Certificate No.)	Scheduled Calibration
Power meter EPM-442A	GB37480704	07-Oct-15 (No. 217-02222)	Oct-16
Power sensor HP 8481A	US37292783	07-Oct-15 (No. 217-02222)	Oct-16
Power sensor HP 8481A	MY41092317	07-Oct-15 (No. 217-02223)	Oct-16
Reference 20 dB Attenuator	SN: 5058 (20k)	01-Apr-15 (No. 217-02131)	Mar-16
Type-N mismatch combination	SN: 5047.2 / 06327	01-Apr-15 (No. 217-02134)	Mar-16
Reference Probe EX3DV4	SN: 7349	30-Dec-14 (No. EX3-7349_Dec14)	Dec-15
DAE4	SN: 601	17-Aug-15 (No. DAE4-601_Aug15)	Aug-16
Secondary Standards	ID #	Check Date (in house)	Scheduled Check
RF generator R&S SMT-06	100972	15-Jun-15 (in house check Jun-15)	In house check: Jun-18
Network Analyzer HP 8753E	US37390585 S4206	18-Oct-01 (in house check Oct-15)	In house check: Oct-16

Calibrated by: **Israe Elnaouq**      Name: **Israe Elnaouq**      Function: **Laboratory Technician**

Approved by: **Katja Pokovic**      Name: **Katja Pokovic**      Function: **Technical Manager**

Signature  
  

Issued: October 22, 2015

This calibration certificate shall not be reproduced except in full without written approval of the laboratory.



Accredited by the Swiss Accreditation Service (SAS)

Accreditation No.: **SCS 0108**

The Swiss Accreditation Service is one of the signatories to the EA  
Multilateral Agreement for the recognition of calibration certificates

### Glossary:

TSL	tissue simulating liquid
ConvF	sensitivity in TSL / NORM x,y,z
N/A	not applicable or not measured

### Calibration is Performed According to the Following Standards:

- IEEE Std 1528-2013, "IEEE Recommended Practice for Determining the Peak Spatial-Averaged Specific Absorption Rate (SAR) in the Human Head from Wireless Communications Devices: Measurement Techniques", June 2013
- IEC 62209-1, "Procedure to measure the Specific Absorption Rate (SAR) for hand-held devices used in close proximity to the ear (frequency range of 300 MHz to 3 GHz)", February 2005
- IEC 62209-2, "Procedure to determine the Specific Absorption Rate (SAR) for wireless communication devices used in close proximity to the human body (frequency range of 30 MHz to 6 GHz)", March 2010
- KDB 865664, "SAR Measurement Requirements for 100 MHz to 6 GHz"

### Additional Documentation:

- DASY4/5 System Handbook

### Methods Applied and Interpretation of Parameters:

- Measurement Conditions:** Further details are available from the Validation Report at the end of the certificate. All figures stated in the certificate are valid at the frequency indicated.
- Antenna Parameters with TSL:** The dipole is mounted with the spacer to position its feed point exactly below the center marking of the flat phantom section, with the arms oriented parallel to the body axis.
- Feed Point Impedance and Return Loss:** These parameters are measured with the dipole positioned under the liquid filled phantom. The impedance stated is transformed from the measurement at the SMA connector to the feed point. The Return Loss ensures low reflected power. No uncertainty required.
- Electrical Delay:** One-way delay between the SMA connector and the antenna feed point. No uncertainty required.
- SAR measured:** SAR measured at the stated antenna input power.
- SAR normalized:** SAR as measured, normalized to an input power of 1 W at the antenna connector.
- SAR for nominal TSL parameters:** The measured TSL parameters are used to calculate the nominal SAR result.

The reported uncertainty of measurement is stated as the standard uncertainty of measurement multiplied by the coverage factor  $k=2$ , which for a normal distribution corresponds to a coverage probability of approximately 95%.

## Measurement Conditions

DASY system configuration, as far as not given on page 1.

<b>DASY Version</b>	DASY5	V52.8.8
<b>Extrapolation</b>	Advanced Extrapolation	
<b>Phantom</b>	Modular Flat Phantom	
<b>Distance Dipole Center - TSL</b>	10 mm	with Spacer
<b>Zoom Scan Resolution</b>	dx, dy, dz = 5 mm	
<b>Frequency</b>	1900 MHz $\pm$ 1 MHz	

## Head TSL parameters

The following parameters and calculations were applied.

	Temperature	Permittivity	Conductivity
<b>Nominal Head TSL parameters</b>	22.0 °C	40.0	1.40 mho/m
<b>Measured Head TSL parameters</b>	(22.0 $\pm$ 0.2) °C	38.9 $\pm$ 6 %	1.38 mho/m $\pm$ 6 %
<b>Head TSL temperature change during test</b>	< 0.5 °C	----	----

## SAR result with Head TSL

<b>SAR averaged over 1 cm<sup>3</sup> (1 g) of Head TSL</b>	Condition	
SAR measured	250 mW input power	9.92 W/kg
SAR for nominal Head TSL parameters	normalized to 1W	<b>39.8 W/kg <math>\pm</math> 17.0 % (k=2)</b>

<b>SAR averaged over 10 cm<sup>3</sup> (10 g) of Head TSL</b>	condition	
SAR measured	250 mW input power	5.19 W/kg
SAR for nominal Head TSL parameters	normalized to 1W	<b>20.8 W/kg <math>\pm</math> 16.5 % (k=2)</b>

## Body TSL parameters

The following parameters and calculations were applied.

	Temperature	Permittivity	Conductivity
<b>Nominal Body TSL parameters</b>	22.0 °C	53.3	1.52 mho/m
<b>Measured Body TSL parameters</b>	(22.0 $\pm$ 0.2) °C	52.3 $\pm$ 6 %	1.51 mho/m $\pm$ 6 %
<b>Body TSL temperature change during test</b>	< 0.5 °C	----	----

## SAR result with Body TSL

<b>SAR averaged over 1 cm<sup>3</sup> (1 g) of Body TSL</b>	Condition	
SAR measured	250 mW input power	10.0 W/kg
SAR for nominal Body TSL parameters	normalized to 1W	<b>40.0 W/kg <math>\pm</math> 17.0 % (k=2)</b>

<b>SAR averaged over 10 cm<sup>3</sup> (10 g) of Body TSL</b>	condition	
SAR measured	250 mW input power	5.30 W/kg
SAR for nominal Body TSL parameters	normalized to 1W	<b>21.2 W/kg <math>\pm</math> 16.5 % (k=2)</b>

## Appendix (Additional assessments outside the scope of SCS 0108)

### Antenna Parameters with Head TSL

Impedance, transformed to feed point	53.0 $\Omega$ + 7.1 j $\Omega$
Return Loss	- 22.5 dB

### Antenna Parameters with Body TSL

Impedance, transformed to feed point	48.8 $\Omega$ + 7.7 j $\Omega$
Return Loss	- 22.1 dB

### General Antenna Parameters and Design

Electrical Delay (one direction)	1.203 ns
----------------------------------	----------

After long term use with 100W radiated power, only a slight warming of the dipole near the feedpoint can be measured.

The dipole is made of standard semirigid coaxial cable. The center conductor of the feeding line is directly connected to the second arm of the dipole. The antenna is therefore short-circuited for DC-signals. On some of the dipoles, small end caps are added to the dipole arms in order to improve matching when loaded according to the position as explained in the "Measurement Conditions" paragraph. The SAR data are not affected by this change. The overall dipole length is still according to the Standard.

No excessive force must be applied to the dipole arms, because they might bend or the soldered connections near the feedpoint may be damaged.

### Additional EUT Data

Manufactured by	SPEAG
Manufactured on	July 04, 2003

## DASY5 Validation Report for Head TSL

Date: 22.10.2015

Test Laboratory: SPEAG, Zurich, Switzerland

**DUT: Dipole 1900 MHz; Type: D1900V2; Serial: D1900V2 - SN: 5d041**

Communication System: UID 0 - CW; Frequency: 1900 MHz

Medium parameters used:  $f = 1900$  MHz;  $\sigma = 1.38$  S/m;  $\epsilon_r = 38.9$ ;  $\rho = 1000$  kg/m<sup>3</sup>

Phantom section: Flat Section

Measurement Standard: DASY5 (IEEE/IEC/ANSI C63.19-2011)

DASY52 Configuration:

- Probe: EX3DV4 - SN7349; ConvF(8.14, 8.14, 8.14); Calibrated: 30.12.2014;
- Sensor-Surface: 1.4mm (Mechanical Surface Detection)
- Electronics: DAE4 Sn601; Calibrated: 17.08.2015
- Phantom: Flat Phantom 5.0 (front); Type: QD000P50AA; Serial: 1001
- DASY52 52.8.8(1222); SEMCAD X 14.6.10(7331)

### Dipole Calibration for Head Tissue/Pin=250 mW, d=10mm/Zoom Scan (7x7x7)/Cube 0:

Measurement grid: dx=5mm, dy=5mm, dz=5mm

Reference Value = 109.2 V/m; Power Drift = 0.04 dB

Peak SAR (extrapolated) = 18.6 W/kg

**SAR(1 g) = 9.92 W/kg; SAR(10 g) = 5.19 W/kg**

Maximum value of SAR (measured) = 15.4 W/kg

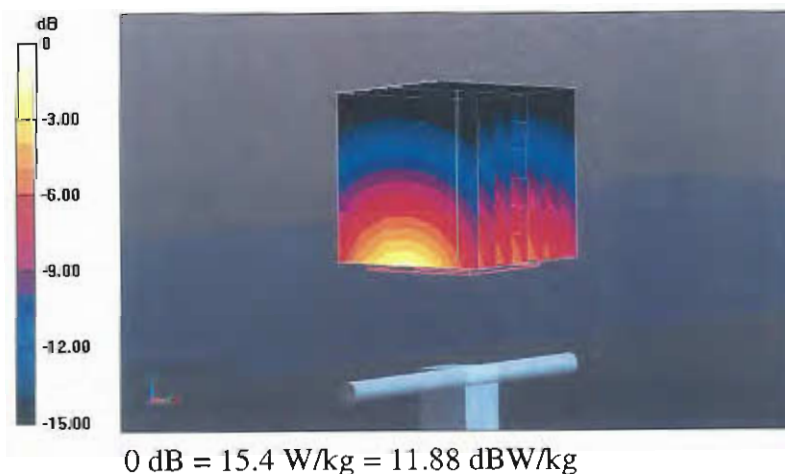

# Impedance Measurement Plot for Head TSL

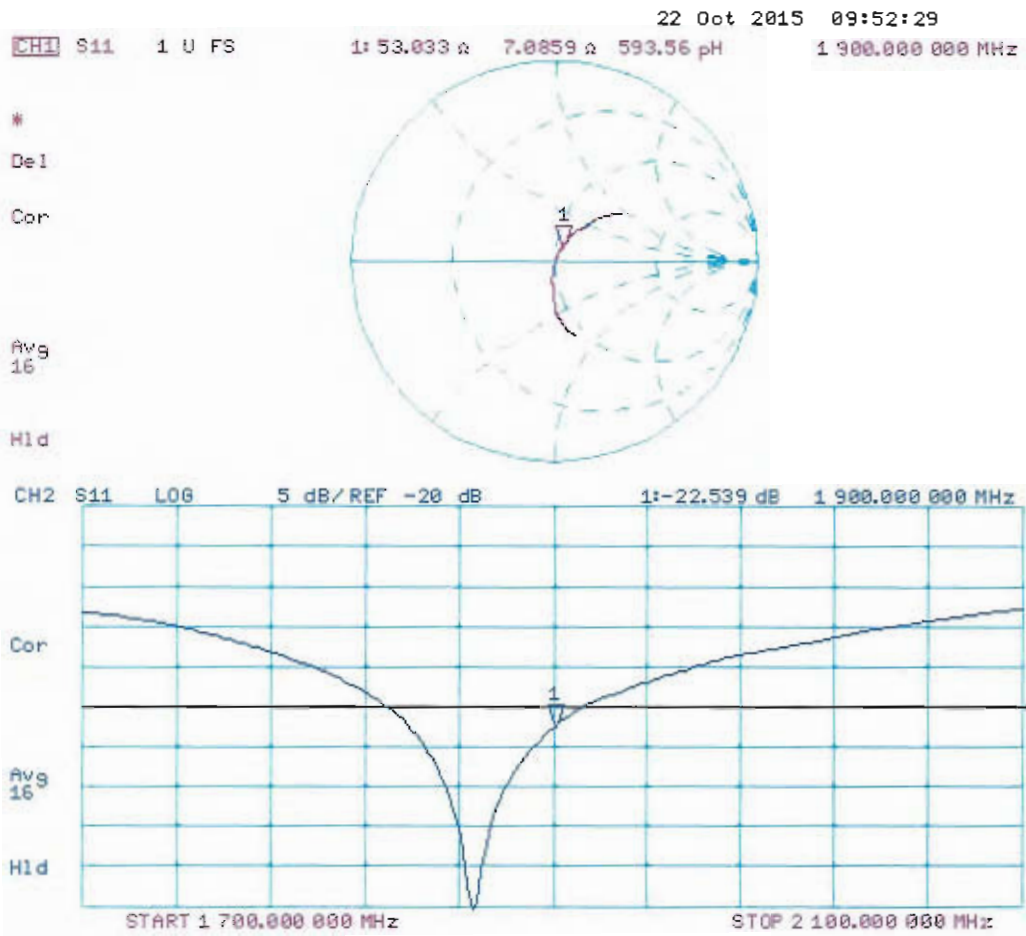



## DASY5 Validation Report for Body TSL

Date: 22.10.2015

Test Laboratory: SPEAG, Zurich, Switzerland

**DUT: Dipole 1900 MHz; Type: D1900V2; Serial: D1900V2 - SN: 5d041**

Communication System: UID 0 - CW; Frequency: 1900 MHz

Medium parameters used:  $f = 1900$  MHz;  $\sigma = 1.51$  S/m;  $\epsilon_r = 52.3$ ;  $\rho = 1000$  kg/m<sup>3</sup>

Phantom section: Flat Section

Measurement Standard: DASY5 (IEEE/IEC/ANSI C63.19-2011)

DASY52 Configuration:

- Probe: EX3DV4 - SN7349; ConvF(7.9, 7.9, 7.9); Calibrated: 30.12.2014;
- Sensor-Surface: 1.4mm (Mechanical Surface Detection)
- Electronics: DAE4 Sn601; Calibrated: 17.08.2015
- Phantom: Flat Phantom 5.0 (back); Type: QD000P50AA; Serial: 1002
- DASY52 52.8.8(1222); SEMCAD X 14.6.10(7331)

### **Dipole Calibration for Body Tissue/Pin=250 mW, d=10mm/Zoom Scan (7x7x7)/Cube 0:**

Measurement grid: dx=5mm, dy=5mm, dz=5mm

Reference Value = 104.2 V/m; Power Drift = 0.02 dB

Peak SAR (extrapolated) = 17.9 W/kg

**SAR(1 g) = 10 W/kg; SAR(10 g) = 5.3 W/kg**

Maximum value of SAR (measured) = 15.2 W/kg

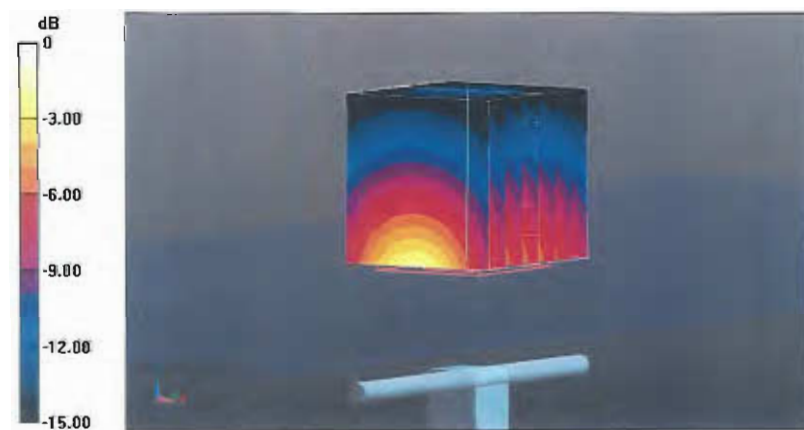

0 dB = 15.2 W/kg = 11.82 dBW/kg

# Impedance Measurement Plot for Body TSL

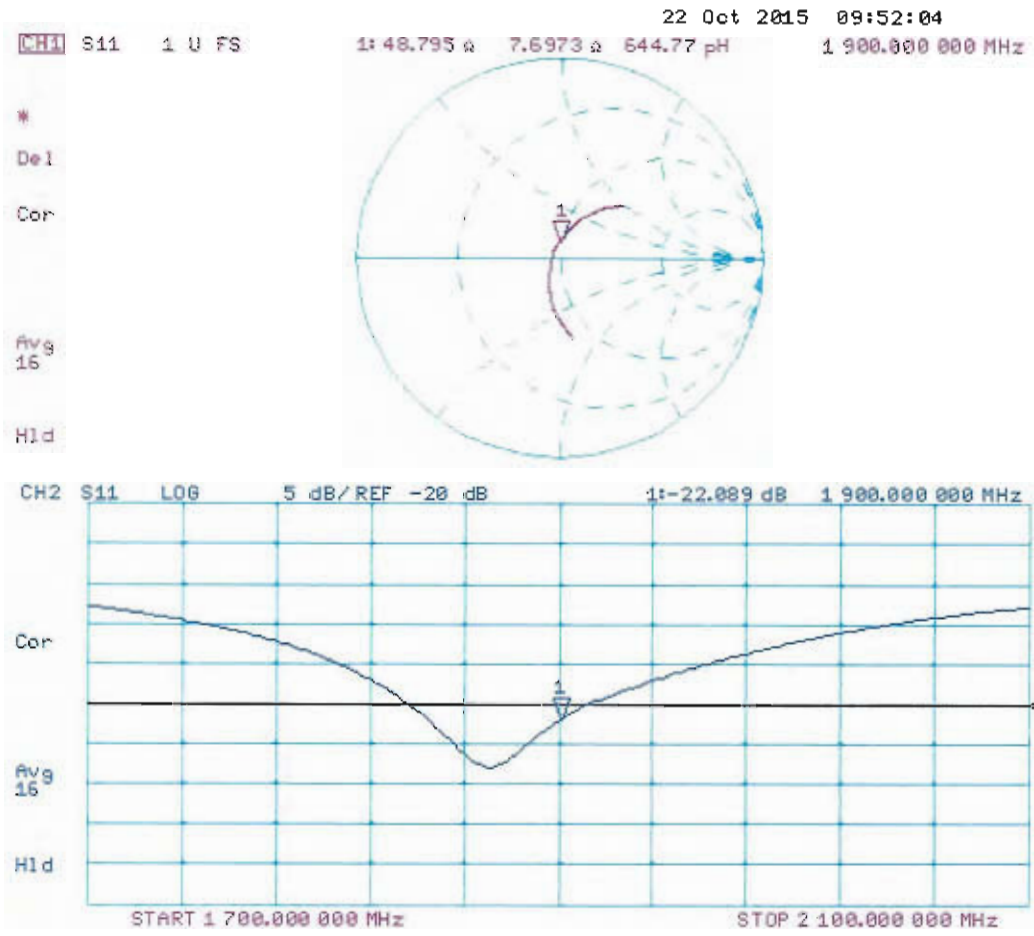



Accredited by the Swiss Accreditation Service (SAS)  
The Swiss Accreditation Service is one of the signatories to the EA  
Multilateral Agreement for the recognition of calibration certificates

Accreditation No.: **SCS 0108**

Client **Sporton-TW (Auden)**

Certificate No: **D2600V2-1008\_Aug15**

## CALIBRATION CERTIFICATE

Object **D2600V2 - SN: 1008**

Calibration procedure(s) **QA CAL-05.v9  
Calibration procedure for dipole validation kits above 700 MHz**

Calibration date: **August 19, 2015**

This calibration certificate documents the traceability to national standards, which realize the physical units of measurements (SI).  
The measurements and the uncertainties with confidence probability are given on the following pages and are part of the certificate.

All calibrations have been conducted in the closed laboratory facility: environment temperature ( $22 \pm 3$ )°C and humidity < 70%.

Calibration Equipment used (M&TE critical for calibration)

Primary Standards	ID #	Cal Date (Certificate No.)	Scheduled Calibration
Power meter EPM-442A	GB37480704	07-Oct-14 (No. 217-02020)	Oct-15
Power sensor HP 8481A	US37292783	07-Oct-14 (No. 217-02020)	Oct-15
Power sensor HP 8481A	MY41092317	07-Oct-14 (No. 217-02021)	Oct-15
Reference 20 dB Attenuator	SN: 5058 (20k)	01-Apr-15 (No. 217-02131)	Mar-16
Type-N mismatch combination	SN: 5047.2 / 06327	01-Apr-15 (No. 217-02134)	Mar-16
Reference Probe ES3DV3	SN: 3205	30-Dec-14 (No. ES3-3205_Dec14)	Dec-15
DAE4	SN: 601	17-Aug-15 (No. DAE4-601_Aug15)	Aug-16
Secondary Standards	ID #	Check Date (in house)	Scheduled Check
RF generator R&S SMT-06	100005	04-Aug-99 (in house check Oct-13)	In house check: Oct-16
Network Analyzer HP 8753E	US37390585 S4206	18-Oct-01 (in house check Oct-14)	In house check: Oct-15

Calibrated by: **Name** Michael Weber **Function** Laboratory Technician

Signature

Approved by: **Name** Katja Pokovic **Function** Technical Manager

Issued: August 26, 2015

This calibration certificate shall not be reproduced except in full without written approval of the laboratory.



Accredited by the Swiss Accreditation Service (SAS)

Accreditation No.: **SCS 0108**

The Swiss Accreditation Service is one of the signatories to the EA  
Multilateral Agreement for the recognition of calibration certificates

### Glossary:

TSL	tissue simulating liquid
ConvF	sensitivity in TSL / NORM x,y,z
N/A	not applicable or not measured

### Calibration is Performed According to the Following Standards:

- IEEE Std 1528-2013, "IEEE Recommended Practice for Determining the Peak Spatial-Averaged Specific Absorption Rate (SAR) in the Human Head from Wireless Communications Devices: Measurement Techniques", June 2013
- IEC 62209-1, "Procedure to measure the Specific Absorption Rate (SAR) for hand-held devices used in close proximity to the ear (frequency range of 300 MHz to 3 GHz)", February 2005
- IEC 62209-2, "Procedure to determine the Specific Absorption Rate (SAR) for wireless communication devices used in close proximity to the human body (frequency range of 30 MHz to 6 GHz)", March 2010
- KDB 865664, "SAR Measurement Requirements for 100 MHz to 6 GHz"

### Additional Documentation:

- DASY4/5 System Handbook

### Methods Applied and Interpretation of Parameters:

- Measurement Conditions:** Further details are available from the Validation Report at the end of the certificate. All figures stated in the certificate are valid at the frequency indicated.
- Antenna Parameters with TSL:** The dipole is mounted with the spacer to position its feed point exactly below the center marking of the flat phantom section, with the arms oriented parallel to the body axis.
- Feed Point Impedance and Return Loss:** These parameters are measured with the dipole positioned under the liquid filled phantom. The impedance stated is transformed from the measurement at the SMA connector to the feed point. The Return Loss ensures low reflected power. No uncertainty required.
- Electrical Delay:** One-way delay between the SMA connector and the antenna feed point. No uncertainty required.
- SAR measured:** SAR measured at the stated antenna input power.
- SAR normalized:** SAR as measured, normalized to an input power of 1 W at the antenna connector.
- SAR for nominal TSL parameters:** The measured TSL parameters are used to calculate the nominal SAR result.

The reported uncertainty of measurement is stated as the standard uncertainty of measurement multiplied by the coverage factor  $k=2$ , which for a normal distribution corresponds to a coverage probability of approximately 95%.

## Measurement Conditions

DASY system configuration, as far as not given on page 1.

<b>DASY Version</b>	DASY5	V52.8.8
<b>Extrapolation</b>	Advanced Extrapolation	
<b>Phantom</b>	Modular Flat Phantom	
<b>Distance Dipole Center - TSL</b>	10 mm	with Spacer
<b>Zoom Scan Resolution</b>	dx, dy, dz = 5 mm	
<b>Frequency</b>	2600 MHz $\pm$ 1 MHz	

## Head TSL parameters

The following parameters and calculations were applied.

	Temperature	Permittivity	Conductivity
<b>Nominal Head TSL parameters</b>	22.0 °C	39.0	1.96 mho/m
<b>Measured Head TSL parameters</b>	(22.0 $\pm$ 0.2) °C	38.6 $\pm$ 6 %	2.05 mho/m $\pm$ 6 %
<b>Head TSL temperature change during test</b>	< 0.5 °C	----	----

## SAR result with Head TSL

<b>SAR averaged over 1 cm<sup>3</sup> (1 g) of Head TSL</b>	Condition	
SAR measured	250 mW input power	14.4 W/kg
SAR for nominal Head TSL parameters	normalized to 1W	<b>56.3 W/kg <math>\pm</math> 17.0 % (k=2)</b>

<b>SAR averaged over 10 cm<sup>3</sup> (10 g) of Head TSL</b>	condition	
SAR measured	250 mW input power	6.47 W/kg
SAR for nominal Head TSL parameters	normalized to 1W	<b>25.6 W/kg <math>\pm</math> 16.5 % (k=2)</b>

## Body TSL parameters

The following parameters and calculations were applied.

	Temperature	Permittivity	Conductivity
<b>Nominal Body TSL parameters</b>	22.0 °C	52.5	2.16 mho/m
<b>Measured Body TSL parameters</b>	(22.0 $\pm$ 0.2) °C	52.8 $\pm$ 6 %	2.18 mho/m $\pm$ 6 %
<b>Body TSL temperature change during test</b>	< 0.5 °C	----	----

## SAR result with Body TSL

<b>SAR averaged over 1 cm<sup>3</sup> (1 g) of Body TSL</b>	Condition	
SAR measured	250 mW input power	14.0 W/kg
SAR for nominal Body TSL parameters	normalized to 1W	<b>55.8 W/kg <math>\pm</math> 17.0 % (k=2)</b>

<b>SAR averaged over 10 cm<sup>3</sup> (10 g) of Body TSL</b>	condition	
SAR measured	250 mW input power	6.29 W/kg
SAR for nominal Body TSL parameters	normalized to 1W	<b>25.1 W/kg <math>\pm</math> 16.5 % (k=2)</b>

## Appendix (Additional assessments outside the scope of SCS 0108)

### Antenna Parameters with Head TSL

Impedance, transformed to feed point	49.6 $\Omega$ - 2.1 j $\Omega$
Return Loss	- 33.2 dB

### Antenna Parameters with Body TSL

Impedance, transformed to feed point	45.8 $\Omega$ - 1.7 j $\Omega$
Return Loss	- 26.5 dB

### General Antenna Parameters and Design

Electrical Delay (one direction)	1.154 ns
----------------------------------	----------

After long term use with 100W radiated power, only a slight warming of the dipole near the feedpoint can be measured.

The dipole is made of standard semirigid coaxial cable. The center conductor of the feeding line is directly connected to the second arm of the dipole. The antenna is therefore short-circuited for DC-signals. On some of the dipoles, small end caps are added to the dipole arms in order to improve matching when loaded according to the position as explained in the "Measurement Conditions" paragraph. The SAR data are not affected by this change. The overall dipole length is still according to the Standard.

No excessive force must be applied to the dipole arms, because they might bend or the soldered connections near the feedpoint may be damaged.

### Additional EUT Data

Manufactured by	SPEAG
Manufactured on	December 23, 2006

## DASY5 Validation Report for Head TSL

Date: 19.08.2015

Test Laboratory: SPEAG, Zurich, Switzerland

**DUT: Dipole 2600 MHz; Type: D2600V2; Serial: D2600V2 - SN: 1008**

Communication System: UID 0 - CW; Frequency: 2600 MHz

Medium parameters used:  $f = 2600$  MHz;  $\sigma = 2.05$  S/m;  $\epsilon_r = 38.6$ ;  $\rho = 1000$  kg/m<sup>3</sup>

Phantom section: Flat Section

Measurement Standard: DASY5 (IEEE/IEC/ANSI C63.19-2011)

DASY52 Configuration:

- Probe: ES3DV3 - SN3205; ConvF(4.49, 4.49, 4.49); Calibrated: 30.12.2014;
- Sensor-Surface: 3mm (Mechanical Surface Detection)
- Electronics: DAE4 Sn601; Calibrated: 17.08.2015
- Phantom: Flat Phantom 5.0 (front); Type: QD000P50AA; Serial: 1001
- DASY52 52.8.8(1222); SEMCAD X 14.6.10(7331)

### Dipole Calibration for Head Tissue/Pin=250 mW, d=10mm/Zoom Scan (7x7x7)/Cube 0:

Measurement grid: dx=5mm, dy=5mm, dz=5mm

Reference Value = 102.2 V/m; Power Drift = 0.03 dB

Peak SAR (extrapolated) = 30.4 W/kg

**SAR(1 g) = 14.4 W/kg; SAR(10 g) = 6.47 W/kg**

Maximum value of SAR (measured) = 19.5 W/kg



# Impedance Measurement Plot for Head TSL

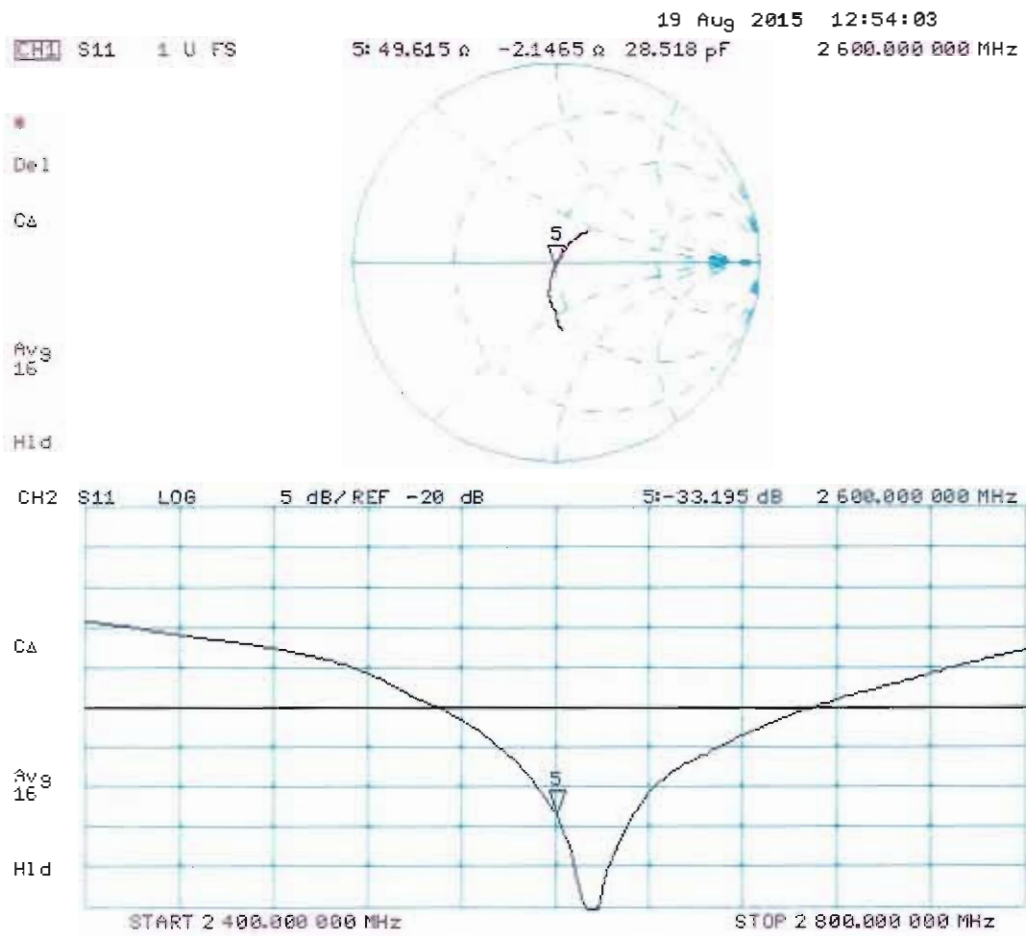



## DASY5 Validation Report for Body TSL

Date: 19.08.2015

Test Laboratory: SPEAG, Zurich, Switzerland

**DUT: Dipole 2600 MHz; Type: D2600V2; Serial: D2600V2 - SN: 1008**

Communication System: UID 0 - CW; Frequency: 2600 MHz

Medium parameters used:  $f = 2600$  MHz;  $\sigma = 2.18$  S/m;  $\epsilon_r = 52.8$ ;  $\rho = 1000$  kg/m<sup>3</sup>

Phantom section: Flat Section

Measurement Standard: DASY5 (IEEE/IEC/ANSI C63.19-2011)

DASY52 Configuration:

- Probe: ES3DV3 - SN3205; ConvF(4.I3, 4.I3, 4.I3); Calibrated: 30.12.2014;
- Sensor-Surface: 3mm (Mechanical Surface Detection)
- Electronics: DAE4 Sn601; Calibrated: 17.08.2015
- Phantom: Flat Phantom 5.0 (back); Type: QD000P50AA; Serial: 1002
- DASY52 52.8.8(1222); SEMCAD X 14.6.10(7331)

### Dipole Calibration for Body Tissue/Pin=250 mW, d=10mm/Zoom Scan (7x7x7)/Cube 0:

Measurement grid: dx=5mm, dy=5mm, dz=5mm

Reference Value = 97.30 V/m; Power Drift = -0.01 dB

Peak SAR (extrapolated) = 28.6 W/kg

**SAR(1 g) = 14 W/kg; SAR(10 g) = 6.29 W/kg**

Maximum value of SAR (measured) = 18.7 W/kg

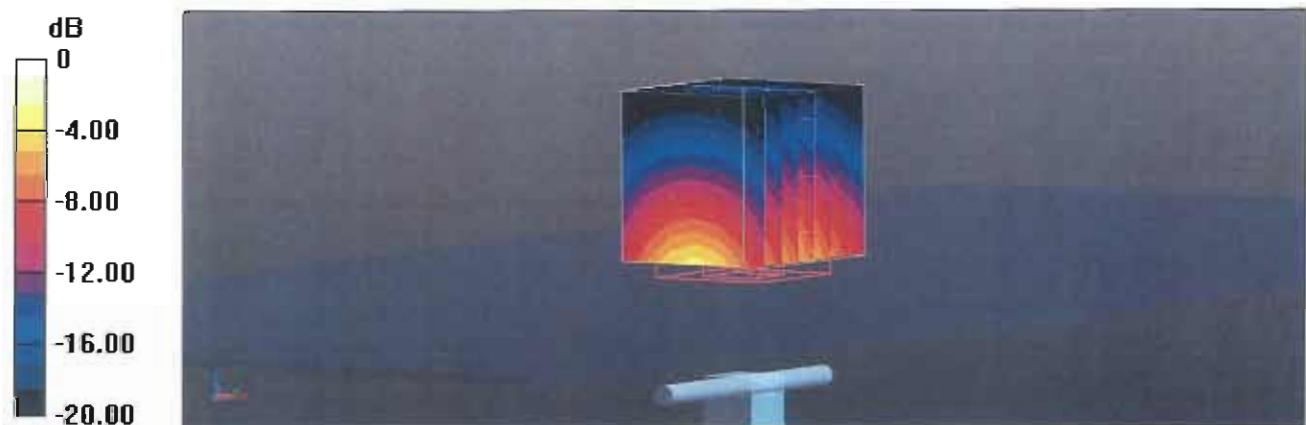

0 dB = 18.7 W/kg = 12.72 dBW/kg

# Impedance Measurement Plot for Body TSL

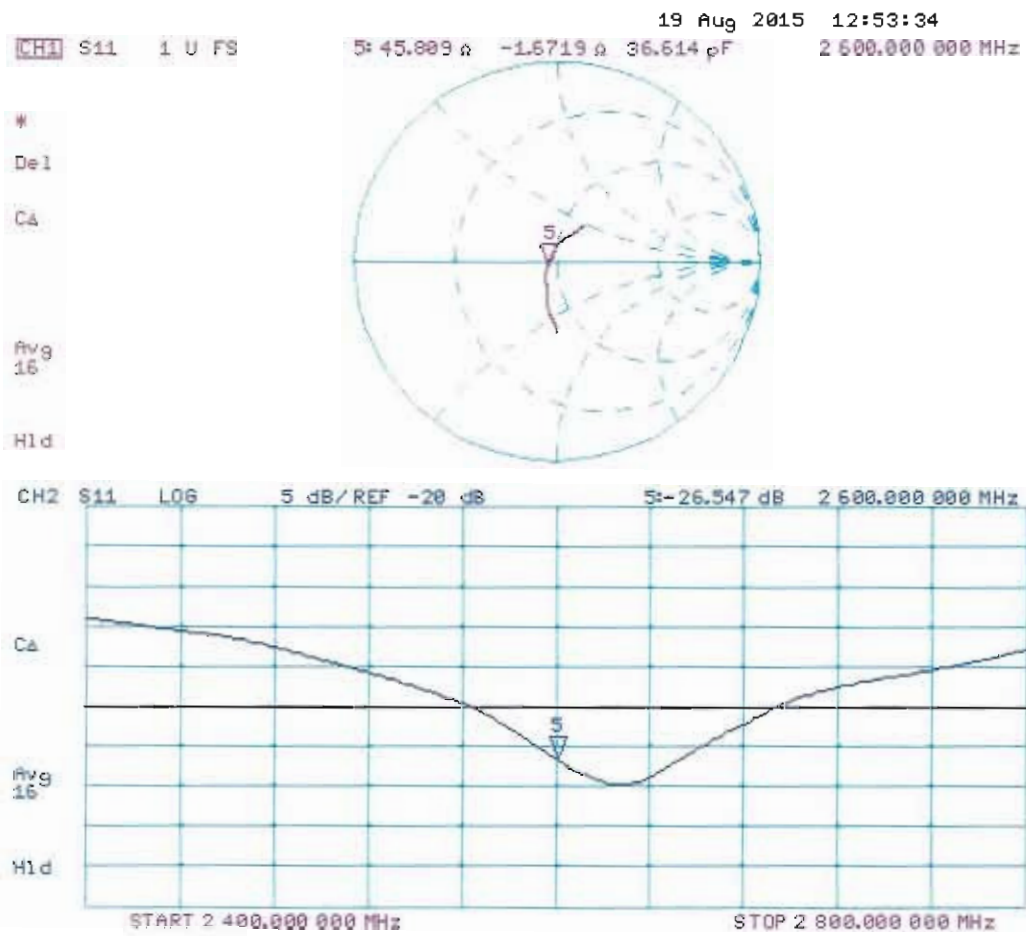



Accredited by the Swiss Accreditation Service (SAS)  
 The Swiss Accreditation Service is one of the signatories to the EA  
 Multilateral Agreement for the recognition of calibration certificates

Accreditation No.: **SCS 0108**

Client **Sporton - TW (Auden)**

Certificate No: **DAE4-778\_Aug15**

## CALIBRATION CERTIFICATE

Object **DAE4 - SD 000 D04 BM - SN: 778**

Calibration procedure(s) **QA CAL-06.v29**  
**Calibration procedure for the data acquisition electronics (DAE)**

Calibration date: **August 25, 2015**

This calibration certificate documents the traceability to national standards, which realize the physical units of measurements (SI).  
 The measurements and the uncertainties with confidence probability are given on the following pages and are part of the certificate.

All calibrations have been conducted in the closed laboratory facility: environment temperature (22 ± 3)°C and humidity < 70%.

Calibration Equipment used (M&TE critical for calibration)

Primary Standards	ID #	Cal Date (Certificate No.)	Scheduled Calibration
Keithley Multimeter Type 2001	SN: 0810278	03-Oct-14 (No:15573)	Oct-15
Secondary Standards	ID #	Check Date (in house)	Scheduled Check
Auto DAE Calibration Unit	SE UWS 053 AA 1001	06-Jan-15 (in house check)	In house check: Jan-16
Calibrator Box V2.1	SE UMS 006 AA 1002	06-Jan-15 (in house check)	In house check: Jan-16

Calibrated by:	Name Eric Hainfeld	Function Technician	Signature 
Approved by:	Fin Bornholt	Deputy Technical Manager	

Issued: August 25, 2015

This calibration certificate shall not be reproduced except in full without written approval of the laboratory.



Accredited by the Swiss Accreditation Service (SAS)  
The Swiss Accreditation Service is one of the signatories to the EA  
Multilateral Agreement for the recognition of calibration certificates

Accreditation No.: **SCS 0108**

## Glossary

DAE data acquisition electronics  
Connector angle information used in DASY system to align probe sensor X to the robot coordinate system.

## Methods Applied and Interpretation of Parameters

- *DC Voltage Measurement:* Calibration Factor assessed for use in DASY system by comparison with a calibrated instrument traceable to national standards. The figure given corresponds to the full scale range of the voltmeter in the respective range.
- *Connector angle:* The angle of the connector is assessed measuring the angle mechanically by a tool inserted. Uncertainty is not required.
- The following parameters as documented in the Appendix contain technical information as a result from the performance test and require no uncertainty.
  - *DC Voltage Measurement Linearity:* Verification of the Linearity at +10% and -10% of the nominal calibration voltage. Influence of offset voltage is included in this measurement.
  - *Common mode sensitivity:* Influence of a positive or negative common mode voltage on the differential measurement.
  - *Channel separation:* Influence of a voltage on the neighbor channels not subject to an input voltage.
  - *AD Converter Values with inputs shorted:* Values on the internal AD converter corresponding to zero input voltage
  - *Input Offset Measurement:* Output voltage and statistical results over a large number of zero voltage measurements.
  - *Input Offset Current:* Typical value for information; Maximum channel input offset current, not considering the input resistance.
  - *Input resistance:* Typical value for information: DAE input resistance at the connector, during internal auto-zeroing and during measurement.
  - *Low Battery Alarm Voltage:* Typical value for information. Below this voltage, a battery alarm signal is generated.
  - *Power consumption:* Typical value for information. Supply currents in various operating modes.

## DC Voltage Measurement

A/D - Converter Resolution nominal

High Range: 1LSB = 6.1 $\mu$ V, full range = -100...+300 mV

Low Range: 1LSB = 61nV, full range = -1.....+3mV

DASY measurement parameters: Auto Zero Time: 3 sec; Measuring time: 3 sec

Calibration Factors	X	Y	Z
High Range	404.656 $\pm$ 0.02% (k=2)	403.464 $\pm$ 0.02% (k=2)	405.018 $\pm$ 0.02% (k=2)
Low Range	3.98590 $\pm$ 1.50% (k=2)	3.96400 $\pm$ 1.50% (k=2)	4.00088 $\pm$ 1.50% (k=2)

## Connector Angle

Connector Angle to be used in DASY system	280.5 $^{\circ}$ $\pm$ 1 $^{\circ}$
---	-------------------------------------

## Appendix (Additional assessments outside the scope of SCS0108)

### 1. DC Voltage Linearity

High Range	Reading ( $\mu\text{V}$ )	Difference ( $\mu\text{V}$ )	Error (%)
Channel X + Input	200032.03	-5.20	-0.00
Channel X + Input	20005.20	1.02	0.01
Channel X - Input	-20003.13	3.32	-0.02
Channel Y + Input	200036.32	-1.13	-0.00
Channel Y + Input	20003.24	-0.80	-0.00
Channel Y - Input	-20004.43	2.14	-0.01
Channel Z + Input	200036.09	-1.05	-0.00
Channel Z + Input	20000.94	-2.98	-0.01
Channel Z - Input	-20010.33	-3.75	0.02

Low Range	Reading ( $\mu\text{V}$ )	Difference ( $\mu\text{V}$ )	Error (%)
Channel X + Input	2000.43	0.05	0.00
Channel X + Input	199.83	-0.40	-0.20
Channel X - Input	-199.82	-0.18	0.09
Channel Y + Input	2000.55	0.27	0.01
Channel Y + Input	200.80	0.64	0.32
Channel Y - Input	-200.23	-0.50	0.25
Channel Z + Input	1999.96	-0.17	-0.01
Channel Z + Input	198.86	-1.27	-0.63
Channel Z - Input	-201.15	-1.37	0.69

### 2. Common mode sensitivity

DASY measurement parameters: Auto Zero Time: 3 sec; Measuring time: 3 sec

	Common mode Input Voltage (mV)	High Range Average Reading ( $\mu\text{V}$ )	Low Range Average Reading ( $\mu\text{V}$ )
Channel X	200	-5.02	-5.64
	- 200	6.48	5.20
Channel Y	200	-1.48	-1.57
	- 200	0.41	0.04
Channel Z	200	-11.81	-11.73
	- 200	9.10	9.26

### 3. Channel separation

DASY measurement parameters: Auto Zero Time: 3 sec; Measuring time: 3 sec

	Input Voltage (mV)	Channel X ( $\mu\text{V}$ )	Channel Y ( $\mu\text{V}$ )	Channel Z ( $\mu\text{V}$ )
Channel X	200	-	-0.58	-3.14
Channel Y	200	9.32	-	-0.10
Channel Z	200	4.11	6.98	-

#### 4. AD-Converter Values with inputs shorted

DASY measurement parameters: Auto Zero Time: 3 sec; Measuring time: 3 sec

	High Range (LSB)	Low Range (LSB)
Channel X	16052	16596
Channel Y	16174	16055
Channel Z	16437	15803

#### 5. Input Offset Measurement

DASY measurement parameters: Auto Zero Time: 3 sec; Measuring time: 3 sec

Input 10M $\Omega$

	Average ( $\mu$ V)	min. Offset ( $\mu$ V)	max. Offset ( $\mu$ V)	Std. Deviation ( $\mu$ V)
Channel X	0.91	-0.00	1.57	0.34
Channel Y	-0.04	-1.67	1.95	0.65
Channel Z	-0.86	-2.30	0.32	0.53

#### 6. Input Offset Current

Nominal Input circuitry offset current on all channels: <25fA

#### 7. Input Resistance (Typical values for information)

	Zeroing (kOhm)	Measuring (MOhm)
Channel X	200	200
Channel Y	200	200
Channel Z	200	200

#### 8. Low Battery Alarm Voltage (Typical values for information)

Typical values	Alarm Level (VDC)
Supply (+ Vcc)	+7.9
Supply (- Vcc)	-7.6

#### 9. Power Consumption (Typical values for information)

Typical values	Switched off (mA)	Stand by (mA)	Transmitting (mA)
Supply (+ Vcc)	+0.01	+6	+14
Supply (- Vcc)	-0.01	-8	-9



Accredited by the Swiss Accreditation Service (SAS)  
The Swiss Accreditation Service is one of the signatories to the EA  
Multilateral Agreement for the recognition of calibration certificates

Accreditation No.: **SCS 0108**

Client **Sporton-TW (Auden)**

Certificate No: **DAE4-1399\_Nov15**

## CALIBRATION CERTIFICATE

Object **DAE4 - SD 000 D04 BM - SN: 1399**

Calibration procedure(s) **QA CAL-06.v29**  
**Calibration procedure for the data acquisition electronics (DAE)**

Calibration date: **November 23, 2015**

This calibration certificate documents the traceability to national standards, which realize the physical units of measurements (SI).  
The measurements and the uncertainties with confidence probability are given on the following pages and are part of the certificate.

All calibrations have been conducted in the closed laboratory facility: environment temperature  $(22 \pm 3)^\circ\text{C}$  and humidity  $< 70\%$ .

Calibration Equipment used (M&TE critical for calibration)

Primary Standards	ID #	Cal Date (Certificate No.)	Scheduled Calibration
Keithley Multimeter Type 2001	SN: 0810278	09-Sep-15 (No:17153)	Sep-16
Secondary Standards	ID #	Check Date (in house)	Scheduled Check
Auto DAE Calibration Unit	SE UWS 053 AA 1001	06-Jan-15 (in house check)	In house check: Jan-16
Calibrator Box V2.1	SE UMS 006 AA 1002	06-Jan-15 (in house check)	In house check: Jan-16

Calibrated by:	Name Dominique Steffen	Function Technician	Signature 
Approved by:	Fin Bomholt	Deputy Technical Manager	

Issued: November 23, 2015

This calibration certificate shall not be reproduced except in full without written approval of the laboratory.





Accredited by the Swiss Accreditation Service (SAS)  
The Swiss Accreditation Service is one of the signatories to the EA  
Multilateral Agreement for the recognition of calibration certificates

Accreditation No.: **SCS 0108**

## Glossary

DAE data acquisition electronics  
Connector angle information used in DASY system to align probe sensor X to the robot coordinate system.

## Methods Applied and Interpretation of Parameters

- *DC Voltage Measurement:* Calibration Factor assessed for use in DASY system by comparison with a calibrated instrument traceable to national standards. The figure given corresponds to the full scale range of the voltmeter in the respective range.
- *Connector angle:* The angle of the connector is assessed measuring the angle mechanically by a tool inserted. Uncertainty is not required.
- The following parameters as documented in the Appendix contain technical information as a result from the performance test and require no uncertainty.
  - *DC Voltage Measurement Linearity:* Verification of the Linearity at +10% and -10% of the nominal calibration voltage. Influence of offset voltage is included in this measurement.
  - *Common mode sensitivity:* Influence of a positive or negative common mode voltage on the differential measurement.
  - *Channel separation:* Influence of a voltage on the neighbor channels not subject to an input voltage.
  - *AD Converter Values with inputs shorted:* Values on the internal AD converter corresponding to zero input voltage
  - *Input Offset Measurement:* Output voltage and statistical results over a large number of zero voltage measurements.
  - *Input Offset Current:* Typical value for information; Maximum channel input offset current, not considering the input resistance.
  - *Input resistance:* Typical value for information: DAE input resistance at the connector, during internal auto-zeroing and during measurement.
  - *Low Battery Alarm Voltage:* Typical value for information. Below this voltage, a battery alarm signal is generated.
  - *Power consumption:* Typical value for information. Supply currents in various operating modes.

## DC Voltage Measurement

A/D - Converter Resolution nominal

High Range: 1LSB = 6.1 $\mu$ V, full range = -100...+300 mV

Low Range: 1LSB = 61nV, full range = -1.....+3mV

DASY measurement parameters: Auto Zero Time: 3 sec; Measuring time: 3 sec

Calibration Factors	X	Y	Z
High Range	403.569 $\pm$ 0.02% (k=2)	403.830 $\pm$ 0.02% (k=2)	403.686 $\pm$ 0.02% (k=2)
Low Range	3.98186 $\pm$ 1.50% (k=2)	3.99005 $\pm$ 1.50% (k=2)	3.98036 $\pm$ 1.50% (k=2)

## Connector Angle

Connector Angle to be used in DASY system	303.0 $^{\circ}$ $\pm$ 1 $^{\circ}$
---	-------------------------------------

## Appendix (Additional assessments outside the scope of SCS0108)

### 1. DC Voltage Linearity

High Range		Reading ( $\mu\text{V}$ )	Difference ( $\mu\text{V}$ )	Error (%)
Channel X	+ Input	200034.20	-1.95	-0.00
Channel X	+ Input	20004.24	-0.55	-0.00
Channel X	- Input	-20004.68	0.95	-0.00
Channel Y	+ Input	200034.75	-2.81	-0.00
Channel Y	+ Input	20002.71	-1.97	-0.01
Channel Y	- Input	-20006.72	-0.91	0.00
Channel Z	+ Input	200034.35	-2.72	-0.00
Channel Z	+ Input	20002.74	-1.91	-0.01
Channel Z	- Input	-20007.13	-1.44	0.01

Low Range		Reading ( $\mu\text{V}$ )	Difference ( $\mu\text{V}$ )	Error (%)
Channel X	+ Input	2000.90	-0.02	-0.00
Channel X	+ Input	201.19	0.32	0.16
Channel X	- Input	-198.77	0.20	-0.10
Channel Y	+ Input	2000.69	-0.23	-0.01
Channel Y	+ Input	200.19	-0.57	-0.29
Channel Y	- Input	-199.64	-0.59	0.29
Channel Z	+ Input	2000.76	-0.09	-0.00
Channel Z	+ Input	199.54	-1.29	-0.64
Channel Z	- Input	-200.88	-1.78	0.90

### 2. Common mode sensitivity

DASY measurement parameters: Auto Zero Time: 3 sec; Measuring time: 3 sec

	Common mode Input Voltage (mV)	High Range Average Reading ( $\mu\text{V}$ )	Low Range Average Reading ( $\mu\text{V}$ )
Channel X	200	-5.42	-6.82
	- 200	8.31	6.25
Channel Y	200	-5.59	-5.99
	- 200	4.78	4.49
Channel Z	200	-7.36	-7.21
	- 200	4.34	4.37

### 3. Channel separation

DASY measurement parameters: Auto Zero Time: 3 sec; Measuring time: 3 sec

	Input Voltage (mV)	Channel X ( $\mu\text{V}$ )	Channel Y ( $\mu\text{V}$ )	Channel Z ( $\mu\text{V}$ )
Channel X	200	-	5.03	-1.50
Channel Y	200	9.40	-	5.92
Channel Z	200	8.43	7.65	-

#### 4. AD-Converter Values with inputs shorted

DASY measurement parameters: Auto Zero Time: 3 sec; Measuring time: 3 sec

	High Range (LSB)	Low Range (LSB)
Channel X	15830	16396
Channel Y	16113	15933
Channel Z	15887	15858

#### 5. Input Offset Measurement

DASY measurement parameters: Auto Zero Time: 3 sec; Measuring time: 3 sec

Input 10M $\Omega$

	Average ( $\mu$ V)	min. Offset ( $\mu$ V)	max. Offset ( $\mu$ V)	Std. Deviation ( $\mu$ V)
Channel X	0.38	-0.36	1.37	0.35
Channel Y	0.35	-0.44	1.17	0.34
Channel Z	-2.61	-3.42	-1.45	0.39

#### 6. Input Offset Current

Nominal input circuitry offset current on all channels: <25fA

#### 7. Input Resistance (Typical values for information)

	Zeroing (kOhm)	Measuring (MOhm)
Channel X	200	200
Channel Y	200	200
Channel Z	200	200

#### 8. Low Battery Alarm Voltage (Typical values for information)

Typical values	Alarm Level (VDC)
Supply (+ Vcc)	+7.9
Supply (- Vcc)	-7.6

#### 9. Power Consumption (Typical values for information)

Typical values	Switched off (mA)	Stand by (mA)	Transmitting (mA)
Supply (+ Vcc)	+0.01	+6	+14
Supply (- Vcc)	-0.01	-8	-9



Accredited by the Swiss Accreditation Service (SAS)  
The Swiss Accreditation Service is one of the signatories to the EA  
Multilateral Agreement for the recognition of calibration certificates

Accreditation No.: **SCS 0108**

Client **Sporton-TW (Auden)**

Certificate No: **EX3-3697\_Sep15**

## CALIBRATION CERTIFICATE

Object: **EX3DV4 - SN:3697**

Calibration procedure(s): **QA CAL-01.v9, QA CAL-23.v5, QA CAL-25.v6  
Calibration procedure for dosimetric E-field probes**

Calibration date: **September 28, 2015**

This calibration certificate documents the traceability to national standards, which realize the physical units of measurements (SI).  
The measurements and the uncertainties with confidence probability are given on the following pages and are part of the certificate.

All calibrations have been conducted in the closed laboratory facility: environment temperature (22 ± 3)°C and humidity < 70%.

Calibration Equipment used (M&TE critical for calibration)

Primary Standards	ID	Cal Date (Certificate No.)	Scheduled Calibration
Power meter E4419B	GB41293874	01-Apr-15 (No. 217-02128)	Mar-16
Power sensor E4412A	MY41498087	01-Apr-15 (No. 217-02128)	Mar-16
Reference 3 dB Attenuator	SN: S5054 (3c)	01-Apr-15 (No. 217-02129)	Mar-16
Reference 20 dB Attenuator	SN: S5277 (20x)	01-Apr-15 (No. 217-02132)	Mar-16
Reference 30 dB Attenuator	SN: S5129 (30b)	01-Apr-15 (No. 217-02133)	Mar-16
Reference Probe ES3DV2	SN: 3013	30-Dec-14 (No. ES3-3013_Dec14)	Dec-15
DAE4	SN: 660	14-Jan-15 (No. DAE4-660_Jan15)	Jan-16
Secondary Standards	ID	Check Date (in house)	Scheduled Check
RF generator HP 8648C	US3642U01700	4-Aug-99 (in house check Apr-13)	In house check: Apr-16
Network Analyzer HP 8753E	US37390585	18-Oct-01 (in house check Oct-14)	In house check: Oct-15

	Name	Function	Signature
Calibrated by:	Israe Elnaouq	Laboratory Technician	
Approved by:	Katja Pokovic	Technical Manager	

Issued: September 30, 2015

This calibration certificate shall not be reproduced except in full without written approval of the laboratory.



Accredited by the Swiss Accreditation Service (SAS)

Accreditation No.: **SCS 0108**

The Swiss Accreditation Service is one of the signatories to the EA  
Multilateral Agreement for the recognition of calibration certificates

### Glossary:

TSL	tissue simulating liquid
NORM <sub>x,y,z</sub>	sensitivity in free space
ConvF	sensitivity in TSL / NORM <sub>x,y,z</sub>
DCP	diode compression point
CF	crest factor (1/duty_cycle) of the RF signal
A, B, C, D	modulation dependent linearization parameters
Polarization $\varphi$	$\varphi$ rotation around probe axis
Polarization $\vartheta$	$\vartheta$ rotation around an axis that is in the plane normal to probe axis (at measurement center), i.e., $\vartheta = 0$ is normal to probe axis
Connector Angle	information used in DASY system to align probe sensor X to the robot coordinate system

### Calibration is Performed According to the Following Standards:

- IEEE Std 1528-2013, "IEEE Recommended Practice for Determining the Peak Spatial-Averaged Specific Absorption Rate (SAR) in the Human Head from Wireless Communications Devices: Measurement Techniques", June 2013
- IEC 62209-1, "Procedure to measure the Specific Absorption Rate (SAR) for hand-held devices used in close proximity to the ear (frequency range of 300 MHz to 3 GHz)", February 2005
- IEC 62209-2, "Procedure to determine the Specific Absorption Rate (SAR) for wireless communication devices used in close proximity to the human body (frequency range of 30 MHz to 6 GHz)", March 2010
- KDB 865664, "SAR Measurement Requirements for 100 MHz to 6 GHz"

### Methods Applied and Interpretation of Parameters:

- NORM<sub>x,y,z</sub>**: Assessed for E-field polarization  $\vartheta = 0$  ( $f \leq 900$  MHz in TEM-cell;  $f > 1800$  MHz: R22 waveguide). NORM<sub>x,y,z</sub> are only intermediate values, i.e., the uncertainties of NORM<sub>x,y,z</sub> does not affect the E<sup>2</sup>-field uncertainty inside TSL (see below ConvF).
- NORM(f)<sub>x,y,z</sub>** = NORM<sub>x,y,z</sub> \* frequency\_response (see Frequency Response Chart). This linearization is implemented in DASY4 software versions later than 4.2. The uncertainty of the frequency response is included in the stated uncertainty of ConvF.
- DCP<sub>x,y,z</sub>**: DCP are numerical linearization parameters assessed based on the data of power sweep with CW signal (no uncertainty required). DCP does not depend on frequency nor media.
- PAR**: PAR is the Peak to Average Ratio that is not calibrated but determined based on the signal characteristics
- A<sub>x,y,z</sub>; B<sub>x,y,z</sub>; C<sub>x,y,z</sub>; D<sub>x,y,z</sub>; VR<sub>x,y,z</sub>**: A, B, C, D are numerical linearization parameters assessed based on the data of power sweep for specific modulation signal. The parameters do not depend on frequency nor media. VR is the maximum calibration range expressed in RMS voltage across the diode.
- ConvF and Boundary Effect Parameters**: Assessed in flat phantom using E-field (or Temperature Transfer Standard for  $f \leq 800$  MHz) and inside waveguide using analytical field distributions based on power measurements for  $f > 800$  MHz. The same setups are used for assessment of the parameters applied for boundary compensation (alpha, depth) of which typical uncertainty values are given. These parameters are used in DASY4 software to improve probe accuracy close to the boundary. The sensitivity in TSL corresponds to NORM<sub>x,y,z</sub> \* ConvF whereby the uncertainty corresponds to that given for ConvF. A frequency dependent ConvF is used in DASY version 4.4 and higher which allows extending the validity from  $\pm 50$  MHz to  $\pm 100$  MHz.
- Spherical isotropy (3D deviation from isotropy)**: in a field of low gradients realized using a flat phantom exposed by a patch antenna.
- Sensor Offset**: The sensor offset corresponds to the offset of virtual measurement center from the probe tip (on probe axis). No tolerance required.
- Connector Angle**: The angle is assessed using the information gained by determining the NORM<sub>x</sub> (no uncertainty required).

# Probe EX3DV4

## SN:3697

Manufactured: April 22, 2009  
Calibrated: September 28, 2015

Calibrated for DASY/EASY Systems  
(Note: non-compatible with DASY2 system!)

## DASY/EASY - Parameters of Probe: EX3DV4 - SN:3697

### Basic Calibration Parameters

	Sensor X	Sensor Y	Sensor Z	Unc (k=2)
Norm ( $\mu\text{V}/(\text{V}/\text{m})^2$ ) <sup>A</sup>	0.35	0.38	0.34	$\pm 10.1 \%$
DCP (mV) <sup>B</sup>	101.2	102.4	103.9	

### Modulation Calibration Parameters

UID	Communication System Name		A dB	B dB $\sqrt{\mu\text{V}}$	C	D dB	VR mV	Unc <sup>E</sup> (k=2)
0	CW	X	0.0	0.0	1.0	0.00	130.2	$\pm 2.7 \%$
		Y	0.0	0.0	1.0		136.1	
		Z	0.0	0.0	1.0		124.8	

The reported uncertainty of measurement is stated as the standard uncertainty of measurement multiplied by the coverage factor  $k=2$ , which for a normal distribution corresponds to a coverage probability of approximately 95%.

<sup>A</sup> The uncertainties of Norm X,Y,Z do not affect the  $E^2$ -field uncertainty inside TSL (see Pages 5 and 6).

<sup>B</sup> Numerical linearization parameter: uncertainty not required.

<sup>E</sup> Uncertainty is determined using the max. deviation from linear response applying rectangular distribution and is expressed for the square of the field value.



## DASY/EASY - Parameters of Probe: EX3DV4 - SN:3697

### Calibration Parameter Determined in Head Tissue Simulating Media

f (MHz) <sup>C</sup>	Relative Permittivity <sup>F</sup>	Conductivity (S/m) <sup>F</sup>	ConvF X	ConvF Y	ConvF Z	Alpha <sup>G</sup>	Depth <sup>G</sup> (mm)	Unc (k=2)
750	41.9	0.89	9.13	9.13	9.13	0.26	1.12	± 12.0 %
835	41.5	0.90	8.76	8.76	8.76	0.19	1.51	± 12.0 %
900	41.5	0.97	8.56	8.56	8.56	0.19	1.55	± 12.0 %
1750	40.1	1.37	7.73	7.73	7.73	0.27	0.98	± 12.0 %
1900	40.0	1.40	7.47	7.47	7.47	0.34	0.88	± 12.0 %
2450	39.2	1.80	6.75	6.75	6.75	0.37	0.80	± 12.0 %

<sup>C</sup> Frequency validity above 300 MHz of ± 100 MHz only applies for DASY v4.4 and higher (see Page 2), else it is restricted to ± 50 MHz. The uncertainty is the RSS of the ConvF uncertainty at calibration frequency and the uncertainty for the indicated frequency band. Frequency validity below 300 MHz is ± 10, 25, 40, 50 and 70 MHz for ConvF assessments at 30, 64, 128, 150 and 220 MHz respectively. Above 5 GHz frequency validity can be extended to ± 110 MHz.

<sup>F</sup> At frequencies below 3 GHz, the validity of tissue parameters ( $\epsilon$  and  $\sigma$ ) can be relaxed to ± 10% if liquid compensation formula is applied to measured SAR values. At frequencies above 3 GHz, the validity of tissue parameters ( $\epsilon$  and  $\sigma$ ) is restricted to ± 5%. The uncertainty is the RSS of the ConvF uncertainty for indicated target tissue parameters.

<sup>G</sup> Alpha/Depth are determined during calibration. SPEAG warrants that the remaining deviation due to the boundary effect after compensation is always less than ± 1% for frequencies below 3 GHz and below ± 2% for frequencies between 3-6 GHz at any distance larger than half the probe tip diameter from the boundary.

## DASY/EASY - Parameters of Probe: EX3DV4 - SN:3697

### Calibration Parameter Determined in Body Tissue Simulating Media

f (MHz) <sup>C</sup>	Relative Permittivity <sup>F</sup>	Conductivity (S/m) <sup>F</sup>	ConvF X	ConvF Y	ConvF Z	Alpha <sup>G</sup>	Depth <sup>G</sup> (mm)	Unc (k=2)
750	55.5	0.96	8.96	8.96	8.96	0.30	1.17	± 12.0 %
835	55.2	0.97	8.90	8.90	8.90	0.36	1.03	± 12.0 %
1750	53.4	1.49	7.34	7.34	7.34	0.42	0.80	± 12.0 %
1900	53.3	1.52	7.17	7.17	7.17	0.42	0.87	± 12.0 %
2450	52.7	1.95	6.90	6.90	6.90	0.42	0.85	± 12.0 %

<sup>C</sup> Frequency validity above 300 MHz of ± 100 MHz only applies for DASY v4.4 and higher (see Page 2), else it is restricted to ± 50 MHz. The uncertainty is the RSS of the ConvF uncertainty at calibration frequency and the uncertainty for the indicated frequency band. Frequency validity below 300 MHz is ± 10, 25, 40, 50 and 70 MHz for ConvF assessments at 30, 64, 128, 150 and 220 MHz respectively. Above 5 GHz frequency validity can be extended to ± 110 MHz.

<sup>F</sup> At frequencies below 3 GHz, the validity of tissue parameters ( $\epsilon$  and  $\sigma$ ) can be relaxed to ± 10% if liquid compensation formula is applied to measured SAR values. At frequencies above 3 GHz, the validity of tissue parameters ( $\epsilon$  and  $\sigma$ ) is restricted to ± 5%. The uncertainty is the RSS of the ConvF uncertainty for indicated target tissue parameters.

<sup>G</sup> Alpha/Depth are determined during calibration. SPEAG warrants that the remaining deviation due to the boundary effect after compensation is always less than ± 1% for frequencies below 3 GHz and below ± 2% for frequencies between 3-6 GHz at any distance larger than half the probe tip diameter from the boundary.

### Frequency Response of E-Field (TEM-Cell: ifi110 EXX, Waveguide: R22)

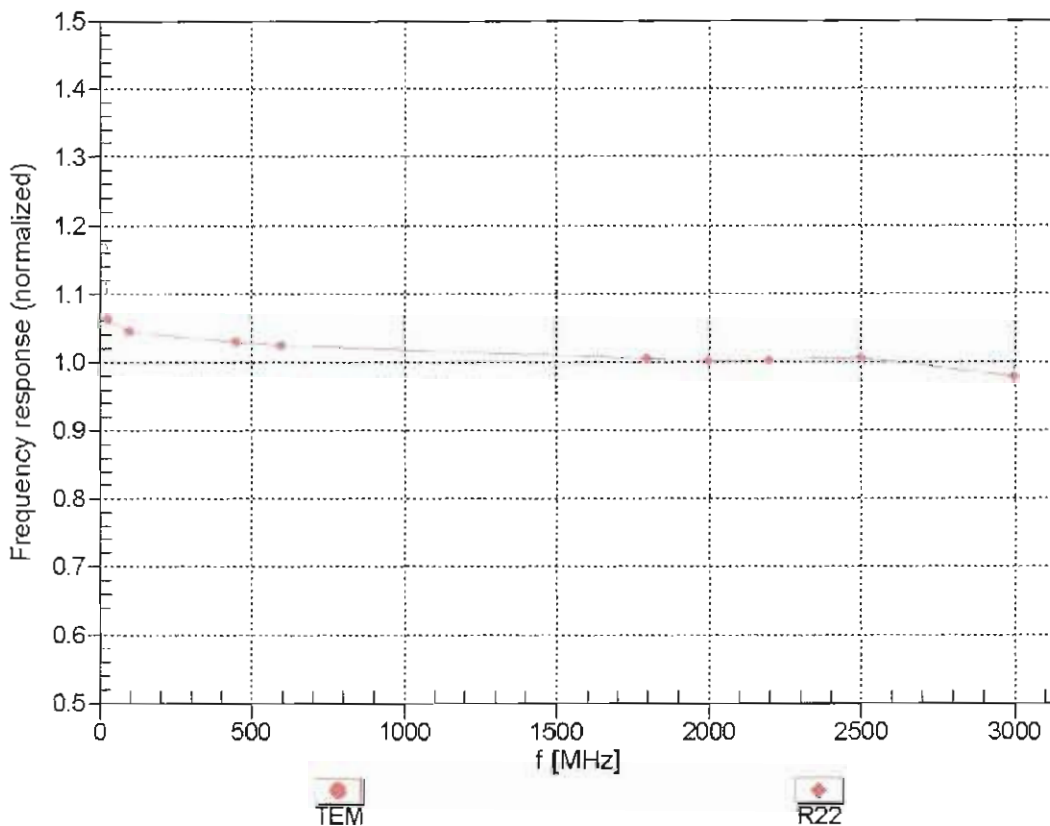

Uncertainty of Frequency Response of E-field:  $\pm 6.3\%$  (k=2)

### Receiving Pattern ( $\phi$ ), $\theta = 0^\circ$

f=600 MHz,TEM

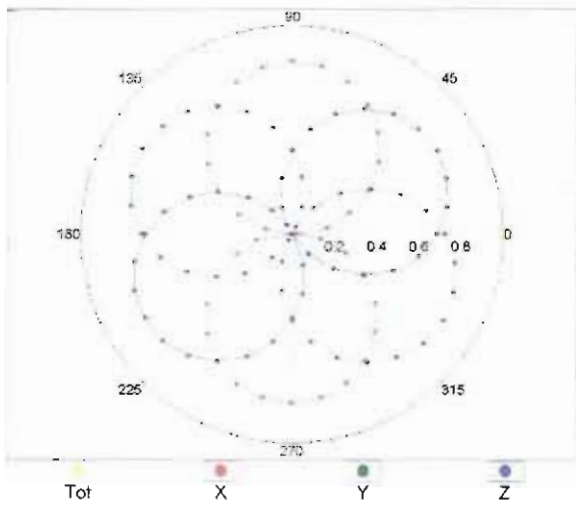

f=1800 MHz,R22

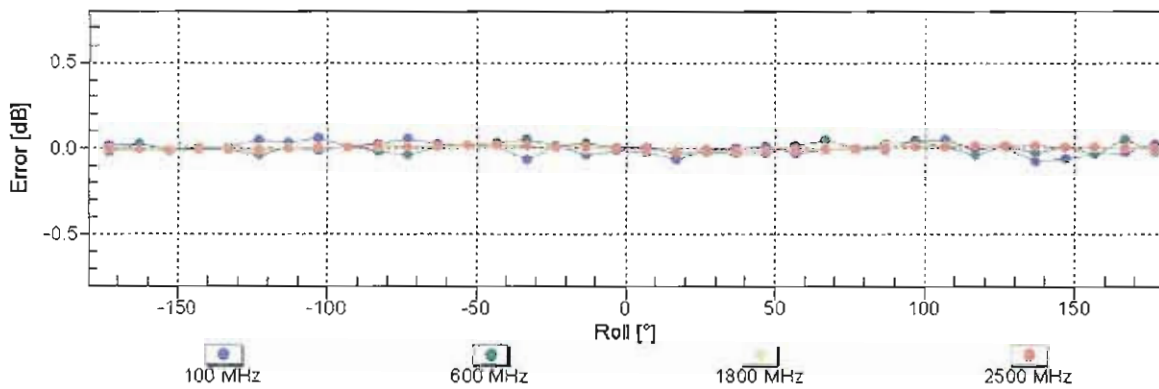
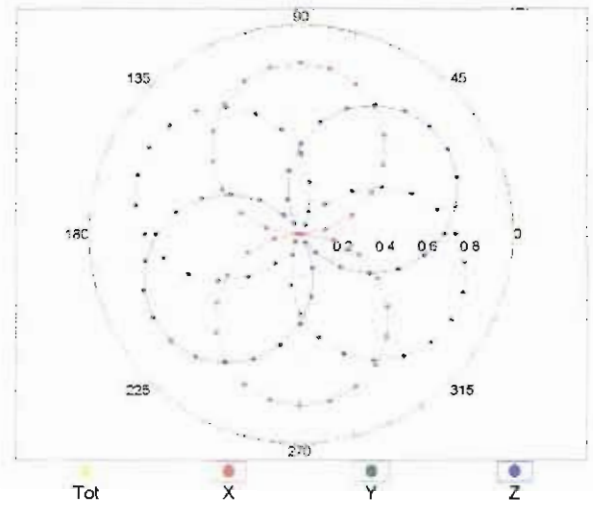

Uncertainty of Axial Isotropy Assessment:  $\pm 0.5\%$  (k=2)

### Dynamic Range $f(\text{SAR}_{\text{head}})$ (TEM cell , $f_{\text{eval}}= 1900 \text{ MHz}$ )

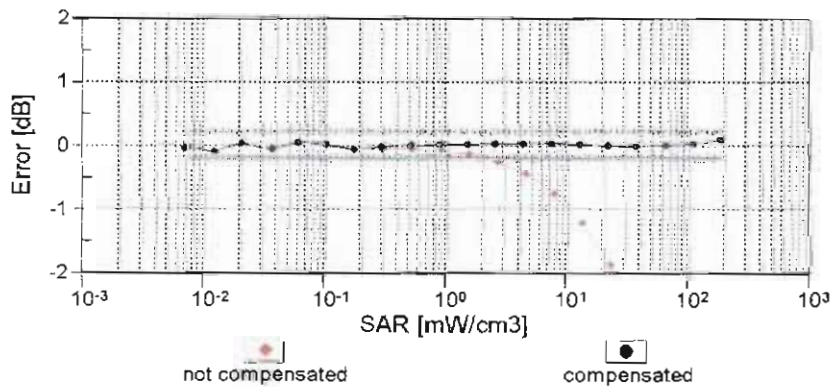
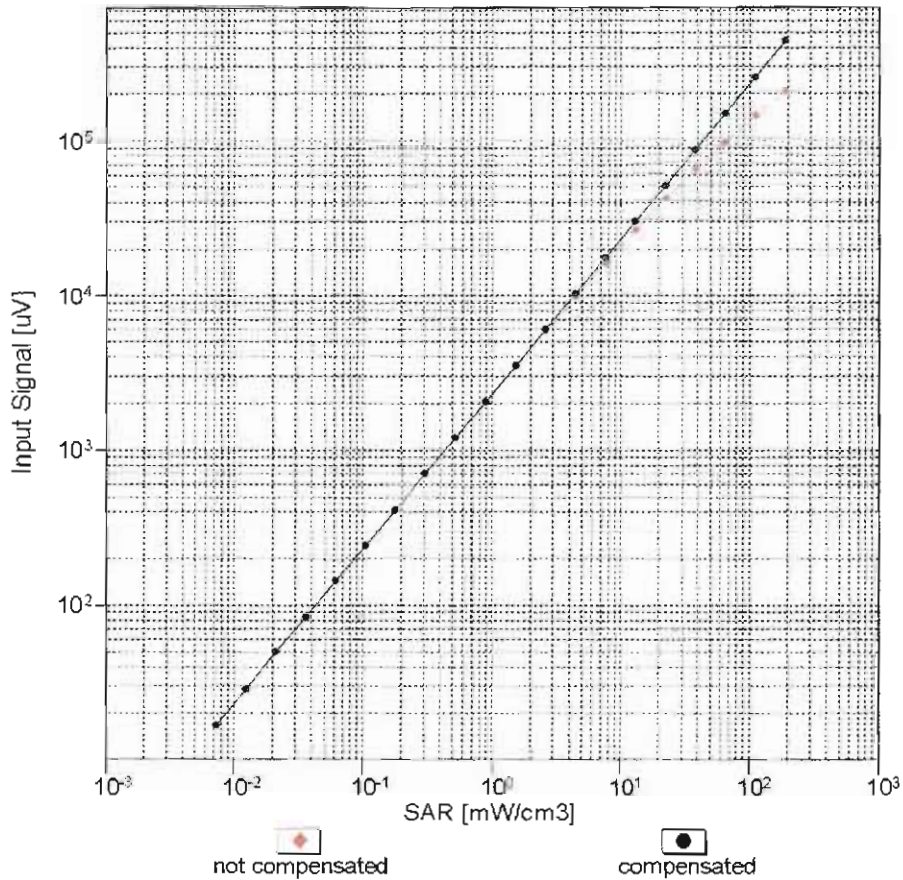

**Uncertainty of Linearity Assessment:  $\pm 0.6\%$  ( $k=2$ )**

## Conversion Factor Assessment

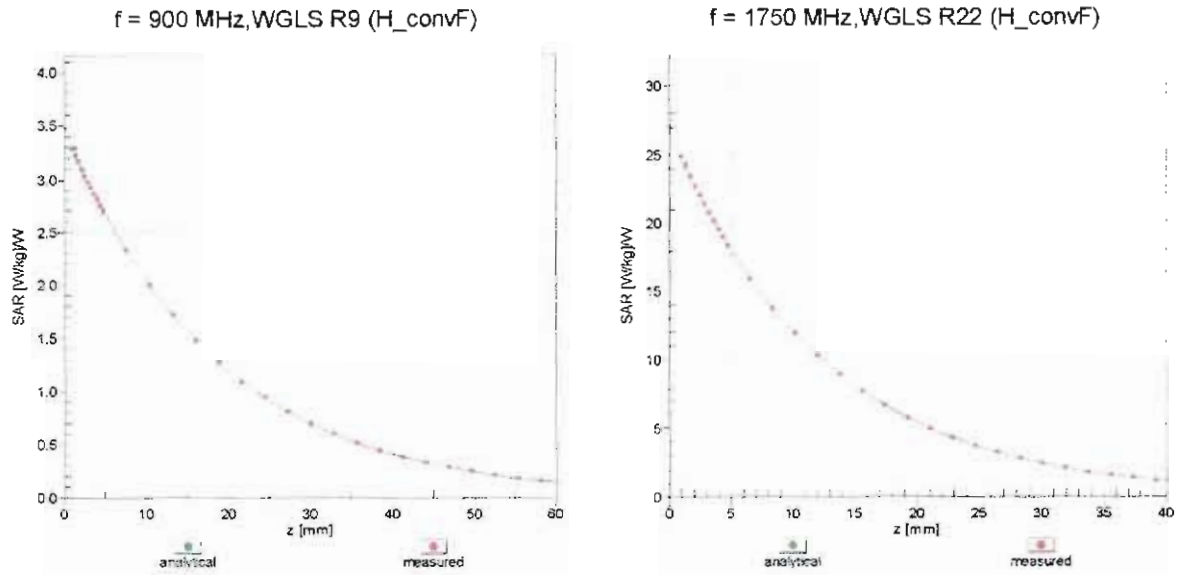

## Deviation from Isotropy in Liquid

Error ( $\phi$ ,  $\theta$ ), f = 900 MHz

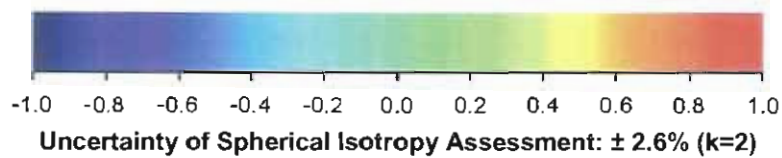
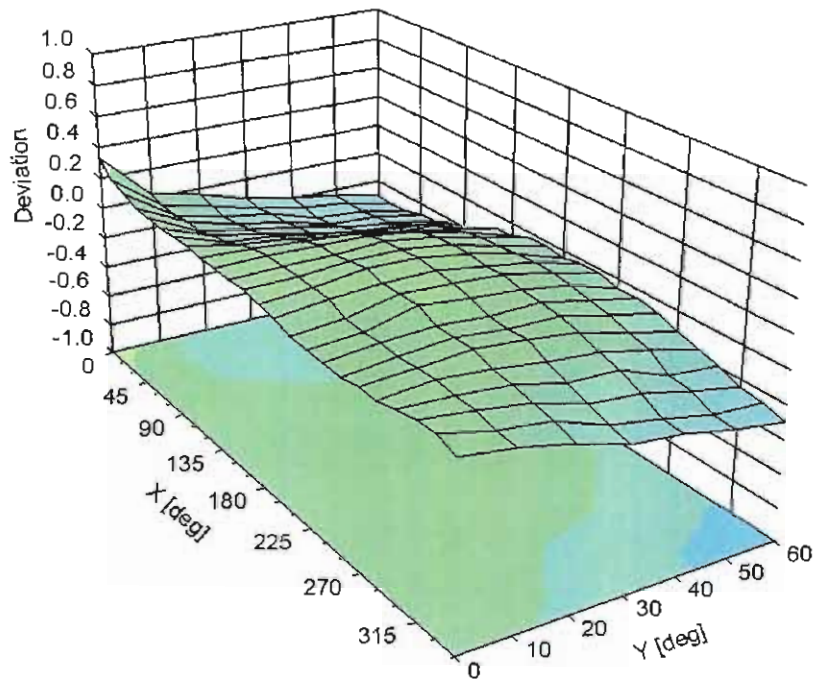

Uncertainty of Spherical Isotropy Assessment:  $\pm 2.6\%$  (k=2)

**DASY/EASY - Parameters of Probe: EX3DV4 - SN:3697****Other Probe Parameters**

Sensor Arrangement	Triangular
Connector Angle (°)	-23.3
Mechanical Surface Detection Mode	enabled
Optical Surface Detection Mode	disabled
Probe Overall Length	337 mm
Probe Body Diameter	10 mm
Tip Length	9 mm
Tip Diameter	2.5 mm
Probe Tip to Sensor X Calibration Point	1 mm
Probe Tip to Sensor Y Calibration Point	1 mm
Probe Tip to Sensor Z Calibration Point	1 mm
Recommended Measurement Distance from Surface	1.4 mm



Accredited by the Swiss Accreditation Service (SAS)  
The Swiss Accreditation Service is one of the signatories to the EA  
Multilateral Agreement for the recognition of calibration certificates

Accreditation No.: SCS 0108

Client **Auden**

Certificate No: **EX3-3578\_Mar15**

## CALIBRATION CERTIFICATE

Object **EX3DV4 - SN:3578**

Calibration procedure(s) **QA CAL-01.v9, QA CAL-14.v4, QA CAL-23.v5, QA CAL-25.v6  
Calibration procedure for dosimetric E-field probes**

Calibration date: **March 31, 2015**

This calibration certificate documents the traceability to national standards, which realize the physical units of measurements (SI).  
The measurements and the uncertainties with confidence probability are given on the following pages and are part of the certificate.

All calibrations have been conducted in the closed laboratory facility: environment temperature ( $22 \pm 3$ )°C and humidity < 70%.

Calibration Equipment used (M&TE critical for calibration)

Primary Standards	ID	Cal Date (Certificate No.)	Scheduled Calibration
Power meter E4419B	GB41293874	03-Apr-14 (No. 217-01911)	Apr-15
Power sensor E4412A	MY41498087	03-Apr-14 (No. 217-01911)	Apr-15
Reference 3 dB Attenuator	SN: S5054 (3c)	03-Apr-14 (No. 217-01915)	Apr-15
Reference 20 dB Attenuator	SN: S5277 (20x)	03-Apr-14 (No. 217-01919)	Apr-15
Reference 30 dB Attenuator	SN: S5129 (30b)	03-Apr-14 (No. 217-01920)	Apr-15
Reference Probe ES3DV2	SN: 3013	30-Dec-14 (No. ES3-3013_Dec14)	Dec-15
DAE4	SN: 660	14-Jan-15 (No. DAE4-660_Jan15)	Jan-16
Secondary Standards	ID	Check Date (in house)	Scheduled Check
RF generator HP 8648C	US3642U01700	4-Aug-99 (in house check Apr-13)	In house check: Apr-16
Network Analyzer HP 8753E	US37390585	18-Oct-01 (in house check Oct-14)	In house check: Oct-15

	Name	Function	Signature
Calibrated by:	Leif Klysner	Laboratory Technician	
Approved by:	Katja Pokovic	Technical Manager	
			Issued: April 1, 2015

This calibration certificate shall not be reproduced except in full without written approval of the laboratory.





Accredited by the Swiss Accreditation Service (SAS)  
The Swiss Accreditation Service is one of the signatories to the EA  
Multilateral Agreement for the recognition of calibration certificates

Accreditation No.: **SCS 0108**

**Glossary:**

TSL	tissue simulating liquid
NORM <sub>x,y,z</sub>	sensitivity in free space
ConvF	sensitivity in TSL / NORM <sub>x,y,z</sub>
DCP	diode compression point
CF	crest factor (1/duty_cycle) of the RF signal
A, B, C, D	modulation dependent linearization parameters
Polarization φ	φ rotation around probe axis
Polarization ϑ	ϑ rotation around an axis that is in the plane normal to probe axis (at measurement center), i.e., ϑ = 0 is normal to probe axis
Connector Angle	information used in DASY system to align probe sensor X to the robot coordinate system

**Calibration is Performed According to the Following Standards:**

- a) IEEE Std 1528-2013, "IEEE Recommended Practice for Determining the Peak Spatial-Averaged Specific Absorption Rate (SAR) in the Human Head from Wireless Communications Devices: Measurement Techniques", June 2013
- b) IEC 62209-1, "Procedure to measure the Specific Absorption Rate (SAR) for hand-held devices used in close proximity to the ear (frequency range of 300 MHz to 3 GHz)", February 2005

**Methods Applied and Interpretation of Parameters:**

- **NORM<sub>x,y,z</sub>**: Assessed for E-field polarization ϑ = 0 (f ≤ 900 MHz in TEM-cell; f > 1800 MHz: R22 waveguide). NORM<sub>x,y,z</sub> are only intermediate values, i.e., the uncertainties of NORM<sub>x,y,z</sub> does not affect the E<sup>2</sup>-field uncertainty inside TSL (see below *ConvF*).
- **NORM(f)<sub>x,y,z</sub>** = NORM<sub>x,y,z</sub> \* *frequency\_response* (see Frequency Response Chart). This linearization is implemented in DASY4 software versions later than 4.2. The uncertainty of the frequency response is included in the stated uncertainty of *ConvF*.
- **DCP<sub>x,y,z</sub>**: DCP are numerical linearization parameters assessed based on the data of power sweep with CW signal (no uncertainty required). DCP does not depend on frequency nor media.
- **PAR**: PAR is the Peak to Average Ratio that is not calibrated but determined based on the signal characteristics
- **A<sub>x,y,z</sub>; B<sub>x,y,z</sub>; C<sub>x,y,z</sub>; D<sub>x,y,z</sub>; VR<sub>x,y,z</sub>; A, B, C, D** are numerical linearization parameters assessed based on the data of power sweep for specific modulation signal. The parameters do not depend on frequency nor media. VR is the maximum calibration range expressed in RMS voltage across the diode.
- **ConvF and Boundary Effect Parameters**: Assessed in flat phantom using E-field (or Temperature Transfer Standard for f ≤ 800 MHz) and inside waveguide using analytical field distributions based on power measurements for f > 800 MHz. The same setups are used for assessment of the parameters applied for boundary compensation (alpha, depth) of which typical uncertainty values are given. These parameters are used in DASY4 software to improve probe accuracy close to the boundary. The sensitivity in TSL corresponds to NORM<sub>x,y,z</sub> \* *ConvF* whereby the uncertainty corresponds to that given for *ConvF*. A frequency dependent *ConvF* is used in DASY version 4.4 and higher which allows extending the validity from ± 50 MHz to ± 100 MHz.
- **Spherical isotropy (3D deviation from isotropy)**: in a field of low gradients realized using a flat phantom exposed by a patch antenna.
- **Sensor Offset**: The sensor offset corresponds to the offset of virtual measurement center from the probe tip (on probe axis). No tolerance required.
- **Connector Angle**: The angle is assessed using the information gained by determining the NORM<sub>x</sub> (no uncertainty required).

# Probe EX3DV4

## SN:3578

Manufactured:	November 4, 2005
Repaired:	March 25, 2015
Calibrated:	March 31, 2015

Calibrated for DASY/EASY Systems  
(Note: non-compatible with DASY2 system!)

## DASY/EASY - Parameters of Probe: EX3DV4 - SN:3578

### Basic Calibration Parameters

	Sensor X	Sensor Y	Sensor Z	Unc (k=2)
Norm ( $\mu\text{V}/(\text{V}/\text{m})^2$ ) <sup>A</sup>	0.44	0.38	0.44	$\pm 10.1\%$
DCP (mV) <sup>B</sup>	104.0	107.0	105.2	

### Modulation Calibration Parameters

UID	Communication System Name		A dB	B dB $\sqrt{\mu\text{V}}$	C	D dB	VR mV	Unc <sup>E</sup> (k=2)
0	CW	X	0.0	0.0	1.0	0.00	147.2	$\pm 2.7\%$
		Y	0.0	0.0	1.0		137.4	
		Z	0.0	0.0	1.0		130.3	

The reported uncertainty of measurement is stated as the standard uncertainty of measurement multiplied by the coverage factor  $k=2$ , which for a normal distribution corresponds to a coverage probability of approximately 95%.

<sup>A</sup> The uncertainties of Norm X, Y, Z do not affect the  $E^2$ -field uncertainty inside TSL (see Pages 5 and 6).

<sup>B</sup> Numerical linearization parameter: uncertainty not required.

<sup>E</sup> Uncertainty is determined using the max. deviation from linear response applying rectangular distribution and is expressed for the square of the field value.

## DASY/EASY - Parameters of Probe: EX3DV4 - SN:3578

### Calibration Parameter Determined in Head Tissue Simulating Media

f (MHz) <sup>C</sup>	Relative Permittivity <sup>F</sup>	Conductivity (S/m) <sup>F</sup>	ConvF X	ConvF Y	ConvF Z	Alpha <sup>G</sup>	Depth (mm) <sup>G</sup>	Unct. (k=2)
750	41.9	0.89	9.59	9.59	9.59	0.27	1.23	± 12.0 %
835	41.5	0.90	9.17	9.17	9.17	0.27	1.17	± 12.0 %
900	41.5	0.97	8.93	8.93	8.93	0.18	1.57	± 12.0 %
1450	40.5	1.20	8.26	8.26	8.26	0.41	0.80	± 12.0 %
1750	40.1	1.37	7.96	7.96	7.96	0.35	0.91	± 12.0 %
1900	40.0	1.40	7.77	7.77	7.77	0.42	0.82	± 12.0 %
2000	40.0	1.40	7.69	7.69	7.69	0.42	0.80	± 12.0 %
2300	39.5	1.67	7.41	7.41	7.41	0.31	0.91	± 12.0 %
2450	39.2	1.80	7.11	7.11	7.11	0.41	0.80	± 12.0 %
2600	39.0	1.96	6.90	6.90	6.90	0.35	0.97	± 12.0 %
5200	36.0	4.66	5.44	5.44	5.44	0.35	1.80	± 13.1 %
5300	35.9	4.76	5.30	5.30	5.30	0.35	1.80	± 13.1 %
5500	35.6	4.96	5.08	5.08	5.08	0.40	1.80	± 13.1 %
5600	35.5	5.07	4.99	4.99	4.99	0.40	1.80	± 13.1 %
5800	35.3	5.27	4.88	4.88	4.88	0.40	1.80	± 13.1 %

<sup>C</sup> Frequency validity above 300 MHz of ± 100 MHz only applies for DASY v4.4 and higher (see Page 2), else it is restricted to ± 50 MHz. The uncertainty is the RSS of the ConvF uncertainty at calibration frequency and the uncertainty for the indicated frequency band. Frequency validity below 300 MHz is ± 10, 25, 40, 50 and 70 MHz for ConvF assessments at 30, 64, 128, 150 and 220 MHz respectively. Above 5 GHz frequency validity can be extended to ± 110 MHz.

<sup>F</sup> At frequencies below 3 GHz, the validity of tissue parameters ( $\epsilon$  and  $\sigma$ ) can be relaxed to ± 10% if liquid compensation formula is applied to measured SAR values. At frequencies above 3 GHz, the validity of tissue parameters ( $\epsilon$  and  $\sigma$ ) is restricted to ± 5%. The uncertainty is the RSS of the ConvF uncertainty for indicated target tissue parameters.

<sup>G</sup> Alpha/Depth are determined during calibration. SPEAG warrants that the remaining deviation due to the boundary effect after compensation is always less than ± 1% for frequencies below 3 GHz and below ± 2% for frequencies between 3-6 GHz at any distance larger than half the probe tip diameter from the boundary.

## DASY/EASY - Parameters of Probe: EX3DV4 - SN:3578

### Calibration Parameter Determined in Body Tissue Simulating Media

f (MHz) <sup>C</sup>	Relative Permittivity <sup>F</sup>	Conductivity (S/m) <sup>F</sup>	ConvF X	ConvF Y	ConvF Z	Alpha <sup>G</sup>	Depth (mm) <sup>G</sup>	Unct. (k=2)
750	55.5	0.96	9.29	9.29	9.29	0.17	1.81	± 12.0 %
835	55.2	0.97	9.27	9.27	9.27	0.28	1.18	± 12.0 %
900	55.0	1.05	9.00	9.00	9.00	0.17	1.92	± 12.0 %
1450	54.0	1.30	8.37	8.37	8.37	0.32	1.14	± 12.0 %
1750	53.4	1.49	7.65	7.65	7.65	0.43	0.88	± 12.0 %
1900	53.3	1.52	7.28	7.28	7.28	0.45	0.80	± 12.0 %
2000	53.3	1.52	7.31	7.31	7.31	0.39	0.86	± 12.0 %
2300	52.9	1.81	7.09	7.09	7.09	0.41	0.80	± 12.0 %
2450	52.7	1.95	6.95	6.95	6.95	0.45	0.80	± 12.0 %
2600	52.5	2.16	6.69	6.69	6.69	0.40	0.80	± 12.0 %
5200	49.0	5.30	4.87	4.87	4.87	0.45	1.90	± 13.1 %
5300	48.9	5.42	4.65	4.65	4.65	0.45	1.90	± 13.1 %
5500	48.6	5.65	4.20	4.20	4.20	0.50	1.90	± 13.1 %
5600	48.5	5.77	4.15	4.15	4.15	0.50	1.90	± 13.1 %
5800	48.2	6.00	4.31	4.31	4.31	0.50	1.90	± 13.1 %

<sup>C</sup> Frequency validity above 300 MHz of ± 100 MHz only applies for DASY v4.4 and higher (see Page 2), else it is restricted to ± 50 MHz. The uncertainty is the RSS of the ConvF uncertainty at calibration frequency and the uncertainty for the indicated frequency band. Frequency validity below 300 MHz is ± 10, 25, 40, 50 and 70 MHz for ConvF assessments at 30, 64, 128, 150 and 220 MHz respectively. Above 5 GHz frequency validity can be extended to ± 110 MHz.

<sup>F</sup> At frequencies below 3 GHz, the validity of tissue parameters ( $\epsilon$  and  $\sigma$ ) can be relaxed to ± 10% if liquid compensation formula is applied to measured SAR values. At frequencies above 3 GHz, the validity of tissue parameters ( $\epsilon$  and  $\sigma$ ) is restricted to ± 5%. The uncertainty is the RSS of the ConvF uncertainty for indicated target tissue parameters.

<sup>G</sup> Alpha/Depth are determined during calibration. SPEAG warrants that the remaining deviation due to the boundary effect after compensation is always less than ± 1% for frequencies below 3 GHz and below ± 2% for frequencies between 3-6 GHz at any distance larger than half the probe tip diameter from the boundary.

# Frequency Response of E-Field

(TEM-Cell:ifi110 EXX, Waveguide: R22)

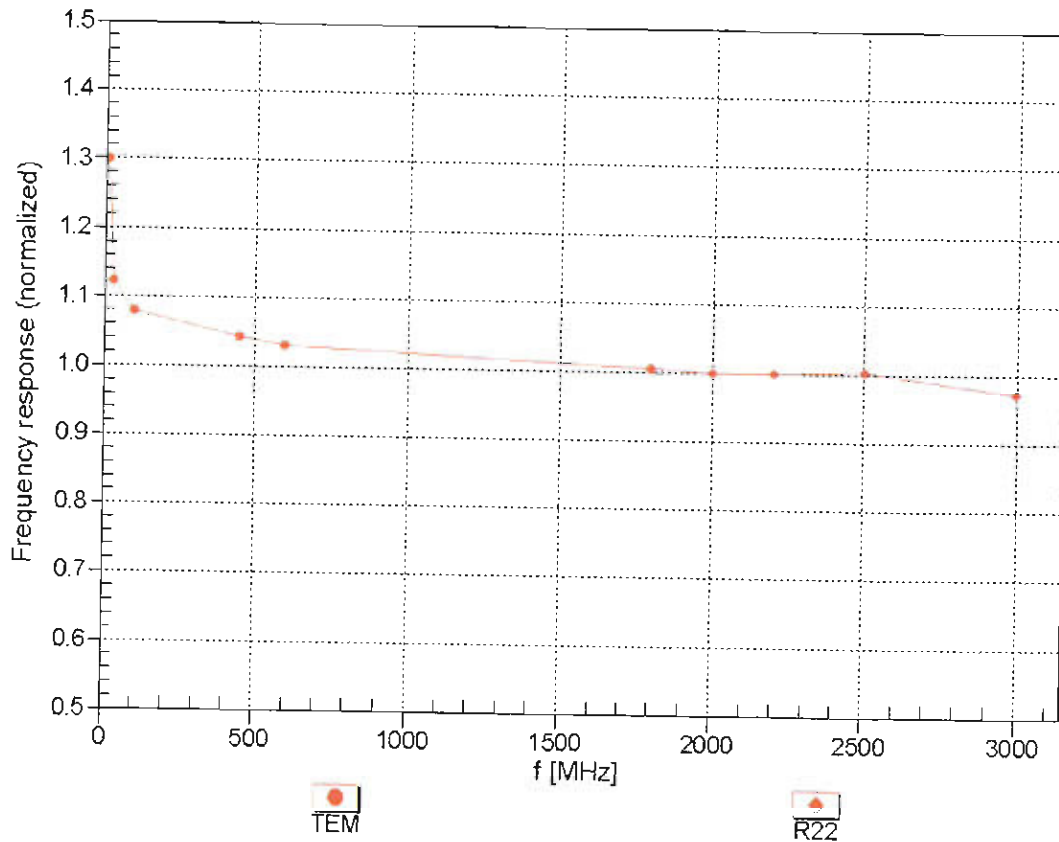

Uncertainty of Frequency Response of E-field:  $\pm 6.3\%$  (k=2)

### Receiving Pattern ( $\phi$ ), $\vartheta = 0^\circ$

f=600 MHz,TEM

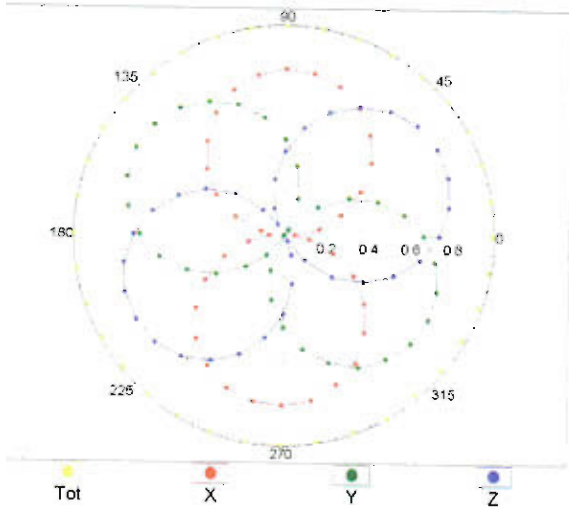

f=1800 MHz,R22

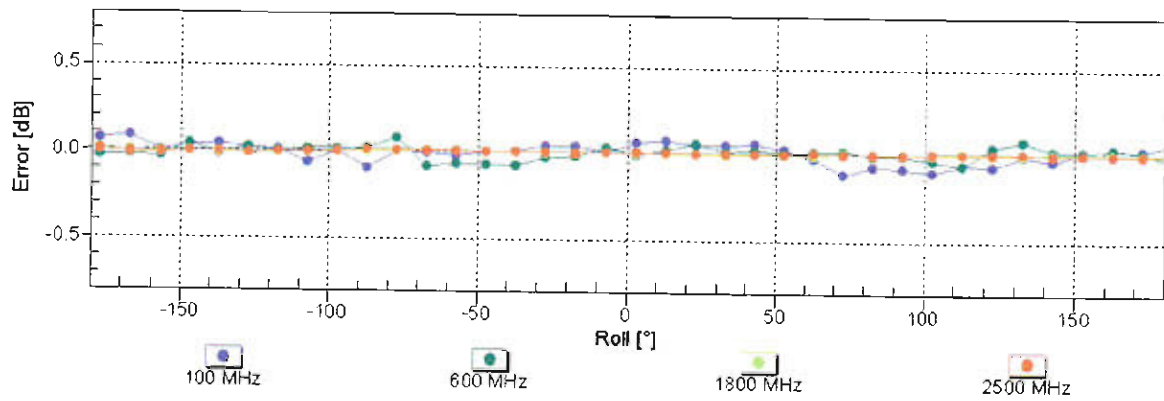
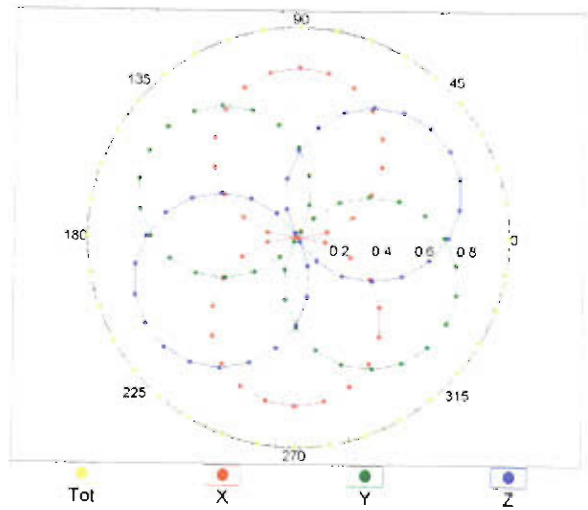

Uncertainty of Axial Isotropy Assessment:  $\pm 0.5\%$  ( $k=2$ )

### Dynamic Range $f(\text{SAR}_{\text{head}})$ (TEM cell , $f_{\text{eval}} = 1900 \text{ MHz}$ )

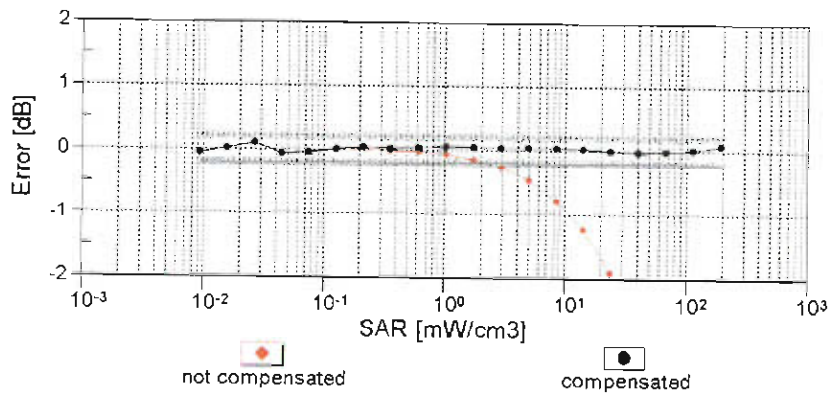
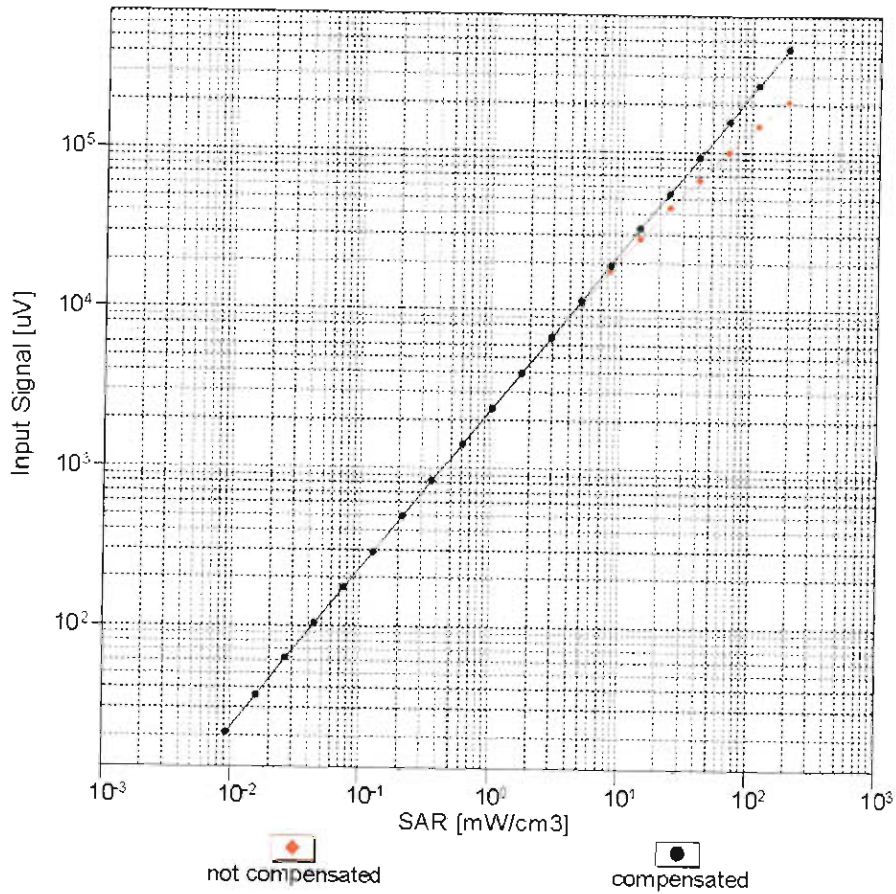

Uncertainty of Linearity Assessment:  $\pm 0.6\%$  ( $k=2$ )



# Conversion Factor Assessment

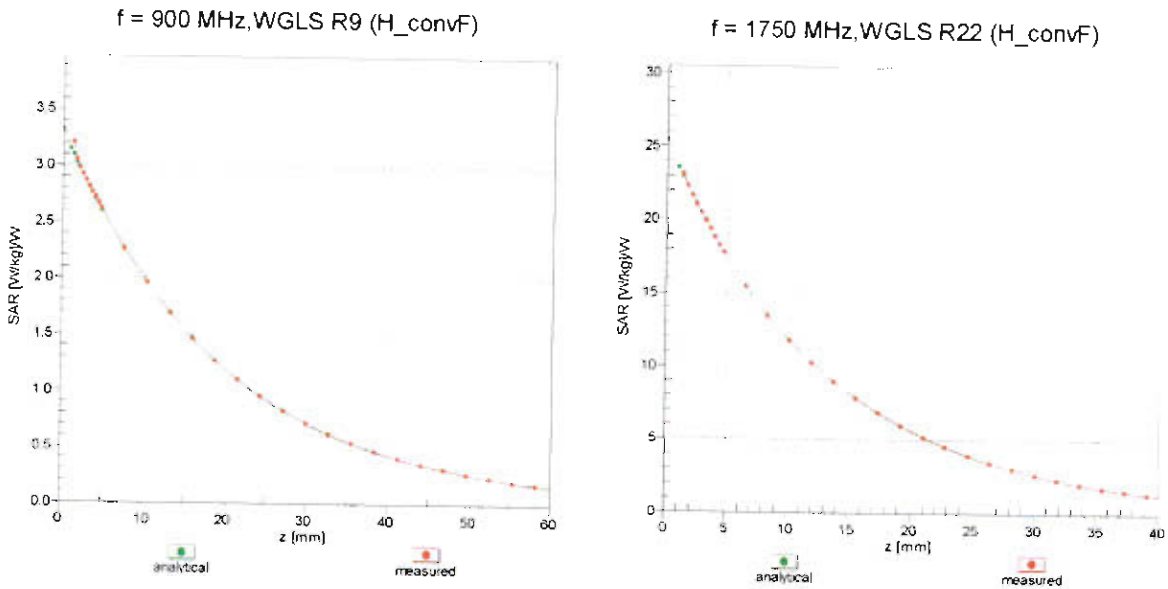

## Deviation from Isotropy in Liquid Error ( $\phi, \theta$ ), f = 900 MHz

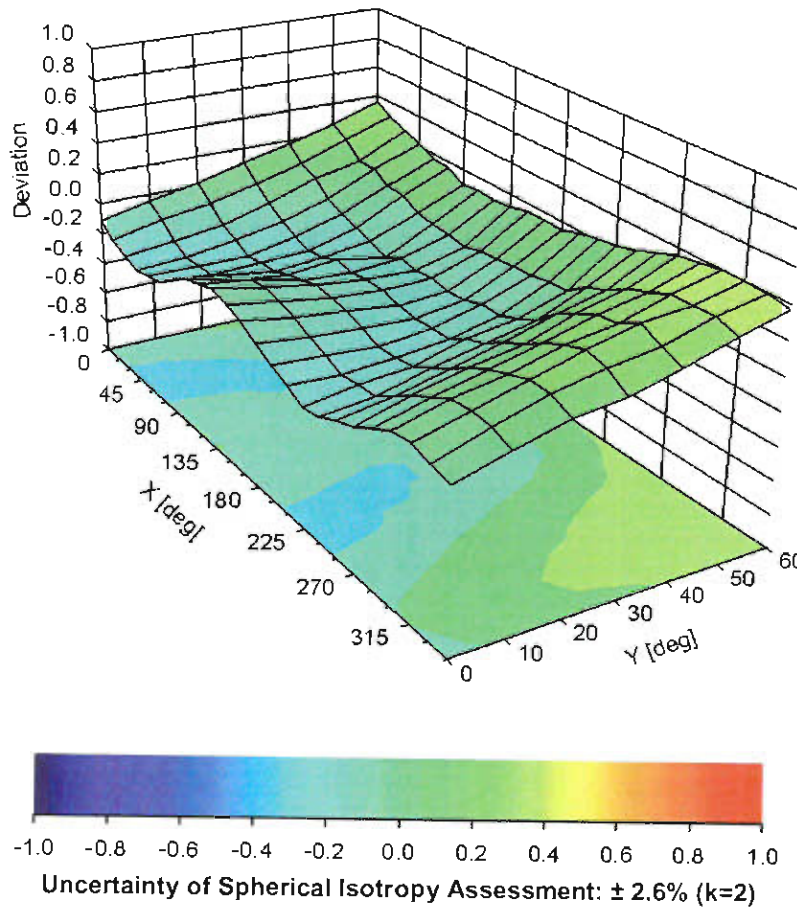

## DASY/EASY - Parameters of Probe: EX3DV4 - SN:3578

### Other Probe Parameters

Sensor Arrangement	Triangular
Connector Angle (°)	-17.3
Mechanical Surface Detection Mode	enabled
Optical Surface Detection Mode	disabled
Probe Overall Length	337 mm
Probe Body Diameter	10 mm
Tip Length	9 mm
Tip Diameter	2.5 mm
Probe Tip to Sensor X Calibration Point	1 mm
Probe Tip to Sensor Y Calibration Point	1 mm
Probe Tip to Sensor Z Calibration Point	1 mm
Recommended Measurement Distance from Surface	1.4 mm



Accredited by the Swiss Accreditation Service (SAS)  
The Swiss Accreditation Service is one of the signatories to the EA  
Multilateral Agreement for the recognition of calibration certificates

Accreditation No.: **SCS 0108**

Client **Sporton-TW (Auden)**

Certificate No: **ES3-3270\_Sep15**

## CALIBRATION CERTIFICATE

Object **ES3DV3 - SN:3270**

Calibration procedure(s) **QA CAL-01.v9, QA CAL-23.v5, QA CAL-25.v6  
Calibration procedure for dosimetric E-field probes**

Calibration date: **September 28, 2015**

This calibration certificate documents the traceability to national standards, which realize the physical units of measurements (SI).  
The measurements and the uncertainties with confidence probability are given on the following pages and are part of the certificate.

All calibrations have been conducted in the closed laboratory facility: environment temperature (22 ± 3)°C and humidity < 70%.

Calibration Equipment used (M&TE critical for calibration)

Primary Standards	ID	Cal Date (Certificate No.)	Scheduled Calibration
Power meter E4419B	GB41293874	01-Apr-15 (No. 217-02128)	Mar-16
Power sensor E4412A	MY41498087	01-Apr-15 (No. 217-02128)	Mar-16
Reference 3 dB Attenuator	SN: S5054 (3c)	01-Apr-15 (No. 217-02129)	Mar-16
Reference 20 dB Attenuator	SN: S5277 (20x)	01-Apr-15 (No. 217-02132)	Mar-16
Reference 30 dB Attenuator	SN: S5129 (30b)	01-Apr-15 (No. 217-02133)	Mar-16
Reference Probe ES3DV2	SN: 3013	30-Dec-14 (No. ES3-3013_Dec14)	Dec-15
DAE4	SN: 660	14-Jan-15 (No. DAE4-660_Jan15)	Jan-16
Secondary Standards	ID	Check Date (in house)	Scheduled Check
RF generator HP 8648C	US3642U01700	4-Aug-99 (in house check Apr-13)	In house check: Apr-16
Network Analyzer HP 8753E	US37390585	18-Oct-01 (in house check Oct-14)	In house check: Oct-15

	Name	Function	Signature
Calibrated by:	Israe Elnaouq	Laboratory Technician	
Approved by:	Katja Pokovic	Technical Manager	
			Issued: September 30, 2015
This calibration certificate shall not be reproduced except in full without written approval of the laboratory.			



Accredited by the Swiss Accreditation Service (SAS)

Accreditation No.: **SCS 0108**

The Swiss Accreditation Service is one of the signatories to the EA Multilateral Agreement for the recognition of calibration certificates

### Glossary:

TSL	tissue simulating liquid
NORM <sub>x,y,z</sub>	sensitivity in free space
ConvF	sensitivity in TSL / NORM <sub>x,y,z</sub>
DCP	diode compression point
CF	crest factor (1/duty_cycle) of the RF signal
A, B, C, D	modulation dependent linearization parameters
Polarization $\varphi$	$\varphi$ rotation around probe axis
Polarization $\vartheta$	$\vartheta$ rotation around an axis that is in the plane normal to probe axis (at measurement center), i.e., $\vartheta = 0$ is normal to probe axis
Connector Angle	information used in DASY system to align probe sensor X to the robot coordinate system

### Calibration is Performed According to the Following Standards:

- IEEE Std 1528-2013, "IEEE Recommended Practice for Determining the Peak Spatial-Averaged Specific Absorption Rate (SAR) in the Human Head from Wireless Communications Devices: Measurement Techniques", June 2013
- IEC 62209-1, "Procedure to measure the Specific Absorption Rate (SAR) for hand-held devices used in close proximity to the ear (frequency range of 300 MHz to 3 GHz)", February 2005
- IEC 62209-2, "Procedure to determine the Specific Absorption Rate (SAR) for wireless communication devices used in close proximity to the human body (frequency range of 30 MHz to 6 GHz)", March 2010
- KDB 865664, "SAR Measurement Requirements for 100 MHz to 6 GHz"

### Methods Applied and Interpretation of Parameters:

- NORM<sub>x,y,z</sub>**: Assessed for E-field polarization  $\vartheta = 0$  ( $f \leq 900$  MHz in TEM-cell;  $f > 1800$  MHz: R22 waveguide). NORM<sub>x,y,z</sub> are only intermediate values, i.e., the uncertainties of NORM<sub>x,y,z</sub> does not affect the E<sup>2</sup>-field uncertainty inside TSL (see below ConvF).
- NORM(f)<sub>x,y,z</sub>** = NORM<sub>x,y,z</sub> \* frequency\_response (see Frequency Response Chart). This linearization is implemented in DASY4 software versions later than 4.2. The uncertainty of the frequency response is included in the stated uncertainty of ConvF.
- DCP<sub>x,y,z</sub>**: DCP are numerical linearization parameters assessed based on the data of power sweep with CW signal (no uncertainty required). DCP does not depend on frequency nor media.
- PAR**: PAR is the Peak to Average Ratio that is not calibrated but determined based on the signal characteristics
- A<sub>x,y,z</sub>; B<sub>x,y,z</sub>; C<sub>x,y,z</sub>; D<sub>x,y,z</sub>; VR<sub>x,y,z</sub>**: A, B, C, D are numerical linearization parameters assessed based on the data of power sweep for specific modulation signal. The parameters do not depend on frequency nor media. VR is the maximum calibration range expressed in RMS voltage across the diode.
- ConvF and Boundary Effect Parameters**: Assessed in flat phantom using E-field (or Temperature Transfer Standard for  $f \leq 800$  MHz) and inside waveguide using analytical field distributions based on power measurements for  $f > 800$  MHz. The same setups are used for assessment of the parameters applied for boundary compensation (alpha, depth) of which typical uncertainty values are given. These parameters are used in DASY4 software to improve probe accuracy close to the boundary. The sensitivity in TSL corresponds to NORM<sub>x,y,z</sub> \* ConvF whereby the uncertainty corresponds to that given for ConvF. A frequency dependent ConvF is used in DASY version 4.4 and higher which allows extending the validity from  $\pm 50$  MHz to  $\pm 100$  MHz.
- Spherical isotropy (3D deviation from isotropy)**: in a field of low gradients realized using a flat phantom exposed by a patch antenna.
- Sensor Offset**: The sensor offset corresponds to the offset of virtual measurement center from the probe tip (on probe axis). No tolerance required.
- Connector Angle**: The angle is assessed using the information gained by determining the NORM<sub>x</sub> (no uncertainty required).

# Probe ES3DV3

## SN:3270

Manufactured: February 25, 2010  
Calibrated: September 28, 2015

Calibrated for DASY/EASY Systems  
(Note: non-compatible with DASY2 system!)

## DASY/EASY - Parameters of Probe: ES3DV3 - SN:3270

### Basic Calibration Parameters

	Sensor X	Sensor Y	Sensor Z	Unc (k=2)
Norm ( $\mu\text{V}/(\text{V}/\text{m})^2$ ) <sup>A</sup>	1.10	1.19	1.21	$\pm 10.1 \%$
DCP (mV) <sup>B</sup>	102.9	106.4	103.6	

### Modulation Calibration Parameters

UID	Communication System Name		A dB	B dB $\sqrt{\mu\text{V}}$	C	D dB	VR mV	Unc <sup>E</sup> (k=2)
0	CW	X	0.0	0.0	1.0	0.00	193.7	$\pm 3.0 \%$
		Y	0.0	0.0	1.0		212.5	
		Z	0.0	0.0	1.0		204.6	

The reported uncertainty of measurement is stated as the standard uncertainty of measurement multiplied by the coverage factor  $k=2$ , which for a normal distribution corresponds to a coverage probability of approximately 95%.

<sup>A</sup> The uncertainties of Norm X,Y,Z do not affect the  $E^2$ -field uncertainty inside TSL (see Pages 5 and 6).

<sup>B</sup> Numerical linearization parameter: uncertainty not required.

<sup>E</sup> Uncertainty is determined using the max. deviation from linear response applying rectangular distribution and is expressed for the square of the field value.

## DASY/EASY - Parameters of Probe: ES3DV3 - SN:3270

### Calibration Parameter Determined in Head Tissue Simulating Media

f (MHz) <sup>C</sup>	Relative Permittivity <sup>F</sup>	Conductivity (S/m) <sup>F</sup>	ConvF X	ConvF Y	ConvF Z	Alpha <sup>G</sup>	Depth <sup>G</sup> (mm)	Unc (k=2)
750	41.9	0.89	6.50	6.50	6.50	0.32	1.98	± 12.0 %
835	41.5	0.90	6.32	6.32	6.32	0.52	1.47	± 12.0 %
900	41.5	0.97	6.16	6.16	6.16	0.47	1.53	± 12.0 %
1750	40.1	1.37	5.32	5.32	5.32	0.71	1.25	± 12.0 %
1900	40.0	1.40	5.12	5.12	5.12	0.80	1.20	± 12.0 %
2000	40.0	1.40	5.12	5.12	5.12	0.60	1.38	± 12.0 %
2450	39.2	1.80	4.59	4.59	4.59	0.70	1.39	± 12.0 %
2600	39.0	1.96	4.44	4.44	4.44	0.73	1.37	± 12.0 %

<sup>C</sup> Frequency validity above 300 MHz of ± 100 MHz only applies for DASY v4.4 and higher (see Page 2), else it is restricted to ± 50 MHz. The uncertainty is the RSS of the ConvF uncertainty at calibration frequency and the uncertainty for the indicated frequency band. Frequency validity below 300 MHz is ± 10, 25, 40, 50 and 70 MHz for ConvF assessments at 30, 64, 128, 150 and 220 MHz respectively. Above 5 GHz frequency validity can be extended to ± 110 MHz.

<sup>F</sup> At frequencies below 3 GHz, the validity of tissue parameters ( $\epsilon$  and  $\sigma$ ) can be relaxed to ± 10% if liquid compensation formula is applied to measured SAR values. At frequencies above 3 GHz, the validity of tissue parameters ( $\epsilon$  and  $\sigma$ ) is restricted to ± 5%. The uncertainty is the RSS of the ConvF uncertainty for indicated target tissue parameters.

<sup>G</sup> Alpha/Depth are determined during calibration. SPEAG warrants that the remaining deviation due to the boundary effect after compensation is always less than ± 1% for frequencies below 3 GHz and below ± 2% for frequencies between 3-6 GHz at any distance larger than half the probe tip diameter from the boundary.

## DASY/EASY - Parameters of Probe: ES3DV3 - SN:3270

### Calibration Parameter Determined in Body Tissue Simulating Media

f (MHz) <sup>C</sup>	Relative Permittivity <sup>F</sup>	Conductivity (S/m) <sup>F</sup>	ConvF X	ConvF Y	ConvF Z	Alpha <sup>G</sup>	Depth <sup>G</sup> (mm)	Unc (k=2)
750	55.5	0.96	6.30	6.30	6.30	0.43	1.61	± 12.0 %
835	55.2	0.97	6.24	6.24	6.24	0.30	2.13	± 12.0 %
1750	53.4	1.49	4.95	4.95	4.95	0.64	1.38	± 12.0 %
1900	53.3	1.52	4.78	4.78	4.78	0.64	1.43	± 12.0 %
2450	52.7	1.95	4.37	4.37	4.37	0.80	1.24	± 12.0 %
2600	52.5	2.16	4.27	4.27	4.27	0.80	1.20	± 12.0 %

<sup>C</sup> Frequency validity above 300 MHz of ± 100 MHz only applies for DASY v4.4 and higher (see Page 2), else it is restricted to ± 50 MHz. The uncertainty is the RSS of the ConvF uncertainty at calibration frequency and the uncertainty for the indicated frequency band. Frequency validity below 300 MHz is ± 10, 25, 40, 50 and 70 MHz for ConvF assessments at 30, 64, 128, 150 and 220 MHz respectively. Above 5 GHz frequency validity can be extended to ± 110 MHz.

<sup>F</sup> At frequencies below 3 GHz, the validity of tissue parameters ( $\epsilon$  and  $\sigma$ ) can be relaxed to ± 10% if liquid compensation formula is applied to measured SAR values. At frequencies above 3 GHz, the validity of tissue parameters ( $\epsilon$  and  $\sigma$ ) is restricted to ± 5%. The uncertainty is the RSS of the ConvF uncertainty for indicated target tissue parameters.

<sup>G</sup> Alpha/Depth are determined during calibration. SPEAG warrants that the remaining deviation due to the boundary effect after compensation is always less than ± 1% for frequencies below 3 GHz and below ± 2% for frequencies between 3-6 GHz at any distance larger than half the probe tip diameter from the boundary.



## Frequency Response of E-Field (TEM-Cell:ifi110 EXX, Waveguide: R22)

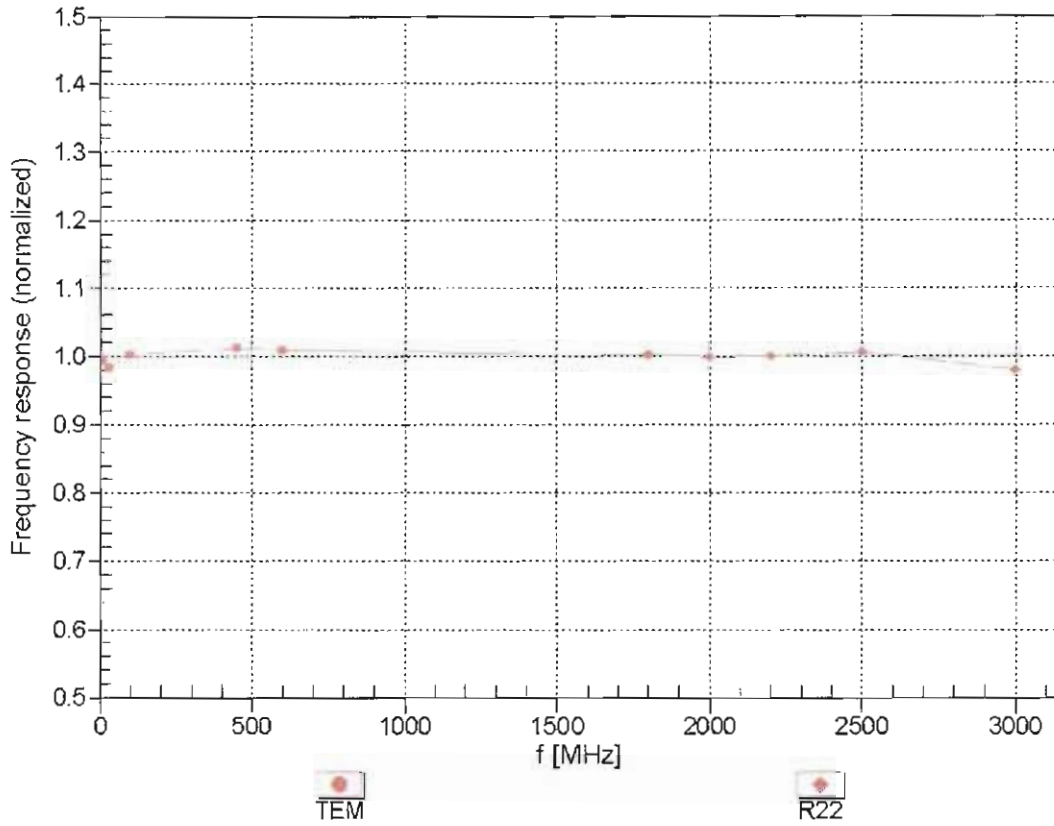

Uncertainty of Frequency Response of E-field:  $\pm 6.3\%$  (k=2)

### Receiving Pattern ( $\phi$ ), $\theta = 0^\circ$

f=600 MHz,TEM

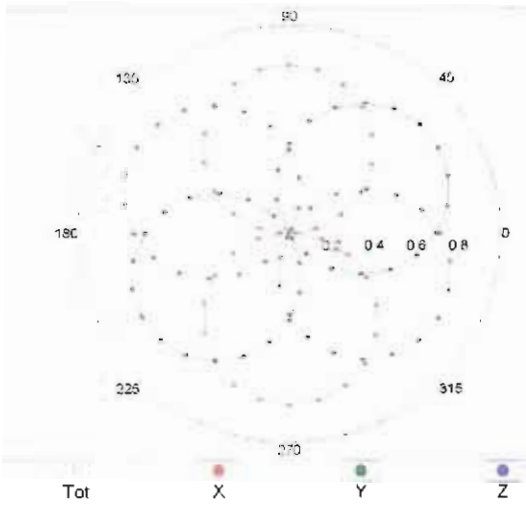

f=1800 MHz,R22

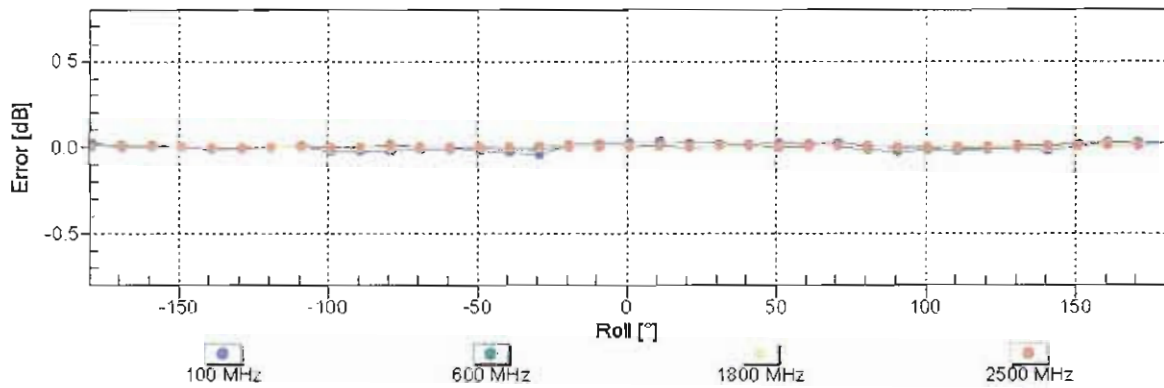
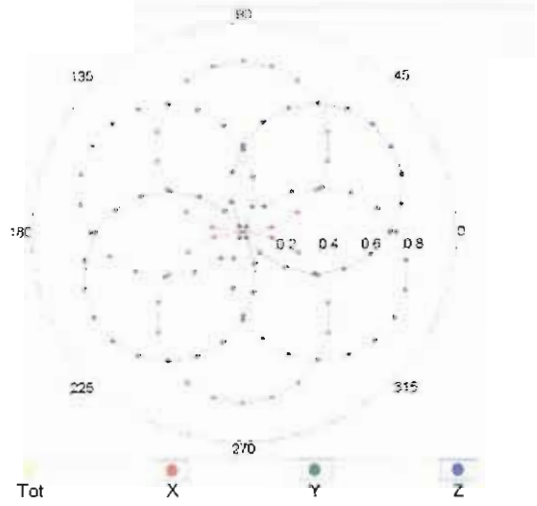

Uncertainty of Axial Isotropy Assessment:  $\pm 0.5\%$  (k=2)

### Dynamic Range $f(SAR_{head})$ (TEM cell , $f_{eval}= 1900$ MHz)

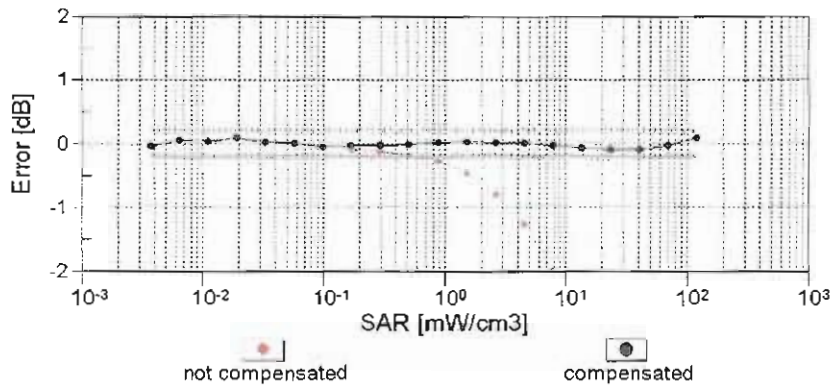
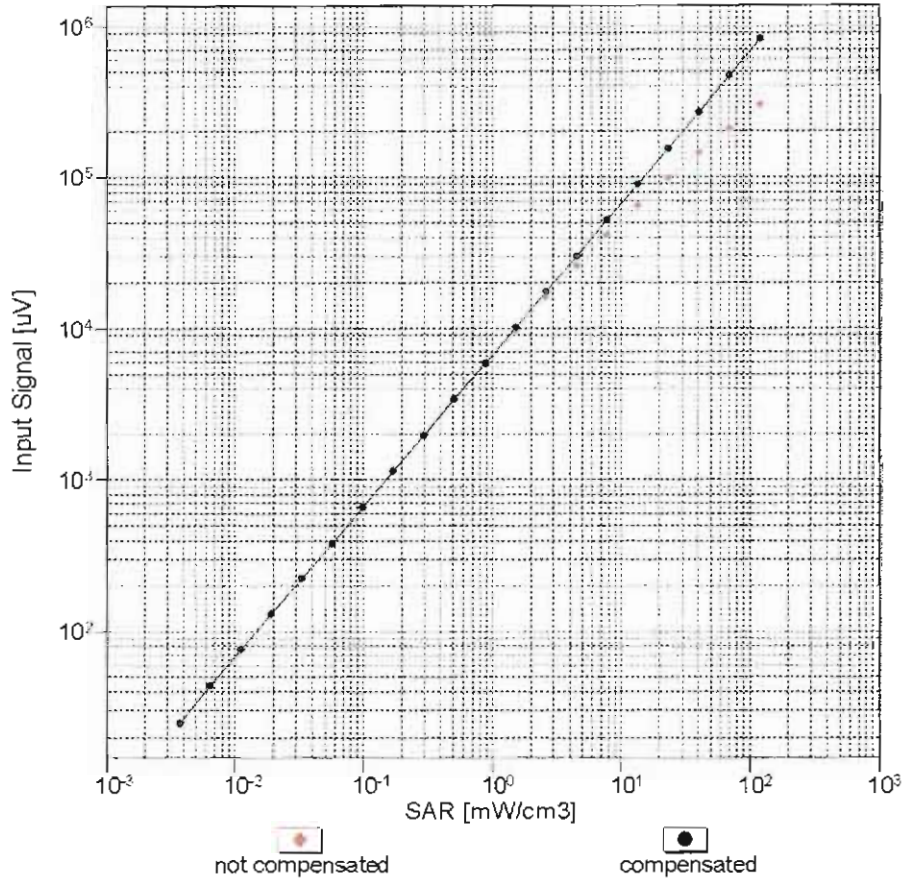

Uncertainty of Linearity Assessment:  $\pm 0.6\%$  ( $k=2$ )

# Conversion Factor Assessment

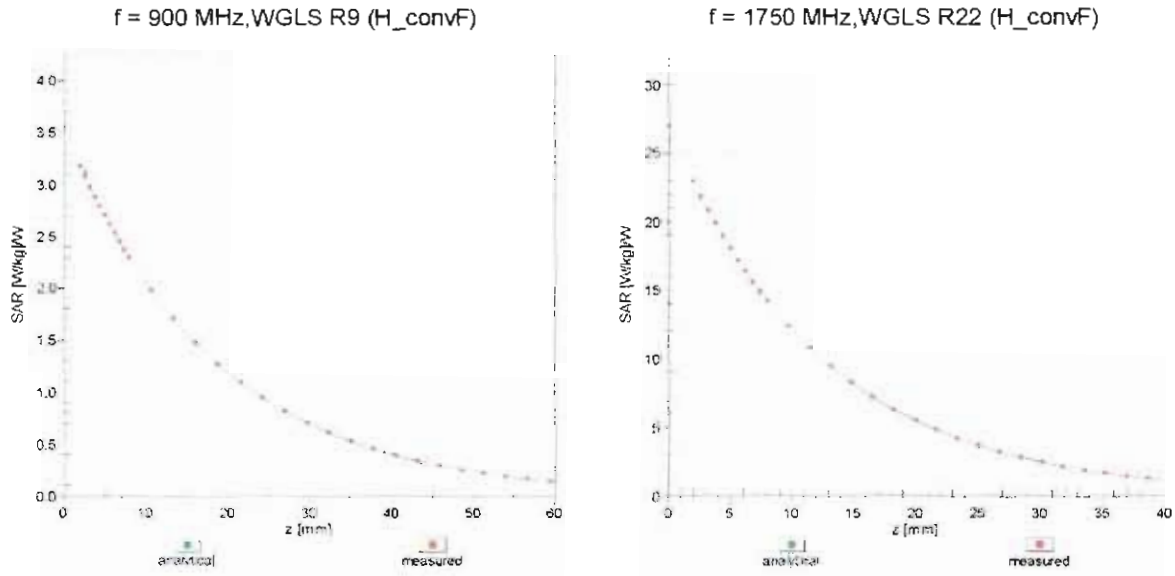

## Deviation from Isotropy in Liquid

Error ( $\phi, \theta$ ), f = 900 MHz

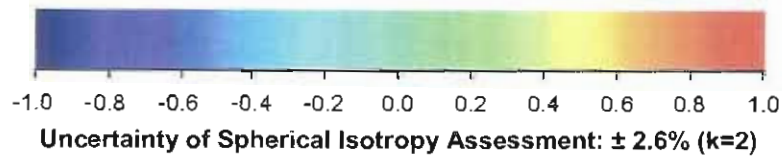
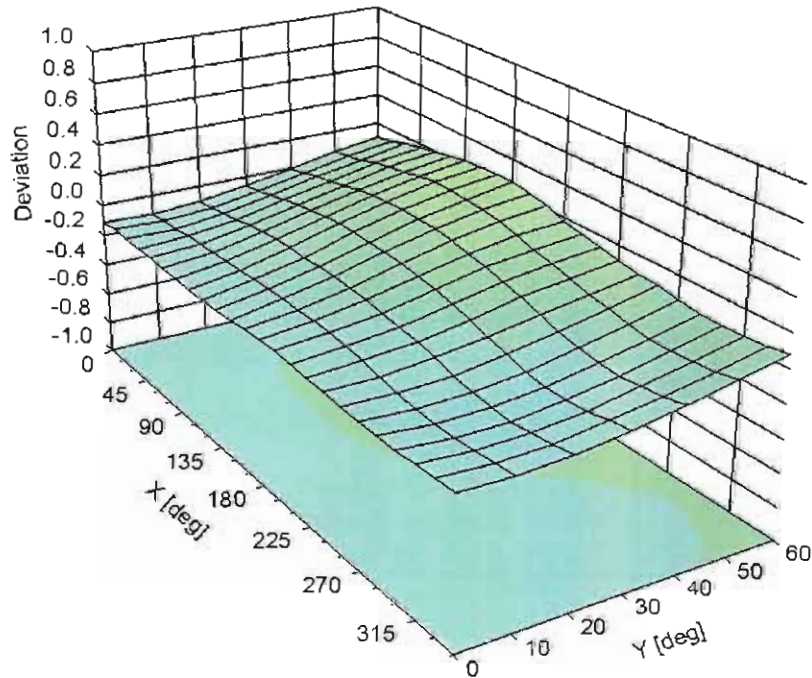

**DASY/EASY - Parameters of Probe: ES3DV3 - SN:3270****Other Probe Parameters**

Sensor Arrangement	Triangular
Connector Angle (°)	-18.7
Mechanical Surface Detection Mode	enabled
Optical Surface Detection Mode	disabled
Probe Overall Length	337 mm
Probe Body Diameter	10 mm
Tip Length	10 mm
Tip Diameter	4 mm
Probe Tip to Sensor X Calibration Point	2 mm
Probe Tip to Sensor Y Calibration Point	2 mm
Probe Tip to Sensor Z Calibration Point	2 mm
Recommended Measurement Distance from Surface	3 mm