

FCC SAR Test Report

APPLICANT : Wistron Corporation
EQUIPMENT : Tablet PC
BRAND NAME : Lenovo
MODEL NAME : TP00082A
FCC ID : PU5-TP00082ASI
STANDARD : FCC 47 CFR Part 2 (2.1093)
ANSI/IEEE C95.1-1992
IEEE 1528-2013

Equipment: Sierra Wireless EM7455 and Intel 8265D2W tested inside of Lenovo Tablet PC

We, SPORTON INTERNATIONAL INC., would like to declare that the tested sample has been evaluated in accordance with the procedures and had been in compliance with the applicable technical standards.

The test results in this report apply exclusively to the tested model / sample. Without written approval of SPORTON INTERNATIONAL INC., the test report shall not be reproduced except in full.

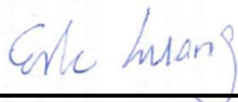

Reviewed by: Eric Huang / Deputy Manager



Approved by: Jones Tsai / Manager



SPORTON INTERNATIONAL INC.

No.52, Hwa Ya 1st Rd., Hwa Ya Technology Park, Kwei-Shan District, Taoyuan City, Taiwan (R.O.C.)



Table of Contents

1. Statement of Compliance 4
2. Administration Data 5
3. Guidance Applied..... 5
3.1 Re-use of Measured Data 6
4. Equipment Under Test (EUT) Information 7
4.1 General Information 7
4.2 General LTE SAR Test and Reporting Considerations 9
5. RF Exposure Limits.....11
5.1 Uncontrolled Environment 11
5.2 Controlled Environment..... 11
6. Specific Absorption Rate (SAR).....12
6.1 Introduction 12
6.2 SAR Definition..... 12
7. System Description and Setup13
7.1 E-Field Probe 14
7.2 Data Acquisition Electronics (DAE) 14
7.3 Phantom..... 15
7.4 Device Holder..... 16
8. Measurement Procedures17
8.1 Spatial Peak SAR Evaluation 17
8.2 Power Reference Measurement..... 18
8.3 Area Scan 18
8.4 Zoom Scan..... 19
8.5 Volume Scan Procedures 19
8.6 Power Drift Monitoring..... 19
9. Test Equipment List20
10. System Verification21
10.1 Tissue Simulating Liquids..... 21
10.2 Tissue Verification 22
10.3 System Performance Check Results..... 23
11. RF Exposure Positions23
11.1 SAR Testing for Tablet 23
12. Conducted RF Output Power (Unit: dBm).....24
13. SAR test exclusion table70
14. SAR Test Results71
14.1 Spot check of WWAN SAR 72
14.2 Body SAR 73
14.3 Repeated SAR Measurement 74
15. Simultaneous Transmission Analysis75
15.1 Body Exposure Conditions 76
15.2 SPLSR Evaluation and Analysis..... 82
16. Uncertainty Assessment119
17. References122
Appendix A. Plots of System Performance Check
Appendix B. Plots of High SAR Measurement
Appendix C. DASy Calibration Certificate
Appendix D. Reference Report
Appendix E. Test Setup Photos



Revision History

REPORT NO.	VERSION	DESCRIPTION	ISSUED DATE
FA5N2711-08	Rev. 01	Initial issue of report	Nov. 18, 2016



1. Statement of Compliance

The maximum results of Specific Absorption Rate (SAR) found during testing for Wistron Corporation, Tablet PC, TP00082A, are as follows.

Equipment Class	Frequency Band	Highest SAR Summary		Highest Simultaneous Transmission 1g SAR (W/kg)
		Body	1g SAR (W/kg)	
Licensed	WCDMA II		1.02	1.59
	WCDMA IV		1.30	
	WCDMA V		1.19	
	LTE Band 4		1.29	
	LTE Band 7		1.26	
	LTE Band 12		1.02	
	LTE Band 13		1.23	
	LTE Band 2 / 25		1.11	
	LTE Band 5 / 26		1.09	
	LTE Band 41		1.27	
DTS	2.4GHz WLAN		0.98	1.59
NII	5GHz WLAN		1.18	1.59
DSS	Bluetooth		0.09	1.59
Date of Testing:			2016/9/22 ~ 2016/10/18	
Remark : 1. LTE band 2 / 5 SAR test was covered by Band 25 / 26; according to April 2015 TCB workshop, SAR test for overlapping LTE bands can be reduced if <ol style="list-style-type: none"> the maximum output power, including tolerance, for the smaller band is ≤ the larger band to qualify for the SAR test exclusion the channel bandwidth and other operating parameters for the smaller band are fully supported by the larger band 				

This device is in compliance with Specific Absorption Rate (SAR) for general population/uncontrolled exposure limits (1.6 W/kg) specified in FCC 47 CFR part 2 (2.1093) and ANSI/IEEE C95.1-1992, and had been tested in accordance with the measurement methods and procedures specified in IEEE 1528-2013 and FCC KDB publications

2. Administration Data

Testing Laboratory	
Test Site	SPORTON INTERNATIONAL INC.
Test Site Location	No.52, Hwa Ya 1st Rd., Hwa Ya Technology Park, Kwei-Shan District, Taoyuan City, Taiwan (R.O.C.) TEL: +886-3-327-3456 FAX: +886-3-328-4978

Applicant	
Company Name	Wistron Corporation
Address	21F, No. 88, Sec. 1, Hsin Tai Wu Rd., Hsichih Dist, New Taipei City 221, Taiwan R.O.C.

Manufacturer	
Company Name	Wistron Corporation
Address	21F, No. 88, Sec. 1, Hsin Tai Wu Rd., Hsichih Dist, New Taipei City 221, Taiwan R.O.C.

3. Guidance Applied

The Specific Absorption Rate (SAR) testing specification, method, and procedure for this device is in accordance with the following standards:

- FCC 47 CFR Part 2 (2.1093)
- ANSI/IEEE C95.1-1992
- IEEE 1528-2013
- FCC KDB 865664 D01 SAR Measurement 100 MHz to 6 GHz v01r04
- FCC KDB 865664 D02 SAR Reporting v01r02
- FCC KDB 447498 D01 General RF Exposure Guidance v06
- FCC KDB 248227 D01 802.11 Wi-Fi SAR v02r02
- FCC KDB 616217 D04 SAR for laptop and tablets v01r02
- FCC KDB 941225 D01 3G SAR Procedures v03r01
- FCC KDB 941225 D05 SAR for LTE Devices v02r05



3.1 Re-use of Measured Data

1. Introduction Section

This report referenced from the FCC ID: PU5-TP00082AUC
(WCDMA Band 2 / 4 / 5 and LTE Band 2 / 4 / 5 / 7 / 12 / 13 / 25 / 26 / 41)

And the applicant takes full responsibility that the test data as referenced in this report represent compliance for this FCC ID.

2. Difference Section

Both original devices and modified devices that only difference is WLAN module, therefore SAR data for WWAN from the original filling was used for this model. Sopt checks for WWAN were performed to ensure that the SAR measurement for both device are the same, for WLAN SAR is full test in this report.

The WWAN (WCDMA Band 2 / 4 / 5 and LTE Band 4 / 7 / 12 / 13 / 25 / 26 / 41) SAR measurement results from the original report (Sporton SAR Report No. FA5N2711-01, FCC ID: PU5-TP00082AUC) or appendix D. In this report, highest SAR summary and Sim-Tx analysis evaluation is select higher value of either original SAR result or spot checks SAR result.

3. Spot Check Verification Data Section

Band	BW (MHz)	Modulation	RB Size	RB offset	Mode	Test Position	Gap (mm)	Power Reduction	Ch.	Freq. (MHz)	Original Model (FCC ID : PU5-TP00082AUC)				Spot Check Mode (FCC ID : PU5- TP00082ASI)				Deviation
											Average Power (dBm)	Tune-Up Limit (dBm)	Measured 1g SAR (W/kg)	Reported 1g SAR (W/kg)	Average Power (dBm)	Tune-Up Limit (dBm)	Measured 1g SAR (W/kg)	Reported 1g SAR (W/kg)	
WCDMA II	-	-	-	-	RMC 12.2Kbps	Bottom Face	11mm	OFF	9262	1852.4	22.83	24.00	0.778	1.019	22.73	24.00	0.638	0.855	-16.1%
WCDMA IV	-	-	-	-	RMC 12.2Kbps	Bottom Face	11mm	OFF	1513	1752.6	22.76	24.00	0.975	1.297	22.66	24.00	0.821	1.118	-13.8%
WCDMA V	-	-	-	-	RMC 12.2Kbps	Bottom Face	0mm	ON	4182	836.4	20.00	21.50	0.804	1.136	20.19	21.50	0.879	1.188	4.6%
LTE Band 4	20M	QPSK	1	0	-	Edge 2	0mm	ON	20175	1732.5	16.61	17.50	1.050	1.289	16.96	17.50	0.914	1.035	-19.7%
LTE Band 7	20M	QPSK	1	0	-	Bottom Face	0mm	ON	21350	2560	17.40	18.00	1.100	1.263	16.99	18.00	0.946	1.194	-5.5%
LTE Band 12	10M	QPSK	1	0	-	Bottom Face	0mm	ON	23095	707.5	19.28	20.50	0.768	1.017	19.02	20.50	0.671	0.943	-7.2%
LTE Band 13	10M	QPSK	1	0	-	Bottom Face	0mm	ON	23230	782	19.84	21.00	0.942	1.230	20.06	21.00	0.961	1.193	-3.0%
LTE Band 25	20M	QPSK	1	0	-	Edge 2	0mm	ON	26140	1860	16.59	17.50	0.896	1.105	17.07	17.50	0.803	0.887	-19.8%
LTE Band 26	15M	QPSK	1	0	-	Bottom Face	0mm	ON	26865	831.5	19.90	21.00	0.803	1.034	20.02	21.00	0.870	1.090	5.4%
LTE Band 41	20M	QPSK	1	0	-	Bottom Face	0mm	ON	41055	2636.5	17.25	18.00	1.060	1.267	17.04	18.00	0.812	1.019	-19.6%

Note: In the table above, all the deviation of SAR test results are compliant with uncertainty budget.

4. Reference detail Section:

Equipment Class	Reference FCC ID	Folder Test/RF Exposure	Report Title/Section
PCB	PU5-TP00082AUC	RF Exposure (FA5N2711-01)	Sections related to WWAN test data



4. Equipment Under Test (EUT) Information

4.1 General Information

Product Feature & Specification	
Equipment Name	Tablet PC
Brand Name	Lenovo
Model Name	TP00082A
FCC ID	PU5-TP00082ASI
Integrated WWAN Module	Brand Name: Sierra Wireless Model Name: EM7455
Integrated WLAN Module	Brand Name: Intel Model Name: 8265D2W
IMEI Code	014583000192610
Wireless Technology and Frequency Range	WCDMA Band II: 1852.4 MHz ~ 1907.6 MHz WCDMA Band IV: 1712.4 MHz ~ 1752.6 MHz WCDMA Band V: 826.4 MHz ~ 846.6 MHz LTE Band 2: 1850 MHz ~ 1910 MHz LTE Band 4: 1710 MHz ~ 1755 MHz LTE Band 5: 824 MHz ~ 849 MHz LTE Band 7: 2500 MHz ~ 2570 MHz LTE Band 12: 699 MHz ~ 716 MHz LTE Band 13: 777 MHz ~ 787 MHz LTE Band 25: 1850 MHz ~ 1915 MHz LTE Band 26: 814 MHz ~ 849 MHz LTE Band 41: 2496 MHz ~ 2690 MHz WLAN 2.4GHz Band: 2412 MHz ~ 2472 MHz WLAN 5.2GHz Band: 5180 MHz ~ 5240 MHz WLAN 5.3GHz Band: 5260 MHz ~ 5320 MHz WLAN 5.5GHz Band: 5500 MHz ~ 5720 MHz WLAN 5.8GHz Band: 5745 MHz ~ 5825 MHz Bluetooth: 2402 MHz ~ 2480 MHz
Mode	· RMC 12.2Kbps · HSDPA · HSUPA · DC-HSDPA · LTE: QPSK, 16QAM · 802.11a/b/g/n/ac HT20/HT40/VHT20/VHT40/VHT80 · Bluetooth BR/EDR/LE/HS
EUT Stage	Production Unit
Remark :	1. This device has installed proximity sensor and relevant information please refer to the original report as Appendix D



WWAN Antenna Information		
Manufacturer	PULSE	
Parts Number	025.900FA.0001	
Ant. Type	Monopole	
Peak Gain (dBi)	UE-UTRA, Band 12	-0.90
	UE-UTRA, Band 13	-0.37
	UMTS 850, Band 5	-0.56
	UE-UTRA, Band 5	
	UE-UTRA, Band 26	-0.53
	UMTS, Band 4	3.11
	UE-UTRA, Band 4	
	UMTS1900, Band 2	3.01
	UE-UTRA, Band 2	
	UE-UTRA, Band 25	3.22
UE-UTRA, Band 7	-0.08	
UE-UTRA, Band 41	-0.19	

WLAN Antenna Information		
Manufacturer	PULSE	
Antenna Type	Main: dipole Antenna	Aux: dipole Antenna
Part number	025.900FC.0001	025.900FD.0001
Peak gain(dBi)	Main Antenna :	Aux Antenna :
	WLAN(2.4G):-0.82	WLAN(2.4G):1.39 BT :1.39
	WLAN(5G):2.31	WLAN(5G):3.13



4.2 General LTE SAR Test and Reporting Considerations

Summarized necessary items addressed in KDB 941225 D05 v02r05																																																		
FCC ID	PU5-TP00082ASI																																																	
Equipment Name	Tablet PC																																																	
Operating Frequency Range of each LTE transmission band	LTE Band 02: 1850 MHz ~ 1910 MHz LTE Band 04: 1710 MHz ~ 1755 MHz LTE Band 05: 824 MHz ~ 849 MHz LTE Band 07: 2500 MHz ~ 2570 MHz LTE Band 12: 699 MHz ~ 716 MHz LTE Band 13: 777 MHz ~ 787 MHz LTE Band 25: 1850 MHz ~ 1915 MHz LTE Band 26: 814 MHz ~ 849 MHz LTE Band 41: 2496 MHz ~ 2690 MHz																																																	
Channel Bandwidth	LTE Band 02: 1.4MHz, 3MHz, 5MHz, 10MHz, 15MHz, 20MHz LTE Band 04: 1.4MHz, 3MHz, 5MHz, 10MHz, 15MHz, 20MHz LTE Band 05: 1.4MHz, 3MHz, 5MHz, 10MHz LTE Band 07: 5MHz, 10MHz, 15MHz, 20MHz LTE Band 12: 1.4MHz, 3MHz, 5MHz, 10MHz LTE Band 13: 5MHz, 10MHz LTE Band 25: 1.4MHz, 3MHz, 5MHz, 10MHz, 15MHz, 20MHz LTE Band 26: 1.4MHz, 3MHz, 5MHz, 10MHz, 15MHz LTE Band 41: 5MHz, 10MHz, 15MHz, 20MHz																																																	
uplink modulations used	QPSK, and 16QAM																																																	
LTE Voice / Data requirements	Data only																																																	
LTE MPR permanently built-in by design	<p style="text-align: center;">Table 6.2.3-1: Maximum Power Reduction (MPR) for Power Class 3</p> <table border="1" style="width: 100%; border-collapse: collapse;"> <thead> <tr> <th rowspan="2">Modulation</th> <th colspan="6">Channel bandwidth / Transmission bandwidth (RB)</th> <th rowspan="2">MPR (dB)</th> </tr> <tr> <th>1.4 MHz</th> <th>3.0 MHz</th> <th>5 MHz</th> <th>10 MHz</th> <th>15 MHz</th> <th>20 MHz</th> </tr> </thead> <tbody> <tr> <td>QPSK</td> <td>> 5</td> <td>> 4</td> <td>> 8</td> <td>> 12</td> <td>> 16</td> <td>> 18</td> <td>≤ 1</td> </tr> <tr> <td>16 QAM</td> <td>≤ 5</td> <td>≤ 4</td> <td>≤ 8</td> <td>≤ 12</td> <td>≤ 16</td> <td>≤ 18</td> <td>≤ 1</td> </tr> <tr> <td>16 QAM</td> <td>> 5</td> <td>> 4</td> <td>> 8</td> <td>> 12</td> <td>> 16</td> <td>> 18</td> <td>≤ 2</td> </tr> </tbody> </table>												Modulation	Channel bandwidth / Transmission bandwidth (RB)						MPR (dB)	1.4 MHz	3.0 MHz	5 MHz	10 MHz	15 MHz	20 MHz	QPSK	> 5	> 4	> 8	> 12	> 16	> 18	≤ 1	16 QAM	≤ 5	≤ 4	≤ 8	≤ 12	≤ 16	≤ 18	≤ 1	16 QAM	> 5	> 4	> 8	> 12	> 16	> 18	≤ 2
Modulation	Channel bandwidth / Transmission bandwidth (RB)						MPR (dB)																																											
	1.4 MHz	3.0 MHz	5 MHz	10 MHz	15 MHz	20 MHz																																												
QPSK	> 5	> 4	> 8	> 12	> 16	> 18	≤ 1																																											
16 QAM	≤ 5	≤ 4	≤ 8	≤ 12	≤ 16	≤ 18	≤ 1																																											
16 QAM	> 5	> 4	> 8	> 12	> 16	> 18	≤ 2																																											
LTE A-MPR	In the base station simulator configuration, Network Setting value is set to NS_01 to disable A-MPR during SAR testing and the LTE SAR tests was transmitting on all TTI frames (Maximum TTI)																																																	
Spectrum plots for RB configuration	A properly configured base station simulator was used for the SAR and power measurement; therefore, spectrum plots for each RB allocation and offset configuration are not included in the SAR report.																																																	
Power reduction applied to satisfy SAR compliance	Yes, Proximity Sensor.																																																	
LTE Carrier Aggregation Combinations	Inter-Band and Intra-Band possible combinations and the detail power verification please refer to original report as Appendix D																																																	
LTE Carrier Aggregation Additional Information	This device does not support full CA features on 3GPP Release 10. It supports a maximum of 2 carriers in the downlink only. All uplink communications are identical to the Release 8 Specifications. Uplink communications are done on the PCC. Due to carrier capability, only the combinations listed above are supported. The following LTE Release features are not supported: Relay, HetNet, Enhanced MIMO, eICI, WiFi Offloading, MDH, eMBMA, Cross-Carrier Scheduling, Enhanced SC-FDMA.																																																	
Transmission (H, M, L) channel numbers and frequencies in each LTE band																																																		
LTE Band 2																																																		
	Bandwidth 1.4 MHz		Bandwidth 3 MHz		Bandwidth 5 MHz		Bandwidth 10 MHz		Bandwidth 15 MHz		Bandwidth 20 MHz																																							
	Ch. #	Freq. (MHz)	Ch. #	Freq. (MHz)	Ch. #	Freq. (MHz)	Ch. #	Freq. (MHz)	Ch. #	Freq. (MHz)	Ch. #	Freq. (MHz)																																						
L	18607	1850.7	18615	1851.5	18625	1852.5	18650	1855	18675	1857.5	18700	1860																																						
M	18900	1880	18900	1880	18900	1880	18900	1880	18900	1880	18900	1880																																						
H	19193	1909.3	19185	1908.5	19175	1907.5	19150	1905	19125	1902.5	19100	1900																																						



LTE Band 4																
	Bandwidth 1.4 MHz		Bandwidth 3 MHz		Bandwidth 5 MHz		Bandwidth 10 MHz		Bandwidth 15 MHz		Bandwidth 20 MHz					
	Ch. #	Freq. (MHz)	Ch. #	Freq. (MHz)	Ch. #	Freq. (MHz)	Ch. #	Freq. (MHz)	Ch. #	Freq. (MHz)	Ch. #	Freq. (MHz)				
L	19957	1710.7	19965	1711.5	19975	1712.5	20000	1715	20025	1717.5	20050	1720				
M	20175	1732.5	20175	1732.5	20175	1732.5	20175	1732.5	20175	1732.5	20175	1732.5				
H	20393	1754.3	20385	1753.5	20375	1752.5	20350	1750	20325	1747.5	20300	1745				
LTE Band 5																
	Bandwidth 1.4 MHz		Bandwidth 3 MHz		Bandwidth 5 MHz		Bandwidth 10 MHz		Bandwidth 15 MHz		Bandwidth 20 MHz					
	Ch. #	Freq. (MHz)	Ch. #	Freq. (MHz)	Ch. #	Freq. (MHz)	Ch. #	Freq. (MHz)	Ch. #	Freq. (MHz)	Ch. #	Freq. (MHz)				
L	20407	824.7	20415	825.5	20425	826.5	20450	829	20450	829	20450	829				
M	20525	836.5	20525	836.5	20525	836.5	20525	836.5	20525	836.5	20525	836.5				
H	20643	848.3	20635	847.5	20625	846.5	20600	844	20600	844	20600	844				
LTE Band 7																
	Bandwidth 5 MHz		Bandwidth 10 MHz		Bandwidth 15 MHz		Bandwidth 20 MHz		Bandwidth 15 MHz		Bandwidth 20 MHz					
	Ch. #	Freq. (MHz)	Ch. #	Freq. (MHz)	Ch. #	Freq. (MHz)	Ch. #	Freq. (MHz)	Ch. #	Freq. (MHz)	Ch. #	Freq. (MHz)				
L	20775	2502.5	20800	2505	20825	2507.5	20850	2510	20850	2510	20850	2510				
M	21100	2535	21100	2535	21100	2535	21100	2535	21100	2535	21100	2535				
H	21425	2567.5	21400	2565	21375	2562.5	21350	2560	21350	2560	21350	2560				
LTE Band 12																
	Bandwidth 1.4 MHz		Bandwidth 3 MHz		Bandwidth 5 MHz		Bandwidth 10 MHz		Bandwidth 15 MHz		Bandwidth 20 MHz					
	Ch. #	Freq. (MHz)	Ch. #	Freq. (MHz)	Ch. #	Freq. (MHz)	Ch. #	Freq. (MHz)	Ch. #	Freq. (MHz)	Ch. #	Freq. (MHz)				
L	23017	699.7	23025	700.5	23035	701.5	23060	704	23060	704	23060	704				
M	23095	707.5	23095	707.5	23095	707.5	23095	707.5	23095	707.5	23095	707.5				
H	23173	715.3	23165	714.5	23155	713.5	23130	711	23130	711	23130	711				
LTE Band 13																
	Bandwidth 5 MHz				Bandwidth 10 MHz				Bandwidth 15 MHz				Bandwidth 20 MHz			
	Channel #		Freq.(MHz)		Channel #		Freq.(MHz)		Channel #		Freq.(MHz)		Channel #		Freq.(MHz)	
L	23205		779.5		23230		782		23230		782		23230		782	
M	23230		782		23230		782		23230		782		23230		782	
H	23255		784.5		23230		782		23230		782		23230		782	
LTE Band 25																
	Bandwidth 1.4 MHz		Bandwidth 3 MHz		Bandwidth 5 MHz		Bandwidth 10 MHz		Bandwidth 15 MHz		Bandwidth 20 MHz					
	Ch. #	Freq. (MHz)	Ch. #	Freq. (MHz)	Ch. #	Freq. (MHz)	Ch. #	Freq. (MHz)	Ch. #	Freq. (MHz)	Ch. #	Freq. (MHz)				
L	26047	1850.7	26055	1851.5	26065	1852.5	26090	1855	26115	1857.5	26140	1860				
M	26340	1880	26340	1880	26340	1880	26340	1880	26340	1880	26340	1880				
H	26683	1914.3	26675	1913.5	26665	1912.5	26640	1910	26615	1907.5	26590	1905				
LTE Band 26																
	Bandwidth 1.4 MHz		Bandwidth 3 MHz		Bandwidth 5 MHz		Bandwidth 10 MHz		Bandwidth 15 MHz		Bandwidth 20 MHz					
	Ch. #	Freq. (MHz)	Ch. #	Freq. (MHz)	Ch. #	Freq. (MHz)	Ch. #	Freq. (MHz)	Ch. #	Freq. (MHz)	Ch. #	Freq. (MHz)				
L	26697	814.7	26705	815.5	26715	816.5	26740	819	26765	821.5	26790	824.5				
M	26865	831.5	26865	831.5	26865	831.5	26865	831.5	26865	831.5	26865	831.5				
H	27033	848.3	27025	847.5	27015	846.5	26990	844	26965	841.5	26940	838.5				
LTE Band 41																
	Bandwidth 5 MHz		Bandwidth 10 MHz		Bandwidth 15 MHz		Bandwidth 20 MHz		Bandwidth 15 MHz		Bandwidth 20 MHz					
	Ch. #	Freq. (MHz)	Ch. #	Freq. (MHz)	Ch. #	Freq. (MHz)	Ch. #	Freq. (MHz)	Ch. #	Freq. (MHz)	Ch. #	Freq. (MHz)				
L	39675	2498.5	39700	2501	39725	2503.5	39750	2506	39750	2506	39750	2506				
L	40148	2545.8	40160	2547	40173	2548.3	40185	2549.5	40185	2549.5	40185	2549.5				
M	40620	2593	40620	2593	40620	2593	40620	2593	40620	2593	40620	2593				
H	41093	2640.3	41080	2639	41068	2637.8	41055	2636.5	41055	2636.5	41055	2636.5				
H	41565	2687.5	41540	2685	41515	2682.5	41490	2680	41490	2680	41490	2680				



5. RF Exposure Limits

5.1 Uncontrolled Environment

Uncontrolled Environments are defined as locations where there is the exposure of individuals who have no knowledge or control of their exposure. The general population/uncontrolled exposure limits are applicable to situations in which the general public may be exposed or in which persons who are exposed as a consequence of their employment may not be made fully aware of the potential for exposure or cannot exercise control over their exposure. Members of the general public would come under this category when exposure is not employment-related; for example, in the case of a wireless transmitter that exposes persons in its vicinity.

5.2 Controlled Environment

Controlled Environments are defined as locations where there is exposure that may be incurred by persons who are aware of the potential for exposure, (i.e. as a result of employment or occupation). In general, occupational/controlled exposure limits are applicable to situations in which persons are exposed as a consequence of their employment, who have been made fully aware of the potential for exposure and can exercise control over their exposure. The exposure category is also applicable when the exposure is of a transient nature due to incidental passage through a location where the exposure levels may be higher than the general population/uncontrolled limits, but the exposed person is fully aware of the potential for exposure and can exercise control over his or her exposure by leaving the area or by some other appropriate means.

Limits for Occupational/Controlled Exposure (W/kg)

Table with 3 columns: Whole-Body, Partial-Body, Hands, Wrists, Feet and Ankles. Values: 0.4, 8.0, 20.0

Limits for General Population/Uncontrolled Exposure (W/kg)

Table with 3 columns: Whole-Body, Partial-Body, Hands, Wrists, Feet and Ankles. Values: 0.08, 1.6, 4.0

- 1. Whole-Body SAR is averaged over the entire body, partial-body SAR is averaged over any 1gram of tissue defined as a tissue volume in the shape of a cube. SAR for hands, wrists, feet and ankles is averaged over any 10 grams of tissue defined as a tissue volume in the shape of a cube.



6. Specific Absorption Rate (SAR)

6.1 Introduction

SAR is related to the rate at which energy is absorbed per unit mass in an object exposed to a radio field. The SAR distribution in a biological body is complicated and is usually carried out by experimental techniques or numerical modeling. The standard recommends limits for two tiers of groups, occupational/controlled and general population/uncontrolled, based on a person's awareness and ability to exercise control over his or her exposure. In general, occupational/controlled exposure limits are higher than the limits for general population/uncontrolled.

6.2 SAR Definition

The SAR definition is the time derivative (rate) of the incremental energy (dW) absorbed by (dissipated in) an incremental mass (dm) contained in a volume element (dv) of a given density (ρ). The equation description is as below:

$$SAR = \frac{d}{dt} \left(\frac{dW}{dm} \right) = \frac{d}{dt} \left(\frac{dW}{\rho dv} \right)$$

SAR is expressed in units of Watts per kilogram (W/kg)

$$SAR = \frac{\sigma |E|^2}{\rho}$$

Where: σ is the conductivity of the tissue, ρ is the mass density of the tissue and E is the RMS electrical field strength.

7. System Description and Setup

The DASY system used for performing compliance tests consists of the following items:

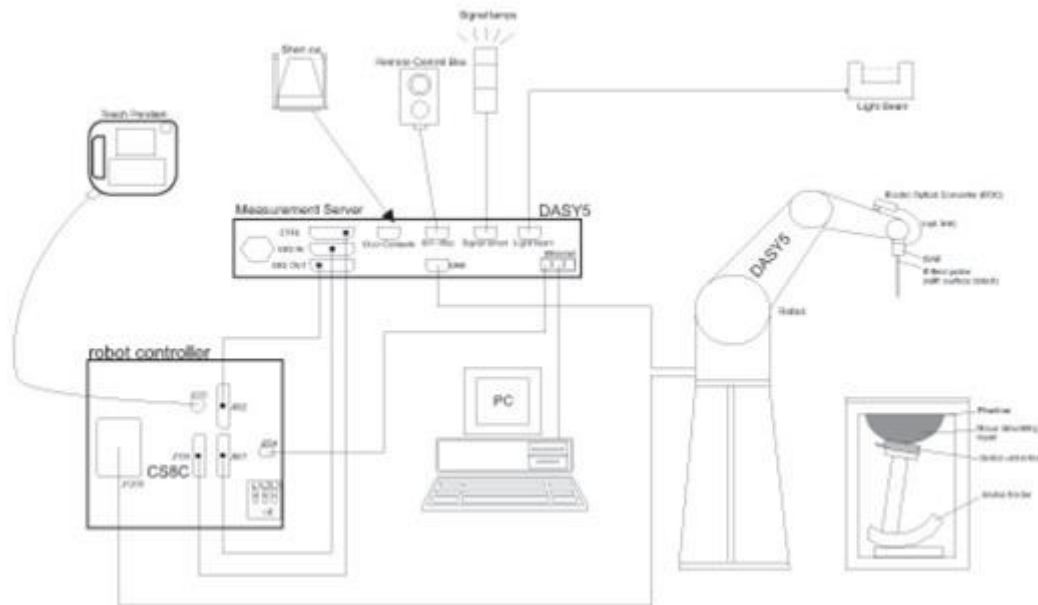

- A standard high precision 6-axis robot with controller, teach pendant and software. An arm extension for accommodating the data acquisition electronics (DAE).
- An isotropic Field probe optimized and calibrated for the targeted measurement.
- A data acquisition electronics (DAE) which performs the signal amplification, signal multiplexing, AD-conversion, offset measurements, mechanical surface detection, collision detection, etc. The unit is battery powered with standard or rechargeable batteries. The signal is optically transmitted to the EOC.
- The Electro-optical converter (EOC) performs the conversion from optical to electrical signals for the digital communication to the DAE. To use optical surface detection, a special version of the EOC is required. The EOC signal is transmitted to the measurement server.
- The function of the measurement server is to perform the time critical tasks such as signal filtering, control of the robot operation and fast movement interrupts.
- The Light Beam used is for probe alignment. This improves the (absolute) accuracy of the probe positioning.
- A computer running WinXP or Win7 and the DASY5 software.
- Remote control and teach pendant as well as additional circuitry for robot safety such as warning lamps, etc.
- The phantom, the device holder and other accessories according to the targeted measurement.

7.1 E-Field Probe

The SAR measurement is conducted with the dosimetric probe (manufactured by SPEAG). The probe is specially designed and calibrated for use in liquid with high permittivity. The dosimetric probe has special calibration in liquid at different frequency. This probe has a built in optical surface detection system to prevent from collision with phantom.

<ES3DV3 Probe>

Construction	Symmetric design with triangular core Interleaved sensors Built-in shielding against static charges PEEK enclosure material (resistant to organic solvents, e.g., DGBE)	
Frequency	10 MHz – 4 GHz; Linearity: ± 0.2 dB (30 MHz – 4 GHz)	
Directivity	± 0.2 dB in TSL (rotation around probe axis) ± 0.3 dB in TSL (rotation normal to probe axis)	
Dynamic Range	5 μ W/g – >100 mW/g; Linearity: ± 0.2 dB	
Dimensions	Overall length: 337 mm (tip: 20 mm) Tip diameter: 3.9 mm (body: 12 mm) Distance from probe tip to dipole centers: 3.0 mm	

<EX3DV4 Probe>

Construction	Symmetric design with triangular core Built-in shielding against static charges PEEK enclosure material (resistant to organic solvents, e.g., DGBE)	
Frequency	10 MHz – >6 GHz Linearity: ± 0.2 dB (30 MHz – 6 GHz)	
Directivity	± 0.3 dB in TSL (rotation around probe axis) ± 0.5 dB in TSL (rotation normal to probe axis)	
Dynamic Range	10 μ W/g – >100 mW/g Linearity: ± 0.2 dB (noise: typically <1 μ W/g)	
Dimensions	Overall length: 337 mm (tip: 20 mm) Tip diameter: 2.5 mm (body: 12 mm) Typical distance from probe tip to dipole centers: 1 mm	

7.2 Data Acquisition Electronics (DAE)

The data acquisition electronics (DAE) consists of a highly sensitive electrometer-grade preamplifier with auto-zeroing, a channel and gain-switching multiplexer, a fast 16 bit AD-converter and a command decoder and control logic unit. Transmission to the measurement server is accomplished through an optical downlink for data and status information as well as an optical uplink for commands and the clock.

The input impedance of the DAE is 200 MOhm; the inputs are symmetrical and floating. Common mode rejection is above 80 dB.



FIG 5.1 Photo of DAE

7.3 Phantom

<SAM Twin Phantom>

Shell Thickness	2 ± 0.2 mm; Center ear point: 6 ± 0.2 mm	
Filling Volume	Approx. 25 liters	
Dimensions	Length: 1000 mm; Width: 500 mm; Height: adjustable feet	
Measurement Areas	Left Hand, Right Hand, Flat Phantom	

The bottom plate contains three pair of bolts for locking the device holder. The device holder positions are adjusted to the standard measurement positions in the three sections. A white cover is provided to tap the phantom during off-periods to prevent water evaporation and changes in the liquid parameters. On the phantom top, three reference markers are provided to identify the phantom position with respect to the robot.

<ELI Phantom>

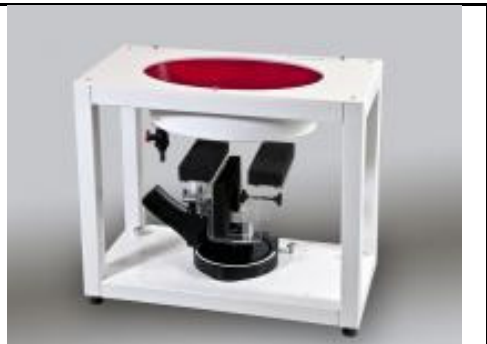
Shell Thickness	2 ± 0.2 mm (sagging: <1%)	
Filling Volume	Approx. 30 liters	
Dimensions	Major ellipse axis: 600 mm Minor axis: 400 mm	

The ELI phantom is intended for compliance testing of handheld and body-mounted wireless devices in the frequency range of 30 MHz to 6 GHz. ELI4 is fully compatible with standard and all known tissue simulating liquids.

7.4 Device Holder

<Mounting Device for Hand-Held Transmitter>

In combination with the Twin SAM V5.0/V5.0c or ELI phantoms, the Mounting Device for Hand-Held Transmitters enables rotation of the mounted transmitter device to specified spherical coordinates. At the heads, the rotation axis is at the ear opening. Transmitter devices can be easily and accurately positioned according to IEC 62209-1, IEEE 1528, FCC, or other specifications. The device holder can be locked for positioning at different phantom sections (left head, right head, flat). And upgrade kit to Mounting Device to enable easy mounting of wider devices like big smart-phones, e-books, small tablets, etc. It holds devices with width up to 140 mm.



Mounting Device for Hand-Held Transmitters



Mounting Device Adaptor for Wide-Phones

<Mounting Device for Laptops and other Body-Worn Transmitters>

The extension is lightweight and made of POM, acrylic glass and foam. It fits easily on the upper part of the mounting device in place of the phone positioned. The extension is fully compatible with the SAM Twin and ELI phantoms.



Mounting Device for Laptops

8. Measurement Procedures

The measurement procedures are as follows:

<Conducted power measurement>

- (a) For WWAN power measurement, use base station simulator to configure EUT WWAN transmission in conducted connection with RF cable, at maximum power in each supported wireless interface and frequency band.
- (b) Read the WWAN RF power level from the base station simulator.
- (c) For WLAN/BT power measurement, use engineering software to configure EUT WLAN/BT continuously transmission, at maximum RF power in each supported wireless interface and frequency band
- (d) Connect EUT RF port through RF cable to the power meter, and measure WLAN/BT output power

<SAR measurement>

- (a) Use base station simulator to configure EUT WWAN transmission in radiated connection, and engineering software to configure EUT WLAN/BT continuously transmission, at maximum RF power, in the highest power channel.
- (b) Place the EUT in the positions as Appendix D demonstrates.
- (c) Set scan area, grid size and other setting on the DASY software.
- (d) Measure SAR results for the highest power channel on each testing position.
- (e) Find out the largest SAR result on these testing positions of each band
- (f) Measure SAR results for other channels in worst SAR testing position if the reported SAR of highest power channel is larger than 0.8 W/kg

According to the test standard, the recommended procedure for assessing the peak spatial-average SAR value consists of the following steps:

- (a) Power reference measurement
- (b) Area scan
- (c) Zoom scan
- (d) Power drift measurement

8.1 Spatial Peak SAR Evaluation

The procedure for spatial peak SAR evaluation has been implemented according to the test standard. It can be conducted for 1g and 10g, as well as for user-specific masses. The DASY software includes all numerical procedures necessary to evaluate the spatial peak SAR value.

The base for the evaluation is a "cube" measurement. The measured volume must include the 1g and 10g cubes with the highest averaged SAR values. For that purpose, the center of the measured volume is aligned to the interpolated peak SAR value of a previously performed area scan.

The entire evaluation of the spatial peak values is performed within the post-processing engine (SEMCAD). The system always gives the maximum values for the 1g and 10g cubes. The algorithm to find the cube with highest averaged SAR is divided into the following stages:

- (a) Extraction of the measured data (grid and values) from the Zoom Scan
- (b) Calculation of the SAR value at every measurement point based on all stored data (A/D values and measurement parameters)
- (c) Generation of a high-resolution mesh within the measured volume
- (d) Interpolation of all measured values from the measurement grid to the high-resolution grid
- (e) Extrapolation of the entire 3-D field distribution to the phantom surface over the distance from sensor to surface
- (f) Calculation of the averaged SAR within masses of 1g and 10g

8.2 Power Reference Measurement

The Power Reference Measurement and Power Drift Measurements are for monitoring the power drift of the device under test in the batch process. The minimum distance of probe sensors to surface determines the closest measurement point to phantom surface. This distance cannot be smaller than the distance of sensor calibration points to probe tip as defined in the probe properties.

8.3 Area Scan

The area scan is used as a fast scan in two dimensions to find the area of high field values, before doing a fine measurement around the hot spot. The sophisticated interpolation routines implemented in DASY software can find the maximum found in the scanned area, within a range of the global maximum. The range (in dB0 is specified in the standards for compliance testing. For example, a 2 dB range is required in IEEE standard 1528 and IEC 62209 standards, whereby 3 dB is a requirement when compliance is assessed in accordance with the ARIB standard (Japan), if only one zoom scan follows the area scan, then only the absolute maximum will be taken as reference. For cases where multiple maximums are detected, the number of zoom scans has to be increased accordingly.

Area scan parameters extracted from FCC KDB 865664 D01v01r04 SAR measurement 100 MHz to 6 GHz.

	≤ 3 GHz	> 3 GHz
Maximum distance from closest measurement point (geometric center of probe sensors) to phantom surface	5 ± 1 mm	$\frac{1}{2} \cdot \delta \cdot \ln(2) \pm 0.5$ mm
Maximum probe angle from probe axis to phantom surface normal at the measurement location	30° ± 1°	20° ± 1°
Maximum area scan spatial resolution: Δx_{Area} , Δy_{Area}	≤ 2 GHz: ≤ 15 mm 2 – 3 GHz: ≤ 12 mm	3 – 4 GHz: ≤ 12 mm 4 – 6 GHz: ≤ 10 mm
	When the x or y dimension of the test device, in the measurement plane orientation, is smaller than the above, the measurement resolution must be ≤ the corresponding x or y dimension of the test device with at least one measurement point on the test device.	

8.4 Zoom Scan

Zoom scans are used assess the peak spatial SAR values within a cubic averaging volume containing 1 gram and 10 gram of simulated tissue. The zoom scan measures points (refer to table below) within a cube shoes base faces are centered on the maxima found in a preceding area scan job within the same procedure. When the measurement is done, the zoom scan evaluates the averaged SAR for 1 gram and 10 gram and displays these values next to the job's label.

Zoom scan parameters extracted from FCC KDB 865664 D01v01r04 SAR measurement 100 MHz to 6 GHz.

		≤ 3 GHz	> 3 GHz	
Maximum zoom scan spatial resolution: $\Delta x_{Zoom}, \Delta y_{Zoom}$		≤ 2 GHz: ≤ 8 mm 2 – 3 GHz: ≤ 5 mm*	3 – 4 GHz: ≤ 5 mm* 4 – 6 GHz: ≤ 4 mm*	
Maximum zoom scan spatial resolution, normal to phantom surface	uniform grid: $\Delta z_{Zoom}(n)$	≤ 5 mm	3 – 4 GHz: ≤ 4 mm 4 – 5 GHz: ≤ 3 mm 5 – 6 GHz: ≤ 2 mm	
	graded grid	$\Delta z_{Zoom}(1)$: between 1 st two points closest to phantom surface	≤ 4 mm	3 – 4 GHz: ≤ 3 mm 4 – 5 GHz: ≤ 2.5 mm 5 – 6 GHz: ≤ 2 mm
		$\Delta z_{Zoom}(n>1)$: between subsequent points	$\leq 1.5 \cdot \Delta z_{Zoom}(n-1)$	
Minimum zoom scan volume	x, y, z	≥ 30 mm	3 – 4 GHz: ≥ 28 mm 4 – 5 GHz: ≥ 25 mm 5 – 6 GHz: ≥ 22 mm	
Note: δ is the penetration depth of a plane-wave at normal incidence to the tissue medium; see draft standard IEEE P1528-2011 for details. * When zoom scan is required and the <i>reported</i> SAR from the <i>area scan based 1-g SAR estimation</i> procedures of KDB 447498 is ≤ 1.4 W/kg, ≤ 8 mm, ≤ 7 mm and ≤ 5 mm zoom scan resolution may be applied, respectively, for 2 GHz to 3 GHz, 3 GHz to 4 GHz and 4 GHz to 6 GHz.				

8.5 Volume Scan Procedures

The volume scan is used for assess overlapping SAR distributions for antennas transmitting in different frequency bands. It is equivalent to an oversized zoom scan used in standalone measurements. The measurement volume will be used to enclose all the simultaneous transmitting antennas. For antennas transmitting simultaneously in different frequency bands, the volume scan is measured separately in each frequency band. In order to sum correctly to compute the 1g aggregate SAR, the EUT remain in the same test position for all measurements and all volume scan use the same spatial resolution and grid spacing. When all volume scan were completed, the software, SEMCAD postprocessor can combine and subsequently superpose these measurement data to calculating the multiband SAR.

8.6 Power Drift Monitoring

All SAR testing is under the EUT install full charged battery and transmit maximum output power. In DASy measurement software, the power reference measurement and power drift measurement procedures are used for monitoring the power drift of EUT during SAR test. Both these procedures measure the field at a specified reference position before and after the SAR testing. The software will calculate the field difference in dB. If the power drifts more than 5%, the SAR will be retested.



9. Test Equipment List

Manufacturer	Name of Equipment	Type/Model	Serial Number	Calibration	
				Last Cal.	Due Date
SPEAG	750MHz System Validation Kit	D750V3	1012	May. 18, 2016	May. 17, 2017
SPEAG	835MHz System Validation Kit	D835V2	499	Mar. 21, 2016	Mar. 20, 2017
SPEAG	1750MHz System Validation Kit	D1750V2	1068	Nov. 23, 2015	Nov. 22, 2016
SPEAG	1900MHz System Validation Kit	D1900V2	5d041	Oct. 22, 2015	Oct. 21, 2016
SPEAG	2450MHz System Validation Kit	D2450V2	926	Jul. 25, 2016	Jul. 24, 2017
SPEAG	2600MHz System Validation Kit	D2600V2	1113	Aug. 30, 2016	Aug. 29, 2017
SPEAG	5GHz System Validation Kit	D5GHZV2	1040	Jun. 17, 2016	Jun. 16, 2017
SPEAG	5GHz System Validation Kit	D5GHZV2	1128	Jul. 27, 2016	Jul. 26, 2017
SPEAG	Data Acquisition Electronics	DAE3	495	May. 27, 2016	May. 26, 2017
SPEAG	Data Acquisition Electronics	DAE4	1399	Nov. 23, 2015	Nov. 22, 2016
SPEAG	Data Acquisition Electronics	DAE4	679	Jun. 13, 2016	Jun. 12, 2017
SPEAG	Dosimetric E-Field Probe	EX3DV4	3925	May. 26, 2016	May. 25, 2017
SPEAG	Dosimetric E-Field Probe	EX3DV4	3955	Nov. 24, 2015	Nov. 23, 2016
SPEAG	Dosimetric E-Field Probe	EX3DV4	3820	Jun. 27, 2016	Jun. 26, 2017
WonDer	Thermometer	WD-5015	TM281	Oct. 16, 2015	Oct. 15, 2016
Wisewind	Thermometer	HTC-1	TM560	Oct. 16, 2015	Oct. 15, 2016
WonDer	Thermometer	WD-5015	TM281	Oct. 12, 2016	Oct. 11, 2017
Wisewind	Thermometer	HTC-1	TM560	Oct. 12, 2016	Oct. 11, 2017
Anritsu	Radio Communication Analyzer	MT8820C	6201381760	May. 10, 2016	May. 09, 2017
Agilent	Wireless Communication Test Set	E5515C	GB46311322	Mar. 05, 2015	Mar. 04, 2017
R&S	BT Base Station	CBT32	100519	Jun. 03, 2016	Jun. 02, 2017
SPEAG	Device Holder	N/A	N/A	N/A	N/A
R&S	Signal Generator	MG3710A	6201502524	Dec. 18, 2015	Dec. 17, 2016
Agilent	ENA Network Analyzer	E5071C	MY46316648	Jan. 12, 2016	Jan. 11, 2017
SPEAG	Dielectric Probe Kit	DAK-3.5	1126	Jul. 19, 2016	Jul. 18, 2017
LINE SEIKI	Digital Thermometer	LKMelectronic	DTM3000SPEZIAL	Sep. 05, 2016	Sep. 04, 2017
Anritsu	Power Meter	ML2495A	1419002	May. 10, 2016	May. 09, 2017
Anritsu	Power Sensor	MA2411B	1339124	May. 10, 2016	May. 09, 2017
Agilent	Spectrum Analyzer	E4408B	MY44211028	Aug. 22, 2016	Aug. 21, 2017
Mini-Circuits	Power Amplifier	ZVE-8G+	D120604	Mar. 16, 2016	Mar. 15, 2017
Mini-Circuits	Power Amplifier	ZHL-42W+	QA1344002	Mar. 16, 2016	Mar. 15, 2017
ATM	Dual Directional Coupler	C122H-10	P610410z-02	Note 1	
Woken	Attenuator 1	WK0602-XX	N/A	Note 1	
PE	Attenuator 2	PE7005-10	N/A	Note 1	
PE	Attenuator 3	PE7005- 3	N/A	Note 1	

General Note:

1. Prior to system verification and validation, the path loss from the signal generator to the system check source and the power meter, which includes the amplifier, cable, attenuator and directional coupler, was measured by the network analyzer. The reading of the power meter was offset by the path loss difference between the path to the power meter and the path to the system check source to monitor the actual power level fed to the system check source.

10. System Verification

10.1 Tissue Simulating Liquids

For the measurement of the field distribution inside the SAM phantom with DASY, the phantom must be filled with around 25 liters of homogeneous body tissue simulating liquid. For head SAR testing, the liquid height from the ear reference point (ERP) of the phantom to the liquid top surface is larger than 15 cm, which is shown in Fig. 10.1. For body SAR testing, the liquid height from the center of the flat phantom to the liquid top surface is larger than 15 cm, which is shown in Fig. 10.2.

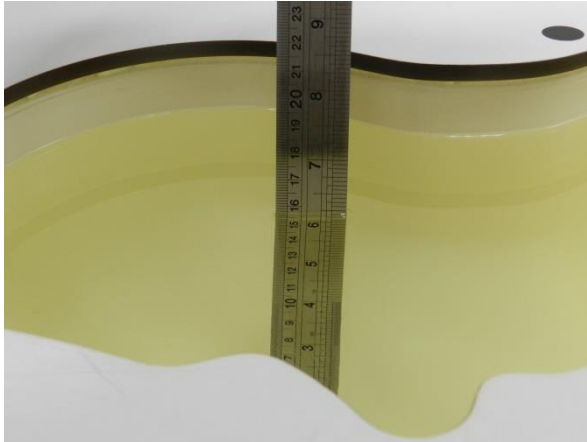

Fig 10.1 Photo of Liquid Height for Head SAR

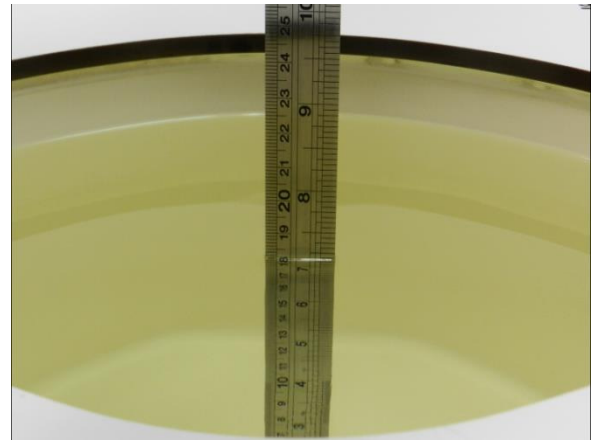

Fig 10.2 Photo of Liquid Height for Body SAR



10.2 Tissue Verification

The following tissue formulations are provided for reference only as some of the parameters have not been thoroughly verified. The composition of ingredients may be modified accordingly to achieve the desired target tissue parameters required for routine SAR evaluation.

Frequency (MHz)	Water (%)	Sugar (%)	Cellulose (%)	Salt (%)	Preventol (%)	DGBE (%)	Conductivity (σ)	Permittivity (ε _r)
For Head								
750	41.1	57.0	0.2	1.4	0.2	0	0.89	41.9
835	40.3	57.9	0.2	1.4	0.2	0	0.90	41.5
900	40.3	57.9	0.2	1.4	0.2	0	0.97	41.5
1800, 1900, 2000	55.2	0	0	0.3	0	44.5	1.40	40.0
2450	55.0	0	0	0	0	45.0	1.80	39.2
2600	54.8	0	0	0.1	0	45.1	1.96	39.0
For Body								
750	51.7	47.2	0	0.9	0.1	0	0.96	55.5
835	50.8	48.2	0	0.9	0.1	0	0.97	55.2
900	50.8	48.2	0	0.9	0.1	0	1.05	55.0
1800, 1900, 2000	70.2	0	0	0.4	0	29.4	1.52	53.3
2450	68.6	0	0	0	0	31.4	1.95	52.7
2600	68.1	0	0	0.1	0	31.8	2.16	52.5

Simulating Liquid for 5GHz, Manufactured by SPEAG

Ingredients	(% by weight)
Water	64~78%
Mineral oil	11~18%
Emulsifiers	9~15%
Additives and Salt	2~3%

<Tissue Dielectric Parameter Check Results>

Frequency (MHz)	Tissue Type	Liquid Temp. (°C)	Conductivity (σ)	Permittivity (ε _r)	Conductivity Target (σ)	Permittivity Target (ε _r)	Delta (σ) (%)	Delta (ε _r) (%)	Limit (%)	Date
750	MSL	22.6	0.957	55.028	0.96	55.50	-0.31	-0.85	±5	2016/10/1
835	MSL	22.6	0.986	56.433	0.97	55.20	1.65	2.23	±5	2016/10/1
1750	MSL	22.7	1.508	55.884	1.49	53.40	1.21	4.65	±5	2016/10/1
1900	MSL	22.7	1.520	53.546	1.52	53.30	0.00	0.46	±5	2016/10/1
2450	MSL	22.3	1.986	54.952	1.95	52.70	1.85	4.27	±5	2016/10/7
2450	MSL	22.3	1.944	53.053	1.95	52.70	-0.31	0.67	±5	2016/10/18
2600	MSL	22.4	2.125	52.570	2.16	52.50	-1.62	0.13	±5	2016/9/22
5200	MSL	22.5	5.459	47.153	5.30	49.00	3.00	-3.77	±5	2016/10/1
5250	MSL	22.3	5.389	46.935	5.36	48.95	0.54	-4.12	±5	2016/10/6
5300	MSL	22.5	5.588	46.984	5.42	48.90	3.10	-3.92	±5	2016/10/1
5600	MSL	22.7	5.649	46.107	5.77	48.50	-2.10	-4.93	±5	2016/10/3
5600	MSL	22.3	5.920	46.713	5.77	48.50	2.60	-3.68	±5	2016/10/6
5750	MSL	22.3	6.121	46.454	5.94	48.28	3.05	-3.78	±5	2016/10/6

10.3 System Performance Check Results

Comparing to the original SAR value provided by SPEAG, the verification data should be within its specification of 10 %. Below table shows the target SAR and measured SAR after normalized to 1W input power. The table below indicates the system performance check can meet the variation criterion and the plots can be referred to Appendix A of this report.

Date	Frequency (MHz)	Tissue Type	Input Power (mW)	Dipole S/N	Probe S/N	DAE S/N	Measured 1g SAR (W/kg)	Targeted 1g SAR (W/kg)	Normalized 1g SAR (W/kg)	Deviation (%)
2016/10/1	750	MSL	250	D750V3-1012	EX3DV4 - SN3955	DAE4 Sn1399	2.21	8.72	8.84	1.38
2016/10/1	835	MSL	250	D835V2-499	EX3DV4 - SN3955	DAE4 Sn1399	2.53	9.52	10.12	6.30
2016/10/1	1750	MSL	250	D1750V2-1068	EX3DV4 - SN3955	DAE4 Sn1399	9.15	35.70	36.60	2.52
2016/10/1	1900	MSL	250	D1900V2-5d041	EX3DV4 - SN3955	DAE4 Sn1399	10.00	40.00	40.00	0.00
2016/10/7	2450	MSL	250	D2450V2-926	EX3DV4 - SN3955	DAE4 Sn1399	12.10	51.20	48.40	-5.47
2016/10/18	2450	MSL	250	D2450V2-926	EX3DV4 - SN3955	DAE4 Sn1399	12.40	51.20	49.60	-3.13
2016/9/22	2600	MSL	250	D2600V2-1113	EX3DV4 - SN3820	DAE4 Sn679	14.10	55.60	56.40	1.44
2016/10/1	5200	MSL	100	D5GHzV2-1040	EX3DV4 - SN3925	DAE3 Sn495	7.29	72.90	72.90	0.00
2016/10/6	5250	MSL	100	D5GHzV2-1128	EX3DV4 - SN3955	DAE4 Sn1399	7.73	74.50	77.30	3.76
2016/10/1	5300	MSL	100	D5GHzV2-1040	EX3DV4 - SN3925	DAE3 Sn495	7.76	76.40	77.60	1.57
2016/10/3	5600	MSL	100	D5GHzV2-1128	EX3DV4 - SN3955	DAE4 Sn1399	7.50	78.00	75.00	-3.85
2016/10/6	5600	MSL	100	D5GHzV2-1128	EX3DV4 - SN3955	DAE4 Sn1399	7.95	78.00	79.50	1.92
2016/10/6	5750	MSL	100	D5GHzV2-1128	EX3DV4 - SN3955	DAE4 Sn1399	7.43	76.10	74.30	-2.37

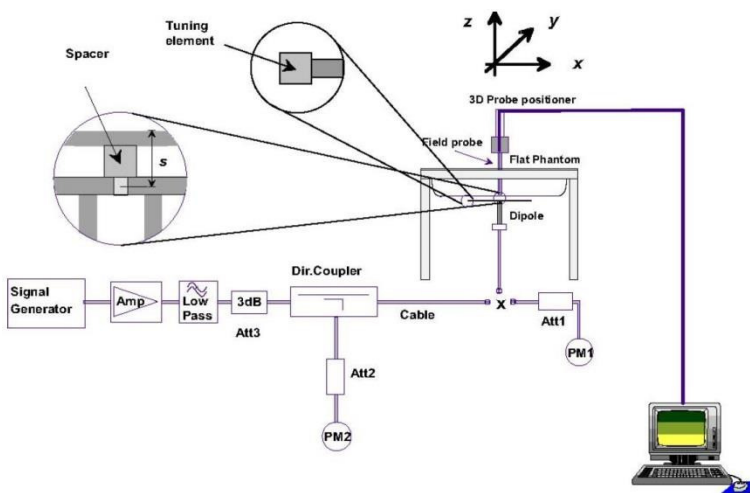

Fig 8.3.1 System Performance Check Setup



Fig 8.3.2 Setup Photo

11. RF Exposure Positions

11.1 SAR Testing for Tablet

This device can be used also in full sized tablet exposure conditions, due to its size. Per FCC KDB 616217, the back surface and edges of the tablet should be tested for SAR compliance with the tablet touching the phantom. The SAR exclusion threshold in KDB 447498 D01v06 can be applied to determine SAR test exclusion for adjacent edge configurations. The closest distance from the antenna to an adjacent tablet edge is used to determine if SAR testing is required for the adjacent edges, with the adjacent edge positioned against the phantom and the edge containing the antenna positioned perpendicular to the phantom.



12. Conducted RF Output Power (Unit: dBm)

<WCDMA Conducted Power>

<Default Power Mode>

Band		WCDMA II			Tune-up Limit (dBm)	WCDMA IV			Tune-up Limit (dBm)	WCDMA V			Tune-up Limit (dBm)
TX Channel		9262	9400	9538		1312	1413	1513		4132	4182	4233	
Rx Channel		9662	9800	9938	1537	1638	1738	4357	4407	4458			
Frequency (MHz)		1852.4	1880	1907.6	1712.4	1732.6	1752.6	826.4	836.4	846.6			
3GPP Rel 99	RMC 12.2Kbps	22.73	22.81	22.59	24.00	22.58	22.76	22.66	24.00	22.66	22.67	22.88	24.00
3GPP Rel 6	HSDPA Subtest-1	22.55	22.42	22.23	24.00	22.03	22.13	22.19	24.00	22.24	22.48	22.57	24.00
3GPP Rel 6	HSDPA Subtest-2	22.38	22.40	22.28	24.00	22.04	22.14	22.20	24.00	22.33	22.42	22.47	24.00
3GPP Rel 6	HSDPA Subtest-3	22.01	21.84	21.69	23.50	21.55	22.10	21.67	23.50	21.81	21.89	22.26	23.50
3GPP Rel 6	HSDPA Subtest-4	21.90	21.96	21.73	23.50	21.56	21.98	21.59	23.50	21.74	21.86	22.27	23.50
3GPP Rel 8	DC-HSDPA Subtest-1	22.31	22.33	22.24	24.00	22.01	22.49	22.09	24.00	22.38	22.34	22.56	24.00
3GPP Rel 8	DC-HSDPA Subtest-2	22.42	22.44	22.25	24.00	22.06	22.49	22.15	24.00	22.32	22.30	22.56	24.00
3GPP Rel 8	DC-HSDPA Subtest-3	21.78	21.81	21.68	23.50	21.57	21.98	21.63	23.50	21.71	21.99	21.96	23.50
3GPP Rel 8	DC-HSDPA Subtest-4	22.03	21.91	21.85	23.50	21.53	22.03	21.67	23.50	21.75	21.82	21.97	23.50
3GPP Rel 6	HSUPA Subtest-1	22.44	22.46	22.25	24.00	22.08	22.37	22.16	24.00	22.30	22.53	22.50	24.00
3GPP Rel 6	HSUPA Subtest-2	21.75	21.81	21.56	22.00	20.64	21.06	20.52	22.00	21.11	21.17	21.15	22.00
3GPP Rel 6	HSUPA Subtest-3	21.33	21.42	21.26	23.00	21.14	21.62	21.28	23.00	21.22	21.35	21.89	23.00
3GPP Rel 6	HSUPA Subtest-4	21.67	21.78	21.58	22.00	20.75	21.16	20.56	22.00	21.48	21.34	21.95	22.00
3GPP Rel 6	HSUPA Subtest-5	22.30	22.37	22.19	24.00	22.03	22.66	22.33	24.00	22.34	22.55	22.81	24.00

<Reduced Power Mode>

Band		WCDMA II			Tune-up Limit (dBm)	WCDMA IV			Tune-up Limit (dBm)	WCDMA V			Tune-up Limit (dBm)
TX Channel		9262	9400	9538		1312	1413	1513		4132	4182	4233	
Rx Channel		9662	9800	9938	1537	1638	1738	4357	4407	4458			
Frequency (MHz)		1852.4	1880	1907.6	1712.4	1732.6	1752.6	826.4	836.4	846.6			
3GPP Rel 99	RMC 12.2Kbps	16.25	16.18	16.29	17.00	15.95	16.04	16.00	17.00	20.08	20.19	20.10	21.50
3GPP Rel 6	HSDPA Subtest-1	15.23	15.20	15.27	17.00	15.03	15.12	15.04	17.00	18.86	18.88	18.96	19.50
3GPP Rel 6	HSDPA Subtest-2	15.31	15.17	15.34	17.00	15.02	15.03	15.05	17.00	18.99	18.88	19.09	19.50
3GPP Rel 6	HSDPA Subtest-3	14.72	14.67	14.82	16.50	14.53	14.50	14.52	16.50	18.47	18.39	18.48	19.00
3GPP Rel 6	HSDPA Subtest-4	14.76	14.66	14.78	16.50	14.51	14.50	14.53	16.50	18.46	18.37	18.49	19.00
3GPP Rel 8	DC-HSDPA Subtest-1	15.16	15.10	15.33	17.00	15.02	15.05	15.04	17.00	18.88	18.80	18.94	19.50
3GPP Rel 8	DC-HSDPA Subtest-2	15.18	15.11	15.35	17.00	15.03	15.04	15.02	17.00	18.97	18.90	18.97	19.50
3GPP Rel 8	DC-HSDPA Subtest-3	14.79	14.65	14.82	16.50	14.50	14.53	14.51	16.50	18.45	18.42	18.51	19.00
3GPP Rel 8	DC-HSDPA Subtest-4	14.70	14.63	14.78	16.50	14.50	14.55	14.51	16.50	18.42	18.39	18.46	19.00
3GPP Rel 6	HSUPA Subtest-1	13.69	13.50	13.74	15.50	13.71	13.55	13.52	15.50	17.51	17.52	17.58	19.50
3GPP Rel 6	HSUPA Subtest-2	13.96	13.89	14.04	15.50	14.02	13.90	14.03	15.50	17.66	17.55	17.61	18.50
3GPP Rel 6	HSUPA Subtest-3	14.25	14.09	14.34	14.50	14.27	14.11	14.18	15.50	17.97	17.85	17.93	18.50
3GPP Rel 6	HSUPA Subtest-4	14.23	14.17	14.36	15.50	14.32	14.15	14.34	15.50	18.11	17.98	18.11	18.50
3GPP Rel 6	HSUPA Subtest-5	15.29	15.13	15.19	15.50	14.89	15.06	15.04	15.50	18.94	18.79	18.98	19.50



<LTE Conducted Power>

Default Power Mode

<LTE Band 2>

BW [MHz]	Modulation	RB Size	RB Offset	Power Low Ch. / Freq.	Power Middle Ch. / Freq.	Power High Ch. / Freq.	Tune-up limit (dBm)	MPR (dB)
Channel				18700	18900	19100		
Frequency (MHz)				1860	1880	1900		
20	QPSK	1	0	23.30	23.40	23.42	24	0
20	QPSK	1	49	22.84	22.84	22.72		
20	QPSK	1	99	23.06	22.96	22.78		
20	QPSK	50	0	22.20	22.29	22.20	23	1
20	QPSK	50	24	22.01	21.93	21.88		
20	QPSK	50	50	21.94	21.90	21.72		
20	QPSK	100	0	22.14	22.15	21.99		
20	16QAM	1	0	22.29	22.30	22.14	23	1
20	16QAM	1	49	22.12	22.10	21.93		
20	16QAM	1	99	22.27	22.22	22.03		
20	16QAM	50	0	21.33	21.19	21.14	22	2
20	16QAM	50	24	20.97	20.94	20.81		
20	16QAM	50	50	20.95	20.88	20.72		
20	16QAM	100	0	21.14	21.09	20.95		
Channel				18675	18900	19125	Tune-up limit (dBm)	MPR (dB)
Frequency (MHz)				1857.5	1880	1902.5		
15	QPSK	1	0	23.14	23.20	22.96	24	0
15	QPSK	1	37	22.73	22.74	22.61		
15	QPSK	1	74	22.99	22.92	22.58		
15	QPSK	36	0	22.13	22.20	22.10	23	1
15	QPSK	36	20	21.89	21.85	21.77		
15	QPSK	36	39	21.86	21.79	21.62		
15	QPSK	75	0	22.08	22.05	21.91		
15	16QAM	1	0	22.21	22.26	21.97	23	1
15	16QAM	1	37	22.02	21.98	21.76		
15	16QAM	1	74	22.19	22.13	21.91		
15	16QAM	36	0	21.21	21.11	20.99	22	2
15	16QAM	36	20	20.81	20.89	20.75		
15	16QAM	36	39	20.86	20.80	20.61		
15	16QAM	75	0	21.03	21.02	20.85		
Channel				18650	18900	19150	Tune-up limit (dBm)	MPR (dB)
Frequency (MHz)				1855	1880	1905		
10	QPSK	1	0	23.19	23.13	22.88	24	0
10	QPSK	1	25	22.71	22.69	22.49		
10	QPSK	1	49	22.95	22.77	22.58		
10	QPSK	25	0	22.05	22.18	21.99	23	1
10	QPSK	25	12	21.95	21.72	21.73		
10	QPSK	25	25	21.75	21.84	21.60		
10	QPSK	50	0	22.05	21.92	21.87		
10	16QAM	1	0	22.14	22.17	21.97	23	1
10	16QAM	1	25	21.96	22.03	21.70		
10	16QAM	1	49	22.16	22.10	21.95		
10	16QAM	25	0	21.14	21.09	21.01	22	2
10	16QAM	25	12	20.76	20.80	20.68		
10	16QAM	25	25	20.76	20.77	20.52		
10	16QAM	50	0	20.95	20.98	20.77		



Channel				18625	18900	19175	Tune-up limit (dBm)	MPR (dB)
Frequency (MHz)				1852.5	1880	1907.5		
5	QPSK	1	0	22.93	23.01	22.86	24	0
5	QPSK	1	12	22.63	22.70	22.45		
5	QPSK	1	24	22.83	22.74	22.59		
5	QPSK	12	0	21.92	22.09	22.11	23	1
5	QPSK	12	7	21.80	21.72	21.67		
5	QPSK	12	13	21.66	21.67	21.53		
5	QPSK	25	0	21.93	22.03	21.88	23	1
5	16QAM	1	0	22.04	22.14	21.93		
5	16QAM	1	12	21.91	21.84	21.71		
5	16QAM	1	24	22.05	22.04	21.83	22	2
5	16QAM	12	0	21.14	21.03	20.83		
5	16QAM	12	7	20.80	20.70	20.53		
5	16QAM	12	13	20.75	20.71	20.60	22	2
5	16QAM	12	13	20.75	20.71	20.60		
5	16QAM	25	0	20.99	20.94	20.76		
Channel				18615	18900	19185	Tune-up limit (dBm)	MPR (dB)
Frequency (MHz)				1851.5	1880	1908.5		
3	QPSK	1	0	22.98	22.98	22.91	24	0
3	QPSK	1	8	22.59	22.60	22.45		
3	QPSK	1	14	22.80	22.68	22.50		
3	QPSK	8	0	21.94	22.18	21.98	23	1
3	QPSK	8	4	21.72	21.58	21.79		
3	QPSK	8	7	21.56	21.73	21.44		
3	QPSK	15	0	21.83	22.01	21.71	23	1
3	16QAM	1	0	22.06	22.04	21.89		
3	16QAM	1	8	21.91	21.75	21.55		
3	16QAM	1	14	21.95	22.05	21.83	22	2
3	16QAM	8	0	21.02	21.01	20.89		
3	16QAM	8	4	20.69	20.61	20.58		
3	16QAM	8	7	20.67	20.75	20.45	22	2
3	16QAM	8	7	20.67	20.75	20.45		
3	16QAM	15	0	20.92	20.91	20.67		
Channel				18607	18900	19193	Tune-up limit (dBm)	MPR (dB)
Frequency (MHz)				1850.7	1880	1909.3		
1.4	QPSK	1	0	22.90	22.97	22.87	24	0
1.4	QPSK	1	3	22.46	22.48	22.30		
1.4	QPSK	1	5	22.77	22.73	22.51		
1.4	QPSK	3	0	22.35	22.24	22.28		
1.4	QPSK	3	1	22.64	22.41	22.39		
1.4	QPSK	3	3	22.67	22.43	22.35		
1.4	QPSK	6	0	21.97	21.96	21.71	23	1
1.4	16QAM	1	0	21.99	22.06	21.91	23	1
1.4	16QAM	1	3	21.93	21.80	21.65		
1.4	16QAM	1	5	21.82	21.94	21.73		
1.4	16QAM	3	0	21.31	21.27	21.24		
1.4	16QAM	3	1	21.73	21.31	21.22		
1.4	16QAM	3	3	21.85	21.53	21.22		
1.4	16QAM	6	0	20.69	20.74	20.59	22	2



<LTE Band 4>

BW [MHz]	Modulation	RB Size	RB Offset	Power Low Ch. / Freq.	Power Middle Ch. / Freq.	Power High Ch. / Freq.	Tune-up limit (dBm)	MPR (dB)
Channel				20050	20175	20300		
Frequency (MHz)				1720	1732.5	1745		
20	QPSK	1	0	23.52	23.50	23.50	24	0
20	QPSK	1	49	22.77	22.84	22.58		
20	QPSK	1	99	22.89	22.90	22.87		
20	QPSK	50	0	22.08	22.27	22.09	23	1
20	QPSK	50	24	21.82	21.79	21.72		
20	QPSK	50	50	21.73	21.60	21.72		
20	QPSK	100	0	22.00	22.18	21.87		
20	16QAM	1	0	22.18	22.34	22.31	23	1
20	16QAM	1	49	22.10	21.92	21.82		
20	16QAM	1	99	22.16	22.03	22.05		
20	16QAM	50	0	21.05	21.09	21.04	22	2
20	16QAM	50	24	20.78	20.79	20.68		
20	16QAM	50	50	20.66	20.59	20.70		
20	16QAM	100	0	20.99	21.01	20.85		
Channel				20025	20175	20325	Tune-up limit (dBm)	MPR (dB)
Frequency (MHz)				1717.5	1732.5	1747.5		
15	QPSK	1	0	23.13	23.18	23.15	24	0
15	QPSK	1	37	22.74	22.66	22.54		
15	QPSK	1	74	22.88	22.90	22.85		
15	QPSK	36	0	22.07	22.16	22.00	23	1
15	QPSK	36	20	21.78	21.68	21.57		
15	QPSK	36	39	21.65	21.62	21.70		
15	QPSK	75	0	21.92	22.14	21.83	23	1
15	16QAM	1	0	22.07	22.27	22.25		
15	16QAM	1	37	22.11	21.90	21.87		
15	16QAM	1	74	22.12	22.05	22.07		
15	16QAM	36	0	21.00	21.05	21.05	22	2
15	16QAM	36	20	20.77	20.66	20.60		
15	16QAM	36	39	20.59	20.52	20.63		
15	16QAM	75	0	20.83	20.95	20.86		
Channel				20000	20175	20350	Tune-up limit (dBm)	MPR (dB)
Frequency (MHz)				1715	1732.5	1750		
10	QPSK	1	0	23.13	23.22	23.24	24	0
10	QPSK	1	25	22.77	22.60	22.54		
10	QPSK	1	49	22.84	22.86	22.78		
10	QPSK	25	0	22.04	22.16	22.02	23	1
10	QPSK	25	12	21.77	21.67	21.56		
10	QPSK	25	25	21.70	21.63	21.59		
10	QPSK	50	0	21.84	22.02	21.80	23	1
10	16QAM	1	0	22.10	22.27	22.10		
10	16QAM	1	25	21.94	21.85	21.73		
10	16QAM	1	49	22.07	21.98	21.99		
10	16QAM	25	0	20.96	20.99	21.00	22	2
10	16QAM	25	12	20.67	20.65	20.55		
10	16QAM	25	25	20.55	20.57	20.62		
10	16QAM	50	0	20.77	20.90	20.76		



Channel				19975	20175	20375	Tune-up limit (dBm)	MPR (dB)
Frequency (MHz)				1712.5	1732.5	1752.5		
5	QPSK	1	0	23.07	23.17	23.19	24	0
5	QPSK	1	12	22.68	22.56	22.51		
5	QPSK	1	24	22.83	22.77	22.79		
5	QPSK	12	0	22.02	22.10	22.01	23	1
5	QPSK	12	7	21.65	21.61	21.49		
5	QPSK	12	13	21.67	21.53	21.53		
5	QPSK	25	0	21.83	21.86	21.73	23	1
5	16QAM	1	0	22.00	22.26	22.20		
5	16QAM	1	12	21.90	21.83	21.70		
5	16QAM	1	24	22.08	21.87	22.00	22	2
5	16QAM	12	0	20.87	21.00	21.00		
5	16QAM	12	7	20.63	20.60	20.56		
5	16QAM	12	13	20.55	20.44	20.67	22	2
5	16QAM	25	0	20.71	20.81	20.64		
5	16QAM	25	0	20.71	20.81	20.64		
Channel				19965	20175	20385	Tune-up limit (dBm)	MPR (dB)
Frequency (MHz)				1711.5	1732.5	1753.5		
3	QPSK	1	0	23.04	23.13	23.13	24	0
3	QPSK	1	8	22.60	22.45	22.47		
3	QPSK	1	14	22.66	22.86	22.69		
3	QPSK	8	0	22.04	22.05	21.84	23	1
3	QPSK	8	4	21.70	21.46	21.47		
3	QPSK	8	7	21.57	21.59	21.50		
3	QPSK	15	0	21.72	21.94	21.72	23	1
3	16QAM	1	0	21.99	22.21	22.19		
3	16QAM	1	8	21.88	21.69	21.63		
3	16QAM	1	14	21.96	21.96	21.90	22	2
3	16QAM	8	0	20.88	20.95	20.97		
3	16QAM	8	4	20.52	20.61	20.57		
3	16QAM	8	7	20.46	20.42	20.54	22	2
3	16QAM	8	7	20.46	20.42	20.54		
3	16QAM	15	0	20.68	20.90	20.62		
Channel				19957	20175	20393	Tune-up limit (dBm)	MPR (dB)
Frequency (MHz)				1710.7	1732.5	1754.3		
1.4	QPSK	1	0	22.98	23.13	23.14	24	0
1.4	QPSK	1	3	22.59	22.42	22.35		
1.4	QPSK	1	5	22.66	22.82	22.72		
1.4	QPSK	3	0	22.74	22.43	22.37		
1.4	QPSK	3	1	22.75	22.49	22.52		
1.4	QPSK	3	3	22.85	22.56	22.42		
1.4	QPSK	6	0	21.65	21.88	21.68	23	1
1.4	16QAM	1	0	21.87	22.22	22.23	23	1
1.4	16QAM	1	3	21.80	21.74	21.67		
1.4	16QAM	1	5	21.96	21.90	21.86		
1.4	16QAM	3	0	21.80	21.46	21.37		
1.4	16QAM	3	1	21.74	21.42	21.43		
1.4	16QAM	3	3	21.91	21.52	21.45		
1.4	16QAM	6	0	20.57	20.82	20.49	22	2



<LTE Band 5>

BW [MHz]	Modulation	RB Size	RB Offset	Power Low Ch. / Freq.	Power Middle Ch. / Freq.	Power High Ch. / Freq.	Tune-up limit (dBm)	MPR (dB)
Channel				20450	20525	20600		
Frequency (MHz)				829	836.5	844		
10	QPSK	1	0	23.54	23.50	23.50	24	0
10	QPSK	1	25	22.29	22.32	22.29		
10	QPSK	1	49	22.17	22.11	22.08		
10	QPSK	25	0	21.22	21.29	21.35	23	1
10	QPSK	25	12	21.09	21.17	21.23		
10	QPSK	25	25	21.18	21.19	21.25		
10	QPSK	50	0	21.24	21.31	21.08	23	1
10	16QAM	1	0	21.55	21.73	21.66		
10	16QAM	1	25	21.56	21.61	21.55		
10	16QAM	1	49	21.37	21.26	21.29	22	2
10	16QAM	25	0	20.25	20.09	20.12		
10	16QAM	25	12	20.27	20.11	20.24		
10	16QAM	25	25	20.26	20.32	20.11	22	2
10	16QAM	50	0	20.25	20.09	20.09		
Channel				20425	20525	20625	Tune-up limit (dBm)	MPR (dB)
Frequency (MHz)				826.5	836.5	846.5		
5	QPSK	1	0	22.30	22.43	22.32	24	0
5	QPSK	1	12	22.17	22.20	22.29		
5	QPSK	1	24	22.18	22.05	22.03		
5	QPSK	12	0	21.07	21.21	21.38	23	1
5	QPSK	12	7	21.07	21.14	21.16		
5	QPSK	12	13	21.14	21.13	21.18		
5	QPSK	25	0	21.16	21.15	21.24	23	1
5	16QAM	1	0	21.51	21.53	21.54		
5	16QAM	1	12	21.52	21.70	21.46		
5	16QAM	1	24	21.36	21.24	21.22	22	2
5	16QAM	12	0	20.15	20.17	20.07		
5	16QAM	12	7	20.25	20.23	20.14		
5	16QAM	12	13	20.13	20.20	20.22	22	2
5	16QAM	25	0	20.09	20.04	20.13		
Channel				20415	20525	20635	Tune-up limit (dBm)	MPR (dB)
Frequency (MHz)				825.5	836.5	847.5		
3	QPSK	1	0	22.21	22.34	22.37	24	0
3	QPSK	1	8	22.07	22.10	22.14		
3	QPSK	1	14	22.10	22.24	22.23		
3	QPSK	8	0	21.22	21.14	21.25	23	1
3	QPSK	8	4	21.09	21.10	21.29		
3	QPSK	8	7	21.22	21.20	21.14		
3	QPSK	15	0	21.07	21.19	21.12	23	1
3	16QAM	1	0	21.58	21.64	21.53		
3	16QAM	1	8	21.49	21.65	21.40		
3	16QAM	1	14	21.31	21.18	21.19	22	2
3	16QAM	8	0	20.16	20.20	20.06		
3	16QAM	8	4	20.03	20.17	20.04		
3	16QAM	8	7	20.00	20.06	20.11	22	2
3	16QAM	15	0	20.11	20.16	20.25		



Channel				20407	20525	20643	Tune-up limit (dBm)	MPR (dB)
Frequency (MHz)				824.7	836.5	848.3		
1.4	QPSK	1	0	22.24	22.34	22.30	24	0
1.4	QPSK	1	3	22.14	22.10	22.13		
1.4	QPSK	1	5	22.16	22.10	22.15		
1.4	QPSK	3	0	22.10	22.20	22.09		
1.4	QPSK	3	1	22.16	22.27	22.13		
1.4	QPSK	3	3	22.11	22.28	22.15		
1.4	QPSK	6	0	21.04	21.12	21.09	23	1
1.4	16QAM	1	0	21.43	21.63	21.36	23	1
1.4	16QAM	1	3	21.51	21.53	21.36		
1.4	16QAM	1	5	21.24	21.13	21.10		
1.4	16QAM	3	0	21.21	21.33	21.27		
1.4	16QAM	3	1	21.17	21.26	21.20		
1.4	16QAM	3	3	21.28	21.31	21.28		
1.4	16QAM	6	0	20.04	20.08	20.14	22	2



<LTE Band 7>

BW [MHz]	Modulation	RB Size	RB Offset	Power Low Ch. / Freq.	Power Middle Ch. / Freq.	Power High Ch. / Freq.	Tune-up limit (dBm)	MPR (dB)
Channel				20850	21100	21350		
Frequency (MHz)				2510	2535	2560		
20	QPSK	1	0	22.02	22.10	22.03		
20	QPSK	1	49	21.11	21.15	21.02	23	0
20	QPSK	1	99	21.10	21.10	21.05		
20	QPSK	50	0	20.12	20.14	20.02		
20	QPSK	50	24	20.07	20.07	20.01	22	1
20	QPSK	50	50	20.03	20.02	20.01		
20	QPSK	100	0	20.03	20.05	20.02		
20	16QAM	1	0	20.37	20.41	20.23	22	1
20	16QAM	1	49	20.31	20.38	20.17		
20	16QAM	1	99	20.05	20.01	20.02		
20	16QAM	50	0	19.20	19.17	19.03	21	2
20	16QAM	50	24	19.15	19.13	19.01		
20	16QAM	50	50	19.03	19.05	19.06		
20	16QAM	100	0	19.14	19.18	19.10		
Channel				20825	21100	21375		
Frequency (MHz)				2507.5	2535	2562.5		
15	QPSK	1	0	21.03	21.13	21.06		
15	QPSK	1	37	21.03	21.11	21.01	23	0
15	QPSK	1	74	21.03	21.00	21.03		
15	QPSK	36	0	20.06	20.14	20.04		
15	QPSK	36	20	20.01	20.14	20.06	22	1
15	QPSK	36	39	20.07	20.01	20.00		
15	QPSK	75	0	20.01	20.08	20.08		
15	16QAM	1	0	20.32	20.40	20.12	22	1
15	16QAM	1	37	20.34	20.31	20.05		
15	16QAM	1	74	20.00	20.05	20.05		
15	16QAM	36	0	19.13	19.14	19.05	21	2
15	16QAM	36	20	19.22	19.14	19.01		
15	16QAM	36	39	19.08	19.00	19.05		
15	16QAM	75	0	19.05	19.11	19.04		
Channel				20800	21100	21400		
Frequency (MHz)				2505	2535	2565		
10	QPSK	1	0	21.03	21.14	21.09		
10	QPSK	1	25	21.08	21.13	21.03	23	0
10	QPSK	1	49	21.00	21.06	21.01		
10	QPSK	25	0	20.05	20.11	20.06		
10	QPSK	25	12	20.05	20.07	20.09	22	1
10	QPSK	25	25	20.06	20.07	20.07		
10	QPSK	50	0	20.07	20.06	20.00		
10	16QAM	1	0	20.40	20.40	20.13	22	1
10	16QAM	1	25	20.35	20.31	20.11		
10	16QAM	1	49	20.08	20.09	20.01		
10	16QAM	25	0	19.10	19.21	19.08	21	2
10	16QAM	25	12	19.08	19.17	19.10		
10	16QAM	25	25	19.03	19.04	19.01		
10	16QAM	50	0	19.04	19.03	19.03		



Channel				20775	21100	21425	Tune-up limit (dBm)	MPR (dB)
Frequency (MHz)				2502.5	2535	2567.5		
5	QPSK	1	0	21.07	21.13	21.09	23	0
5	QPSK	1	12	21.01	21.04	21.00		
5	QPSK	1	24	21.05	21.00	21.00		
5	QPSK	12	0	20.06	20.07	20.00	22	1
5	QPSK	12	7	20.13	20.08	20.08		
5	QPSK	12	13	20.03	20.03	20.00		
5	QPSK	25	0	20.06	20.09	20.08		
5	16QAM	1	0	20.36	20.45	20.17	22	1
5	16QAM	1	12	20.21	20.26	20.13		
5	16QAM	1	24	20.08	20.01	20.05		
5	16QAM	12	0	19.09	19.06	19.09	21	2
5	16QAM	12	7	19.11	19.18	19.01		
5	16QAM	12	13	19.08	19.00	19.09		
5	16QAM	25	0	19.04	19.03	19.05		



<LTE Band 12>

BW [MHz]	Modulation	RB Size	RB Offset	Power Low Ch. / Freq.	Power Middle Ch. / Freq.	Power High Ch. / Freq.	Tune-up limit (dBm)	MPR (dB)
Channel				23060	23095	23130		
Frequency (MHz)				704	707.5	711		
10	QPSK	1	0	22.61	22.58	22.60	24	0
10	QPSK	1	25	22.27	22.33	22.27		
10	QPSK	1	49	22.29	22.31	22.13		
10	QPSK	25	0	21.23	21.36	21.25	23	1
10	QPSK	25	12	21.23	21.30	21.15		
10	QPSK	25	25	21.20	21.32	21.23		
10	QPSK	50	0	21.15	21.30	21.16		
10	16QAM	1	0	21.66	21.66	21.52	23	1
10	16QAM	1	25	21.63	21.58	21.46		
10	16QAM	1	49	21.54	21.45	21.39		
10	16QAM	25	0	20.24	20.25	20.30	22	2
10	16QAM	25	12	20.34	20.36	20.23		
10	16QAM	25	25	20.25	20.34	20.23		
10	16QAM	50	0	20.24	20.32	20.23		
Channel				23035	23095	23155		
Frequency (MHz)				701.5	707.5	713.5		
5	QPSK	1	0	22.32	22.29	22.26	24	0
5	QPSK	1	12	22.28	22.36	22.13		
5	QPSK	1	24	22.31	22.36	22.12		
5	QPSK	12	0	21.21	21.37	21.13	23	1
5	QPSK	12	7	21.24	21.27	21.20		
5	QPSK	12	13	21.26	21.36	21.21		
5	QPSK	25	0	21.24	21.36	21.14		
5	16QAM	1	0	21.57	21.72	21.45	23	1
5	16QAM	1	12	21.65	21.73	21.57		
5	16QAM	1	24	21.46	21.61	21.44		
5	16QAM	12	0	20.24	20.28	20.14	22	2
5	16QAM	12	7	20.17	20.25	20.14		
5	16QAM	12	13	20.29	20.35	20.22		
5	16QAM	25	0	20.25	20.21	20.09		
Channel				23025	23095	23165		
Frequency (MHz)				700.5	707.5	714.5		
3	QPSK	1	0	22.33	22.29	22.22	24	0
3	QPSK	1	8	22.25	22.33	22.14		
3	QPSK	1	14	22.25	22.26	22.11		
3	QPSK	8	0	21.24	21.39	21.20	23	1
3	QPSK	8	4	21.34	21.35	21.14		
3	QPSK	8	7	21.23	21.25	21.09		
3	QPSK	15	0	21.27	21.40	21.25		
3	16QAM	1	0	21.57	21.74	21.39	23	1
3	16QAM	1	8	21.67	21.66	21.57		
3	16QAM	1	14	21.44	21.49	21.42		
3	16QAM	8	0	20.39	20.33	20.23	22	2
3	16QAM	8	4	20.35	20.41	20.18		
3	16QAM	8	7	20.34	20.34	20.23		
3	16QAM	15	0	20.25	20.36	20.25		



Channel				23017	23095	23173	Tune-up limit (dBm)	MPR (dB)
Frequency (MHz)				699.7	707.5	715.3		
1.4	QPSK	1	0	22.30	22.29	22.27	24	0
1.4	QPSK	1	3	22.33	22.22	22.09		
1.4	QPSK	1	5	22.36	22.32	22.27		
1.4	QPSK	3	0	22.25	22.25	22.18		
1.4	QPSK	3	1	22.26	22.31	22.28		
1.4	QPSK	3	3	22.30	22.32	22.18		
1.4	QPSK	6	0	21.32	21.21	21.04	23	1
1.4	16QAM	1	0	21.73	21.76	21.51	23	1
1.4	16QAM	1	3	21.70	21.68	21.58		
1.4	16QAM	1	5	21.71	21.69	21.58		
1.4	16QAM	3	0	21.33	21.18	21.24		
1.4	16QAM	3	1	21.39	21.27	21.14		
1.4	16QAM	3	3	21.33	21.42	21.16		
1.4	16QAM	6	0	20.34	20.31	20.09	22	2



<LTE Band 13>

BW [MHz]	Modulation	RB Size	RB Offset	Power Low Ch. / Freq.	Power Middle Ch. / Freq.	Power High Ch. / Freq.	Tune-up limit (dBm)	MPR (dB)
Channel				23230				
Frequency (MHz)				782				
10	QPSK	1	0	22.37			24	0
10	QPSK	1	25	23.74				
10	QPSK	1	49	23.59				
10	QPSK	25	0	22.50			23	1
10	QPSK	25	12	22.47				
10	QPSK	25	25	22.47				
10	QPSK	50	0	22.49				
10	16QAM	1	0	21.42			23	1
10	16QAM	1	25	22.86				
10	16QAM	1	49	22.82				
10	16QAM	25	0	21.50			22	2
10	16QAM	25	12	21.48				
10	16QAM	25	25	21.44				
10	16QAM	50	0	21.34				
Channel				23205	23230	23255	Tune-up limit (dBm)	MPR (dB)
Frequency (MHz)				779.5	782	784.5		
5	QPSK	1	0	23.22	23.78	23.62	24	0
5	QPSK	1	12	23.22	23.71	23.67		
5	QPSK	1	24	23.25	23.54	23.53		
5	QPSK	12	0	23.73	23.71	23.62	23	1
5	QPSK	12	7	22.58	22.71	22.91		
5	QPSK	12	13	22.73	22.75	22.81		
5	QPSK	25	0	22.71	22.76	22.84	23	1
5	16QAM	1	0	22.75	22.67	22.88		
5	16QAM	1	12	22.35	23.08	23.00		
5	16QAM	1	24	22.89	22.95	22.87		
5	16QAM	12	0	23.00	22.99	23.03	22	2
5	16QAM	12	7	21.39	21.65	21.93		
5	16QAM	12	13	21.84	21.65	21.88		
5	16QAM	25	0	21.59	21.75	21.82		



<LTE Band 25>

BW [MHz]	Modulation	RB Size	RB Offset	Power Low Ch. / Freq.	Power Middle Ch. / Freq.	Power High Ch. / Freq.	Tune-up limit (dBm)	MPR (dB)
Channel				26140	26340	26590		
Frequency (MHz)				1860	1880	1905		
20	QPSK	1	0	23.50	23.48	23.54	24	0
20	QPSK	1	49	22.43	22.34	22.29		
20	QPSK	1	99	22.68	22.57	22.42		
20	QPSK	50	0	21.78	21.85	21.80	23	1
20	QPSK	50	24	21.59	21.41	21.38		
20	QPSK	50	50	21.46	21.45	21.31		
20	QPSK	100	0	21.52	21.73	21.65		
20	16QAM	1	0	22.34	22.66	22.38	23	1
20	16QAM	1	49	21.70	21.55	21.43		
20	16QAM	1	99	21.85	21.76	21.62		
20	16QAM	50	0	20.91	20.74	20.64	22	2
20	16QAM	50	24	20.59	20.48	20.37		
20	16QAM	50	50	20.41	20.48	20.30		
20	16QAM	100	0	20.73	20.55	20.60		
Channel				26115	26340	26615		
Frequency (MHz)				1857.5	1880	1907.5		
15	QPSK	1	0	23.26	23.32	23.27	24	0
15	QPSK	1	37	22.32	22.31	22.36		
15	QPSK	1	74	22.55	22.51	22.38		
15	QPSK	36	0	21.69	21.79	21.81	23	1
15	QPSK	36	20	21.63	21.34	21.40		
15	QPSK	36	39	21.40	21.41	21.36		
15	QPSK	75	0	21.50	21.58	21.56	23	1
15	16QAM	1	0	22.26	22.48	22.38		
15	16QAM	1	37	21.57	21.51	21.45		
15	16QAM	1	74	21.90	21.65	21.66		
15	16QAM	36	0	20.80	20.62	20.66	22	2
15	16QAM	36	20	20.49	20.50	20.41		
15	16QAM	36	39	20.29	20.46	20.32		
15	16QAM	75	0	20.67	20.54	20.57		
Channel				26090	26340	26640		
Frequency (MHz)				1855	1880	1910		
10	QPSK	1	0	23.16	23.30	23.13	24	0
10	QPSK	1	25	22.29	22.34	22.38		
10	QPSK	1	49	22.49	22.51	22.27		
10	QPSK	25	0	21.66	21.68	21.67	23	1
10	QPSK	25	12	21.60	21.26	21.25		
10	QPSK	25	25	21.33	21.45	21.40		
10	QPSK	50	0	21.53	21.52	21.65	23	1
10	16QAM	1	0	22.28	22.52	22.36		
10	16QAM	1	25	21.58	21.47	21.38		
10	16QAM	1	49	21.87	21.58	21.49		
10	16QAM	25	0	20.84	20.68	20.61	22	2
10	16QAM	25	12	20.45	20.50	20.44		
10	16QAM	25	25	20.39	20.38	20.43		
10	16QAM	50	0	20.53	20.39	20.51		



Channel				26065	26340	26665	Tune-up limit (dBm)	MPR (dB)
Frequency (MHz)				1852.5	1880	1912.5		
5	QPSK	1	0	23.08	23.24	23.09	24	0
5	QPSK	1	12	22.13	22.34	22.32		
5	QPSK	1	24	22.40	22.40	22.40		
5	QPSK	12	0	21.57	21.71	21.53	23	1
5	QPSK	12	7	21.51	21.57	21.62		
5	QPSK	12	13	21.25	21.43	21.37		
5	QPSK	25	0	21.46	21.49	21.60	23	1
5	16QAM	1	0	22.34	22.49	22.26		
5	16QAM	1	12	21.67	21.46	21.25		
5	16QAM	1	24	21.77	21.50	21.49	22	2
5	16QAM	12	0	20.69	20.59	20.54		
5	16QAM	12	7	20.44	20.45	20.38		
5	16QAM	12	13	20.35	20.38	20.39	22	2
5	16QAM	25	0	20.46	20.40	20.54		
5	16QAM	25	0	20.46	20.40	20.54		
Channel				26055	26340	26675	Tune-up limit (dBm)	MPR (dB)
Frequency (MHz)				1851.5	1880	1913.5		
3	QPSK	1	0	23.06	23.24	23.09	24	0
3	QPSK	1	8	22.14	22.29	22.30		
3	QPSK	1	14	22.31	22.34	22.32		
3	QPSK	8	0	21.58	21.60	21.51	23	1
3	QPSK	8	4	21.51	21.54	21.56		
3	QPSK	8	7	21.23	21.38	21.29		
3	QPSK	15	0	21.49	21.47	21.51	23	1
3	16QAM	1	0	22.31	22.37	22.12		
3	16QAM	1	8	21.58	21.57	21.60		
3	16QAM	1	14	21.62	21.52	21.40	22	2
3	16QAM	8	0	20.78	20.65	20.61		
3	16QAM	8	4	20.29	20.43	20.28		
3	16QAM	8	7	20.34	20.37	20.32	22	2
3	16QAM	8	7	20.34	20.37	20.32		
3	16QAM	15	0	20.44	20.40	20.39		
Channel				26047	26340	26683	Tune-up limit (dBm)	MPR (dB)
Frequency (MHz)				1850.7	1880	1914.3		
1.4	QPSK	1	0	22.95	23.18	22.94	24	0
1.4	QPSK	1	3	22.13	22.27	22.23		
1.4	QPSK	1	5	22.39	22.26	22.26		
1.4	QPSK	3	0	22.75	22.81	22.70		
1.4	QPSK	3	1	22.77	22.91	22.72		
1.4	QPSK	3	3	22.90	22.82	22.77		
1.4	QPSK	6	0	21.38	21.42	21.48	23	1
1.4	16QAM	1	0	22.10	22.24	22.22	23	1
1.4	16QAM	1	3	21.48	21.34	21.32		
1.4	16QAM	1	5	21.65	21.57	21.37		
1.4	16QAM	3	0	21.57	21.63	21.70		
1.4	16QAM	3	1	21.60	21.58	21.73		
1.4	16QAM	3	3	21.70	21.71	21.74		
1.4	16QAM	6	0	20.43	20.29	20.40	22	2



<LTE Band 26>

BW [MHz]	Modulation	RB Size	RB Offset	Power Low Ch. / Freq.	Power Middle Ch. / Freq.	Power High Ch. / Freq.	Tune-up limit (dBm)	MPR (dB)
Channel				26765	26865	26965		
Frequency (MHz)				821.5	831.5	841.5		
15	QPSK	1	0	23.12	23.87	23.98		
15	QPSK	1	37	22.35	22.25	22.34	24	0
15	QPSK	1	74	22.33	22.19	22.26		
15	QPSK	36	0	21.51	21.54	21.52		
15	QPSK	36	20	21.45	21.37	21.50	23	1
15	QPSK	36	39	21.32	21.15	21.38		
15	QPSK	75	0	21.48	21.49	21.41		
15	16QAM	1	0	21.77	21.87	21.76	23	1
15	16QAM	1	37	21.73	21.55	21.58		
15	16QAM	1	74	21.54	21.47	21.57		
15	16QAM	36	0	20.44	20.39	20.44	22	2
15	16QAM	36	20	20.48	20.36	20.42		
15	16QAM	36	39	20.28	20.15	20.24		
15	16QAM	75	0	20.37	20.33	20.39		
Channel				26740	26865	26990		
Frequency (MHz)				819	831.5	844		
10	QPSK	1	0	22.53	22.51	22.54		
10	QPSK	1	25	22.38	22.17	22.36	24	0
10	QPSK	1	49	22.20	22.15	22.18		
10	QPSK	25	0	21.47	21.44	21.48		
10	QPSK	25	12	21.38	21.25	21.47	23	1
10	QPSK	25	25	21.25	21.20	21.38		
10	QPSK	50	0	21.42	21.34	21.46		
10	16QAM	1	0	21.69	21.83	21.73	23	1
10	16QAM	1	25	21.55	21.43	21.56		
10	16QAM	1	49	21.48	21.37	21.51		
10	16QAM	25	0	20.50	20.32	20.41	22	2
10	16QAM	25	12	20.31	20.30	20.39		
10	16QAM	25	25	20.32	20.08	20.27		
10	16QAM	50	0	20.44	20.24	20.31		
Channel				26715	26865	27015		
Frequency (MHz)				816.5	831.5	846.5		
5	QPSK	1	0	22.46	22.51	22.47		
5	QPSK	1	12	22.27	22.17	22.30	24	0
5	QPSK	1	24	22.14	22.07	22.08		
5	QPSK	12	0	21.39	21.33	21.41		
5	QPSK	12	7	21.34	21.21	21.43	23	1
5	QPSK	12	13	21.32	21.08	21.35		
5	QPSK	25	0	21.42	21.30	21.44		
5	16QAM	1	0	21.70	21.75	21.71	23	1
5	16QAM	1	12	21.51	21.46	21.58		
5	16QAM	1	24	21.45	21.41	21.43		
5	16QAM	12	0	20.39	20.22	20.42	22	2
5	16QAM	12	7	20.27	20.23	20.26		
5	16QAM	12	13	20.25	20.09	20.15		
5	16QAM	25	0	20.43	20.21	20.31		



Channel				26705	26865	27025	Tune-up limit (dBm)	MPR (dB)
Frequency (MHz)				815.5	831.5	847.5		
3	QPSK	1	0	22.33	22.42	22.43	24	0
3	QPSK	1	8	22.24	22.22	22.22		
3	QPSK	1	14	22.20	22.07	22.18		
3	QPSK	8	0	21.37	21.29	21.40	23	1
3	QPSK	8	4	21.28	21.19	21.31		
3	QPSK	8	7	21.23	21.10	21.26		
3	QPSK	15	0	21.35	21.24	21.30	23	1
3	16QAM	1	0	21.68	21.72	21.68		
3	16QAM	1	8	21.39	21.39	21.48		
3	16QAM	1	14	21.34	21.35	21.38	22	2
3	16QAM	8	0	20.40	20.14	20.38		
3	16QAM	8	4	20.25	20.25	20.24		
3	16QAM	8	7	20.24	20.22	20.18	22	2
3	16QAM	15	0	20.39	20.15	20.24		
Channel				26697	26865	27033	Tune-up limit (dBm)	MPR (dB)
Frequency (MHz)				814.7	831.5	848.3		
1.4	QPSK	1	0	22.34	22.35	22.34	24	0
1.4	QPSK	1	3	22.17	22.20	22.22		
1.4	QPSK	1	5	22.05	22.06	22.06		
1.4	QPSK	3	0	22.25	22.26	22.35		
1.4	QPSK	3	1	22.19	22.07	22.28		
1.4	QPSK	3	3	22.22	22.06	22.15		
1.4	QPSK	6	0	21.23	21.20	21.24	23	1
1.4	16QAM	1	0	21.69	21.66	21.70	23	1
1.4	16QAM	1	3	21.32	21.34	21.45		
1.4	16QAM	1	5	21.35	21.27	21.33		
1.4	16QAM	3	0	21.34	21.18	21.40		
1.4	16QAM	3	1	21.18	21.07	21.17		
1.4	16QAM	3	3	21.20	21.18	21.13		
1.4	16QAM	6	0	20.31	20.01	20.20	22	2



Reduced Power Mode

<LTE Band 2>

BW [MHz]	Modulation	RB Size	RB Offset	Power Low Ch. / Freq.	Power Middle Ch. / Freq.	Power High Ch. / Freq.	Tune-up limit (dBm)	MPR (dB)
Channel				18700	18900	19100		
Frequency (MHz)				1860	1880	1900		
20	QPSK	1	0	16.71	16.84	16.75	17.5	0
20	QPSK	1	49	15.61	15.60	15.59		
20	QPSK	1	99	15.81	15.78	15.81		
20	QPSK	50	0	16.08	16.09	16.09	17.5	0
20	QPSK	50	24	15.82	15.79	15.80		
20	QPSK	50	50	15.79	15.62	15.68		
20	QPSK	100	0	15.98	15.99	15.82		
20	16QAM	1	0	16.53	16.53	16.52	17.5	0
20	16QAM	1	49	15.88	15.91	15.90		
20	16QAM	1	99	16.09	16.06	16.12		
20	16QAM	50	0	16.00	16.10	16.03	17.5	0
20	16QAM	50	24	15.78	15.76	15.87		
20	16QAM	50	50	15.76	15.62	15.77		
20	16QAM	100	0	15.98	15.86	16.01		
Channel				18675	18900	19125	Tune-up limit (dBm)	MPR (dB)
Frequency (MHz)				1857.5	1880	1902.5		
15	QPSK	1	0	16.18	16.34	16.32	17.5	0
15	QPSK	1	37	15.96	15.83	15.82		
15	QPSK	1	74	15.76	15.65	15.74		
15	QPSK	36	0	16.00	15.96	15.90	17.5	0
15	QPSK	36	20	15.77	15.76	15.84		
15	QPSK	36	39	15.69	15.61	15.70		
15	QPSK	75	0	15.76	15.73	15.74		
15	16QAM	1	0	16.48	16.53	16.47	17.5	0
15	16QAM	1	37	15.98	15.87	16.08		
15	16QAM	1	74	16.02	15.90	15.98		
15	16QAM	36	0	15.92	16.01	15.90	17.5	0
15	16QAM	36	20	15.77	15.82	15.78		
15	16QAM	36	39	15.74	15.58	15.74		
15	16QAM	75	0	15.83	15.85	15.80		
Channel				18650	18900	19150	Tune-up limit (dBm)	MPR (dB)
Frequency (MHz)				1855	1880	1905		
10	QPSK	1	0	16.11	16.15	16.11	17.5	0
10	QPSK	1	25	15.86	15.79	15.95		
10	QPSK	1	49	15.83	15.64	15.72		
10	QPSK	25	0	15.93	15.96	15.93	17.5	0
10	QPSK	25	12	15.83	15.76	15.85		
10	QPSK	25	25	15.79	15.70	15.75		
10	QPSK	50	0	15.79	15.87	15.83		
10	16QAM	1	0	16.40	16.41	16.39	17.5	0
10	16QAM	1	25	16.13	15.99	16.08		
10	16QAM	1	49	16.02	15.88	16.04		
10	16QAM	25	0	15.96	15.97	15.86	17.5	0
10	16QAM	25	12	15.86	15.78	15.90		
10	16QAM	25	25	15.89	15.74	15.78		
10	16QAM	50	0	15.81	15.84	15.77		



Channel				18625	18900	19175	Tune-up limit (dBm)	MPR (dB)
Frequency (MHz)				1852.5	1880	1907.5		
5	QPSK	1	0	15.88	15.93	15.84	17.5	0
5	QPSK	1	12	15.75	15.78	15.88		
5	QPSK	1	24	15.70	15.58	15.77		
5	QPSK	12	0	15.79	15.85	15.85	17.5	0
5	QPSK	12	7	15.79	15.83	15.78		
5	QPSK	12	13	15.84	15.81	15.86		
5	QPSK	25	0	15.82	15.75	15.84	17.5	0
5	16QAM	1	0	16.22	16.25	16.13		
5	16QAM	1	12	16.05	16.10	16.18		
5	16QAM	1	24	15.98	16.00	16.03	17.5	0
5	16QAM	12	0	15.78	15.90	15.86		
5	16QAM	12	7	15.88	15.89	15.86		
5	16QAM	12	13	15.91	15.83	15.89	17.5	0
5	16QAM	25	0	15.90	15.83	15.81		
Channel				18615	18900	19185		
Frequency (MHz)				1851.5	1880	1908.5		
3	QPSK	1	0	15.93	15.89	15.89	17.5	0
3	QPSK	1	8	15.84	15.95	15.73		
3	QPSK	1	14	15.78	15.82	15.85		
3	QPSK	8	0	15.83	15.82	15.79	17.5	0
3	QPSK	8	4	15.86	15.93	15.83		
3	QPSK	8	7	15.86	15.86	15.84		
3	QPSK	15	0	15.79	15.87	15.86	17.5	0
3	16QAM	1	0	16.23	16.19	16.23		
3	16QAM	1	8	16.15	16.16	16.23		
3	16QAM	1	14	15.96	15.99	16.02	17.5	0
3	16QAM	8	0	15.88	15.91	15.96		
3	16QAM	8	4	15.91	15.98	15.86		
3	16QAM	8	7	15.90	15.93	15.89	17.5	0
3	16QAM	8	7	15.90	15.93	15.89		
3	16QAM	15	0	15.83	15.86	15.87		
Channel				18607	18900	19193	Tune-up limit (dBm)	MPR (dB)
Frequency (MHz)				1850.7	1880	1909.3		
1.4	QPSK	1	0	15.88	15.95	15.90	17.5	0
1.4	QPSK	1	3	15.80	15.90	15.82		
1.4	QPSK	1	5	15.81	15.85	15.83		
1.4	QPSK	3	0	15.72	15.72	15.72	17.5	0
1.4	QPSK	3	1	15.83	15.81	15.77		
1.4	QPSK	3	3	15.85	15.89	15.80		
1.4	QPSK	6	0	15.80	15.79	15.82	17.5	0
1.4	16QAM	1	0	16.22	16.18	16.15	17.5	0
1.4	16QAM	1	3	16.12	16.12	16.17		
1.4	16QAM	1	5	16.02	16.17	16.10		
1.4	16QAM	3	0	15.83	15.82	15.86	17.5	0
1.4	16QAM	3	1	15.84	15.92	15.89		
1.4	16QAM	3	3	15.89	15.93	15.94		
1.4	16QAM	6	0	15.85	15.90	15.85	17.5	0



<LTE Band 4>

BW [MHz]	Modulation	RB Size	RB Offset	Power Low Ch. / Freq.	Power Middle Ch. / Freq.	Power High Ch. / Freq.	Tune-up limit (dBm)	MPR (dB)
Channel				20050	20175	20300		
Frequency (MHz)				1720	1732.5	1745		
20	QPSK	1	0	16.93	16.96	16.99	17.5	0
20	QPSK	1	49	15.63	15.59	15.62		
20	QPSK	1	99	15.88	15.84	15.75		
20	QPSK	50	0	16.06	16.11	16.06	17.5	0
20	QPSK	50	24	15.69	15.80	15.78		
20	QPSK	50	50	15.76	15.60	15.68		
20	QPSK	100	0	15.86	15.91	15.91		
20	16QAM	1	0	16.48	16.49	16.45	17.5	0
20	16QAM	1	49	16.00	15.89	15.97		
20	16QAM	1	99	16.13	16.06	16.03		
20	16QAM	50	0	15.94	16.11	16.08	17.5	0
20	16QAM	50	24	15.65	15.77	15.81		
20	16QAM	50	50	15.72	15.62	15.66		
20	16QAM	100	0	15.80	15.97	15.95		
Channel				20025	20175	20325		
Frequency (MHz)				1717.5	1732.5	1747.5		
15	QPSK	1	0	16.22	16.29	16.20	17.5	0
15	QPSK	1	37	15.67	15.63	15.63		
15	QPSK	1	74	15.72	15.82	15.64		
15	QPSK	36	0	15.88	15.88	15.88	17.5	0
15	QPSK	36	20	15.67	15.75	15.76		
15	QPSK	36	39	15.62	15.63	15.70		
15	QPSK	75	0	15.81	15.77	15.91		
15	16QAM	1	0	16.43	16.50	16.42	17.5	0
15	16QAM	1	37	15.90	15.85	15.94		
15	16QAM	1	74	15.91	16.04	15.88		
15	16QAM	36	0	15.87	15.90	15.91	17.5	0
15	16QAM	36	20	15.70	15.77	15.71		
15	16QAM	36	39	15.74	15.66	15.71		
15	16QAM	75	0	15.77	15.89	15.92		
Channel				20000	20175	20350		
Frequency (MHz)				1715	1732.5	1750		
10	QPSK	1	0	15.82	15.97	15.86	17.5	0
10	QPSK	1	25	15.80	15.74	15.75		
10	QPSK	1	49	15.59	15.54	15.50		
10	QPSK	25	0	15.87	15.62	15.70	17.5	0
10	QPSK	25	12	15.70	15.63	15.78		
10	QPSK	25	25	15.51	15.56	15.59		
10	QPSK	50	0	15.74	15.64	15.60		
10	16QAM	1	0	16.12	16.27	16.12	17.5	0
10	16QAM	1	25	16.05	15.87	15.92		
10	16QAM	1	49	15.88	15.79	15.81		
10	16QAM	25	0	15.80	15.69	15.76	17.5	0
10	16QAM	25	12	15.73	15.59	15.78		
10	16QAM	25	25	15.64	15.61	15.65		
10	16QAM	50	0	15.79	15.59	15.62		



Channel				19975	20175	20375	Tune-up limit (dBm)	MPR (dB)
Frequency (MHz)				1712.5	1732.5	1752.5		
5	QPSK	1	0	15.70	15.76	15.79	17.5	0
5	QPSK	1	12	15.59	15.71	15.71		
5	QPSK	1	24	15.68	15.52	15.65		
5	QPSK	12	0	15.66	15.63	15.65	17.5	0
5	QPSK	12	7	15.75	15.76	15.61		
5	QPSK	12	13	15.73	15.64	15.64		
5	QPSK	25	0	15.77	15.71	15.52		
5	16QAM	1	0	16.07	16.14	15.94	17.5	0
5	16QAM	1	12	16.05	16.06	15.95		
5	16QAM	1	24	15.98	15.85	15.91		
5	16QAM	12	0	15.73	15.69	15.66	17.5	0
5	16QAM	12	7	15.72	15.75	15.66		
5	16QAM	12	13	15.74	15.63	15.67		
5	16QAM	25	0	15.75	15.68	15.52		
Channel				19965	20175	20385	Tune-up limit (dBm)	MPR (dB)
Frequency (MHz)				1711.5	1732.5	1753.5		
3	QPSK	1	0	15.61	15.83	15.68	17.5	0
3	QPSK	1	8	15.80	15.68	15.68		
3	QPSK	1	14	15.66	15.53	15.58		
3	QPSK	8	0	15.74	15.63	15.71	17.5	0
3	QPSK	8	4	15.83	15.59	15.60		
3	QPSK	8	7	15.76	15.51	15.63		
3	QPSK	15	0	15.81	15.60	15.61		
3	16QAM	1	0	15.82	16.09	15.94	17.5	0
3	16QAM	1	8	16.09	15.95	16.01		
3	16QAM	1	14	15.93	15.67	15.77		
3	16QAM	8	0	15.71	15.71	15.69	17.5	0
3	16QAM	8	4	15.81	15.69	15.59		
3	16QAM	8	7	15.82	15.62	15.64		
3	16QAM	15	0	15.73	15.54	15.68		
Channel				19957	20175	20393	Tune-up limit (dBm)	MPR (dB)
Frequency (MHz)				1710.7	1732.5	1754.3		
1.4	QPSK	1	0	15.73	15.75	15.65	17.5	0
1.4	QPSK	1	3	15.65	15.60	15.66		
1.4	QPSK	1	5	15.65	15.54	15.55		
1.4	QPSK	3	0	15.59	15.51	15.58		
1.4	QPSK	3	1	15.66	15.50	15.68		
1.4	QPSK	3	3	15.72	15.60	15.70		
1.4	QPSK	6	0	15.56	15.52	15.59	17.5	0
1.4	16QAM	1	0	15.85	16.00	15.97	17.5	0
1.4	16QAM	1	3	15.87	15.87	16.01		
1.4	16QAM	1	5	15.87	15.83	15.86		
1.4	16QAM	3	0	15.71	15.67	15.64		
1.4	16QAM	3	1	15.73	15.54	15.59		
1.4	16QAM	3	3	15.71	15.62	15.72		
1.4	16QAM	6	0	15.67	15.59	15.69	17.5	0



<LTE Band 5>

BW [MHz]	Modulation	RB Size	RB Offset	Power Low Ch. / Freq.	Power Middle Ch. / Freq.	Power High Ch. / Freq.	Tune-up limit (dBm)	MPR (dB)
Channel				20450	20525	20600		
Frequency (MHz)				829	836.5	844		
10	QPSK	1	0	19.95	20.03	20.04		
10	QPSK	1	25	19.93	19.91	19.89	21	0
10	QPSK	1	49	19.76	19.87	19.83		
10	QPSK	25	0	19.88	20.01	19.81		
10	QPSK	25	12	19.83	19.94	19.81	21	0
10	QPSK	25	25	19.75	19.90	19.79		
10	QPSK	50	0	19.84	20.05	19.76		
10	16QAM	1	0	20.01	20.00	19.95	21	0
10	16QAM	1	25	19.85	19.85	19.99		
10	16QAM	1	49	19.77	19.79	19.88		
10	16QAM	25	0	19.88	19.92	19.86	21	0
10	16QAM	25	12	19.94	19.95	19.82		
10	16QAM	25	25	19.73	19.93	19.83		
10	16QAM	50	0	19.89	19.74	19.79		
Channel				20425	20525	20625		
Frequency (MHz)				826.5	836.5	846.5		
5	QPSK	1	0	19.93	20.00	19.90		
5	QPSK	1	12	19.83	19.98	19.86	21	0
5	QPSK	1	24	19.87	20.01	19.76		
5	QPSK	12	0	19.81	19.88	19.81		
5	QPSK	12	7	19.83	19.89	19.80	21	0
5	QPSK	12	13	19.90	19.99	19.81		
5	QPSK	25	0	19.77	20.01	19.85		
5	16QAM	1	0	19.95	20.03	19.99	21	0
5	16QAM	1	12	20.02	19.97	19.96		
5	16QAM	1	24	19.76	19.74	19.86		
5	16QAM	12	0	19.95	20.03	19.89	21	0
5	16QAM	12	7	19.86	19.75	19.87		
5	16QAM	12	13	19.93	20.05	19.81		
5	16QAM	25	0	19.79	19.94	19.86		
Channel				20415	20525	20635		
Frequency (MHz)				825.5	836.5	847.5		
3	QPSK	1	0	19.97	19.98	19.91		
3	QPSK	1	8	19.72	19.89	19.74	21	0
3	QPSK	1	14	19.85	19.97	19.83		
3	QPSK	8	0	19.86	19.92	19.75		
3	QPSK	8	4	19.87	20.00	19.87	21	0
3	QPSK	8	7	19.76	19.85	19.72		
3	QPSK	15	0	19.90	19.98	19.82		
3	16QAM	1	0	19.85	19.96	19.93	21	0
3	16QAM	1	8	19.97	20.00	19.95		
3	16QAM	1	14	19.92	19.84	19.93		
3	16QAM	8	0	19.95	20.04	19.87	21	0
3	16QAM	8	4	19.87	19.84	19.90		
3	16QAM	8	7	19.85	19.75	19.83		
3	16QAM	15	0	19.89	19.96	19.83		



Channel				20407	20525	20643	Tune-up limit (dBm)	MPR (dB)
Frequency (MHz)				824.7	836.5	848.3		
1.4	QPSK	1	0	19.98	20.11	20.01	21	0
1.4	QPSK	1	3	19.95	20.05	19.94		
1.4	QPSK	1	5	20.01	20.03	19.85		
1.4	QPSK	3	0	19.73	19.90	19.82		
1.4	QPSK	3	1	19.86	20.05	19.86		
1.4	QPSK	3	3	19.84	20.10	19.79		
1.4	QPSK	6	0	19.78	19.95	19.76	21	0
1.4	16QAM	1	0	19.94	19.98	19.97	21	0
1.4	16QAM	1	3	19.77	19.97	19.81		
1.4	16QAM	1	5	19.85	19.90	19.91		
1.4	16QAM	3	0	19.93	19.85	19.91		
1.4	16QAM	3	1	19.92	19.86	19.82		
1.4	16QAM	3	3	19.99	19.87	19.95		
1.4	16QAM	6	0	19.89	19.63	19.92	21	0



<LTE Band 7>

BW [MHz]	Modulation	RB Size	RB Offset	Power Low Ch. / Freq.	Power Middle Ch. / Freq.	Power High Ch. / Freq.	Tune-up limit (dBm)	MPR (dB)
Channel				20850	21100	21350		
Frequency (MHz)				2510	2535	2560		
20	QPSK	1	0	17.09	17.10	16.99	18	0
20	QPSK	1	49	16.90	17.02	16.82		
20	QPSK	1	99	16.98	16.80	16.65		
20	QPSK	50	0	17.39	17.45	17.12	18	0
20	QPSK	50	24	17.37	17.42	17.07		
20	QPSK	50	50	17.30	17.32	17.04		
20	QPSK	100	0	17.23	17.29	17.00		
20	16QAM	1	0	17.38	17.49	17.32	18	0
20	16QAM	1	49	17.49	17.49	17.36		
20	16QAM	1	99	17.23	17.05	16.98		
20	16QAM	50	0	17.38	17.46	17.07	18	0
20	16QAM	50	24	17.36	17.48	17.05		
20	16QAM	50	50	17.21	17.26	17.03		
20	16QAM	100	0	17.27	17.38	16.93		
Channel				20825	21100	21375	Tune-up limit (dBm)	MPR (dB)
Frequency (MHz)				2507.5	2535	2562.5		
15	QPSK	1	0	17.20	17.56	16.99	18	0
15	QPSK	1	37	17.43	17.43	17.15		
15	QPSK	1	74	17.08	17.10	16.84		
15	QPSK	36	0	17.43	17.50	17.10	18	0
15	QPSK	36	20	17.39	17.42	17.07		
15	QPSK	36	39	17.21	17.30	17.01		
15	QPSK	75	0	17.27	17.44	17.04		
15	16QAM	1	0	17.38	17.47	17.29	18	0
15	16QAM	1	37	17.35	17.43	17.29		
15	16QAM	1	74	17.37	17.39	17.10		
15	16QAM	36	0	17.43	17.42	17.08	18	0
15	16QAM	36	20	17.38	17.37	17.04		
15	16QAM	36	39	17.22	17.29	17.02		
15	16QAM	75	0	17.38	17.39	16.97		
Channel				20800	21100	21400	Tune-up limit (dBm)	MPR (dB)
Frequency (MHz)				2505	2535	2565		
10	QPSK	1	0	17.21	17.53	17.02	18	0
10	QPSK	1	25	17.33	17.45	17.12		
10	QPSK	1	49	17.28	17.23	16.98		
10	QPSK	25	0	17.28	17.35	17.00	18	0
10	QPSK	25	12	17.37	17.54	17.09		
10	QPSK	25	25	17.25	17.43	17.09		
10	QPSK	50	0	17.30	17.32	17.10		
10	16QAM	1	0	17.43	17.52	17.41	18	0
10	16QAM	1	25	17.52	17.51	17.45		
10	16QAM	1	49	17.51	17.55	17.30		
10	16QAM	25	0	17.25	17.37	17.03	18	0
10	16QAM	25	12	17.33	17.55	17.16		
10	16QAM	25	25	17.18	17.48	17.14		
10	16QAM	50	0	17.29	17.31	17.12		



Channel				20775	21100	21425	Tune-up limit (dBm)	MPR (dB)
Frequency (MHz)				2502.5	2535	2567.5		
5	QPSK	1	0	17.28	17.55	17.20	18	0
5	QPSK	1	12	17.16	17.48	17.13		
5	QPSK	1	24	17.25	17.42	17.15		
5	QPSK	12	0	17.25	17.49	17.11	18	0
5	QPSK	12	7	17.27	17.47	17.11		
5	QPSK	12	13	17.35	17.52	17.09		
5	QPSK	25	0	17.25	17.46	17.09		
5	16QAM	1	0	17.53	17.59	17.39	18	0
5	16QAM	1	12	17.45	17.50	17.52		
5	16QAM	1	24	17.52	17.48	17.47		
5	16QAM	12	0	17.27	17.41	17.13	18	0
5	16QAM	12	7	17.30	17.36	17.19		
5	16QAM	12	13	17.28	17.53	17.13		
5	16QAM	25	0	17.19	17.53	17.09		



<LTE Band 12>

BW [MHz]	Modulation	RB Size	RB Offset	Power Low Ch. / Freq.	Power Middle Ch. / Freq.	Power High Ch. / Freq.	Tune-up limit (dBm)	MPR (dB)
Channel				23060	23095	23130		
Frequency (MHz)				704	707.5	711		
10	QPSK	1	0	19.06	19.02	19.02	20.5	0
10	QPSK	1	25	19.04	18.99	19.01		
10	QPSK	1	49	19.02	18.96	19.01		
10	QPSK	25	0	19.11	19.17	19.16	20.5	0
10	QPSK	25	12	19.00	19.08	19.04		
10	QPSK	25	25	18.78	19.04	19.05		
10	QPSK	50	0	19.10	19.16	19.09		
10	16QAM	1	0	19.05	19.17	19.16	20.5	0
10	16QAM	1	25	19.12	18.98	19.12		
10	16QAM	1	49	18.89	18.91	18.90		
10	16QAM	25	0	18.89	19.14	19.04	20.5	0
10	16QAM	25	12	19.05	19.09	19.11		
10	16QAM	25	25	18.82	19.03	19.04		
10	16QAM	50	0	18.88	19.07	19.03		
Channel				23035	23095	23155	Tune-up limit (dBm)	MPR (dB)
Frequency (MHz)				701.5	707.5	713.5		
5	QPSK	1	0	19.11	19.22	19.10	20.5	0
5	QPSK	1	12	19.26	19.12	19.01		
5	QPSK	1	24	19.21	19.05	19.05		
5	QPSK	12	0	19.08	19.23	18.95	20.5	0
5	QPSK	12	7	18.91	19.09	19.01		
5	QPSK	12	13	19.14	19.07	19.10		
5	QPSK	25	0	19.21	19.03	19.05		
5	16QAM	1	0	19.12	19.22	19.13	20.5	0
5	16QAM	1	12	19.12	19.17	19.11		
5	16QAM	1	24	19.01	19.04	19.02		
5	16QAM	12	0	19.09	19.08	19.04	20.5	0
5	16QAM	12	7	19.17	19.13	19.10		
5	16QAM	12	13	19.09	19.08	19.07		
5	16QAM	25	0	19.10	19.13	19.06		
Channel				23025	23095	23165	Tune-up limit (dBm)	MPR (dB)
Frequency (MHz)				700.5	707.5	714.5		
3	QPSK	1	0	19.14	19.21	18.99	20.5	0
3	QPSK	1	8	19.02	19.08	19.02		
3	QPSK	1	14	19.08	19.01	19.04		
3	QPSK	8	0	19.09	19.07	19.13	20.5	0
3	QPSK	8	4	19.22	19.13	19.05		
3	QPSK	8	7	19.15	18.99	19.08		
3	QPSK	15	0	19.18	19.14	19.03		
3	16QAM	1	0	19.10	19.17	19.07	20.5	0
3	16QAM	1	8	19.02	18.96	19.00		
3	16QAM	1	14	18.84	18.91	18.91		
3	16QAM	8	0	18.79	18.80	18.90	20.5	0
3	16QAM	8	4	18.71	18.73	19.02		
3	16QAM	8	7	19.08	19.07	19.06		
3	16QAM	15	0	18.96	18.78	19.06		



Channel				23017	23095	23173	Tune-up limit (dBm)	MPR (dB)
Frequency (MHz)				699.7	707.5	715.3		
1.4	QPSK	1	0	19.17	19.24	19.16	20.5	0
1.4	QPSK	1	3	19.16	19.16	19.15		
1.4	QPSK	1	5	19.17	19.13	19.17		
1.4	QPSK	3	0	19.10	18.96	18.94		
1.4	QPSK	3	1	19.11	19.11	19.04		
1.4	QPSK	3	3	19.12	19.10	19.09		
1.4	QPSK	6	0	19.14	18.92	18.92	20.5	0
1.4	16QAM	1	0	18.96	19.01	18.95	20.5	0
1.4	16QAM	1	3	19.04	18.99	19.01		
1.4	16QAM	1	5	19.02	18.98	18.97		
1.4	16QAM	3	0	19.05	18.99	18.99		
1.4	16QAM	3	1	18.98	18.85	19.01		
1.4	16QAM	3	3	19.06	19.03	18.97		
1.4	16QAM	6	0	18.86	18.86	19.01	20.5	0



<LTE Band 13>

BW [MHz]	Modulation	RB Size	RB Offset	Power Low Ch. / Freq.	Power Middle Ch. / Freq.	Power High Ch. / Freq.	Tune-up limit (dBm)	MPR (dB)
Channel				23230				
Frequency (MHz)				782				
10	QPSK	1	0	20.06			21	0
10	QPSK	1	25	19.82				
10	QPSK	1	49	19.75				
10	QPSK	25	0	19.66			21	0
10	QPSK	25	12	19.64				
10	QPSK	25	25	19.57				
10	QPSK	50	0	19.80				
10	16QAM	1	0	19.37			21	0
10	16QAM	1	25	20.08				
10	16QAM	1	49	20.03				
10	16QAM	25	0	19.93			21	0
10	16QAM	25	12	19.83				
10	16QAM	25	25	19.74				
10	16QAM	50	0	19.78				
Channel				23205	23230	23255	Tune-up limit (dBm)	MPR (dB)
Frequency (MHz)				779.5	782	784.5		
5	QPSK	1	0	19.70	19.75	19.65	21	0
5	QPSK	1	12	19.68	19.66	19.74		
5	QPSK	1	24	19.57	19.69	19.72		
5	QPSK	12	0	19.68	19.74	19.68	21	0
5	QPSK	12	7	19.62	19.60	19.67		
5	QPSK	12	13	19.66	19.74	19.57		
5	QPSK	25	0	19.73	19.72	19.66		
5	16QAM	1	0	19.17	19.71	19.67	21	0
5	16QAM	1	12	19.62	19.55	19.62		
5	16QAM	1	24	19.57	19.51	19.46		
5	16QAM	12	0	19.57	19.72	19.73	21	0
5	16QAM	12	7	19.68	19.68	19.72		
5	16QAM	12	13	19.58	19.73	19.68		
5	16QAM	25	0	19.54	19.73	19.69		



<LTE Band 25>

BW [MHz]	Modulation	RB Size	RB Offset	Power Low Ch. / Freq.	Power Middle Ch. / Freq.	Power High Ch. / Freq.	Tune-up limit (dBm)	MPR (dB)
Channel				26140	26340	26590		
Frequency (MHz)				1860	1880	1905		
20	QPSK	1	0	17.07	17.14	17.00	17.5	0
20	QPSK	1	49	16.01	15.87	15.87		
20	QPSK	1	99	15.89	16.05	16.08		
20	QPSK	50	0	16.27	16.36	16.27	17.5	0
20	QPSK	50	24	15.97	16.10	16.02		
20	QPSK	50	50	15.81	15.95	15.93		
20	QPSK	100	0	16.01	16.30	16.07		
20	16QAM	1	0	16.78	16.81	16.79	17.5	0
20	16QAM	1	49	16.23	16.10	16.00		
20	16QAM	1	99	16.14	16.15	16.26		
20	16QAM	50	0	16.28	16.29	16.34	17.5	0
20	16QAM	50	24	16.06	15.95	16.08		
20	16QAM	50	50	15.85	15.87	15.97		
20	16QAM	100	0	16.07	16.07	16.28		
Channel				26115	26340	26615		
Frequency (MHz)				1857.5	1880	1907.5		
15	QPSK	1	0	16.43	16.44	16.38	17.5	0
15	QPSK	1	37	16.29	16.21	16.06		
15	QPSK	1	74	15.81	15.85	15.90		
15	QPSK	36	0	16.12	16.12	16.04	17.5	0
15	QPSK	36	20	15.82	15.92	16.03		
15	QPSK	36	39	15.92	15.71	15.92		
15	QPSK	75	0	15.96	15.94	16.06		
15	16QAM	1	0	16.71	16.74	16.62	17.5	0
15	16QAM	1	37	16.19	16.02	16.19		
15	16QAM	1	74	16.11	16.36	16.19		
15	16QAM	36	0	16.13	16.26	16.22	17.5	0
15	16QAM	36	20	15.93	15.91	16.04		
15	16QAM	36	39	15.90	15.78	15.87		
15	16QAM	75	0	16.05	16.01	16.09		
Channel				26090	26340	26640		
Frequency (MHz)				1855	1880	1910		
10	QPSK	1	0	16.15	16.45	16.29	17.5	0
10	QPSK	1	25	16.03	15.93	16.09		
10	QPSK	1	49	16.02	15.77	15.99		
10	QPSK	25	0	16.00	16.05	16.10	17.5	0
10	QPSK	25	12	16.02	15.89	16.11		
10	QPSK	25	25	15.86	15.71	16.00		
10	QPSK	50	0	15.94	15.93	16.14		
10	16QAM	1	0	16.58	16.60	16.43	17.5	0
10	16QAM	1	25	16.27	16.18	16.37		
10	16QAM	1	49	16.21	15.99	16.25		
10	16QAM	25	0	16.03	16.06	16.13	17.5	0
10	16QAM	25	12	16.05	15.95	16.12		
10	16QAM	25	25	15.91	15.76	16.12		
10	16QAM	50	0	15.98	15.85	16.08		



Channel				26065	26340	26665	Tune-up limit (dBm)	MPR (dB)
Frequency (MHz)				1852.5	1880	1912.5		
5	QPSK	1	0	16.18	16.18	16.19	17.5	0
5	QPSK	1	12	16.06	15.97	16.19		
5	QPSK	1	24	15.90	15.77	16.01		
5	QPSK	12	0	15.98	15.93	16.09	17.5	0
5	QPSK	12	7	15.92	15.88	16.04		
5	QPSK	12	13	15.89	15.83	16.06		
5	QPSK	25	0	15.88	15.78	16.10	17.5	0
5	16QAM	1	0	16.40	16.44	16.39		
5	16QAM	1	12	16.19	16.50	16.11		
5	16QAM	1	24	16.15	16.13	16.26	17.5	0
5	16QAM	12	0	16.07	16.07	16.15		
5	16QAM	12	7	16.02	15.97	16.08		
5	16QAM	12	13	15.90	15.85	16.05	17.5	0
5	16QAM	25	0	15.85	15.88	16.12		
Channel				26055	26340	26675		
Frequency (MHz)				1851.5	1880	1913.5		
3	QPSK	1	0	16.01	16.20	15.97	17.5	0
3	QPSK	1	8	15.92	16.04	16.17		
3	QPSK	1	14	16.09	15.80	15.71		
3	QPSK	8	0	16.00	15.95	15.93	17.5	0
3	QPSK	8	4	15.99	15.92	15.97		
3	QPSK	8	7	15.82	15.85	15.96		
3	QPSK	15	0	15.75	15.85	15.94	17.5	0
3	16QAM	1	0	16.32	16.46	16.16		
3	16QAM	1	8	16.34	16.25	16.35		
3	16QAM	1	14	16.07	16.20	16.11	17.5	0
3	16QAM	8	0	16.07	15.97	15.99		
3	16QAM	8	4	15.92	15.96	16.05		
3	16QAM	8	7	15.94	15.89	15.94	17.5	0
3	16QAM	8	7	15.94	15.89	15.94		
3	16QAM	15	0	15.90	15.84	15.99		
Channel				26047	26340	26683	Tune-up limit (dBm)	MPR (dB)
Frequency (MHz)				1850.7	1880	1914.3		
1.4	QPSK	1	0	15.89	16.14	16.01	17.5	0
1.4	QPSK	1	3	16.12	15.99	15.98		
1.4	QPSK	1	5	15.73	15.82	15.92		
1.4	QPSK	3	0	15.97	15.85	15.92	17.5	0
1.4	QPSK	3	1	16.01	15.90	15.85		
1.4	QPSK	3	3	15.81	15.82	15.98		
1.4	QPSK	6	0	15.75	15.75	15.92	17.5	0
1.4	16QAM	1	0	16.20	16.30	16.29	17.5	0
1.4	16QAM	1	3	16.36	16.28	16.27		
1.4	16QAM	1	5	16.03	16.08	16.12		
1.4	16QAM	3	0	15.86	15.89	15.97	17.5	0
1.4	16QAM	3	1	16.09	16.05	15.93		
1.4	16QAM	3	3	15.90	15.97	15.99		
1.4	16QAM	6	0	15.85	15.84	15.99	17.5	0



<LTE Band 26>

BW [MHz]	Modulation	RB Size	RB Offset	Power Low Ch. / Freq.	Power Middle Ch. / Freq.	Power High Ch. / Freq.	Tune-up limit (dBm)	MPR (dB)
Channel				26765	26865	26965		
Frequency (MHz)				821.5	831.5	841.5		
15	QPSK	1	0	20.00	20.02	20.01	21	0
15	QPSK	1	37	19.64	19.69	19.53		
15	QPSK	1	74	19.55	19.62	19.64		
15	QPSK	36	0	19.62	19.80	19.64	21	0
15	QPSK	36	20	19.62	19.69	19.61		
15	QPSK	36	39	19.53	19.66	19.59		
15	QPSK	75	0	19.59	19.70	19.70		
15	16QAM	1	0	19.77	19.80	19.73	21	0
15	16QAM	1	37	19.75	19.76	19.68		
15	16QAM	1	74	19.63	19.73	19.84		
15	16QAM	36	0	19.66	19.79	19.70	21	0
15	16QAM	36	20	19.68	19.78	19.64		
15	16QAM	36	39	19.60	19.69	19.74		
15	16QAM	75	0	19.67	19.73	19.80		
Channel				26740	26865	26990	Tune-up limit (dBm)	MPR (dB)
Frequency (MHz)				819	831.5	844		
10	QPSK	1	0	19.55	19.64	19.61	21	0
10	QPSK	1	25	19.52	19.62	19.69		
10	QPSK	1	49	19.39	19.47	19.49		
10	QPSK	25	0	19.55	19.61	19.56	21	0
10	QPSK	25	12	19.56	19.57	19.55		
10	QPSK	25	25	19.46	19.60	19.60		
10	QPSK	50	0	19.48	19.60	19.59		
10	16QAM	1	0	19.77	19.75	19.76	21	0
10	16QAM	1	25	19.65	19.76	19.71		
10	16QAM	1	49	19.73	19.68	19.67		
10	16QAM	25	0	19.58	19.54	19.57	21	0
10	16QAM	25	12	19.48	19.59	19.61		
10	16QAM	25	25	19.42	19.62	19.50		
10	16QAM	50	0	19.48	19.64	19.58		
Channel				26715	26865	27015	Tune-up limit (dBm)	MPR (dB)
Frequency (MHz)				816.5	831.5	846.5		
5	QPSK	1	0	19.55	19.81	19.58	21	0
5	QPSK	1	12	19.55	19.66	19.64		
5	QPSK	1	24	19.52	19.59	19.62		
5	QPSK	12	0	19.38	19.70	19.51	21	0
5	QPSK	12	7	19.49	19.78	19.59		
5	QPSK	12	13	19.42	19.60	19.62		
5	QPSK	25	0	19.50	19.61	19.61		
5	16QAM	1	0	19.78	19.74	19.72	21	0
5	16QAM	1	12	19.73	19.71	19.71		
5	16QAM	1	24	19.71	19.58	19.76		
5	16QAM	12	0	19.38	19.72	19.59	21	0
5	16QAM	12	7	19.51	19.78	19.66		
5	16QAM	12	13	19.46	19.61	19.72		
5	16QAM	25	0	19.49	19.59	19.57		



Channel				26705	26865	27025	Tune-up limit (dBm)	MPR (dB)
Frequency (MHz)				815.5	831.5	847.5		
3	QPSK	1	0	19.51	19.74	19.67	21	0
3	QPSK	1	8	19.75	19.79	19.73		
3	QPSK	1	14	19.44	19.70	19.57		
3	QPSK	8	0	19.45	19.77	19.67	21	0
3	QPSK	8	4	19.54	19.71	19.70		
3	QPSK	8	7	19.46	19.65	19.63		
3	QPSK	15	0	19.50	19.67	19.66		
3	16QAM	1	0	19.76	19.86	19.77	21	0
3	16QAM	1	8	19.75	19.82	19.76		
3	16QAM	1	14	19.69	19.62	19.66		
3	16QAM	8	0	19.55	19.63	19.66	21	0
3	16QAM	8	4	19.60	19.61	19.74		
3	16QAM	8	7	19.53	19.73	19.64		
3	16QAM	15	0	19.51	19.78	19.69		
Channel				26697	26865	27033	Tune-up limit (dBm)	MPR (dB)
Frequency (MHz)				814.7	831.5	848.3		
1.4	QPSK	1	0	19.55	19.83	19.75	21	0
1.4	QPSK	1	3	19.70	19.79	19.74		
1.4	QPSK	1	5	19.51	19.64	19.67		
1.4	QPSK	3	0	19.41	19.61	19.66		
1.4	QPSK	3	1	19.56	19.69	19.62		
1.4	QPSK	3	3	19.60	19.75	19.68		
1.4	QPSK	6	0	19.45	19.68	19.54	21	0
1.4	16QAM	1	0	19.75	19.78	19.69	21	0
1.4	16QAM	1	3	19.71	19.70	19.78		
1.4	16QAM	1	5	19.64	19.74	19.61		
1.4	16QAM	3	0	19.53	19.73	19.60		
1.4	16QAM	3	1	19.57	19.77	19.63		
1.4	16QAM	3	3	19.66	19.56	19.71		
1.4	16QAM	6	0	19.62	19.53	19.60	21	0



Default Power Mode

<LTE Band 41>

RB Size	RB Offset	Power Low Ch. / Freq.	Power Low Middle Ch. / Freq.	Power Middle Ch. / Freq.	Power High Middle Ch. / Freq.	Power High Ch. / Freq.	Tune-up limit (dBm)	MPR (dB)
Channel		39750	40185	40620	41055	41490		
Frequency (MHz)		2506	2549.5	2593	2636.5	2680		
1	0	21.20	21.25	21.15	21.22	21.26	23	0
1	49	21.04	21.08	21.03	21.07	21.15		
1	99	21.03	21.07	21.02	21.06	21.11		
50	0	20.21	20.16	20.21	20.10	20.27	22	1
50	24	20.12	20.15	20.13	20.06	20.22		
50	50	20.08	20.00	20.01	20.00	20.10		
100	0	20.08	20.08	20.12	20.00	20.16		
1	0	20.02	20.11	20.12	20.03	20.30	22	1
1	49	20.23	20.17	20.21	20.05	20.18		
1	99	20.16	20.04	20.16	20.00	20.10		
50	0	19.10	19.19	19.14	19.09	19.29	21	2
50	24	19.15	19.18	19.20	19.05	19.23		
50	50	19.07	19.04	19.01	19.00	19.14		
100	0	19.11	19.16	19.20	19.00	19.23		
Channel		39725	40173	40620	41068	41515		
Frequency (MHz)		2503.5	2548.3	2593	2637.8	2682.5		
1	0	21.08	21.09	21.13	21.02	21.14	23	0
1	37	21.00	21.02	21.06	21.02	21.11		
1	74	21.04	21.01	21.02	21.01	21.03		
36	0	20.11	20.12	20.21	20.08	20.24	22	1
36	20	20.02	20.11	20.08	20.01	20.12		
36	39	20.06	20.03	20.02	20.00	20.07		
75	0	20.07	20.08	20.12	20.02	20.09		
1	0	20.08	20.09	20.07	20.06	20.22	22	1
1	37	20.13	20.11	20.11	20.07	20.17		
1	74	20.07	20.04	20.11	20.09	20.02		
36	0	19.06	19.13	19.05	19.09	19.24	21	2
36	20	19.10	19.12	19.18	19.07	19.20		
36	39	19.08	19.07	19.05	19.09	19.05		
75	0	19.03	19.10	19.14	19.04	19.19		
Channel		39700	40160	40620	41080	41540		
Frequency (MHz)		2501	2547	2593	2639	2685		
1	0	21.13	21.09	21.07	21.09	21.15	23	0
1	25	21.06	21.08	21.03	21.05	21.10		
1	49	21.08	21.03	21.03	21.08	21.06		
25	0	20.20	20.08	20.21	20.05	20.24	22	1
25	12	20.08	20.12	20.12	21.07	20.20		
25	25	20.00	20.03	20.04	21.00	20.09		
50	0	20.02	20.06	20.06	20.00	20.14		
1	0	20.02	20.02	20.12	20.09	20.20	22	1
1	25	20.16	20.16	20.14	20.05	20.09		
1	49	20.07	20.04	20.12	20.08	20.01		
25	0	19.01	19.18	19.07	19.05	19.28	21	2
25	12	19.10	19.13	19.12	19.04	19.15		
25	25	19.02	19.04	19.03	19.06	19.05		
50	0	19.06	19.11	19.15	19.03	19.13		



Channel	39675	40148	40620	41093	41565	Tune-up limit (dBm)	MPR (dB)	
Frequency (MHz)	2498.5	2545.8	2593	2640.30	2687.5			
1	0	21.14	21.08	21.03	21.09	21.15	23	0
1	12	21.07	21.00	21.03	21.07	21.10		
1	24	21.06	21.03	21.07	21.02	21.04		
12	0	20.12	20.11	20.16	20.07	20.21	22	1
12	7	20.04	20.15	20.03	20.05	20.21		
12	13	20.08	20.08	20.02	20.00	20.00		
25	0	20.04	20.09	20.08	20.05	20.13		
1	0	20.01	20.04	20.02	20.08	20.24	22	1
1	12	20.18	20.11	20.21	20.05	20.15		
1	24	20.16	20.03	20.08	20.03	20.02		
12	0	19.01	19.11	19.13	19.09	19.20	21	2
12	7	19.07	19.18	19.10	19.04	19.19		
12	13	19.02	19.04	19.01	19.06	19.14		
25	0	19.03	19.16	19.15	19.08	19.20		



Reduced Power Mode

<LTE Band 41>

BW [MHz]	Modulation	RB Size	RB Offset	Power Low Ch. / Freq.	Power Low Middle Ch. / Freq.	Power Middle Ch. / Freq.	Power High Middle Ch. / Freq.	Power High Ch. / Freq.	Tune-up limit (dBm)	MPR (dB)
Channel				39750	40185	40620	41055	41490		
Frequency (MHz)				2506	2549.5	2593	2636.5	2680		
20	QPSK	1	0	17.05	17.08	17.11	17.04	17.06	18	0
20	QPSK	1	49	16.93	16.73	16.80	16.79	17.04		
20	QPSK	1	99	16.66	16.38	16.53	16.58	16.77		
20	QPSK	50	0	17.21	17.05	17.23	17.13	17.21	18	0
20	QPSK	50	24	17.20	16.96	16.94	17.03	17.20		
20	QPSK	50	50	16.93	16.90	16.89	16.85	17.00		
20	QPSK	100	0	17.00	16.87	17.17	16.98	16.95	18	0
20	16QAM	1	0	16.87	16.92	16.85	16.87	17.16		
20	16QAM	1	49	17.19	17.01	16.98	17.03	17.32		
20	16QAM	1	99	16.67	16.55	16.56	16.64	16.81	18	0
20	16QAM	50	0	17.20	17.09	16.99	17.04	17.32		
20	16QAM	50	24	17.15	16.93	17.01	17.12	17.27		
20	16QAM	50	50	16.98	16.82	16.92	16.81	17.00	18	0
20	16QAM	100	0	17.06	16.91	16.92	16.93	17.17		
Channel				39725	40173	40620	41068	41515		
Frequency (MHz)				2503.5	2548.3	2593	2637.8	2682.5	18	0
15	QPSK	1	0	17.06	16.88	17.20	16.82	16.83		
15	QPSK	1	37	16.95	17.04	17.14	17.00	16.95		
15	QPSK	1	74	16.77	16.69	16.75	16.50	16.54	18	0
15	QPSK	36	0	17.15	16.94	16.86	16.88	16.96		
15	QPSK	36	20	17.13	16.90	16.99	16.93	16.97		
15	QPSK	36	39	17.01	16.84	16.75	16.49	16.83	18	0
15	QPSK	75	0	17.16	16.97	16.84	16.78	16.93		
15	16QAM	1	0	17.05	17.12	17.07	16.82	17.07		
15	16QAM	1	37	17.07	17.00	17.01	16.87	17.06	18	0
15	16QAM	1	74	17.06	16.74	16.82	16.52	16.77		
15	16QAM	36	0	17.03	16.97	16.85	16.81	16.90		
15	16QAM	36	20	16.98	17.00	16.95	16.86	16.90	18	0
15	16QAM	36	39	17.08	16.85	16.81	16.64	16.71		
15	16QAM	75	0	16.99	16.89	16.84	16.88	16.77		
Channel				39700	40160	40620	41080	41540	Tune-up limit (dBm)	MPR (dB)
Frequency (MHz)				2501	2547	2593	2639	2685	18	0
10	QPSK	1	0	16.54	16.55	16.75	16.54	16.53		
10	QPSK	1	25	16.54	16.50	16.62	16.55	16.48		
10	QPSK	1	49	16.48	16.51	16.35	16.55	16.49	18	0
10	QPSK	25	0	16.62	16.53	16.42	16.57	16.56		
10	QPSK	25	12	16.58	16.56	16.47	16.45	16.53		
10	QPSK	25	25	16.50	16.44	16.34	16.61	16.64	18	0
10	QPSK	50	0	16.56	16.47	16.42	16.55	16.54		
10	16QAM	1	0	16.69	16.66	16.74	16.75	16.70		
10	16QAM	1	25	16.52	16.64	16.63	16.66	16.46	18	0
10	16QAM	1	49	16.59	16.47	16.36	16.51	16.65		
10	16QAM	25	0	16.70	16.72	16.49	16.76	16.68		
10	16QAM	25	12	16.40	16.64	16.57	16.78	16.72	18	0
10	16QAM	25	25	16.73	16.45	16.37	16.52	16.65		
10	16QAM	50	0	16.76	16.38	16.40	16.53	16.75		



Channel				39675	40148	40620	41093	41565	Tune-up limit (dBm)	MPR (dB)
Frequency (MHz)				2498.5	2545.8	2593	2640.30	2687.5		
5	QPSK	1	0	16.47	16.51	16.77	16.62	16.63	18	0
5	QPSK	1	12	16.37	16.45	16.35	16.48	16.57		
5	QPSK	1	24	16.40	16.32	16.26	16.46	16.60		
5	QPSK	12	0	16.29	16.54	16.44	16.50	16.64	18	0
5	QPSK	12	7	16.74	16.57	16.46	16.60	16.66		
5	QPSK	12	13	16.72	16.58	16.29	16.56	16.53		
5	QPSK	25	0	16.64	16.54	16.32	16.47	16.60	18	0
5	16QAM	1	0	16.63	16.60	16.73	16.66	16.74		
5	16QAM	1	12	16.71	16.56	16.52	16.65	16.72		
5	16QAM	1	24	16.72	16.50	16.41	16.56	16.75	18	0
5	16QAM	12	0	16.70	16.57	16.41	16.47	16.66		
5	16QAM	12	7	16.70	16.58	16.51	16.54	16.71		
5	16QAM	12	13	16.81	16.46	16.46	16.50	16.70		
5	16QAM	25	0	16.70	16.59	16.53	16.48	16.67		

**<WLAN Conducted Power>****General Note:**

1. For each antenna, transmit power in SISO operation is larger than (or equal to) the power in MIMO operation, RF exposure compliance of MIMO mode can be deduced from the compliance simultaneous transmission of antennas operating in SISO mode.
2. Per KDB 248227 D01v02r02, the simultaneous SAR provisions in KDB publication 447498 should be applied to determine simultaneous transmission SAR test exclusion for WiFi MIMO. If the sum of 1g single transmission chain SAR measurements is $< 1.6\text{W/kg}$ and SAR peak to location ratio ≤ 0.04 , no additional SAR measurements for MIMO.
3. Per KDB 248227 D01v02r02, SAR test reduction is determined according to 802.11 transmission mode configurations and certain exposure conditions with multiple test positions. In the 2.4 GHz band, separate SAR procedures are applied to DSSS and OFDM configurations to simplify DSSS test requirements. For OFDM, in both 2.4 and 5 GHz bands, an initial test configuration must be determined for each standalone and aggregated frequency band, according to the transmission mode configuration with the highest maximum output power specified for production units to perform SAR measurements. If the same highest maximum output power applies to different combinations of channel bandwidths, modulations and data rates, additional procedures are applied to determine which test configurations require SAR measurement. When applicable, an initial test position may be applied to reduce the number of SAR measurements required for next to the ear, UMPC mini-tablet or hotspot mode configurations with multiple test positions.
4. For 2.4 GHz 802.11b DSSS, either the initial test position procedure for multiple exposure test positions or the DSSS procedure for fixed exposure position is applied; these are mutually exclusive. For 2.4 GHz and 5 GHz OFDM configurations, the initial test configuration is applied to measure SAR using either the initial test position procedure for multiple exposure test position configurations or the initial test configuration procedures for fixed exposure test conditions. Based on the reported SAR of the measured configurations and maximum output power of the transmission mode configurations that are not included in the initial test configuration, the subsequent test configuration and initial test position procedures are applied to determine if SAR measurements are required for the remaining OFDM transmission configurations. In general, the number of test channels that require SAR measurement is minimized based on maximum output power measured for the test sample(s).
5. For OFDM transmission configurations in the 2.4 GHz and 5 GHz bands, When the same maximum power is specified for multiple transmission modes in a frequency band, the largest channel bandwidth, lowest order modulation, lowest data rate and lowest order 802.11a/g/n/ac mode is used for SAR measurement, on the highest measured output power channel for each frequency band.
6. DSSS and OFDM configurations are considered separately according to the required SAR procedures. SAR is measured in the initial test position using the 802.11 transmission mode configuration required by the DSSS procedure or initial test configuration and subsequent test configuration(s) according to the OFDM procedures.18 The initial test position procedure is described in the following:
 - a. When the reported SAR of the initial test position is $\leq 0.4\text{ W/kg}$, further SAR measurement is not required for the other test positions in that exposure configuration and 802.11 transmission mode combinations within the frequency band or aggregated band.
 - b. When the reported SAR of the test position is $> 0.4\text{ W/kg}$, SAR is repeated for the 802.11 transmission mode configuration tested in the initial test position to measure the subsequent next closet/smallest test separation distance and maximum coupling test position on the highest maximum output power channel, until the report SAR is $\leq 0.8\text{ W/kg}$ or all required test position are tested.
 - c. For all positions/configurations, when the reported SAR is $> 0.8\text{ W/kg}$, SAR is measured for these test positions/configurations on the subsequent next highest measured output power channel(s) until the reported SAR is $\leq 1.2\text{ W/kg}$ or all required channels are tested.
7. For 8265D2W, channel #12 and #13 SAR testing are not necessary, due to the maximum power is equal or smaller than other channels, the maximum power please refer to WLAN conducted power table.



<2.4GHz WLAN ANT 1>

	Mode	Channel	Frequency (MHz)	Data Rate	Average power (dBm)	Tune-Up Limit	Duty Cycle %
2.4GHz WLAN ANT 1	802.11b	CH 1	2412	1Mbps	14.85	15.00	98.56
		CH 6	2437		14.93	15.00	
		CH 11	2462		14.68	15.00	
		CH 12	2467		14.82	15.00	
		CH 13	2472		14.56	15.00	
	802.11g	CH 1	2412	6Mbps	14.75	15.00	94.50
		CH 6	2437		14.91	15.00	
		CH 11	2462		14.67	15.00	
		CH 12	2467		14.72	15.00	
		CH 13	2472		-0.97	-0.50	
	802.11n-HT20	CH 1	2412	MCS0	14.67	15.00	95.00
		CH 6	2437		14.85	15.00	
		CH 11	2462		14.50	15.00	
		CH 12	2467		14.72	15.00	
		CH 13	2472		14.78	15.00	
	802.11n-HT40	CH 3	2422	MCS0	14.67	15.00	96.91
CH 6		2437	14.76		15.00		
CH 9		2452	14.60		15.00		
CH 10		2457	14.01		14.50		
CH 11		2462	1.10		1.50		

<2.4GHz WLAN ANT 2>

	Mode	Channel	Frequency (MHz)	Data Rate	Average power (dBm)	Tune-Up Limit	Duty Cycle %
2.4GHz WLAN ANT 2	802.11b	CH 1	2412	1Mbps	14.83	15.00	98.56
		CH 6	2437		14.65	15.00	
		CH 11	2462		14.92	15.00	
		CH 12	2467		14.76	15.00	
		CH 13	2472		14.82	15.00	
	802.11g	CH 1	2412	6Mbps	14.80	15.00	94.50
		CH 6	2437		14.65	15.00	
		CH 11	2462		14.86	15.00	
		CH 12	2467		14.89	15.00	
		CH 13	2472		-2.17	-2.00	
	802.11n-HT20	CH 1	2412	MCS0	14.81	15.00	95.00
		CH 6	2437		14.50	15.00	
		CH 11	2462		14.84	15.00	
		CH 12	2467		14.81	15.00	
		CH 13	2472		-2.47	-2.00	
	802.11n-HT40	CH 3	2422	MCS0	14.76	15.00	95.92
CH 6		2437	14.78		15.00		
CH 9		2452	14.72		15.00		
CH 10		2457	14.86		15.00		
CH 11		2462	1.08		1.50		



<2.4GHz WLAN ANT 1+2>

	Mode	Channel	Frequency (MHz)	Data Rate	Average power (dBm)	Tune-Up Limit	Duty Cycle %
2.4GHz WLAN ANT 1+2	802.11n-HT20	CH 1	2412	MCS0	14.50	15.00	94.12
		CH 6	2437		14.54	15.00	
		CH 11	2462		14.62	15.00	
		CH 12	2467		14.34	14.50	
		CH 13	2472		-4.40	-4.00	
	802.11n-HT40	CH 3	2422	MCS0	14.66	15.00	92.48
		CH 6	2437		14.51	15.00	
		CH 9	2452		14.46	15.00	
		CH 10	2457		12.6	13.00	
		CH 11	2462		3.35	3.50	



<5GHz WLAN ANT1>

	Mode	Channel	Frequency (MHz)	Data Rate	Average power (dBm)	Tune-Up Limit	Duty Cycle %
5.2GHz WLAN ANT 1	802.11a	CH 36	5180	6Mbps	13.35	13.50	94.50
		CH 40	5200		13.32	13.50	
		CH 44	5220		13.33	13.50	
		CH 48	5240		13.43	13.50	
	802.11n-HT20	CH 36	5180	MCS0	13.31	13.50	95.52
		CH 40	5200		13.29	13.50	
		CH 44	5220		13.39	13.50	
		CH 48	5240		13.44	13.50	
	802.11n-HT40	CH 38	5190	MCS0	13.30	13.50	96.91
		CH 46	5230		13.29	13.50	
	802.11ac-VHT20	CH 36	5180	MCS0	13.30	13.50	95.05
		CH 40	5200		13.35	13.50	
		CH 44	5220		13.37	13.50	
		CH 48	5240		13.42	13.50	
	802.11ac-VHT40	CH 38	5190	MCS0	13.31	13.50	95.96
		CH 46	5230		13.28	13.50	
802.11ac-VHT80	CH 42	5210	MCS0	13.33	13.50	94.26	

	Mode	Channel	Frequency (MHz)	Data Rate	Average power (dBm)	Tune-Up Limit	Duty Cycle %
5.3GHz WLAN ANT 1	802.11a	CH 52	5260	6Mbps	13.37	13.50	94.50
		CH 56	5280		13.36	13.50	
		CH 60	5300		13.35	13.50	
		CH 64	5320		13.26	13.50	
	802.11n-HT20	CH 52	5260	MCS0	13.30	13.50	95.52
		CH 56	5280		13.28	13.50	
		CH 60	5300		13.36	13.50	
		CH 64	5320		13.29	13.50	
	802.11n-HT40	CH 54	5270	MCS0	13.23	13.50	96.91
		CH 62	5310		13.06	13.50	
	802.11ac-VHT20	CH 52	5260	MCS0	13.28	13.50	95.05
		CH 56	5280		13.25	13.50	
		CH 60	5300		13.35	13.50	
		CH 64	5320		13.30	13.50	
	802.11ac-VHT40	CH 54	5270	MCS0	13.26	13.50	95.96
		CH 62	5310		13.08	13.50	
802.11ac-VHT80	CH 58	5290	MCS0	13.29	13.50	94.26	



	Mode	Channel	Frequency (MHz)	Data Rate	Average power (dBm)	Tune-Up Limit	Duty Cycle %
5.5GHz WLAN ANT 1	802.11a	CH 100	5500	6Mbps	13.06	13.50	94.50
		CH 116	5580		13.10	13.50	
		CH 124	5620		13.20	13.50	
		CH 132	5660		13.18	13.50	
		CH 140	5700		13.03	13.50	
		CH 144	5720		13.32	13.50	
	802.11n-HT20	CH 100	5500	MCS0	13.31	13.50	95.52
		CH 116	5580		13.22	13.50	
		CH 124	5620		13.19	13.50	
		CH 132	5660		13.20	13.50	
		CH 140	5700		13.12	13.50	
		CH 144	5720		13.25	13.50	
	802.11n-HT40	CH 102	5510	MCS0	13.27	13.50	96.91
		CH 110	5550		13.16	13.50	
		CH 126	5630		13.19	13.50	
		CH 134	5670		13.17	13.50	
		CH 142	5710		13.22	13.50	
	802.11ac-VHT20	CH 100	5500	MCS0	13.30	13.50	95.05
		CH 116	5580		13.26	13.50	
		CH 124	5620		13.29	13.50	
		CH 132	5660		13.25	13.50	
		CH 140	5700		13.12	13.50	
		CH 144	5720		13.19	13.50	
	802.11ac-VHT40	CH 102	5510	MCS0	13.26	13.50	95.96
		CH 110	5550		13.21	13.50	
		CH 126	5630		13.22	13.50	
		CH 134	5670		13.24	13.50	
CH 142		5710	13.29		13.50		
802.11ac-VHT80	CH 106	5530	MCS0	13.22	13.50	94.26	
	CH 122	5610		13.23	13.50		
	CH 138	5690		13.30	13.50		



	Mode	Channel	Frequency (MHz)	Data Rate	Average power (dBm)	Tune-Up Limit	Duty Cycle %
5.8GHz WLAN ANT 1	802.11a	CH 149	5745	MCS0	13.22	13.50	94.50
		CH 157	5785		13.25	13.50	
		CH 165	5825		13.29	13.50	
	802.11n-HT20	CH 149	5745	MCS0	13.38	13.50	95.55
		CH 157	5785		13.35	13.50	
		CH 165	5825		13.32	13.50	
	802.11n-HT40	CH 151	5755	MCS0	13.27	13.50	96.91
		CH 159	5795		13.33	13.50	
	802.11ac-VHT20	CH 149	5745	MCS0	13.37	13.50	95.05
		CH 157	5785		13.34	13.50	
		CH 165	5825		13.31	13.50	
	802.11ac-VHT40	CH 151	5755	MCS0	13.28	13.50	95.96
CH 159		5795	13.35		13.50		
802.11ac-VHT80	CH 155	5775	MCS0	13.33	13.50	94.26	

<5GHz WLAN ANT2>

	Mode	Channel	Frequency (MHz)	Data Rate	Average power (dBm)	Tune-Up Limit	Duty Cycle %
5.2GHz WLAN ANT 2	802.11a	CH 36	5180	6Mbps	13.39	13.50	94.50
		CH 40	5200		13.22	13.50	
		CH 44	5220		13.07	13.50	
		CH 48	5240		13.12	13.50	
	802.11n-HT20	CH 36	5180	MCS0	13.37	13.50	95.03
		CH 40	5200		13.19	13.50	
		CH 44	5220		13.13	13.50	
		CH 48	5240		13.03	13.50	
	802.11n-HT40	CH 38	5190	MCS0	13.33	13.50	96.91
		CH 46	5230		13.34	13.50	
	802.11ac-VHT20	CH 36	5180	MCS0	13.32	13.50	95.05
		CH 40	5200		13.11	13.50	
		CH 44	5220		13.05	13.50	
		CH 48	5240		13.01	13.50	
	802.11ac-VHT40	CH 38	5190	MCS0	13.40	13.50	95.92
CH 46		5230	13.36		13.50		
802.11ac-VHT80	CH 42	5210	MCS0	13.21	13.50	93.44	



	Mode	Channel	Frequency (MHz)	Data Rate	Average power (dBm)	Tune-Up Limit	Duty Cycle %
5.3GHz WLAN ANT 2	802.11a	CH 52	5260	6Mbps	13.05	13.50	94.50
		CH 56	5280		13.15	13.50	
		CH 60	5300		13.08	13.50	
		CH 64	5320		13.01	13.50	
	802.11n-HT20	CH 52	5260	MCS0	13.15	13.50	95.03
		CH 56	5280		13.19	13.50	
		CH 60	5300		13.04	13.50	
		CH 64	5320		13.25	13.50	
	802.11n-HT40	CH 54	5270	MCS0	13.27	13.50	96.91
		CH 62	5310		13.25	13.50	
	802.11ac-VHT20	CH 52	5260	MCS0	13.08	13.50	95.05
		CH 56	5280		13.10	13.50	
		CH 60	5300		13.02	13.50	
		CH 64	5320		13.19	13.50	
802.11ac-VHT40	CH 54	5270	MCS0	13.29	13.50	95.92	
	CH 62	5310		13.27	13.50		
802.11ac-VHT80	CH 58	5290	MCS0	13.33	13.50	93.44	



	Mode	Channel	Frequency (MHz)	Data Rate	Average power (dBm)	Tune-Up Limit	Duty Cycle %
5.5GHz WLAN ANT 2	802.11a	CH 100	5500	6Mbps	13.10	13.50	94.50
		CH 116	5580		13.06	13.50	
		CH 124	5620		13.15	13.50	
		CH 132	5660		13.12	13.50	
		CH 140	5700		13.28	13.50	
		CH 144	5720		13.21	13.50	
	802.11n-HT20	CH 100	5500	MCS0	13.41	13.50	95.03
		CH 116	5580		13.32	13.50	
		CH 124	5620		13.29	13.50	
		CH 132	5660		13.30	13.50	
		CH 140	5700		13.38	13.50	
		CH 144	5720		13.35	13.50	
	802.11n-HT40	CH 102	5510	MCS0	13.30	13.50	96.91
		CH 110	5550		13.33	13.50	
		CH 126	5630		13.24	13.50	
		CH 134	5670		13.20	13.50	
	802.11ac-VHT20	CH 142	5710	MCS0	13.22	13.50	95.50
		CH 100	5500		13.31	13.50	
		CH 116	5580		13.26	13.50	
		CH 124	5620		13.22	13.50	
		CH 132	5660		13.24	13.50	
		CH 140	5700		13.35	13.50	
	802.11ac-VHT40	CH 144	5720	MCS0	13.36	13.50	95.92
		CH 102	5510		13.32	13.50	
		CH 110	5550		13.34	13.50	
		CH 126	5630		13.21	13.50	
		CH 134	5670		13.22	13.50	
802.11ac-VHT80	CH 142	5710	MCS0	13.19	13.50	93.44	
	CH 106	5530		13.32	13.50		
	CH 122	5610		13.29	13.50		
		CH 138	5690		13.28	13.50	



	Mode	Channel	Frequency (MHz)	Data Rate	Average power (dBm)	Tune-Up Limit	Duty Cycle %
5.8GHz WLAN ANT 2	802.11a	CH 149	5745	MCS0	13.35	13.50	94.50
		CH 157	5785		13.38	13.50	
		CH 165	5825		13.33	13.50	
	802.11n-HT20	CH 149	5745	MCS0	13.35	13.50	95.03
		CH 157	5785		13.36	13.50	
		CH 165	5825		13.20	13.50	
	802.11n-HT40	CH 151	5755	MCS0	13.27	13.50	96.91
		CH 159	5795		13.24	13.50	
	802.11ac-VHT20	CH 149	5745	MCS0	13.36	13.50	95.05
		CH 157	5785		13.32	13.50	
		CH 165	5825		13.22	13.50	
	802.11ac-VHT40	CH 151	5755	MCS0	13.28	13.50	95.92
CH 159		5795	13.26		13.50		
802.11ac-VHT80	CH 155	5775	MCS0	13.30	13.50	93.44	

<5GHz WLAN ANT1+2>

	Mode	Channel	Frequency (MHz)	Data Rate	Average power (dBm)	Tune-Up Limit	Duty Cycle %
5.2GHz WLAN ANT 1+2	802.11n-HT20	CH 36	5180	MCS0	13.43	13.50	95.10
		CH 40	5200		13.39	13.50	
		CH 44	5220		13.38	13.50	
		CH 48	5240		13.44	13.50	
	802.11n-HT40	CH 38	5190	MCS0	13.40	13.50	92.42
		CH 46	5230		13.36	13.50	
	802.11ac-VHT20	CH 36	5180	MCS0	13.36	13.50	95.15
		CH 40	5200		13.36	13.50	
		CH 44	5220		13.30	13.50	
		CH 48	5240		13.40	13.50	
	802.11ac-VHT40	CH 38	5190	MCS0	13.36	13.50	92.48
		CH 46	5230		13.33	13.50	
802.11ac-VHT80	CH 42	5210	MCS0	13.21	13.50	86.30	



5.3GHz WLAN ANT 1+2	Mode	Channel	Frequency (MHz)	Data Rate	Average power (dBm)	Tune-Up Limit	Duty Cycle %
	802.11n-HT20	CH 52	5260	MCS0	13.41	13.50	95.10
		CH 56	5280		13.39		
		CH 60	5300		13.31		
		CH 64	5320		13.24		
	802.11n-HT40	CH 54	5270	MCS0	13.34	13.50	92.42
		CH 62	5310		13.35		
	802.11ac-VHT20	CH 52	5260	MCS0	13.01	13.50	95.15
CH 56		5280	13.29				
CH 60		5300	13.26				
CH 64		5320	13.20				
802.11ac-VHT40	CH 54	5270	MCS0	13.29	13.50	92.48	
	CH 62	5310		13.28			
802.11ac-VHT80	CH 58	5290	MCS0	13.33	13.50	86.30	

5.5GHz WLAN ANT 1+2	Mode	Channel	Frequency (MHz)	Data Rate	Average power (dBm)	Tune-Up Limit	Duty Cycle %
	802.11n-HT20	CH 100	5500	MCS0	13.31	13.50	95.10
		CH 116	5580		13.23		
		CH 124	5620		13.30		
		CH 132	5660		13.29		
		CH 140	5700		13.17		
		CH 144	5720		13.22		
	802.11n-HT40	CH 102	5510	MCS0	13.27	13.50	92.42
		CH 110	5550		13.32		
		CH 126	5630		13.36		
		CH 134	5670		13.16		
	802.11ac-VHT20	CH 142	5710	MCS0	13.15	13.50	95.15
		CH 100	5500		13.25		
		CH 116	5580		13.23		
		CH 124	5620		13.19		
		CH 132	5660		13.13		
		CH 140	5700		13.13		
	802.11ac-VHT40	CH 144	5720	MCS0	13.19	13.50	92.48
		CH 102	5510		13.21		
		CH 110	5550		13.27		
		CH 126	5630		13.25		
		CH 134	5670		13.07		
	802.11ac-VHT80	CH 142	5710	MCS0	13.11	13.50	86.30
		CH 106	5530		13.26		
CH 122		5610	13.32				
CH 138		5690	13.28				

5.8GHz WLAN ANT 1+2	Mode	Channel	Frequency (MHz)	Data Rate	Average power (dBm)	Tune-Up Limit	Duty Cycle %
	802.11n-HT20	CH 149	5745	MCS0	13.28	13.50	95.10
		CH 157	5785		13.27		
		CH 165	5825		13.30		
	802.11n-HT40	CH 151	5755	MCS0	13.24	13.50	92.42
		CH 159	5795		13.30		
	802.11ac-VHT20	CH 149	5745	MCS0	13.24	13.50	95.15
		CH 157	5785		13.26		
		CH 165	5825		13.28		
	802.11ac-VHT40	CH 151	5755	MCS0	13.25	13.50	92.48
CH 159		5795	13.22				
802.11ac-VHT80	CH 155	5775	MCS0	13.31	13.50	86.30	

<2.4GHz Bluetooth>

General Note:

- For 2.4GHz Bluetooth SAR testing was selected 1Mbps (DH5), due to its highest average power.
- The Bluetooth duty cycle is 76.6 % as following figure, and the theoretical maximum duty cycle of DH5 is 83.3%, therefore the SAR test result will be scaled up to the theoretical maximum duty cycle for SAR evaluation.

Mode	Channel	Frequency (MHz)	Average power (dBm)		
			1Mbps	2Mbps	3Mbps
BR/EDR	CH 00	2402	9.09	5.87	4.87
	CH 39	2441	9.84	6.23	5.33
	CH 78	2480	8.35	4.59	4.07
Tune-up Limit			11.8	6.5	5.5

Mode	Channel	Frequency (MHz)	Average power (dBm)
			GFSK
LE	CH 00	2402	4.97
	CH 19	2440	4.67
	CH 39	2480	2.95
Tune-up Limit			5

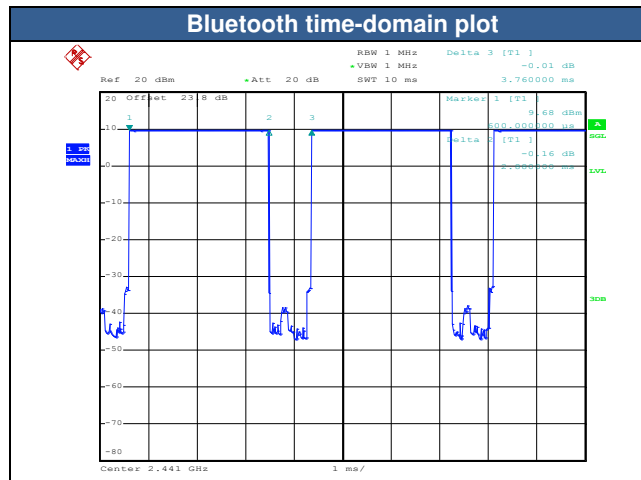

13. SAR test exclusion table

General Note:

1. The below table, when the distance is < 50 mm exclusion threshold is "Ratio", when the distance is > 50 mm exclusion threshold is "mW"
2. Maximum power is the source-based time-average power and represents the maximum RF output power among production units
3. Per KDB 447498 D01v06, for larger devices, the test separation distance of adjacent edge configuration is determined by the closest separation between the antenna and the user.
4. Per KDB 447498 D01v06, standalone SAR test exclusion threshold is applied; If the test separation distance is < 5mm, 5mm is used to determine SAR exclusion threshold.
5. Per KDB 447498 D01v06, the 1-g and 10-g SAR test exclusion thresholds for 100 MHz to 6 GHz at *test separation distances* ≤ 50 mm are determined by:
 - $[(max. power of channel, including tune-up tolerance, mW)/(min. test separation distance, mm)] \cdot [\sqrt{f(GHz)}] \leq 3.0$ for 1-g SAR and ≤ 7.5 for 10-g extremity SAR
 - f(GHz) is the RF channel transmit frequency in GHz
 - Power and distance are rounded to the nearest mW and mm before calculation
 - The result is rounded to one decimal place for comparison
6. Per KDB 447498 D01v06, at 100 MHz to 6 GHz and for *test separation distances* > 50 mm, the SAR test exclusion threshold is determined according to the following
 - a) [Threshold at 50 mm in step 1) + (test separation distance - 50 mm)· (f(MHz)/150)] mW, at 100 MHz to 1500 MHz
 - b) [Threshold at 50 mm in step 1) + (test separation distance - 50 mm)· 10] mW at > 1500 MHz and ≤ 6 GHz
7. The detail antenna location please refers to Appendix E.

	Wireless Interface	BT ANT 2	2.4GHz WLAN ANT 1	2.4GHz WLAN ANT 2	5GHz WLAN ANT 1	5GHz WLAN ANT 2
Exposure Position	Calculated Frequency	2480MHz	2462MHz	2462MHz	5825MHz	5825MHz
	Maximum power (dBm)	11.8	15	15	13.5	13.5
	Maximum rated power(mW)	15.0	32.0	32.0	22.0	22.0
	Separation distance(mm)	5.0	5.0	5.0	5.0	5.0
Bottom Face	exclusion threshold	4.7	10.0	10.0	10.6	10.6
	Testing required?	Yes	Yes	Yes	Yes	Yes
	Separation distance(mm)	5.0	66.2	5.0	66.2	5.0
Edge 1	exclusion threshold	4.7	257.0	10.0	224.0	10.6
	Testing required?	Yes	No	Yes	No	Yes
	Separation distance(mm)	164.2	277.9	164.2	277.9	164.2
Edge 2	exclusion threshold	1240.0	2375.0	1238.0	2341.0	1204.0
	Testing required?	No	No	No	No	No
	Separation distance(mm)	192.0	117.0	192.0	117.0	192.0
Edge 3	exclusion threshold	1516.0	766.0	1516.0	732.0	1482.0
	Testing required?	No	No	No	No	No
	Separation distance(mm)	111.5	5.0	111.5	5.0	111.5
Edge 4	exclusion threshold	710.0	10.0	711.0	10.6	677.0
	Testing required?	No	Yes	No	Yes	No



14. SAR Test Results

General Note:

1. Per KDB 447498 D01v06, the reported SAR is the measured SAR value adjusted for maximum tune-up tolerance.
 - a. Tune-up scaling Factor = tune-up limit power (mW) / EUT RF power (mW), where tune-up limit is the maximum rated power among all production units.
 - b. For SAR testing of WLAN signal with non-100% duty cycle, the measured SAR is scaled-up by the duty cycle scaling factor which is equal to "1/(duty cycle)"
 - c. For WWAN/Bluetooth: Reported SAR(W/kg)= Measured SAR(W/kg)*Tune-up Scaling Factor
 - d. For WLAN: Reported SAR(W/kg)= Measured SAR(W/kg)* Duty Cycle scaling factor * Tune-up scaling factor
 - e. For TDD LTE SAR measurement, the duty cycle 1:1.59 (62.9 %) was used perform testing and considering the theoretical duty cycle of 63.3% for extended cyclic prefix in the uplink, and the theoretical duty cycle of 62.9% for normal cyclic prefix in uplink, a scaling factor of extended cyclic prefix 63.3%/62.9% = 1.006 is applied to scale-up the measured SAR result. The Reported TDD LTE SAR = measured SAR (W/kg) * Tune-up Scaling Factor* scaling factor for extended cyclic prefix.
2. Per KDB 447498 D01v06, for each exposure position, testing of other required channels within the operating mode of a frequency band is not required when the *reported* 1-g or 10-g SAR for the mid-band or highest output power channel is:
 - ≤ 0.8 W/kg or 2.0 W/kg, for 1-g or 10-g respectively, when the transmission band is ≤ 100 MHz
 - ≤ 0.6 W/kg or 1.5 W/kg, for 1-g or 10-g respectively, when the transmission band is between 100 MHz and 200 MHz
 - ≤ 0.4 W/kg or 1.0 W/kg, for 1-g or 10-g respectively, when the transmission band is ≥ 200 MHz
3. Per KDB 865664 D01v01r04, for each frequency band, repeated SAR measurement is required only when the measured SAR is ≥ 0.8 W/kg.
4. According to TCB workshop October 2016, when the highest reported SAR of an antenna is > 1.2 W/kg, holder perturbation verification is required for each antenna, using the highest SAR configuration among all applicable frequency bands.
5. For the body SAR measurement was used a low-loss foam block performed testing, the relative permittivity and loss tangent of the foam material is 1.0 and 10^{-5} , respectively, therefore holder perturbation verification is not required even highest reported SAR is >1.2 W/kg.

WLAN Note:

1. Per KDB 248227 D01v02r02, for 2.4GHz 802.11g/n SAR testing is not required when the highest reported SAR for DSSS is adjusted by the ratio of OFDM to DSSS specified maximum output power and the adjusted SAR is ≤ 1.2 W/kg.
2. Per KDB 248227 D01v02r02, U-NII-1 SAR testing is not required when the U-NII-2A band highest reported SAR for a test configuration is ≤ 1.2 W/kg, SAR is not required for U-NII-1 band.
3. When the reported SAR of the test position is > 0.4 W/kg, SAR is repeated for the 802.11 transmission mode configuration tested in the initial test position to measure the subsequent next closet/smallest test separation distance and maximum coupling test position on the highest maximum output power channel, until the report SAR is ≤ 0.8 W/kg or all required test position are tested.
4. For all positions / configurations, when the reported SAR is > 0.8 W/kg, SAR is measured for these test positions / configurations on the subsequent next highest measured output power channel(s) until the reported SAR is ≤ 1.2 W/kg or all required channels are tested.
5. For WLAN SAR testing was performed on single antenna RF power in SISO mode is larger or equal to the single antenna RF power in MIMO mode, and for RF exposure assessment of MIMO mode simultaneous transmission exclusion analysis was performed with SAR test results of each antenna in SISO mode.
6. Per KDB 248227 D01v02r02, the simultaneous SAR provisions in KDB publication 447498 should be applied to determine simultaneous transmission SAR test exclusion for WiFi MIMO. If the sum of 1g single transmission chain SAR measurements is < 1.6 W/kg and SAR peak to location ratio ≤ 0.04 , no additional SAR measurements for MIMO.
7. During SAR testing the WLAN transmission was verified using a spectrum analyzer.



14.1 Spot check of WWAN SAR

<WCDMA SAR>

Plot No.	Band	Mode	Test Position	Gap (mm)	Power Reduction	Ch.	Freq. (MHz)	Average Power (dBm)	Tune-Up Limit (dBm)	Tune-up Scaling Factor	Power Drift (dB)	Measured 1g SAR (W/kg)	Reported 1g SAR (W/kg)
01	WCDMA II	RMC 12.2Kbps	Bottom Face	11mm	OFF	9262	1852.4	22.73	24.00	1.340	0.04	0.638	0.855
02	WCDMA IV	RMC 12.2Kbps	Bottom Face	11mm	OFF	1513	1752.6	22.66	24.00	1.361	-0.11	0.821	1.118
03	WCDMA V	RMC 12.2Kbps	Bottom Face	0mm	ON	4182	836.4	20.19	21.50	1.352	-0.19	0.879	1.188

<FDD LTE SAR>

Plot No.	Band	BW (MHz)	Modulation	RB Size	RB offset	Test Position	Gap (mm)	Power Reduction	Ch.	Freq. (MHz)	Average Power (dBm)	Tune-Up Limit (dBm)	Tune-up Scaling Factor	Power Drift (dB)	Measured 1g SAR (W/kg)	Reported 1g SAR (W/kg)
04	LTE Band 4	20M	QPSK	1	0	Edge 2	0mm	ON	20175	1732.5	16.96	17.50	1.132	-0.14	0.914	1.035
05	LTE Band 7	20M	QPSK	1	0	Bottom Face	0mm	ON	21350	2560	16.99	18.00	1.262	-0.14	0.946	1.194
06	LTE Band 12	10M	QPSK	1	0	Bottom Face	0mm	ON	23095	707.5	19.02	20.50	1.406	0.14	0.671	0.943
07	LTE Band 13	10M	QPSK	1	0	Bottom Face	0mm	ON	23230	782	20.06	21.00	1.242	-0.06	0.961	1.193
08	LTE Band 25	20M	QPSK	1	0	Edge 2	0mm	ON	26140	1860	17.07	17.50	1.104	-0.13	0.803	0.887
09	LTE Band 26	15M	QPSK	1	0	Bottom Face	0mm	ON	26865	831.5	20.02	21.00	1.253	-0.16	0.870	1.090

<TDD LTE SAR>

Plot No.	Band	BW (MHz)	Modulation	RB Size	RB offset	Test Position	Gap (mm)	Power Reduction	Ch.	Freq. (MHz)	Average Power (dBm)	Tune-Up Limit (dBm)	Tune-up Scaling Factor	Duty Cycle %	Duty Cycle Scaling Factor	Power Drift (dB)	Measured 1g SAR (W/kg)	Reported 1g SAR (W/kg)
10	LTE Band 41	20M	QPSK	1	0	Bottom Face	0mm	ON	41055	2636.5	17.04	18.00	1.247	62.9	1.006	-0.04	0.812	1.019

Note: WWAN highest SAR summary and WWAN Sim-Tx analysis evaluation is select higher value of either original SAR result or spot checks SAR result.



14.2 Body SAR

<WLAN SAR>

Plot No.	Band	Mode	Test Position	Gap (mm)	Antenna	Ch.	Freq. (MHz)	Average Power (dBm)	Tune-Up Limit (dBm)	Tune-up Scaling Factor	Duty Cycle %	Duty Cycle Scaling Factor	Power Drift (dB)	Measured 1g SAR (W/kg)	Reported 1g SAR (W/kg)
11	WLAN2.4GHz	802.11b 1Mbps	Bottom Face	0mm	Ant 1	6	2437	14.93	15.00	1.016	98.56	1.015	-0.02	0.953	0.982
	WLAN2.4GHz	802.11b 1Mbps	Bottom Face	0mm	Ant 1	1	2412	14.85	15.00	1.034	98.56	1.015	-0.04	0.845	0.887
	WLAN2.4GHz	802.11b 1Mbps	Edge 4	0mm	Ant 1	6	2437	14.93	15.00	1.016	98.56	1.015	-0.12	0.388	0.400
	WLAN2.4GHz	802.11b 1Mbps	Bottom Face	0mm	Ant 2	11	2462	14.92	15.00	1.018	98.56	1.015	-0.18	0.554	0.572
	WLAN2.4GHz	802.11b 1Mbps	Edge 1	0mm	Ant 2	11	2462	14.92	15.00	1.018	98.56	1.015	0.13	0.524	0.541
12	WLAN5GHz	802.11ac-VHT80 MCS0	Bottom Face	0mm	Ant 1	58	5290	13.29	13.50	1.050	94.26	1.061	-0.1	0.875	0.974
	WLAN5GHz	802.11n-HT40 MCS0	Bottom Face	0mm	Ant 1	54	5270	13.23	13.50	1.064	96.91	1.032	-0.15	0.768	0.843
	WLAN5GHz	802.11ac-VHT80 MCS0	Edge 4	0mm	Ant 1	58	5290	13.29	13.50	1.050	94.26	1.061	-0.18	0.457	0.509
	WLAN5GHz	802.11ac-VHT80 MCS0	Bottom Face	0mm	Ant 2	58	5290	13.33	13.50	1.040	93.44	1.070	0.02	0.789	0.878
	WLAN5GHz	802.11n-HT40 MCS0	Bottom Face	0mm	Ant 2	54	5270	13.27	13.50	1.054	96.91	1.032	-0.01	0.812	0.884
	WLAN5GHz	802.11ac-VHT80 MCS0	Edge 1	0mm	Ant 2	58	5290	13.33	13.50	1.040	93.44	1.070	-0.13	0.749	0.833
	WLAN5GHz	802.11n-HT40 MCS0	Edge 1	0mm	Ant 2	54	5270	13.27	13.50	1.054	96.91	1.032	-0.12	0.840	0.914
	WLAN5GHz	802.11ac-VHT80 MCS0	Bottom Face	0mm	Ant 1	138	5690	13.30	13.50	1.047	94.26	1.061	0.13	0.701	0.779
	WLAN5GHz	802.11ac-VHT80 MCS0	Edge 4	0mm	Ant 1	138	5690	13.30	13.50	1.047	94.26	1.061	-0.11	0.575	0.639
	WLAN5GHz	802.11ac-VHT80 MCS0	Bottom Face	0mm	Ant 2	106	5530	13.32	13.50	1.041	93.44	1.070	0.19	0.972	1.083
	WLAN5GHz	802.11ac-VHT80 MCS0	Bottom Face	0mm	Ant 2	122	5610	13.29	13.50	1.048	93.44	1.070	-0.06	1.020	1.144
13	WLAN5GHz	802.11ac-VHT80 MCS0	Bottom Face	0mm	Ant 2	138	5690	13.28	13.50	1.052	93.44	1.070	-0.02	1.050	1.182
	WLAN5GHz	802.11ac-VHT80 MCS0	Edge 1	0mm	Ant 2	106	5530	13.32	13.50	1.041	93.44	1.070	-0.12	0.825	0.919
	WLAN5GHz	802.11ac-VHT80 MCS0	Edge 1	0mm	Ant 2	122	5610	13.29	13.50	1.048	93.44	1.070	-0.06	0.794	0.891
	WLAN5GHz	802.11ac-VHT80 MCS0	Edge 1	0mm	Ant 2	138	5690	13.28	13.50	1.052	93.44	1.070	-0.06	0.802	0.903
	WLAN5GHz	802.11ac-VHT80 MCS0	Bottom Face	0mm	Ant 1	155	5775	13.33	13.50	1.041	94.26	1.061	0.18	0.886	0.978
14	WLAN5GHz	802.11n-HT40 MCS0	Bottom Face	0mm	Ant 1	159	5795	13.33	13.50	1.041	96.91	1.032	0.07	1.010	1.085
	WLAN5GHz	802.11ac-VHT80 MCS0	Edge 4	0mm	Ant 1	155	5775	13.33	13.50	1.041	94.26	1.061	-0.09	0.752	0.830
	WLAN5GHz	802.11n-HT40 MCS0	Edge 4	0mm	Ant 1	159	5795	13.33	13.50	1.041	96.91	1.032	-0.18	0.802	0.861
	WLAN5GHz	802.11ac-VHT80 MCS0	Bottom Face	0mm	Ant 2	155	5775	13.30	13.50	1.046	93.44	1.070	-0.16	0.764	0.855
	WLAN5GHz	802.11n-HT40 MCS0	Bottom Face	0mm	Ant 2	151	5755	13.27	13.50	1.055	96.91	1.032	-0.11	0.837	0.912
	WLAN5GHz	802.11ac-VHT80 MCS0	Edge 1	0mm	Ant 2	155	5775	13.30	13.50	1.046	93.44	1.070	-0.09	0.639	0.715

<Bluetooth SAR>

Plot No.	Band	Mode	Test Position	Gap (mm)	Antenna	Ch.	Freq. (MHz)	Average Power (dBm)	Tune-Up Limit (dBm)	Tune-up Scaling Factor	Duty Cycle %	Duty Cycle Scaling Factor	Power Drift (dB)	Measured 1g SAR (W/kg)	Reported 1g SAR (W/kg)
15	Bluetooth	1Mbps	Bottom Face	0mm	Ant 2	39	2441	9.84	11.80	1.572	76.6	1.087	-0.04	0.053	0.091
	Bluetooth	1Mbps	Bottom Face	0mm	Ant 2	0	2402	9.09	10.00	1.234	76.6	1.087	-0.05	0.050	0.067
	Bluetooth	1Mbps	Bottom Face	0mm	Ant 2	78	2480	8.35	10.00	1.464	76.6	1.087	-0.09	0.042	0.066
	Bluetooth	1Mbps	Edge 1	0mm	Ant 2	39	2441	9.84	11.80	1.572	76.6	1.087	-0.08	0.047	0.080



14.3 Repeated SAR Measurement

No.	Band	Mode	Test Position	Gap (mm)	Antenna	Ch.	Freq. (MHz)	Average Power (dBm)	Tune-Up Limit (dBm)	Tune-up Scaling Factor	Duty Cycle %	Duty Cycle Scaling Factor	Power Drift (dB)	Measured 1g SAR (W/kg)	Ratio	Reported 1g SAR (W/kg)
1 st	WLAN2.4GHz	802.11b 1Mbps	Bottom Face	0mm	Ant 1	6	2437	14.93	15.00	1.016	98.56	1.015	-0.02	0.953		0.982
2 nd	WLAN2.4GHz	802.11b 1Mbps	Bottom Face	0mm	Ant 1	6	2437	14.93	15.00	1.016	98.56	1.015	-0.12	0.888	1.07	0.915
1 st	WLAN5GHz	802.11ac-VHT80 MCS0	Bottom Face	0mm	Ant 1	58	5290	13.29	13.50	1.050	94.26	1.061	-0.1	0.882		0.974
2 nd	WLAN5GHz	802.11ac-VHT80 MCS0	Bottom Face	0mm	Ant 1	58	5290	13.29	13.50	1.050	94.26	1.061	-0.15	0.799	1.09	0.890
1 st	WLAN5GHz	802.11ac-VHT80 MCS0	Bottom Face	0mm	Ant 2	138	5690	13.28	13.50	1.052	93.44	1.070	-0.02	1.050		1.182
2 nd	WLAN5GHz	802.11ac-VHT80 MCS0	Bottom Face	0mm	Ant 2	138	5690	13.28	13.50	1.052	93.44	1.070	-0.06	1.030	1.02	1.159
1 st	WLAN5GHz	802.11n-HT40 MCS0	Bottom Face	0mm	Ant 1	159	5795	13.33	13.50	1.041	96.91	1.032	0.07	1.010		1.085
2 nd	WLAN5GHz	802.11n-HT40 MCS0	Bottom Face	0mm	Ant 1	159	5795	13.33	13.50	1.041	94.26	1.061	0.15	0.910	1.08	1.005

General Note:

- Per KDB 865664 D01v01r04, for each frequency band, repeated SAR measurement is required only when the measured SAR is $\geq 0.8W/kg$.
- Per KDB 865664 D01v01r04, if the ratio among the repeated measurement is ≤ 1.2 and the measured SAR $< 1.45W/kg$, only one repeated measurement is required.
- The ratio is the difference in percentage between original and repeated *measured SAR*.
- All measurement SAR result is scaled-up to account for tune-up tolerance and is compliant.

15. Simultaneous Transmission Analysis

NO.	Simultaneous Transmission Configurations	Body
1.	WWAN + WLAN ANT1	Yes
2.	WWAN + WLAN ANT2	Yes
3.	WWAN + Bluetooth ANT2	Yes
4.	WLAN ANT1 + WLAN ANT2	Yes
5.	WLAN ANT1 + Bluetooth ANT2	Yes
6.	WWAN + WLAN ANT1 + WLAN ANT2	Yes
7.	WWAN + WLAN ANT1 + Bluetooth ANT2	Yes

General Note:

1. WWAN Sim-Tx analysis evaluation is select higher value of either original SAR result or spot checks SAR result, the original SAR result can be refer to (Sporton SAR Report No. FA5N2711-01, FCC ID: P5U-TP00082AUC) or appendix D.
2. The worst case WLAN reported SAR for each configuration was used for SAR summation. Therefore, the following summations represent the absolute worst cases for simultaneous transmission with WLAN.
3. WLAN and Bluetooth share the same antenna2, and cannot transmit simultaneously.
4. EUT will choose either WLAN 2.4GHz or WLAN 5GHz according to the network signal condition; therefore, 2.4GHz WLAN and 5GHz WLAN will not operate simultaneously at any moment.
5. For simultaneous transmission analysis for exposure position of 11mm for bottom face, 9mm for edge1, 15mm for edge2, WLAN SAR tested at 0mm separation is worse and the test data is used for conservative SAR summation.
6. The Scaled SAR summation is calculated based on the same configuration and test position.
7. For “no.1~ and 5” SPLSR evaluation and analysis was cover by “No.6 ~ No.7”.
8. Per KDB 447498 D01v06, simultaneous transmission SAR is compliant if,
 - i) Scalar SAR summation < 1.6W/kg.
 - ii) $SPLSR = (SAR1 + SAR2)^{1.5} / (\min. \text{ separation distance, mm})$, and the peak separation distance is determined from the square root of $[(x1-x2)^2 + (y1-y2)^2 + (z1-z2)^2]$, where (x1, y1, z1) and (x2, y2, z2) are the coordinates of the extrapolated peak SAR locations in the zoom scan.
 - iii) If $SPLSR \leq 0.04$, simultaneously transmission SAR measurement is not necessary.
 - iv) Simultaneously transmission SAR measurement, and the reported multi-band SAR < 1.6W/kg.
 - v) The SPLSR calculated results please refer to section 15.2.



15.1 Body Exposure Conditions

WWAN Band	Exposure Position	1	2	3	1+2 Summed 1g SAR (W/kg)	1+3 Summed 1g SAR (W/kg)	2+3 Summed 1g SAR (W/kg)	1+2+3 Summed 1g SAR (W/kg)	1+2+3 SPLSR	1+2+3 Case No	
		WWAN	2.4GHz WLAN Ant 1	2.4GHz WLAN Ant 2							
		1g SAR (W/kg)	1g SAR (W/kg)	1g SAR (W/kg)							
WCDMA	WCDMA II	Bottom Face at 0mm	0.750	0.982	0.572	1.732	1.322	1.554	2.304	0.01	Case 1
		Edge 1 at 0mm	0.499		0.541	0.499	1.040	0.541	1.040		
		Edge 2 at 0mm	0.957			0.957	0.957	0.000	0.957		
		Bottom Face at 11mm	1.019	0.982	0.572	2.001	1.591	1.554	2.573	0.01	Case 2
		Edge 1 at 9mm	0.603		0.541	0.603	1.144	0.541	1.144		
		Edge 2 at 15mm	0.651			0.651	0.651	0.000	0.651		
	WCDMA IV	Bottom Face at 0mm	1.147	0.982	0.572	2.129	1.719	1.554	2.701	0.01	Case 3
		Edge 1 at 0mm	0.454		0.541	0.454	0.995	0.541	0.995		
		Edge 2 at 0mm	1.113			1.113	1.113	0.000	1.113		
		Bottom Face at 11mm	1.297	0.982	0.572	2.279	1.869	1.554	2.851	0.02	Case 4
		Edge 1 at 9mm	0.618		0.541	0.618	1.159	0.541	1.159		
		Edge 2 at 15mm	0.534			0.534	0.534	0.000	0.534		
	WCDMA V	Bottom Face at 0mm	1.188	0.982	0.572	2.170	1.760	1.554	2.742	0.01	Case 5
		Edge 1 at 0mm	0.200		0.541	0.200	0.741	0.541	0.741		
		Edge 2 at 0mm	0.671			0.671	0.671	0.000	0.671		
		Bottom Face at 11mm	0.503	0.982	0.572	1.485	1.075	1.554	2.057	0.01	Case 6
		Edge 1 at 9mm	0.181		0.541	0.181	0.722	0.541	0.722		
		Edge 2 at 15mm	0.251			0.251	0.251	0.000	0.251		
		Edge 3 at 0mm	0.074			0.074	0.074	0.000	0.074		
		Edge 4 at 0mm	0.022	0.400		0.422	0.022	0.400	0.422		
	LTE	LTE Band 4	Bottom Face at 0mm	1.227	0.982	0.572	2.209	1.799	1.554	2.781	0.01
Edge 1 at 0mm			0.477		0.541	0.477	1.018	0.541	1.018		
Edge 2 at 0mm			1.289			1.289	1.289	0.000	1.289		
Bottom Face at 11mm			1.210	0.982	0.572	2.192	1.782	1.554	2.764	0.01	Case 8
Edge 1 at 9mm			0.528		0.541	0.528	1.069	0.541	1.069		
Edge 2 at 15mm		0.506			0.506	0.506	0.000	0.506			
LTE Band 7		Bottom Face at 0mm	1.263	0.982	0.572	2.245	1.835	1.554	2.817	0.02	Case 9
		Edge 1 at 0mm	0.304		0.541	0.304	0.845	0.541	0.845		
		Edge 2 at 0mm	0.696			0.696	0.696	0.000	0.696		
		Bottom Face at 11mm	0.384	0.982	0.572	1.366	0.956	1.554	1.938	0.01	Case 10
	Edge 1 at 9mm	0.408		0.541	0.408	0.949	0.541	0.949			
Edge 2 at 15mm	0.187			0.187	0.187	0.000	0.187				



WWAN Band	Exposure Position	1	2	3	1+2 Summed 1g SAR (W/kg)	1+3 Summed 1g SAR (W/kg)	2+3 Summed 1g SAR (W/kg)	1+2+3 Summed 1g SAR (W/kg)	1+2+3 SPLSR	1+2+3 Case No	
		WWAN	2.4GHz WLAN Ant 1	2.4GHz WLAN Ant 2							
		1g SAR (W/kg)	1g SAR (W/kg)	1g SAR (W/kg)							
LTE	LTE Band 12	Bottom Face at 0mm	1.017	0.982	0.572	1.999	1.589	1.554	2.571	0.01	Case 11
		Edge 1 at 0mm	0.112		0.541	0.112	0.653	0.541	0.653		
		Edge 2 at 0mm	0.616			0.616	0.616	0.000	0.616		
		Bottom Face at 11mm	0.494	0.982	0.572	1.476	1.066	1.554	2.048	0.01	Case 12
		Edge 1 at 9mm	0.089		0.541	0.089	0.630	0.541	0.630		
		Edge 2 at 15mm	0.219			0.219	0.219	0.000	0.219		
		Edge 3 at 0mm	0.028			0.028	0.028	0.000	0.028		
	Edge 4 at 0mm	0.021	0.400		0.421	0.021	0.400	0.421			
	LTE Band 13	Bottom Face at 0mm	1.230	0.982	0.572	2.212	1.802	1.554	2.784	0.01	Case 13
		Edge 1 at 0mm	0.197		0.541	0.197	0.738	0.541	0.738		
		Edge 2 at 0mm	0.787			0.787	0.787	0.000	0.787		
		Bottom Face at 11mm	0.673	0.982	0.572	1.655	1.245	1.554	2.227	0.01	Case 14
		Edge 1 at 9mm	0.225		0.541	0.225	0.766	0.541	0.766		
		Edge 2 at 15mm	0.237			0.237	0.237	0.000	0.237		
		Edge 3 at 0mm	0.056			0.056	0.056	0.000	0.056		
	Edge 4 at 0mm	0.031	0.400		0.431	0.031	0.400	0.431			
	LTE Band 25	Bottom Face at 0mm	0.935	0.982	0.572	1.917	1.507	1.554	2.489	0.01	Case 15
		Edge 1 at 0mm	0.504		0.541	0.504	1.045	0.541	1.045		
		Edge 2 at 0mm	1.105			1.105	1.105	0.000	1.105		
		Bottom Face at 11mm	0.971	0.982	0.572	1.953	1.543	1.554	2.525	0.01	Case 16
		Edge 1 at 9mm	0.498		0.541	0.498	1.039	0.541	1.039		
		Edge 2 at 15mm	0.651			0.651	0.651	0.000	0.651		
	LTE Band 26	Bottom Face at 0mm	1.090	0.982	0.572	2.072	1.662	1.554	2.644	0.01	Case 17
		Edge 1 at 0mm	0.152		0.541	0.152	0.693	0.541	0.693		
Edge 2 at 0mm		0.657			0.657	0.657	0.000	0.657			
Bottom Face at 11mm		0.534	0.982	0.572	1.516	1.106	1.554	2.088	0.01	Case 18	
Edge 1 at 9mm		0.171		0.541	0.171	0.712	0.541	0.712			
Edge 2 at 15mm		0.229			0.229	0.229	0.000	0.229			
LTE Band 41	Bottom Face at 0mm	1.267	0.982	0.572	2.249	1.839	1.554	2.821	0.02	Case 19	
	Edge 1 at 0mm	0.146		0.541	0.146	0.687	0.541	0.687			
	Edge 2 at 0mm	0.515			0.515	0.515	0.000	0.515			
	Bottom Face at 11mm	0.414	0.982	0.572	1.396	0.986	1.554	1.968	0.01	Case 20	
	Edge 1 at 9mm	0.150		0.541	0.150	0.691	0.541	0.691			
	Edge 2 at 15mm	0.126			0.126	0.126	0.000	0.126			



WWAN Band	Exposure Position	1	4	5	1+4 Summed 1g SAR (W/kg)	1+5 Summed 1g SAR (W/kg)	4+5 Summed 1g SAR (W/kg)	1+4+5 Summed 1g SAR (W/kg)	1+4+5 SPLSR	1+4+5 Case No		
		WWAN	5GHz WLAN Ant 1	5GHz WLAN Ant 2								
		1g SAR (W/kg)	1g SAR (W/kg)	1g SAR (W/kg)								
WCDMA	WCDMA II	Bottom Face at 0mm	0.750	1.085	1.182	1.835	1.932	2.267	3.017	0.03	Case 21	
		Edge 1 at 0mm	0.499		0.919	0.499	1.418	0.919	1.418			
		Edge 2 at 0mm	0.957			0.957	0.957	0.000	0.957			
		Bottom Face at 11mm	1.019	1.085	1.182	2.104	2.201	2.267	3.286	0.03	Case 22	
		Edge 1 at 9mm	0.603		0.919	0.603	1.522	0.919	1.522			
		Edge 2 at 15mm	0.651			0.651	0.651	0.000	0.651			
	WCDMA IV	Bottom Face at 0mm	1.147	1.085	1.182	2.232	2.329	2.267	3.414	0.03	Case 23	
		Edge 1 at 0mm	0.454		0.919	0.454	1.373	0.919	1.373			
		Edge 2 at 0mm	1.113			1.113	1.113	0.000	1.113			
		Bottom Face at 11mm	1.297	1.085	1.182	2.382	2.479	2.267	3.564	0.03	Case 24	
		Edge 1 at 9mm	0.618		0.919	0.618	1.537	0.919	1.537			
		Edge 2 at 15mm	0.534			0.534	0.534	0.000	0.534			
	WCDMA V	Bottom Face at 0mm	1.188	1.085	1.182	2.273	2.370	2.267	3.455	0.03	Case 25	
		Edge 1 at 0mm	0.200		0.919	0.200	1.119	0.919	1.119			
		Edge 2 at 0mm	0.671			0.671	0.671	0.000	0.671			
		Bottom Face at 11mm	0.503	1.085	1.182	1.588	1.685	2.267	2.770	0.03	Case 26	
		Edge 1 at 9mm	0.181		0.919	0.181	1.100	0.919	1.100			
		Edge 2 at 15mm	0.251			0.251	0.251	0.000	0.251			
	LTE	LTE Band 4	Edge 3 at 0mm	0.074			0.074	0.074	0.000	0.074		
			Edge 4 at 0mm	0.022	0.861		0.883	0.022	0.861	0.883		
			Bottom Face at 0mm	1.227	1.085	1.182	2.312	2.409	2.267	3.494	0.03	Case 27
			Edge 1 at 0mm	0.477		0.919	0.477	1.396	0.919	1.396		
			Edge 2 at 0mm	1.289			1.289	1.289	0.000	1.289		
			Bottom Face at 11mm	1.210	1.085	1.182	2.295	2.392	2.267	3.477	0.03	Case 28
LTE Band 7		Edge 1 at 9mm	0.528		0.919	0.528	1.447	0.919	1.447			
		Edge 2 at 15mm	0.506			0.506	0.506	0.000	0.506			
		Bottom Face at 0mm	1.263	1.085	1.182	2.348	2.445	2.267	3.530	0.03	Case 29	
		Edge 1 at 0mm	0.304		0.919	0.304	1.223	0.919	1.223			
		Edge 2 at 0mm	0.696			0.696	0.696	0.000	0.696			
		Bottom Face at 11mm	0.384	1.085	1.182	1.469	1.566	2.267	2.651	0.03	Case 30	
		Edge 1 at 9mm	0.408		0.919	0.408	1.327	0.919	1.327			
		Edge 2 at 15mm	0.187			0.187	0.187	0.000	0.187			



WWAN Band	Exposure Position	1	4	5	1+4 Summed 1g SAR (W/kg)	1+5 Summed 1g SAR (W/kg)	4+5 Summed 1g SAR (W/kg)	1+4+5 Summed 1g SAR (W/kg)	1+4+5 SPLSR	1+4+5 Case No	
		WWAN	5GHz WLAN Ant 1	5GHz WLAN Ant 2							
		1g SAR (W/kg)	1g SAR (W/kg)	1g SAR (W/kg)							
LTE	LTE Band 12	Bottom Face at 0mm	1.017	1.085	1.182	2.102	2.199	2.267	3.284	0.03	Case 31
		Edge 1 at 0mm	0.112		0.919	0.112	1.031	0.919	1.031		
		Edge 2 at 0mm	0.616			0.616	0.616	0.000	0.616		
		Bottom Face at 11mm	0.494	1.085	1.182	1.579	1.676	2.267	2.761	0.03	Case 32
		Edge 1 at 9mm	0.089		0.919	0.089	1.008	0.919	1.008		
		Edge 2 at 15mm	0.219			0.219	0.219	0.000	0.219		
		Edge 3 at 0mm	0.028			0.028	0.028	0.000	0.028		
	Edge 4 at 0mm	0.021	0.861		0.882	0.021	0.861	0.882			
	LTE Band 13	Bottom Face at 0mm	1.230	1.085	1.182	2.315	2.412	2.267	3.497	0.03	Case 33
		Edge 1 at 0mm	0.197		0.919	0.197	1.116	0.919	1.116		
		Edge 2 at 0mm	0.787			0.787	0.787	0.000	0.787		
		Bottom Face at 11mm	0.673	1.085	1.182	1.758	1.855	2.267	2.940	0.03	Case 34
		Edge 1 at 9mm	0.225		0.919	0.225	1.144	0.919	1.144		
		Edge 2 at 15mm	0.237			0.237	0.237	0.000	0.237		
		Edge 3 at 0mm	0.056			0.056	0.056	0.000	0.056		
	Edge 4 at 0mm	0.031	0.861		0.892	0.031	0.861	0.892			
	LTE Band 25	Bottom Face at 0mm	0.935	1.085	1.182	2.020	2.117	2.267	3.202	0.03	Case 35
		Edge 1 at 0mm	0.504		0.919	0.504	1.423	0.919	1.423		
		Edge 2 at 0mm	1.105			1.105	1.105	0.000	1.105		
		Bottom Face at 11mm	0.971	1.085	1.182	2.056	2.153	2.267	3.238	0.03	Case 36
		Edge 1 at 9mm	0.498		0.919	0.498	1.417	0.919	1.417		
		Edge 2 at 15mm	0.651			0.651	0.651	0.000	0.651		
	LTE Band 26	Bottom Face at 0mm	1.090	1.085	1.182	2.175	2.272	2.267	3.357	0.03	Case 37
		Edge 1 at 0mm	0.152		0.919	0.152	1.071	0.919	1.071		
		Edge 2 at 0mm	0.657			0.657	0.657	0.000	0.657		
		Bottom Face at 11mm	0.534	1.085	1.182	1.619	1.716	2.267	2.801	0.03	Case 38
		Edge 1 at 9mm	0.171		0.919	0.171	1.090	0.919	1.090		
		Edge 2 at 15mm	0.229			0.229	0.229	0.000	0.229		
LTE Band 41	Bottom Face at 0mm	1.267	1.085	1.182	2.352	2.449	2.267	3.534	0.03	Case 39	
	Edge 1 at 0mm	0.146		0.919	0.146	1.065	0.919	1.065			
	Edge 2 at 0mm	0.515			0.515	0.515	0.000	0.515			
	Bottom Face at 11mm	0.414	1.085	1.182	1.499	1.596	2.267	2.681	0.03	Case 40	
	Edge 1 at 9mm	0.150		0.919	0.150	1.069	0.919	1.069			
	Edge 2 at 15mm	0.126			0.126	0.126	0.000	0.126			



WWAN Band	Exposure Position	1	2	4	6	1+2+6	1+4+6	1+6	1+2+6	1+2+6	1+4+6	1+4+6	
		WWAN	2.4GHz WLAN Ant 1	5GHz WLAN Ant 1	Bluetooth Ant 2	Summed 1g SAR (W/kg)	Summed 1g SAR (W/kg)	Summed 1g SAR (W/kg)	SPLSR	Case No	SPLSR	Case No	
		1g SAR (W/kg)	1g SAR (W/kg)	1g SAR (W/kg)	1g SAR (W/kg)								
WCDMA	WCDMA II	Bottom Face at 0mm	0.750	0.982	1.085	0.091	1.823	1.926	0.841	0.01	Case 41	0.01	Case 57
		Edge 1 at 0mm	0.499			0.080	0.579	0.579	0.579				
		Edge 2 at 0mm	0.957				0.957	0.957	0.957				
		Bottom Face at 11mm	1.019	0.982	1.085	0.091	2.092	2.195	1.110	0.01	Case 42	0.01	Case 58
		Edge 1 at 9mm	0.603			0.080	0.683	0.683	0.683				
		Edge 2 at 15mm	0.651				0.651	0.651	0.651				
	WCDMA IV	Bottom Face at 0mm	1.147	0.982	1.085	0.091	2.220	2.323	1.238	0.01	Case 43	0.01	Case 59
		Edge 1 at 0mm	0.454			0.080	0.534	0.534	0.534				
		Edge 2 at 0mm	1.113				1.113	1.113	1.113				
		Bottom Face at 11mm	1.297	0.982	1.085	0.091	2.370	2.473	1.388	0.01	Case 44	0.01	Case 60
		Edge 1 at 9mm	0.618			0.080	0.698	0.698	0.698				
		Edge 2 at 15mm	0.534				0.534	0.534	0.534				
	WCDMA V	Bottom Face at 0mm	1.188	0.982	1.085	0.091	2.261	2.364	1.279	0.01	Case 45	0.01	Case 61
		Edge 1 at 0mm	0.200			0.080	0.280	0.280	0.280				
		Edge 2 at 0mm	0.671				0.671	0.671	0.671				
		Bottom Face at 11mm	0.503	0.982	1.085	0.091	1.576	1.679	0.594			0.01	Case 62
		Edge 1 at 9mm	0.181			0.080	0.261	0.261	0.261				
		Edge 2 at 15mm	0.251				0.251	0.251	0.251				
Edge 3 at 0mm		0.074				0.074	0.074	0.074					
Edge 4 at 0mm		0.022	0.400	0.861		0.422	0.883	0.022					
LTE	LTE Band 4	Bottom Face at 0mm	1.227	0.982	1.085	0.091	2.300	2.403	1.318	0.01	Case 46	0.01	Case 63
		Edge 1 at 0mm	0.477			0.080	0.557	0.557	0.557				
		Edge 2 at 0mm	1.289				1.289	1.289	1.289				
		Bottom Face at 11mm	1.210	0.982	1.085	0.091	2.283	2.386	1.301	0.01	Case 47	0.01	Case 64
		Edge 1 at 9mm	0.528			0.080	0.608	0.608	0.608				
		Edge 2 at 15mm	0.506				0.506	0.506	0.506				
	LTE Band 7	Bottom Face at 0mm	1.263	0.982	1.085	0.091	2.336	2.439	1.354	0.01	Case 48	0.01	Case 65
		Edge 1 at 0mm	0.304			0.080	0.384	0.384	0.384				
		Edge 2 at 0mm	0.696				0.696	0.696	0.696				
		Bottom Face at 11mm	0.384	0.982	1.085	0.091	1.457	1.560	0.475				
		Edge 1 at 9mm	0.408			0.080	0.488	0.488	0.488				
		Edge 2 at 15mm	0.187				0.187	0.187	0.187				



WWAN Band	Exposure Position	1	2	4	6	1+2+6	1+4+6	1+6	1+2+6	1+2+6	1+4+6	1+4+6	
		WWAN	2.4GHz WLAN Ant 1	5GHz WLAN Ant 1	Bluetooth Ant 2	Summed 1g SAR (W/kg)	Summed 1g SAR (W/kg)	Summed 1g SAR (W/kg)	SPLSR	Case No	SPLSR	Case No	
		1g SAR (W/kg)	1g SAR (W/kg)	1g SAR (W/kg)	1g SAR (W/kg)								
LTE	LTE Band 12	Bottom Face at 0mm	1.017	0.982	1.085	0.091	2.090	2.193	1.108	0.01	Case 49	0.01	Case 66
		Edge 1 at 0mm	0.112			0.080	0.192	0.192	0.192				
		Edge 2 at 0mm	0.616				0.616	0.616	0.616				
		Bottom Face at 11mm	0.494	0.982	1.085	0.091	1.567	1.670	0.585			0.01	Case 67
		Edge 1 at 9mm	0.089			0.080	0.169	0.169	0.169				
		Edge 2 at 15mm	0.219				0.219	0.219	0.219				
		Edge 3 at 0mm	0.028				0.028	0.028	0.028				
	Edge 4 at 0mm	0.021	0.400	0.861		0.421	0.882	0.021					
	LTE Band 13	Bottom Face at 0mm	1.230	0.982	1.085	0.091	2.303	2.406	1.321	0.01	Case 50	0.01	Case 68
		Edge 1 at 0mm	0.197			0.080	0.277	0.277	0.277				
		Edge 2 at 0mm	0.787				0.787	0.787	0.787				
		Bottom Face at 11mm	0.673	0.982	1.085	0.091	1.746	1.849	0.764	0.01	Case 51	0.01	Case 69
		Edge 1 at 9mm	0.225			0.080	0.305	0.305	0.305				
		Edge 2 at 15mm	0.237				0.237	0.237	0.237				
		Edge 3 at 0mm	0.056				0.056	0.056	0.056				
	Edge 4 at 0mm	0.031	0.400	0.861		0.431	0.892	0.031					
	LTE Band 25	Bottom Face at 0mm	0.935	0.982	1.085	0.091	2.008	2.111	1.026	0.01	Case 52	0.01	Case 70
		Edge 1 at 0mm	0.504			0.080	0.584	0.584	0.584				
		Edge 2 at 0mm	1.105				1.105	1.105	1.105				
		Bottom Face at 11mm	0.971	0.982	1.085	0.091	2.044	2.147	1.062	0.01	Case 53	0.01	Case 71
		Edge 1 at 9mm	0.498			0.080	0.578	0.578	0.578				
	LTE Band 26	Edge 2 at 15mm	0.651				0.651	0.651	0.651				
		Bottom Face at 0mm	1.090	0.982	1.085	0.091	2.163	2.266	1.181	0.01	Case 54	0.01	Case 72
		Edge 1 at 0mm	0.152			0.080	0.232	0.232	0.232				
		Edge 2 at 0mm	0.657				0.657	0.657	0.657				
		Bottom Face at 11mm	0.534	0.982	1.085	0.091	1.607	1.710	0.625	0.01	Case 55	0.01	Case 73
	LTE Band 41	Edge 1 at 9mm	0.171			0.080	0.251	0.251	0.251				
		Edge 2 at 15mm	0.229				0.229	0.229	0.229				
Bottom Face at 0mm		1.267	0.982	1.085	0.091	2.340	2.443	1.358	0.01	Case 56	0.01	Case 74	
Edge 1 at 0mm		0.146			0.080	0.226	0.226	0.226					
Edge 2 at 0mm		0.515				0.515	0.515	0.515					
Bottom Face at 11mm		0.414	0.982	1.085	0.091	1.487	1.590	0.505					
Edge 1 at 9mm	0.150			0.080	0.230	0.230	0.230						
Edge 2 at 15mm	0.126				0.126	0.126	0.126						

15.2 SPLSR Evaluation and Analysis

General Note:

- SPLSR = $(SAR_1 + SAR_2)^{1.5} / (\text{min. separation distance, mm})$. If $SPLSR \leq 0.04$, simultaneously transmission SAR measurement is not necessary

Case 1	Band	Position	SAR (W/kg)	Gap (cm)	SAR peak location (m)			3D distance (mm)	Summed SAR (W/kg)	SPLSR Results	Simultaneous SAR
					X	Y	Z				
WCDMA II	2.4GHz ANT1	Bottom Face	0.75	0mm	75	141.5	3.44	285.8	1.73	0.01	Not required
			0.982	0mm	20.2	-139	3.08				
WCDMA II	2.4GHz ANT2	Bottom Face	0.75	0mm	75	141.5	3.44	168.3	1.32	0.01	Not required
			0.572	0mm	99.4	-25	2.33				
2.4GHz ANT1	2.4GHz ANT2	Bottom Face	0.982	0mm	20.2	-139	3.08	138.8	1.55	0.01	Not required
			0.572	0mm	99.4	-25	2.33				

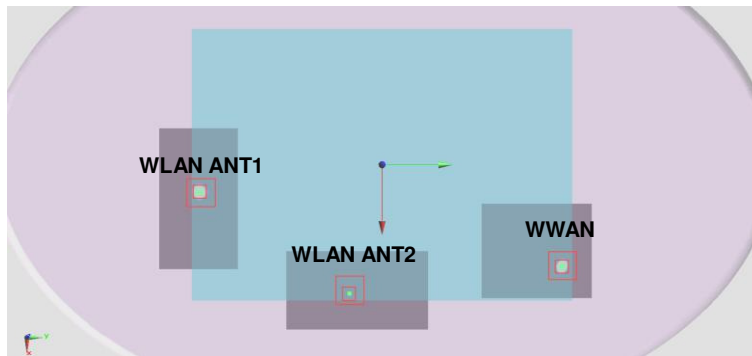

Case 2	Band	Position	SAR (W/kg)	Gap (cm)	SAR peak location (m)			3D distance (mm)	Summed SAR (W/kg)	SPLSR Results	Simultaneous SAR
					X	Y	Z				
WCDMA II	2.4GHz ANT1	Bottom Face	1.019	11mm	74	143	2.09	287.1	2.00	0.01	Not required
			0.982	0mm	20.2	-139	3.08				
WCDMA II	2.4GHz ANT2	Bottom Face	1.019	11mm	74	143	2.09	169.9	1.59	0.01	Not required
			0.572	0mm	99.4	-25	2.33				
2.4GHz ANT1	2.4GHz ANT2	Bottom Face	0.982	0mm	20.2	-139	3.08	138.8	1.55	0.01	Not required
			0.572	0mm	99.4	-25	2.33				

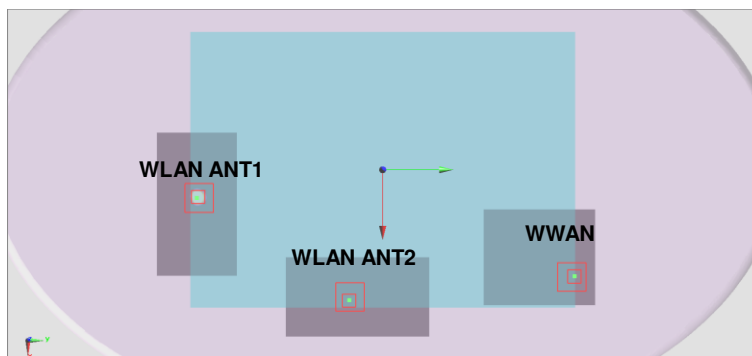

Case 3	Band	Position	SAR (W/kg)	Gap (cm)	SAR peak location (m)			3D distance (mm)	Summed SAR (W/kg)	SPLSR Results	Simultaneous SAR
					X	Y	Z				
Case 3	WCDMA IV	Bottom Face	1.147	0mm	70.9	144.5	2.91	288.0	2.13	0.01	Not required
	2.4GHz ANT1		0.982	0mm	20.2	-139	3.08				
	WCDMA IV	Bottom Face	1.147	0mm	70.9	144.5	2.91	171.9	1.72	0.01	Not required
	2.4GHz ANT2		0.572	0mm	99.4	-25	2.33				
	2.4GHz ANT1	Bottom Face	0.982	0mm	20.2	-139	3.08	138.8	1.55	0.01	Not required
	2.4GHz ANT2		0.572	0mm	99.4	-25	2.33				

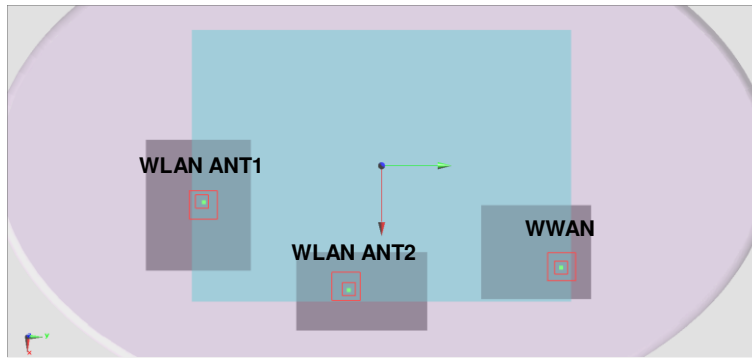

Case 4	Band	Position	SAR (W/kg)	Gap (cm)	SAR peak location (m)			3D distance (mm)	Summed SAR (W/kg)	SPLSR Results	Simultaneous SAR
					X	Y	Z				
Case 4	WCDMA IV	Bottom Face	1.297	11mm	74	143	2.11	287.1	2.28	0.01	Not required
	2.4GHz ANT1		0.982	0mm	20.2	-139	3.08				
	WCDMA IV	Bottom Face	1.297	11mm	74	143	2.11	169.9	1.87	0.02	Not required
	2.4GHz ANT2		0.572	0mm	99.4	-25	2.33				
	2.4GHz ANT1	Bottom Face	0.982	0mm	20.2	-139	3.08	138.8	1.55	0.01	Not required
	2.4GHz ANT2		0.572	0mm	99.4	-25	2.33				

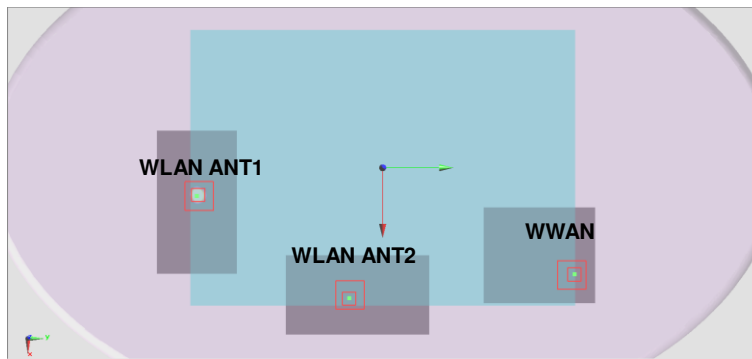

Case 5	Band	Position	SAR (W/kg)	Gap (cm)	SAR peak location (m)			3D distance (mm)	Summed SAR (W/kg)	SPLSR Results	Simultaneous SAR
					X	Y	Z				
Case 5	WCDMA V	Bottom Face	1.188	0mm	62.5	138	2.8	280.2	2.17	0.01	Not required
	2.4GHz ANT1		0.982	0mm	20.2	-139	3.08				
	WCDMA V	Bottom Face	1.188	0mm	62.5	138	2.8	167.1	1.76	0.01	Not required
	2.4GHz ANT2		0.572	0mm	99.4	-25	2.33				
	2.4GHz ANT1	Bottom Face	0.982	0mm	20.2	-139	3.08	138.8	1.55	0.01	Not required
	2.4GHz ANT2		0.572	0mm	99.4	-25	2.33				

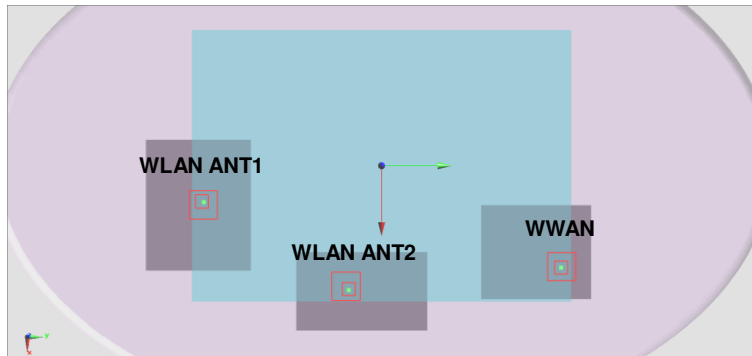

Case 6	Band	Position	SAR (W/kg)	Gap (cm)	SAR peak location (m)			3D distance (mm)	Summed SAR (W/kg)	SPLSR Results	Simultaneous SAR
					X	Y	Z				
Case 6	WCDMA V	Bottom Face	0.503	11mm	72.5	143	1.52	286.8	1.49	0.01	Not required
	2.4GHz ANT1		0.982	0mm	20.2	-139	3.08				
	WCDMA V	Bottom Face	0.503	11mm	72.5	143	1.52	170.1	1.08	0.01	Not required
	2.4GHz ANT2		0.572	0mm	99.4	-25	2.33				
	2.4GHz ANT1	Bottom Face	0.982	0mm	20.2	-139	3.08	138.8	1.55	0.01	Not required
	2.4GHz ANT2		0.572	0mm	99.4	-25	2.33				

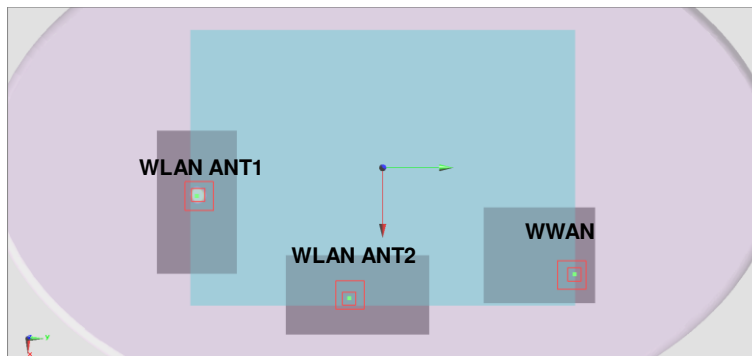

Case 7	Band	Position	SAR (W/kg)	Gap (cm)	SAR peak location (m)			3D distance (mm)	Summed SAR (W/kg)	SPLSR Results	Simultaneous SAR
					X	Y	Z				
Case 7	LTE Band 4	Bottom Face	1.227	0mm	70.9	142.9	2.92	286.4	2.21	0.01	Not required
	2.4GHz ANT1		0.982	0mm	20.2	-139	3.08				
	LTE Band 4	Bottom Face	1.227	0mm	70.9	142.9	2.92	170.3	1.80	0.01	Not required
	2.4GHz ANT2		0.572	0mm	99.4	-25	2.33				
	2.4GHz ANT1	Bottom Face	0.982	0mm	20.2	-139	3.08	138.8	1.55	0.01	Not required
	2.4GHz ANT2		0.572	0mm	99.4	-25	2.33				

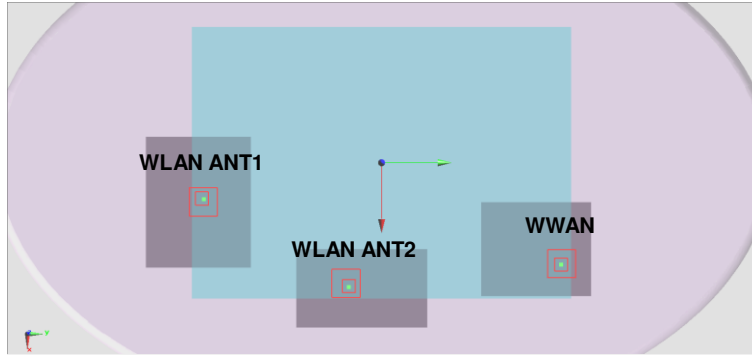

Case 8	Band	Position	SAR (W/kg)	Gap (cm)	SAR peak location (m)			3D distance (mm)	Summed SAR (W/kg)	SPLSR Results	Simultaneous SAR
					X	Y	Z				
Case 8	LTE Band 4	Bottom Face	1.21	11mm	68.1	142.5	1.76	285.5	2.19	0.01	Not required
	2.4GHz ANT1		0.982	0mm	20.2	-139	3.08				
	LTE Band 4	Bottom Face	1.21	11mm	68.1	142.5	1.76	170.4	1.78	0.01	Not required
	2.4GHz ANT2		0.572	0mm	99.4	-25	2.33				
	2.4GHz ANT1	Bottom Face	0.982	0mm	20.2	-139	3.08	138.8	1.55	0.01	Not required
	2.4GHz ANT2		0.572	0mm	99.4	-25	2.33				

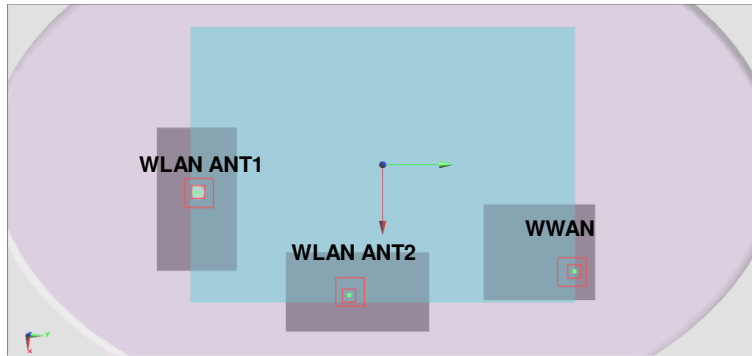

Case 9	Band	Position	SAR (W/kg)	Gap (cm)	SAR peak location (m)			3D distance (mm)	Summed SAR (W/kg)	SPLSR Results	Simultaneous SAR
					X	Y	Z				
LTE Band 7	2.4GHz ANT1	Bottom Face	1.263	0mm	77	136.2	3.32	281.0	2.25	0.01	Not required
			0.982	0mm	20.2	-139	3.08				
LTE Band 7	2.4GHz ANT2	Bottom Face	1.263	0mm	77	136.2	3.32	162.8	1.84	0.02	Not required
			0.572	0mm	99.4	-25	2.33				
2.4GHz ANT1	2.4GHz ANT2	Bottom Face	0.982	0mm	20.2	-139	3.08	138.8	1.55	0.01	Not required
			0.572	0mm	99.4	-25	2.33				

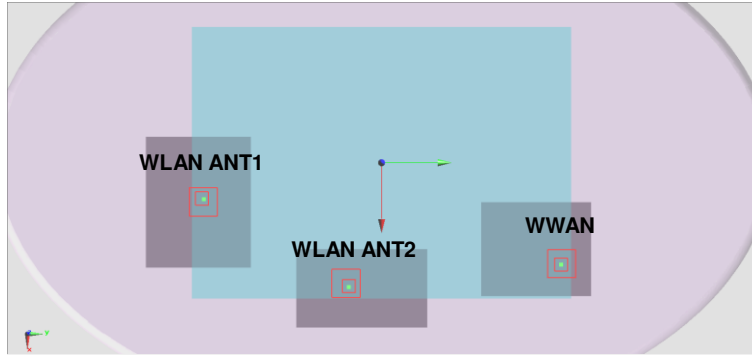

Case 10	Band	Position	SAR (W/kg)	Gap (cm)	SAR peak location (m)			3D distance (mm)	Summed SAR (W/kg)	SPLSR Results	Simultaneous SAR
					X	Y	Z				
LTE Band 7	2.4GHz ANT1	Bottom Face	0.384	11mm	81.4	144.4	2.22	289.9	1.37	0.01	Not required
			0.982	0mm	20.2	-139	3.08				
LTE Band 7	2.4GHz ANT2	Bottom Face	0.384	11mm	81.4	144.4	2.22	170.4	0.96	0.01	Not required
			0.572	0mm	99.4	-25	2.33				
2.4GHz ANT1	2.4GHz ANT2	Bottom Face	0.982	0mm	20.2	-139	3.08	138.8	1.55	0.01	Not required
			0.572	0mm	99.4	-25	2.33				

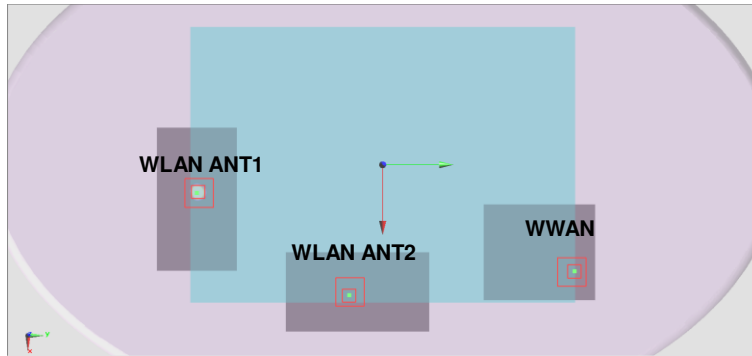

Case 11	Band	Position	SAR (W/kg)	Gap (cm)	SAR peak location (m)			3D distance (mm)	Summed SAR (W/kg)	SPLSR Results	Simultaneous SAR
					X	Y	Z				
Case 11	LTE Band 12	Bottom Face	1.017	0mm	52.6	141.4	2.37	282.3	2.00	0.01	Not required
	2.4GHz ANT1		0.982	0mm	20.2	-139	3.08				
	LTE Band 12	Bottom Face	1.017	0mm	52.6	141.4	2.37	172.9	1.59	0.01	Not required
	2.4GHz ANT2		0.572	0mm	99.4	-25	2.33				
	2.4GHz ANT1	Bottom Face	0.982	0mm	20.2	-139	3.08	138.8	1.55	0.01	Not required
	2.4GHz ANT2		0.572	0mm	99.4	-25	2.33				

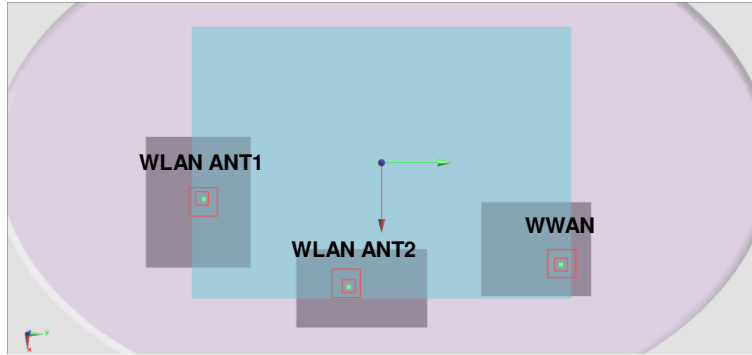

Case 12	Band	Position	SAR (W/kg)	Gap (cm)	SAR peak location (m)			3D distance (mm)	Summed SAR (W/kg)	SPLSR Results	Simultaneous SAR
					X	Y	Z				
Case 12	LTE Band 12	Bottom Face	0.494	11mm	69.7	148.9	1.48	292.1	1.48	0.01	Not required
	2.4GHz ANT1		0.982	0mm	20.2	-139	3.08				
	LTE Band 12	Bottom Face	0.494	11mm	69.7	148.9	1.48	176.4	1.07	0.01	Not required
	2.4GHz ANT2		0.572	0mm	99.4	-25	2.33				
	2.4GHz ANT1	Bottom Face	0.982	0mm	20.2	-139	3.08	138.8	1.55	0.01	Not required
	2.4GHz ANT2		0.572	0mm	99.4	-25	2.33				

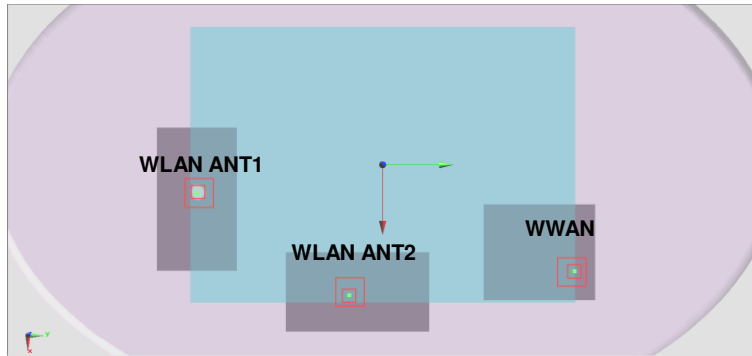

Case 13	Band	Position	SAR (W/kg)	Gap (cm)	SAR peak location (m)			3D distance (mm)	Summed SAR (W/kg)	SPLSR Results	Simultaneous SAR
					X	Y	Z				
Case 13	LTE Band 13	Bottom Face	1.23	0mm	70	143	2.67	286.4	2.21	0.01	Not required
	2.4GHz ANT1		0.982	0mm	20.2	-139	3.08				
	LTE Band 13	Bottom Face	1.23	0mm	70	143	2.67	170.6	1.80	0.01	Not required
	2.4GHz ANT2		0.572	0mm	99.4	-25	2.33				
	2.4GHz ANT1	Bottom Face	0.982	0mm	20.2	-139	3.08	138.8	1.55	0.01	Not required
	2.4GHz ANT2		0.572	0mm	99.4	-25	2.33				

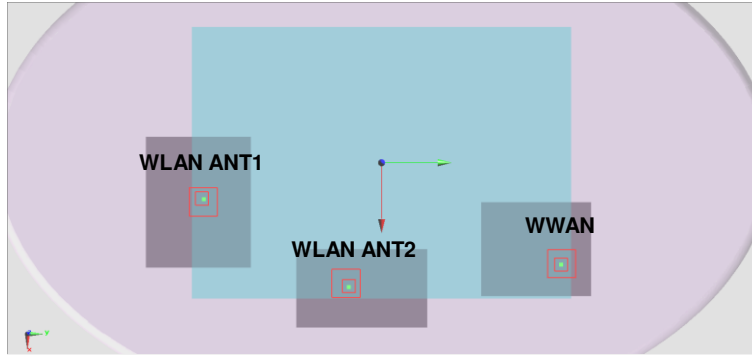

Case 14	Band	Position	SAR (W/kg)	Gap (cm)	SAR peak location (m)			3D distance (mm)	Summed SAR (W/kg)	SPLSR Results	Simultaneous SAR
					X	Y	Z				
Case 14	LTE Band 13	Bottom Face	0.673	11mm	69.3	144.5	1.46	287.7	1.66	0.01	Not required
	2.4GHz ANT1		0.982	0mm	20.2	-139	3.08				
	LTE Band 13	Bottom Face	0.673	11mm	69.3	144.5	1.46	172.2	1.25	0.01	Not required
	2.4GHz ANT2		0.572	0mm	99.4	-25	2.33				
	2.4GHz ANT1	Bottom Face	0.982	0mm	20.2	-139	3.08	138.8	1.55	0.01	Not required
	2.4GHz ANT2		0.572	0mm	99.4	-25	2.33				

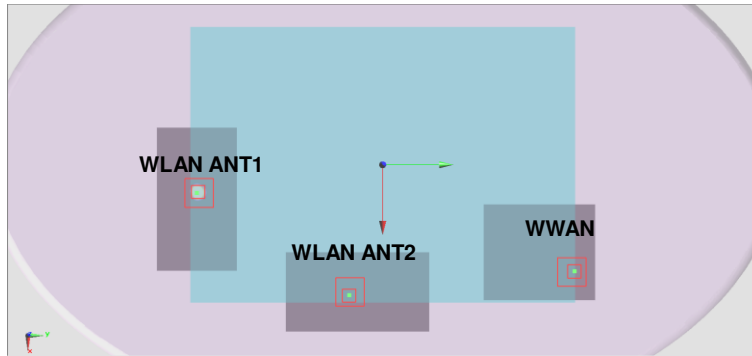

Case 15	Band	Position	SAR (W/kg)	Gap (cm)	SAR peak location (m)			3D distance (mm)	Summed SAR (W/kg)	SPLSR Results	Simultaneous SAR
					X	Y	Z				
Case 15	LTE Band 25	Bottom Face	0.935	0mm	73.4	143.1	3.1	287.1	1.92	0.01	Not required
	2.4GHz ANT1		0.982	0mm	20.2	-139	3.08				
	LTE Band 25	Bottom Face	0.935	0mm	73.4	143.1	3.1	170.1	1.51	0.01	Not required
	2.4GHz ANT2		0.572	0mm	99.4	-25	2.33				
	2.4GHz ANT1	Bottom Face	0.982	0mm	20.2	-139	3.08	138.8	1.55	0.01	Not required
	2.4GHz ANT2		0.572	0mm	99.4	-25	2.33				

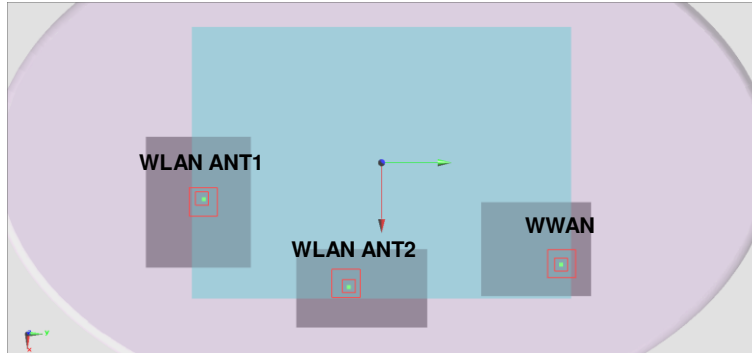

Case 16	Band	Position	SAR (W/kg)	Gap (cm)	SAR peak location (m)			3D distance (mm)	Summed SAR (W/kg)	SPLSR Results	Simultaneous SAR
					X	Y	Z				
Case 16	LTE Band 25	Bottom Face	0.971	11mm	65.1	142.9	1.7	285.5	1.95	0.01	Not required
	2.4GHz ANT1		0.982	0mm	20.2	-139	3.08				
	LTE Band 25	Bottom Face	0.971	11mm	65.1	142.9	1.7	171.4	1.54	0.01	Not required
	2.4GHz ANT2		0.572	0mm	99.4	-25	2.33				
	2.4GHz ANT1	Bottom Face	0.982	0mm	20.2	-139	3.08	138.8	1.55	0.01	Not required
	2.4GHz ANT2		0.572	0mm	99.4	-25	2.33				

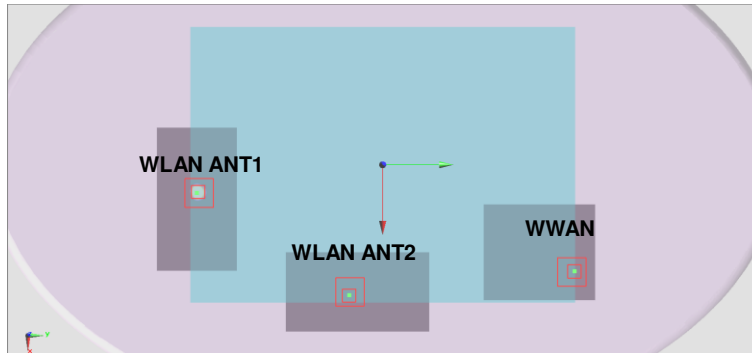

Case 17	Band	Position	SAR (W/kg)	Gap (cm)	SAR peak location (m)			3D distance (mm)	Summed SAR (W/kg)	SPLSR Results	Simultaneous SAR
					X	Y	Z				
LTE Band 26	2.4GHz ANT1	Bottom Face	1.09	0mm	63.1	139.3	2.73	281.6	2.07	0.01	Not required
			0.982	0mm	20.2	-139	3.08				
LTE Band 26	2.4GHz ANT2	Bottom Face	1.09	0mm	63.1	139.3	2.73	168.3	1.66	0.01	Not required
			0.572	0mm	99.4	-25	2.33				
2.4GHz ANT1	2.4GHz ANT2	Bottom Face	0.982	0mm	20.2	-139	3.08	138.8	1.55	0.01	Not required
			0.572	0mm	99.4	-25	2.33				

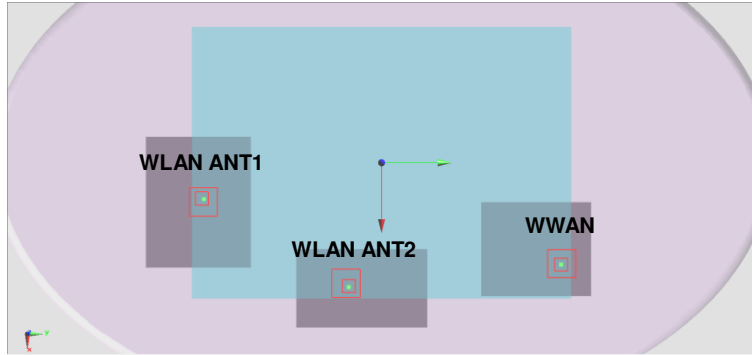

Case 18	Band	Position	SAR (W/kg)	Gap (cm)	SAR peak location (m)			3D distance (mm)	Summed SAR (W/kg)	SPLSR Results	Simultaneous SAR
					X	Y	Z				
LTE Band 26	2.4GHz ANT1	Bottom Face	0.534	11mm	72.5	144.5	1.53	288.3	1.52	0.01	Not required
			0.982	0mm	20.2	-139	3.08				
LTE Band 26	2.4GHz ANT2	Bottom Face	0.534	11mm	72.5	144.5	1.53	171.6	1.11	0.01	Not required
			0.572	0mm	99.4	-25	2.33				
2.4GHz ANT1	2.4GHz ANT2	Bottom Face	0.982	0mm	20.2	-139	3.08	138.8	1.55	0.01	Not required
			0.572	0mm	99.4	-25	2.33				

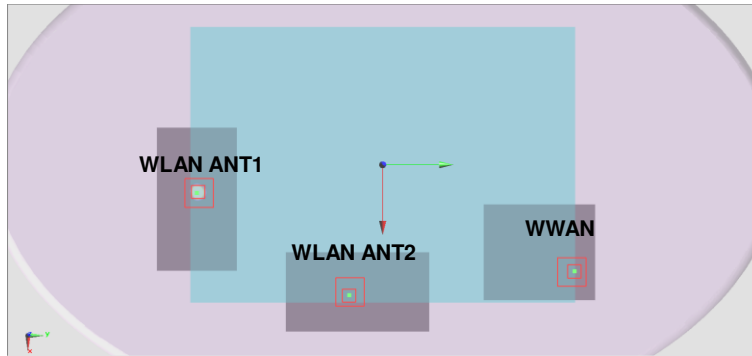

Case 19	Band	Position	SAR (W/kg)	Gap (cm)	SAR peak location (m)			3D distance (mm)	Summed SAR (W/kg)	SPLSR Results	Simultaneous SAR
					X	Y	Z				
Case 19	LTE Band 41	Bottom Face	1.267	0mm	79.8	137	3.24	282.4	2.25	0.01	Not required
	2.4GHz ANT1		0.982	0mm	20.2	-139	3.08				
Case 19	LTE Band 41	Bottom Face	1.267	0mm	79.8	137	3.24	163.2	1.84	0.02	Not required
	2.4GHz ANT2		0.572	0mm	99.4	-25	2.33				
Case 19	2.4GHz ANT1	Bottom Face	0.982	0mm	20.2	-139	3.08	138.8	1.55	0.01	Not required
	2.4GHz ANT2		0.572	0mm	99.4	-25	2.33				

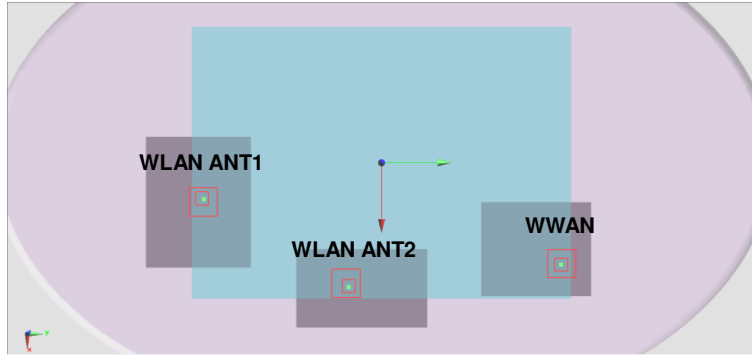

Case 20	Band	Position	SAR (W/kg)	Gap (cm)	SAR peak location (m)			3D distance (mm)	Summed SAR (W/kg)	SPLSR Results	Simultaneous SAR
					X	Y	Z				
Case 20	LTE Band 41	Bottom Face	0.414	11mm	78.6	138.6	2.05	283.7	1.40	0.01	Not required
	2.4GHz ANT1		0.982	0mm	20.2	-139	3.08				
Case 20	LTE Band 41	Bottom Face	0.414	11mm	78.6	138.6	2.05	164.9	0.99	0.01	Not required
	2.4GHz ANT2		0.572	0mm	99.4	-25	2.33				
Case 20	2.4GHz ANT1	Bottom Face	0.982	0mm	20.2	-139	3.08	138.8	1.55	0.01	Not required
	2.4GHz ANT2		0.572	0mm	99.4	-25	2.33				

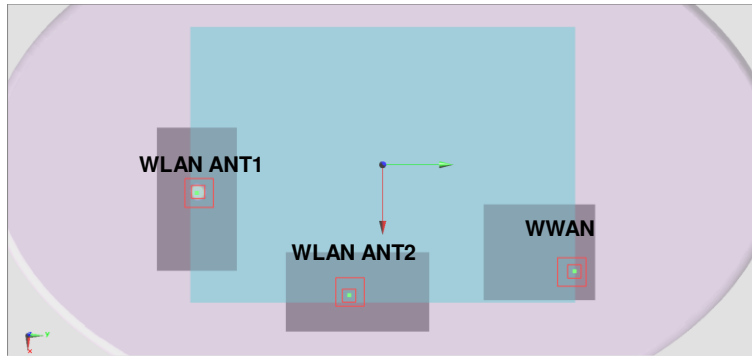

Case 21	Band	Position	SAR (W/kg)	Gap (cm)	SAR peak location (m)			3D distance (mm)	Summed SAR (W/kg)	SPLSR Results	Simultaneous SAR
					X	Y	Z				
WCDMA II	5GHz ANT1	Bottom Face	0.75	0mm	75	141.5	3.44	282.1	1.84	0.01	Not required
			1.085	0mm	19	-135	3.44				
WCDMA II	5GHz ANT2	Bottom Face	0.75	0mm	75	141.5	3.44	168.2	1.93	0.02	Not required
			1.182	0mm	94	-25.6	3.13				
5GHz ANT1	5GHz ANT2	Bottom Face	1.085	0mm	19	-135	3.44	132.6	2.27	0.03	Not required
			1.182	0mm	94	-25.6	3.13				

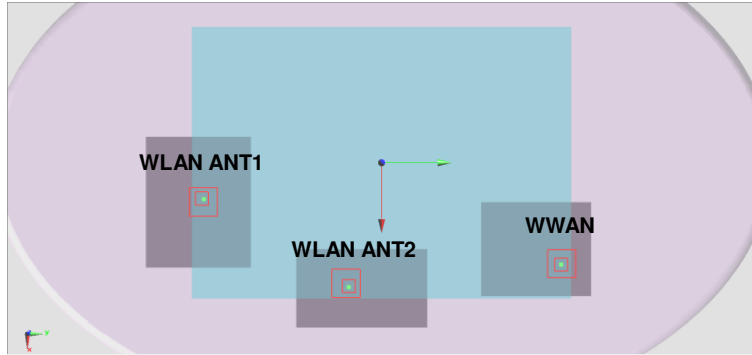

Case 22	Band	Position	SAR (W/kg)	Gap (cm)	SAR peak location (m)			3D distance (mm)	Summed SAR (W/kg)	SPLSR Results	Simultaneous SAR
					X	Y	Z				
WCDMA II	5GHz ANT1	Bottom Face	1.019	11mm	74	143	2.09	283.4	2.10	0.01	Not required
			1.085	0mm	19	-135	3.44				
WCDMA II	5GHz ANT2	Bottom Face	1.019	11mm	74	143	2.09	169.8	2.20	0.02	Not required
			1.182	0mm	94	-25.6	3.13				
5GHz ANT1	5GHz ANT2	Bottom Face	1.085	0mm	19	-135	3.44	132.6	2.27	0.03	Not required
			1.182	0mm	94	-25.6	3.13				

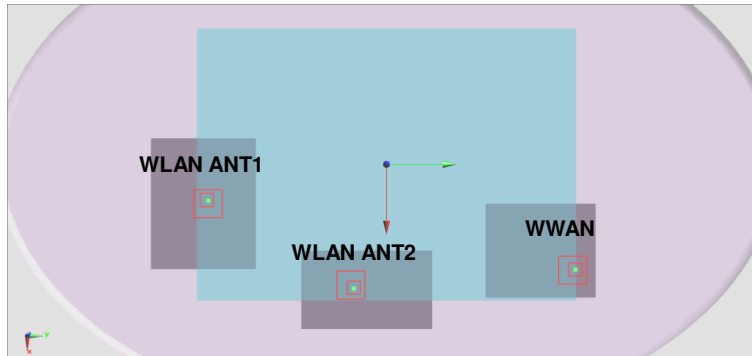

Case	Band	Position	SAR (W/kg)	Gap (cm)	SAR peak location (m)			3D distance (mm)	Summed SAR (W/kg)	SPLSR Results	Simultaneous SAR
					X	Y	Z				
23	WCDMA IV	Bottom Face	1.147	0mm	70.9	144.5	2.91	284.3	2.23	0.01	Not required
	5GHz ANT1		1.085	0mm	19	-135	3.44				
	WCDMA IV	Bottom Face	1.147	0mm	70.9	144.5	2.91	171.7	2.33	0.02	Not required
	5GHz ANT2		1.182	0mm	94	-25.6	3.13				
	5GHz ANT1	Bottom Face	1.085	0mm	19	-135	3.44	132.6	2.27	0.03	Not required
	5GHz ANT2		1.182	0mm	94	-25.6	3.13				

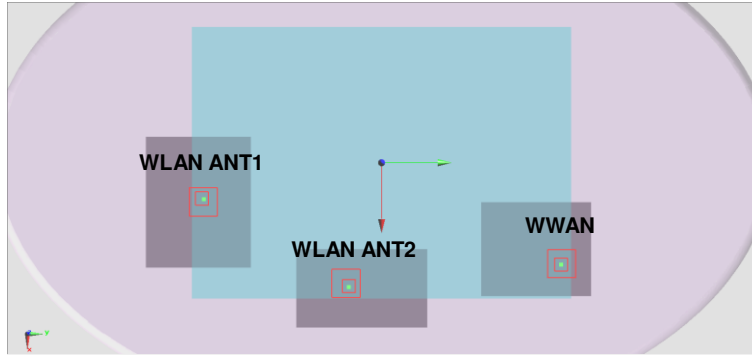

Case	Band	Position	SAR (W/kg)	Gap (cm)	SAR peak location (m)			3D distance (mm)	Summed SAR (W/kg)	SPLSR Results	Simultaneous SAR
					X	Y	Z				
24	WCDMA IV	Bottom Face	1.297	11mm	74	143	2.11	283.4	2.38	0.01	Not required
	5GHz ANT1		1.085	0mm	19	-135	3.44				
	WCDMA IV	Bottom Face	1.297	11mm	74	143	2.11	169.8	2.48	0.02	Not required
	5GHz ANT2		1.182	0mm	94	-25.6	3.13				
	5GHz ANT1	Bottom Face	1.085	0mm	19	-135	3.44	132.6	2.27	0.03	Not required
	5GHz ANT2		1.182	0mm	94	-25.6	3.13				

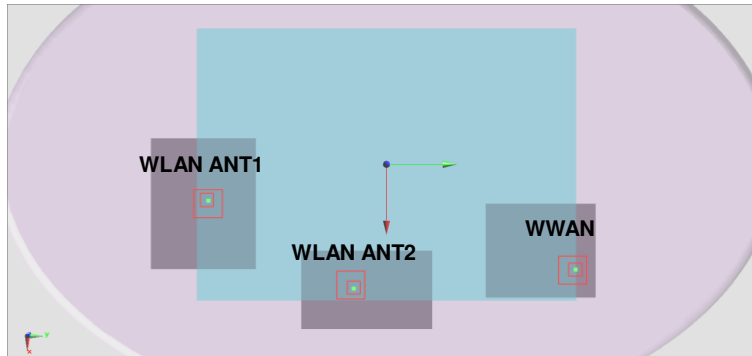

Case	Band	Position	SAR (W/kg)	Gap (cm)	SAR peak location (m)			3D distance (mm)	Summed SAR (W/kg)	SPLSR Results	Simultaneous SAR
					X	Y	Z				
25	WCDMA V	Bottom Face	1.188	0mm	62.5	138	2.8	276.4	2.27	0.01	Not required
	5GHz ANT1		1.085	0mm	19	-135	3.44				
	WCDMA V	Bottom Face	1.188	0mm	62.5	138	2.8	166.6	2.37	0.02	Not required
	5GHz ANT2		1.182	0mm	94	-25.6	3.13				
	5GHz ANT1	Bottom Face	1.085	0mm	19	-135	3.44	132.6	2.27	0.03	Not required
	5GHz ANT2		1.182	0mm	94	-25.6	3.13				

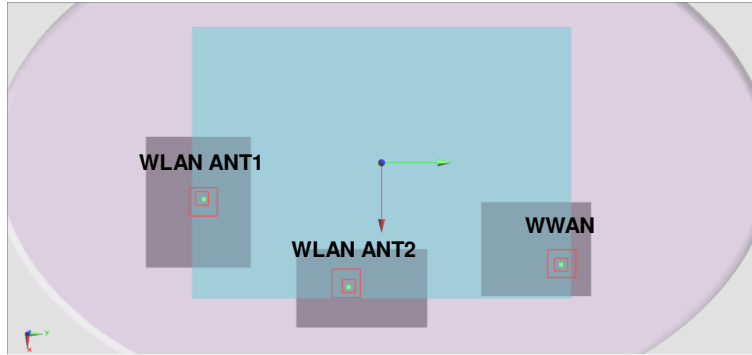

Case	Band	Position	SAR (W/kg)	Gap (cm)	SAR peak location (m)			3D distance (mm)	Summed SAR (W/kg)	SPLSR Results	Simultaneous SAR
					X	Y	Z				
26	WCDMA V	Bottom Face	0.503	11mm	72.5	143	1.52	283.1	1.59	0.01	Not required
	5GHz ANT1		1.085	0mm	19	-135	3.44				
	WCDMA V	Bottom Face	0.503	11mm	72.5	143	1.52	170.0	1.69	0.01	Not required
	5GHz ANT2		1.182	0mm	94	-25.6	3.13				
	5GHz ANT1	Bottom Face	1.085	0mm	19	-135	3.44	132.6	2.27	0.03	Not required
	5GHz ANT2		1.182	0mm	94	-25.6	3.13				

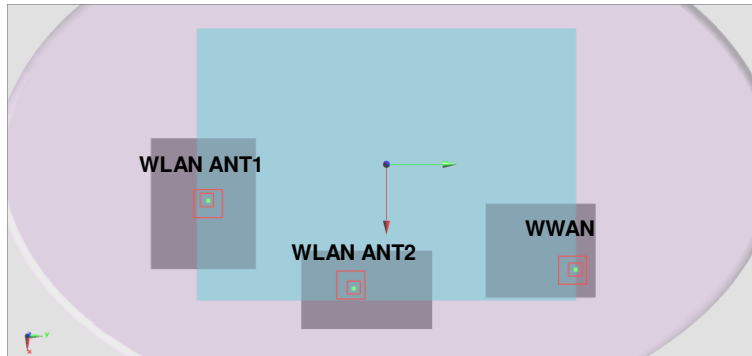

Case 27	Band	Position	SAR (W/kg)	Gap (cm)	SAR peak location (m)			3D distance (mm)	Summed SAR (W/kg)	SPLSR Results	Simultaneous SAR
					X	Y	Z				
Case 27	LTE Band 4	Bottom Face	1.227	0mm	70.9	142.9	2.92	282.7	2.31	0.01	Not required
	5GHz ANT1		1.085	0mm	19	-135	3.44				
Case 27	LTE Band 4	Bottom Face	1.227	0mm	70.9	142.9	2.92	170.1	2.41	0.02	Not required
	5GHz ANT2		1.182	0mm	94	-25.6	3.13				
Case 27	5GHz ANT1	Bottom Face	1.085	0mm	19	-135	3.44	132.6	2.27	0.03	Not required
	5GHz ANT2		1.182	0mm	94	-25.6	3.13				

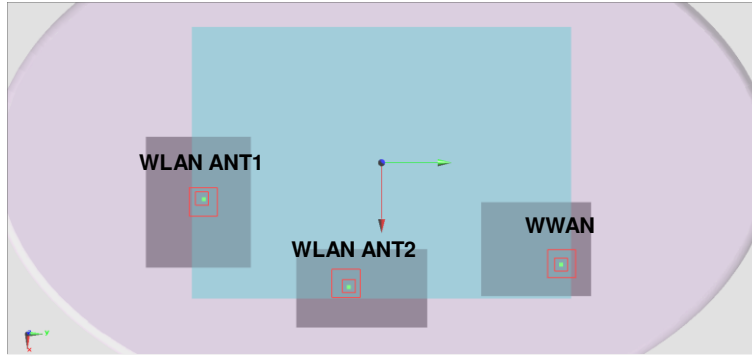

Case 28	Band	Position	SAR (W/kg)	Gap (cm)	SAR peak location (m)			3D distance (mm)	Summed SAR (W/kg)	SPLSR Results	Simultaneous SAR
					X	Y	Z				
Case 28	LTE Band 4	Bottom Face	1.21	11mm	68.1	142.5	1.76	281.8	2.30	0.01	Not required
	5GHz ANT1		1.085	0mm	19	-135	3.44				
Case 28	LTE Band 4	Bottom Face	1.21	11mm	68.1	142.5	1.76	170.1	2.39	0.02	Not required
	5GHz ANT2		1.182	0mm	94	-25.6	3.13				
Case 28	5GHz ANT1	Bottom Face	1.085	0mm	19	-135	3.44	132.6	2.27	0.03	Not required
	5GHz ANT2		1.182	0mm	94	-25.6	3.13				

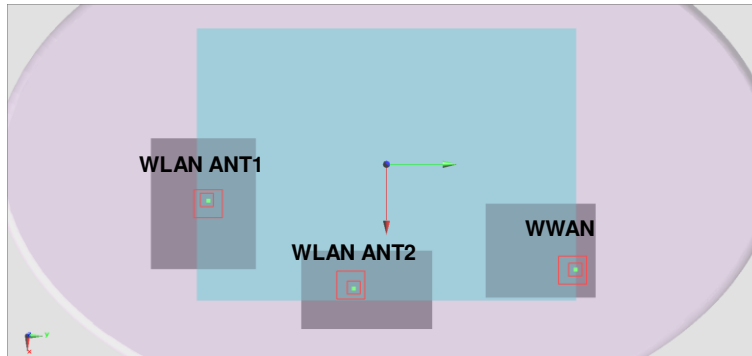

Case 29	Band	Position	SAR (W/kg)	Gap (cm)	SAR peak location (m)			3D distance (mm)	Summed SAR (W/kg)	SPLSR Results	Simultaneous SAR
					X	Y	Z				
Case 29	LTE Band 7	Bottom Face	1.263	0mm	77	136.2	3.32	277.3	2.35	0.01	Not required
	5GHz ANT1		1.085	0mm	19	-135	3.44				
Case 29	LTE Band 7	Bottom Face	1.263	0mm	77	136.2	3.32	162.7	2.45	0.02	Not required
	5GHz ANT2		1.182	0mm	94	-25.6	3.13				
Case 29	5GHz ANT1	Bottom Face	1.085	0mm	19	-135	3.44	132.6	2.27	0.03	Not required
	5GHz ANT2		1.182	0mm	94	-25.6	3.13				

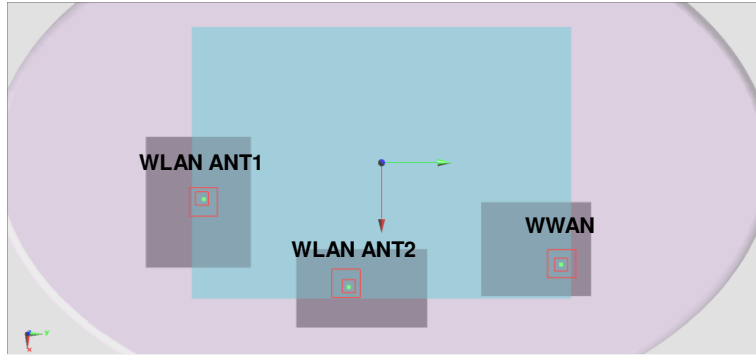

Case 30	Band	Position	SAR (W/kg)	Gap (cm)	SAR peak location (m)			3D distance (mm)	Summed SAR (W/kg)	SPLSR Results	Simultaneous SAR
					X	Y	Z				
Case 30	LTE Band 7	Bottom Face	0.384	11mm	81.4	144.4	2.22	286.3	1.47	0.01	Not required
	5GHz ANT1		1.085	0mm	19	-135	3.44				
Case 30	LTE Band 7	Bottom Face	0.384	11mm	81.4	144.4	2.22	170.5	1.57	0.01	Not required
	5GHz ANT2		1.182	0mm	94	-25.6	3.13				
Case 30	5GHz ANT1	Bottom Face	1.085	0mm	19	-135	3.44	132.6	2.27	0.03	Not required
	5GHz ANT2		1.182	0mm	94	-25.6	3.13				

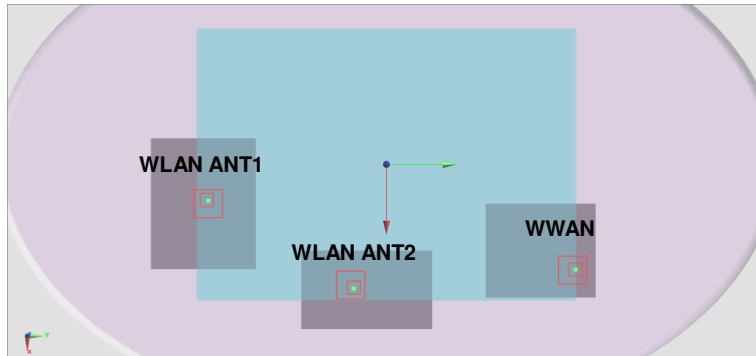

Case 31	Band	Position	SAR (W/kg)	Gap (cm)	SAR peak location (m)			3D distance (mm)	Summed SAR (W/kg)	SPLSR Results	Simultaneous SAR
					X	Y	Z				
Case 31	LTE Band 12	Bottom Face	1.017	0mm	52.6	141.4	2.37	278.4	2.10	0.01	Not required
	5GHz ANT1		1.085	0mm	19	-135	3.44				
	LTE Band 12	Bottom Face	1.017	0mm	52.6	141.4	2.37	172.1	2.20	0.02	Not required
	5GHz ANT2		1.182	0mm	94	-25.6	3.13				
	5GHz ANT1	Bottom Face	1.085	0mm	19	-135	3.44	132.6	2.27	0.03	Not required
	5GHz ANT2		1.182	0mm	94	-25.6	3.13				

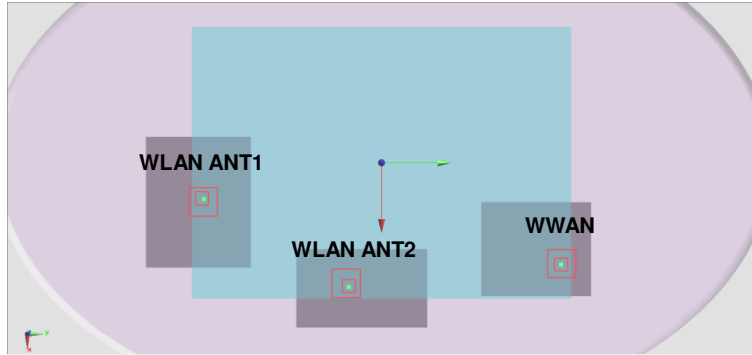

Case 32	Band	Position	SAR (W/kg)	Gap (cm)	SAR peak location (m)			3D distance (mm)	Summed SAR (W/kg)	SPLSR Results	Simultaneous SAR
					X	Y	Z				
Case 32	LTE Band 12	Bottom Face	0.494	11mm	69.7	148.9	1.48	288.4	1.58	0.01	Not required
	5GHz ANT1		1.085	0mm	19	-135	3.44				
	LTE Band 12	Bottom Face	0.494	11mm	69.7	148.9	1.48	176.2	1.68	0.01	Not required
	5GHz ANT2		1.182	0mm	94	-25.6	3.13				
	5GHz ANT1	Bottom Face	1.085	0mm	19	-135	3.44	132.6	2.27	0.03	Not required
	5GHz ANT2		1.182	0mm	94	-25.6	3.13				

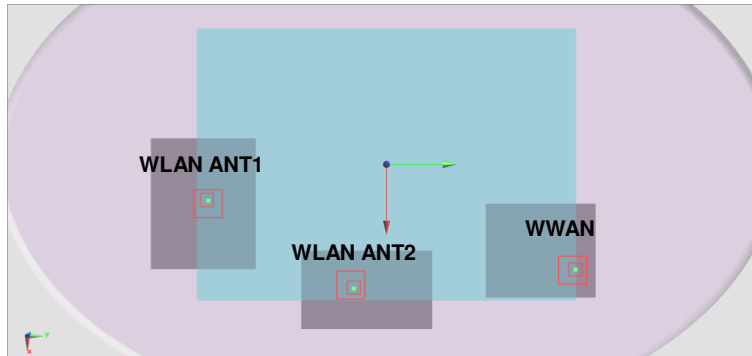

Case	Band	Position	SAR (W/kg)	Gap (cm)	SAR peak location (m)			3D distance (mm)	Summed SAR (W/kg)	SPLSR Results	Simultaneous SAR
					X	Y	Z				
33	LTE Band 13	Bottom Face	1.23	0mm	70	143	2.67	282.6	2.32	0.01	Not required
	5GHz ANT1		1.085	0mm	19	-135	3.44				
	LTE Band 13	Bottom Face	1.23	0mm	70	143	2.67	170.3	2.41	0.02	Not required
	5GHz ANT2		1.182	0mm	94	-25.6	3.13				
	5GHz ANT1	Bottom Face	1.085	0mm	19	-135	3.44	132.6	2.27	0.03	Not required
	5GHz ANT2		1.182	0mm	94	-25.6	3.13				

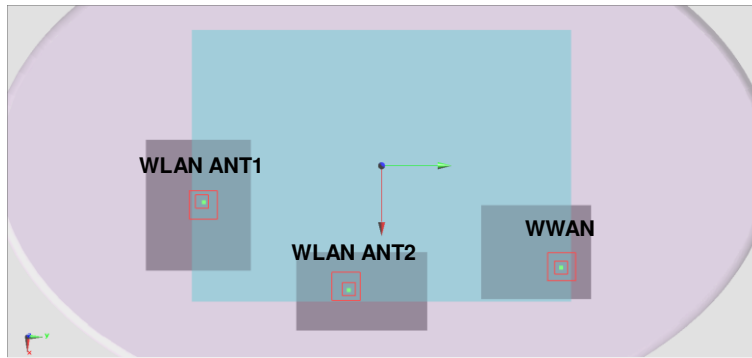

Case	Band	Position	SAR (W/kg)	Gap (cm)	SAR peak location (m)			3D distance (mm)	Summed SAR (W/kg)	SPLSR Results	Simultaneous SAR
					X	Y	Z				
34	LTE Band 13	Bottom Face	0.673	11mm	69.3	144.5	1.46	284.0	1.76	0.01	Not required
	5GHz ANT1		1.085	0mm	19	-135	3.44				
	LTE Band 13	Bottom Face	0.673	11mm	69.3	144.5	1.46	171.9	1.86	0.01	Not required
	5GHz ANT2		1.182	0mm	94	-25.6	3.13				
	5GHz ANT1	Bottom Face	1.085	0mm	19	-135	3.44	132.6	2.27	0.03	Not required
	5GHz ANT2		1.182	0mm	94	-25.6	3.13				

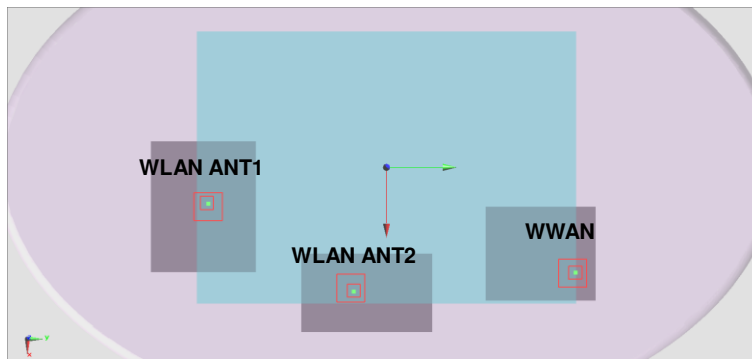

Case	Band	Position	SAR (W/kg)	Gap (cm)	SAR peak location (m)			3D distance (mm)	Summed SAR (W/kg)	SPLSR Results	Simultaneous SAR
					X	Y	Z				
35	LTE Band 25	Bottom Face	0.935	0mm	73.4	143.1	3.1	283.4	2.02	0.01	Not required
	5GHz ANT1		1.085	0mm	19	-135	3.44				
	LTE Band 25	Bottom Face	0.935	0mm	73.4	143.1	3.1	170.0	2.12	0.02	Not required
	5GHz ANT2		1.182	0mm	94	-25.6	3.13				
	5GHz ANT1	Bottom Face	1.085	0mm	19	-135	3.44	132.6	2.27	0.03	Not required
	5GHz ANT2		1.182	0mm	94	-25.6	3.13				

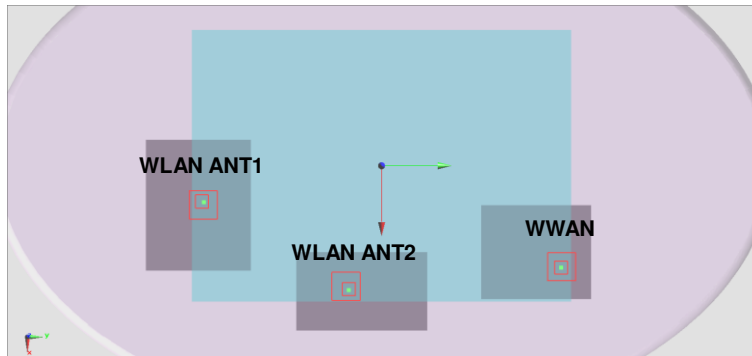

Case	Band	Position	SAR (W/kg)	Gap (cm)	SAR peak location (m)			3D distance (mm)	Summed SAR (W/kg)	SPLSR Results	Simultaneous SAR
					X	Y	Z				
36	LTE Band 25	Bottom Face	0.971	11mm	65.1	142.9	1.7	281.7	2.06	0.01	Not required
	5GHz ANT1		1.085	0mm	19	-135	3.44				
	LTE Band 25	Bottom Face	0.971	11mm	65.1	142.9	1.7	171.0	2.15	0.02	Not required
	5GHz ANT2		1.182	0mm	94	-25.6	3.13				
	5GHz ANT1	Bottom Face	1.085	0mm	19	-135	3.44	132.6	2.27	0.03	Not required
	5GHz ANT2		1.182	0mm	94	-25.6	3.13				

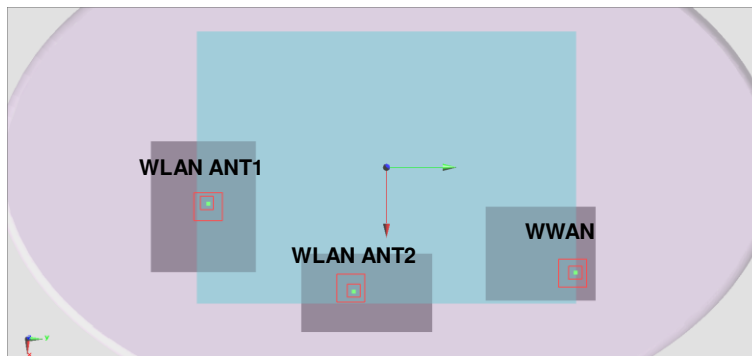

Case	Band	Position	SAR (W/kg)	Gap (cm)	SAR peak location (m)			3D distance (mm)	Summed SAR (W/kg)	SPLSR Results	Simultaneous SAR
					X	Y	Z				
37	LTE Band 26	Bottom Face	1.09	0mm	63.1	139.3	2.73	277.8	2.18	0.01	Not required
	5GHz ANT1		1.085	0mm	19	-135	3.44				
	LTE Band 26	Bottom Face	1.09	0mm	63.1	139.3	2.73	167.8	2.27	0.02	Not required
	5GHz ANT2		1.182	0mm	94	-25.6	3.13				
	5GHz ANT1	Bottom Face	1.085	0mm	19	-135	3.44	132.6	2.27	0.03	Not required
	5GHz ANT2		1.182	0mm	94	-25.6	3.13				

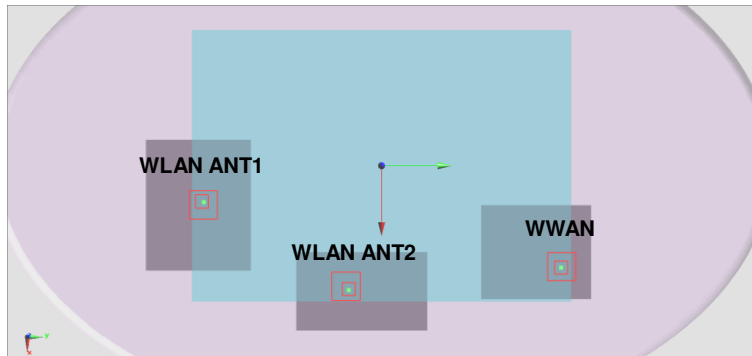

Case	Band	Position	SAR (W/kg)	Gap (cm)	SAR peak location (m)			3D distance (mm)	Summed SAR (W/kg)	SPLSR Results	Simultaneous SAR
					X	Y	Z				
38	LTE Band 26	Bottom Face	0.534	11mm	72.5	144.5	1.53	284.6	1.62	0.01	Not required
	5GHz ANT1		1.085	0mm	19	-135	3.44				
	LTE Band 26	Bottom Face	0.534	11mm	72.5	144.5	1.53	171.5	1.72	0.01	Not required
	5GHz ANT2		1.182	0mm	94	-25.6	3.13				
	5GHz ANT1	Bottom Face	1.085	0mm	19	-135	3.44	132.6	2.27	0.03	Not required
	5GHz ANT2		1.182	0mm	94	-25.6	3.13				

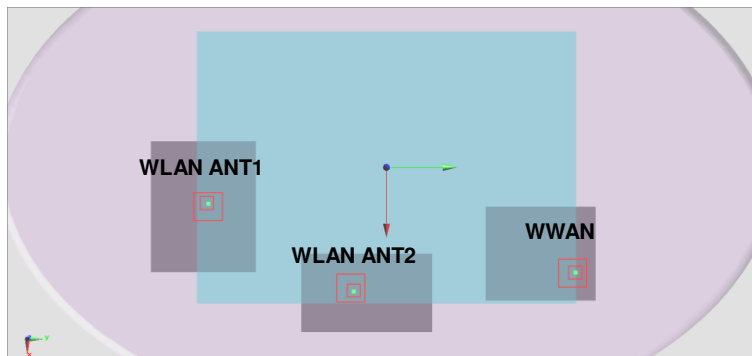

Case 39	Band	Position	SAR (W/kg)	Gap (cm)	SAR peak location (m)			3D distance (mm)	Summed SAR (W/kg)	SPLSR Results	Simultaneous SAR
					X	Y	Z				
LTE Band 41	5GHz ANT1	Bottom Face	1.267	0mm	79.8	137	3.24	278.7	2.35	0.01	Not required
			1.085	0mm	19	-135	3.44				
LTE Band 41	5GHz ANT2	Bottom Face	1.267	0mm	79.8	137	3.24	163.2	2.45	0.02	Not required
			1.182	0mm	94	-25.6	3.13				
5GHz ANT1	5GHz ANT2	Bottom Face	1.085	0mm	19	-135	3.44	132.6	2.27	0.03	Not required
			1.182	0mm	94	-25.6	3.13				

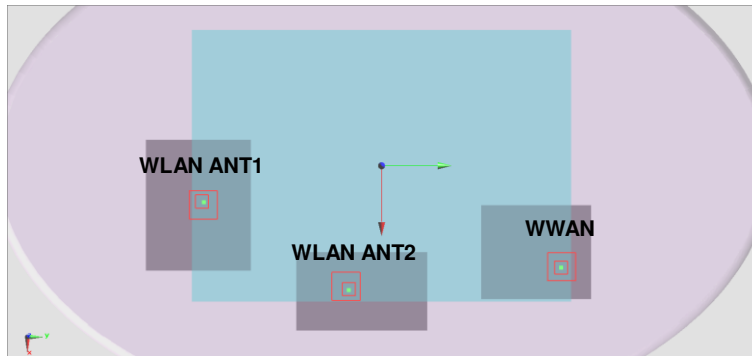

Case 40	Band	Position	SAR (W/kg)	Gap (cm)	SAR peak location (m)			3D distance (mm)	Summed SAR (W/kg)	SPLSR Results	Simultaneous SAR
					X	Y	Z				
LTE Band 41	5GHz ANT1	Bottom Face	0.414	11mm	78.6	138.6	2.05	280.0	1.50	0.01	Not required
			1.085	0mm	19	-135	3.44				
LTE Band 41	5GHz ANT2	Bottom Face	0.414	11mm	78.6	138.6	2.05	164.9	1.60	0.01	Not required
			1.182	0mm	94	-25.6	3.13				
5GHz ANT1	5GHz ANT2	Bottom Face	1.085	0mm	19	-135	3.44	132.6	2.27	0.03	Not required
			1.182	0mm	94	-25.6	3.13				

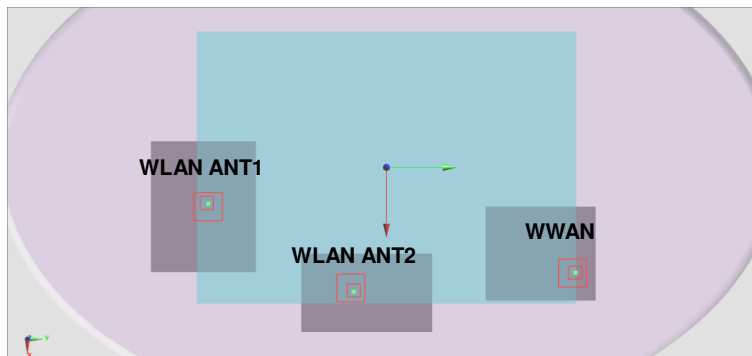

Case	Band	Position	SAR (W/kg)	Gap (cm)	SAR peak location (m)			3D distance (mm)	Summed SAR (W/kg)	SPLSR Results	Simultaneous SAR
					X	Y	Z				
41	WCDMA II	Bottom Face	0.75	0mm	75	141.5	3.44	285.8	1.73	0.01	Not required
	2.4GHz ANT1		0.982	0mm	20.2	-139	3.08				
	WCDMA II	Bottom Face	0.75	0mm	75	141.5	3.44	169.0	0.84	0.00	Not required
	Bluetooth		0.091	0mm	98.8	-25.8	2.77				
	2.4GHz ANT1	Bottom Face	0.982	0mm	20.2	-139	3.08	137.8	1.07	0.01	Not required
	Bluetooth		0.091	0mm	98.8	-25.8	2.77				

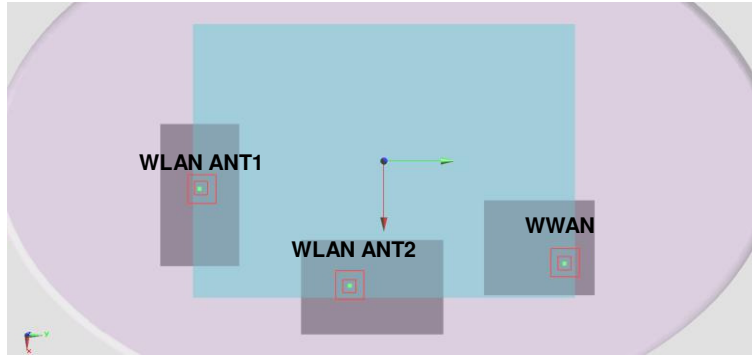

Case	Band	Position	SAR (W/kg)	Gap (cm)	SAR peak location (m)			3D distance (mm)	Summed SAR (W/kg)	SPLSR Results	Simultaneous SAR
					X	Y	Z				
42	WCDMA II	Bottom Face	1.019	11mm	74	143	2.09	287.1	2.00	0.01	Not required
	2.4GHz ANT1		0.982	0mm	20.2	-139	3.08				
	WCDMA II	Bottom Face	1.019	11mm	74	143	2.09	170.6	1.11	0.01	Not required
	Bluetooth		0.091	0mm	98.8	-25.8	2.77				
	2.4GHz ANT1	Bottom Face	0.982	0mm	20.2	-139	3.08	137.8	1.07	0.01	Not required
	Bluetooth		0.091	0mm	98.8	-25.8	2.77				

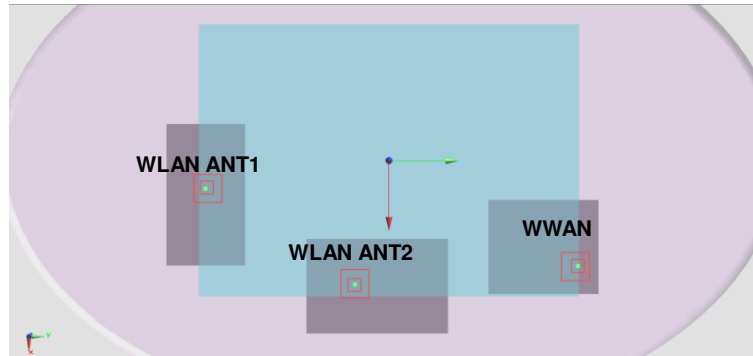

Case	Band	Position	SAR (W/kg)	Gap (cm)	SAR peak location (m)			3D distance (mm)	Summed SAR (W/kg)	SPLSR Results	Simultaneous SAR
					X	Y	Z				
43	WCDMA IV	Bottom Face	1.147	0mm	70.9	144.5	2.91	288.0	2.13	0.01	Not required
	2.4GHz ANT1		0.982	0mm	20.2	-139	3.08				
	WCDMA IV	Bottom Face	1.147	0mm	70.9	144.5	2.91	172.6	1.24	0.01	Not required
	Bluetooth		0.091	0mm	98.8	-25.8	2.77				
	2.4GHz ANT1	Bottom Face	0.982	0mm	20.2	-139	3.08	137.8	1.07	0.01	Not required
	Bluetooth		0.091	0mm	98.8	-25.8	2.77				

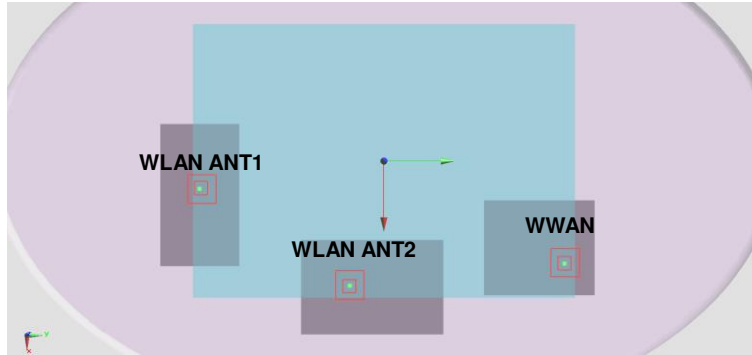

Case	Band	Position	SAR (W/kg)	Gap (cm)	SAR peak location (m)			3D distance (mm)	Summed SAR (W/kg)	SPLSR Results	Simultaneous SAR
					X	Y	Z				
44	WCDMA IV	Bottom Face	1.297	11mm	74	143	2.11	287.1	2.28	0.01	Not required
	2.4GHz ANT1		0.982	0mm	20.2	-139	3.08				
	WCDMA IV	Bottom Face	1.297	11mm	74	143	2.11	170.6	1.39	0.01	Not required
	Bluetooth		0.091	0mm	98.8	-25.8	2.77				
	2.4GHz ANT1	Bottom Face	0.982	0mm	20.2	-139	3.08	137.8	1.07	0.01	Not required
	Bluetooth		0.091	0mm	98.8	-25.8	2.77				

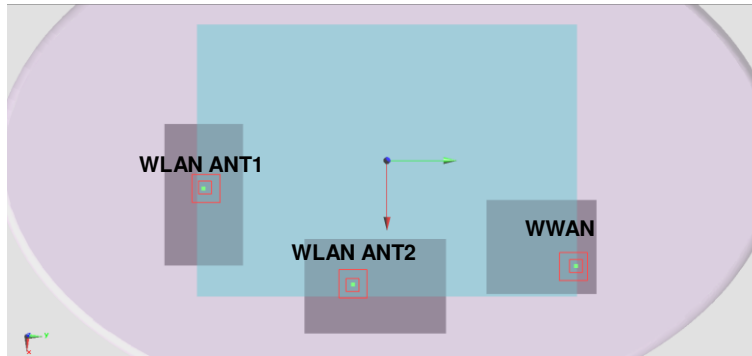

Case	Band	Position	SAR (W/kg)	Gap (cm)	SAR peak location (m)			3D distance (mm)	Summed SAR (W/kg)	SPLSR Results	Simultaneous SAR
					X	Y	Z				
45	WCDMA V	Bottom Face	1.188	0mm	62.5	138	2.8	280.2	2.17	0.01	Not required
	2.4GHz ANT1		0.982	0mm	20.2	-139	3.08				
	WCDMA V	Bottom Face	1.188	0mm	62.5	138	2.8	167.8	1.28	0.01	Not required
	Bluetooth		0.091	0mm	98.8	-25.8	2.77				
	2.4GHz ANT1	Bottom Face	0.982	0mm	20.2	-139	3.08	137.8	1.07	0.01	Not required
	Bluetooth		0.091	0mm	98.8	-25.8	2.77				

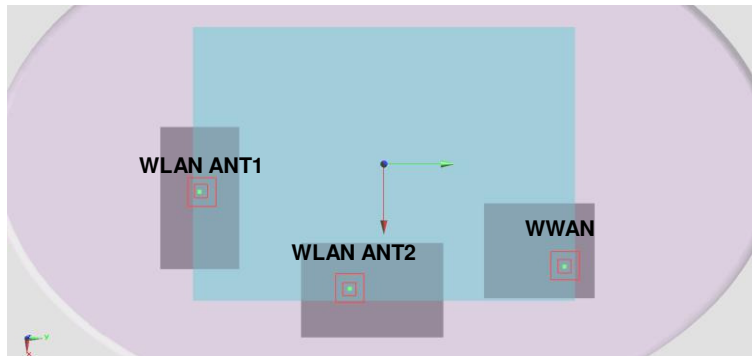

Case	Band	Position	SAR (W/kg)	Gap (cm)	SAR peak location (m)			3D distance (mm)	Summed SAR (W/kg)	SPLSR Results	Simultaneous SAR
					X	Y	Z				
46	LTE Band 4	Bottom Face	1.227	0mm	70.9	142.9	2.92	286.4	2.21	0.01	Not required
	2.4GHz ANT1		0.982	0mm	20.2	-139	3.08				
	LTE Band 4	Bottom Face	1.227	0mm	70.9	142.9	2.92	171.0	1.32	0.01	Not required
	Bluetooth		0.091	0mm	98.8	-25.8	2.77				
	2.4GHz ANT1	Bottom Face	0.982	0mm	20.2	-139	3.08	137.8	1.07	0.01	Not required
	Bluetooth		0.091	0mm	98.8	-25.8	2.77				

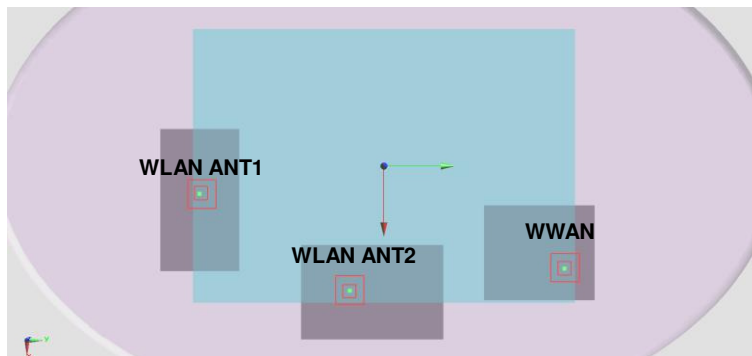

Case 47	Band	Position	SAR (W/kg)	Gap (cm)	SAR peak location (m)			3D distance (mm)	Summed SAR (W/kg)	SPLSR Results	Simultaneous SAR
					X	Y	Z				
Case 47	LTE Band 4	Bottom Face	1.21	11mm	68.1	142.5	1.76	285.5	2.19	0.01	Not required
	2.4GHz ANT1		0.982	0mm	20.2	-139	3.08				
	LTE Band 4	Bottom Face	1.21	11mm	68.1	142.5	1.76	171.1	1.30	0.01	Not required
	Bluetooth		0.091	0mm	98.8	-25.8	2.77				
	2.4GHz ANT1	Bottom Face	0.982	0mm	20.2	-139	3.08	137.8	1.07	0.01	Not required
	Bluetooth		0.091	0mm	98.8	-25.8	2.77				

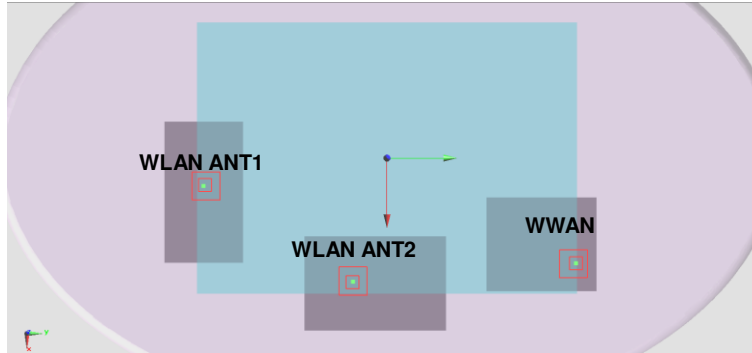

Case 48	Band	Position	SAR (W/kg)	Gap (cm)	SAR peak location (m)			3D distance (mm)	Summed SAR (W/kg)	SPLSR Results	Simultaneous SAR
					X	Y	Z				
Case 48	LTE Band 7	Bottom Face	1.263	0mm	77	136.2	3.32	281.0	2.25	0.01	Not required
	2.4GHz ANT1		0.982	0mm	20.2	-139	3.08				
	LTE Band 7	Bottom Face	1.263	0mm	77	136.2	3.32	163.5	1.35	0.01	Not required
	Bluetooth		0.091	0mm	98.8	-25.8	2.77				
	2.4GHz ANT1	Bottom Face	0.982	0mm	20.2	-139	3.08	137.8	1.07	0.01	Not required
	Bluetooth		0.091	0mm	98.8	-25.8	2.77				

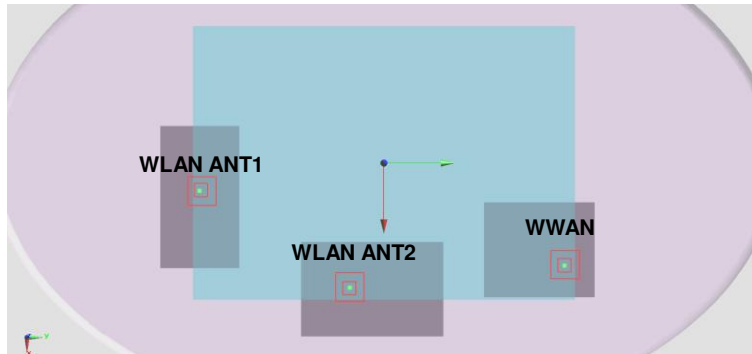

Case 49	Band	Position	SAR (W/kg)	Gap (cm)	SAR peak location (m)			3D distance (mm)	Summed SAR (W/kg)	SPLSR Results	Simultaneous SAR
					X	Y	Z				
LTE Band 12	2.4GHz ANT1	Bottom Face	1.017	0mm	52.6	141.4	2.37	282.3	2.00	0.01	Not required
			0.982	0mm	20.2	-139	3.08				
LTE Band 12	Bluetooth	Bottom Face	1.017	0mm	52.6	141.4	2.37	173.5	1.11	0.01	Not required
			0.091	0mm	98.8	-25.8	2.77				
2.4GHz ANT1	Bluetooth	Bottom Face	0.982	0mm	20.2	-139	3.08	137.8	1.07	0.01	Not required
			0.091	0mm	98.8	-25.8	2.77				

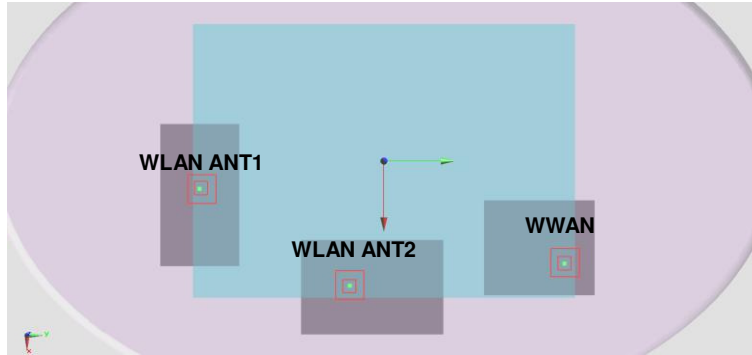

Case 50	Band	Position	SAR (W/kg)	Gap (cm)	SAR peak location (m)			3D distance (mm)	Summed SAR (W/kg)	SPLSR Results	Simultaneous SAR
					X	Y	Z				
LTE Band 13	2.4GHz ANT1	Bottom Face	1.23	0mm	70	143	2.67	286.4	2.21	0.01	Not required
			0.982	0mm	20.2	-139	3.08				
LTE Band 13	Bluetooth	Bottom Face	1.23	0mm	70	143	2.67	171.2	1.32	0.01	Not required
			0.091	0mm	98.8	-25.8	2.77				
2.4GHz ANT1	Bluetooth	Bottom Face	0.982	0mm	20.2	-139	3.08	137.8	1.07	0.01	Not required
			0.091	0mm	98.8	-25.8	2.77				

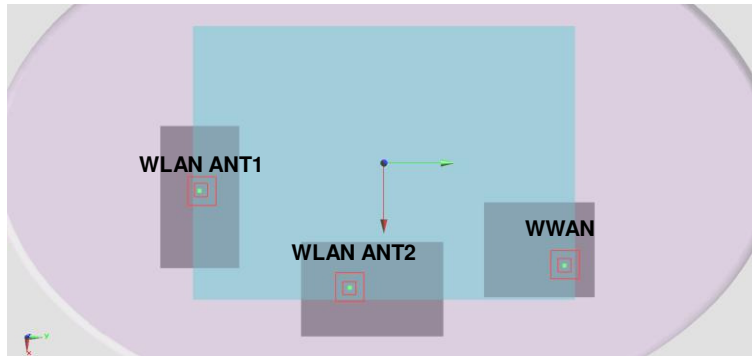

Case 51	Band	Position	SAR (W/kg)	Gap (cm)	SAR peak location (m)			3D distance (mm)	Summed SAR (W/kg)	SPLSR Results	Simultaneous SAR
					X	Y	Z				
Case 51	LTE Band 13	Bottom Face	0.673	11mm	69.3	144.5	1.46	287.7	1.66	0.01	Not required
	2.4GHz ANT1		0.982	0mm	20.2	-139	3.08				
	LTE Band 13	Bottom Face	0.673	11mm	69.3	144.5	1.46	172.8	0.76	0.00	Not required
	Bluetooth		0.091	0mm	98.8	-25.8	2.77				
	2.4GHz ANT1	Bottom Face	0.982	0mm	20.2	-139	3.08	137.8	1.07	0.01	Not required
	Bluetooth		0.091	0mm	98.8	-25.8	2.77				

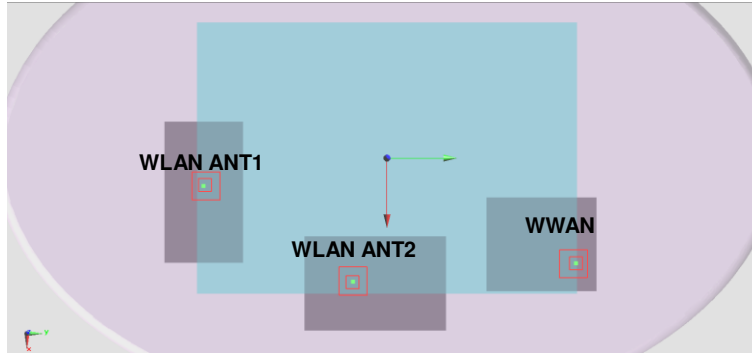

Case 52	Band	Position	SAR (W/kg)	Gap (cm)	SAR peak location (m)			3D distance (mm)	Summed SAR (W/kg)	SPLSR Results	Simultaneous SAR
					X	Y	Z				
Case 52	LTE Band 25	Bottom Face	0.935	0mm	73.4	143.1	3.1	287.1	1.92	0.01	Not required
	2.4GHz ANT1		0.982	0mm	20.2	-139	3.08				
	LTE Band 25	Bottom Face	0.935	0mm	73.4	143.1	3.1	170.8	1.03	0.01	Not required
	Bluetooth		0.091	0mm	98.8	-25.8	2.77				
	2.4GHz ANT1	Bottom Face	0.982	0mm	20.2	-139	3.08	137.8	1.07	0.01	Not required
	Bluetooth		0.091	0mm	98.8	-25.8	2.77				

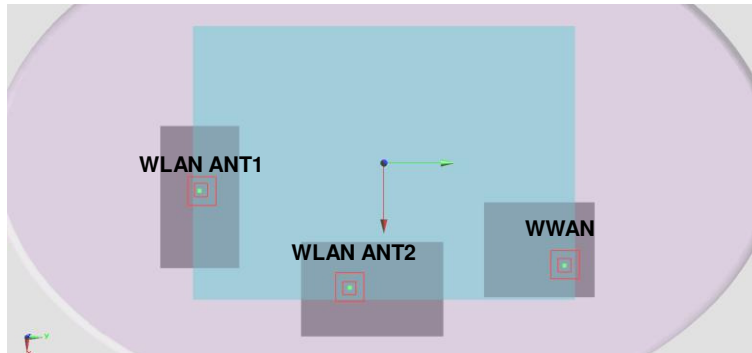

Case	Band	Position	SAR (W/kg)	Gap (cm)	SAR peak location (m)			3D distance (mm)	Summed SAR (W/kg)	SPLSR Results	Simultaneous SAR
					X	Y	Z				
53	LTE Band 25	Bottom Face	0.971	11mm	65.1	142.9	1.7	285.5	1.95	0.01	Not required
	2.4GHz ANT1		0.982	0mm	20.2	-139	3.08				
	LTE Band 25	Bottom Face	0.971	11mm	65.1	142.9	1.7	172.0	1.06	0.01	Not required
	Bluetooth		0.091	0mm	98.8	-25.8	2.77				
	2.4GHz ANT1	Bottom Face	0.982	0mm	20.2	-139	3.08	137.8	1.07	0.01	Not required
	Bluetooth		0.091	0mm	98.8	-25.8	2.77				

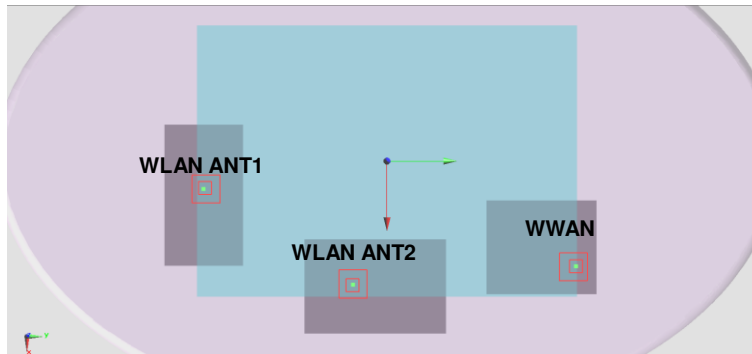

Case	Band	Position	SAR (W/kg)	Gap (cm)	SAR peak location (m)			3D distance (mm)	Summed SAR (W/kg)	SPLSR Results	Simultaneous SAR
					X	Y	Z				
54	LTE Band 26	Bottom Face	1.09	0mm	63.1	139.3	2.73	281.6	2.07	0.01	Not required
	2.4GHz ANT1		0.982	0mm	20.2	-139	3.08				
	LTE Band 26	Bottom Face	1.09	0mm	63.1	139.3	2.73	168.9	1.18	0.01	Not required
	Bluetooth		0.091	0mm	98.8	-25.8	2.77				
	2.4GHz ANT1	Bottom Face	0.982	0mm	20.2	-139	3.08	137.8	1.07	0.01	Not required
	Bluetooth		0.091	0mm	98.8	-25.8	2.77				

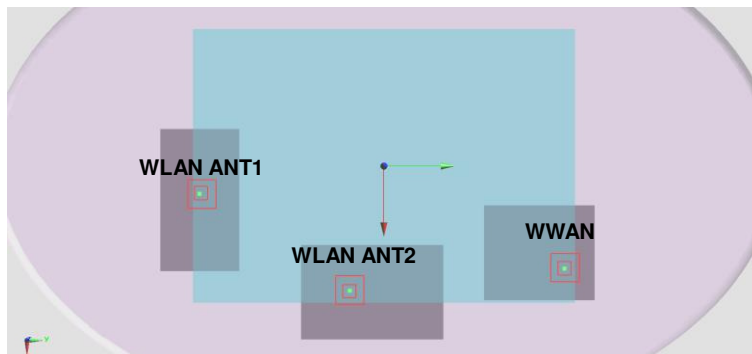

Case	Band	Position	SAR (W/kg)	Gap (cm)	SAR peak location (m)			3D distance (mm)	Summed SAR (W/kg)	SPLSR Results	Simultaneous SAR
					X	Y	Z				
55	LTE Band 26	Bottom Face	0.534	11mm	72.5	144.5	1.53	288.3	1.52	0.01	Not required
	2.4GHz ANT1		0.982	0mm	20.2	-139	3.08				
	LTE Band 26	Bottom Face	0.534	11mm	72.5	144.5	1.53	172.3	0.63	0.00	Not required
	Bluetooth		0.091	0mm	98.8	-25.8	2.77				
	2.4GHz ANT1	Bottom Face	0.982	0mm	20.2	-139	3.08	137.8	1.07	0.01	Not required
	Bluetooth		0.091	0mm	98.8	-25.8	2.77				

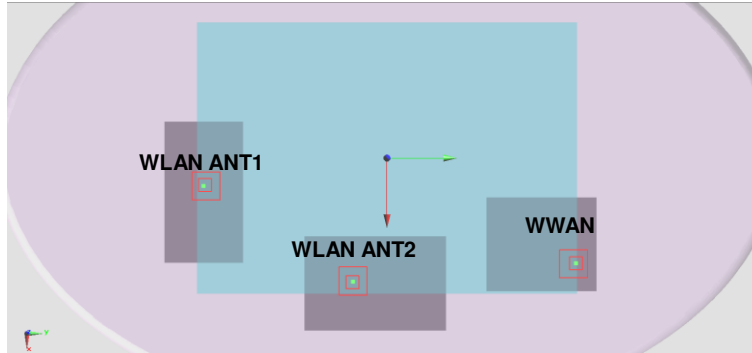

Case	Band	Position	SAR (W/kg)	Gap (cm)	SAR peak location (m)			3D distance (mm)	Summed SAR (W/kg)	SPLSR Results	Simultaneous SAR
					X	Y	Z				
56	LTE Band 41	Bottom Face	1.267	0mm	79.8	137	3.24	282.4	2.25	0.01	Not required
	2.4GHz ANT1		0.982	0mm	20.2	-139	3.08				
	LTE Band 41	Bottom Face	1.267	0mm	79.8	137	3.24	163.9	1.36	0.01	Not required
	Bluetooth		0.091	0mm	98.8	-25.8	2.77				
	2.4GHz ANT1	Bottom Face	0.982	0mm	20.2	-139	3.08	137.8	1.07	0.01	Not required
	Bluetooth		0.091	0mm	98.8	-25.8	2.77				

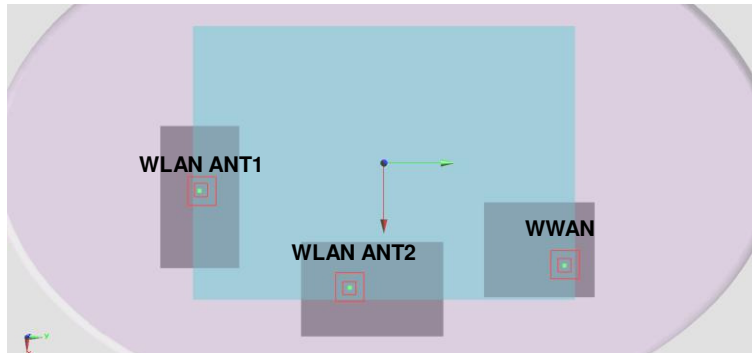

Case	Band	Position	SAR (W/kg)	Gap (cm)	SAR peak location (m)			3D distance (mm)	Summed SAR (W/kg)	SPLSR Results	Simultaneous SAR
					X	Y	Z				
57	WCDMA II	Bottom Face	0.75	0mm	75	141.5	3.44	282.1	1.84	0.01	Not required
	5GHz ANT1		1.085	0mm	19	-135	3.44				
	WCDMA II	Bottom Face	0.75	0mm	75	141.5	3.44	169.0	0.84	0.00	Not required
	Bluetooth		0.091	0mm	98.8	-25.8	2.77				
	5GHz ANT1	Bottom Face	1.085	0mm	19	-135	3.44	135.3	1.18	0.01	Not required
	Bluetooth		0.091	0mm	98.8	-25.8	2.77				

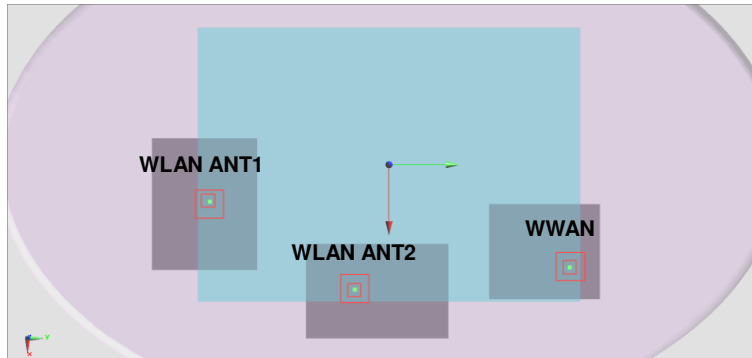

Case	Band	Position	SAR (W/kg)	Gap (cm)	SAR peak location (m)			3D distance (mm)	Summed SAR (W/kg)	SPLSR Results	Simultaneous SAR
					X	Y	Z				
58	WCDMA II	Bottom Face	1.019	11mm	74	143	2.09	283.4	2.10	0.01	Not required
	5GHz ANT1		1.085	0mm	19	-135	3.44				
	WCDMA II	Bottom Face	1.019	11mm	74	143	2.09	170.6	1.11	0.01	Not required
	Bluetooth		0.091	0mm	98.8	-25.8	2.77				
	5GHz ANT1	Bottom Face	1.085	0mm	19	-135	3.44	135.3	1.18	0.01	Not required
	Bluetooth		0.091	0mm	98.8	-25.8	2.77				

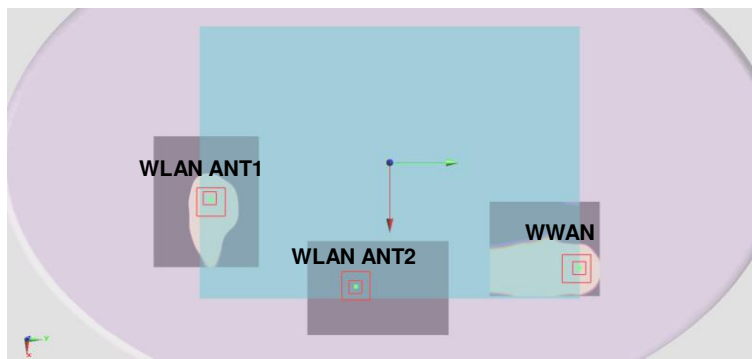

Case 59	Band	Position	SAR (W/kg)	Gap (cm)	SAR peak location (m)			3D distance (mm)	Summed SAR (W/kg)	SPLSR Results	Simultaneous SAR
					X	Y	Z				
WCDMA IV	5GHz ANT1	Bottom Face	1.147	0mm	70.9	144.5	2.91	284.3	2.23	0.01	Not required
			1.085	0mm	19	-135	3.44				
WCDMA IV	Bluetooth	Bottom Face	1.147	0mm	70.9	144.5	2.91	172.6	1.24	0.01	Not required
			0.091	0mm	98.8	-25.8	2.77				
5GHz ANT1	Bluetooth	Bottom Face	1.085	0mm	19	-135	3.44	135.3	1.18	0.01	Not required
			0.091	0mm	98.8	-25.8	2.77				

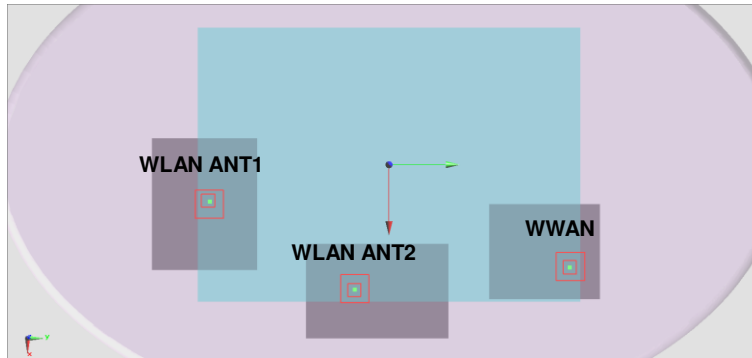

Case 60	Band	Position	SAR (W/kg)	Gap (cm)	SAR peak location (m)			3D distance (mm)	Summed SAR (W/kg)	SPLSR Results	Simultaneous SAR
					X	Y	Z				
WCDMA IV	5GHz ANT1	Bottom Face	1.297	11mm	74	143	2.11	283.4	2.38	0.01	Not required
			1.085	0mm	19	-135	3.44				
WCDMA IV	Bluetooth	Bottom Face	1.297	11mm	74	143	2.11	170.6	1.39	0.01	Not required
			0.091	0mm	98.8	-25.8	2.77				
5GHz ANT1	Bluetooth	Bottom Face	1.085	0mm	19	-135	3.44	135.3	1.18	0.01	Not required
			0.091	0mm	98.8	-25.8	2.77				

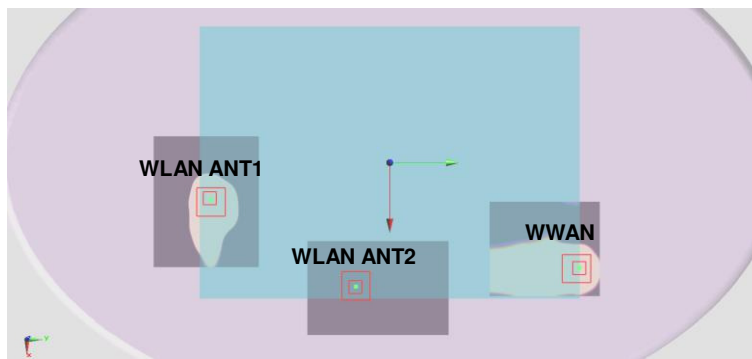

Case	Band	Position	SAR (W/kg)	Gap (cm)	SAR peak location (m)			3D distance (mm)	Summed SAR (W/kg)	SPLSR Results	Simultaneous SAR
					X	Y	Z				
61	WCDMA V	Bottom Face	1.188	0mm	62.5	138	2.8	276.4	2.27	0.01	Not required
	5GHz ANT1		1.085	0mm	19	-135	3.44				
	WCDMA V	Bottom Face	1.188	0mm	62.5	138	2.8	167.8	1.28	0.01	Not required
	Bluetooth		0.091	0mm	98.8	-25.8	2.77				
	5GHz ANT1	Bottom Face	1.085	0mm	19	-135	3.44	135.3	1.18	0.01	Not required
	Bluetooth		0.091	0mm	98.8	-25.8	2.77				

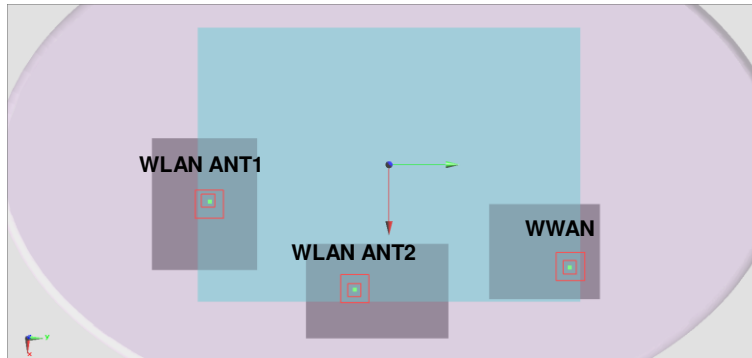

Case	Band	Position	SAR (W/kg)	Gap (cm)	SAR peak location (m)			3D distance (mm)	Summed SAR (W/kg)	SPLSR Results	Simultaneous SAR
					X	Y	Z				
62	WCDMA V	Bottom Face	0.503	11mm	72.5	143	1.52	283.1	1.59	0.01	Not required
	5GHz ANT1		1.085	0mm	19	-135	3.44				
	WCDMA V	Bottom Face	0.503	11mm	72.5	143	1.52	170.8	0.59	0.00	Not required
	Bluetooth		0.091	0mm	98.8	-25.8	2.77				
	5GHz ANT1	Bottom Face	1.085	0mm	19	-135	3.44	135.3	1.18	0.01	Not required
	Bluetooth		0.091	0mm	98.8	-25.8	2.77				

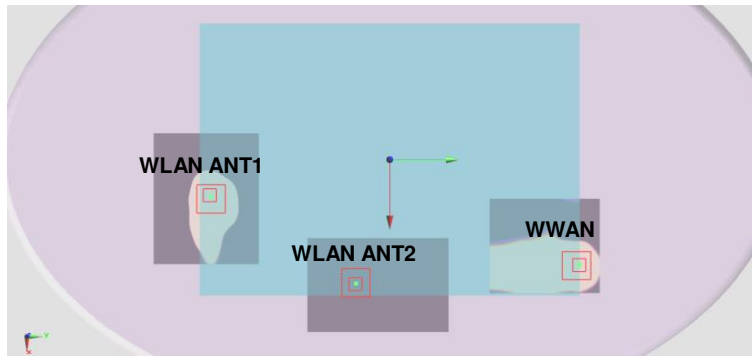

Case	Band	Position	SAR (W/kg)	Gap (cm)	SAR peak location (m)			3D distance (mm)	Summed SAR (W/kg)	SPLSR Results	Simultaneous SAR
					X	Y	Z				
63	LTE Band 4	Bottom Face	1.227	0mm	70.9	142.9	2.92	282.7	2.31	0.01	Not required
	5GHz ANT1		1.085	0mm	19	-135	3.44				
	LTE Band 4	Bottom Face	1.227	0mm	70.9	142.9	2.92	171.0	1.32	0.01	Not required
	Bluetooth		0.091	0mm	98.8	-25.8	2.77				
	5GHz ANT1	Bottom Face	1.085	0mm	19	-135	3.44	135.3	1.18	0.01	Not required
	Bluetooth		0.091	0mm	98.8	-25.8	2.77				

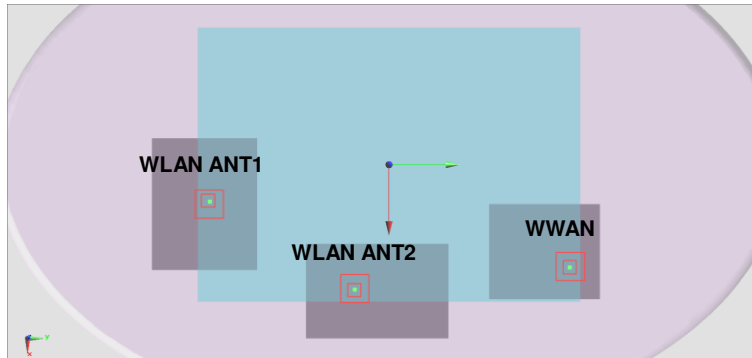

Case	Band	Position	SAR (W/kg)	Gap (cm)	SAR peak location (m)			3D distance (mm)	Summed SAR (W/kg)	SPLSR Results	Simultaneous SAR
					X	Y	Z				
64	LTE Band 4	Bottom Face	1.21	11mm	68.1	142.5	1.76	281.8	2.30	0.01	Not required
	5GHz ANT1		1.085	0mm	19	-135	3.44				
	LTE Band 4	Bottom Face	1.21	11mm	68.1	142.5	1.76	171.1	1.30	0.01	Not required
	Bluetooth		0.091	0mm	98.8	-25.8	2.77				
	5GHz ANT1	Bottom Face	1.085	0mm	19	-135	3.44	135.3	1.18	0.01	Not required
	Bluetooth		0.091	0mm	98.8	-25.8	2.77				

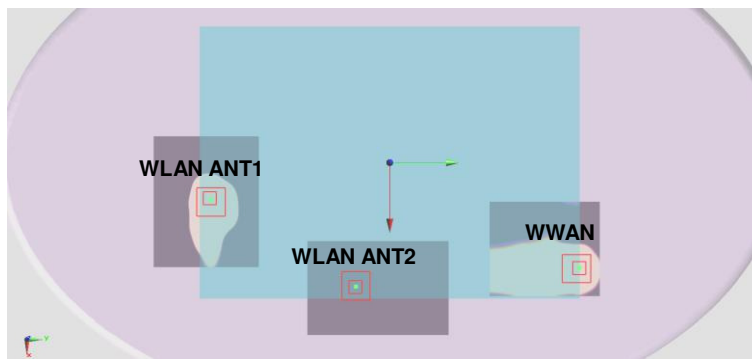

Case	Band	Position	SAR (W/kg)	Gap (cm)	SAR peak location (m)			3D distance (mm)	Summed SAR (W/kg)	SPLSR Results	Simultaneous SAR
					X	Y	Z				
65	LTE Band 7	Bottom Face	1.263	0mm	77	136.2	3.32	277.3	2.35	0.01	Not required
	5GHz ANT1		1.085	0mm	19	-135	3.44				
	LTE Band 7	Bottom Face	1.263	0mm	77	136.2	3.32	163.5	1.35	0.01	Not required
	Bluetooth		0.091	0mm	98.8	-25.8	2.77				
	5GHz ANT1	Bottom Face	1.085	0mm	19	-135	3.44	135.3	1.18	0.01	Not required
	Bluetooth		0.091	0mm	98.8	-25.8	2.77				

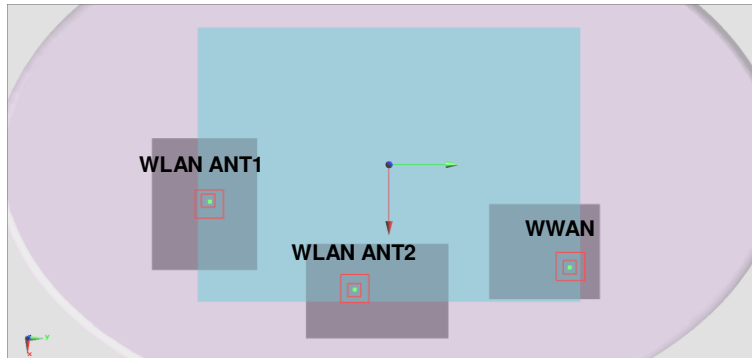

Case	Band	Position	SAR (W/kg)	Gap (cm)	SAR peak location (m)			3D distance (mm)	Summed SAR (W/kg)	SPLSR Results	Simultaneous SAR
					X	Y	Z				
66	LTE Band 12	Bottom Face	1.017	0mm	52.6	141.4	2.37	278.4	2.10	0.01	Not required
	5GHz ANT1		1.085	0mm	19	-135	3.44				
	LTE Band 12	Bottom Face	1.017	0mm	52.6	141.4	2.37	173.5	1.11	0.01	Not required
	Bluetooth		0.091	0mm	98.8	-25.8	2.77				
	5GHz ANT1	Bottom Face	1.085	0mm	19	-135	3.44	135.3	1.18	0.01	Not required
	Bluetooth		0.091	0mm	98.8	-25.8	2.77				

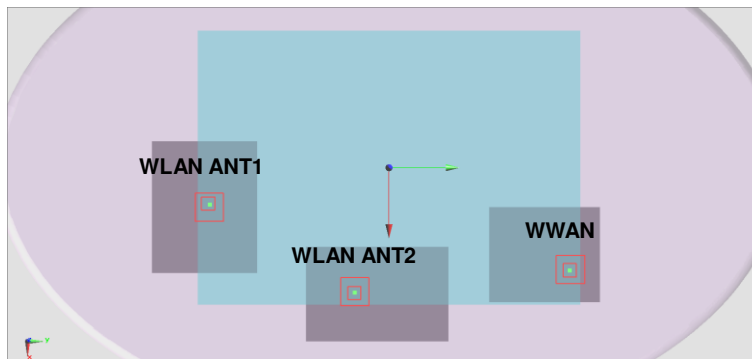

Case	Band	Position	SAR (W/kg)	Gap (cm)	SAR peak location (m)			3D distance (mm)	Summed SAR (W/kg)	SPLSR Results	Simultaneous SAR
					X	Y	Z				
67	LTE Band 12	Bottom Face	0.494	11mm	69.7	148.9	1.48	288.4	1.58	0.01	Not required
	5GHz ANT1		1.085	0mm	19	-135	3.44				
	LTE Band 12	Bottom Face	0.494	11mm	69.7	148.9	1.48	177.1	0.59	0.00	Not required
	Bluetooth		0.091	0mm	98.8	-25.8	2.77				
	5GHz ANT1	Bottom Face	1.085	0mm	19	-135	3.44	135.3	1.18	0.01	Not required
	Bluetooth		0.091	0mm	98.8	-25.8	2.77				

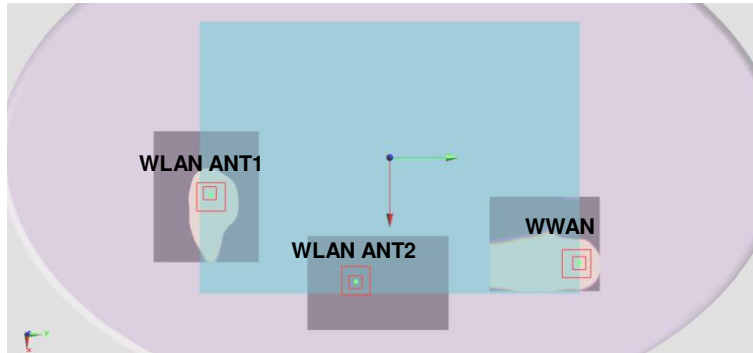

Case	Band	Position	SAR (W/kg)	Gap (cm)	SAR peak location (m)			3D distance (mm)	Summed SAR (W/kg)	SPLSR Results	Simultaneous SAR
					X	Y	Z				
68	LTE Band 13	Bottom Face	1.23	0mm	70	143	2.67	282.6	2.32	0.01	Not required
	5GHz ANT1		1.085	0mm	19	-135	3.44				
	LTE Band 13	Bottom Face	1.23	0mm	70	143	2.67	171.2	1.32	0.01	Not required
	Bluetooth		0.091	0mm	98.8	-25.8	2.77				
	5GHz ANT1	Bottom Face	1.085	0mm	19	-135	3.44	135.3	1.18	0.01	Not required
	Bluetooth		0.091	0mm	98.8	-25.8	2.77				

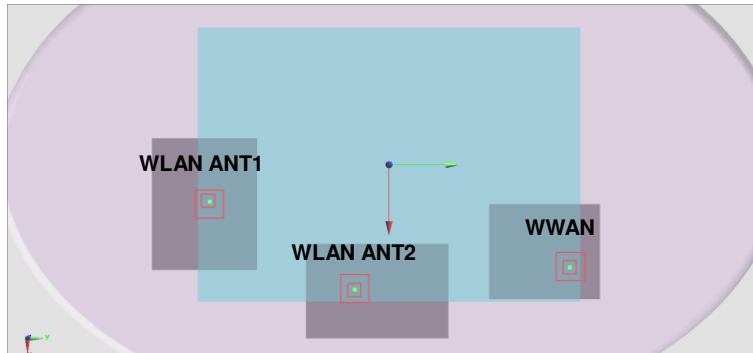

Case	Band	Position	SAR (W/kg)	Gap (cm)	SAR peak location (m)			3D distance (mm)	Summed SAR (W/kg)	SPLSR Results	Simultaneous SAR
					X	Y	Z				
69	LTE Band 13	Bottom Face	0.673	11mm	69.3	144.5	1.46	284.0	1.76	0.01	Not required
	5GHz ANT1		1.085	0mm	19	-135	3.44				
	LTE Band 13	Bottom Face	0.673	11mm	69.3	144.5	1.46	172.8	0.76	0.00	Not required
	Bluetooth		0.091	0mm	98.8	-25.8	2.77				
	5GHz ANT1	Bottom Face	1.085	0mm	19	-135	3.44	135.3	1.18	0.01	Not required
	Bluetooth		0.091	0mm	98.8	-25.8	2.77				

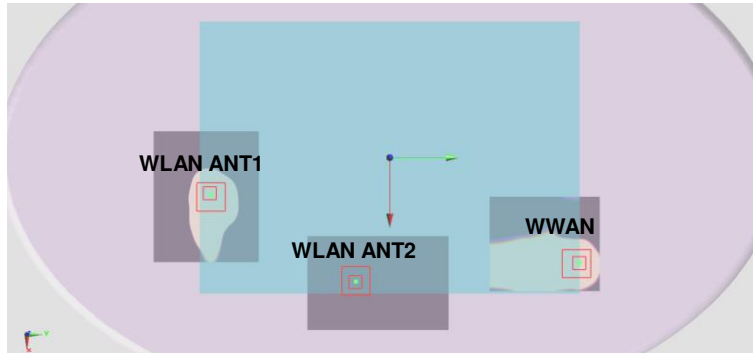

Case	Band	Position	SAR (W/kg)	Gap (cm)	SAR peak location (m)			3D distance (mm)	Summed SAR (W/kg)	SPLSR Results	Simultaneous SAR
					X	Y	Z				
70	LTE Band 25	Bottom Face	0.935	0mm	73.4	143.1	3.1	283.4	2.02	0.01	Not required
	5GHz ANT1		1.085	0mm	19	-135	3.44				
	LTE Band 25	Bottom Face	0.935	0mm	73.4	143.1	3.1	170.8	1.03	0.01	Not required
	Bluetooth		0.091	0mm	98.8	-25.8	2.77				
	5GHz ANT1	Bottom Face	1.085	0mm	19	-135	3.44	135.3	1.18	0.01	Not required
	Bluetooth		0.091	0mm	98.8	-25.8	2.77				

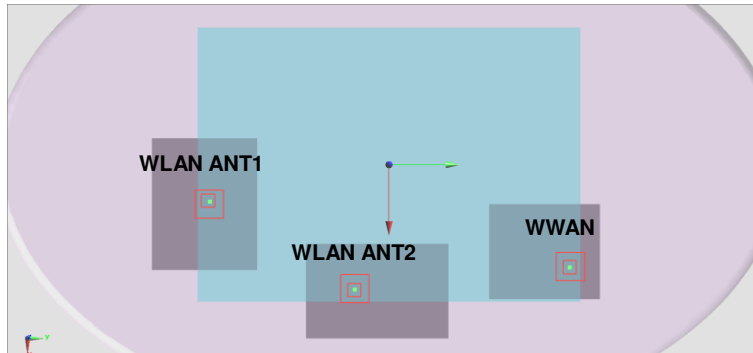

Case	Band	Position	SAR (W/kg)	Gap (cm)	SAR peak location (m)			3D distance (mm)	Summed SAR (W/kg)	SPLSR Results	Simultaneous SAR
					X	Y	Z				
71	LTE Band 25	Bottom Face	0.971	11mm	65.1	142.9	1.7	281.7	2.06	0.01	Not required
	5GHz ANT1		1.085	0mm	19	-135	3.44				
	LTE Band 25	Bottom Face	0.971	11mm	65.1	142.9	1.7	172.0	1.06	0.01	Not required
	Bluetooth		0.091	0mm	98.8	-25.8	2.77				
	5GHz ANT1	Bottom Face	1.085	0mm	19	-135	3.44	135.3	1.18	0.01	Not required
	Bluetooth		0.091	0mm	98.8	-25.8	2.77				

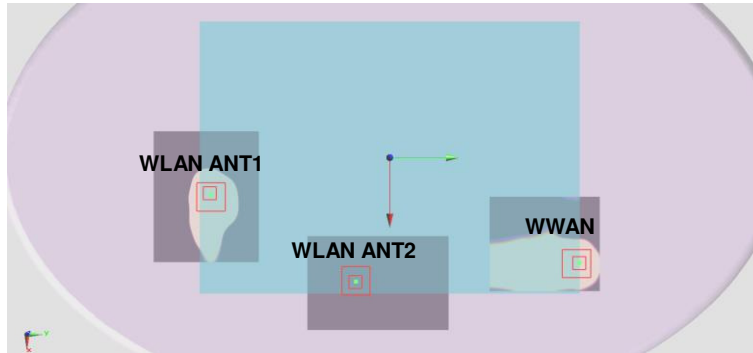

Case	Band	Position	SAR (W/kg)	Gap (cm)	SAR peak location (m)			3D distance (mm)	Summed SAR (W/kg)	SPLSR Results	Simultaneous SAR
					X	Y	Z				
72	LTE Band 26	Bottom Face	1.09	0mm	63.1	139.3	2.73	277.8	2.18	0.01	Not required
	5GHz ANT1		1.085	0mm	19	-135	3.44				
	LTE Band 26	Bottom Face	1.09	0mm	63.1	139.3	2.73	168.9	1.18	0.01	Not required
	Bluetooth		0.091	0mm	98.8	-25.8	2.77				
	5GHz ANT1	Bottom Face	1.085	0mm	19	-135	3.44	135.3	1.18	0.01	Not required
	Bluetooth		0.091	0mm	98.8	-25.8	2.77				

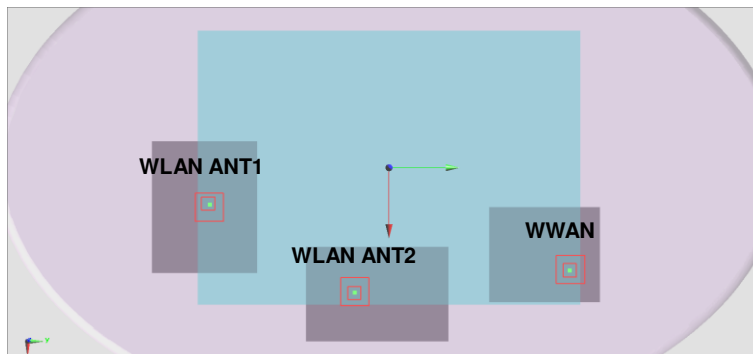

Case	Band	Position	SAR (W/kg)	Gap (cm)	SAR peak location (m)			3D distance (mm)	Summed SAR (W/kg)	SPLSR Results	Simultaneous SAR
					X	Y	Z				
73	LTE Band 26	Bottom Face	0.534	11mm	72.5	144.5	1.53	284.6	1.62	0.01	Not required
	5GHz ANT1		1.085	0mm	19	-135	3.44				
	LTE Band 26	Bottom Face	0.534	11mm	72.5	144.5	1.53	172.3	0.63	0.00	Not required
	Bluetooth		0.091	0mm	98.8	-25.8	2.77				
	5GHz ANT1	Bottom Face	1.085	0mm	19	-135	3.44	135.3	1.18	0.01	Not required
	Bluetooth		0.091	0mm	98.8	-25.8	2.77				

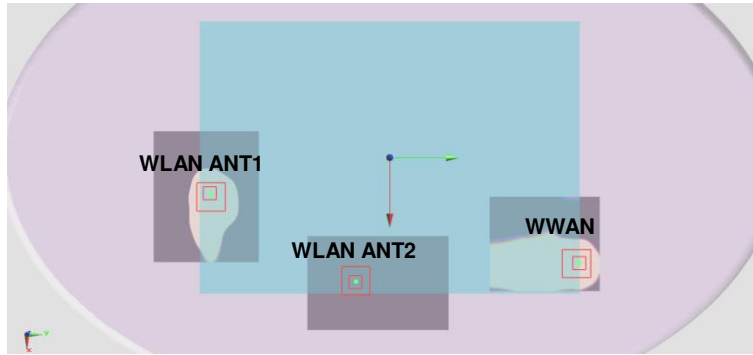

Case	Band	Position	SAR (W/kg)	Gap (cm)	SAR peak location (m)			3D distance (mm)	Summed SAR (W/kg)	SPLSR Results	Simultaneous SAR
					X	Y	Z				
74	LTE Band 41	Bottom Face	1.267	0mm	79.8	137	3.24	278.7	2.35	0.01	Not required
	5GHz ANT1		1.085	0mm	19	-135	3.44				
	LTE Band 41	Bottom Face	1.267	0mm	79.8	137	3.24	163.9	1.36	0.01	Not required
	Bluetooth		0.091	0mm	98.8	-25.8	2.77				
	5GHz ANT1	Bottom Face	1.085	0mm	19	-135	3.44	135.3	1.18	0.01	Not required
	Bluetooth		0.091	0mm	98.8	-25.8	2.77				

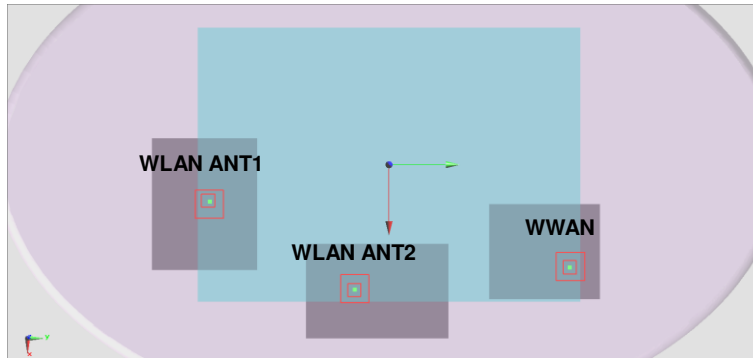

Test Engineer : Ken Li and Ken Li

16. Uncertainty Assessment

The component of uncertainty may generally be categorized according to the methods used to evaluate them. The evaluation of uncertainty by the statistical analysis of a series of observations is termed a Type A evaluation of uncertainty. The evaluation of uncertainty by means other than the statistical analysis of a series of observation is termed a Type B evaluation of uncertainty. Each component of uncertainty, however evaluated, is represented by an estimated standard deviation, termed standard uncertainty, which is determined by the positive square root of the estimated variance.

A Type A evaluation of standard uncertainty may be based on any valid statistical method for treating data. This includes calculating the standard deviation of the mean of a series of independent observations; using the method of least squares to fit a curve to the data in order to estimate the parameter of the curve and their standard deviations; or carrying out an analysis of variance in order to identify and quantify random effects in certain kinds of measurement.

A type B evaluation of standard uncertainty is typically based on scientific judgment using all of the relevant information available. These may include previous measurement data, experience, and knowledge of the behavior and properties of relevant materials and instruments, manufacture’s specification, data provided in calibration reports and uncertainties assigned to reference data taken from handbooks. Broadly speaking, the uncertainty is either obtained from an outdoor source or obtained from an assumed distribution, such as the normal distribution, rectangular or triangular distributions indicated in table below.

Uncertainty Distributions	Normal	Rectangular	Triangular	U-Shape
Multi-plying Factor ^(a)	1/k ^(b)	1/√3	1/√6	1/√2

(a) standard uncertainty is determined as the product of the multiplying factor and the estimated range of variations in the measured quantity

(b) κ is the coverage factor

Table 16.1. Standard Uncertainty for Assumed Distribution

The combined standard uncertainty of the measurement result represents the estimated standard deviation of the result. It is obtained by combining the individual standard uncertainties of both Type A and Type B evaluation using the usual “root-sum-squares” (RSS) methods of combining standard deviations by taking the positive square root of the estimated variances.

Expanded uncertainty is a measure of uncertainty that defines an interval about the measurement result within which the measured value is confidently believed to lie. It is obtained by multiplying the combined standard uncertainty by a coverage factor. Typically, the coverage factor ranges from 2 to 3. Using a coverage factor allows the true value of a measured quantity to be specified with a defined probability within the specified uncertainty range. For purpose of this document, a coverage factor two is used, which corresponds to confidence interval of about 95 %. The DASY uncertainty Budget is shown in the following tables.



Error Description	Uncertainty Value (±%)	Probability	Divisor	(Ci) 1g	(Ci) 10g	Standard Uncertainty (1g) (±%)	Standard Uncertainty (10g) (±%)
Measurement System							
Probe Calibration	6.0	N	1	1	1	6.0	6.0
Axial Isotropy	4.7	R	1.732	0.7	0.7	1.9	1.9
Hemispherical Isotropy	9.6	R	1.732	0.7	0.7	3.9	3.9
Boundary Effects	1.0	R	1.732	1	1	0.6	0.6
Linearity	4.7	R	1.732	1	1	2.7	2.7
System Detection Limits	1.0	R	1.732	1	1	0.6	0.6
Modulation Response	3.2	R	1.732	1	1	1.8	1.8
Readout Electronics	0.3	N	1	1	1	0.3	0.3
Response Time	0.0	R	1.732	1	1	0.0	0.0
Integration Time	2.6	R	1.732	1	1	1.5	1.5
RF Ambient Noise	3.0	R	1.732	1	1	1.7	1.7
RF Ambient Reflections	3.0	R	1.732	1	1	1.7	1.7
Probe Positioner	0.4	R	1.732	1	1	0.2	0.2
Probe Positioning	2.9	R	1.732	1	1	1.7	1.7
Max. SAR Eval.	2.0	R	1.732	1	1	1.2	1.2
Test Sample Related							
Device Positioning	3.0	N	1	1	1	3.0	3.0
Device Holder	3.6	N	1	1	1	3.6	3.6
Power Drift	5.0	R	1.732	1	1	2.9	2.9
Power Scaling	0.0	R	1.732	1	1	0.0	0.0
Phantom and Setup							
Phantom Uncertainty	6.1	R	1.732	1	1	3.5	3.5
SAR correction	0.0	R	1.732	1	0.84	0.0	0.0
Liquid Conductivity Repeatability	0.2	N	1	0.78	0.71	0.1	0.1
Liquid Conductivity (target)	5.0	R	1.732	0.78	0.71	2.3	2.0
Liquid Conductivity (mea.)	2.5	R	1.732	0.78	0.71	1.1	1.0
Temp. unc. - Conductivity	3.4	R	1.732	0.78	0.71	1.5	1.4
Liquid Permittivity Repeatability	0.15	N	1	0.23	0.26	0.0	0.0
Liquid Permittivity (target)	5.0	R	1.732	0.23	0.26	0.7	0.8
Liquid Permittivity (mea.)	2.5	R	1.732	0.23	0.26	0.3	0.4
Temp. unc. - Permittivity	0.83	R	1.732	0.23	0.26	0.1	0.1
Combined Std. Uncertainty						11.4%	11.4%
Coverage Factor for 95 %						K=2	K=2
Expanded STD Uncertainty						22.9%	22.7%

Table 16.2. Uncertainty Budget for frequency range 300 MHz to 3 GHz



Error Description	Uncertainty Value (±%)	Probability	Divisor	(Ci) 1g	(Ci) 10g	Standard Uncertainty (1g) (±%)	Standard Uncertainty (10g) (±%)
Measurement System							
Probe Calibration	7.0	N	1	1	1	7.0	7.0
Axial Isotropy	4.7	R	1.732	0.7	0.7	1.9	1.9
Hemispherical Isotropy	9.6	R	1.732	0.7	0.7	3.9	3.9
Boundary Effects	2.0	R	1.732	1	1	1.2	1.2
Linearity	4.7	R	1.732	1	1	2.7	2.7
System Detection Limits	1.0	R	1.732	1	1	0.6	0.6
Modulation Response	3.2	R	1.732	1	1	1.8	1.8
Readout Electronics	0.3	N	1	1	1	0.3	0.3
Response Time	0.0	R	1.732	1	1	0.0	0.0
Integration Time	2.6	R	1.732	1	1	1.5	1.5
RF Ambient Noise	3.0	R	1.732	1	1	1.7	1.7
RF Ambient Reflections	3.0	R	1.732	1	1	1.7	1.7
Probe Positioner	0.4	R	1.732	1	1	0.2	0.2
Probe Positioning	6.7	R	1.732	1	1	3.9	3.9
Max. SAR Eval.	4.0	R	1.732	1	1	2.3	2.3
Test Sample Related							
Device Positioning	3.0	N	1	1	1	3.0	3.0
Device Holder	3.6	N	1	1	1	3.6	3.6
Power Drift	5.0	R	1.732	1	1	2.9	2.9
Power Scaling	0.0	R	1.732	1	1	0.0	0.0
Phantom and Setup							
Phantom Uncertainty	6.6	R	1.732	1	1	3.8	3.8
SAR correction	0.0	R	1.732	1	0.84	0.0	0.0
Liquid Conductivity Repeatability	0.2	N	1	0.78	0.71	0.1	0.1
Liquid Conductivity (target)	5.0	R	1.732	0.78	0.71	2.3	2.0
Liquid Conductivity (mea.)	2.5	R	1.732	0.78	0.71	1.1	1.0
Temp. unc. - Conductivity	3.4	R	1.732	0.78	0.71	1.5	1.4
Liquid Permittivity Repeatability	0.15	N	1	0.23	0.26	0.0	0.0
Liquid Permittivity (target)	5.0	R	1.732	0.23	0.26	0.7	0.8
Liquid Permittivity (mea.)	2.5	R	1.732	0.23	0.26	0.3	0.4
Temp. unc. - Permittivity	0.83	R	1.732	0.23	0.26	0.1	0.1
Combined Std. Uncertainty						12.8%	12.7%
Coverage Factor for 95 %						K=2	K=2
Expanded STD Uncertainty						25.5%	25.4%

Table 16.3. Uncertainty Budget for frequency range 3 GHz to 6 GHz



17. References

- [1] FCC 47 CFR Part 2 "Frequency Allocations and Radio Treaty Matters; General Rules and Regulations"
- [2] ANSI/IEEE Std. C95.1-1992, "IEEE Standard for Safety Levels with Respect to Human Exposure to Radio Frequency Electromagnetic Fields, 3 kHz to 300 GHz", September 1992
- [3] IEEE Std. 1528-2013, "IEEE Recommended Practice for Determining the Peak Spatial-Average Specific Absorption Rate (SAR) in the Human Head from Wireless Communications Devices: Measurement Techniques", Sep 2013
- [4] SPEAG DASY System Handbook
- [5] FCC KDB 248227 D01 v02r02, "SAR Guidance for IEEE 802.11 (WiFi) Transmitters", Oct 2015.
- [6] FCC KDB 447498 D01 v06, "Mobile and Portable Device RF Exposure Procedures and Equipment Authorization Policies", Oct 2015
- [7] FCC KDB 941225 D01 v03r01, "3G SAR MEAUREMENT PROCEDURES", Oct 2015
- [8] FCC KDB 941225 D05 v02r05, "SAR Evaluation Considerations for LTE Devices", Dec 2015
- [9] FCC KDB 616217 D04 v01r02, "SAR Evaluation Considerations for Laptop, Notebook, Netbook and Tablet Computers", Oct 2015
- [10] FCC KDB 865664 D01 v01r04, "SAR Measurement Requirements for 100 MHz to 6 GHz", Aug 2015.
- [11] FCC KDB 865664 D02 v01r02, "RF Exposure Compliance Reporting and Documentation Considerations" Oct 2015.



Appendix A. Plots of System Performance Check

The plots are shown as follows.

System Check_Body_750MHz

DUT: D750V3-1012

Communication System: CW ; Frequency: 750 MHz; Duty Cycle: 1:1

Medium: MSL_750_161001 Medium parameters used: $f = 750$ MHz; $\sigma = 0.957$ S/m; $\epsilon_r = 55.028$; $\rho = 1000$ kg/m³

Ambient Temperature : 23.6 °C ; Liquid Temperature : 22.6 °C

DASY5 Configuration

- Probe: EX3DV4 - SN3955; ConvF(10.36, 10.36, 10.36); Calibrated: 2015/11/24;
- Sensor-Surface: 1.4mm (Mechanical Surface Detection)
- Electronics: DAE4 Sn1399; Calibrated: 2015/11/23
- Phantom: ELI v4.0; Type: QDOVA001BB; Serial: 1026
- Measurement SW: DASY52, Version 52.8 (8); SEMCAD X Version 14.6.10 (7373)

Pin=250mW/Area Scan (61x61x1): Interpolated grid: dx=1.500 mm, dy=1.500 mm

Maximum value of SAR (interpolated) = 2.89 W/kg

Pin=250mW/Zoom Scan (5x5x7)/Cube 0: Measurement grid: dx=8mm, dy=8mm, dz=5mm

Reference Value = 58.72 V/m; Power Drift = -0.12 dB

Peak SAR (extrapolated) = 3.23 W/kg

SAR(1 g) = 2.21 W/kg; SAR(10 g) = 1.5 W/kg

Maximum value of SAR (measured) = 2.89 W/kg

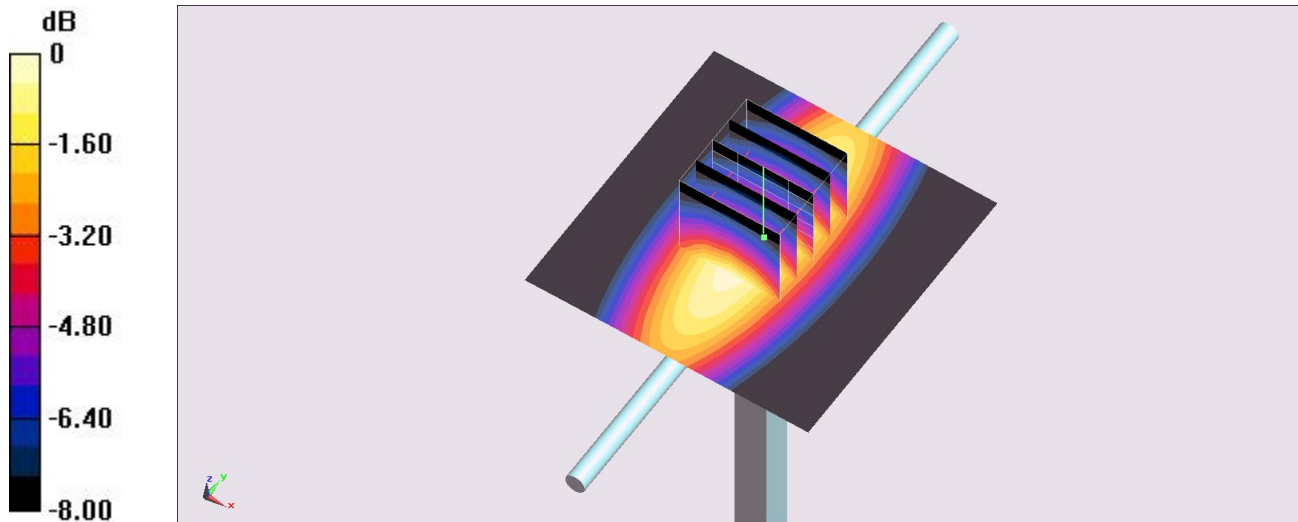

0 dB = 2.89 W/kg = 4.61 dBW/kg

System Check_Body_835MHz

DUT: D835V2-499

Communication System: CW; Frequency: 835 MHz; Duty Cycle: 1:1

Medium: MSL_850_161001 Medium parameters used: $f = 835 \text{ MHz}$; $\sigma = 0.986 \text{ S/m}$; $\epsilon_r = 56.433$; $\rho = 1000 \text{ kg/m}^3$

Ambient Temperature : $23.6 \text{ }^\circ\text{C}$; Liquid Temperature : $22.6 \text{ }^\circ\text{C}$

DASY5 Configuration

- Probe: EX3DV4 - SN3955; ConvF(10.08, 10.08, 10.08); Calibrated: 2015/11/24;
- Sensor-Surface: 1.4mm (Mechanical Surface Detection)
- Electronics: DAE4 Sn1399; Calibrated: 2015/11/23
- Phantom: ELI v4.0; Type: QDOVA001BB; Serial: 1026
- Measurement SW: DASY52, Version 52.8 (8); SEMCAD X Version 14.6.10 (7373)

Pin=250mW/Area Scan (61x61x1): Interpolated grid: $dx=1.500 \text{ mm}$, $dy=1.500 \text{ mm}$

Maximum value of SAR (interpolated) = 3.35 W/kg

Pin=250mW/Zoom Scan (5x5x7)/Cube 0: Measurement grid: $dx=8\text{mm}$, $dy=8\text{mm}$, $dz=5\text{mm}$

Reference Value = 60.65 V/m ; Power Drift = 0.02 dB

Peak SAR (extrapolated) = 3.78 W/kg

SAR(1 g) = 2.53 W/kg ; SAR(10 g) = 1.67 W/kg

Maximum value of SAR (measured) = 3.33 W/kg

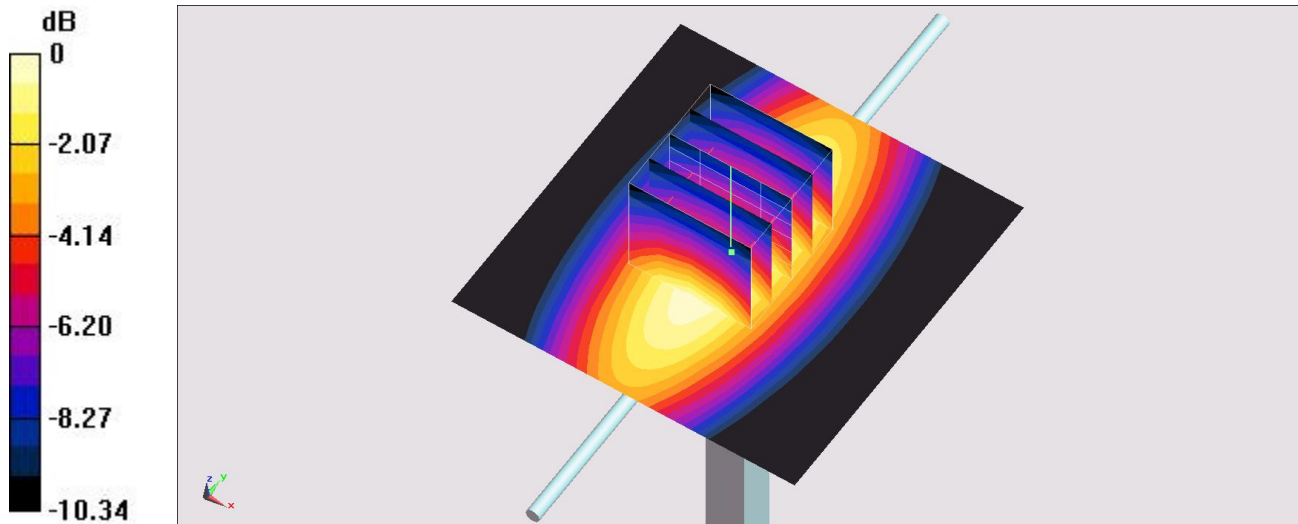

0 dB = $3.33 \text{ W/kg} = 5.22 \text{ dBW/kg}$

System Check_Body_1750MHz

DUT: D1750V2-1068

Communication System: CW; Frequency: 1750 MHz; Duty Cycle: 1:1

Medium: MSL_1750_161001 Medium parameters used: $f = 1750$ MHz; $\sigma = 1.508$ S/m; $\epsilon_r = 55.884$; $\rho = 1000$ kg/m³

Ambient Temperature : 23.7 °C; Liquid Temperature : 22.7 °C

DASY5 Configuration

- Probe: EX3DV4 - SN3955; ConvF(8.25, 8.25, 8.25); Calibrated: 2015/11/24;
- Sensor-Surface: 1.4mm (Mechanical Surface Detection)
- Electronics: DAE4 Sn1399; Calibrated: 2015/11/23
- Phantom: ELI v4.0; Type: QDOVA001BB; Serial: 1026
- Measurement SW: DASY52, Version 52.8 (8); SEMCAD X Version 14.6.10 (7373)

Pin=250mW/Area Scan (61x61x1): Interpolated grid: dx=1.500 mm, dy=1.500 mm

Maximum value of SAR (interpolated) = 13.7 W/kg

Pin=250mW/Zoom Scan (5x5x7)/Cube 0: Measurement grid: dx=8mm, dy=8mm, dz=5mm

Reference Value = 97.46 V/m; Power Drift = 0.11 dB

Peak SAR (extrapolated) = 16.0 W/kg

SAR(1 g) = 9.15 W/kg; SAR(10 g) = 4.91 W/kg

Maximum value of SAR (measured) = 13.8 W/kg

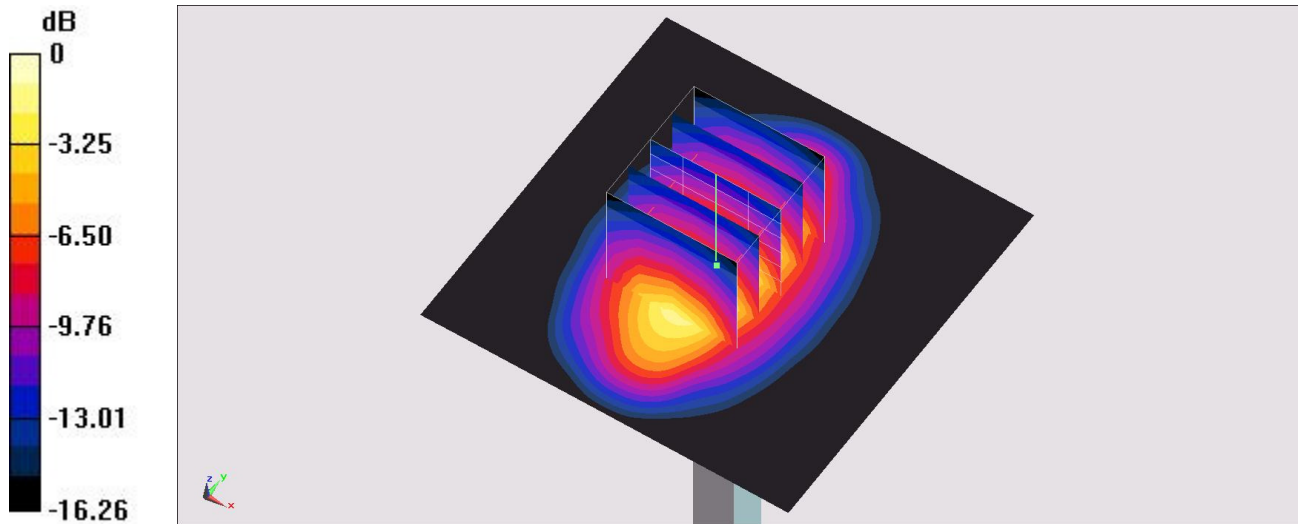

0 dB = 13.8 W/kg = 11.40 dBW/kg

System Check_Body_1900MHz

DUT: D1900V2-5d041

Communication System: CW; Frequency: 1900 MHz; Duty Cycle: 1:1

Medium: MSL_1900_161001 Medium parameters used: $f = 1900$ MHz; $\sigma = 1.52$ S/m; $\epsilon_r = 53.546$; $\rho = 1000$ kg/m³

Ambient Temperature : 23.7 °C; Liquid Temperature : 22.7 °C

DASY5 Configuration

- Probe: EX3DV4 - SN3955; ConvF(7.89, 7.89, 7.89); Calibrated: 2015/11/24;
- Sensor-Surface: 1.4mm (Mechanical Surface Detection)
- Electronics: DAE4 Sn1399; Calibrated: 2015/11/23
- Phantom: ELI v4.0; Type: QDOVA001BB; Serial: 1026
- Measurement SW: DASY52, Version 52.8 (8); SEMCAD X Version 14.6.10 (7373)

Pin=250mW/Area Scan (61x61x1): Interpolated grid: dx=1.500 mm, dy=1.500 mm

Maximum value of SAR (interpolated) = 15.1 W/kg

Pin=250mW/Zoom Scan (5x5x7)/Cube 0: Measurement grid: dx=8mm, dy=8mm, dz=5mm

Reference Value = 102.6 V/m; Power Drift = 0.06 dB

Peak SAR (extrapolated) = 17.9 W/kg

SAR(1 g) = 10 W/kg; SAR(10 g) = 5.25 W/kg

Maximum value of SAR (measured) = 15.4 W/kg

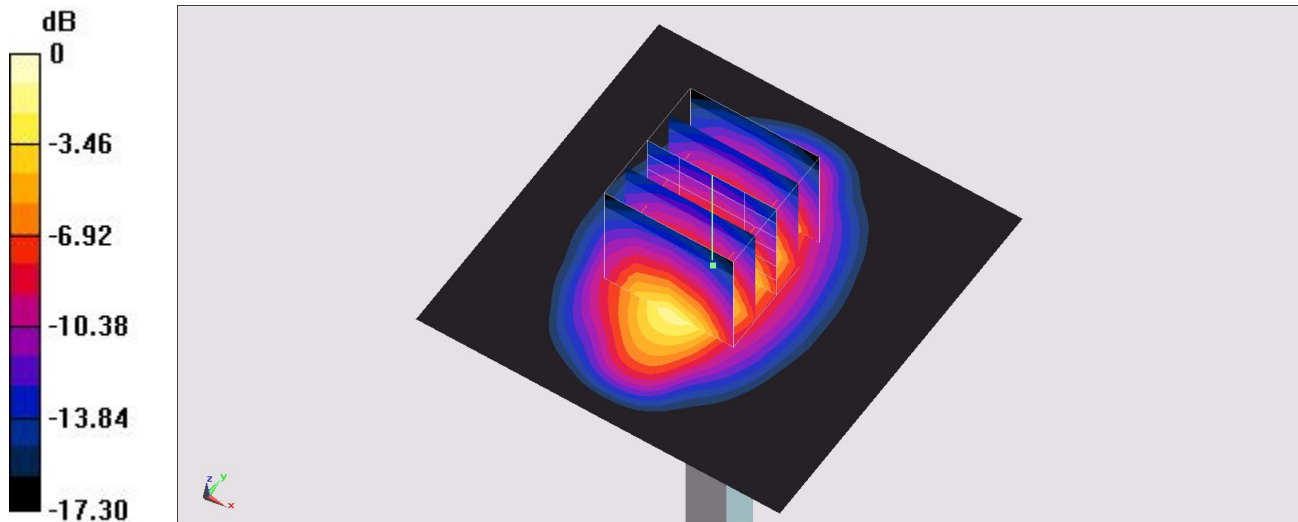

0 dB = 15.4 W/kg = 11.88 dBW/kg

System Check_Body_2450MHz

DUT: D2450V2-926

Communication System: CW; Frequency: 2450 MHz; Duty Cycle: 1:1

Medium: MSL_2450_161007 Medium parameters used: $f = 2450$ MHz; $\sigma = 1.986$ S/m; $\epsilon_r = 54.952$; $\rho = 1000$ kg/m³

Ambient Temperature : 23.3 °C; Liquid Temperature : 22.3 °C

DASY5 Configuration

- Probe: EX3DV4 - SN3955; ConvF(7.53, 7.53, 7.53); Calibrated: 2015/11/24;
- Sensor-Surface: 1.4mm (Mechanical Surface Detection)
- Electronics: DAE4 Sn1399; Calibrated: 2015/11/23
- Phantom: ELI v4.0; Type: QDOVA001BB; Serial: 1026
- Measurement SW: DASY52, Version 52.8 (8); SEMCAD X Version 14.6.10 (7373)

Pin=250mW/Area Scan (61x61x1): Interpolated grid: dx=1.200 mm, dy=1.200 mm

Maximum value of SAR (interpolated) = 20.4 W/kg

Pin=250mW/Zoom Scan (7x7x7)/Cube 0: Measurement grid: dx=5mm, dy=5mm, dz=5mm

Reference Value = 102.2 V/m; Power Drift = -0.07 dB

Peak SAR (extrapolated) = 23.8 W/kg

SAR(1 g) = 12.1 W/kg; SAR(10 g) = 5.74 W/kg

Maximum value of SAR (measured) = 19.7 W/kg

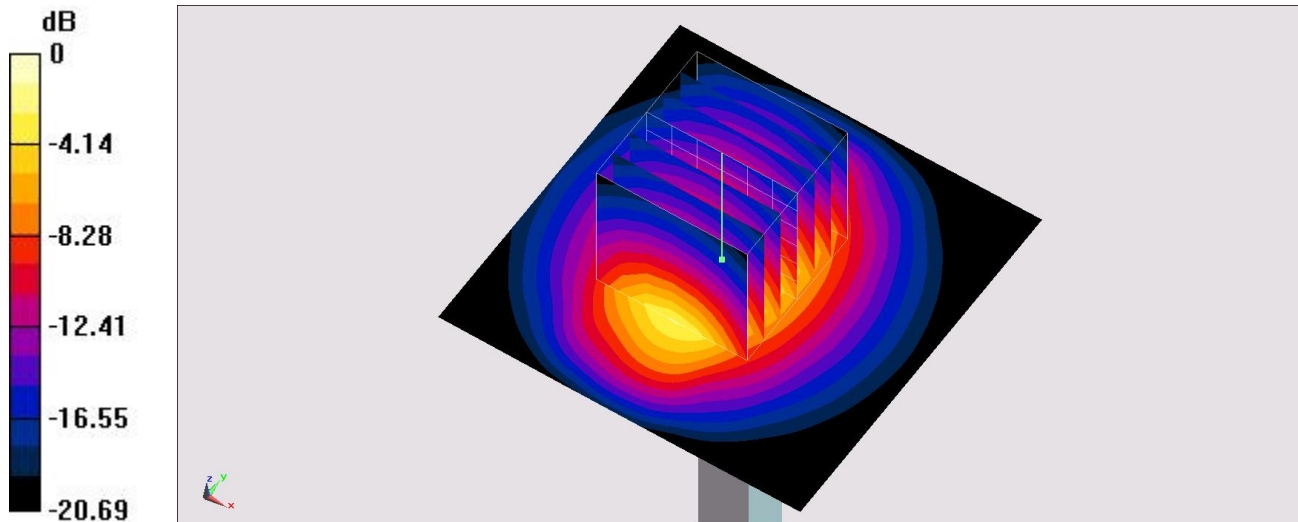

0 dB = 19.7 W/kg = 12.94 dBW/kg

System Check_Body_2450MHz

DUT: D2450V2-926

Communication System: CW; Frequency: 2450 MHz; Duty Cycle: 1:1

Medium: MSL_2450_161018 Medium parameters used: $f = 2450$ MHz; $\sigma = 1.944$ S/m; $\epsilon_r = 53.053$; $\rho = 1000$ kg/m³

Ambient Temperature : 23.3 °C; Liquid Temperature : 22.3 °C

DASY5 Configuration

- Probe: EX3DV4 - SN3955; ConvF(7.53, 7.53, 7.53); Calibrated: 2015/11/24;
- Sensor-Surface: 1.4mm (Mechanical Surface Detection)
- Electronics: DAE4 Sn1399; Calibrated: 2015/11/23
- Phantom: ELI v4.0; Type: QDOVA001BB; Serial: 1026
- Measurement SW: DASY52, Version 52.8 (8); SEMCAD X Version 14.6.10 (7373)

Pin=250mW/Area Scan (61x61x1): Interpolated grid: dx=1.200 mm, dy=1.200 mm

Maximum value of SAR (interpolated) = 20.1 W/kg

Pin=250mW/Zoom Scan (7x7x7)/Cube 0: Measurement grid: dx=5mm, dy=5mm, dz=5mm

Reference Value = 104.4 V/m; Power Drift = 0.01 dB

Peak SAR (extrapolated) = 24.3 W/kg

SAR(1 g) = 12.4 W/kg; SAR(10 g) = 5.9 W/kg

Maximum value of SAR (measured) = 20.0 W/kg

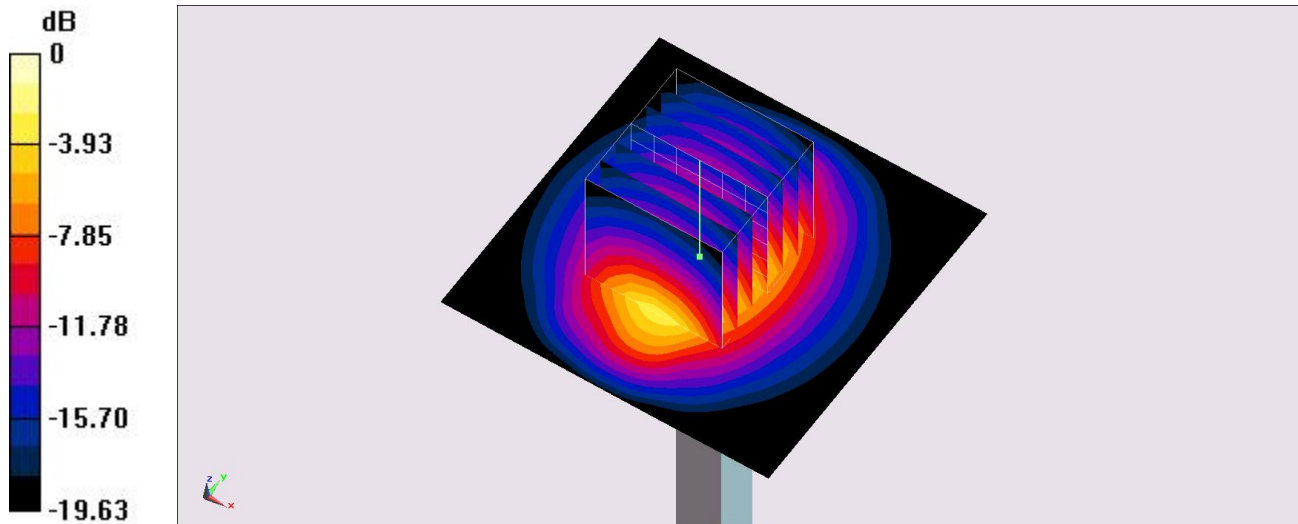

0 dB = 20.0 W/kg = 13.01 dBW/kg

System Check_Body_2600MHz

DUT: D2600V2-1113

Communication System: CW; Frequency: 2600 MHz; Duty Cycle: 1:1

Medium: MSL_2600_160922 Medium parameters used: $f = 2600$ MHz; $\sigma = 2.125$ S/m; $\epsilon_r = 52.57$; $\rho = 1000$ kg/m³

Ambient Temperature : 23.4 °C; Liquid Temperature : 22.4 °C

DASY5 Configuration

- Probe: EX3DV4 - SN3820; ConvF(6.52, 6.52, 6.52); Calibrated: 2016/6/27;
- Sensor-Surface: 1.4mm (Mechanical Surface Detection)
- Electronics: DAE4 Sn679; Calibrated: 2016/6/13
- Phantom: ELI v5.0; Type: QDOVA002AA; Serial: TP:1227
- Measurement SW: DASY52, Version 52.8 (8); SEMCAD X Version 14.6.10 (7373)

Pin=250mW/Area Scan (61x61x1): Interpolated grid: dx=1.200 mm, dy=1.200 mm

Maximum value of SAR (interpolated) = 22.8 W/kg

Pin=250mW/Zoom Scan (7x7x7)/Cube 0: Measurement grid: dx=5mm, dy=5mm, dz=5mm

Reference Value = 106.2 V/m; Power Drift = -0.10 dB

Peak SAR (extrapolated) = 27.3 W/kg

SAR(1 g) = 14.1 W/kg; SAR(10 g) = 6.63 W/kg

Maximum value of SAR (measured) = 22.7 W/kg

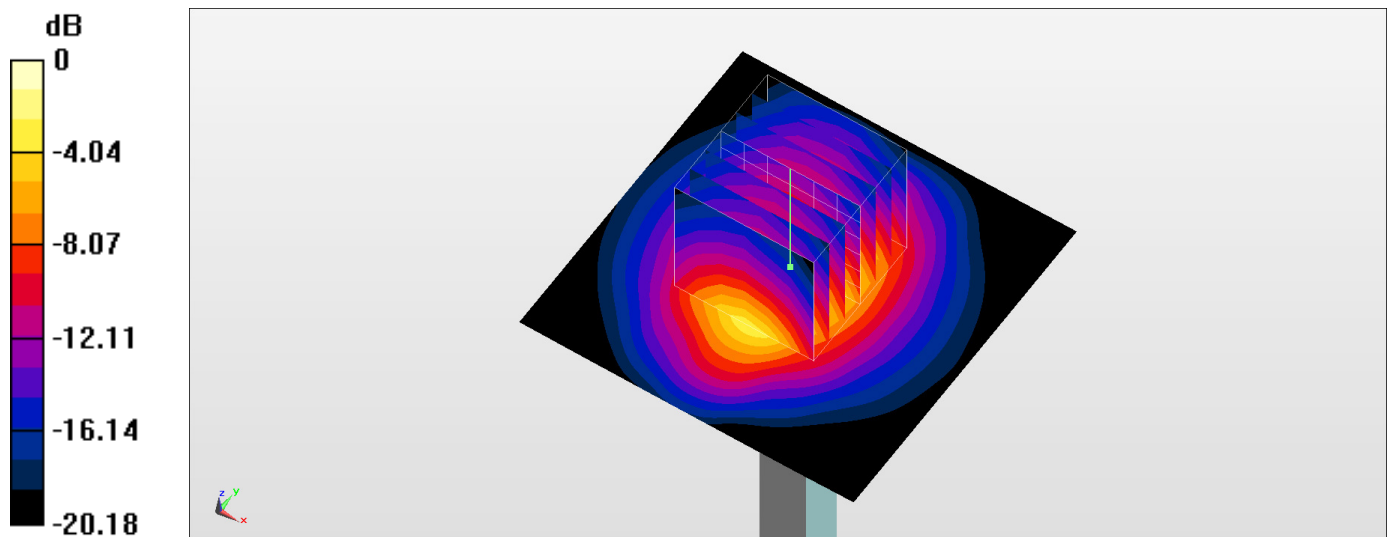

0 dB = 22.7 W/kg = 13.56 dBW/kg

System Check_Body_5200MHz

DUT: D5GHzV2-1040

Communication System: CW; Frequency: 5200 MHz; Duty Cycle: 1:1

Medium: MSL_5G_161001 Medium parameters used: $f = 5200$ MHz; $\sigma = 5.459$ S/m; $\epsilon_r = 47.153$; $\rho = 1000$ kg/m³

Ambient Temperature : 23.5 °C; Liquid Temperature : 22.5 °C

DASY5 Configuration

- Probe: EX3DV4 - SN3925; ConvF(4.39, 4.39, 4.39); Calibrated: 2016/5/26;
- Sensor-Surface: 1.4mm (Mechanical Surface Detection)
- Electronics: DAE3 Sn495; Calibrated: 2016/5/27
- Phantom: ELI v5.0; Type: QDOVA002AA; Serial: TP:1227
- Measurement SW: DASY52, Version 52.8 (8); SEMCAD X Version 14.6.10 (7373)

Pin=100mW/Area Scan (71x71x1): Interpolated grid: dx=1.000 mm, dy=1.000 mm

Maximum value of SAR (interpolated) = 17.8 W/kg

Pin=100mW/Zoom Scan (7x7x7)/Cube 0: Measurement grid: dx=4mm, dy=4mm, dz=1.4mm

Reference Value = 41.41 V/m; Power Drift = 0.02 dB

Peak SAR (extrapolated) = 30.8 W/kg

SAR(1 g) = 7.29 W/kg; SAR(10 g) = 1.95 W/kg

Maximum value of SAR (measured) = 18.5 W/kg

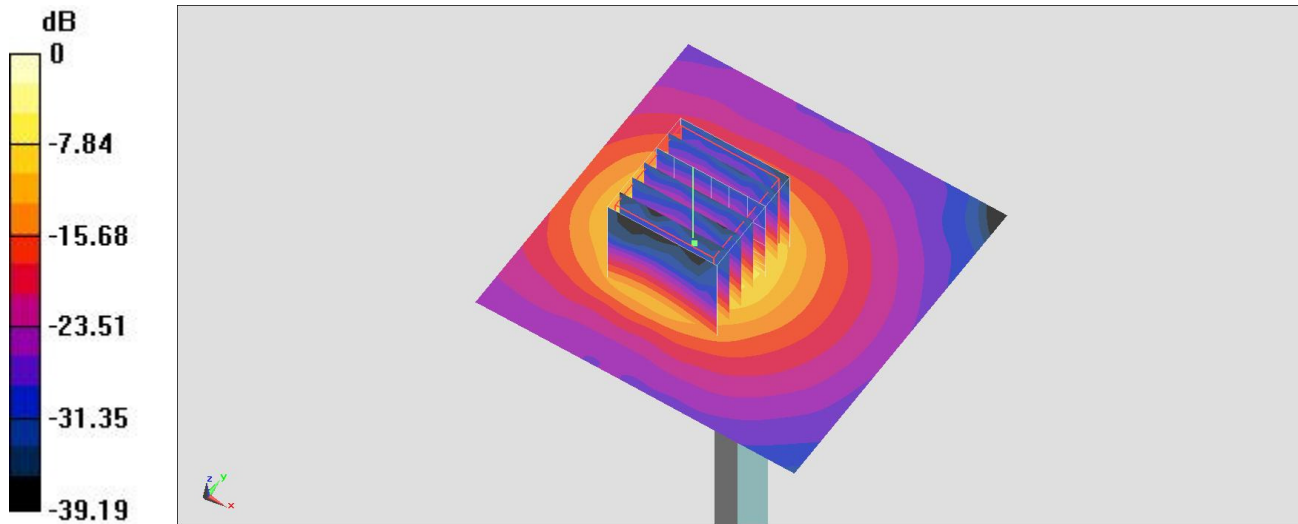

0 dB = 18.5 W/kg = 12.67 dBW/kg

System Check_Body_5250MHz

DUT: D5GHzV2-1128

Communication System: CW; Frequency: 5250 MHz; Duty Cycle: 1:1

Medium: MSL_5G_161006 Medium parameters used: $f = 5250$ MHz; $\sigma = 5.389$ S/m; $\epsilon_r = 46.935$; $\rho = 1000$ kg/m³

Ambient Temperature : 23.3 °C; Liquid Temperature : 22.3 °C

DASY5 Configuration

- Probe: EX3DV4 - SN3955; ConvF(4.42, 4.42, 4.42); Calibrated: 2015/11/24;
- Sensor-Surface: 1.4mm (Mechanical Surface Detection)
- Electronics: DAE4 Sn1399; Calibrated: 2015/11/23
- Phantom: ELI v4.0; Type: QDOVA001BB; Serial: 1026
- Measurement SW: DASY52, Version 52.8 (8); SEMCAD X Version 14.6.10 (7373)

Pin=100mW/Area Scan (71x71x1): Interpolated grid: dx=1.000 mm, dy=1.000 mm

Maximum value of SAR (interpolated) = 18.1 W/kg

Pin=100mW/Zoom Scan (7x7x7)/Cube 0: Measurement grid: dx=4mm, dy=4mm, dz=1.4mm

Reference Value = 65.18 V/m; Power Drift = 0.10 dB

Peak SAR (extrapolated) = 29.6 W/kg

SAR(1 g) = 7.73 W/kg; SAR(10 g) = 2.21 W/kg

Maximum value of SAR (measured) = 17.9 W/kg

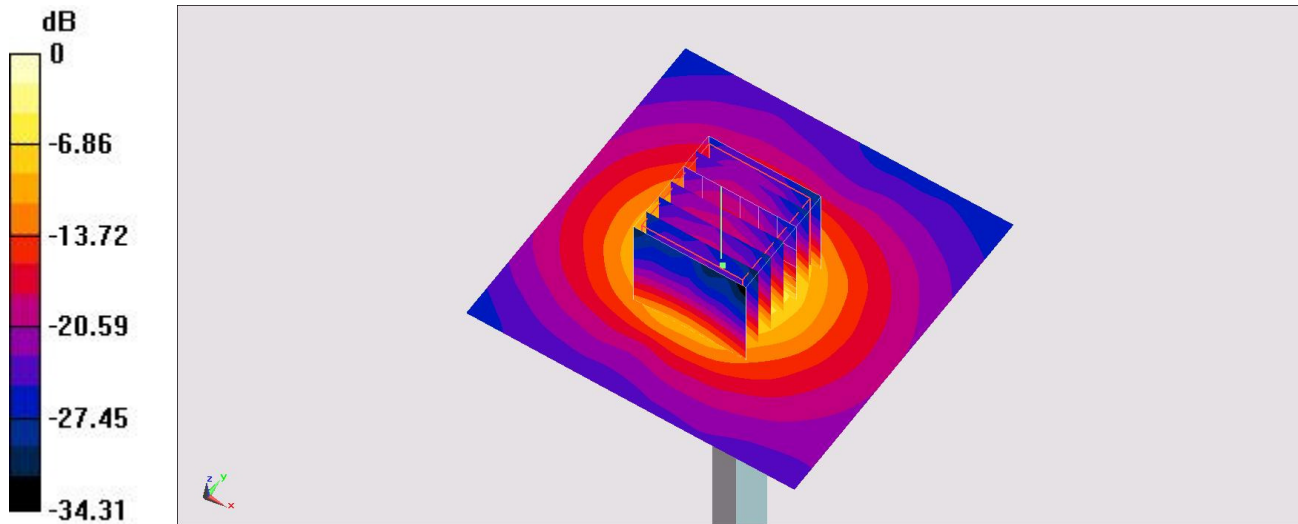

0 dB = 17.9 W/kg = 12.53 dBW/kg

System Check_Body_5300MHz

DUT: D5GHzV2-1040

Communication System: CW; Frequency: 5300 MHz; Duty Cycle: 1:1

Medium: MSL_5G_161001 Medium parameters used: $f = 5300$ MHz; $\sigma = 5.588$ S/m; $\epsilon_r = 46.984$; $\rho = 1000$ kg/m³

Ambient Temperature : 23.5 °C; Liquid Temperature : 22.5 °C

DASY5 Configuration

- Probe: EX3DV4 - SN3925; ConvF(4.22, 4.22, 4.22); Calibrated: 2016/5/26;
- Sensor-Surface: 1.4mm (Mechanical Surface Detection)
- Electronics: DAE3 Sn495; Calibrated: 2016/5/27
- Phantom: ELI v5.0; Type: QDOVA002AA; Serial: TP:1227
- Measurement SW: DASY52, Version 52.8 (8); SEMCAD X Version 14.6.10 (7373)

Pin=100mW/Area Scan (71x71x1): Interpolated grid: dx=1.000 mm, dy=1.000 mm

Maximum value of SAR (interpolated) = 18.9 W/kg

Pin=100mW/Zoom Scan (7x7x7)/Cube 0: Measurement grid: dx=4mm, dy=4mm, dz=1.4mm

Reference Value = 42.23 V/m; Power Drift = -0.05 dB

Peak SAR (extrapolated) = 32.8 W/kg

SAR(1 g) = 7.76 W/kg; SAR(10 g) = 2.08 W/kg

Maximum value of SAR (measured) = 19.7 W/kg

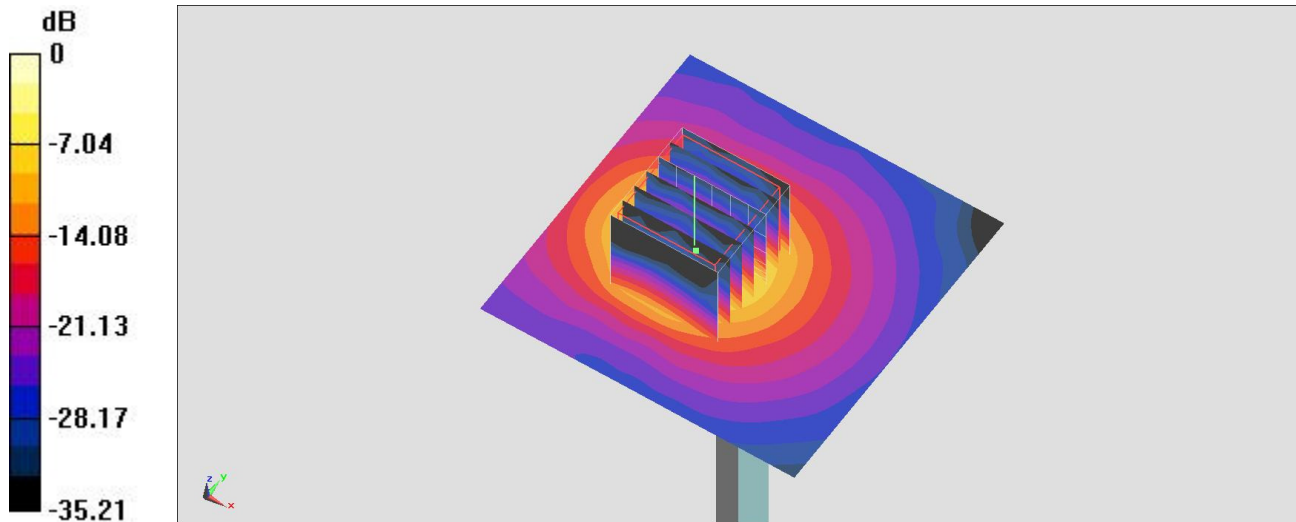

0 dB = 19.7 W/kg = 12.94 dBW/kg

System Check_Body_5600MHz

DUT: D5GHzV2-1128

Communication System: CW; Frequency: 5600 MHz; Duty Cycle: 1:1

Medium: MSL_5G_161003 Medium parameters used: $f = 5600$ MHz; $\sigma = 5.649$ S/m; $\epsilon_r = 46.107$; $\rho = 1000$ kg/m³

Ambient Temperature : 23.7 °C; Liquid Temperature : 22.7 °C

DASY5 Configuration

- Probe: EX3DV4 - SN3955; ConvF(3.81, 3.81, 3.81); Calibrated: 2015/11/24;
- Sensor-Surface: 1.4mm (Mechanical Surface Detection)
- Electronics: DAE4 Sn1399; Calibrated: 2015/11/23
- Phantom: ELI v4.0; Type: QDOVA001BB; Serial: 1026
- Measurement SW: DASY52, Version 52.8 (8); SEMCAD X Version 14.6.10 (7373)

Pin=100mW/Area Scan (71x71x1): Interpolated grid: dx=1.000 mm, dy=1.000 mm

Maximum value of SAR (interpolated) = 18.7 W/kg

Pin=100mW/Zoom Scan (7x7x7)/Cube 0: Measurement grid: dx=4mm, dy=4mm, dz=1.4mm

Reference Value = 68.28 V/m; Power Drift = -0.06 dB

Peak SAR (extrapolated) = 30.1 W/kg

SAR(1 g) = 7.5 W/kg; SAR(10 g) = 2.07 W/kg

Maximum value of SAR (measured) = 18.6 W/kg

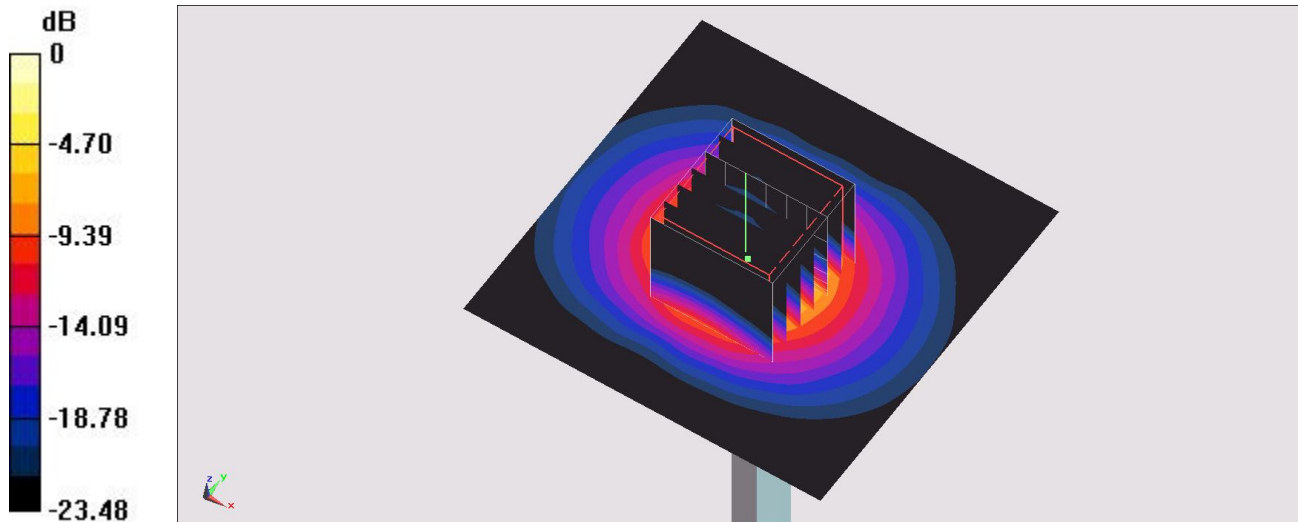

0 dB = 18.6 W/kg = 12.70 dBW/kg

System Check_Body_5600MHz

DUT: D5GHzV2-1128

Communication System: CW; Frequency: 5600 MHz; Duty Cycle: 1:1

Medium: MSL_5G_161006 Medium parameters used: $f = 5600$ MHz; $\sigma = 5.92$ S/m; $\epsilon_r = 46.713$; $\rho = 1000$ kg/m³

Ambient Temperature : 23.3 °C; Liquid Temperature : 22.3 °C

DASY5 Configuration

- Probe: EX3DV4 - SN3955; ConvF(3.81, 3.81, 3.81); Calibrated: 2015/11/24;
- Sensor-Surface: 1.4mm (Mechanical Surface Detection)
- Electronics: DAE4 Sn1399; Calibrated: 2015/11/23
- Phantom: ELI v4.0; Type: QDOVA001BB; Serial: 1026
- Measurement SW: DASY52, Version 52.8 (8); SEMCAD X Version 14.6.10 (7373)

Pin=100mW/Area Scan (71x71x1): Interpolated grid: dx=1.000 mm, dy=1.000 mm

Maximum value of SAR (interpolated) = 19.2 W/kg

Pin=100mW/Zoom Scan (7x7x7)/Cube 0: Measurement grid: dx=4mm, dy=4mm, dz=1.4mm

Reference Value = 65.64 V/m; Power Drift = 0.16 dB

Peak SAR (extrapolated) = 30.7 W/kg

SAR(1 g) = 7.95 W/kg; SAR(10 g) = 2.23 W/kg

Maximum value of SAR (measured) = 19.3 W/kg

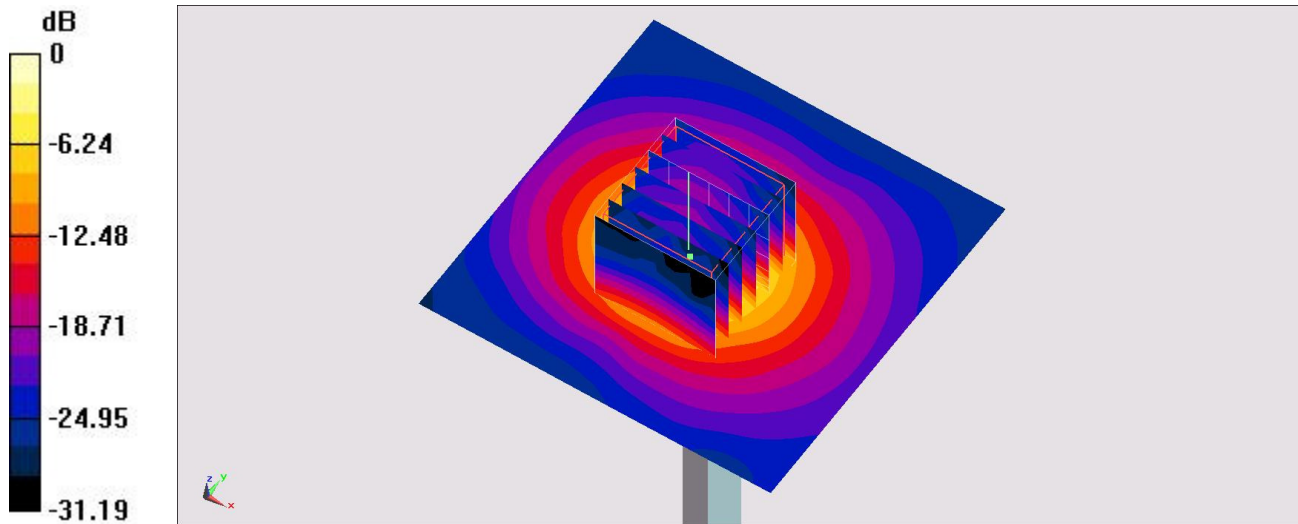

0 dB = 19.3 W/kg = 12.86 dBW/kg

System Check_Body_5750MHz

DUT: D5GHzV2-1128

Communication System: CW; Frequency: 5750 MHz; Duty Cycle: 1:1

Medium: MSL_5G_161006 Medium parameters used: $f = 5750$ MHz; $\sigma = 6.121$ S/m; $\epsilon_r = 46.454$; $\rho = 1000$ kg/m³

Ambient Temperature : 23.3 °C; Liquid Temperature : 22.3 °C

DASY5 Configuration

- Probe: EX3DV4 - SN3955; ConvF(3.92, 3.92, 3.92); Calibrated: 2015/11/24;
- Sensor-Surface: 1.4mm (Mechanical Surface Detection)
- Electronics: DAE4 Sn1399; Calibrated: 2015/11/23
- Phantom: ELI v4.0; Type: QDOVA001BB; Serial: 1026
- Measurement SW: DASY52, Version 52.8 (8); SEMCAD X Version 14.6.10 (7373)

Pin=100mW/Area Scan (71x71x1): Interpolated grid: dx=1.000 mm, dy=1.000 mm

Maximum value of SAR (interpolated) = 18.3 W/kg

Pin=100mW/Zoom Scan (7x7x7)/Cube 0: Measurement grid: dx=4mm, dy=4mm, dz=1.4mm

Reference Value = 65.84 V/m; Power Drift = 0.04 dB

Peak SAR (extrapolated) = 32.1 W/kg

SAR(1 g) = 7.43 W/kg; SAR(10 g) = 2.02 W/kg

Maximum value of SAR (measured) = 19.2 W/kg

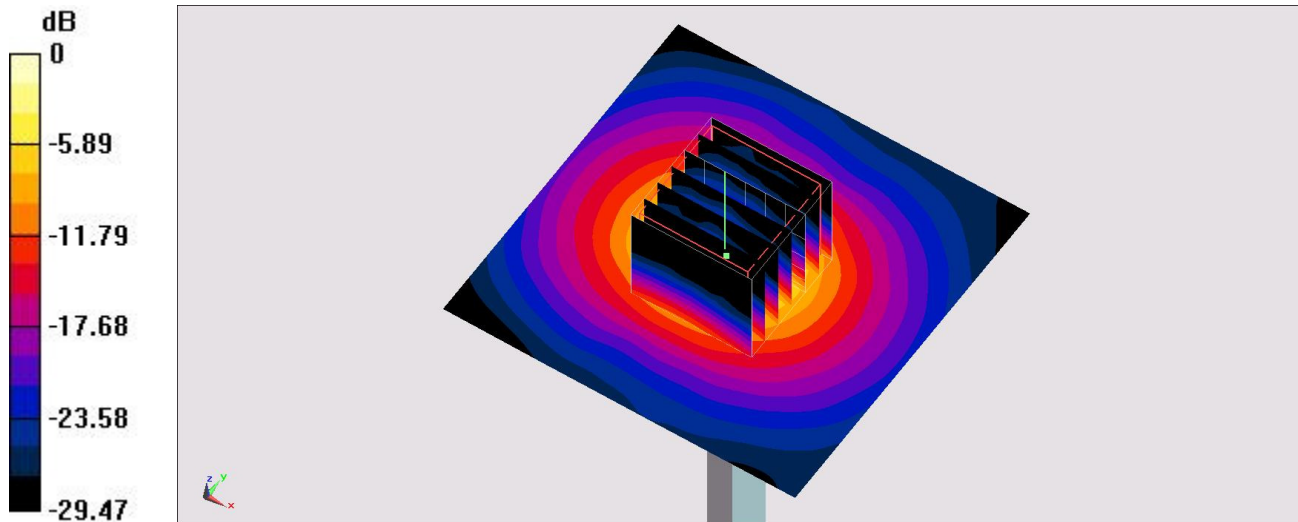

0 dB = 19.2 W/kg = 12.83 dBW/kg



Appendix B. Plots of SAR Measurement

The plots are shown as follows.

#01_WCDMA II_RMC 12.2Kbps_Bottom Face_11mm_Ch9262

Communication System: WCDMA; Frequency: 1852.4 MHz; Duty Cycle: 1:1

Medium: MSL_1900_161001 Medium parameters used: $f = 1852.4 \text{ MHz}$; $\sigma = 1.464 \text{ S/m}$; $\epsilon_r = 53.729$;
 $\rho = 1000 \text{ kg/m}^3$

Ambient Temperature : $23.7 \text{ }^\circ\text{C}$; Liquid Temperature : $22.7 \text{ }^\circ\text{C}$

DASY5 Configuration

- Probe: EX3DV4 - SN3955; ConvF(7.89, 7.89, 7.89); Calibrated: 2015/11/24;
- Sensor-Surface: 1.4mm (Mechanical Surface Detection)
- Electronics: DAE4 Sn1399; Calibrated: 2015/11/23
- Phantom: ELI v4.0; Type: QDOVA001BB; Serial: 1026
- Measurement SW: DASY52, Version 52.8 (8); SEMCAD X Version 14.6.10 (7373)

Area Scan (51x71x1): Interpolated grid: $dx=1.500 \text{ mm}$, $dy=1.500 \text{ mm}$

Maximum value of SAR (interpolated) = 0.946 W/kg

Zoom Scan (5x5x7)/Cube 0: Measurement grid: $dx=8\text{mm}$, $dy=8\text{mm}$, $dz=5\text{mm}$

Reference Value = 23.43 V/m ; Power Drift = 0.04 dB

Peak SAR (extrapolated) = 1.03 W/kg

SAR(1 g) = 0.638 W/kg ; SAR(10 g) = 0.375 W/kg

Maximum value of SAR (measured) = 0.907 W/kg

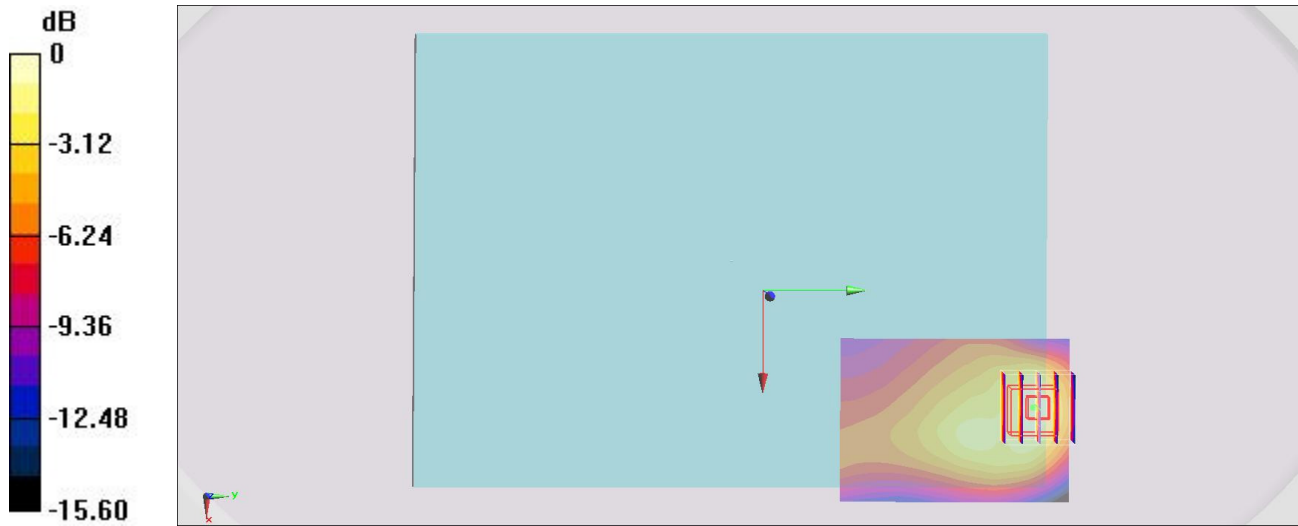

0 dB = 0.907 W/kg = -0.42 dBW/kg

#02_WCDMA IV_RMC 12.2Kbps_Bottom Face_11mm_Ch1513

Communication System: WCDMA; Frequency: 1752.6 MHz; Duty Cycle: 1:1

Medium: MSL_1750_161001 Medium parameters used: $f = 1753$ MHz; $\sigma = 1.511$ S/m; $\epsilon_r = 55.876$; $\rho = 1000$ kg/m³

Ambient Temperature : 23.7 °C; Liquid Temperature : 22.7 °C

DASY5 Configuration

- Probe: EX3DV4 - SN3955; ConvF(8.25, 8.25, 8.25); Calibrated: 2015/11/24;
- Sensor-Surface: 1.4mm (Mechanical Surface Detection)
- Electronics: DAE4 Sn1399; Calibrated: 2015/11/23
- Phantom: ELI v4.0; Type: QDOVA001BB; Serial: 1026
- Measurement SW: DASY52, Version 52.8 (8); SEMCAD X Version 14.6.10 (7373)

Area Scan (51x71x1): Interpolated grid: dx=1.500 mm, dy=1.500 mm

Maximum value of SAR (interpolated) = 1.19 W/kg

Zoom Scan (5x5x7)/Cube 0: Measurement grid: dx=8mm, dy=8mm, dz=5mm

Reference Value = 28.37 V/m; Power Drift = -0.11 dB

Peak SAR (extrapolated) = 1.30 W/kg

SAR(1 g) = 0.821 W/kg; SAR(10 g) = 0.489 W/kg

Maximum value of SAR (measured) = 1.15 W/kg

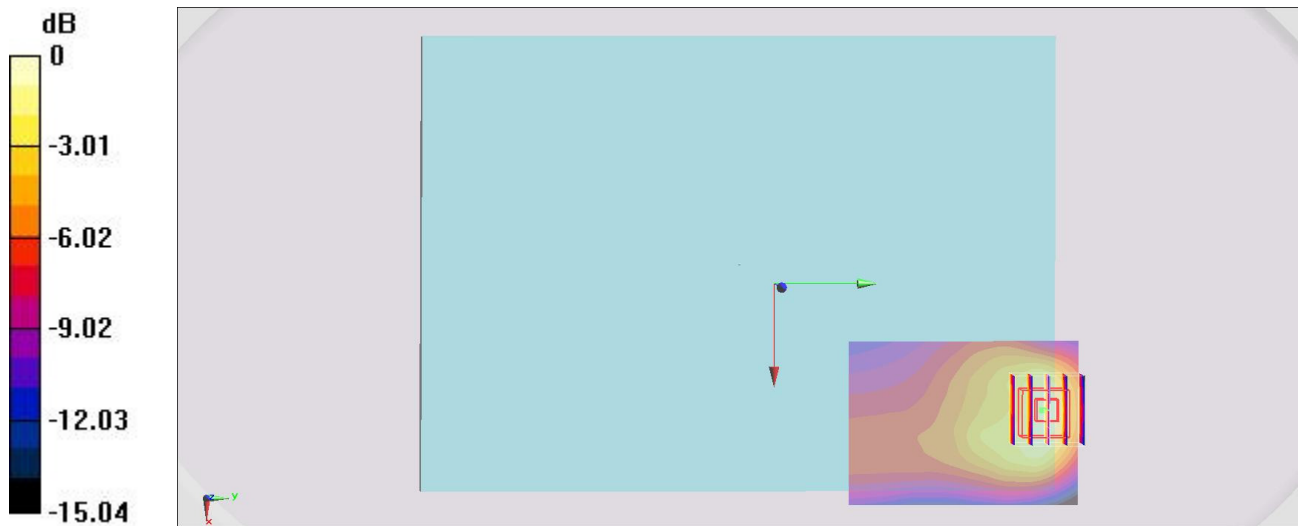

0 dB = 1.15 W/kg = 0.61 dBW/kg

#03_WCDMA V_RMC 12.2Kbps_Bottom Face_0mm_Ch4182

Communication System: WCDMA; Frequency: 836.4 MHz; Duty Cycle: 1:1
 Medium: MSL_850_161001 Medium parameters used: $f = 836.4$ MHz; $\sigma = 0.987$ S/m; $\epsilon_r = 56.421$; $\rho = 1000$ kg/m³
 Ambient Temperature : 23.6 °C; Liquid Temperature : 22.6 °C

DASY5 Configuration

- Probe: EX3DV4 - SN3955; ConvF(10.08, 10.08, 10.08); Calibrated: 2015/11/24;
- Sensor-Surface: 1.4mm (Mechanical Surface Detection)
- Electronics: DAE4 Sn1399; Calibrated: 2015/11/23
- Phantom: ELI v4.0; Type: QDOVA001BB; Serial: 1026
- Measurement SW: DASY52, Version 52.8 (8); SEMCAD X Version 14.6.10 (7373)

Area Scan (51x71x1): Interpolated grid: dx=1.500 mm, dy=1.500 mm
 Maximum value of SAR (interpolated) = 1.47 W/kg

Zoom Scan (6x6x7)/Cube 0: Measurement grid: dx=8mm, dy=8mm, dz=5mm
 Reference Value = 25.79 V/m; Power Drift = -0.19 dB
 Peak SAR (extrapolated) = 1.61 W/kg
SAR(1 g) = 0.879 W/kg; SAR(10 g) = 0.529 W/kg
 Maximum value of SAR (measured) = 1.36 W/kg

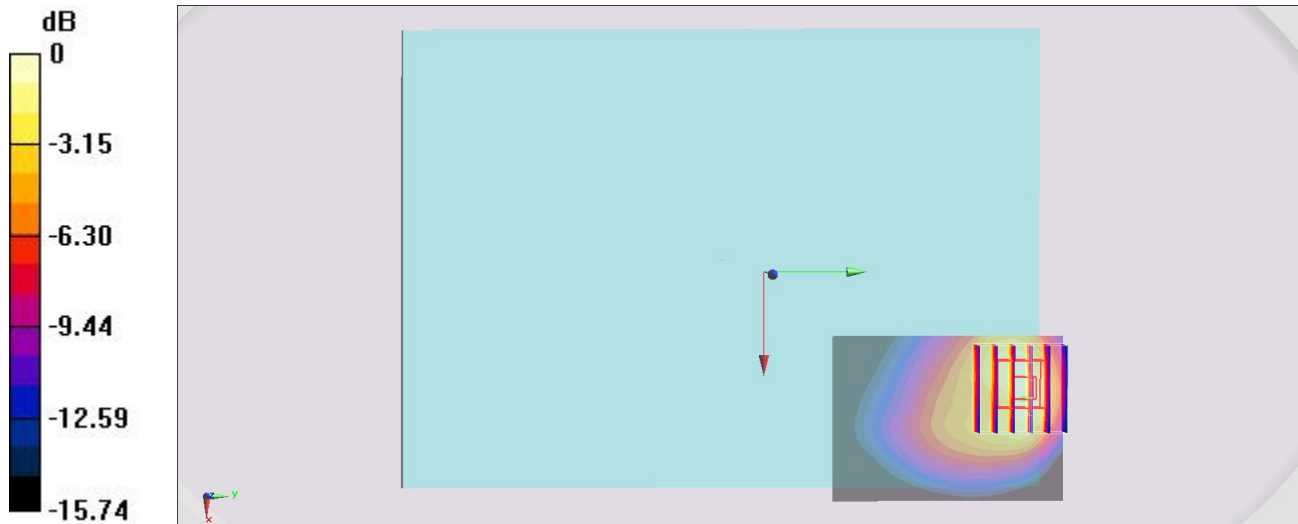

0 dB = 1.36 W/kg = 1.34 dBW/kg

#04_LTE Band 4_20M_QPSK_1_0_Edge 2_0mm_Ch20175

Communication System: LTE; Frequency: 1732.5 MHz; Duty Cycle: 1:1

Medium: MSL_1750_161001 Medium parameters used: $f = 1732.5$ MHz; $\sigma = 1.49$ S/m; $\epsilon_r = 55.939$; $\rho = 1000$ kg/m³

Ambient Temperature : 23.7 °C; Liquid Temperature : 22.7 °C

DASY5 Configuration

- Probe: EX3DV4 - SN3955; ConvF(8.25, 8.25, 8.25); Calibrated: 2015/11/24;
- Sensor-Surface: 1.4mm (Mechanical Surface Detection)
- Electronics: DAE4 Sn1399; Calibrated: 2015/11/23
- Phantom: ELI v4.0; Type: QDOVA001BB; Serial: 1026
- Measurement SW: DASY52, Version 52.8 (8); SEMCAD X Version 14.6.10 (7373)

Area Scan (41x81x1): Interpolated grid: dx=1.500 mm, dy=1.500 mm

Maximum value of SAR (interpolated) = 1.27 W/kg

Zoom Scan (5x5x7)/Cube 0: Measurement grid: dx=8mm, dy=8mm, dz=5mm

Reference Value = 28.50 V/m; Power Drift = -0.14 dB

Peak SAR (extrapolated) = 1.43 W/kg

SAR(1 g) = 0.914 W/kg; SAR(10 g) = 0.422 W/kg

Maximum value of SAR (measured) = 1.13 W/kg

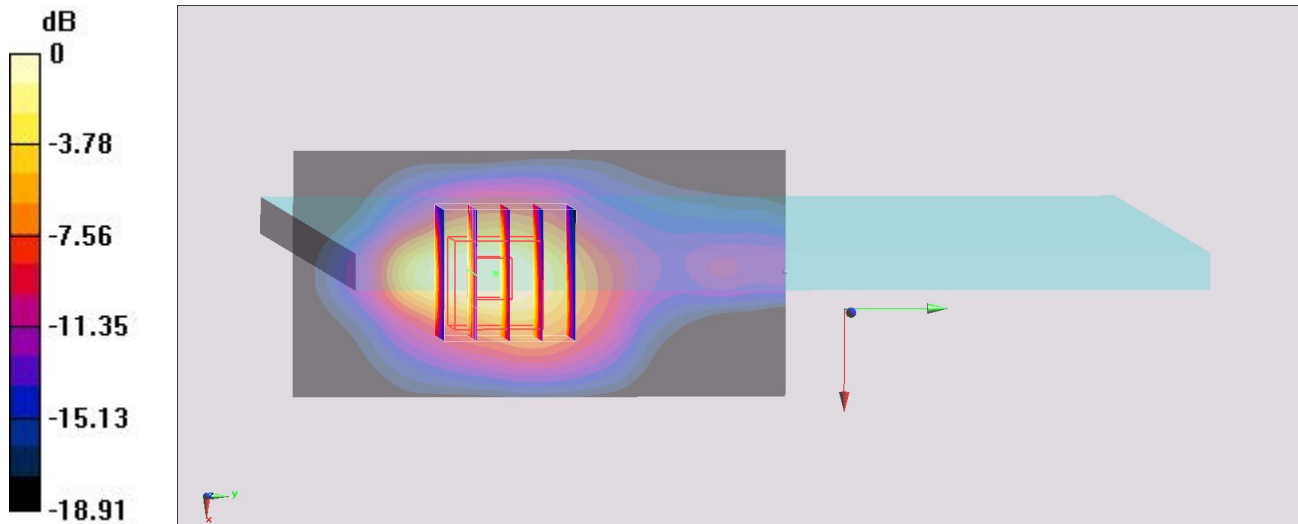

0 dB = 1.13 W/kg = 0.53 dBW/kg

#05_LTE Band 7_20M_QPSK_1_0_Bottom Face_0mm_Ch21350

Communication System: LTE; Frequency: 2560 MHz; Duty Cycle: 1:1

Medium: MSL_2600_160922 Medium parameters used: $f = 2560$ MHz; $\sigma = 2.069$ S/m; $\epsilon_r = 52.687$; $\rho = 1000$ kg/m³

Ambient Temperature : 23.4 °C; Liquid Temperature : 22.4 °C

DASY5 Configuration

- Probe: EX3DV4 - SN3820; ConvF(6.52, 6.52, 6.52); Calibrated: 2016/6/27;
- Sensor-Surface: 1.4mm (Mechanical Surface Detection)
- Electronics: DAE4 Sn679; Calibrated: 2016/6/13
- Phantom: ELI v5.0; Type: QDOVA002AA; Serial: TP:1227
- Measurement SW: DASY52, Version 52.8 (8); SEMCAD X Version 14.6.10 (7373)

Area Scan (61x71x1): Interpolated grid: dx=1.200 mm, dy=1.200 mm

Maximum value of SAR (interpolated) = 1.60 W/kg

Zoom Scan (7x7x7)/Cube 0: Measurement grid: dx=5mm, dy=5mm, dz=5mm

Reference Value = 17.55 V/m; Power Drift = -0.14 dB

Peak SAR (extrapolated) = 2.20 W/kg

SAR(1 g) = 0.946 W/kg; SAR(10 g) = 0.367 W/kg

Maximum value of SAR (measured) = 1.71 W/kg

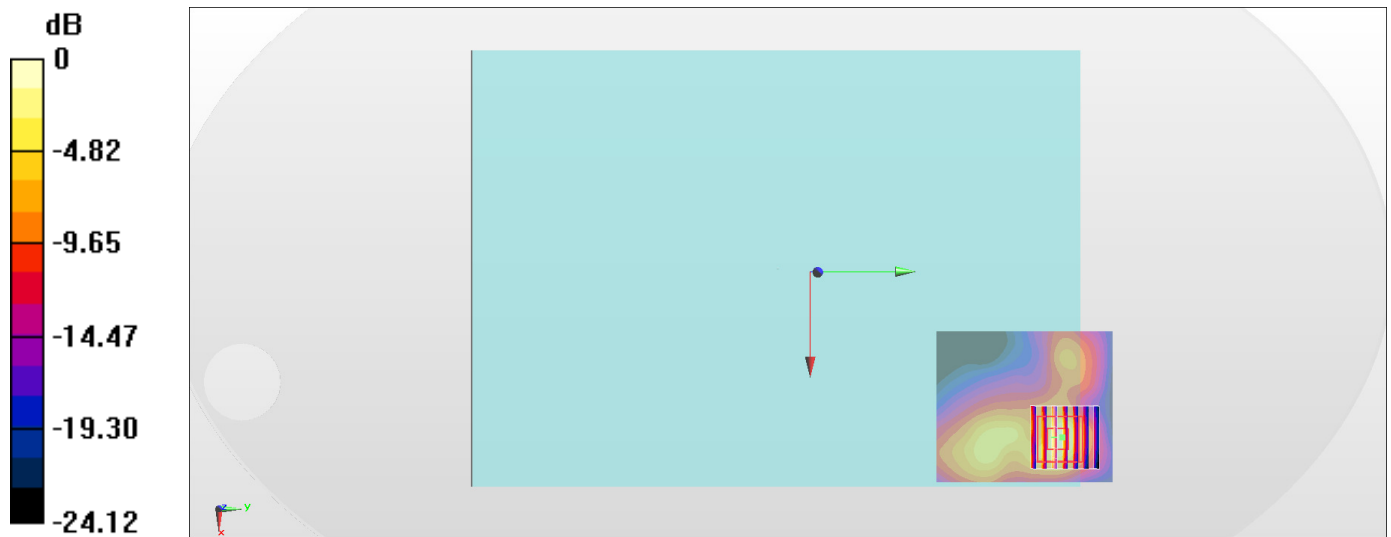

0 dB = 1.71 W/kg = 2.33 dBW/kg

#06_LTE Band 12_10M_QPSK_1_0_Bottom Face_0mm_Ch23095

Communication System: LTE ; Frequency: 707.5 MHz;Duty Cycle: 1:1

Medium: MSL_750_161001 Medium parameters used: $f = 707.5$ MHz; $\sigma = 0.917$ S/m; $\epsilon_r = 55.434$; $\rho = 1000$ kg/m³

Ambient Temperature : 23.6 °C; Liquid Temperature : 22.6 °C

DASY5 Configuration

- Probe: EX3DV4 - SN3955; ConvF(10.36, 10.36, 10.36); Calibrated: 2015/11/24;
- Sensor-Surface: 1.4mm (Mechanical Surface Detection)
- Electronics: DAE4 Sn1399; Calibrated: 2015/11/23
- Phantom: ELI v4.0; Type: QDOVA001BB; Serial: 1026
- Measurement SW: DASY52, Version 52.8 (8); SEMCAD X Version 14.6.10 (7373)

Area Scan (61x61x1): Interpolated grid: dx=1.500 mm, dy=1.500 mm

Maximum value of SAR (interpolated) = 0.977 W/kg

Zoom Scan (5x5x7)/Cube 0: Measurement grid: dx=8mm, dy=8mm, dz=5mm

Reference Value = 20.80 V/m; Power Drift = 0.14 dB

Peak SAR (extrapolated) = 1.28 W/kg

SAR(1 g) = 0.671 W/kg; SAR(10 g) = 0.393 W/kg

Maximum value of SAR (measured) = 1.02 W/kg

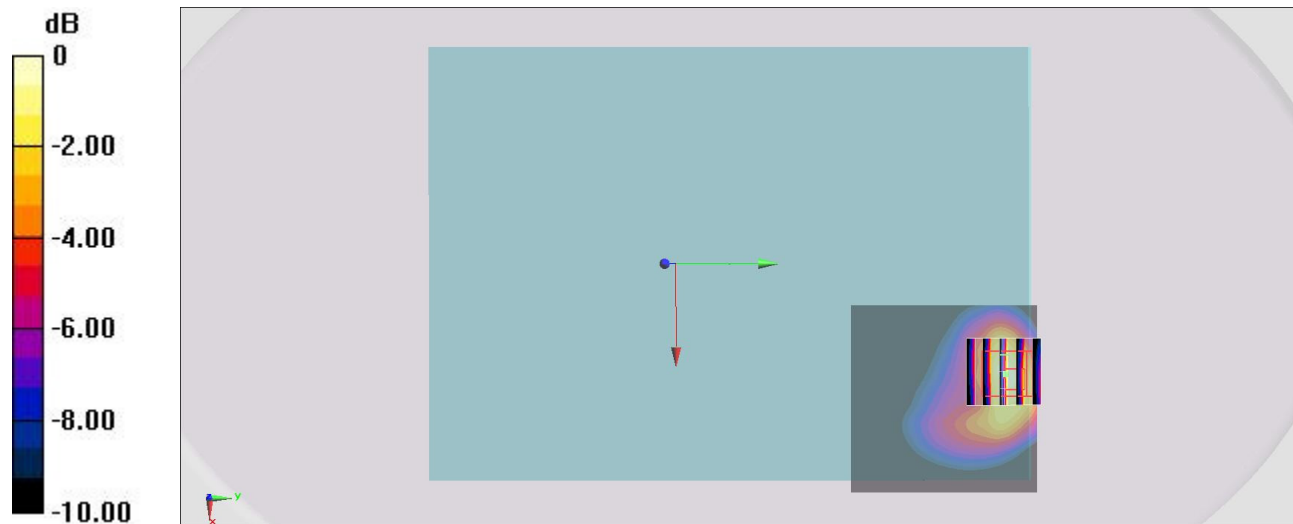

0 dB = 1.02 W/kg = 0.09 dBW/kg

#07_LTE Band 13_10M_QPSK_1_0_Bottom Face_0mm_Ch23230

Communication System: LTE ; Frequency: 782 MHz; Duty Cycle: 1:1

Medium: MSL_750_161001 Medium parameters used: $f = 782 \text{ MHz}$; $\sigma = 0.987 \text{ S/m}$; $\epsilon_r = 54.704$; $\rho = 1000 \text{ kg/m}^3$

Ambient Temperature : $23.6 \text{ }^\circ\text{C}$; Liquid Temperature : $22.6 \text{ }^\circ\text{C}$

DASY5 Configuration

- Probe: EX3DV4 - SN3955; ConvF(10.36, 10.36, 10.36); Calibrated: 2015/11/24;
- Sensor-Surface: 1.4mm (Mechanical Surface Detection)
- Electronics: DAE4 Sn1399; Calibrated: 2015/11/23
- Phantom: ELI v4.0; Type: QDOVA001BB; Serial: 1026
- Measurement SW: DASY52, Version 52.8 (8); SEMCAD X Version 14.6.10 (7373)

Area Scan (61x61x1): Interpolated grid: $dx=1.500 \text{ mm}$, $dy=1.500 \text{ mm}$

Maximum value of SAR (interpolated) = 1.44 W/kg

Zoom Scan (5x5x7)/Cube 0: Measurement grid: $dx=8\text{mm}$, $dy=8\text{mm}$, $dz=5\text{mm}$

Reference Value = 26.30 V/m ; Power Drift = -0.06 dB

Peak SAR (extrapolated) = 1.71 W/kg

SAR(1 g) = 0.961 W/kg ; SAR(10 g) = 0.584 W/kg

Maximum value of SAR (measured) = 1.32 W/kg

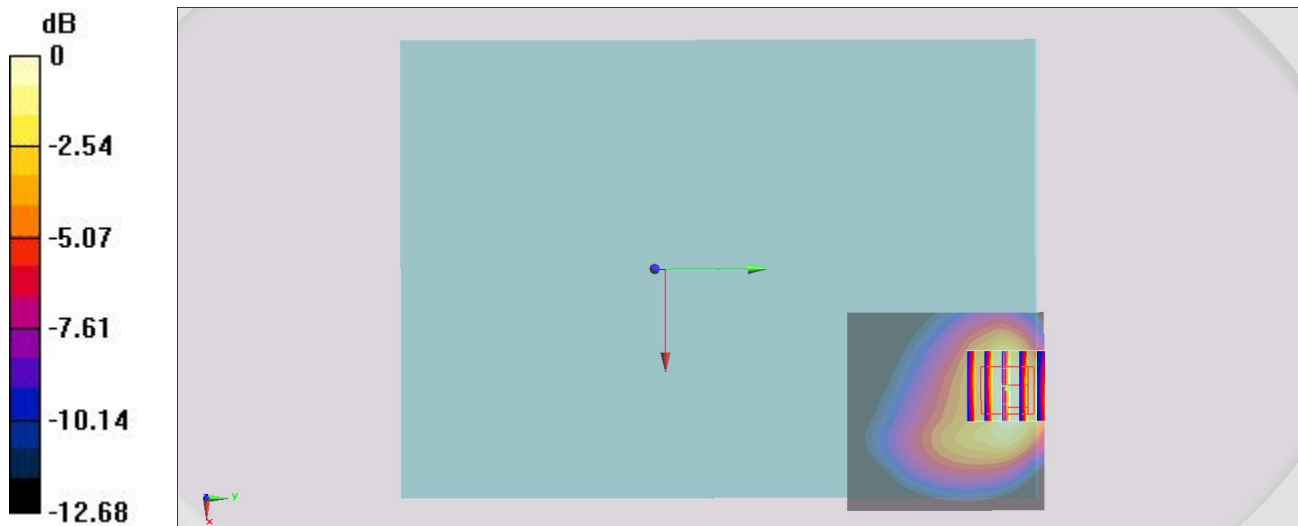

0 dB = 1.32 W/kg = 1.21 dBW/kg

#08_LTE Band 25_20M_QPSK_1_0_Edge 2_0mm_Ch26140

Communication System: LTE; Frequency: 1860 MHz; Duty Cycle: 1:1

Medium: MSL_1900_161001 Medium parameters used: $f = 1860$ MHz; $\sigma = 1.473$ S/m; $\epsilon_r = 53.709$; $\rho = 1000$ kg/m³

Ambient Temperature : 23.7 °C; Liquid Temperature : 22.7 °C

DASY5 Configuration

- Probe: EX3DV4 - SN3955; ConvF(7.89, 7.89, 7.89); Calibrated: 2015/11/24;
- Sensor-Surface: 1.4mm (Mechanical Surface Detection)
- Electronics: DAE4 Sn1399; Calibrated: 2015/11/23
- Phantom: ELI v4.0; Type: QDOVA001BB; Serial: 1026
- Measurement SW: DASY52, Version 52.8 (8); SEMCAD X Version 14.6.10 (7373)

Area Scan (41x71x1): Interpolated grid: dx=1.500 mm, dy=1.500 mm

Maximum value of SAR (interpolated) = 1.14 W/kg

Zoom Scan (5x5x7)/Cube 0: Measurement grid: dx=8mm, dy=8mm, dz=5mm

Reference Value = 27.93 V/m; Power Drift = -0.13 dB

Peak SAR (extrapolated) = 1.33 W/kg

SAR(1 g) = 0.803 W/kg; SAR(10 g) = 0.370 W/kg

Maximum value of SAR (measured) = 1.08 W/kg

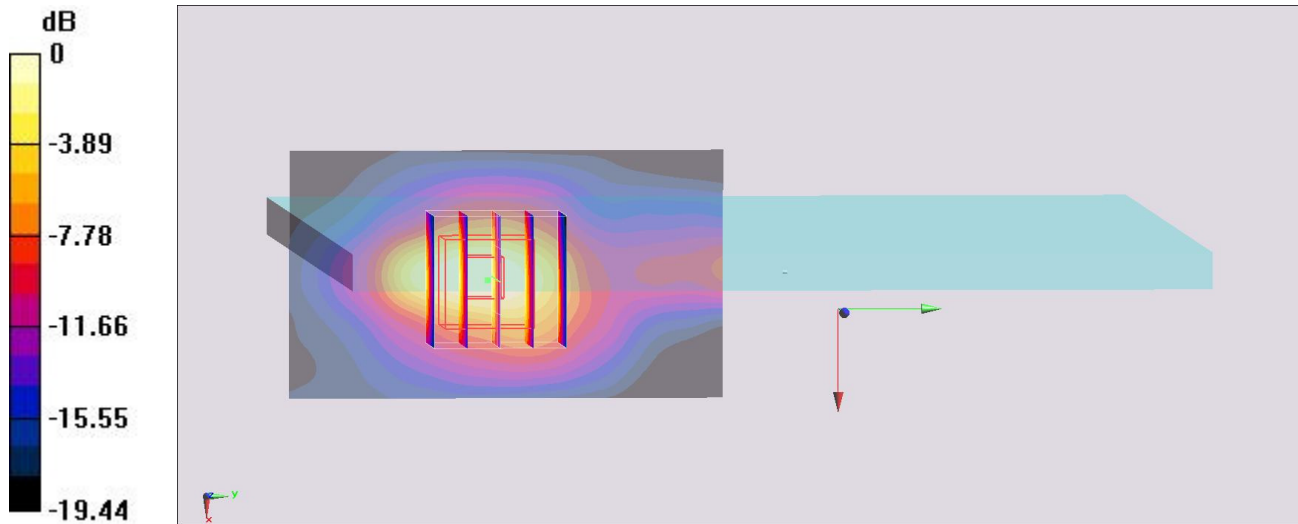

0 dB = 1.08 W/kg = 0.33 dBW/kg

#09_LTE Band 26_15M_QPSK_1_0_Bottom Face_0mm_Ch26865

Communication System: LTE ; Frequency: 831.5 MHz;Duty Cycle: 1:1

Medium: MSL_850_161001 Medium parameters used: $f = 831.5$ MHz; $\sigma = 0.982$ S/m; $\epsilon_r = 56.466$; $\rho = 1000$ kg/m³

Ambient Temperature : 23.6 °C; Liquid Temperature : 22.6 °C

DASY5 Configuration

- Probe: EX3DV4 - SN3955; ConvF(10.08, 10.08, 10.08); Calibrated: 2015/11/24;
- Sensor-Surface: 1.4mm (Mechanical Surface Detection)
- Electronics: DAE4 Sn1399; Calibrated: 2015/11/23
- Phantom: ELI v4.0; Type: QDOVA001BB; Serial: 1026
- Measurement SW: DASY52, Version 52.8 (8); SEMCAD X Version 14.6.10 (7373)

Area Scan (61x61x1): Interpolated grid: dx=1.500 mm, dy=1.500 mm

Maximum value of SAR (interpolated) = 1.31 W/kg

Zoom Scan (5x5x7)/Cube 0: Measurement grid: dx=8mm, dy=8mm, dz=5mm

Reference Value = 25.22 V/m; Power Drift = -0.16 dB

Peak SAR (extrapolated) = 1.53 W/kg

SAR(1 g) = 0.870 W/kg; SAR(10 g) = 0.525 W/kg

Maximum value of SAR (measured) = 1.19 W/kg

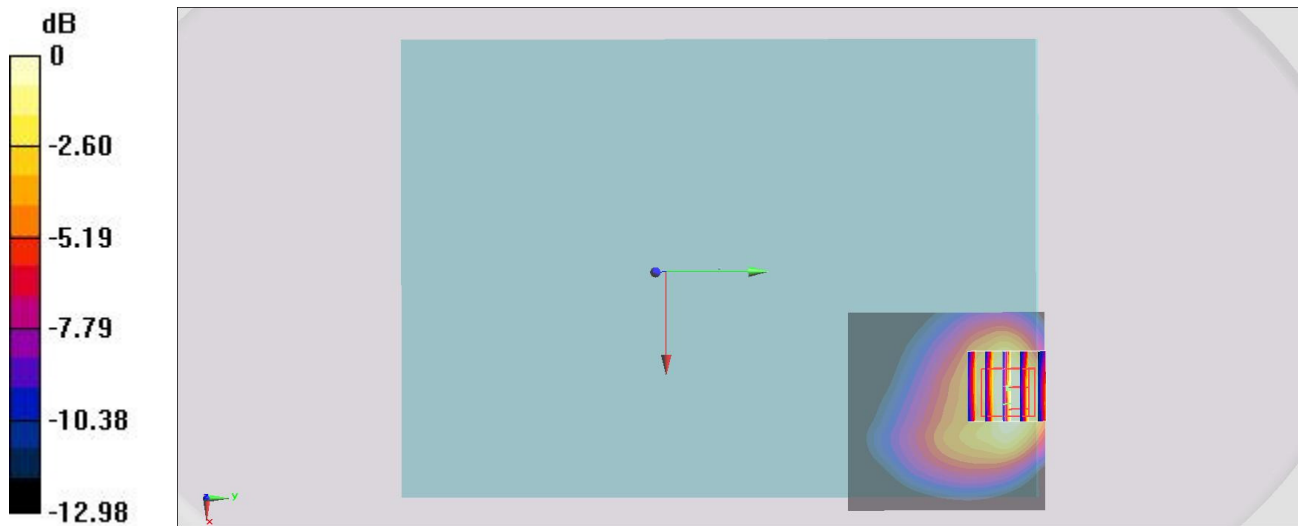

0 dB = 1.19 W/kg = 0.76 dBW/kg

#10_LTE Band 41_20M_QPSK_1_0_Bottom Face_0mm_Ch41055

Communication System: LTE-TDD; Frequency: 2636.5 MHz; Duty Cycle: 1:1.59

Medium: MSL_2600_160922 Medium parameters used: $f = 2636.5$ MHz; $\sigma = 2.175$ S/m; $\epsilon_r = 52.441$;

$\rho = 1000$ kg/m³

Ambient Temperature : 23.4 °C; Liquid Temperature : 22.4 °C

DASY5 Configuration

- Probe: EX3DV4 - SN3820; ConvF(6.52, 6.52, 6.52); Calibrated: 2016/6/27;
- Sensor-Surface: 1.4mm (Mechanical Surface Detection)
- Electronics: DAE4 Sn679; Calibrated: 2016/6/13
- Phantom: ELI v5.0; Type: QDOVA002AA; Serial: TP:1227
- Measurement SW: DASY52, Version 52.8 (8); SEMCAD X Version 14.6.10 (7373)

Area Scan (61x71x1): Interpolated grid: dx=1.200 mm, dy=1.200 mm

Maximum value of SAR (interpolated) = 1.46 W/kg

Zoom Scan (7x7x7)/Cube 0: Measurement grid: dx=5mm, dy=5mm, dz=5mm

Reference Value = 16.08 V/m; Power Drift = -0.04 dB

Peak SAR (extrapolated) = 2.01 W/kg

SAR(1 g) = 0.812 W/kg; SAR(10 g) = 0.297 W/kg

Maximum value of SAR (measured) = 1.49 W/kg

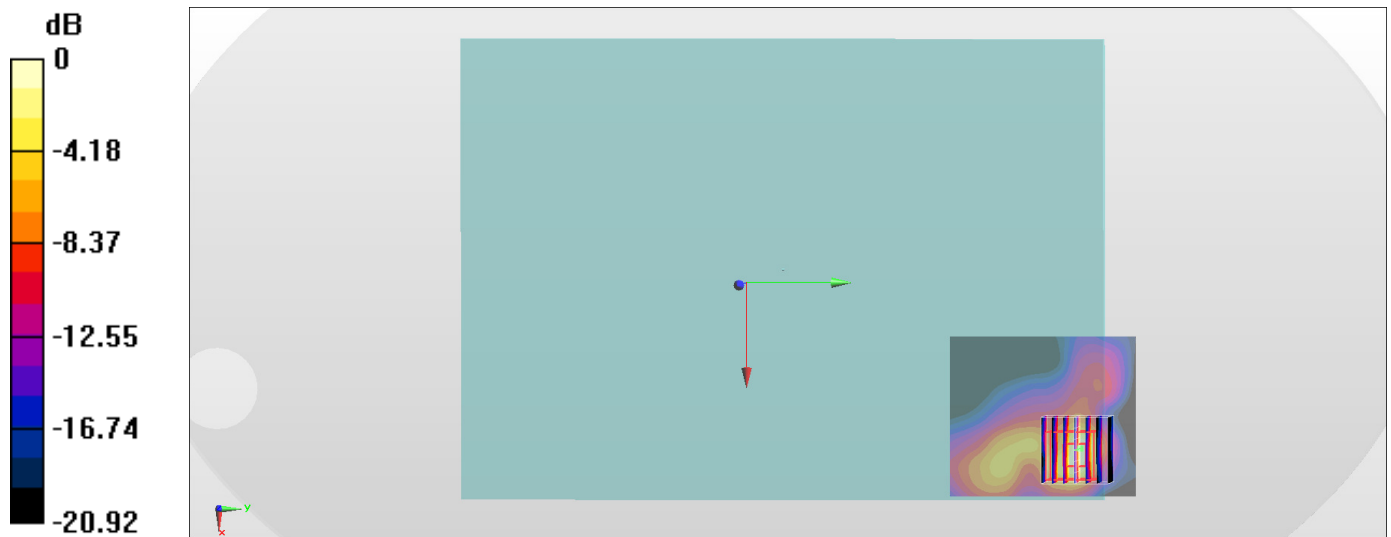

0 dB = 1.49 W/kg = 1.73 dBW/kg

#11_WLAN2.4GHz_802.11b 1Mbps_Bottom Face_0mm_Ch6;Ant 1

Communication System: 802.11b ; Frequency: 2437 MHz;Duty Cycle: 1:1.015

Medium: MSL_2450_161007 Medium parameters used : $f = 2437$ MHz; $\sigma = 1.969$ S/m; $\epsilon_r = 54.997$; $\rho = 1000$ kg/m³

Ambient Temperature : 23.3 °C; Liquid Temperature : 22.3 °C

DASY5 Configuration

- Probe: EX3DV4 - SN3955; ConvF(7.53, 7.53, 7.53); Calibrated: 2015/11/24;
- Sensor-Surface: 1.4mm (Mechanical Surface Detection)
- Electronics: DAE4 Sn1399; Calibrated: 2015/11/23
- Phantom: ELI v4.0; Type: QDOVA001BB; Serial: 1026
- Measurement SW: DASY52, Version 52.8 (8); SEMCAD X Version 14.6.10 (7373)

Area Scan (91x51x1): Interpolated grid: dx=1.200 mm, dy=1.200 mm

Maximum value of SAR (interpolated) = 1.82 W/kg

Zoom Scan (7x7x7)/Cube 0: Measurement grid: dx=5mm, dy=5mm, dz=5mm

Reference Value = 27.99 V/m; Power Drift = -0.02 dB

Peak SAR (extrapolated) = 2.40 W/kg

SAR(1 g) = 0.953 W/kg; SAR(10 g) = 0.389 W/kg

Maximum value of SAR (measured) = 1.75 W/kg

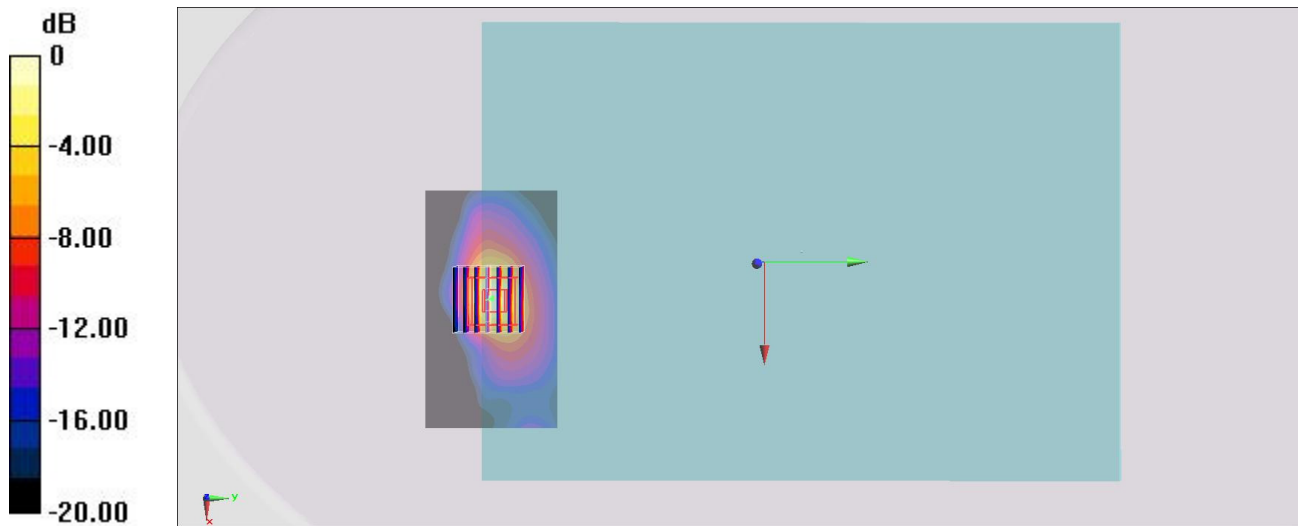

0 dB = 1.75 W/kg = 2.43 dBW/kg

#12_WLAN5GHz_802.11ac-VHT80 MCS0_Bottom Face_0mm_Ch58;Ant 1

Communication System: 802.11ac ; Frequency: 5290 MHz;Duty Cycle: 1:1.061

Medium: MSL_5G_161001 Medium parameters used: $f = 5290$ MHz; $\sigma = 5.579$ S/m; $\epsilon_r = 46.989$; $\rho = 1000$ kg/m³

Ambient Temperature : 23.5 °C; Liquid Temperature : 22.5 °C

DASY5 Configuration

- Probe: EX3DV4 - SN3925; ConvF(4.22, 4.22, 4.22); Calibrated: 2016/5/26;
- Sensor-Surface: 1.4mm (Mechanical Surface Detection)
- Electronics: DAE3 Sn495; Calibrated: 2016/5/27
- Phantom: ELI v5.0; Type: QDOVA002AA; Serial: TP:1227
- Measurement SW: DASY52, Version 52.8 (8); SEMCAD X Version 14.6.10 (7331)

Area Scan (101x81x1): Interpolated grid: dx=1.000 mm, dy=1.000 mm

Maximum value of SAR (interpolated) = 2.18 W/kg

Zoom Scan (7x7x7)/Cube 0: Measurement grid: dx=4mm, dy=4mm, dz=1.4mm

Reference Value = 15.63 V/m; Power Drift = -0.10 dB

Peak SAR (extrapolated) = 3.73 W/kg

SAR(1 g) = 0.875 W/kg; SAR(10 g) = 0.274 W/kg

Maximum value of SAR (measured) = 2.32 W/kg

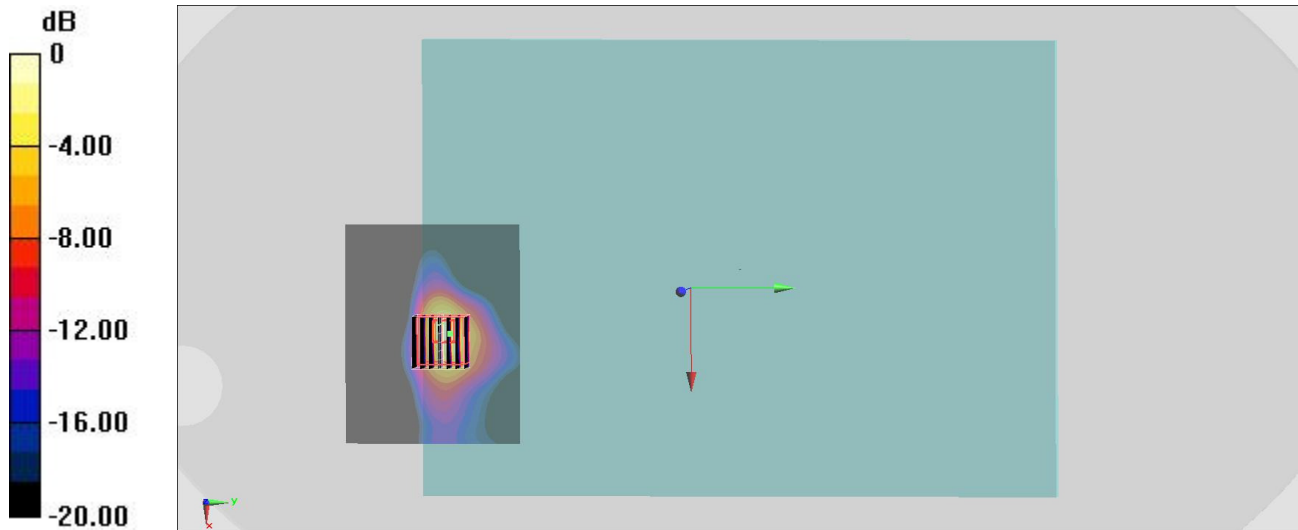

0 dB = 2.32 W/kg = 3.65 dBW/kg

#13_WLAN5GHz_802.11ac-VHT80 MCS0_Bottom Face_0mm_Ch138;Ant 2

Communication System: 802.11ac; Frequency: 5690 MHz; Duty Cycle: 1:1.070

Medium: MSL_5G_161006 Medium parameters used: $f = 5690$ MHz; $\sigma = 6.038$ S/m; $\epsilon_r = 46.552$; $\rho = 1000$ kg/m³

Ambient Temperature : 23.3 °C; Liquid Temperature : 22.3 °C

DASY5 Configuration

- Probe: EX3DV4 - SN3955; ConvF(3.81, 3.81, 3.81); Calibrated: 2015/11/24;
- Sensor-Surface: 1.4mm (Mechanical Surface Detection)
- Electronics: DAE4 Sn1399; Calibrated: 2015/11/23
- Phantom: ELI v4.0; Type: QDOVA001BB; Serial: 1026
- Measurement SW: DASY52, Version 52.8 (8); SEMCAD X Version 14.6.10 (7373)

Area Scan (61x101x1): Interpolated grid: dx=1.000 mm, dy=1.000 mm

Maximum value of SAR (interpolated) = 3.21 W/kg

Zoom Scan (9x8x7)/Cube 0: Measurement grid: dx=4mm, dy=4mm, dz=1.4mm

Reference Value = 16.69 V/m; Power Drift = -0.02 dB

Peak SAR (extrapolated) = 5.31 W/kg

SAR(1 g) = 1.05 W/kg; SAR(10 g) = 0.324 W/kg

Maximum value of SAR (measured) = 3.05 W/kg

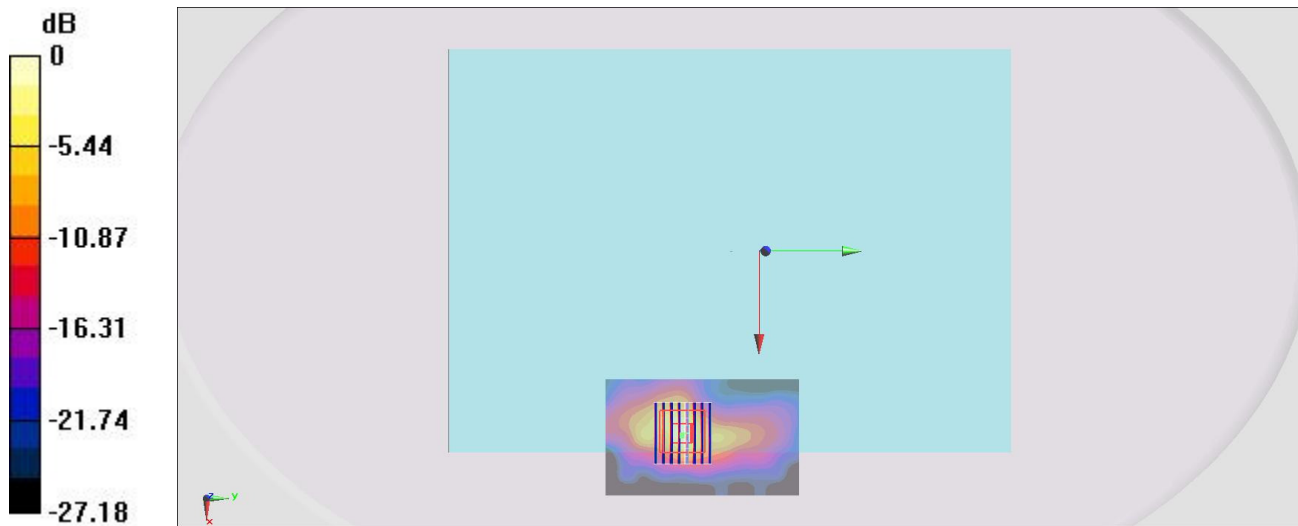

0 dB = 3.05 W/kg = 4.84 dBW/kg

#14_WLAN5GHz_802.11n-HT40 MCS0_Bottom Face_0mm_Ch159;Ant 1

Communication System: 802.11n; Frequency: 5795 MHz; Duty Cycle: 1:1.032

Medium: MSL_5G_161006 Medium parameters used: $f = 5795$ MHz; $\sigma = 6.178$ S/m; $\epsilon_r = 46.381$; $\rho = 1000$ kg/m³

Ambient Temperature : 23.3 °C; Liquid Temperature : 22.3 °C

DASY5 Configuration

- Probe: EX3DV4 - SN3955; ConvF(3.92, 3.92, 3.92); Calibrated: 2015/11/24;
- Sensor-Surface: 1.4mm (Mechanical Surface Detection)
- Electronics: DAE4 Sn1399; Calibrated: 2015/11/23
- Phantom: ELI v4.0; Type: QDOVA001BB; Serial: 1026
- Measurement SW: DASY52, Version 52.8 (8); SEMCAD X Version 14.6.10 (7373)

Area Scan (51x41x1): Interpolated grid: dx=1.000 mm, dy=1.000 mm

Maximum value of SAR (interpolated) = 2.28 W/kg

Zoom Scan (7x7x7)/Cube 0: Measurement grid: dx=4mm, dy=4mm, dz=1.4mm

Reference Value = 14.95 V/m; Power Drift = 0.07 dB

Peak SAR (extrapolated) = 6.77 W/kg

SAR(1 g) = 1.01 W/kg; SAR(10 g) = 0.306 W/kg

Maximum value of SAR (measured) = 2.69 W/kg

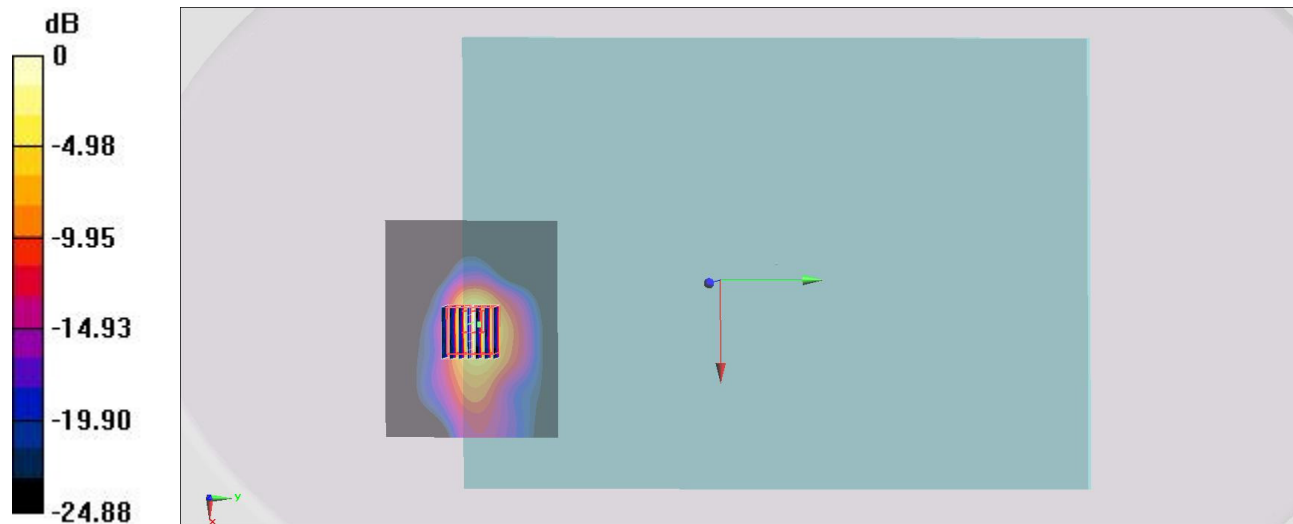

0 dB = 2.69 W/kg = 4.30 dBW/kg

#15_Bluetooth_1Mbps_Bottom Face_0mm_Ch39;Ant 2

Communication System: Bluetooth; Frequency: 2441 MHz; Duty Cycle: 1:1.31

Medium: MSL_2450_161018 Medium parameters used: $f = 2441$ MHz; $\sigma = 1.934$ S/m; $\epsilon_r = 53.083$; $\rho = 1000$ kg/m³

Ambient Temperature : 23.3 °C; Liquid Temperature : 22.3 °C

DASY5 Configuration

- Probe: EX3DV4 - SN3955; ConvF(7.53, 7.53, 7.53); Calibrated: 2015/11/24;
- Sensor-Surface: 1.4mm (Mechanical Surface Detection)
- Electronics: DAE4 Sn1399; Calibrated: 2015/11/23
- Phantom: ELI v4.0; Type: QDOVA001BB; Serial: 1026
- Measurement SW: DASY52, Version 52.8 (8); SEMCAD X Version 14.6.10 (7373)

Area Scan (61x91x1): Interpolated grid: dx=1.200 mm, dy=1.200 mm

Maximum value of SAR (interpolated) = 0.101 W/kg

Zoom Scan (7x7x7)/Cube 0: Measurement grid: dx=5mm, dy=5mm, dz=5mm

Reference Value = 5.023 V/m; Power Drift = -0.04 dB

Peak SAR (extrapolated) = 0.140 W/kg

SAR(1 g) = 0.053 W/kg; SAR(10 g) = 0.027 W/kg

Maximum value of SAR (measured) = 0.106 W/kg

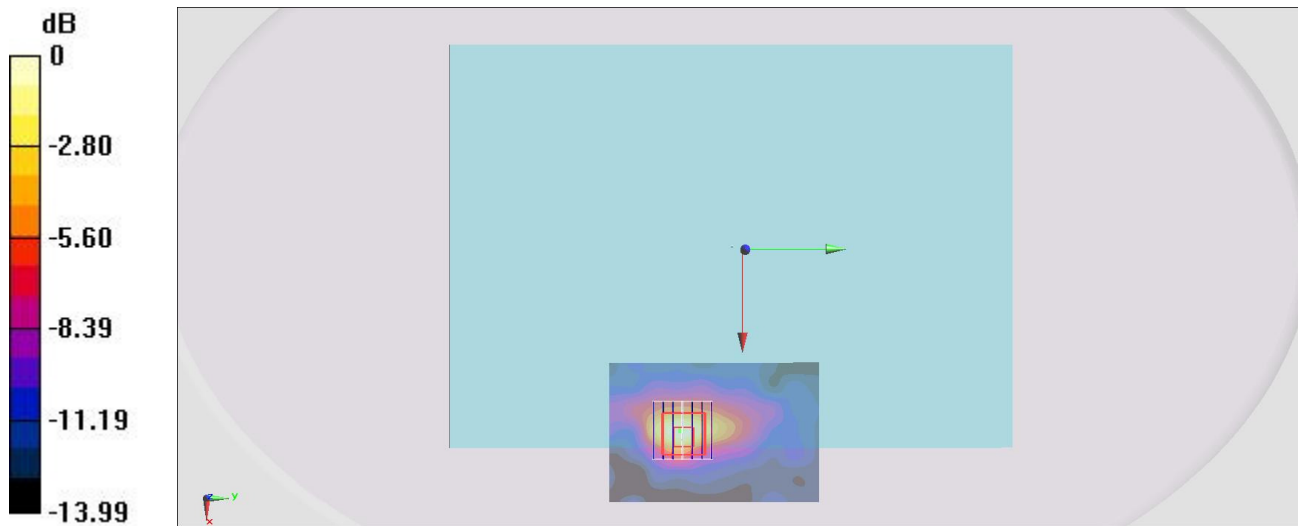

0 dB = 0.106 W/kg = -9.75 dBW/kg