

EMC Test Report

Application for Grant of Equipment Authorization

Industry Canada RSS-Gen Issue 3 / RSS 210 Issue 8 FCC Part 15 Subpart C

Models: 7265D2W and 7265D2W AN

IC CERTIFICATION #: 1000M-7265D2
FCC ID: PD97265D2

APPLICANT: Intel Mobile Communications
100 Center Point Circle, Suite 200
Columbia, SC 23210, USA

TEST SITE(S): National Technical Systems - Silicon Valley
41039 Boyce Road.
Fremont, CA. 94538-2435

IC SITE REGISTRATION #: 2845B-3; 2845B-4, 2845B-5, 2845B-7

REPORT DATE: July 9, 2014

FINAL TEST DATES: June 12 through 20, 2014

TOTAL NUMBER OF PAGES: 97

PROGRAM MGR /
TECHNICAL REVIEWER:



David W. Bare
Chief Engineer

QUALITY ASSURANCE DELEGATE /
FINAL REPORT PREPARER:



David Guidotti
Senior Technical Writer



National Technical Systems - Silicon Valley is accredited by the A2LA, certificate number 0214.26, to perform the test(s) listed in this report, except where noted otherwise. This report and the information contained herein represent the results of testing test articles identified and selected by the client performed to specifications and/or procedures selected by the client. National Technical Systems (NTS) makes no representations, expressed or implied, that such testing is adequate (or inadequate) to demonstrate efficiency, performance, reliability, or any other characteristic of the articles being tested, or similar products. This report should not be relied upon as an endorsement or certification by NTS of the equipment tested, nor does it represent any statement whatsoever as to its merchantability or fitness of the test article, or similar products, for a particular purpose. This report shall not be reproduced except in full

REVISION HISTORY

Rev#	Date	Comments	Modified By
-	July 9, 2014	First release	

TABLE OF CONTENTS

REVISION HISTORY2

TABLE OF CONTENTS3

SCOPE.....4

OBJECTIVE5

STATEMENT OF COMPLIANCE.....5

DEVIATIONS FROM THE STANDARDS.....5

TEST RESULTS SUMMARY6

 FREQUENCY HOPPING SPREAD SPECTRUM (2400 – 2483.5 MHz)6

 GENERAL REQUIREMENTS APPLICABLE TO ALL BANDS6

 MEASUREMENT UNCERTAINTIES7

EQUIPMENT UNDER TEST (EUT) DETAILS.....8

 GENERAL.....8

 ANTENNA SYSTEM8

 ENCLOSURE.....8

 MODIFICATIONS.....8

 SUPPORT EQUIPMENT8

 EUT INTERFACE PORTS9

 EUT OPERATION9

TEST SITE.....10

 GENERAL INFORMATION10

 CONDUCTED EMISSIONS CONSIDERATIONS10

 RADIATED EMISSIONS CONSIDERATIONS10

MEASUREMENT INSTRUMENTATION11

 RECEIVER SYSTEM11

 INSTRUMENT CONTROL COMPUTER11

 LINE IMPEDANCE STABILIZATION NETWORK (LISN).....11

 FILTERS/ATTENUATORS12

 ANTENNAS.....12

 ANTENNA MAST AND EQUIPMENT TURNTABLE12

 INSTRUMENT CALIBRATION.....12

TEST PROCEDURES13

 EUT AND CABLE PLACEMENT13

 CONDUCTED EMISSIONS.....13

 RADIATED EMISSIONS.....14

 CONDUCTED EMISSIONS FROM ANTENNA PORT16

 BANDWIDTH MEASUREMENTS16

 SPECIFICATION LIMITS AND SAMPLE CALCULATIONS17

 CONDUCTED EMISSIONS SPECIFICATION LIMITS: FCC 15.207; FCC 15.107(A), RSS GEN17

 GENERAL TRANSMITTER RADIATED EMISSIONS SPECIFICATION LIMITS18

 OUTPUT POWER LIMITS – FHSS SYSTEMS18

 TRANSMIT MODE SPURIOUS RADIATED EMISSIONS LIMITS – FHSS AND DTS SYSTEMS.....18

 SAMPLE CALCULATIONS - CONDUCTED EMISSIONS19

 SAMPLE CALCULATIONS - RADIATED EMISSIONS.....19

 SAMPLE CALCULATIONS - FIELD STRENGTH TO EIRP CONVERSION.....20

APPENDIX A TEST EQUIPMENT CALIBRATION DATA21

APPENDIX B TEST DATA23

END OF REPORT97

SCOPE

An electromagnetic emissions test has been performed on the Intel Mobile Communications model 7265D2W, pursuant to the following rules:

Industry Canada RSS-Gen Issue 3

RSS 210 Issue 8 “Low-power Licence-exempt Radiocommunication Devices (All Frequency Bands): Category I Equipment”

FCC Part 15 Subpart C

Conducted and radiated emissions data has been collected, reduced, and analyzed within this report in accordance with measurement guidelines set forth in the following reference standards and as outlined in National Technical Systems - Silicon Valley test procedures:

ANSI C63.10-2009

FCC FHSS test procedure DA 00-0705A1

The intentional radiator above has been tested in a simulated typical installation to demonstrate compliance with the relevant Industry Canada performance and procedural standards.

Final system data was gathered in a mode that tended to maximize emissions by varying orientation of EUT, orientation of power and I/O cabling, antenna search height, and antenna polarization.

Every practical effort was made to perform an impartial test using appropriate test equipment of known calibration. All pertinent factors have been applied to reach the determination of compliance.

OBJECTIVE

The primary objective of the manufacturer is compliance with the regulations outlined in the previous section.

Prior to marketing in the USA, all unlicensed transmitters and transceivers require certification. Receive-only devices operating between 30 MHz and 960 MHz are subject to either certification or a manufacturer's declaration of conformity, with all other receive-only devices exempt from the technical requirements.

Prior to marketing in Canada, Class I transmitters, receivers and transceivers require certification. Class II devices are required to meet the appropriate technical requirements but are exempt from certification requirements.

Certification is a procedure where the manufacturer submits test data and technical information to a certification body and receives a certificate or grant of equipment authorization upon successful completion of the certification body's review of the submitted documents. Once the equipment authorization has been obtained, the label indicating compliance must be attached to all identical units, which are subsequently manufactured.

Testing was performed only on model 7265D2W. This model was considered representative of the following models.

7265D2W and 7265D2W AN

STATEMENT OF COMPLIANCE

The tested sample of Intel Mobile Communications model 7265D2W complied with the requirements of the following regulations:

- Industry Canada RSS-Gen Issue 3
- RSS 210 Issue 8 "Low-power Licence-exempt Radiocommunication Devices (All Frequency Bands): Category I Equipment"
- FCC Part 15 Subpart C

Maintenance of compliance is the responsibility of the manufacturer. Any modifications to the product should be assessed to determine their potential impact on the compliance status of the device with respect to the standards detailed in this test report.

The test results recorded herein are based on a single type test of Intel Mobile Communications model 7265D2W and therefore apply only to the tested sample. The sample was selected and prepared by Steven Hackett of Intel Mobile Communications.

DEVIATIONS FROM THE STANDARDS

No deviations were made from the published requirements listed in the scope of this report.

TEST RESULTS SUMMARY**FREQUENCY HOPPING SPREAD SPECTRUM (2400 – 2483.5 MHz)**

FCC Rule Part	RSS Rule Part	Description	Measured Value / Comments	Limit / Requirement	Result
15.247 (a) (1)	RSS 210 A8.1 (1)	20dB Bandwidth	Basic rate: 982 kHz EDR: 1.48 MHz	Channel spacing > 2/3 of the 20dB bandwidth	Complies
		Channel Separation	1000 kHz		Complies
15.247 (a) (1) (iii)	RSS 210 A8.1 (4)	Channel Dwell Time (average time of occupancy)	0.4 seconds per 31.6 seconds for 79 channels	<=0.4 second within a period of 0.4 x number of channels	Complies
15.247 (a) (1) (iii)	RSS 210 A8.1 (4)	Number of Channels	20-79	Minimum of 15	Complies
15.247 (a) (1)	RSS 210 A8.1 (1)	Channel Utilization	The system uses the Bluetooth algorithm and, therefore, meets all requirements for channel utilization.	All channels shall, on average, be used equally	Complies
15.247 (b) (3)	RSS 210 A8.4 (2)	Output Power (multipoint systems)	Basic rate: 5.1 dBm EDR: 1.8 dBm EIRP = 0.007 W ^{Note 1}	1Watt, EIRP limited to 4 Watts.	Complies
15.247(c)	RSS 210 A8.5	Spurious Emissions – 30MHz – 25GHz	All spurious emissions < -20dBc	< -20dBc	Complies
15.247(c) / 15.209	RSS 210 A8.5 Table 2, 3	Radiated Spurious Emissions 30MHz – 25GHz	46.1 dBµV/m @ 2366.1 MHz (-7.9 dB)	15.207 in restricted bands, all others < -20dBc	Complies
15.247 (a) (1)	RSS 210 A8.1(2)	Receiver bandwidth	Refer to operational description (Bluetooth FHSS description) page 2	Shall match the channel bandwidth	Complies
Note 1: EIRP calculated using antenna gain of 3.2 dBi					

GENERAL REQUIREMENTS APPLICABLE TO ALL BANDS

FCC Rule Part	RSS Rule part	Description	Measured Value / Comments	Limit / Requirement	Result (margin)
15.203	-	RF Connector	Unique iPex-4 connector	Unique or integral antenna required	Complies
15.207	RSS GEN Table 4	AC Conducted Emissions	62.0 dBµV @ 0.152 MHz (-3.9 dB)	Refer to page 17	Complies
15.247 (b) (5) 15.407 (f)	RSS 102	RF Exposure Requirements	Refer to SAR report and RSS 102 declaration and User Manual statements.	Refer to OET 65, FCC Part 1 and RSS 102	Complies
-	RSP 100 RSS GEN 7.1.3	User Manual	Refer to User Manual, Page 17	Statement required regarding non- interference	Complies
-	RSP 100 RSS GEN 7.1.2	User Manual	Refer to User Manual page 12	Statement for products with detachable antenna	Complies

MEASUREMENT UNCERTAINTIES

ISO/IEC 17025 requires that an estimate of the measurement uncertainties associated with the emissions test results be included in the report. The measurement uncertainties given below are based on a 95% confidence level and were calculated in accordance with UKAS document LAB 34.

Measurement Type	Measurement Unit	Frequency Range	Expanded Uncertainty
RF power, conducted (power meter)	dBm	25 to 7000 MHz	± 0.52 dB
RF power, conducted (Spectrum analyzer)	dBm	25 to 7000 MHz	± 0.7 dB
Conducted emission of transmitter	dBm	25 to 26500 MHz	± 0.7 dB
Conducted emission of receiver	dBm	25 to 26500 MHz	± 0.7 dB
Radiated emission (substitution method)	dBm	25 to 26500 MHz	± 2.5 dB
Radiated emission (field strength)	dB μ V/m	25 to 1000 MHz	± 3.6 dB
		1000 to 40000 MHz	± 6.0 dB
Conducted Emissions (AC Power)	dB μ V	0.15 to 30 MHz	± 2.4 dB

EQUIPMENT UNDER TEST (EUT) DETAILS**GENERAL**

The Intel Mobile Communications model 7265D2W and 7265D2W AN is a 2x2 Wi-Fi and Bluetooth radio module which supports 802.11abgnac in 2x2 (MIMO) and 1x1 (SISO) modes & BT 4.0 (Basic rate, EDR and BLE modes). Since the EUT would be placed on a tabletop during operation, the EUT was treated as tabletop equipment during testing to simulate the end-user environment. The electrical rating of the EUT is 3.3 VDC.

The sample was received on June 5, 2014 and tested on June 12 through 20, 2014. The EUT consisted of the following component(s):

Manufacturer	Model	Description	Serial Number	FCC and Canada IDs
Intel Mobile Communications	7265D2W	M.2 Card form factor Bluetooth / IEEE 802.11a/b/g/n/ac wireless network adapter	00:15:00:F1:5B:5D or 00:15:00:F1:5B:3A	PD97265D2 1000M-7265D2

ANTENNA SYSTEM

The EUT antenna is a two-antenna PIFA antenna system – Shanghai Universe Communication Electron Co., Ltd. One or both antennas are used for WiFi operation and one for Bluetooth operation. For Bluetooth: Tx is chain B, Rx is chain B. For WiFi, only Chain A is used for transmit in the 2.4GHz band when Bluetooth is active, both chains can be used in 5GHz bands.

ENCLOSURE

The EUT has no enclosure. It is designed to be installed within the enclosure of a host computer.

MODIFICATIONS

No modifications were made to the EUT during the time the product was at NTS Silicon Valley.

SUPPORT EQUIPMENT

The following equipment was used as support equipment for testing:

Company	Model	Description	Serial Number	FCC ID
Dell	DCCY	Desktop computer	BJYN64J	-
Hanns G	HX191DPBUFLF6	LCD monitor	017GR3XY00286	-
Logitech	5680157	Mouse	LNA20956449	-
Intel	NGFF Extension REV 01	Extension Board	4164912-200	-

EUT INTERFACE PORTS

The I/O cabling configuration during testing was as follows:

Port	Connected To	Description	Cable(s)	
			Shielded or Unshielded	Length(m)
Antenna (x2)	Antenna	RF cable	Shielded	0.3
Desktop Mini PCIe Slot	Extension Board	Ribbon	Unshielded	0.8
Desktop USB	Extension Board	Multiwire	Unshielded	1.2
Desktop AC power supply	AC Main	power cable	Unshielded	2.3
Power (test fixture)	Computer	Multiwire	Unshielded	1.5
Desktop USB	Keyboard	Multiwire	Shielded	1.0
Desktop USB	Mouse	Multiwire	Shielded	1.0
Desktop Display	Monitor	Multiwire	Shielded	1.0

EUT OPERATION

During emissions testing the EUT was transmitting on the frequency & at the power level selected in the proprietary DRTU control software.

TEST SITE**GENERAL INFORMATION**

Final test measurements were taken at the test sites listed below. Pursuant to section 2.948 of the FCC's Rules and section 3.3 of RSP-100, construction, calibration, and equipment data has been filed with the Commission and with industry Canada.

Site	Designation / Registration Numbers		Location
	FCC	Canada	
Chamber 3	US0027	2845B-3	41039 Boyce Road Fremont, CA 94538-2435
Chamber 4	US0027	2845B-4	
Chamber 5	US0027	2845B-5	
Chamber 7	US0027	2845B-7	

ANSI C63.4 recommends that ambient noise at the test site be at least 6 dB below the allowable limits. Ambient levels are below this requirement. The test site(s) contain separate areas for radiated and conducted emissions testing. Considerable engineering effort has been expended to ensure that the facilities conform to all pertinent requirements of ANSI C63.4.

CONDUCTED EMISSIONS CONSIDERATIONS

Conducted emissions testing is performed in conformance with ANSI C63.10. Measurements are made with the EUT connected to the public power network through a nominal, standardized RF impedance, which is provided by a line impedance stabilization network, known as a LISN. A LISN is inserted in series with each current-carrying conductor in the EUT power cord.

RADIATED EMISSIONS CONSIDERATIONS

The FCC has determined that radiation measurements made in a shielded enclosure are not suitable for determining levels of radiated emissions. Radiated measurements are performed in an open field environment or in a semi-anechoic chamber. The test sites are maintained free of conductive objects within the CISPR defined elliptical area incorporated in ANSI C63.4 guidelines and meet the Normalized Site Attenuation (NSA) requirements of ANSI C63.4.

MEASUREMENT INSTRUMENTATION

RECEIVER SYSTEM

An EMI receiver as specified in CISPR 16-1-1 is used for emissions measurements. The receivers used can measure over the frequency range of 9 kHz up to 2000 MHz. These receivers allow both ease of measurement and high accuracy to be achieved. The receivers have Peak, Average, and CISPR (Quasi-peak) detectors built into their design so no external adapters are necessary. The receiver automatically sets the required bandwidth for the CISPR detector used during measurements. If the repetition frequency of the signal being measured is below 20Hz, peak measurements are made in lieu of Quasi-Peak measurements.

For measurements above the frequency range of the receivers, a spectrum analyzer is utilized because it provides visibility of the entire spectrum along with the precision and versatility required to support engineering analysis. Average measurements above 1000MHz are performed on the spectrum analyzer using the linear-average method with a resolution bandwidth of 1 MHz and a video bandwidth of 10 Hz, unless the signal is pulsed in which case the average (or video) bandwidth of the measuring instrument is reduced to onset of pulse desensitization and then increased.

INSTRUMENT CONTROL COMPUTER

The receivers utilize either a Rohde & Schwarz EZM Spectrum Monitor/Controller or contain an internal Spectrum Monitor/Controller to view and convert the receiver measurements to the field strength at an antenna or voltage developed at the LISN measurement port, which is then compared directly with the appropriate specification limit. This provides faster, more accurate readings by performing the conversions described under Sample Calculations within the Test Procedures section of this report. Results are printed in a graphic and/or tabular format, as appropriate. A personal computer is used to record all measurements made with the receivers.

The Spectrum Monitor provides a visual display of the signal being measured. In addition, the controller or a personal computer run automated data collection programs which control the receivers. This provides added accuracy since all site correction factors, such as cable loss and antenna factors are added automatically.

LINE IMPEDANCE STABILIZATION NETWORK (LISN)

Line conducted measurements utilize a fifty microhenry Line Impedance Stabilization Network as the monitoring point. The LISN used also contains a 250 uH CISPR adapter. This network provides for calibrated radio frequency noise measurements by the design of the internal low pass and high pass filters on the EUT and measurement ports, respectively.

FILTERS/ATTENUATORS

External filters and precision attenuators are often connected between the receiving antenna or LISN and the receiver. This eliminates saturation effects and non-linear operation due to high amplitude transient events.

ANTENNAS

A loop antenna is used below 30 MHz. For the measurement range 30 MHz to 1000 MHz either a combination of a biconical antenna and a log periodic or a bi-log antenna is used. Above 1000 MHz, horn antennas are used. The antenna calibration factors to convert the received voltage to an electric field strength are included with appropriate cable loss and amplifier gain factors to determine an overall site factor, which is then programmed into the test receivers or incorporated into the test software.

ANTENNA MAST AND EQUIPMENT TURNTABLE

The antennas used to measure the radiated electric field strength are mounted on a non-conductive antenna mast equipped with a motor-drive to vary the antenna height. Measurements below 30 MHz are made with the loop antenna at a fixed height of 1m above the ground plane.

ANSI C63.10 specifies that the test height above ground for table mounted devices shall be 80 centimeters. Floor mounted equipment shall be placed on the ground plane if the device is normally used on a conductive floor or separated from the ground plane by insulating material from 3 to 12 mm if the device is normally used on a non-conductive floor as specified in ANSI C63.4. During radiated measurements, the EUT is positioned on a motorized turntable in conformance with this requirement.

INSTRUMENT CALIBRATION

All test equipment is regularly checked to ensure that performance is maintained in accordance with the manufacturer's specifications. All antennas are calibrated at regular intervals with respect to tuned half-wave dipoles. An exhibit of this report contains the list of test equipment used and calibration information.

TEST PROCEDURES

EUT AND CABLE PLACEMENT

The regulations require that interconnecting cables be connected to the available ports of the unit and that the placement of the unit and the attached cables simulate the worst case orientation that can be expected from a typical installation, so far as practicable. To this end, the position of the unit and associated cabling is varied within the guidelines of ANSI C63.10, and the worst-case orientation is used for final measurements.

CONDUCTED EMISSIONS

Conducted emissions are measured at the plug end of the power cord supplied with the EUT. Excess power cord length is wrapped in a bundle between 30 and 40 centimeters in length near the center of the cord. Preliminary measurements are made to determine the highest amplitude emission relative to the specification limit for all the modes of operation. Placement of system components and varying of cable positions are performed in each mode. A final peak mode scan is then performed in the position and mode for which the highest emission was noted on all current carrying conductors of the power cord.

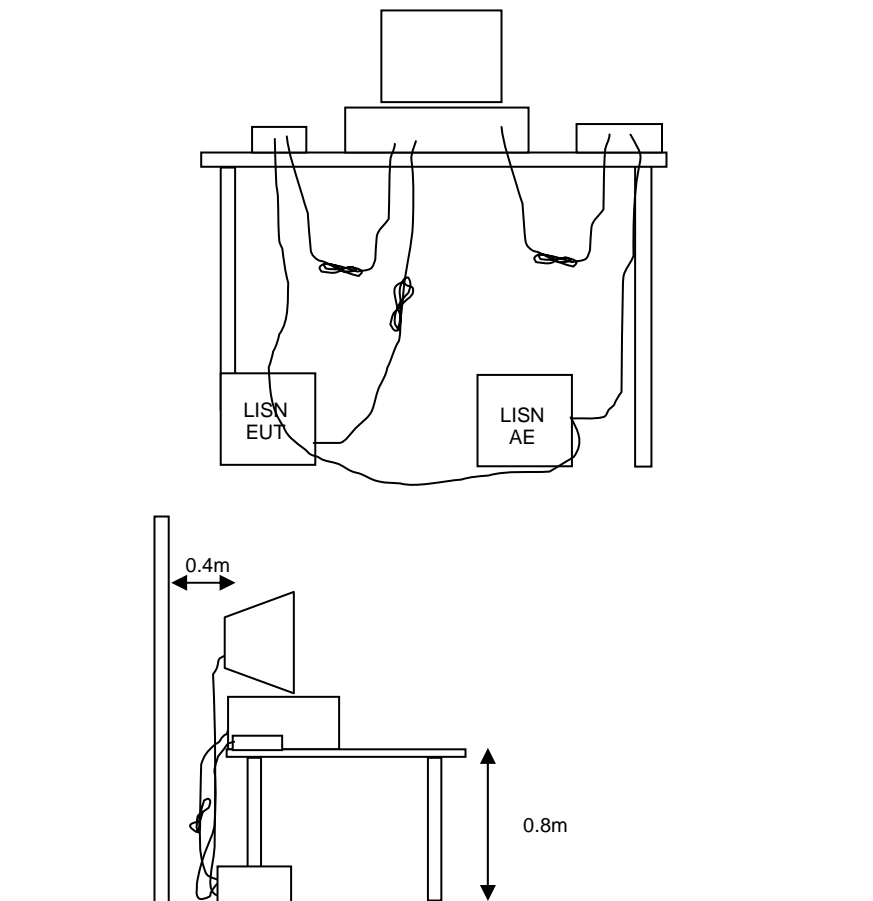

Figure 1 Typical Conducted Emissions Test Configuration

RADIATED EMISSIONS

A preliminary scan of the radiated emissions is performed in which all significant EUT frequencies are identified with the system in a nominal configuration. At least two scans are performed, one scan for each antenna polarization (horizontal and vertical; loop parallel and perpendicular to the EUT). During the preliminary scans, the EUT is rotated through 360°, the antenna height is varied (for measurements above 30 MHz) and cable positions are varied to determine the highest emission relative to the limit. Preliminary scans may be performed in a fully anechoic chamber for the purposes of identifying the frequencies of the highest emissions from the EUT.

A speaker is provided in the receiver to aid in discriminating between EUT and ambient emissions. Other methods used during the preliminary scan for EUT emissions involve scanning with near field magnetic loops, monitoring I/O cables with RF current clamps, and cycling power to the EUT.

Final maximization is a phase in which the highest amplitude emissions identified in the spectral search are viewed while the EUT azimuth angle is varied from 0 to 360 degrees relative to the receiving antenna. The azimuth, which results in the highest emission is then maintained while varying the antenna height from one to four meters (for measurements above 30 MHz, measurements below 30 MHz are made with the loop antenna at a fixed height of 1m). The result is the identification of the highest amplitude for each of the highest peaks. Each recorded level is corrected in the receiver using appropriate factors for cables, connectors, antennas, and preamplifier gain.

When testing above 18 GHz, the receive antenna is located at 1 meter from the EUT and the antenna height is restricted to a maximum of 2.5 meters.

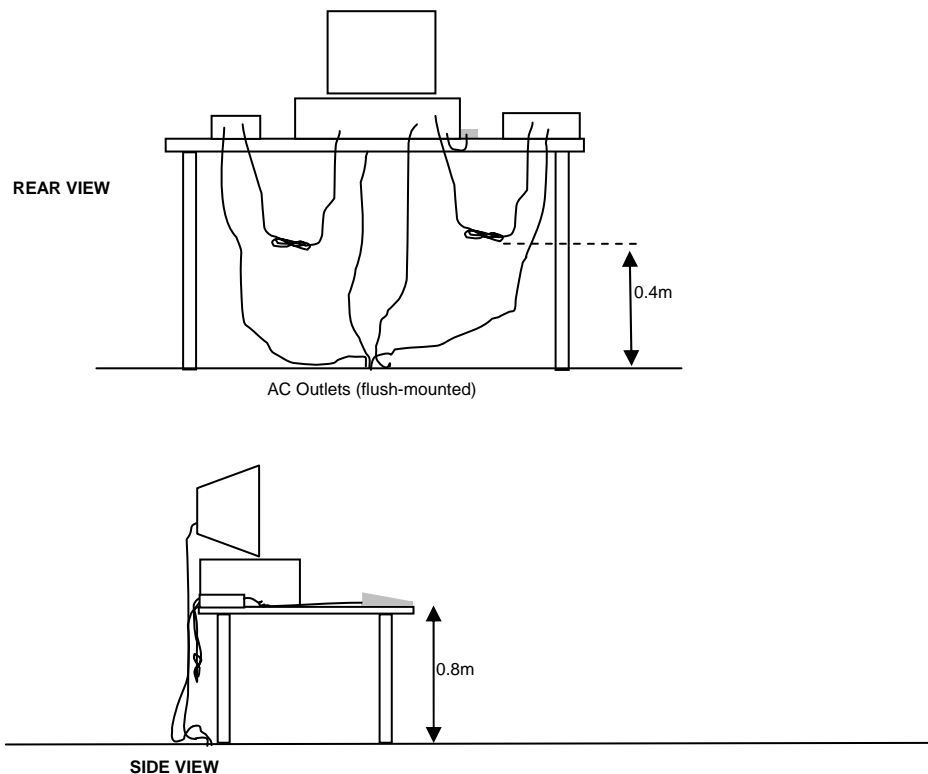

Typical Test Configuration for Radiated Field Strength Measurements

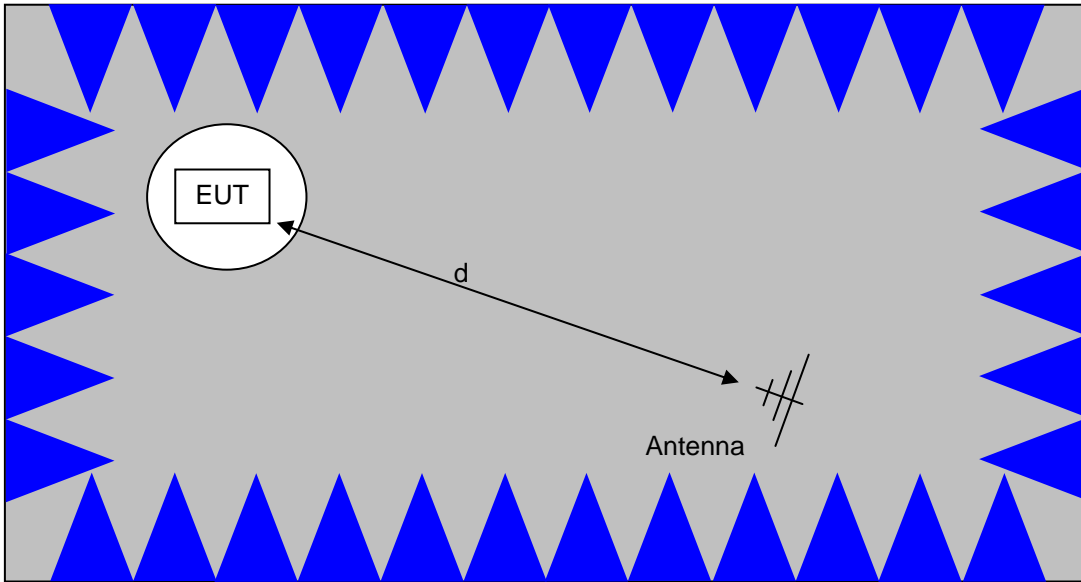

The anechoic materials on the walls and ceiling ensure compliance with the normalized site attenuation requirements of CISPR 16 / CISPR 22 / ANSI C63.4 for an alternate test site at the measurement distances used.

Floor-standing equipment is placed on the floor with insulating supports between the unit and the ground plane.

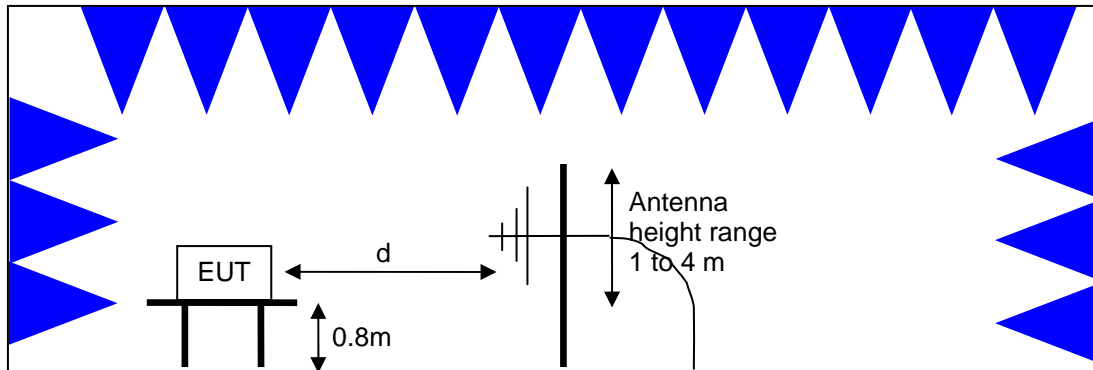

Test Configuration for Radiated Field Strength Measurements
Semi-Anechoic Chamber, Plan and Side Views

CONDUCTED EMISSIONS FROM ANTENNA PORT

Direct measurements of power, bandwidth and power spectral density are performed, where possible, with the antenna port of the EUT connected to either the power meter or spectrum analyzer via a suitable attenuator and/or filter. These are used to ensure that the front end of the measurement instrument is not overloaded by the fundamental transmission.

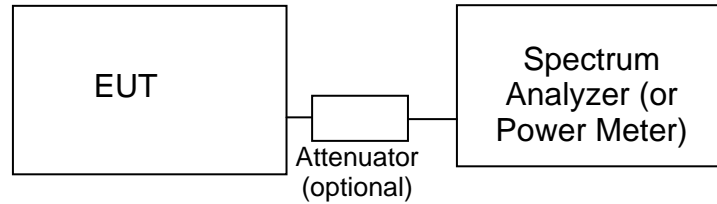
**Test Configuration for Antenna Port Measurements**

Measurement bandwidths (video and resolution) are set in accordance with the relevant standards and NTS Silicon Valley's test procedures for the type of radio being tested. When power measurements are made using a resolution bandwidth less than the signal bandwidth the power is calculated by summing the power across the signal bandwidth using either the analyzer channel power function or by capturing the trace data and calculating the power using software. In both cases the summed power is corrected to account for the equivalent noise bandwidth (ENBW) of the resolution bandwidth used.

If power averaging is used (typically for certain digital modulation techniques), the EUT is configured to transmit continuously. Power averaging is performed using either the built-in function of the analyzer or, if the analyzer does not feature power averaging, using external software. In both cases the average power is calculated over a number of sweeps (typically 100). When the EUT cannot be configured to continuously transmit then either the analyzer is configured to perform a gated sweep to ensure that the power is averaged over periods that the device is transmitting or power averaging is disabled and a max-hold feature is used.

If a power meter is used to make output power measurements the sensor head type (peak or average) is stated in the test data table.

BANDWIDTH MEASUREMENTS

The 6dB, 20dB, 26dB and/or 99% signal bandwidth are measured using the bandwidths recommended by ANSI C63.10 and RSS GEN.

SPECIFICATION LIMITS AND SAMPLE CALCULATIONS

The limits for conducted emissions are given in units of microvolts, and the limits for radiated emissions are given in units of microvolts per meter at a specified test distance. Data is measured in the logarithmic form of decibels relative to one microvolt, or dB microvolts (dBuV). For radiated emissions, the measured data is converted to the field strength at the antenna in dB microvolts per meter (dBuV/m). The results are then converted to the linear forms of uV and uV/m for comparison to published specifications.

For reference, converting the specification limits from linear to decibel form is accomplished by taking the base ten logarithm, then multiplying by 20. These limits in both linear and logarithmic form are as follows:

CONDUCTED EMISSIONS SPECIFICATION LIMITS: FCC 15.207; FCC 15.107(a), RSS GEN

The table below shows the limits for the emissions on the AC power line from an intentional radiator and a receiver.

Frequency (MHz)	Average Limit (dBuV)	Quasi Peak Limit (dBuV)
0.150 to 0.500	Linear decrease on logarithmic frequency axis between 56.0 and 46.0	Linear decrease on logarithmic frequency axis between 66.0 and 56.0
0.500 to 5.000	46.0	56.0
5.000 to 30.000	50.0	60.0

GENERAL TRANSMITTER RADIATED EMISSIONS SPECIFICATION LIMITS

The table below shows the limits for the spurious emissions from transmitters that fall in restricted bands¹ (with the exception of transmitters operating under FCC Part 15 Subpart D and RSS 210 Annex 9), the limits for all emissions from a low power device operating under the general rules of RSS 310 (tables 3 and 4), RSS 210 (table 2) and FCC Part 15 Subpart C section 15.209.

Frequency Range (MHz)	Limit (uV/m)	Limit (dBuV/m @ 3m)
0.009-0.490	2400/F _{KHz} @ 300m	67.6-20*log ₁₀ (F _{KHz}) @ 300m
0.490-1.705	24000/F _{KHz} @ 30m	87.6-20*log ₁₀ (F _{KHz}) @ 30m
1.705 to 30	30 @ 30m	29.5 @ 30m
30 to 88	100 @ 3m	40 @ 3m
88 to 216	150 @ 3m	43.5 @ 3m
216 to 960	200 @ 3m	46.0 @ 3m
Above 960	500 @ 3m	54.0 @ 3m

OUTPUT POWER LIMITS – FHSS SYSTEMS

The table below shows the limits for output power based on the number of channels available for the hopping system.

Operating Frequency (MHz)	Number of Channels	Output Power
902 – 928	≥ 50	1 Watt (30 dBm)
902 – 928	25 to 49	0.25 Watts (24 dBm)
2400 – 2483.5	≥ 75	1 Watt (30 dBm)
2400 – 2483.5	< 75	0.125 Watts (21 dBm)
5725 – 5850	75	1 Watt (30 dBm)

The maximum permitted output power is reduced by 1dB for every dB the antenna gain exceeds 6dBi. Fixed point-to-point applications using the 5725 – 5850 MHz band are not subject to this restriction.

TRANSMIT MODE SPURIOUS RADIATED EMISSIONS LIMITS – FHSS and DTS SYSTEMS

The limits for unwanted (spurious) emissions from the transmitter falling in the restricted bands are those specified in the general limits sections of FCC Part 15 and RSS 210. All other unwanted (spurious) emissions shall be at least 20dB below the level of the highest in-band signal level (30dB if the power is measured using the sample detector/power averaging method).

¹ The restricted bands are detailed in FCC 15.203, RSS 210 Table 1 and RSS 310 Table 2

SAMPLE CALCULATIONS - CONDUCTED EMISSIONS

Receiver readings are compared directly to the conducted emissions specification limit (decibel form) as follows:

$$R_r - S = M$$

where:

R_r = Receiver Reading in dBuV

S = Specification Limit in dBuV

M = Margin to Specification in +/- dB

SAMPLE CALCULATIONS - RADIATED EMISSIONS

Receiver readings are compared directly to the specification limit (decibel form). The receiver internally corrects for cable loss, preamplifier gain, and antenna factor. The calculations are in the reverse direction of the actual signal flow, thus cable loss is added and the amplifier gain is subtracted. The Antenna Factor converts the voltage at the antenna coaxial connector to the field strength at the antenna elements.

A distance factor, when used for electric field measurements above 30MHz, is calculated by using the following formula:

$$F_d = 20 * \text{LOG}_{10} (D_m/D_s)$$

where:

F_d = Distance Factor in dB

D_m = Measurement Distance in meters

D_s = Specification Distance in meters

For electric field measurements below 30MHz the extrapolation factor is either determined by making measurements at multiple distances or a theoretical value is calculated using the formula:

$$F_d = 40 * \text{LOG}_{10} (D_m/D_s)$$

Measurement Distance is the distance at which the measurements were taken and Specification Distance is the distance at which the specification limits are based. The antenna factor converts the voltage at the antenna coaxial connector to the field strength at the antenna elements.

The margin of a given emission peak relative to the limit is calculated as follows:

$$R_c = R_r + F_d$$

and

$$M = R_c - L_s$$

where:

R_r = Receiver Reading in dBuV/m

F_d = Distance Factor in dB

R_c = Corrected Reading in dBuV/m

L_s = Specification Limit in dBuV/m

M = Margin in dB Relative to Spec

SAMPLE CALCULATIONS - FIELD STRENGTH TO EIRP CONVERSION

Where the radiated electric field strength is expressed in terms of the equivalent isotropic radiated power (eirp), or where a field strength measurement of output power is made in lieu of a direct measurement, the following formula is used to convert between eirp and field strength at a distance of d (meters) from the equipment under test:

$$E = \frac{1000000 \sqrt{30 P}}{d} \quad \text{microvolts per meter}$$

where P is the eirp (Watts)

For a measurement at 3m the conversion from a logarithmic value for field strength (dBuV/m) to an eirp power (dBm) is -95.3dB.

Appendix A Test Equipment Calibration Data**Radiated Emissions, 1,000 - 6,500 MHz and 18,000 - 26,000MHz, 12-Jun-14**

<u>Manufacturer</u>	<u>Description</u>	<u>Model</u>	<u>Asset #</u>	<u>Cal Due</u>
Hewlett Packard	SpecAn 9 kHz - 40 GHz, FT (SA40) Blue	8564E (84125C)	1393	5/6/2015
Rohde & Schwarz	EMI Test Receiver, 20 Hz-7 GHz	ESIB7	1538	12/14/2014
EMCO	Antenna, Horn, 1-18 GHz	3115	1561	7/12/2014
Hewlett Packard	Head (Inc flex cable, (1742,1743) Blue)	84125C	1620	5/6/2015
Hewlett Packard	HF Amplifier, 45 MHz -50 GHz (with 1620)	83051A (84125C)	1742	5/6/2015
Hewlett Packard	HF Amplifier, 45 MHz -50 GHz (with 1620)	83051A (84125C)	1743	5/6/2015
A. H. Systems	Purple System Horn, 18-40GHz	SAS-574, p/n: 2581	2160	6/28/2014

Radiated Emissions, 1,000 - 26,000 MHz, 16-Jun-14

<u>Manufacturer</u>	<u>Description</u>	<u>Model</u>	<u>Asset #</u>	<u>Cal Due</u>
Hewlett Packard	SpecAn 9 KHz-26.5 GHz, Non-Program	8563E	284	2/26/2015
EMCO	Antenna, Horn, 1-18 GHz	3115	786	12/20/2015
Hewlett Packard	Microwave Preamplifier, 1-26.5GHz	8449B	870	2/20/2015
Micro-Tronics	Band Reject Filter, 2400-2500 MHz	BRM50702-02	1683	8/2/2014

Radio Antenna Port (Power and Spurious Emissions), 19-Jun-14

<u>Manufacturer</u>	<u>Description</u>	<u>Model</u>	<u>Asset #</u>	<u>Cal Due</u>
Rohde & Schwarz	Power Sensor, 1 uW-100 mW, DC-18 GHz, 50ohms	NRV-Z51	1070	6/6/2015
Rohde & Schwarz	Power Meter, Dual Channel	NRVD	1071	3/24/2015
Rohde & Schwarz	Power Sensor 100 uW - 2 Watts use with 20dB attenuator sn:1031.6959.00 only	NRV-Z32	1423	9/17/2014
Agilent Technologies	PSA, Spectrum Analyzer, (installed options, 111, 115, 123, 1DS, B7J, HYX,	E4446A	2139	4/8/2015

Radiated Emissions, 30 - 1,000 MHz, 17-Jun-14

<u>Manufacturer</u>	<u>Description</u>	<u>Model</u>	<u>Asset #</u>	<u>Cal Due</u>
Sunol Sciences	Biconilog, 30-3000 MHz	JB3	1548	8/9/2014
Rohde & Schwarz	EMI Test Receiver, 20 Hz-7 GHz	ESIB7	1630	6/22/2014
Micro-Tronics	Band Reject Filter, 5470-5725 MHz	BRC50704-02	1730	8/2/2014
Micro-Tronics	Band Reject Filter, 2400-2500 MHz	BRM50702-02	2238	9/18/2014
Com-Power	Preamplifier, 1-1000 MHz	PAM-103	2885	11/1/2014

Radiated Emissions, 1000 - 40,000 MHz, 17-Jun-14

<u>Manufacturer</u>	<u>Description</u>	<u>Model</u>	<u>Asset #</u>	<u>Cal Due</u>
EMCO	Antenna, Horn, 1-18 GHz	3115	487	7/19/2014
Micro-Tronics	Band Reject Filter, 5470-5725 MHz	BRC50704-02	1681	8/20/2014
Hewlett Packard	Head (Inc W1-W4, 1946 , 1947) Purple	84125C	1772	4/25/2015
A. H. Systems	Blue System Horn, 18-40GHz	SAS-574, p/n: 2581	2159	8/8/2014
Hewlett Packard	Microwave Preamplifier, 1-26.5GHz	8449B	2199	2/20/2015

Micro-Tronics	Band Reject Filter, 5150-5350 MHz	BRC50703-02	2239	9/18/2014
Hewlett Packard	SpecAn 9 kHz - 40 GHz, (SA40) Purple	8564E (84125C)	2415	2/27/2015
Hewlett Packard	High Pass filter, 8.2 GHz (Purple System)	P/N 84300-80039	1767	11/26/2014

Radiated Emissions, 1,000- 15,000 MHz, 18-Jun-14

<u>Manufacturer</u>	<u>Description</u>	<u>Model</u>	<u>Asset #</u>	<u>Cal Due</u>
EMCO	Antenna, Horn, 1-18 GHz	3115	487	7/19/2014
Rohde & Schwarz	EMI Test Receiver, 20 Hz-7 GHz	ESIB7	1630	6/22/2014
Micro-Tronics	Band Reject Filter, 5470-5725 MHz	BRC50704-02	1681	8/20/2014
Micro-Tronics	Band Reject Filter, 5725-5875 MHz	BRC50705-02	1682	3/13/2015
Hewlett Packard	High Pass filter, 8.2 GHz (Purple System)	P/N 84300-80039	1767	11/26/2014
Hewlett Packard	Microwave Preamplifier, 1-26.5GHz	8449B	2199	2/20/2015
Micro-Tronics	Band Reject Filter, 2400-2500 MHz	BRM50702-02	2238	9/18/2014
Micro-Tronics	Band Reject Filter, 5150-5350 MHz	BRC50703-02	2239	9/18/2014
Hewlett Packard	SpecAn 9 kHz - 40 GHz, (SA40) Purple	8564E (84125C)	2415	2/27/2015

Radiated Emissions, 1,000- 15,000 MHz, 19-Jun-14

<u>Manufacturer</u>	<u>Description</u>	<u>Model</u>	<u>Asset #</u>	<u>Cal Due</u>
EMCO	Antenna, Horn, 1-18 GHz	3115	487	7/19/2014
Rohde & Schwarz	EMI Test Receiver, 20 Hz-7 GHz	ESIB7	1630	6/22/2014
Micro-Tronics	Band Reject Filter, 5470-5725 MHz	BRC50704-02	1681	8/20/2014
Micro-Tronics	Band Reject Filter, 5725-5875 MHz	BRC50705-02	1682	3/13/2015
Hewlett Packard	High Pass filter, 8.2 GHz (Purple System)	P/N 84300-80039	1767	11/26/2014
Hewlett Packard	Microwave Preamplifier, 1-26.5GHz	8449B	2199	2/20/2015
Micro-Tronics	Band Reject Filter, 2400-2500 MHz	BRM50702-02	2238	9/18/2014
Micro-Tronics	Band Reject Filter, 5150-5350 MHz	BRC50703-02	2239	9/18/2014
Hewlett Packard	SpecAn 9 kHz - 40 GHz, (SA40) Purple	8564E (84125C)	2415	2/27/2015

Conducted Emissions - AC Power Ports, 20-Jun-14

<u>Manufacturer</u>	<u>Description</u>	<u>Model</u>	<u>Asset #</u>	<u>Cal Due</u>
EMCO	LISN, 10 kHz-100 MHz	3825/2	1293	2/13/2015
Rohde & Schwarz	Pulse Limiter	ESH3 Z2	1401	5/15/2015
Rohde & Schwarz	EMI Test Receiver, 20 Hz-7 GHz	ESIB7	1630	6/22/2014

Radio Antenna Port (Power and Spurious Emissions), 20-Jun-14

<u>Manufacturer</u>	<u>Description</u>	<u>Model</u>	<u>Asset #</u>	<u>Cal Due</u>
Agilent Technologies	3Hz -44GHz PSA Spectrum Analyzer	E4446A	2796	2/6/2015

Appendix B Test Data

T95471 Pages 24 - 53

T95472 Pages 54 - 96



EMC Test Data

Client:	Intel Corporation	Job Number:	J94914
Product:	7265D2W	T-Log Number:	T95471
		Project Manager:	Christine Krebill
Contact:	Steve Hackett	Project Coordinator:	-
Emissions Standard(s):	FCC Part 15.247, 15.407, RSS-210	Class:	B
Immunity Standard(s):	-	Environment:	Radio

EMC Test Data

For The

Intel Corporation

Product

7265D2W

Date of Last Test: 6/26/2014



EMC Test Data

Client:	Intel Corporation	Job Number:	J94914
Model:	7265D2W	T-Log Number:	T95471
Contact:	Steve Hackett	Project Manager:	Christine Krebill
Standard:	FCC Part 15.247, 15.407, RSS-210	Project Coordinator:	-
		Class:	N/A

FCC 15.247 FHSS - Power, Bandwidth and Spurious Emissions

Test Specific Details

Objective: The objective of this test session is to perform final qualification testing of the EUT with respect to the specification listed above.

Date of Test: 6/19/2014
 Test Engineer: John Caizzi
 Test Location: Lab 4A

Config. Used: 1
 Config Change: none
 Host Unit Voltage

General Test Configuration

When measuring the conducted emissions from the EUT's antenna port, the antenna port of the EUT was connected to the spectrum analyzer or power meter via a suitable attenuator to prevent overloading the measurement system. All measurements are corrected to allow for the external attenuators used.

Unless stated otherwise the EUT was operating such that it constantly hopped on either the low, center or high channels.

Ambient Conditions:

Temperature: 23 °C
 Rel. Humidity: 35 %

Summary of Results

MAC Address: 001500F15B5D DRTU Tool Version 1.7.3-935 Driver version 17.1.0.11

Run #	Test Performed	Limit	Pass / Fail	Result / Margin
1	30 - 25,000 MHz - Transmitter Conducted Spurious Emissions	FCC Part 15.247(c)	Pass	All spurious emissions > -20 dBc.
2	Output Power	15.247(b)	Pass	Basic Rate: 5.1 dBm (.0032 W) EDR: 1.8 dBm (.0015 W)
3	20dB Bandwidth	15.247(a)	Pass	Basic Rate: 942 kHz EDR: 1483 kHz
3	99% bandwidth	15.247(a)	Pass	Basic Rate: 874 kHz EDR: 1356 kHz
3	Channel Occupancy	15.247(a)	Pass	Complies with Bluetooth protocol
3	Number of Channels	15.247(a)	Pass	79 channels

Modifications Made During Testing:

No modifications were made to the EUT during testing

Deviations From The Standard

No deviations were made from the requirements of the standard.

Client:	Intel Corporation	Job Number:	J94914
Model:	7265D2W	T-Log Number:	T95471
Contact:	Steve Hackett	Project Manager:	Christine Krebill
Standard:	FCC Part 15.247, 15.407, RSS-210	Project Coordinator:	-
		Class:	N/A

Run #1: Antenna Conducted Spurious Emissions, 30 - 25,000 MHz.

Date of Test: 6/19/2020
 Test Engineer: John Caizzi
 Test Location: Lab 4A

Refer to plots below. Scans made using RBW=VB=100 KHz with the limit line set at 20dB below the highest in-band signal level with the hopping feature disabled.

Basic rate (1Mb/s)

Low channel

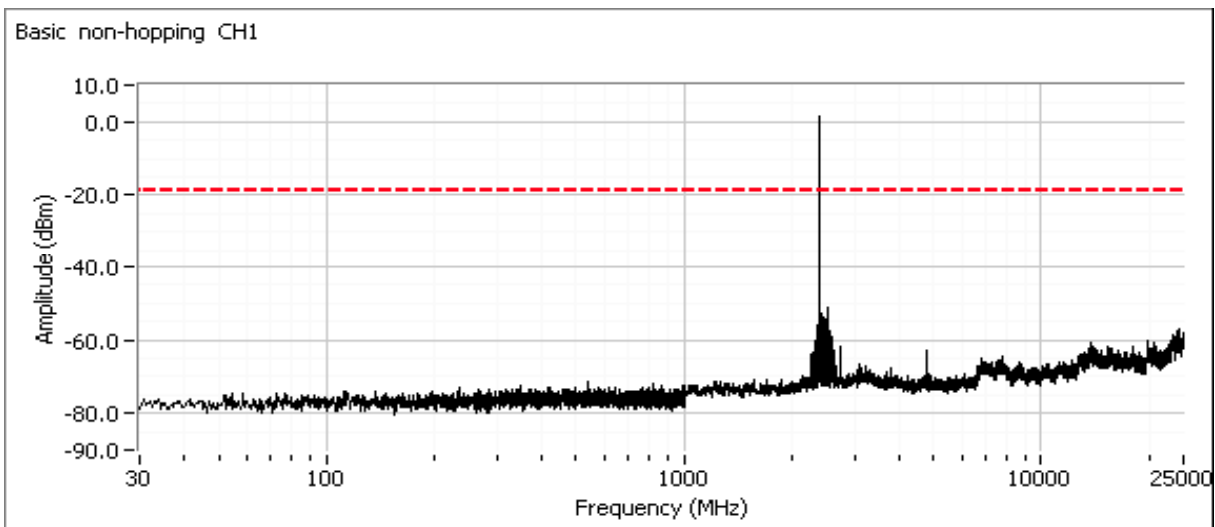

Client: Intel Corporation	Job Number: J94914
Model: 7265D2W	T-Log Number: T95471
Contact: Steve Hackett	Project Manager: Christine Krebill
Standard: FCC Part 15.247, 15.407, RSS-210	Project Coordinator: -
	Class: N/A

Plot showing -20dBc at the lower band edge

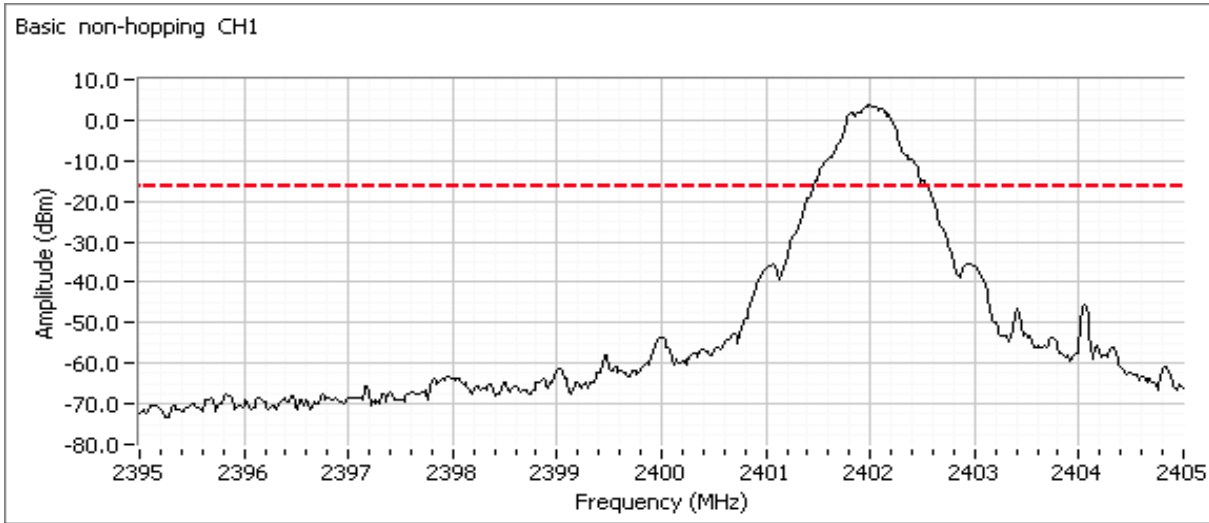

Center channel

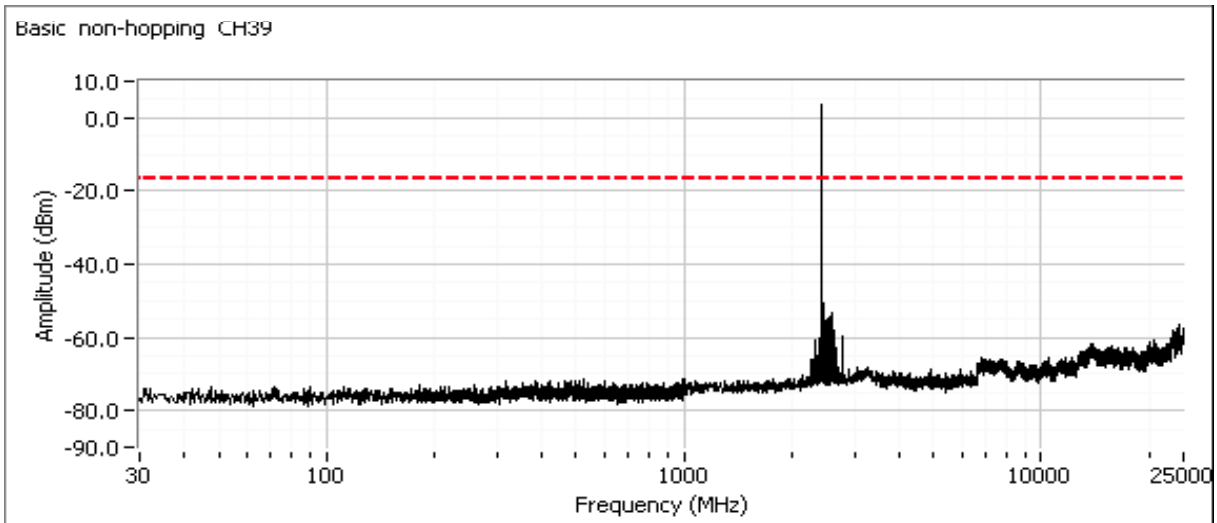

Client:	Intel Corporation	Job Number:	J94914
Model:	7265D2W	T-Log Number:	T95471
Contact:	Steve Hackett	Project Manager:	Christine Krebill
Standard:	FCC Part 15.247, 15.407, RSS-210	Project Coordinator:	-
		Class:	N/A

High channel

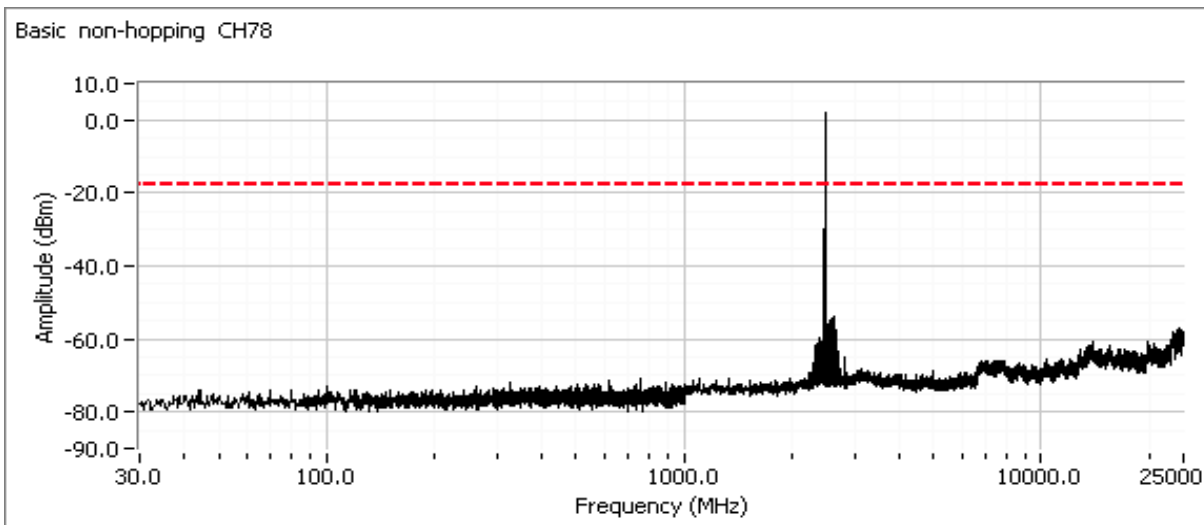

Plot showing -20dBc at the upper band edge

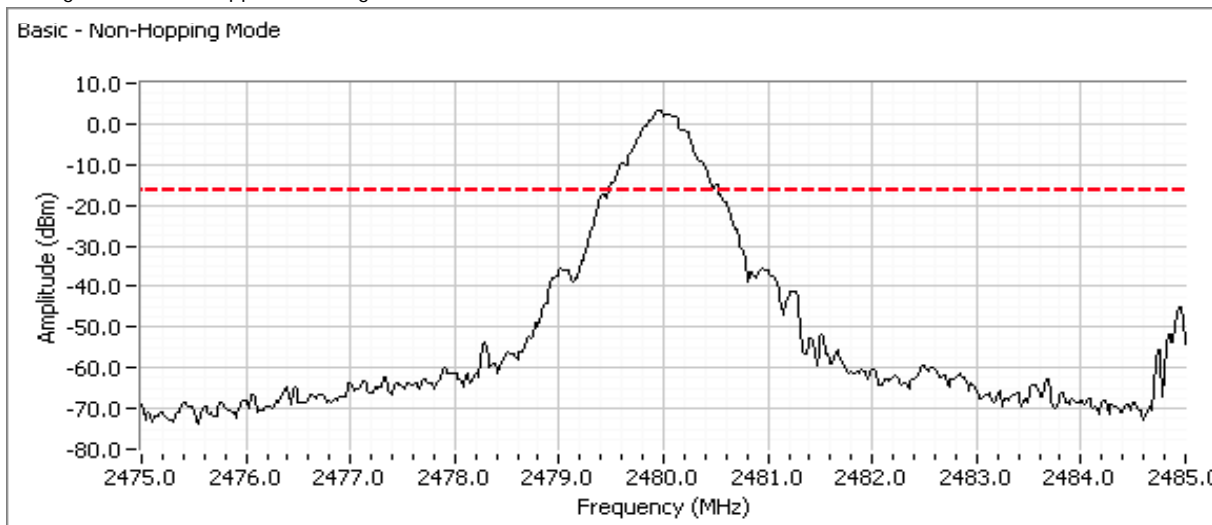

Client:	Intel Corporation	Job Number:	J94914
Model:	7265D2W	T-Log Number:	T95471
Contact:	Steve Hackett	Project Manager:	Christine Krebill
Standard:	FCC Part 15.247, 15.407, RSS-210	Project Coordinator:	-
		Class:	N/A

Refer to plots below. Scans made using RBW=VB=100 KHz with the limit line set at 20dB below the highest in-band signal level with the **hopping feature enabled** to show compliance with the -20dBc requirement at the allocated band edge. The spectrum analyzer is left in max hold mode until the trace stabilizes.

Low band edge, hopping enabled

Plot showing -20dBc at the lower band edge

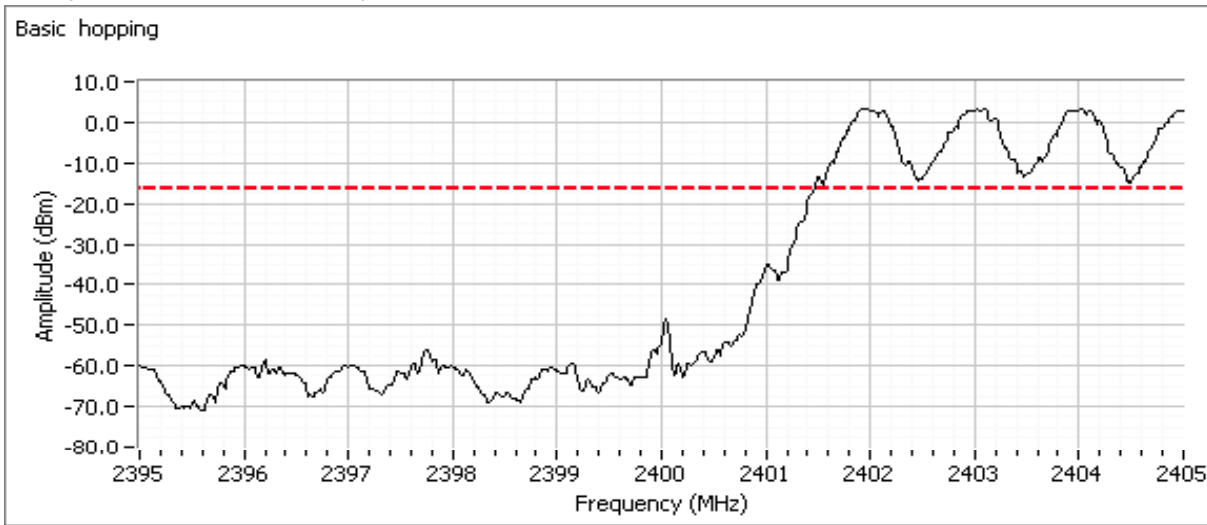

High band edge, hopping enabled

Plot showing -20dBc at the upper band edge

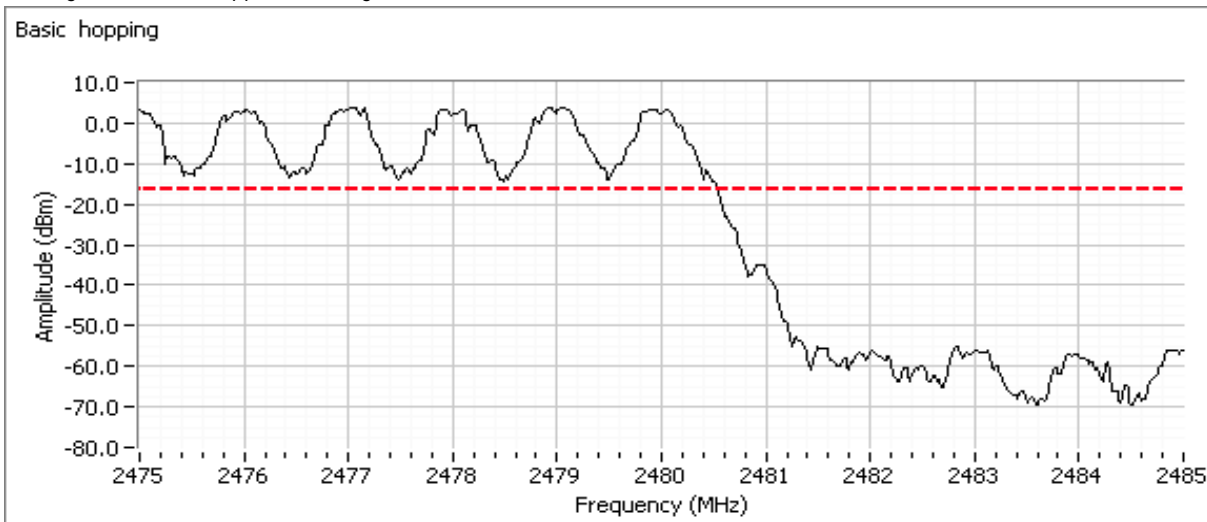

Client:	Intel Corporation	Job Number:	J94914
Model:	7265D2W	T-Log Number:	T95471
Contact:	Steve Hackett	Project Manager:	Christine Krebill
Standard:	FCC Part 15.247, 15.407, RSS-210	Project Coordinator:	-
		Class:	N/A

EDR (3Mb/s)

Low channel

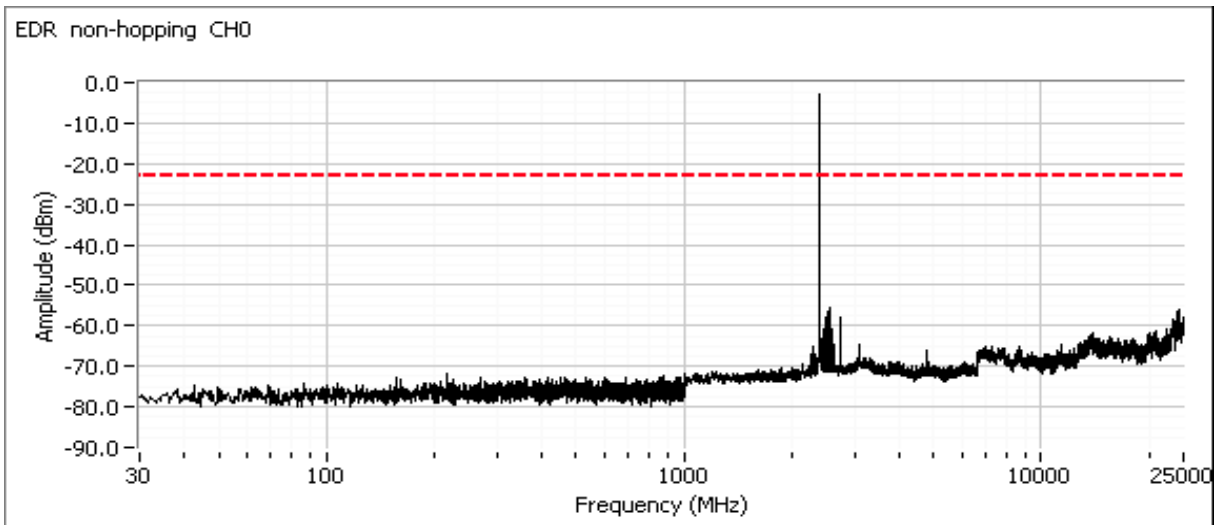

Plot showing -20dBc at the lower band edge

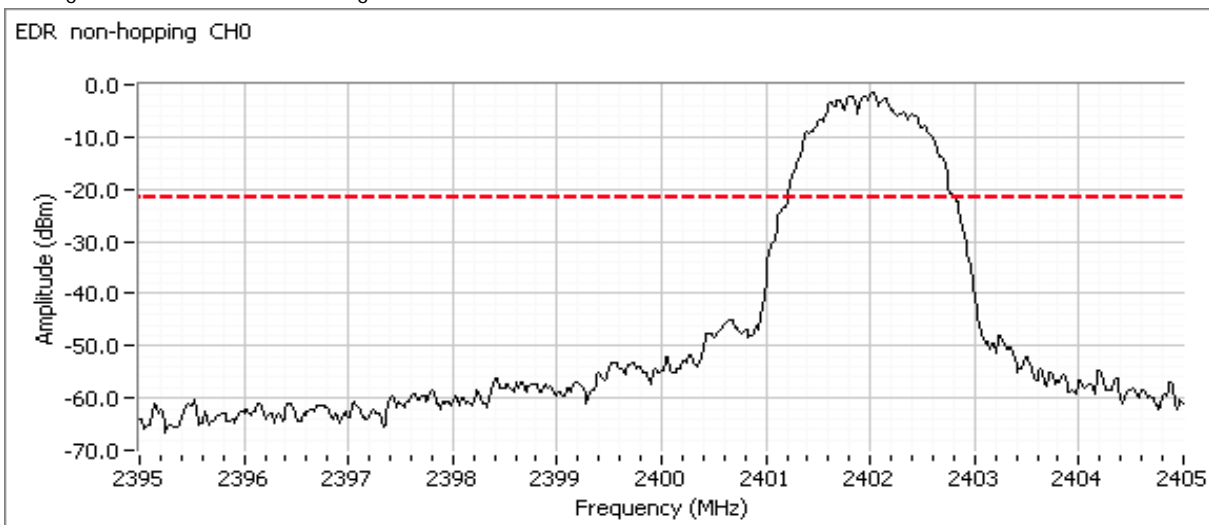

Client:	Intel Corporation	Job Number:	J94914
Model:	7265D2W	T-Log Number:	T95471
Contact:	Steve Hackett	Project Manager:	Christine Krebill
Standard:	FCC Part 15.247, 15.407, RSS-210	Project Coordinator:	-
		Class:	N/A

Center channel

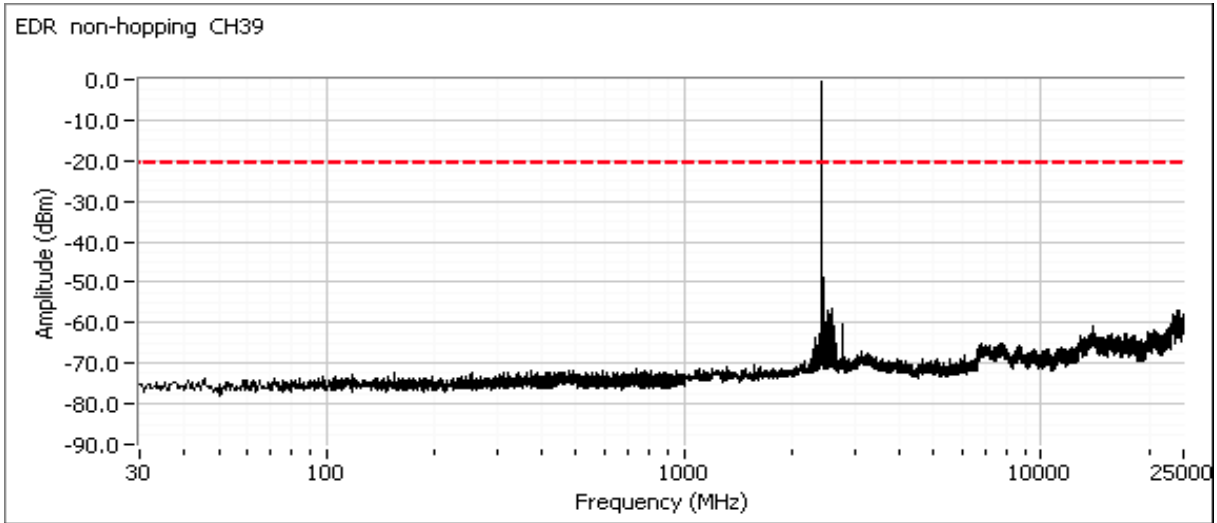

High channel

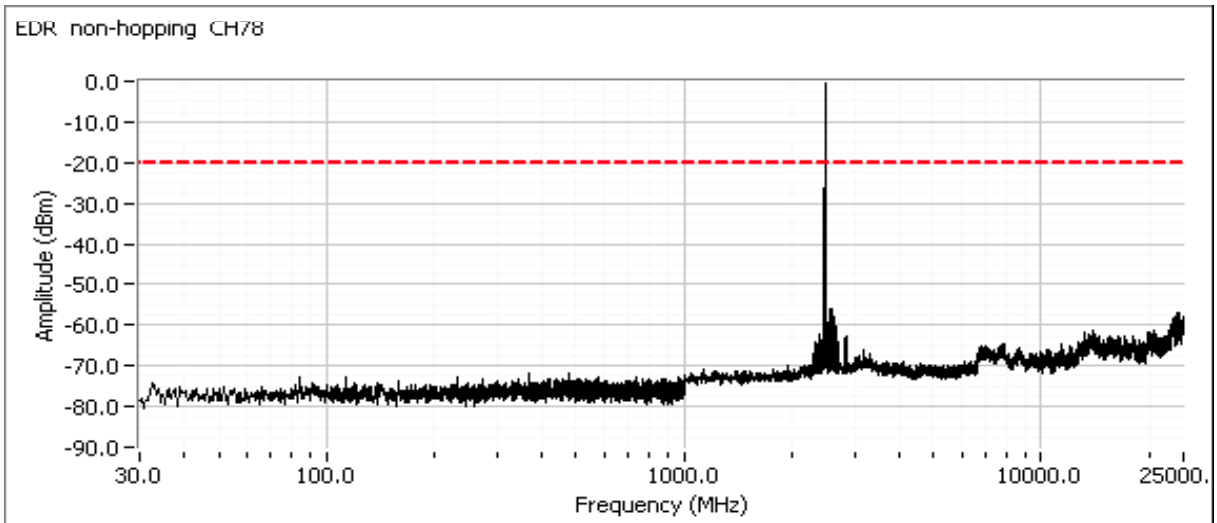

Client:	Intel Corporation	Job Number:	J94914
Model:	7265D2W	T-Log Number:	T95471
Contact:	Steve Hackett	Project Manager:	Christine Krebill
Standard:	FCC Part 15.247, 15.407, RSS-210	Project Coordinator:	-
		Class:	N/A

Plot showing -20dBc at the upper band edge

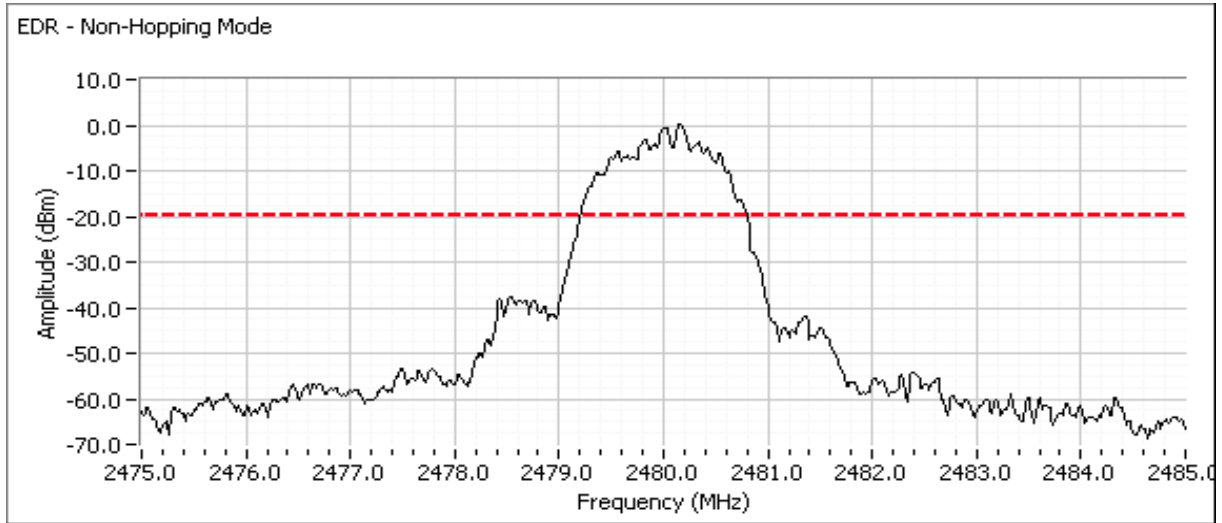

Refer to plots below. Scans made using RBW=VB=100 KHz with the limit line set at 20dB below the highest in-band signal level with the **hopping feature enabled** to show compliance with the -20dBc requirement at the allocated band edge. The spectrum analyzer is left in max hold mode until the trace stabilizes.

Low band edge, hopping enabled

Plot showing -20dBc at the lower band edge

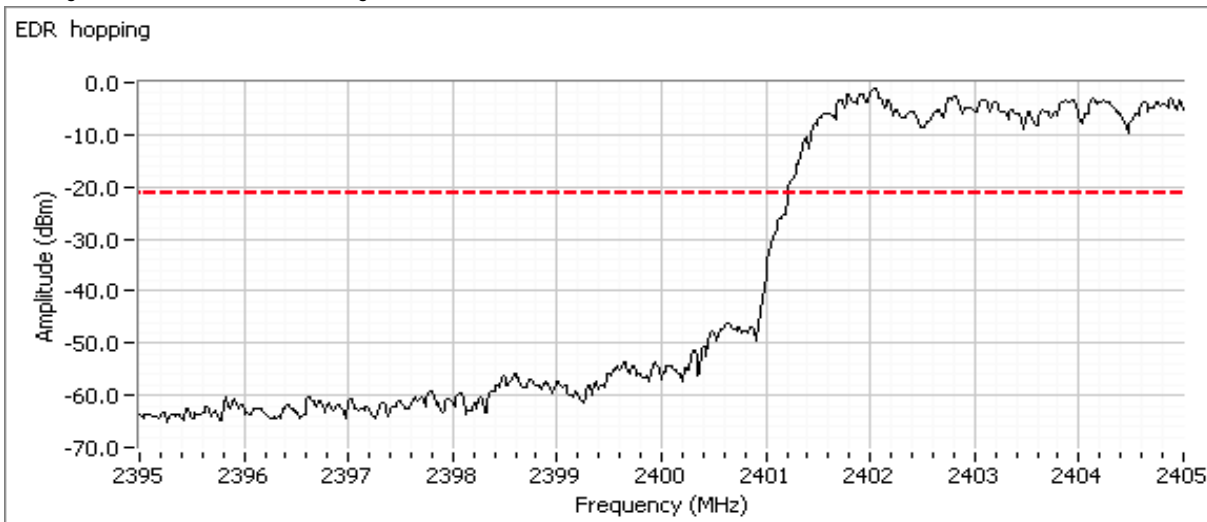



EMC Test Data

Client:	Intel Corporation	Job Number:	J94914
Model:	7265D2W	T-Log Number:	T95471
Contact:	Steve Hackett	Project Manager:	Christine Krebill
Standard:	FCC Part 15.247, 15.407, RSS-210	Project Coordinator:	-
		Class:	N/A

High band edge, hopping enabled
Plot showing -20dBc at the upper band edge

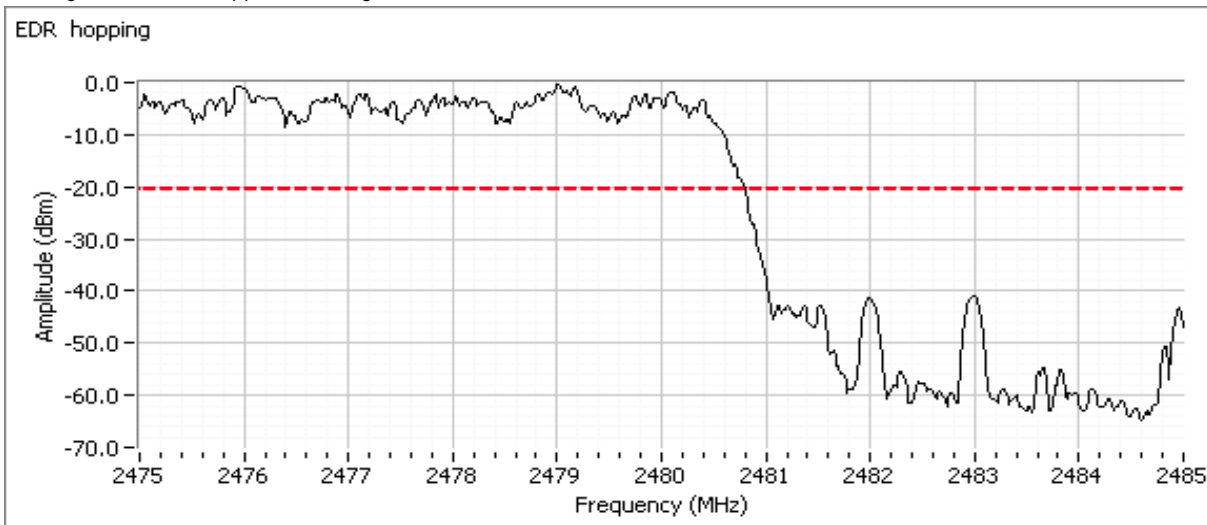



EMC Test Data

Client:	Intel Corporation	Job Number:	J94914
Model:	7265D2W	T-Log Number:	T95471
Contact:	Steve Hackett	Project Manager:	Christine Krebill
Standard:	FCC Part 15.247, 15.407, RSS-210	Project Coordinator:	-
		Class:	N/A

Run #2: Output Power

For frequency hopping systems operating in the 2400-2483.5 MHz band employing at least 75 non-overlapping hopping channels, and all frequency hopping systems in the 5725-5850 MHz band: 1 watt.
 For all other frequency hopping systems in the 2400-2483.5 MHz band: 0.125 watts.

Maximum antenna gain: 3.2 dBi

Mode	Channel	Frequency (MHz)	Res BW	Pavg	Output Power (dBm)	Output Power (W)	EIRP (W)
Basic	Low	2402	NA		5.1	0.0032	0.0068
	Mid	2441			5.1	0.0032	0.0068
	High	2480			4.7	0.0030	0.0062
EDR	Low	2402			1.7	0.0015	0.0031
	Mid	2441			1.8	0.0015	0.0032
	High	2480			1.5	0.0014	0.0030

- Note 1: Output power is measured as a peak power using either a peak power meter or with a spectrum analyzer and $VB > 3 \times RB$ and $RB > 20\text{dB}$ bandwidth. The actual method used was a peak power meter.
- Note 2: Setting is the test utility software setting and used for reference only. Pavg is the average output power measured with an average power meter and is provided for reference only.

Run #3: Bandwidth, Channel Occupancy, Spacing and Number of Channels

Mode	Channel	Frequency (MHz)	Resolution Bandwidth	20dB Bandwidth (kHz)	Resolution Bandwidth	99% Bandwidth (kHz)
Basic	Low	2402	20 kHz	933	20 kHz	874
	Mid	2441		942		865
	High	2480		942		874
EDR	Low	2402		1483		1356
	Mid	2441		1475		1356
	High	2480		1483		1356

- Note 1: 20dB bandwidth measured using $RB = 20\text{ kHz}$, $VB = 62\text{ kHz}$ ($VB > RB$)
- Note 2: 99% bandwidth measured using $RB = 20\text{ kHz}$, $VB = 62\text{ kHz}$ ($VB \geq 3RB$)

Client: Intel Corporation	Job Number: J94914
Model: 7265D2W	T-Log Number: T95471
Contact: Steve Hackett	Project Manager: Christine Krebill
Standard: FCC Part 15.247, 15.407, RSS-210	Project Coordinator: -
	Class: N/A

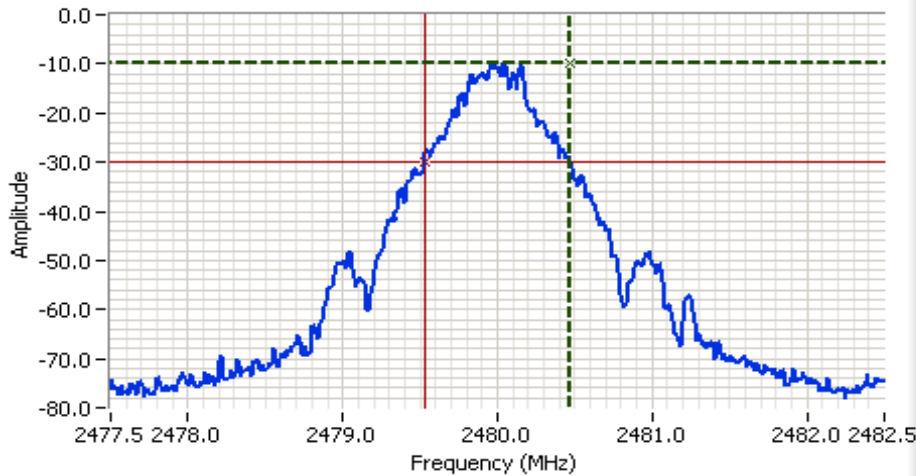

Analyzer Settings
 Agilent Technologies, E4446A
 CF: 2480.000 MHz
 SPAN: 5.000 MHz
 RB: 20.0 kHz
 VB: 62.0 kHz
 Detector: POS
 Attn: 10 DB
 RL Offset: 0.0 DB
 Sweep Time: 11.9ms
 Ref Lvl: 0.0 DBM

Comments
 20dB BW: 942 kHz
 Basic

Cursor 1 2480.4750 -9.80 

Cursor 2 2479.5333 -29.80 

Delta Freq. 942 kHz

Delta Amplitude 20.00

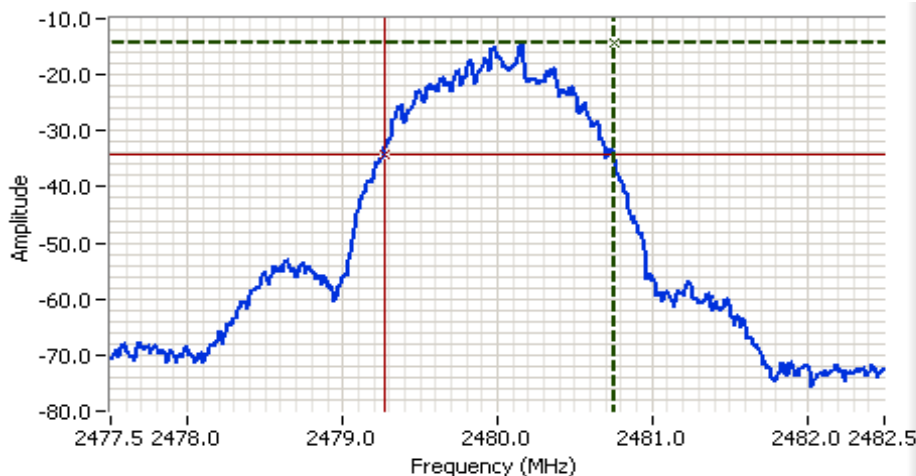

Analyzer Settings
 Agilent Technologies, E4446A
 CF: 2480.000 MHz
 SPAN: 5.000 MHz
 RB: 20.0 kHz
 VB: 62.0 kHz
 Detector: POS
 Attn: 10 DB
 RL Offset: 0.0 DB
 Sweep Time: 11.9ms
 Ref Lvl: 0.0 DBM

Comments
 20dB BW: 1.483 MHz
 EDR

Cursor 1 2480.7500 -14.15 

Cursor 2 2479.2667 -34.16 

Delta Freq. 1.483

Delta Amplitude 20.00



Client: Intel Corporation	Job Number: J94914
Model: 7265D2W	T-Log Number: T95471
Contact: Steve Hackett	Project Manager: Christine Krebill
Standard: FCC Part 15.247, 15.407, RSS-210	Project Coordinator: -
	Class: N/A

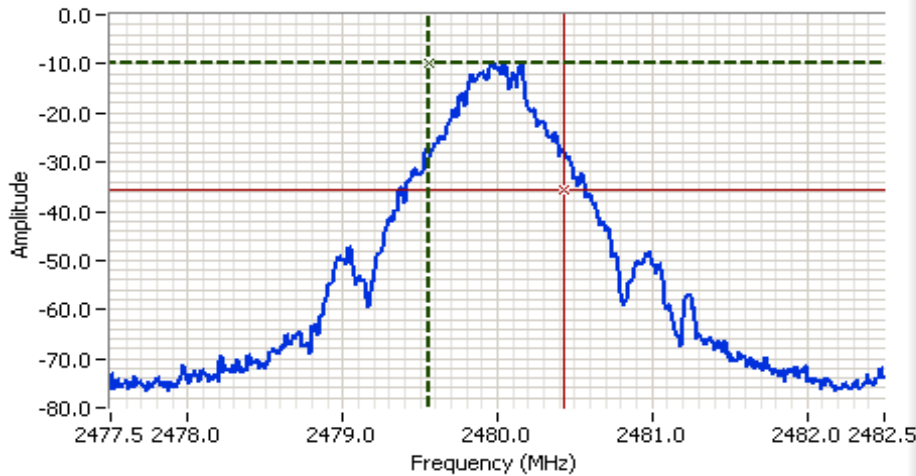

Analyzer Settings

Agilent Technologies, E4446A
 CF: 2480.000 MHz
 SPAN: 5.000 MHz
 RB: 20.0 kHz
 VB: 62.0 kHz
 Detector: POS
 Attn: 10 DB
 RL Offset: 0.0 DB
 Sweep Time: 11.9ms
 Ref Lvl: 0.0 DBM

Comments

99% power BW: 874 kHz
 Basic

Cursor 1 2479.5549 -9.75

Cursor 2 2480.4285 -35.75

Delta Freq. 874 kHz

Delta Amplitude 26.00

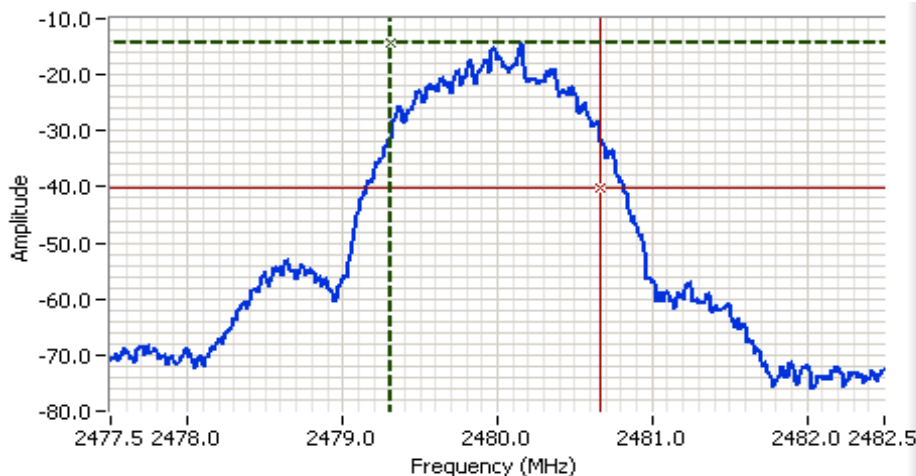

Analyzer Settings

Agilent Technologies, E4446A
 CF: 2480.000 MHz
 SPAN: 5.000 MHz
 RB: 20.0 kHz
 VB: 62.0 kHz
 Detector: POS
 Attn: 10 DB
 RL Offset: 0.0 DB
 Sweep Time: 11.9ms
 Ref Lvl: 0.0 DBM

Comments

99% power BW: 1.356 MHz
 EDR

Cursor 1 2479.3136 -14.18

Cursor 2 2480.6697 -40.17

Delta Freq. 1.356

Delta Amplitude 26.00



Client:	Intel Corporation	Job Number:	J94914
Model:	7265D2W	T-Log Number:	T95471
Contact:	Steve Hackett	Project Manager:	Christine Krebill
Standard:	FCC Part 15.247, 15.407, RSS-210	Project Coordinator:	-
		Class:	N/A

The channel spacing is 1MHz with a minimum of 20 channels and a maximum of 79 channels used. See plots below showing all 79 channels, with first channel at 2402 MHz and last channel at 2480 MHz

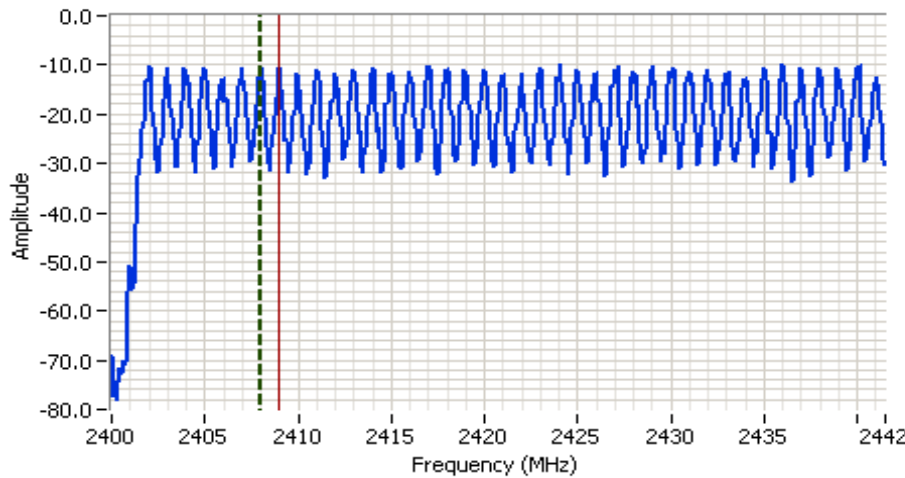

Analyzer Settings
 Agilent Technologies, E4446A
 CF: 2420.750 MHz
 SPAN: 41.500 MHz
 RB: 20.0 kHz
 VB: 62.0 kHz
 Detector: POS
 Attn: 10 DB
 RL Offset: 0.0 DB
 Sweep Time: 99.0ms
 Ref Lvl: 0.0 DBM

Comments
 BT basic
 40 channels, 1 MHz spacing

Cursor 1 2407.9974 3.03 Delta Freq. 973 kHz
 Cursor 2 2408.9701 5.69 Delta Amplitude 2.65

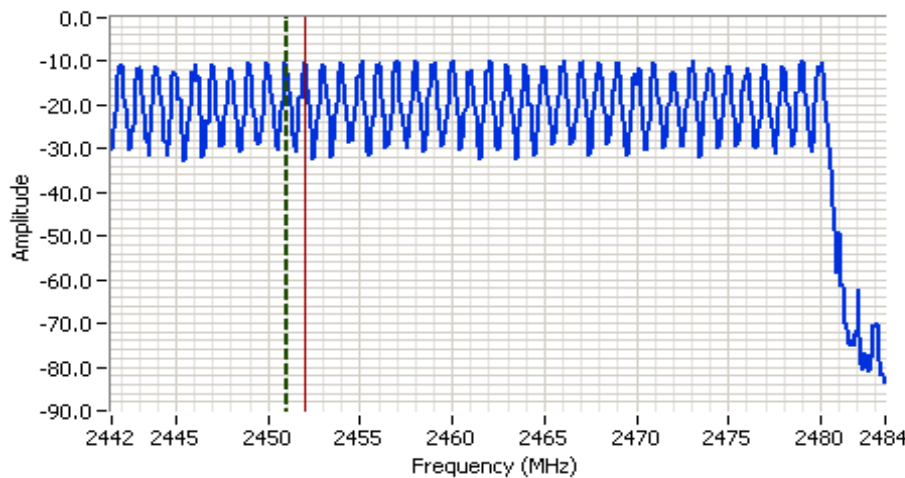

Analyzer Settings
 Agilent Technologies, E4446A
 CF: 2462.500 MHz
 SPAN: 42.000 MHz
 RB: 20.0 kHz
 VB: 62.0 kHz
 Detector: POS
 Attn: 10 DB
 RL Offset: 0.0 DB
 Sweep Time: 100.1ms
 Ref Lvl: 0.0 DBM

Comments
 BT basic
 39 channels, 1 MHz spacing

Cursor 1 2451.0156 14.08 Delta Freq. 984 kHz
 Cursor 2 2452.0000 15.36 Delta Amplitude 1.28



Client: Intel Corporation	Job Number: J94914
Model: 7265D2W	T-Log Number: T95471
Contact: Steve Hackett	Project Manager: Christine Krebill
Standard: FCC Part 15.247, 15.407, RSS-210	Project Coordinator: -
	Class: N/A

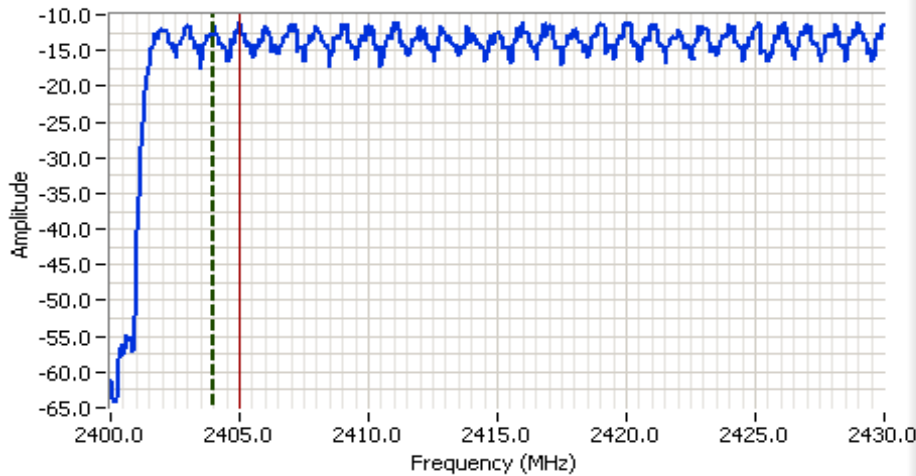

Analyzer Settings
 Agilent Technologies, E4446A
 CF: 2415.000 MHz
 SPAN: 30.000 MHz
 RB: 100 kHz
 VB: 300 kHz
 Detector: POS
 Attn: 10 DB
 RL Offset: 0.0 DB
 Sweep Time: 2.9ms
 Ref Lvl: 0.0 DBM

Comments
 BT EDR
 28 channels, 1 MHz spacing

Cursor 1 2403.9844 -6.09

Cursor 2 2405.0000 -7.13

Delta Freq. 1.016

Delta Amplitude 1.04

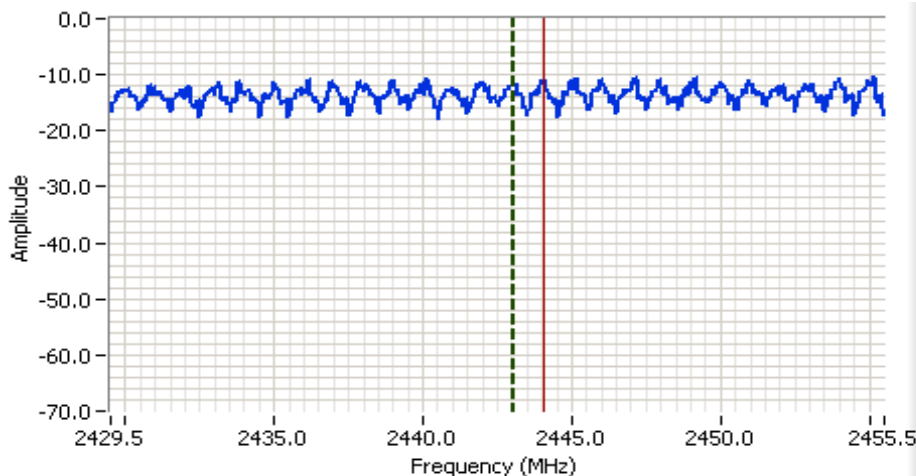

Analyzer Settings
 Agilent Technologies, E4446A
 CF: 2442.500 MHz
 SPAN: 26.000 MHz
 RB: 100 kHz
 VB: 300 kHz
 Detector: POS
 Attn: 10 DB
 RL Offset: 0.0 DB
 Sweep Time: 2.5ms
 Ref Lvl: 0.0 DBM

Comments
 BT EDR
 26 channels, 1 MHz spacing

Cursor 1 2443.0417 3.98

Cursor 2 2444.0573 7.30

Delta Freq. 1.016

Delta Amplitude 3.32





EMC Test Data

Client:	Intel Corporation	Job Number:	J94914
Model:	7265D2W	T-Log Number:	T95471
Contact:	Steve Hackett	Project Manager:	Christine Krebill
Standard:	FCC Part 15.247, 15.407, RSS-210	Project Coordinator:	-
		Class:	N/A

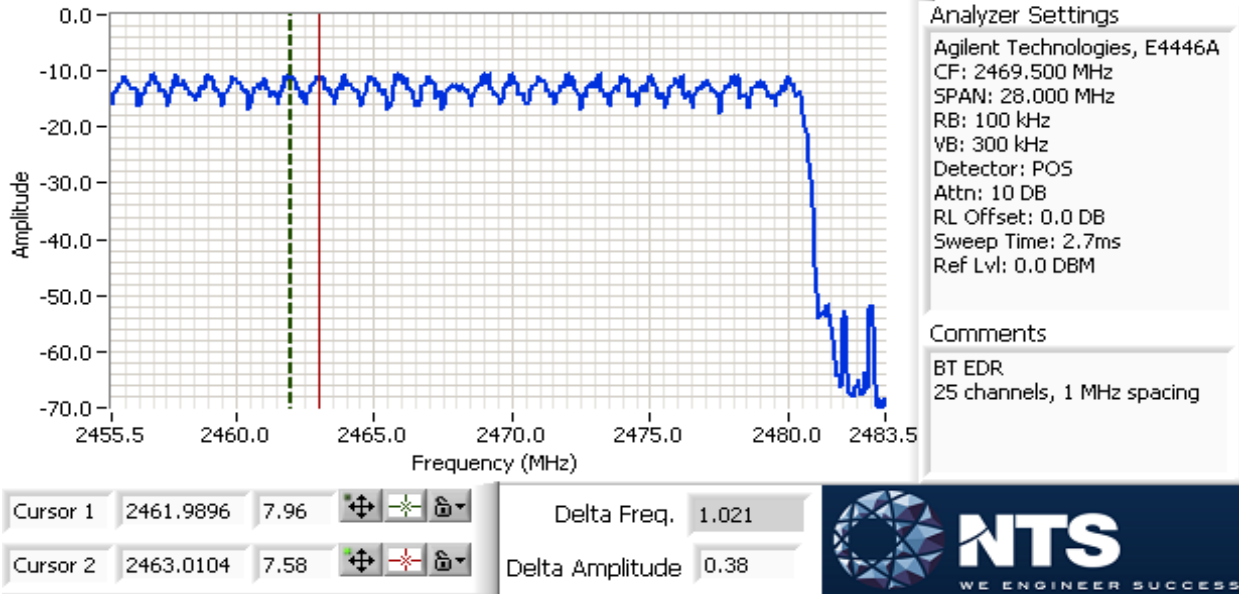

Requirement: Frequency hopping systems in the 2400-2483.5 MHz band shall use at least 15 channels. The average time of occupancy on any channel shall not be greater than 0.4 seconds within a period of 0.4 seconds multiplied by the number of hopping channels employed. (Frequency hopping systems may avoid or suppress transmissions on a particular hopping frequency provided that a minimum of 15 channels are used.)

The device complies with the Bluetooth protocol and employs a minimum of 20 of the available 79 hopping channels when employing adaptive frequency hopping and all 79 channels when not. Channels are selected in a pseudo random manner to ensure, on average, all channels are used equally.

The hopping rate is 1600 hops per second, although any one channel may be used for a single hop slot, 3 hop slots or 5 hop slots. The dwell time per channel is, therefore either 0.625ms (single slot), 1.875ms (three slot) or 3.125ms (five slot). The average time of occupancy will not exceed 0.4s in any time interval of 0.4s multiplied by the number of channels being used.



EMC Test Data

Client:	Intel Corporation	Job Number:	J94914
Model:	7265D2W	T-Log Number:	T95471
Contact:	Steve Hackett	Project Manager:	Christine Krebill
Standard:	FCC Part 15.247, 15.407, RSS-210	Project Coordinator:	-
		Class:	N/A

RSS 210 and FCC 15.247 (DSS) Radiated Spurious Emissions

Test Specific Details

Objective: The objective of this test session is to perform final qualification testing of the EUT with respect to the specification listed above.

General Test Configuration

The EUT and all local support equipment were located on the turntable for radiated spurious emissions testing. For radiated emissions testing the measurement antenna was located 3 meters from the EUT.

Ambient Conditions:

Temperature: 24 °C
Rel. Humidity: 38 %

Summary of Results - Device Operating in the 2400-2483.5 MHz Band

MAC Address: 001500F15B5D DRTU Tool Version 1.7.3-935 Driver version 17.1.0.11

Run #	Mode	Channel	Power Setting	Measured Power	Test Performed	Limit	Result / Margin
1a	Bluetooth basic rate (1Mb/s)	low	10	4.8 dBm	Restricted Band Edge (2390 MHz)	FCC Part 15.209 / 15.247(c)	34.1 dBµV/m @ 2342.1 MHz (-19.9 dB)
1b		center		5.1 dBm	Radiated Emissions, 1 - 26 GHz		No radio realated emissions
1c		high		5.0 dBm	Restricted Band Edge (2483.5 MHz)		34.3 dBµV/m @ 2483.5 MHz (-19.7 dB)
				Radiated Emissions, 1 - 26 GHz	No radio realated emissions		
2a	Bluetooth EDR (3 Mb/s)	low	6	.8 dBm	Restricted Band Edge (2390 MHz)		39.2 dBµV/m @ 2248.8 MHz (-14.8 dB)
2b		center		1.2 dBm	Radiated Emissions, 1 - 26 GHz		43.6 dBµV/m @ 2183.3 MHz (-10.4 dB)
2c		high		1.4 dBm	Restricted Band Edge (2483.5 MHz)		36.5 dBµV/m @ 2483.5 MHz (-17.5 dB)
				Radiated Emissions, 1 - 26 GHz	42.8 dBµV/m @ 9000.6 MHz (-11.2 dB)		



EMC Test Data

Client:	Intel Corporation	Job Number:	J94914
Model:	7265D2W	T-Log Number:	T95471
		Project Manager:	Christine Krebill
Contact:	Steve Hackett	Project Coordinator:	-
Standard:	FCC Part 15.247, 15.407, RSS-210	Class:	N/A

Modifications Made During Testing

No modifications were made to the EUT during testing

Deviations From The Standard

No deviations were made from the requirements of the standard.

Sample Notes

BT Address: 001500F15B61 DRTU Tool Version 1.7.3-935 Driver version 17.1.0.11

Note - the target and measured power are average powers (measured with average power sensor) and are used for reference purposes only. Power is set using "GAIN CONTROL" mode in the DRTU tool.

Antenna: antenna connected.

Basic data rate

Duty Cycle: 0.770

Correction Factor (dB) 2.3

Extended data rate

Duty Cycle: 0.770

Correction Factor (dB) 2.3

Notes:

Bluetooth uses a frequency hopping algorithm that means that the device, during normal operation, is only on a specific channel for a short period of time. The average correction factor is calculated as follows:

A maximum length packet has a duration of 5 time slots.

The hopping rate is 1600 hops/second so the maximum dwell time is 5/1600 seconds, or 3.125ms.

With a minimum of 20 hopping channels a channel will not be used more than 4 times in any 100ms period.

The maximum dwell time in a 100ms period is $4 \times 3.125\text{ms} = 12.5\text{ms}$.

The average correction factor is, therefore, $20\log(12.5/100) = -18\text{dB}$.

As this is a hopping radio this correction factor can be applied to the average value of the signal provided the average value was measured with the device continuously transmitting. DA 00-0705 permits the use of the average correction on the **measured average** value for frequency hopping radios.



EMC Test Data

Client: Intel Corporation	Job Number: J94914
Model: 7265D2W	T-Log Number: T95471
Contact: Steve Hackett	Project Manager: Christine Krebill
Standard: FCC Part 15.247, 15.407, RSS-210	Project Coordinator: -
	Class: N/A

Run #1: Radiated Spurious Emissions, 1000-25000 MHz. Operating Mode: Basic data rate (1Mb/s)

Date of Test: 6/12/2014 & 6/16/14
 Test Engineer: Jack Liu & John Caizzi
 Test Location: Chamber 7

Config Used: 1
 Config Change: none
 EUT Voltage: 3.3 VDC

Run #1a, EUT on Channel #0, 2402MHz

	Target (dBm)	Power Settings Measured (dBm)	Software Setting
Chain B	-	4.8	10dBm

Band Edge Signal Field Strength - Direct measurement of field strength

Frequency	Level	Pol	15.209 / 15.247		Detector	Azimuth	Height	Comments
MHz	dB μ V/m	v/h	Limit	Margin	PK/QP/Avg	degrees	meters	
2342.060	34.1	H	54.0	-19.9	AVG	35	1.0	Correction Factor (2.3dB) added
2326.190	40.5	H	74.0	-33.5	PK	35	1.0	
2342.060	33.3	V	54.0	-20.7	AVG	84	1.0	Correction Factor (2.3dB) added
2345.910	42.5	V	74.0	-31.5	PK	84	1.0	

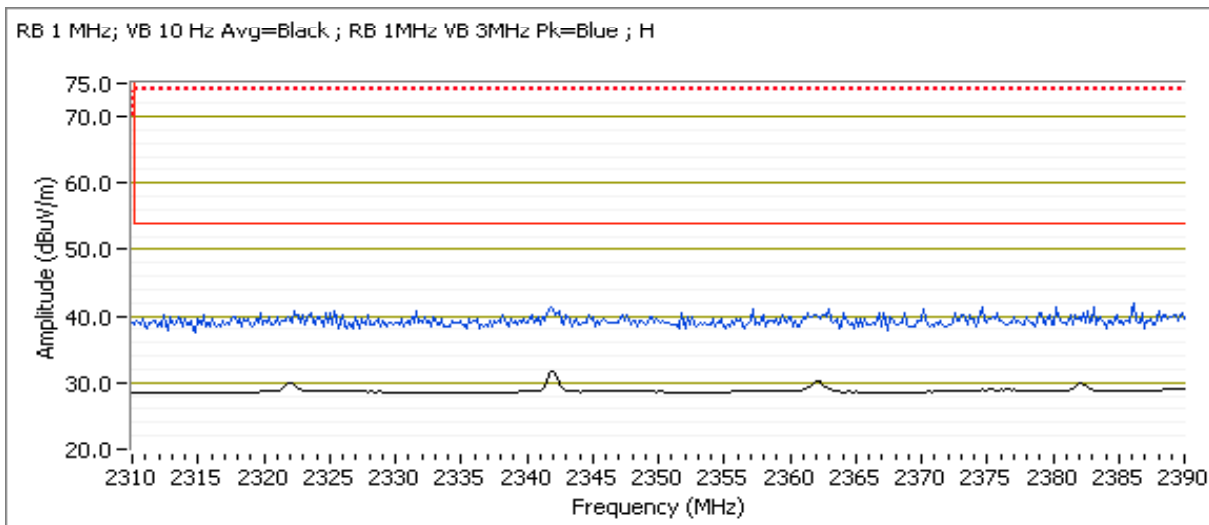

Fundamental Signal Field Strength

Frequency	Level	Pol	15.209 / 15.247		Detector	Azimuth	Height	Comments
MHz	dB μ V/m	v/h	Limit	Margin	PK/QP/Avg	degrees	meters	
2401.930	100.4	H	-	-	PK	197	1.0	POS; RB 100 kHz; VB: 100 kHz
2401.970	95.8	V	-	-	PK	212	1.0	POS; RB 100 kHz; VB: 100 kHz

Client:	Intel Corporation	Job Number:	J94914
Model:	7265D2W	T-Log Number:	T95471
Contact:	Steve Hackett	Project Manager:	Christine Krebill
Standard:	FCC Part 15.247, 15.407, RSS-210	Project Coordinator:	-
		Class:	N/A

Spurious Radiated Emissions:

Frequency	Level	Pol	15.209/15.247		Detector	Azimuth	Height	Comments
MHz	dB μ V/m	v/h	Limit	Margin	PK/QP/Avg	degrees	meters	
1516.670	46.0	V	54.0	-8.0	Peak	246	1.0	Note 2
1616.670	50.7	V	54.0	-3.3	Peak	286	1.0	Note 2
3016.670	45.3	V	54.0	-8.7	Peak	246	1.0	Note 2, note 3
4500.000	42.4	V	54.0	-11.6	Peak	286	1.0	Note 2, note 3

- Note 1: For emissions in restricted bands, the limit of 15.209 was used. For all other emissions, the limit is -20dBc for peak measurements in a measurement bandwidth of 100kHz.
- Note 2: Not radio related. See notes for 2.4GHz Wifi Spurious RE.
- Note 3: Emission in non-restricted band, but limit of 15.209 used.

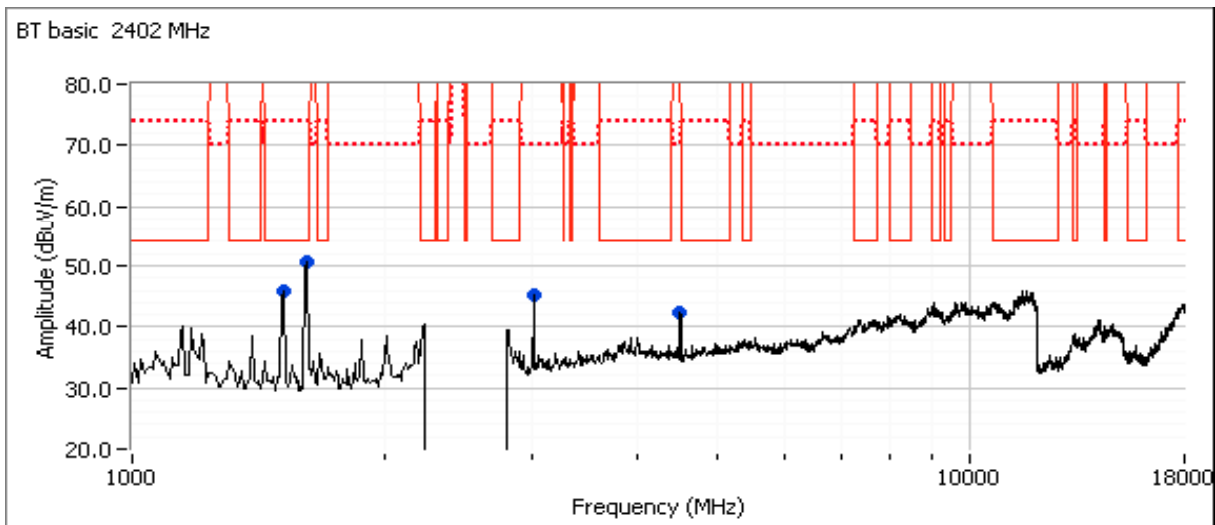



EMC Test Data

Client:	Intel Corporation	Job Number:	J94914
Model:	7265D2W	T-Log Number:	T95471
Contact:	Steve Hackett	Project Manager:	Christine Krebill
Standard:	FCC Part 15.247, 15.407, RSS-210	Project Coordinator:	-
		Class:	N/A

Run #1b: , EUT on Channel #39, 2441MHz

	Target (dBm)	Power Settings Measured (dBm)	Software Setting
Chain B	-	5.1	10dBm

Fundamental Signal Field Strength

Frequency	Level	Pol	15.209 / 15.247		Detector	Azimuth	Height	Comments
MHz	dB μ V/m	v/h	Limit	Margin	PK/QP/Avg	degrees	meters	
2440.880	100.6	H	-	-	PK	181	1.0	POS; RB 100 kHz; VB: 100 kHz
2440.880	94.4	V	-	-	PK	88	1.0	POS; RB 100 kHz; VB: 100 kHz

Spurious Radiated Emissions:

Frequency	Level	Pol	15.209/15.247		Detector	Azimuth	Height	Comments
MHz	dB μ V/m	v/h	Limit	Margin	PK/QP/Avg	degrees	meters	
1516.670	46.5	V	54.0	-7.5	Peak	246	1.0	Note 2
1608.330	49.8	V	54.0	-4.2	Peak	281	1.0	Note 2
3016.670	45.1	V	54.0	-8.9	Peak	246	1.0	Note 2, note 3
4508.330	42.6	V	54.0	-11.4	Peak	275	1.0	Note 2

- Note 1: For emissions in restricted bands, the limit of 15.209 was used. For all other emissions, the limit is -20dBc for peak measurements in a measurement bandwidth of 100kHz.
- Note 2: Not radio related. See notes for 2.4GHz Wifi Spurious RE.
- Note 3: Emission in non-restricted band, but limit of 15.209 used.
- Note 4: Scans made between 18 - 26GHz with the measurement antenna moved around the card and its antennas 20-50cm from the device indicated there were no significant emissions in this frequency range

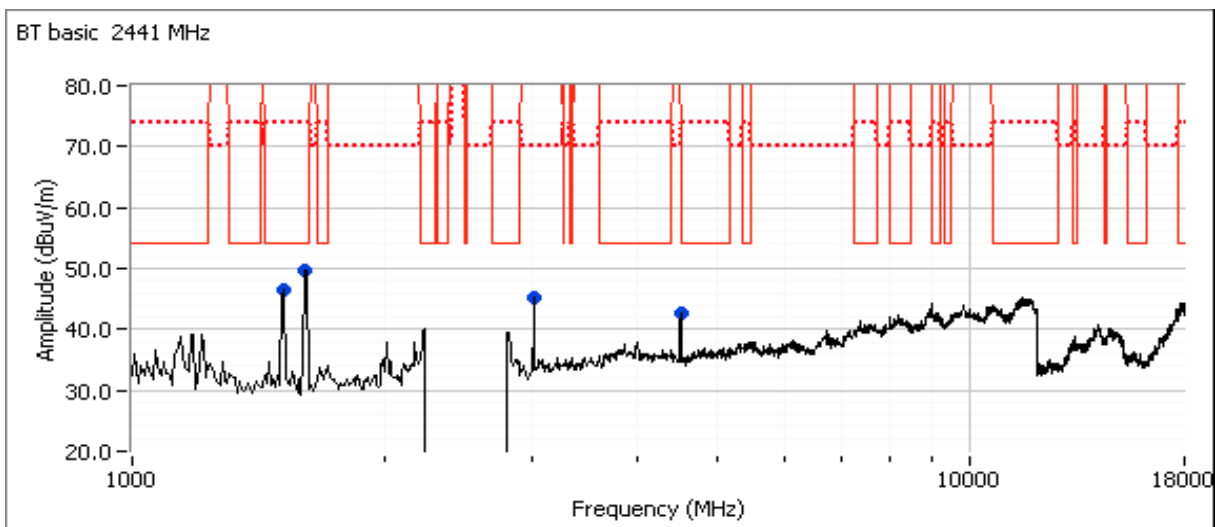

Client: Intel Corporation	Job Number: J94914
Model: 7265D2W	T-Log Number: T95471
	Project Manager: Christine Krebill
Contact: Steve Hackett	Project Coordinator: -
Standard: FCC Part 15.247, 15.407, RSS-210	Class: N/A

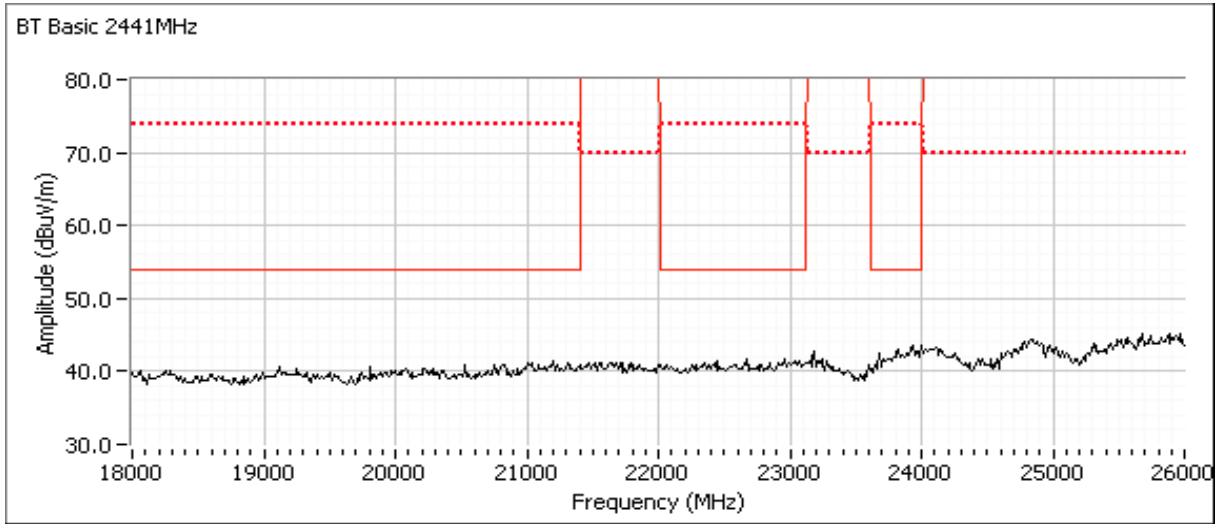



EMC Test Data

Client:	Intel Corporation	Job Number:	J94914
Model:	7265D2W	T-Log Number:	T95471
Contact:	Steve Hackett	Project Manager:	Christine Krebill
Standard:	FCC Part 15.247, 15.407, RSS-210	Project Coordinator:	-
		Class:	N/A

Run #1c: , EUT on Channel #79 2480MHz

	Target (dBm)	Power Settings Measured (dBm)	Software Setting
Chain B	-	5.0	10dBm

Band Edge Signal Field Strength - Direct measurement of field strength

Frequency	Level	Pol	15.209 / 15.247		Detector	Azimuth	Height	Comments
MHz	dB μ V/m	v/h	Limit	Margin	PK/QP/Avg	degrees	meters	
2483.500	34.3	H	54.0	-19.7	AVG	148	1.0	Correction Factor (2.3dB) added
2483.500	54.3	H	74.0	-19.7	PK	148	1.0	
2483.500	32.8	V	54.0	-21.2	AVG	199	1.0	Correction Factor (2.3dB) added
2485.120	50.1	V	74.0	-23.9	PK	199	1.0	

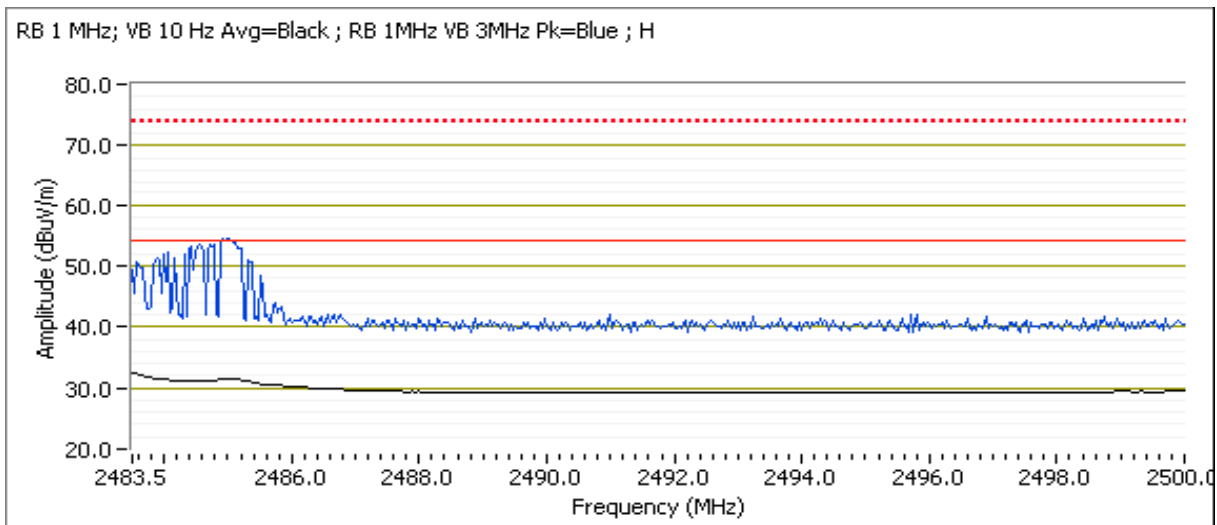

Fundamental Signal Field Strength

Frequency	Level	Pol	15.209 / 15.247		Detector	Azimuth	Height	Comments
MHz	dB μ V/m	v/h	Limit	Margin	PK/QP/Avg	degrees	meters	
2479.980	100.1	H	-	-	PK	170	1.1	POS; RB 100 kHz; VB: 100 kHz
2480.000	92.9	v/h	-	-	PK	200	1.0	POS; RB 100 kHz; VB: 100 kHz

Client:	Intel Corporation	Job Number:	J94914
Model:	7265D2W	T-Log Number:	T95471
Contact:	Steve Hackett	Project Manager:	Christine Krebill
Standard:	FCC Part 15.247, 15.407, RSS-210	Project Coordinator:	-
		Class:	N/A

Spurious Radiated Emissions:

Frequency	Level	Pol	15.209/15.247		Detector	Azimuth	Height	Comments
MHz	dB μ V/m	v/h	Limit	Margin	PK/QP/Avg	degrees	meters	
1508.330	46.0	V	54.0	-8.0	Peak	246	1.0	Note 2
1616.670	50.6	V	54.0	-3.4	Peak	275	1.0	Note 2
3016.670	46.0	V	54.0	-8.0	Peak	337	1.0	Note 2, note 3
4508.330	40.9	V	54.0	-13.1	Peak	269	1.0	Note 2

- Note 1: For emissions in restricted bands, the limit of 15.209 was used. For all other emissions, the limit is -20dBc for peak measurements in a measurement bandwidth of 100kHz.
- Note 2: Not radio related. See notes for 2.4GHz Wifi Spurious RE.
- Note 3: Emission in non-restricted band, but limit of 15.209 used.

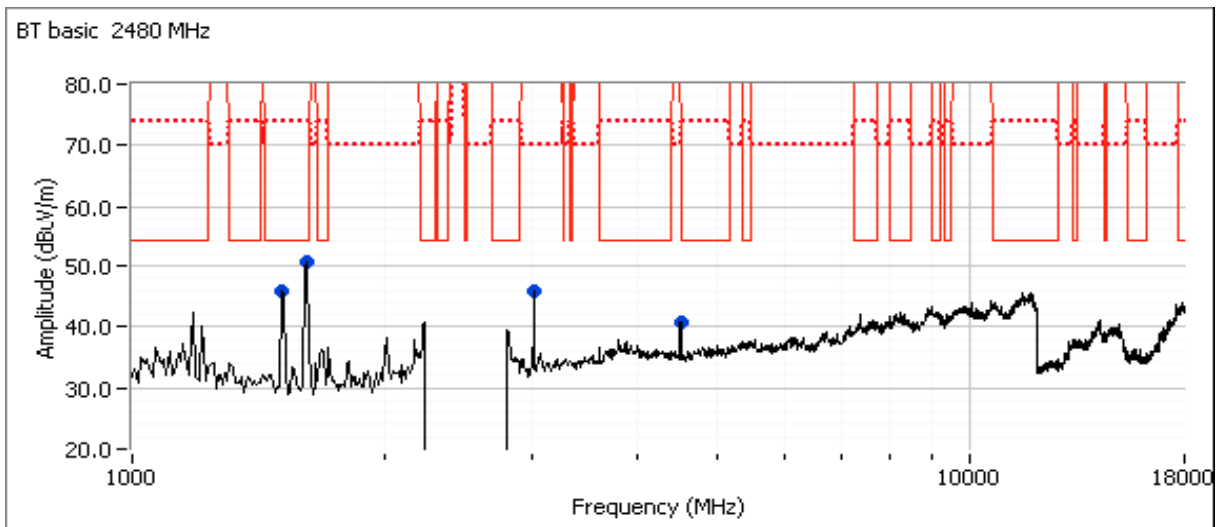



EMC Test Data

Client: Intel Corporation	Job Number: J94914
Model: 7265D2W	T-Log Number: T95471
Contact: Steve Hackett	Project Manager: Christine Krebill
Standard: FCC Part 15.247, 15.407, RSS-210	Project Coordinator: -
	Class: N/A

Run #2: Radiated Spurious Emissions, 1000-25000 MHz. Operating Mode: Extended data rate (3Mb/s)

Date of Test: 6/12/2014 & 6/16/14
 Test Engineer: Jack Liu & John Caizzi
 Test Location: Chamber 7

Config Used: 1
 Config Change: none
 EUT Voltage: 3.3 VDC

Run #2a, EUT on Channel #1 2402MHz

	Target (dBm)	Power Settings Measured (dBm)	Software Setting
Chain B	-	0.8	6dBm

Band Edge Signal Field Strength - Direct measurement of field strength

Frequency	Level	Pol	15.209 / 15.247		Detector	Azimuth	Height	Comments
MHz	dB μ V/m	v/h	Limit	Margin	Pk/QP/Avg	degrees	meters	
2248.780	39.2	H	54.0	-14.8	AVG	299	1.01	
2245.170	47.1	H	74.0	-26.9	PK	299	1.01	
2248.780	37.3	V	54.0	-16.7	AVG	212	1.08	
2246.050	45.7	V	74.0	-28.3	PK	212	1.08	

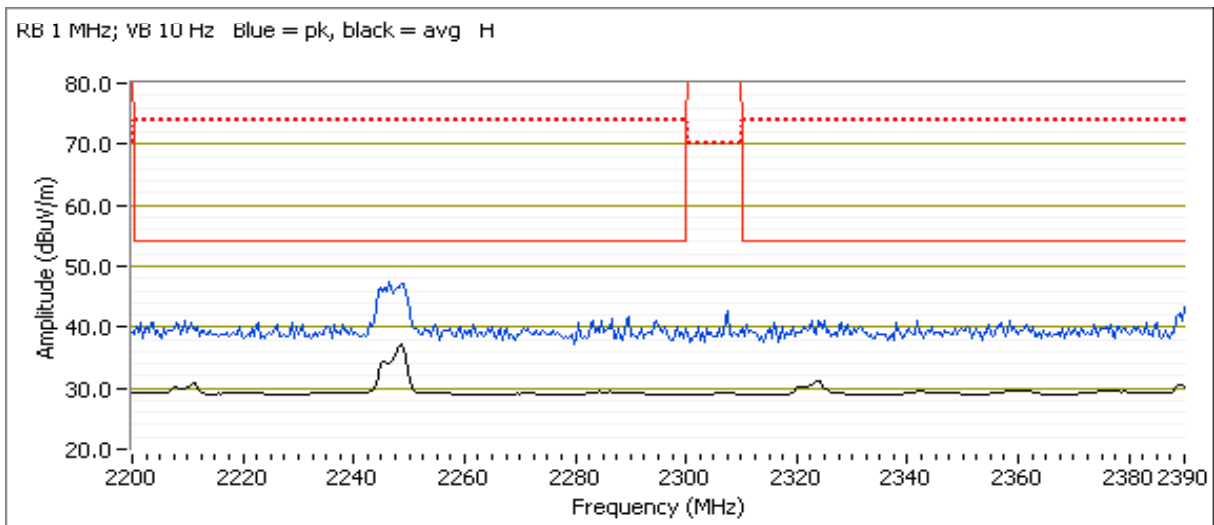

Fundamental Signal Field Strength

Frequency	Level	Pol	15.209 / 15.247		Detector	Azimuth	Height	Comments
MHz	dB μ V/m	v/h	Limit	Margin	Pk/QP/Avg	degrees	meters	
2401.810	96.8	H	-	-	Pk	195	1.25	RB 100 kHz; VB: 300 kHz



EMC Test Data

Client: Intel Corporation	Job Number: J94914
Model: 7265D2W	T-Log Number: T95471
Contact: Steve Hackett	Project Manager: Christine Krebill
Standard: FCC Part 15.247, 15.407, RSS-210	Project Coordinator: -
	Class: N/A

Spurious Radiated Emissions:

Frequency MHz	Level dB μ V/m	Pol v/h	15.209/15.247		Detector PK/QP/Avg	Azimuth degrees	Height meters	Comments
			Limit	Margin				
2183.330	43.6	H	54.0	-10.4	Peak	296	1.0	Note 3
1516.670	46.4	V	54.0	-7.6	Peak	246	1.0	Note 2
1608.330	50.6	V	54.0	-3.4	Peak	286	1.0	Note 2
3016.670	46.1	V	54.0	-7.9	Peak	275	1.0	Note 2, note 3
4508.330	42.6	V	54.0	-11.4	Peak	281	1.0	Note 2
2167.860	37.8	H	54.0	-16.2	AVG	302	1.0	Note 3
2156.130	53.5	H	74.0	-20.5	PK	302	1.0	Note 3

- Note 1: For emissions in restricted bands, the limit of 15.209 was used. For all other emissions, the limit is -20dBc for peak measurements in a measurement bandwidth of 100kHz.
- Note 2: Not radio related. See notes for 2.4GHz Wifi Spurious RE.
- Note 3: Emission in non-restricted band, but limit of 15.209 used.

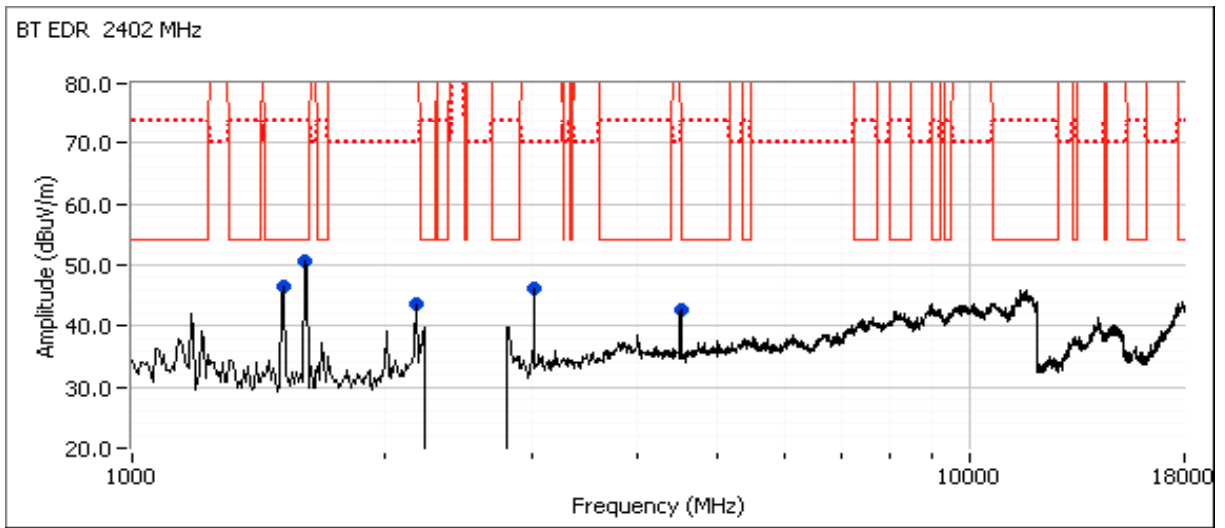



EMC Test Data

Client:	Intel Corporation	Job Number:	J94914
Model:	7265D2W	T-Log Number:	T95471
Contact:	Steve Hackett	Project Manager:	Christine Krebill
Standard:	FCC Part 15.247, 15.407, RSS-210	Project Coordinator:	-
		Class:	N/A

Run #2b: , EUT on Channel #39, 2441MHz

	Target (dBm)	Power Settings Measured (dBm)	Software Setting
Chain B	-	1.2	6dBm

Fundamental Signal Field Strength

Frequency	Level	Pol	15.209 / 15.247		Detector	Azimuth	Height	Comments
MHz	dB μ V/m	v/h	Limit	Margin	PK/QP/Avg	degrees	meters	
2440.970	98.9	H	-	-	Pk	187	1.12	RB 100 kHz;VB 300 kHz;Peak

Spurious Radiated Emissions:

Frequency	Level	Pol	15.209/15.247		Detector	Azimuth	Height	Comments
MHz	dB μ V/m	v/h	Limit	Margin	PK/QP/Avg	degrees	meters	
1516.670	45.0	V	54.0	-9.0	Peak	226	1.0	Note 2
1616.670	50.7	V	54.0	-3.3	Peak	266	1.0	Note 2
3016.670	46.0	V	54.0	-8.0	Peak	272	1.0	Note 2, note 3
4500.000	43.4	V	54.0	-10.6	Peak	277	1.0	Note 2, note 3

- Note 1: For emissions in restricted bands, the limit of 15.209 was used. For all other emissions, the limit is -20dBc for peak measurements in a measurement bandwidth of 100kHz.
- Note 2: Not radio related. See notes for 2.4GHz Wifi Spurious RE.
- Note 3: Emission in non-restricted band, but limit of 15.209 used.
- Note 4: Scans made between 18 - 26GHz with the measurement antenna moved around the card and its antennas 20-50cm from the device indicated there were no significant emissions in this frequency range

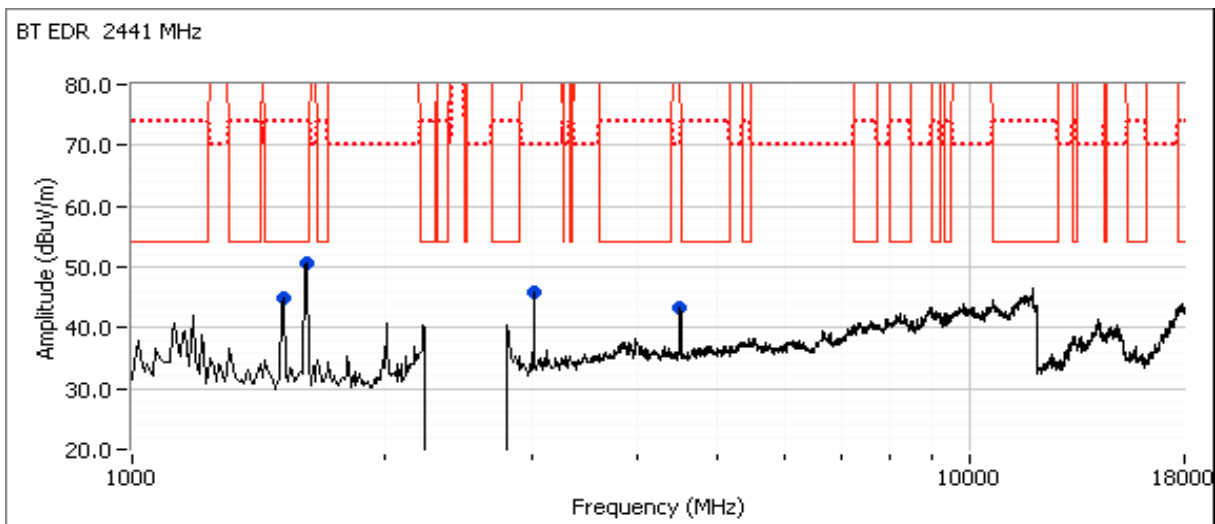

Client: Intel Corporation	Job Number: J94914
Model: 7265D2W	T-Log Number: T95471
	Project Manager: Christine Krebill
Contact: Steve Hackett	Project Coordinator: -
Standard: FCC Part 15.247, 15.407, RSS-210	Class: N/A

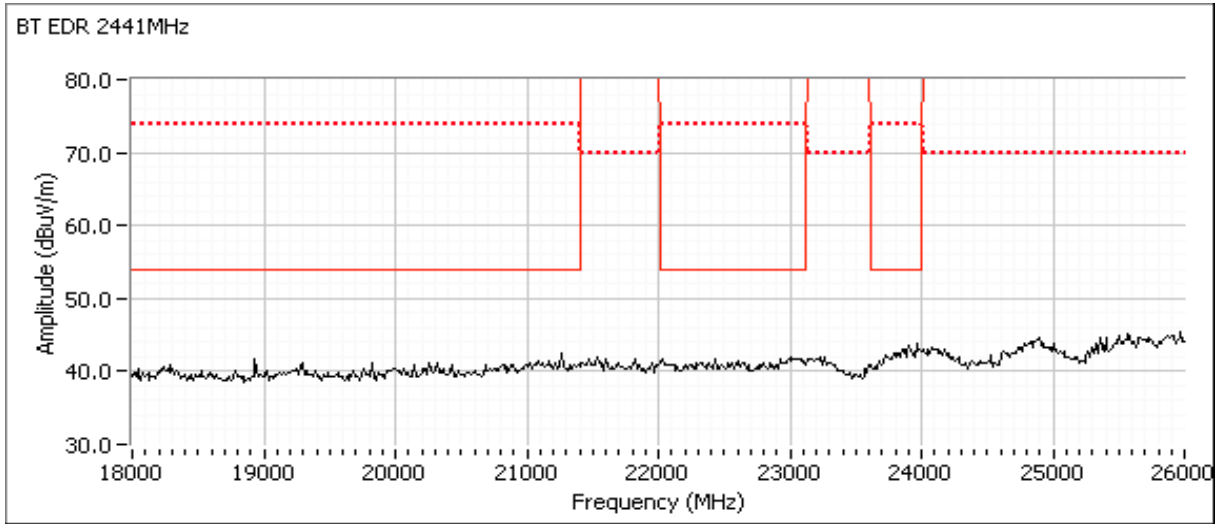



EMC Test Data

Client:	Intel Corporation	Job Number:	J94914
Model:	7265D2W	T-Log Number:	T95471
Contact:	Steve Hackett	Project Manager:	Christine Krebill
Standard:	FCC Part 15.247, 15.407, RSS-210	Project Coordinator:	-
		Class:	N/A

Run #2c: , EUT on Channel #79 2480MHz

	Target (dBm)	Power Settings Measured (dBm)	Software Setting
Chain B	-	1.4	6dBm

Band Edge Signal Field Strength - Direct measurement of field strength

Frequency	Level	Pol	15.209 / 15.247		Detector	Azimuth	Height	Comments
MHz	dB μ V/m	v/h	Limit	Margin	Pk/QP/Avg	degrees	meters	
2483.500	36.5	H	54.0	-17.5	AVG	170	1.2	Correction Factor (2.3dB) added
2483.670	55.3	H	74.0	-18.7	PK	170	1.2	
2483.500	33.4	V	54.0	-20.6	AVG	198	1.0	Correction Factor (2.3dB) added
2484.000	49.9	V	74.0	-24.1	PK	198	1.0	

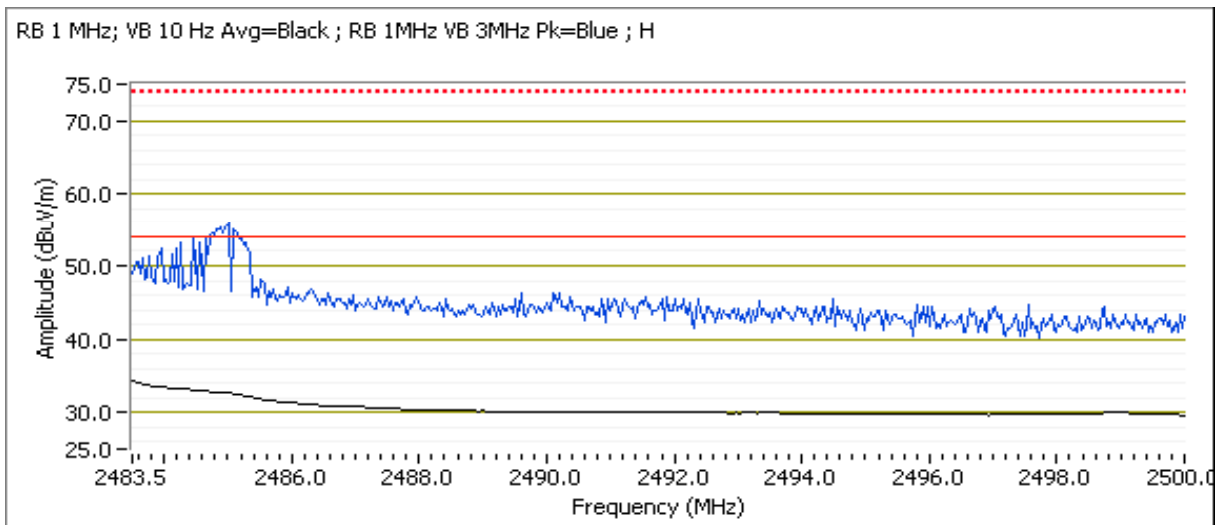

Fundamental Signal Field Strength

Frequency	Level	Pol	15.209 / 15.247		Detector	Azimuth	Height	Comments
MHz	dB μ V/m	v/h	Limit	Margin	Pk/QP/Avg	degrees	meters	
2480.080	96.4	H	-	-	PK	170	1.2	POS; RB 100 kHz; VB: 100 kHz
2480.300	88.4	V	-	-	PK	203	1.0	POS; RB 100 kHz; VB: 100 kHz



EMC Test Data

Client:	Intel Corporation	Job Number:	J94914
Model:	7265D2W	T-Log Number:	T95471
Contact:	Steve Hackett	Project Manager:	Christine Krebill
Standard:	FCC Part 15.247, 15.407, RSS-210	Project Coordinator:	-
		Class:	N/A

Spurious Radiated Emissions:

Frequency MHz	Level dB μ V/m	Pol v/h	15.209/15.247		Detector PK/QP/Avg	Azimuth degrees	Height meters	Comments
			Limit	Margin				
9000.600	42.8	V	54.0	-11.2	AVG	284	1.00	
9001.050	52.4	V	74.0	-21.6	PK	284	1.00	
1516.670	45.7	V	54.0	-8.3	Peak	232	1.0	Note 2
1608.330	50.8	V	54.0	-3.2	Peak	267	1.0	Note 2
3016.670	46.3	V	54.0	-7.7	Peak	272	1.0	Note 2, note 3
4508.330	43.1	V	54.0	-10.9	Peak	272	1.0	Note 2

- Note 1: For emissions in restricted bands, the limit of 15.209 was used. For all other emissions, the limit is -20dBc for peak measurements in a measurement bandwidth of 100kHz.
- Note 2: Not radio related. See notes for 2.4GHz Wifi Spurious RE.
- Note 3: Emission in non-restricted band, but limit of 15.209 used.

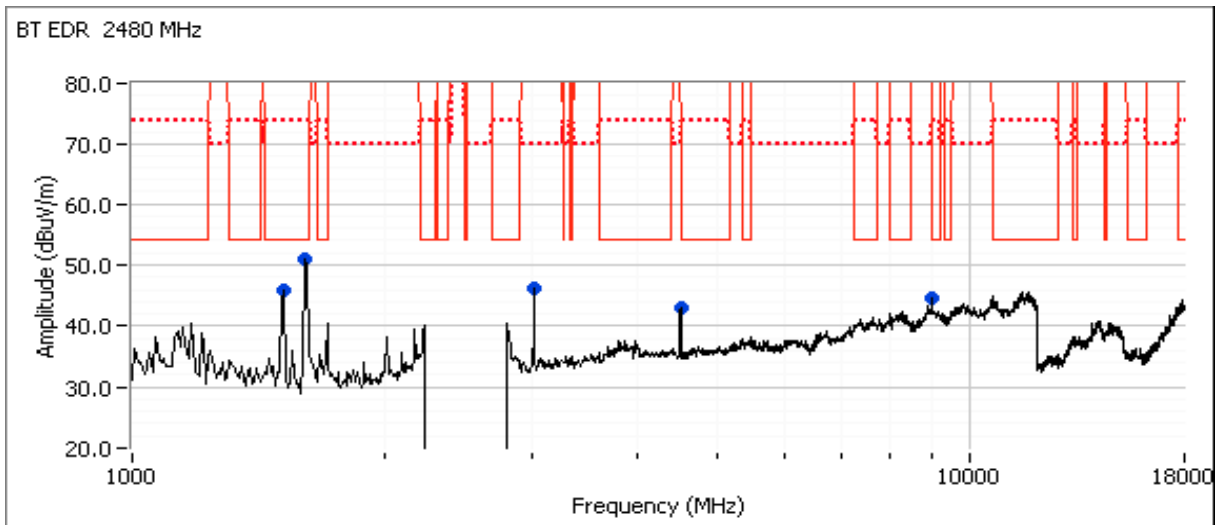



EMC Test Data

Client:	Intel Corporation	Job Number:	J94914
Product:	7265D2W	T-Log Number:	T95472
		Project Manager:	Christine Krebill
Contact:	Steve Hackett	Project Coordinator:	-
Emissions Standard(s):	FCC Part 15.247, 15.407, RSS-210	Class:	B
Immunity Standard(s):	-	Environment:	Radio

EMC Test Data

For The

Intel Corporation

Product

7265D2W

Date of Last Test: 7/8/2014



EMC Test Data

Client:	Intel Corporation	Job Number:	J94914
Model:	7265D2W	T-Log Number:	T95472
		Project Manager:	Christine Krebill
Contact:	Steve Hackett	Project Coordinator:	-
Standard:	FCC Part 15.247, 15.407, RSS-210	Class:	N/A

RSS 210 and FCC 15.247 (DTS) Radiated Spurious Emissions

Test Specific Details

Objective: The objective of this test session is to perform final qualification testing of the EUT with respect to the specification listed above.

General Test Configuration

The EUT and all local support equipment were located on the turntable for radiated spurious emissions testing. For radiated emissions testing the measurement antenna was located 3 meters from the EUT.

For Bluetooth: Tx is chain B, Rx is chain B. **For WiFi,** only Chain A is used for transmit in the 2.4GHz band when Bluetooth is active, both chains can be used in 5GHz bands.

Ambient Conditions:

Temperature: 24 °C
Rel. Humidity: 39 %

Summary of Results

MAC Address: 001500F15B3A DRTU Tool Version 1.7.3-935 Driver version 17.1.0.11

Run #	Mode	Channel	Power Setting	Measured Power	Test Performed	Limit	Result / Margin
1	BT 1Mb/s 802.11b	2402MHz 2412MHz	10 14.5	4.8 17.6	Radiated Emissions 1- 10 GHz	FCC 15.247	56.8 dBµV/m @ 1199.1 MHz (-17.2 dB)
2	BT 1Mb/s 802.11b	2480MHz 2462MHz	10 14.0	5.0 17.7		FCC 15.247	43.5 dBµV/m @ 4924.0 MHz (-10.5 dB)
3	BT 1Mb/s 802.11g	2402MHz 2412MHz	10 20.5	4.8 17.7		FCC 15.247	56.3 dBµV/m @ 1196.0 MHz (-17.7 dB)
4	BT 1Mb/s 802.11g	2480MHz 2462MHz	10 19.5	5.0 17.5		FCC 15.247	53.3 dBµV/m @ 1198.7 MHz (-20.7 dB)



EMC Test Data

Client:	Intel Corporation	Job Number:	J94914
Model:	7265D2W	T-Log Number:	T95472
Contact:	Steve Hackett	Project Manager:	Christine Krebill
Standard:	FCC Part 15.247, 15.407, RSS-210	Project Coordinator:	-
		Class:	N/A

Run #	Mode	Channel	Power Setting	Measured Power	Test Performed	Limit	Result / Margin
WiFi mode for the following runs based on worst case mode from runs 1 through 4							
5	BT 1Mb/s 802.11b	2402MHz 2437MHz	10 14	4.8 17.7	Radiated Emissions 1- 10 GHz	FCC 15.247	46.1 dBµV/m @ 2366.1 MHz (-7.9 dB)
6	BT 1Mb/s 802.11b	2440MHz 2412MHz	10 14.5	5.1 17.6		FCC 15.247	41.9 dBµV/m @ 2356.8 MHz (-12.1 dB)
7	BT 1Mb/s 802.11b	2440MHz 2462MHz	10 14	5.1 17.7	Radiated Emissions 1- 10 GHz	FCC 15.247	41.3 dBµV/m @ 4924.0 MHz (-12.7 dB)
8	BT 1Mb/s 802.11b	2480MHz 2437MHz	10 14	5.0 17.7		FCC 15.247	41.1 dBµV/m @ 4874.0 MHz (-12.9 dB)

WiFi mode and channel and Bluetooth channel based on the worst case mode from runs 1 through 8							
9	BT 3Mb/s 802.11b	2440 MHz 2462 MHz	6 14	1.2 17.7	Radiated Emissions 1- 10 GHz	FCC 15.247	41.4 dBµV/m @ 4924.0 MHz (-12.6 dB)
10	BTLE 802.11b	2440 MHz 2462 MHz	Default 14	3.2 17.7		FCC 15.247	43.5 dBµV/m @ 4924.0 MHz (-10.5 dB)

WiFi mode - 802.11n 20MHz with both chains active at 16.5 dBm per chain, center channel in each 5GHz band. Bluetooth on center channel, 1Mb/s mode							
11	BT 1Mb/s 802.11n20	2440MHz 5200MHz	10 31.0 / 32.0	5.1 16.6 / 16.5	Radiated Emissions 1- 15 GHz	FCC 15.247	No intermodulation founded Other Emissions refer to the spurious RE results
12	BT 1Mb/s 802.11n20	2440MHz 5300MHz	10 32.0 / 33.0	5.1 16.6 / 16.5		FCC 15.247	No intermodulation founded Other Emissions refer to the spurious RE results
13	BT 1Mb/s 802.11n20	2440MHz 5580MHz	10 28.5 / 29.5	5.1 16.5 / 16.6		FCC 15.247	No intermodulation founded Other Emissions refer to the spurious RE results
14	BT 1Mb/s 802.11n20	2440MHz 5785MHz	10 34.5 / 35.5	5.1 16.7 / 16.5		FCC 15.247	No intermodulation founded Other Emissions refer to the spurious RE results



EMC Test Data

Client:	Intel Corporation	Job Number:	J94914
Model:	7265D2W	T-Log Number:	T95472
		Project Manager:	Christine Krebill
Contact:	Steve Hackett	Project Coordinator:	-
Standard:	FCC Part 15.247, 15.407, RSS-210	Class:	N/A

Modifications Made During Testing

No modifications were made to the EUT during testing

Deviations From The Standard

No deviations were made from the requirements of the standard.

Notes:

Bluetooth uses a frequency hopping algorithm that means that the device, during normal operation, is only on a specific channel for a short period of time. The average correction factor is calculated as follows:

A maximum length packet has a duration of 5 time slots.

The hopping rate is 1600 hops/second so the maximum dwell time is 5/1600 seconds, or 3.125ms.

With a minimum of 20 hopping channels a channel will not be used more than 4 times in any 100ms period.

The maximum dwell time in a 100ms period is $4 \times 3.125\text{ms} = 12.5\text{ms}$.

The average correction factor is, therefore, $20\log(12.5/100) = -18\text{dB}$

As this is a hopping radio this correction factor can be applied to the average value of the signal provided the average value was measured with the device continuously transmitting. DA 00-0705 permits the use of the average correction on the **measured average** value for frequency hopping radios.

All measurements in this data sheet do not include the average correction factor.

Antenna: Skycross WiMax/WLAN



EMC Test Data

Client: Intel Corporation	Job Number: J94914
Model: 7265D2W	T-Log Number: T95472
	Project Manager: Christine Krebill
Contact: Steve Hackett	Project Coordinator: -
Standard: FCC Part 15.247, 15.407, RSS-210	Class: N/A

Run #1: 1-10GHz, 802.11b @ 2412 MHz Chain A, BT Basic Rate @ 2402 MHz Chain B
 Date of Test: 6/18/2014 Test Location: FT Chamber #4
 Test Engineer: Jack Liu Config Change: None

	Target (dBm)	Power Settings Measured (dBm)	Software Setting
Chain A	16.5	17.6	14.5
Chain B	-	4.8	10.0

Note - measured power in table above is average power, for reference only.

Perform normal 1-10 GHz scan with filter for fundamental and then 2-3 GHz scan 20-30 cm from the product without filter.

Preliminary Measurements (Peak versus average limit)

Frequency	Level	Pol	15.209/15.247		Detector	Azimuth	Height	Comments
MHz	dB μ V/m	v/h	Limit	Margin	Pk/QP/Avg	degrees	meters	
1200.000	46.6	V	54.0	-7.4	Peak	220	1.0	
1825.000	52.6	V	70.0	-17.4	Peak	60	2.2	
1591.670	42.4	V	54.0	-11.6	Peak	260	1.6	

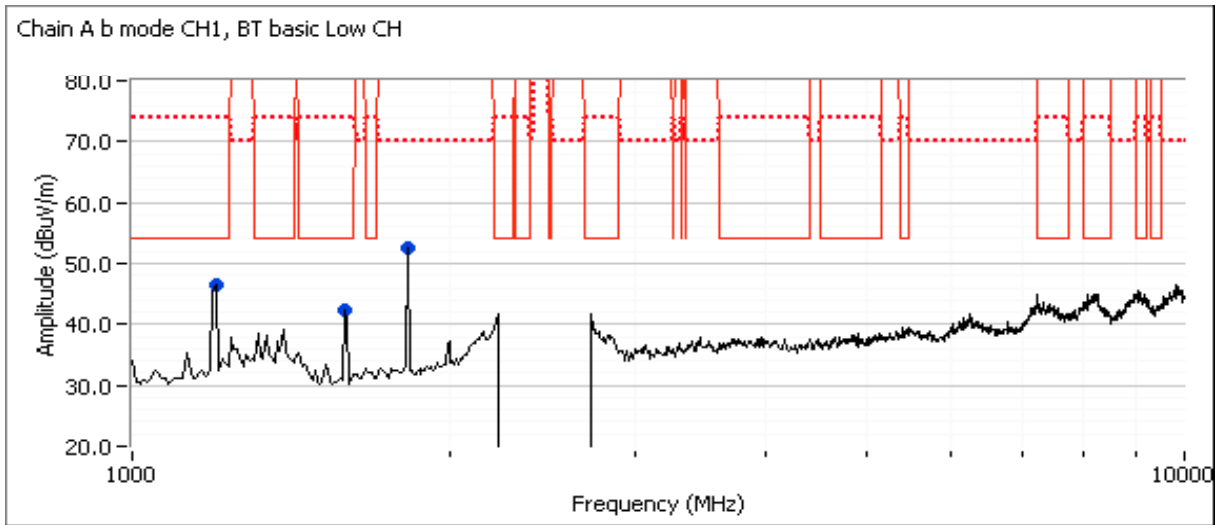



EMC Test Data

Client:	Intel Corporation	Job Number:	J94914
Model:	7265D2W	T-Log Number:	T95472
Contact:	Steve Hackett	Project Manager:	Christine Krebill
Standard:	FCC Part 15.247, 15.407, RSS-210	Project Coordinator:	-
		Class:	N/A

Spurious Emissions excluding allocated band (final measurements at 3m)

Frequency MHz	Level dB μ V/m	Pol v/h	15.209 / 15.247		Detector PK/QP/Avg	Azimuth degrees	Height meters	Comments
			Limit	Margin				
1196.800	31.4	V	54.0	-22.6	AVG	237	1.0	RB 1 MHz;VB 10 Hz;Peak
1199.130	56.8	V	74.0	-17.2	PK	237	1.0	RB 1 MHz;VB 3 MHz;Peak
1819.800	27.3	V	54.0	-26.7	AVG	195	1.9	Note 2
1819.600	39.2	V	74.0	-34.8	PK	195	1.9	Note 2
1594.340	31.2	V	54.0	-22.8	AVG	61	1.6	RB 1 MHz;VB 10 Hz;Peak
1594.940	47.0	V	74.0	-27.0	PK	61	1.6	RB 1 MHz;VB 3 MHz;Peak

Preliminary Measurements (Peak versus average limit) at 20-30cm from EUT

Frequency MHz	Level dB μ V/m	Pol v/h	15.209/15.247		Detector PK/QP/Avg	Azimuth degrees	Height meters	Comments
			Limit	Margin				
2460.920	55.9	H	-	-	Peak	180	1.0	In band intermittent signal
2573.150	43.6	H	54.0	-10.4	Peak	180	1.0	Note 2

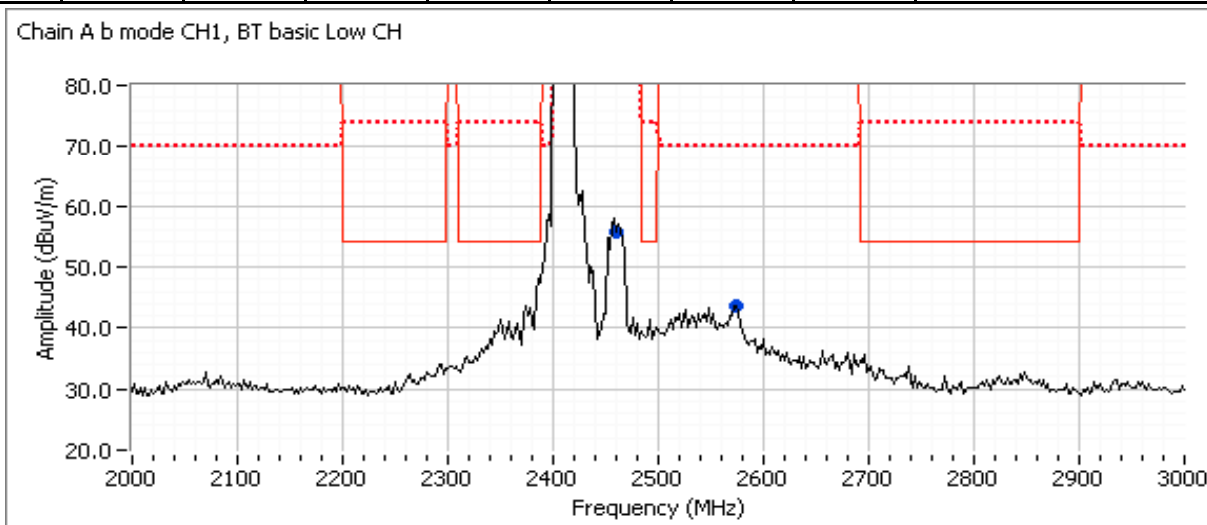

Spurious Emissions near allocated band (final measurements at 3m)

Frequency MHz	Level dB μ V/m	Pol v/h	15.209 / 15.247		Detector PK/QP/Avg	Azimuth degrees	Height meters	Comments
			Limit	Margin				
2573.150	43.6	H	54.0	-10.4	Peak	180	1.0	Note 2

No intermodulation founded

- Note 1: For emissions in restricted bands, the limit of 15.209 was used. For all other emissions, the limit was set 20dB below the level of the fundamental and measured in 100kHz.
- Note 2: Signal is not in a restricted band but the more stringent restricted band limit was used.
- Note 3: Signal is only present when Bluetooth is enabled, average correction for hopping occupancy could be applied



EMC Test Data

Client:	Intel Corporation	Job Number:	J94914
Model:	7265D2W	T-Log Number:	T95472
Contact:	Steve Hackett	Project Manager:	Christine Krebill
Standard:	FCC Part 15.247, 15.407, RSS-210	Project Coordinator:	-
		Class:	N/A

Run #2: 1-10GHz, 802.11b @ 2462 MHz Chain A, BT Basic Rate @ 2480 MHz Chain B
 Date of Test: 6/18/2014 Test Location: FT Chamber #4
 Test Engineer: Jack Liu / R. Varelas Config Change: None

	Power Settings		
	Target (dBm)	Measured (dBm)	Software Setting
Chain A	16.5	17.7	14.0
Chain B	-	5.0	10.0

Note - measured power in table above is average power, for reference only.

Perform normal 1-10 GHz scan with filter for fundamental and then 2-3 GHz scan 20-30 cm from the product without filter.

Preliminary Measurements (Peak versus average limit)

Frequency	Level	Pol	15.209/15.247		Detector	Azimuth	Height	Comments
MHz	dB μ V/m	v/h	Limit	Margin	PK/QP/Avg	degrees	meters	
1191.670	43.8	H	54.0	-10.2	Peak	113	1.5	
1591.670	38.7	V	54.0	-15.3	Peak	126	2.0	
4925.000	46.2	V	54.0	-7.8	Peak	143	1.5	

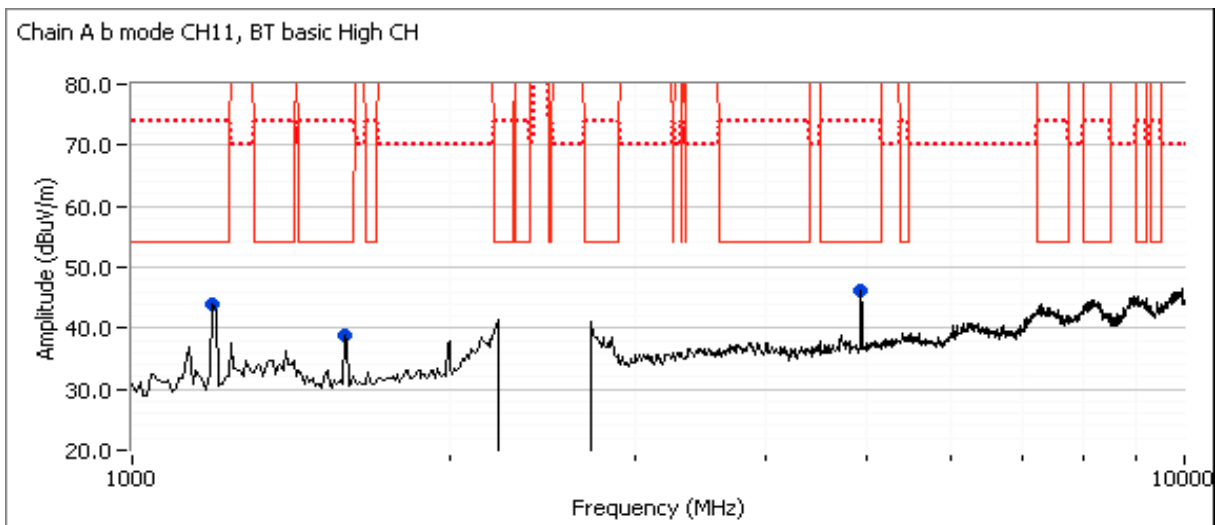



EMC Test Data

Client:	Intel Corporation	Job Number:	J94914
Model:	7265D2W	T-Log Number:	T95472
Contact:	Steve Hackett	Project Manager:	Christine Krebill
Standard:	FCC Part 15.247, 15.407, RSS-210	Project Coordinator:	-
		Class:	N/A

Spurious Emissions excluding allocated band (final measurements at 3m)

Frequency MHz	Level dB μ V/m	Pol v/h	15.209 / 15.247		Detector PK/QP/Avg	Azimuth degrees	Height meters	Comments
			Limit	Margin				
4923.980	43.5	V	54.0	-10.5	AVG	207	1.0	RB 1 MHz;VB 10 Hz;Peak
4924.070	49.0	V	74.0	-25.0	PK	207	1.0	RB 1 MHz;VB 3 MHz;Peak
1174.670	30.3	H	54.0	-23.7	AVG	252	1.7	RB 1 MHz;VB 10 Hz;Peak
1195.670	48.7	H	74.0	-25.3	PK	252	1.7	RB 1 MHz;VB 3 MHz;Peak
1597.800	30.3	V	54.0	-23.7	AVG	284	1.8	RB 1 MHz;VB 10 Hz;Peak
1597.470	48.6	V	74.0	-25.4	PK	284	1.8	RB 1 MHz;VB 3 MHz;Peak

Preliminary Measurements (Peak versus average limit) at 20-30cm from EUT

Frequency MHz	Level dB μ V/m	Pol v/h	15.209/15.247		Detector PK/QP/Avg	Azimuth degrees	Height meters	Comments
			Limit	Margin				
2488.980	53.1	H	-	-	Peak	180	1.0	Refer to Band Edge test result
2623.250	41.0	H	54.0	-13.0	Peak	180	1.0	Note 2

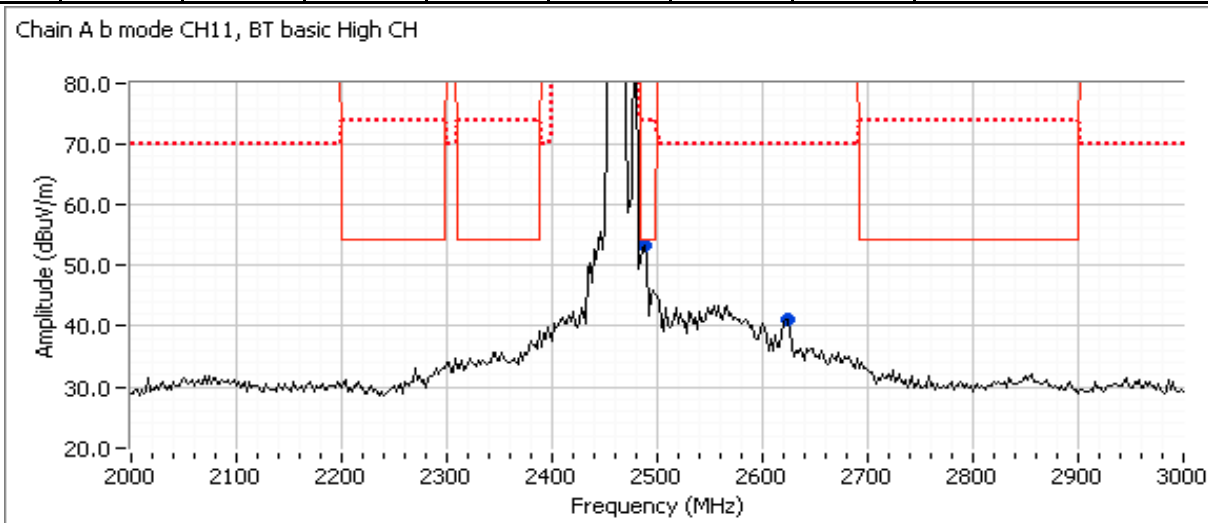

Spurious Emissions near allocated band (final measurements at 3m)

Frequency MHz	Level dB μ V/m	Pol v/h	15.209 / 15.247		Detector PK/QP/Avg	Azimuth degrees	Height meters	Comments
			Limit	Margin				
2623.250	41.0	H	54.0	-13.0	Peak	180	1.0	Note 2

No intermodulation founded

- Note 1: For emissions in restricted bands, the limit of 15.209 was used. For all other emissions, the limit was set 20dB below the level of the fundamental and measured in 100kHz.
- Note 2: Signal is not in a restricted band but the more stringent restricted band limit was used.
- Note 3: Signal is only present when Bluetooth is enabled, average correction for hopping occupancy could be applied.



EMC Test Data

Client: Intel Corporation	Job Number: J94914
Model: 7265D2W	T-Log Number: T95472
Contact: Steve Hackett	Project Manager: Christine Krebill
Standard: FCC Part 15.247, 15.407, RSS-210	Project Coordinator: -
	Class: N/A

Run #3: 1-10GHz, 802.11g @ 2412 MHz Chain A, BT Basic Rate @ 2402 MHz Chain B
 Date of Test: 6/18/2014 Test Location: FT Chamber #4
 Test Engineer: Jack Liu / R. Varelas Config Change: None

	Power Settings		
	Target (dBm)	Measured (dBm)	Software Setting
Chain A	14.0	17.7	20.5
Chain B	-	5.0	10.0

Note - measured power in table above is average power, for reference only.

Perform normal 1-10 GHz scan with filter for fundamental and then 2-3 GHz scan 20-30 cm from the product without filter.

Preliminary Measurements (Peak versus average limit)

Frequency	Level	Pol	15.209/15.247		Detector	Azimuth	Height	Comments
MHz	dB μ V/m	v/h	Limit	Margin	Pk/QP/Avg	degrees	meters	
1191.670	46.3	V	54.0	-7.7	Peak	232	1.0	
1241.670	40.0	H	70.0	-30.0	Peak	216	1.0	
1591.670	40.4	V	54.0	-13.6	Peak	108	2.0	

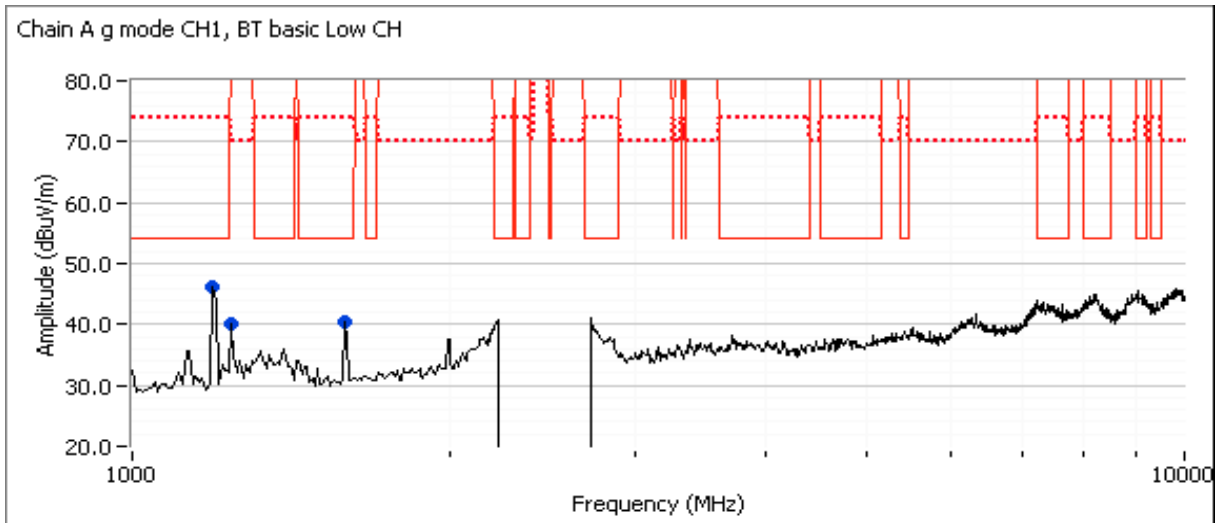

Client:	Intel Corporation	Job Number:	J94914
Model:	7265D2W	T-Log Number:	T95472
Contact:	Steve Hackett	Project Manager:	Christine Krebill
Standard:	FCC Part 15.247, 15.407, RSS-210	Project Coordinator:	-
		Class:	N/A

Spurious Emissions excluding allocated band (final measurements at 3m)

Frequency	Level	Pol	15.209 / 15.247		Detector	Azimuth	Height	Comments
MHz	dB μ V/m	v/h	Limit	Margin	PK/QP/Avg	degrees	meters	
1197.000	31.8	V	54.0	-22.2	AVG	227	1.0	RB 1 MHz;VB 10 Hz;Peak
1196.000	56.3	V	74.0	-17.7	PK	227	1.0	RB 1 MHz;VB 3 MHz;Peak
1260.940	29.1	H	54.0	-24.9	AVG	129	1.4	Note 2
1241.070	42.8	H	74.0	-31.2	PK	129	1.4	Note 2
1594.540	30.9	V	54.0	-23.1	AVG	80	1.5	RB 1 MHz;VB 10 Hz;Peak
1594.070	46.2	V	74.0	-27.8	PK	80	1.5	RB 1 MHz;VB 3 MHz;Peak

Preliminary Measurements (Peak versus average limit) at 20-30cm from EUT

Frequency	Level	Pol	15.209/15.247		Detector	Azimuth	Height	Comments
MHz	dB μ V/m	v/h	Limit	Margin	PK/QP/Avg	degrees	meters	
2462.930	55.3	V	-	-	Peak	180	1.0	In band intermittent signal
2384.770	54.8	V	-	-	Peak	180	1.0	Refer to Band Edge test result

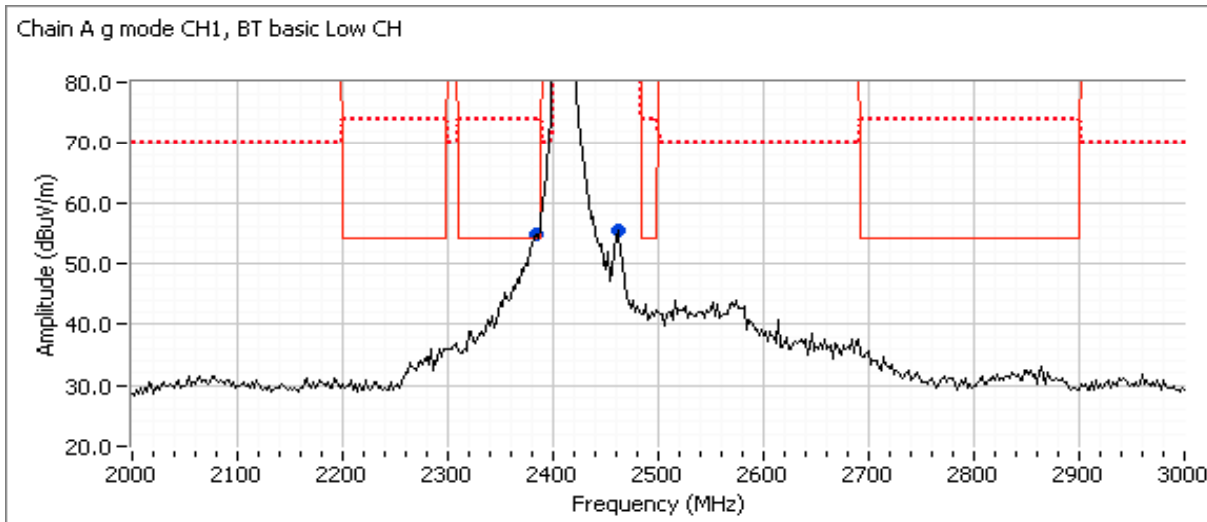

Spurious Emissions near allocated band (final measurements at 3m)

Frequency	Level	Pol	15.209 / 15.247		Detector	Azimuth	Height	Comments
MHz	dB μ V/m	v/h	Limit	Margin	PK/QP/Avg	degrees	meters	

No intermodulation founded

- Note 1: For emissions in restricted bands, the limit of 15.209 was used. For all other emissions, the limit was set 20dB below the level of the fundamental and measured in 100kHz.
- Note 2: Signal is not in a restricted band but the more stringent restricted band limit was used.
- Note 3: Signal is only present when Bluetooth is enabled, average correction for hopping occupancy could be applied



EMC Test Data

Client:	Intel Corporation	Job Number:	J94914
Model:	7265D2W	T-Log Number:	T95472
Contact:	Steve Hackett	Project Manager:	Christine Krebill
Standard:	FCC Part 15.247, 15.407, RSS-210	Project Coordinator:	-
		Class:	N/A

Run #4: 1-10GHz, 802.11g @ 2462 MHz Chain A, BT Basic Rate @ 2480 MHz Chain B
 Date of Test: 6/18/2014 Test Location: FT Chamber #4
 Test Engineer: Jack Liu / R. Varelas Config Change: None

	Target (dBm)	Power Settings Measured (dBm)	Software Setting
Chain A	12.5	17.5	19.5
Chain B	-	5.0	10.0

Note - measured power in table above is average power, for reference only.

Perform normal 1-10 GHz scan with filter for fundamental and then 2-3 GHz scan 20-30 cm from the product without filter.

Preliminary Measurements (Peak versus average limit)

Frequency	Level	Pol	15.209/15.247		Detector	Azimuth	Height	Comments
MHz	dB μ V/m	v/h	Limit	Margin	PK/QP/Avg	degrees	meters	
1600.000	40.2	V	54.0	-13.8	Peak	221	1.5	
1200.000	43.9	V	54.0	-10.1	Peak	259	1.0	

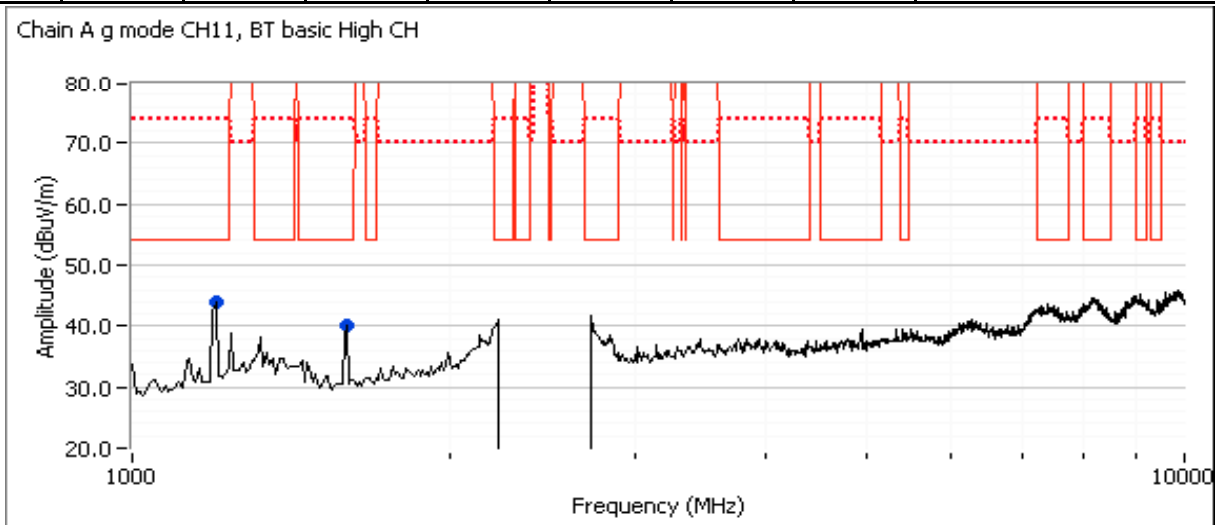

Spurious Emissions excluding allocated band (final measurements at 3m)

Frequency	Level	Pol	15.209 / 15.247		Detector	Azimuth	Height	Comments
MHz	dB μ V/m	v/h	Limit	Margin	PK/QP/Avg	degrees	meters	
1598.670	31.1	V	54.0	-22.9	AVG	62	1.5	RB 1 MHz;VB 10 Hz;Peak
1593.930	47.7	V	74.0	-26.3	PK	62	1.5	RB 1 MHz;VB 3 MHz;Peak
1202.800	32.9	V	54.0	-21.1	AVG	268	1.2	RB 1 MHz;VB 10 Hz;Peak
1198.730	53.3	V	74.0	-20.7	PK	268	1.2	RB 1 MHz;VB 3 MHz;Peak



EMC Test Data

Client: Intel Corporation	Job Number: J94914
Model: 7265D2W	T-Log Number: T95472
Contact: Steve Hackett	Project Manager: Christine Krebill
Standard: FCC Part 15.247, 15.407, RSS-210	Project Coordinator: -
	Class: N/A

Preliminary Measurements (Peak versus average limit) at 20-30cm from EUT

Frequency	Level	Pol	15.209/15.247		Detector	Azimuth	Height	Comments
MHz	dB μ V/m	v/h	Limit	Margin	PK/QP/Avg	degrees	meters	
2490.980	55.6	V	-	-	Peak	180	1.0	Refer to Band Edge test result

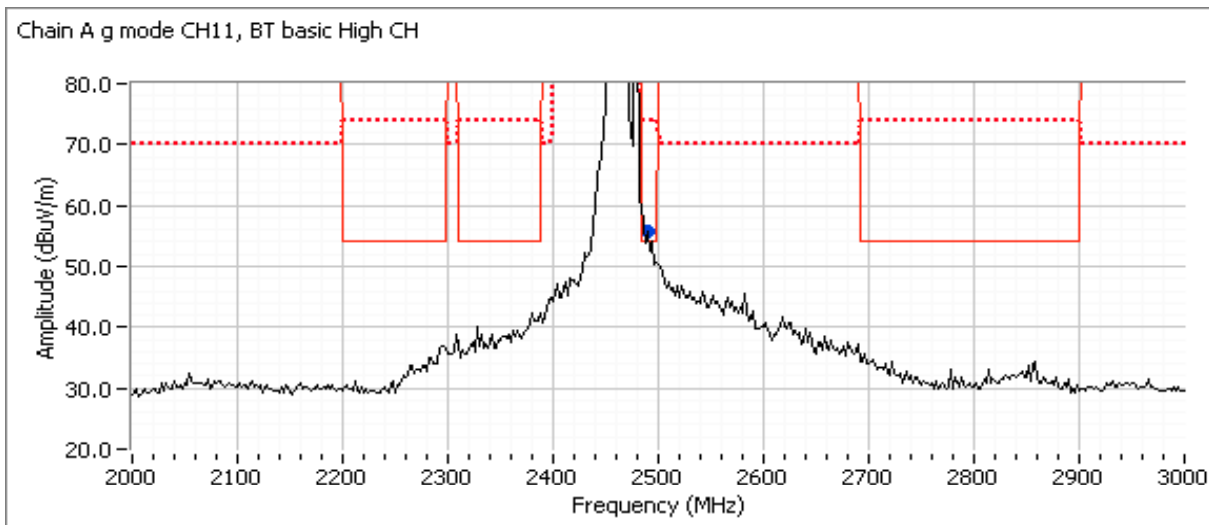

Spurious Emissions near allocated band (final measurements at 3m)

Frequency	Level	Pol	15.209 / 15.247		Detector	Azimuth	Height	Comments
MHz	dB μ V/m	v/h	Limit	Margin	PK/QP/Avg	degrees	meters	

No intermodulation founded

- Note 1: For emissions in restricted bands, the limit of 15.209 was used. For all other emissions, the limit was set 20dB below the level of the fundamental and measured in 100kHz.
- Note 2: Signal is not in a restricted band but the more stringent restricted band limit was used.
- Note 3: Signal is only present when Bluetooth is enabled, average correction for hopping occupancy could be applied



EMC Test Data

Client: Intel Corporation	Job Number: J94914
Model: 7265D2W	T-Log Number: T95472
Contact: Steve Hackett	Project Manager: Christine Krebill
Standard: FCC Part 15.247, 15.407, RSS-210	Project Coordinator: -
	Class: N/A

Run #5: 1-10GHz, 802.11b @ 2437 MHz Chain A, BT Basic Rate @ 2402 MHz Chain B

Date of Test: 6/19/2014 Test Location: FT Chamber 4
 Test Engineer: Jack Liu / R. Varelas Config Change: None

	Target (dBm)	Power Settings Measured (dBm)	Software Setting
Chain A	17.5	17.7	14.0
Chain B	-	4.8	10.0

Note - measured power in table above is average power, for reference only.

Perform normal 1-10 GHz scan with filter for fundamental and then 2-3 GHz scan 20-30 cm from the product without filter.

Preliminary Measurements (Peak versus average limit)

Frequency	Level	Pol	15.209/15.247		Detector	Azimuth	Height	Comments
MHz	dB μ V/m	v/h	Limit	Margin	PK/QP/Avg	degrees	meters	
1195.120	44.6	H	54.0	-9.4	Peak	114	1.3	
1594.440	41.2	V	54.0	-12.8	Peak	227	1.6	
4874.170	42.4	V	54.0	-11.6	Peak	141	1.3	

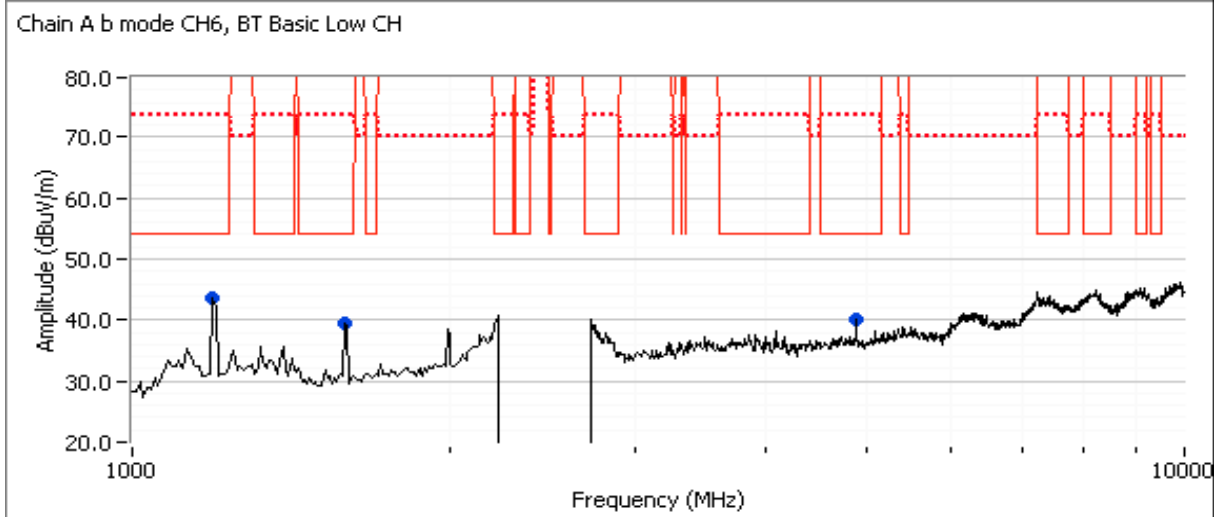

Spurious Emissions excluding allocated band (final measurements at 3m)

Frequency	Level	Pol	15.209 / 15.247		Detector	Azimuth	Height	Comments
MHz	dB μ V/m	v/h	Limit	Margin	PK/QP/Avg	degrees	meters	
4873.970	40.2	V	54.0	-13.8	AVG	154	1.9	RB 1 MHz;VB 10 Hz;Peak
4873.870	46.9	V	74.0	-27.1	PK	154	1.9	RB 1 MHz;VB 3 MHz;Peak
1594.510	30.4	V	54.0	-23.6	AVG	223	1.3	RB 1 MHz;VB 10 Hz;Peak
1596.370	46.1	V	74.0	-27.9	PK	223	1.3	RB 1 MHz;VB 3 MHz;Peak
1196.570	30.7	H	54.0	-23.3	AVG	116	1.6	RB 1 MHz;VB 10 Hz;Peak
1194.630	53.7	H	74.0	-20.3	PK	116	1.6	RB 1 MHz;VB 3 MHz;Peak



EMC Test Data

Client: Intel Corporation	Job Number: J94914
Model: 7265D2W	T-Log Number: T95472
Contact: Steve Hackett	Project Manager: Christine Krebill
Standard: FCC Part 15.247, 15.407, RSS-210	Project Coordinator: -
	Class: N/A

Preliminary Measurements (Peak versus average limit) at 100cm from EUT

Frequency	Level	Pol	15.209/15.247		Detector	Azimuth	Height	Comments
MHz	dB μ V/m	v/h	Limit	Margin	PK/QP/Avg	degrees	meters	
2368.740	49.2	H	54.0	-4.8	Peak	210	1.5	

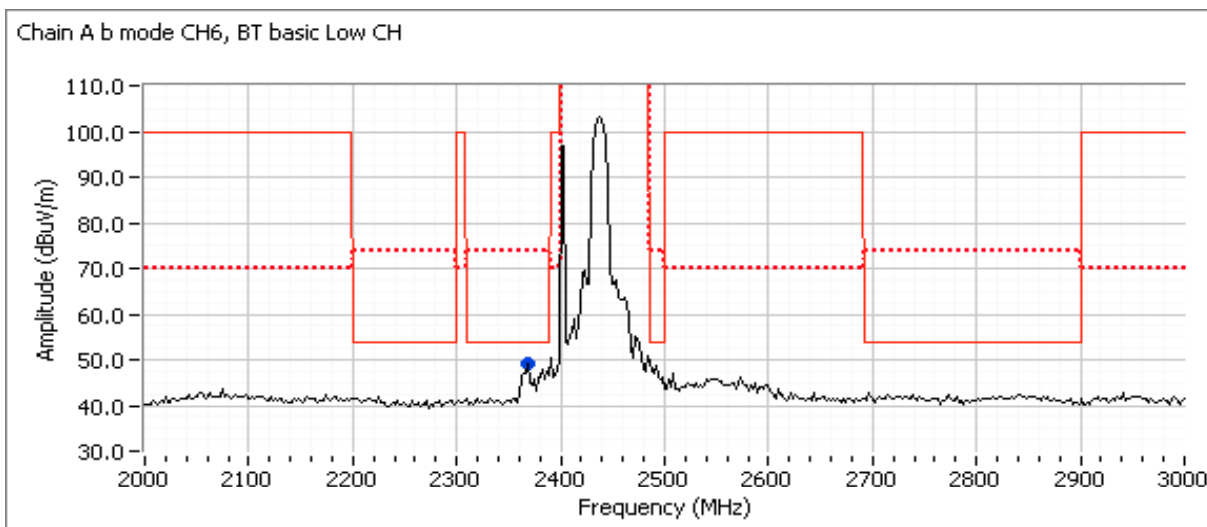

Spurious Emissions near allocated band (final measurements at 3m)

Frequency	Level	Pol	15.209 / 15.247		Detector	Azimuth	Height	Comments
MHz	dB μ V/m	v/h	Limit	Margin	PK/QP/Avg	degrees	meters	
2366.050	46.1	H	54.0	-7.9	AVG	155	1.4	POS; RB 1 MHz; VB: 10 Hz
2366.300	54.2	H	74.0	-19.8	PK	155	1.4	POS; RB 1 MHz; VB: 3 MHz

- Note 1: For emissions in restricted bands, the limit of 15.209 was used. For all other emissions, the limit was set 20dB below the level of the fundamental and measured in 100kHz.
- Note 1: For emissions in restricted bands, the limit of 15.209 was used. For all other emissions, the limit was set 30dB below the level of the fundamental and measured in 100kHz.
- Note 2: Signal is not in a restricted band but the more stringent restricted band limit was used.
- Note 3: Signal is only present when Bluetooth is enabled, average correction for hopping occupancy could be applied



EMC Test Data

Client:	Intel Corporation	Job Number:	J94914
Model:	7265D2W	T-Log Number:	T95472
Contact:	Steve Hackett	Project Manager:	Christine Krebill
Standard:	FCC Part 15.247, 15.407, RSS-210	Project Coordinator:	-
		Class:	N/A

Run #6: 1-10GHz, 802.11b @ 2412 MHz Chain A, BT Basic Rate @ 2440 MHz Chain B
 Date of Test: 6/19/2014 Test Location: FT Chamber 4
 Test Engineer: Jack Liu Config Change: None

	Target (dBm)	Power Settings Measured (dBm)	Software Setting
Chain A	16.5	17.6	14.5
Chain B	-	5.1	10.0

Note - measured power in table above is average power, for reference only.

Perform normal 1-10 GHz scan with filter for fundamental and then 2-3 GHz scan 20-30 cm from the product without filter.

Preliminary Measurements (Peak versus average limit)

Frequency	Level	Pol	15.209/15.247		Detector	Azimuth	Height	Comments
MHz	dB μ V/m	v/h	Limit	Margin	PK/QP/Avg	degrees	meters	
1198.140	44.7	V	54.0	-9.3	Peak	275	1.3	
1590.120	40.7	V	54.0	-13.3	Peak	87	1.9	

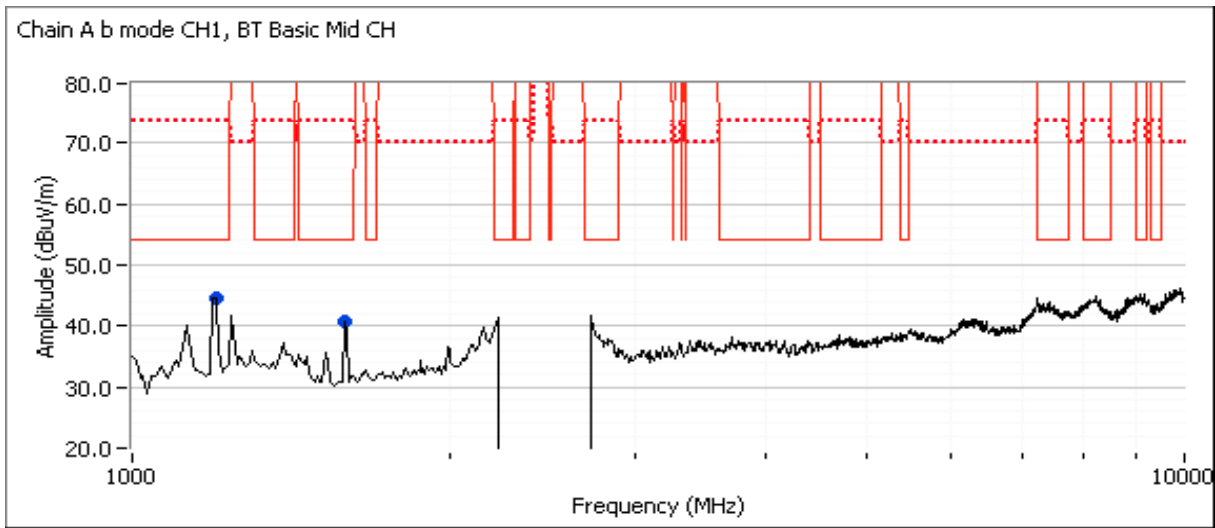

Spurious Emissions excluding allocated band (final measurements at 3m)

Frequency	Level	Pol	15.209 / 15.247		Detector	Azimuth	Height	Comments
MHz	dB μ V/m	v/h	Limit	Margin	PK/QP/Avg	degrees	meters	
1198.160	31.0	V	54.0	-23.0	AVG	277	1.0	RB 1 MHz;VB 10 Hz;Peak
1199.340	50.0	V	74.0	-24.0	PK	277	1.0	RB 1 MHz;VB 3 MHz;Peak
1591.090	28.8	V	54.0	-25.2	AVG	93	1.0	RB 1 MHz;VB 10 Hz;Peak
1590.570	41.2	V	74.0	-32.8	PK	93	1.0	RB 1 MHz;VB 3 MHz;Peak

Client:	Intel Corporation	Job Number:	J94914
Model:	7265D2W	T-Log Number:	T95472
Contact:	Steve Hackett	Project Manager:	Christine Krebill
Standard:	FCC Part 15.247, 15.407, RSS-210	Project Coordinator:	-
		Class:	N/A

Preliminary Measurements (Peak versus average limit) at 100cm from EUT

Frequency	Level	Pol	15.209/15.247		Detector	Azimuth	Height	Comments
MHz	dB μ V/m	v/h	Limit	Margin	PK/QP/Avg	degrees	meters	
2386.770	52.5	H	-	-	Peak	203	1.0	Refer to Band Edge test result
2352.710	44.9	H	54.0	-9.1	Peak	204	1.5	

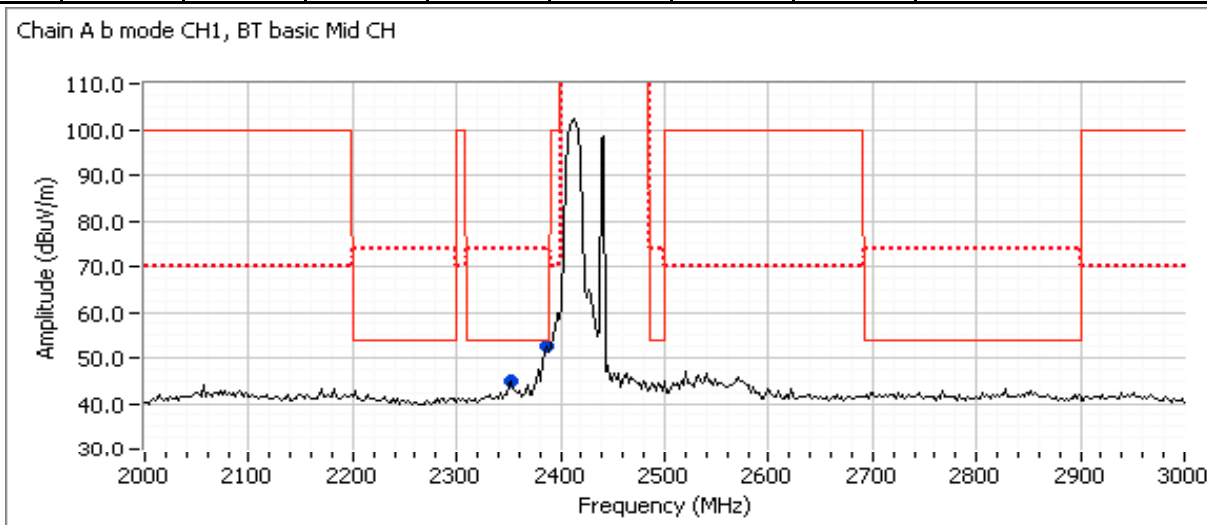

Spurious Emissions near allocated band (final measurements at 3m)

Frequency	Level	Pol	15.209 / 15.247		Detector	Azimuth	Height	Comments
MHz	dB μ V/m	v/h	Limit	Margin	PK/QP/Avg	degrees	meters	
2356.760	41.9	H	54.0	-12.1	AVG	204	1.6	POS; RB 1 MHz; VB: 10 Hz
2356.600	51.1	H	74.0	-22.9	PK	204	1.6	POS; RB 1 MHz; VB: 3 MHz

Note 1: For emissions in restricted bands, the limit of 15.209 was used. For all other emissions, the limit was set 20dB below the level of the fundamental and measured in 100kHz.

Note 1: For emissions in restricted bands, the limit of 15.209 was used. For all other emissions, the limit was set 30dB below the level of the fundamental and measured in 100kHz.

Note 2: Signal is not in a restricted band but the more stringent restricted band limit was used.

Note 3: Signal is only present when Bluetooth is enabled, average correction for hopping occupancy could be applied



EMC Test Data

Client: Intel Corporation	Job Number: J94914
Model: 7265D2W	T-Log Number: T95472
Contact: Steve Hackett	Project Manager: Christine Krebill
Standard: FCC Part 15.247, 15.407, RSS-210	Project Coordinator: -
	Class: N/A

Run #7: 1-10GHz, 802.11b @ 2462 MHz Chain A, BT Basic Rate @ 2440 MHz Chain B
 Date of Test: 6/19/2014 Test Location: FT Chamber 4
 Test Engineer: Jack Liu Config Change: None

	Target (dBm)	Power Settings Measured (dBm)	Software Setting
Chain A	16.5	17.6	14.5
Chain B	-	5.1	10.0

Note - measured power in table above is average power, for reference only.

Perform normal 1-10 GHz scan with filter for fundamental and then 2-3 GHz scan 20-30 cm from the product without filter.

Preliminary Measurements (Peak versus average limit)

Frequency	Level	Pol	15.209/15.247		Detector	Azimuth	Height	Comments
MHz	dB μ V/m	v/h	Limit	Margin	PK/QP/Avg	degrees	meters	
1195.250	45.3	H	54.0	-8.7	Peak	111	1.3	
1590.780	39.5	H	54.0	-14.5	Peak	103	1.0	
4924.000	43.7	H	54.0	-10.3	Peak	189	1.6	

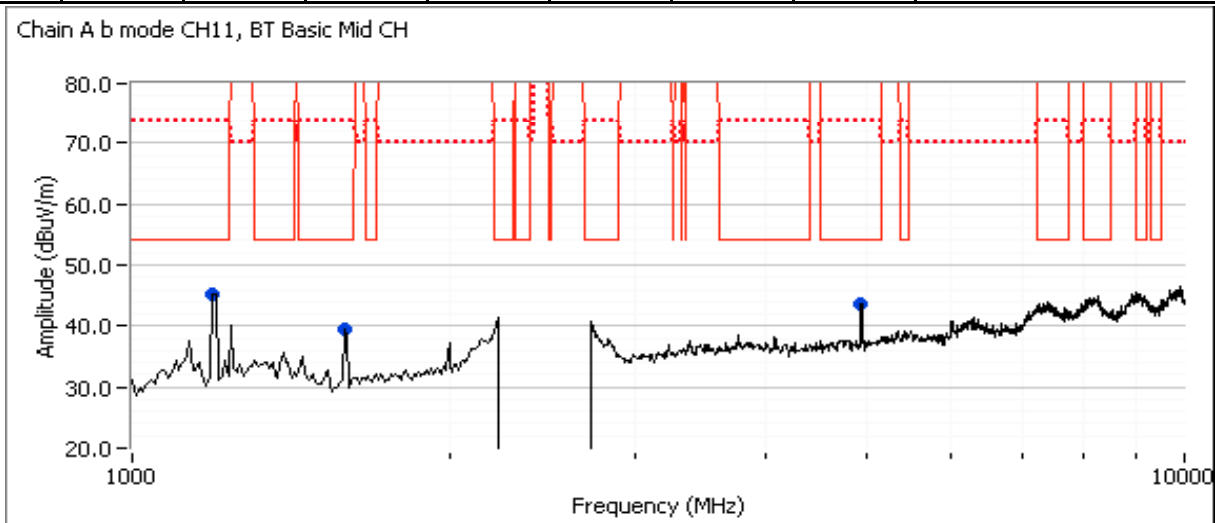

Spurious Emissions excluding allocated mid band (final measurements at 3m)

Frequency	Level	Pol	15.209 / 15.247		Detector	Azimuth	Height	Comments
MHz	dB μ V/m	v/h	Limit	Margin	PK/QP/Avg	degrees	meters	
4923.960	41.3	H	54.0	-12.7	AVG	147	1.0	RB 1 MHz;VB 10 Hz;Peak
4924.020	46.9	H	74.0	-27.1	PK	147	1.0	RB 1 MHz;VB 3 MHz;Peak
1196.560	29.9	H	54.0	-24.1	AVG	116	1.6	RB 1 MHz;VB 10 Hz;Peak
1196.320	53.6	H	74.0	-20.4	PK	116	1.6	RB 1 MHz;VB 3 MHz;Peak
1592.010	29.2	H	54.0	-24.8	AVG	101	1.0	RB 1 MHz;VB 10 Hz;Peak
1592.100	40.7	H	74.0	-33.3	PK	101	1.0	RB 1 MHz;VB 3 MHz;Peak



EMC Test Data

Client: Intel Corporation	Job Number: J94914
Model: 7265D2W	T-Log Number: T95472
Contact: Steve Hackett	Project Manager: Christine Krebill
Standard: FCC Part 15.247, 15.407, RSS-210	Project Coordinator: -
	Class: N/A

Preliminary Measurements (Peak versus average limit) at 20-30cm from EUT

Frequency	Level	Pol	15.209/15.247		Detector	Azimuth	Height	Comments
MHz	dB μ V/m	v/h	Limit	Margin	PK/QP/Avg	degrees	meters	
2488.980	54.7	H	-	-	Peak	182	1.0	Refer to Band Edge test result

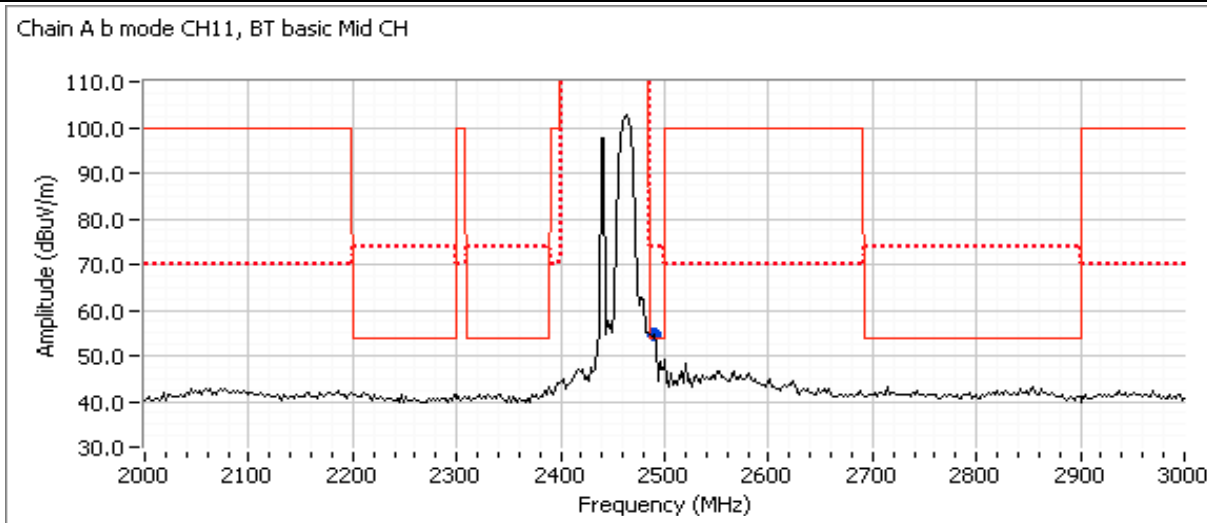

Spurious Emissions near allocated band (final measurements at 3m)

Frequency	Level	Pol	15.209 / 15.247		Detector	Azimuth	Height	Comments
MHz	dB μ V/m	v/h	Limit	Margin	PK/QP/Avg	degrees	meters	

No intermodulation founded

Note 1: For emissions in restricted bands, the limit of 15.209 was used. For all other emissions, the limit was set 20dB below the level of the fundamental and measured in 100kHz.

Note 1: For emissions in restricted bands, the limit of 15.209 was used. For all other emissions, the limit was set 30dB below the level of the fundamental and measured in 100kHz.

Note 2: Signal is not in a restricted band but the more stringent restricted band limit was used.

Note 3: Signal is only present when Bluetooth is enabled, average correction for hopping occupancy could be applied



EMC Test Data

Client: Intel Corporation	Job Number: J94914
Model: 7265D2W	T-Log Number: T95472
Contact: Steve Hackett	Project Manager: Christine Krebill
Standard: FCC Part 15.247, 15.407, RSS-210	Project Coordinator: -
	Class: N/A

Run #8: 1-10GHz, 802.11b @ 2437 MHz Chain A, BT Basic Rate @ 2480 MHz Chain B
 Date of Test: 6/19/2014 Test Location: FT Chamber 4
 Test Engineer: Jack Liu Config Change: None

	Target (dBm)	Power Settings Measured (dBm)	Software Setting
Chain A	16.5	17.7	14.0
Chain B	-	5.0	10.0

Note - measured power in table above is average power, for reference only.

Perform normal 1-10 GHz scan with filter for fundamental and then 2-3 GHz scan 20-30 cm from the product without filter.

Preliminary Measurements (Peak versus average limit)

Frequency	Level	Pol	15.209/15.247		Detector	Azimuth	Height	Comments
MHz	dB μ V/m	v/h	Limit	Margin	PK/QP/Avg	degrees	meters	
1192.970	44.7	V	54.0	-9.3	Peak	224	1.0	
1594.110	41.0	H	54.0	-13.0	Peak	120	1.0	
4874.080	42.6	V	54.0	-11.4	Peak	154	1.9	

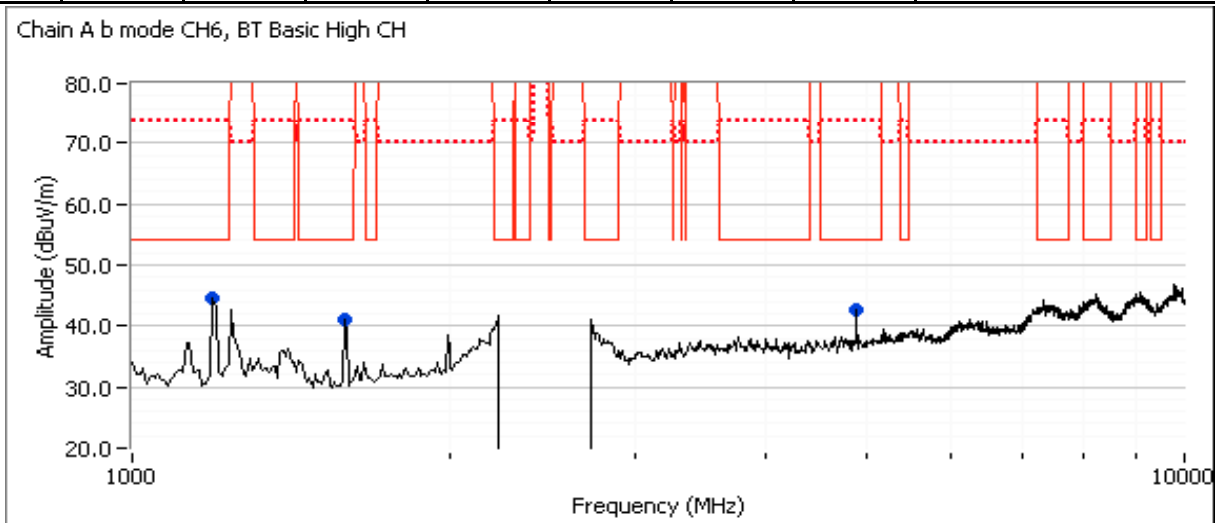

Spurious Emissions excluding allocated band (final measurements at 3m)

Frequency	Level	Pol	15.209 / 15.247		Detector	Azimuth	Height	Comments
MHz	dB μ V/m	v/h	Limit	Margin	PK/QP/Avg	degrees	meters	
4874.020	41.1	V	54.0	-12.9	AVG	154	1.9	RB 1 MHz;VB 10 Hz;Peak
4874.190	47.0	V	74.0	-27.0	PK	154	1.9	RB 1 MHz;VB 3 MHz;Peak
1595.050	31.7	H	54.0	-22.3	AVG	121	1.0	RB 1 MHz;VB 10 Hz;Peak
1593.860	49.9	H	74.0	-24.1	PK	121	1.0	RB 1 MHz;VB 3 MHz;Peak
1194.440	32.5	V	54.0	-21.5	AVG	225	1.0	RB 1 MHz;VB 10 Hz;Peak
1194.200	54.0	V	74.0	-20.0	PK	225	1.0	RB 1 MHz;VB 3 MHz;Peak



EMC Test Data

Client: Intel Corporation	Job Number: J94914
Model: 7265D2W	T-Log Number: T95472
Contact: Steve Hackett	Project Manager: Christine Krebill
Standard: FCC Part 15.247, 15.407, RSS-210	Project Coordinator: -
	Class: N/A

Preliminary Measurements (Peak versus average limit) at 20-30cm from EUT

Frequency	Level	Pol	15.209/15.247		Detector	Azimuth	Height	Comments
MHz	dB μ V/m	v/h	Limit	Margin	PK/QP/Avg	degrees	meters	
No emission founded								

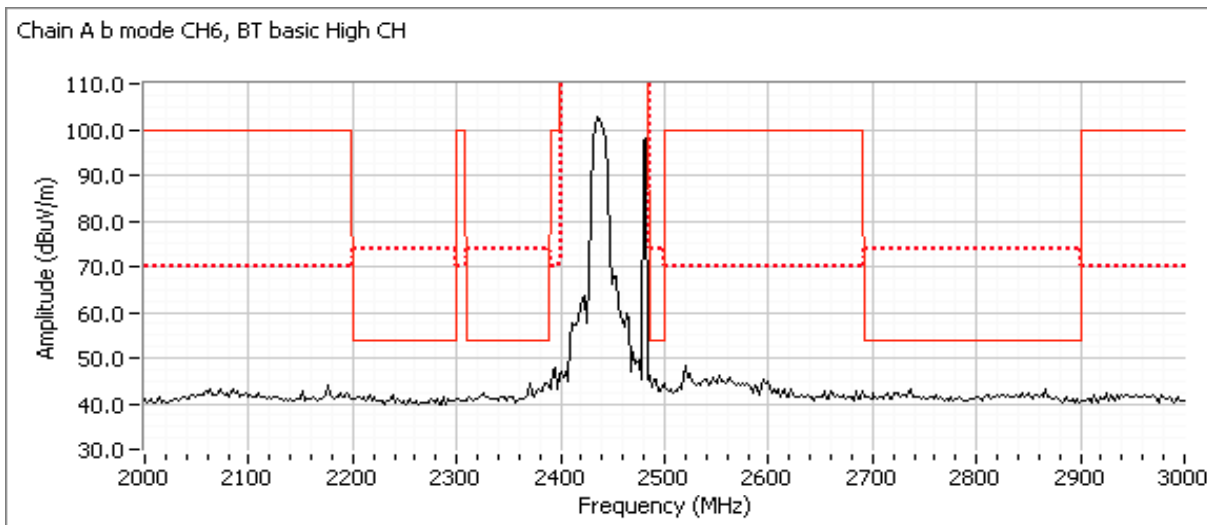

Spurious Emissions near allocated band (final measurements at 3m)

Frequency	Level	Pol	15.209 / 15.247		Detector	Azimuth	Height	Comments
MHz	dB μ V/m	v/h	Limit	Margin	PK/QP/Avg	degrees	meters	
No intermodulation founded								

- Note 1: For emissions in restricted bands, the limit of 15.209 was used. For all other emissions, the limit was set 20dB below the level of the fundamental and measured in 100kHz.
- Note 1: For emissions in restricted bands, the limit of 15.209 was used. For all other emissions, the limit was set 30dB below the level of the fundamental and measured in 100kHz.
- Note 2: Signal is not in a restricted band but the more stringent restricted band limit was used.
- Note 3: Signal is only present when Bluetooth is enabled, average correction for hopping occupancy could be applied



EMC Test Data

Client:	Intel Corporation	Job Number:	J94914
Model:	7265D2W	T-Log Number:	T95472
Contact:	Steve Hackett	Project Manager:	Christine Krebill
Standard:	FCC Part 15.247, 15.407, RSS-210	Project Coordinator:	-
		Class:	N/A

Run #9: 1-10GHz, 802.11b @ 2412 MHz Chain A, BT EDR Rate @ 2440 MHz Chain B
 Date of Test: 6/19/2014 Test Location: FT Chamber 4
 Test Engineer: Jack Liu Config Change: None

	Target (dBm)	Power Settings Measured (dBm)	Software Setting
Chain A	16.5	17.7	14.0
Chain B	-	1.2	6.0

Note - measured power in table above is average power, for reference only.

Perform normal 1-10 GHz scan with filter for fundamental and then 2-3 GHz scan 100 cm from the product without filter.

Preliminary Measurements (Peak versus average limit)

Frequency	Level	Pol	15.209/15.247		Detector	Azimuth	Height	Comments
MHz	dB μ V/m	v/h	Limit	Margin	PK/QP/Avg	degrees	meters	
1245.000	46.2	H	70.0	-23.8	Peak	119	1.3	
1593.170	38.0	H	54.0	-16.0	Peak	124	1.0	
4924.030	45.2	V	54.0	-8.8	Peak	115	1.3	

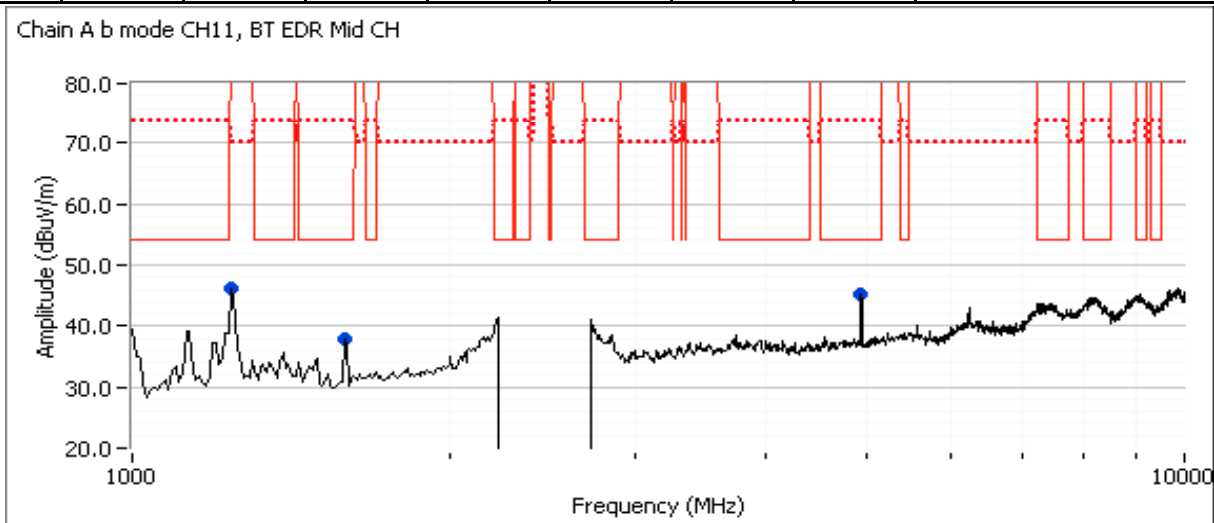

Spurious Emissions excluding allocated band (final measurements at 3m)

Frequency	Level	Pol	15.209 / 15.247		Detector	Azimuth	Height	Comments
MHz	dB μ V/m	v/h	Limit	Margin	PK/QP/Avg	degrees	meters	
4923.970	41.4	V	54.0	-12.6	AVG	146	1.9	RB 1 MHz;VB 10 Hz;Peak
4923.840	47.1	V	74.0	-26.9	PK	146	1.9	RB 1 MHz;VB 3 MHz;Peak
1593.770	32.0	H	54.0	-22.0	AVG	122	1.0	RB 1 MHz;VB 10 Hz;Peak
1592.460	47.7	H	74.0	-26.3	PK	122	1.0	RB 1 MHz;VB 3 MHz;Peak
1244.940	52.4	H	68.3	-15.9	PK	117	0.9	RB 1 MHz;VB 3 MHz;Peak



EMC Test Data

Client: Intel Corporation	Job Number: J94914
Model: 7265D2W	T-Log Number: T95472
Contact: Steve Hackett	Project Manager: Christine Krebill
Standard: FCC Part 15.247, 15.407, RSS-210	Project Coordinator: -
	Class: N/A

Preliminary Measurements (Peak versus average limit) at 20-30cm from EUT

Frequency	Level	Pol	15.209/15.247		Detector	Azimuth	Height	Comments
MHz	dB μ V/m	v/h	Limit	Margin	PK/QP/Avg	degrees	meters	

No intermodulation founded

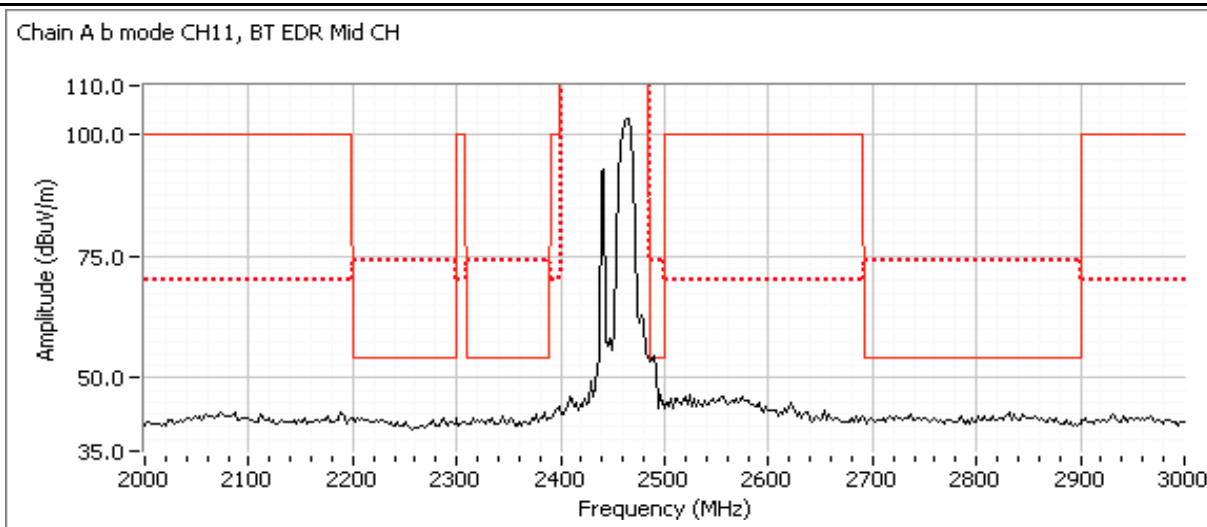

Spurious Emissions near allocated band (final measurements at 3m)

Frequency	Level	Pol	15.209 / 15.247		Detector	Azimuth	Height	Comments
MHz	dB μ V/m	v/h	Limit	Margin	PK/QP/Avg	degrees	meters	

No intermodulation founded

Note 1: For emissions in restricted bands, the limit of 15.209 was used. For all other emissions, the limit was set 20dB below the level of the fundamental and measured in 100kHz.

Note 1: For emissions in restricted bands, the limit of 15.209 was used. For all other emissions, the limit was set 30dB below the level of the fundamental and measured in 100kHz.

Note 2: Signal is not in a restricted band but the more stringent restricted band limit was used.

Note 3: Signal is only present when Bluetooth is enabled, average correction for hopping occupancy could be applied



EMC Test Data

Client: Intel Corporation	Job Number: J94914
Model: 7265D2W	T-Log Number: T95472
Contact: Steve Hackett	Project Manager: Christine Krebill
Standard: FCC Part 15.247, 15.407, RSS-210	Project Coordinator: -
	Class: N/A

Run #10: 1-10GHz, 802.11b @ 2412 MHz Chain A, BTLE @ 2440 MHz Chain B
 Date of Test: 6/19/2014 Test Location: FT Chamber 4
 Test Engineer: Jack Liu Config Change: None

	Target (dBm)	Power Settings Measured (dBm)	Software Setting
Chain A	16.5	17.7	14.0
Chain B	-	3.2	Default

Note - measured power in table above is average power, for reference only.

Perform normal 1-10 GHz scan with filter for fundamental and then 2-3 GHz scan 100 cm from the product without filter.

Preliminary Measurements (Peak versus average limit)

Frequency	Level	Pol	15.209/15.247		Detector	Azimuth	Height	Comments
MHz	dB μ V/m	v/h	Limit	Margin	PK/QP/Avg	degrees	meters	
1242.560	45.5	H	70.0	-24.5	Peak	308	1.6	
1598.530	38.2	V	54.0	-15.8	Peak	60	1.6	
4924.030	46.4	V	54.0	-7.6	Peak	125	2.2	

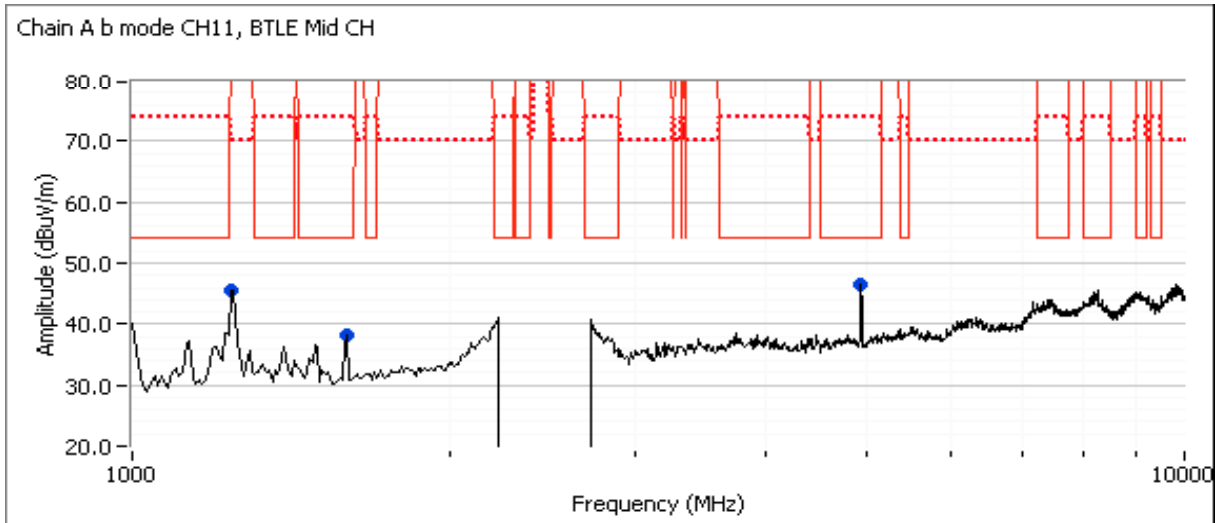

Spurious Emissions excluding allocated band (final measurements at 3m)

Frequency	Level	Pol	15.209 / 15.247		Detector	Azimuth	Height	Comments
MHz	dB μ V/m	v/h	Limit	Margin	PK/QP/Avg	degrees	meters	
4923.990	43.5	V	54.0	-10.5	AVG	157	1.9	RB 1 MHz;VB 10 Hz;Peak
4923.950	48.4	V	74.0	-25.6	PK	157	1.9	RB 1 MHz;VB 3 MHz;Peak
1243.960	48.4	H	68.3	-19.9	PK	306	1.6	RB 1 MHz;VB 3 MHz;Peak
1598.280	31.6	V	54.0	-22.4	AVG	58	1.5	RB 1 MHz;VB 10 Hz;Peak
1598.740	44.6	V	74.0	-29.4	PK	58	1.5	RB 1 MHz;VB 3 MHz;Peak



EMC Test Data

Client:	Intel Corporation	Job Number:	J94914
Model:	7265D2W	T-Log Number:	T95472
Contact:	Steve Hackett	Project Manager:	Christine Krebill
Standard:	FCC Part 15.247, 15.407, RSS-210	Project Coordinator:	-
		Class:	N/A

Preliminary Measurements (Peak versus average limit) at 20-30cm from EUT

Frequency	Level	Pol	15.209/15.247		Detector	Azimuth	Height	Comments
MHz	dB μ V/m	v/h	Limit	Margin	PK/QP/Avg	degrees	meters	

No intermodulation founded

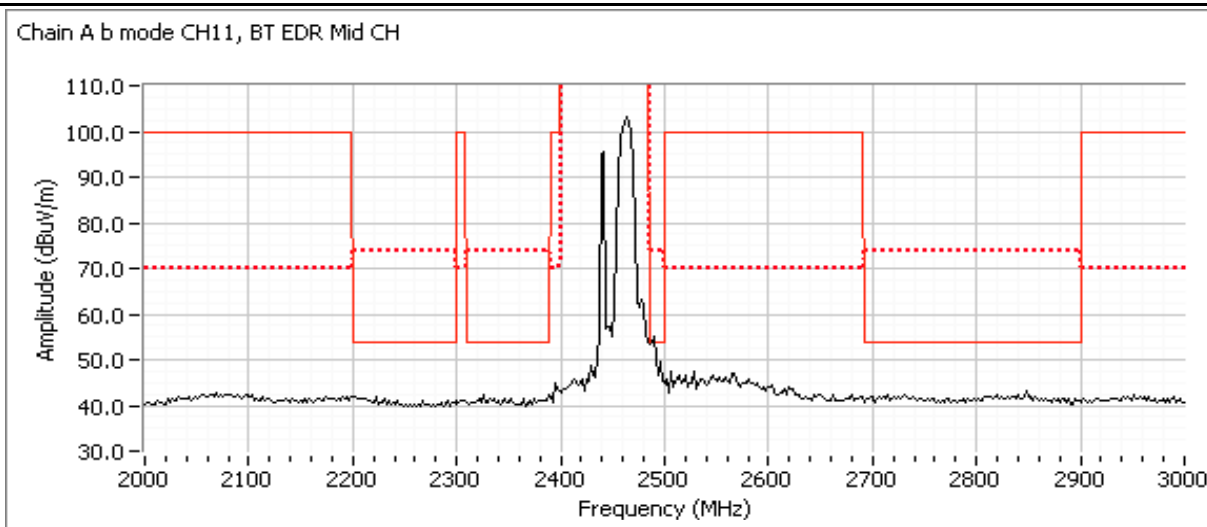

Spurious Emissions near allocated band (final measurments at 3m)

Frequency	Level	Pol	15.209 / 15.247		Detector	Azimuth	Height	Comments
MHz	dB μ V/m	v/h	Limit	Margin	PK/QP/Avg	degrees	meters	

No intermodulation founded

- Note 1: For emissions in restricted bands, the limit of 15.209 was used. For all other emissions, the limit was set 20dB below the level of the fundamental and measured in 100kHz.
- Note 1: For emissions in restricted bands, the limit of 15.209 was used. For all other emissions, the limit was set 30dB below the level of the fundamental and measured in 100kHz.
- Note 2: Signal is not in a restricted band but the more stringent restricted band limit was used.
- Note 3: Signal is only present when Bluetooth is enabled, average correction for hopping occupancy could be applied



EMC Test Data

Client:	Intel Corporation	Job Number:	J94914
Model:	7265D2W	T-Log Number:	T95472
Contact:	Steve Hackett	Project Manager:	Christine Krebill
Standard:	FCC Part 15.247, 15.407, RSS-210	Project Coordinator:	-
		Class:	N/A

Run #11: 1-15GHz, 802.11n20 @ 5200 MHz Chain A+B, BT Basic Rate @ 2440 MHz Chain B
 Date of Test: 6/18/2014 Test Location: FT Chamber #4
 Test Engineer: Jack Liu / R. Varelas Config Change: None

	Target (dBm)	Power Settings Measured (dBm)	Software Setting
WiFi A	16.0	16.6	31.0
WiFi B	16.0	16.5	32.0
Bluetooth	-	5.1	10.0

Note - measured power in table above is average power, for reference only.

Perform normal 7-15 GHz scan with filter for fundamental and then 1-4 and 4-7 GHz scans 20-30 cm from the product without filter.

Preliminary Measurements (Peak versus average limit)

Frequency	Level	Pol	15.209/15.247		Detector	Azimuth	Height	Comments
MHz	dB μ V/m	v/h	Limit	Margin	PK/QP/Avg	degrees	meters	
10401.330	39.0	H	68.3	-29.3	Peak	126	1.0	Harmonic of the EUT

Spurious Emissions (final measurements at 3m)

Frequency	Level	Pol	15.209 / 15.247		Detector	Azimuth	Height	Comments
MHz	dB μ V/m	v/h	Limit	Margin	PK/QP/Avg	degrees	meters	
refer to the spurious RE results								

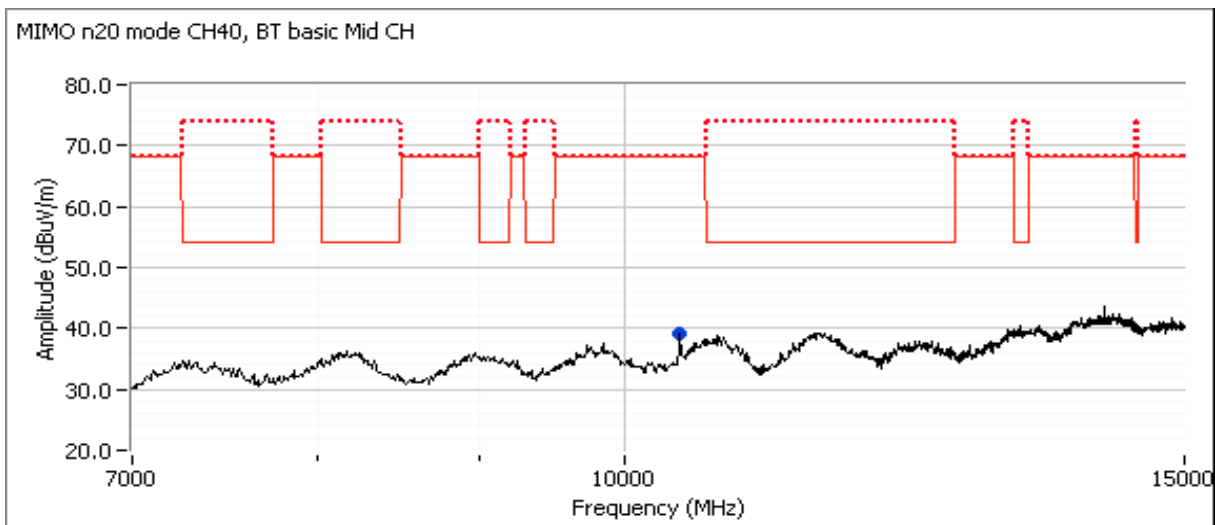



EMC Test Data

Client: Intel Corporation	Job Number: J94914
Model: 7265D2W	T-Log Number: T95472
Contact: Steve Hackett	Project Manager: Christine Krebill
Standard: FCC Part 15.247, 15.407, RSS-210	Project Coordinator: -
	Class: N/A

Preliminary Measurements (Peak versus average limit) at 20-30cm from EUT

Frequency	Level	Pol	15.209/15.247		Detector	Azimuth	Height	Comments
MHz	dB μ V/m	v/h	Limit	Margin	Pk/QP/Avg	degrees	meters	
5370.000	45.6	V	54.0	-8.4	Peak	180	1.0	
4980.000	40.9	V	54.0	-13.1	Peak	180	1.0	
2460.000	59.6	V	120.0	-60.4	Peak	180	1.0	emission is in band

Spurious Emissions (final measurments at 3m)

Frequency	Level	Pol	15.209 / 15.247		Detector	Azimuth	Height	Comments
MHz	dB μ V/m	v/h	Limit	Margin	Pk/QP/Avg	degrees	meters	
no emisissions found above the noise floor								

- Note 1: For emissions in restricted bands, the limit of 15.209 was used. For all other emissions, the limit was set 20dB below the level of the fundamental and measured in 100kHz.
- Note 2: Signal is not in a restricted band but the more stringent restricted band limit was used.
- Note 3: Signal is only present when Bluetooth is enabled, average correction for hopping occupancy could be applied

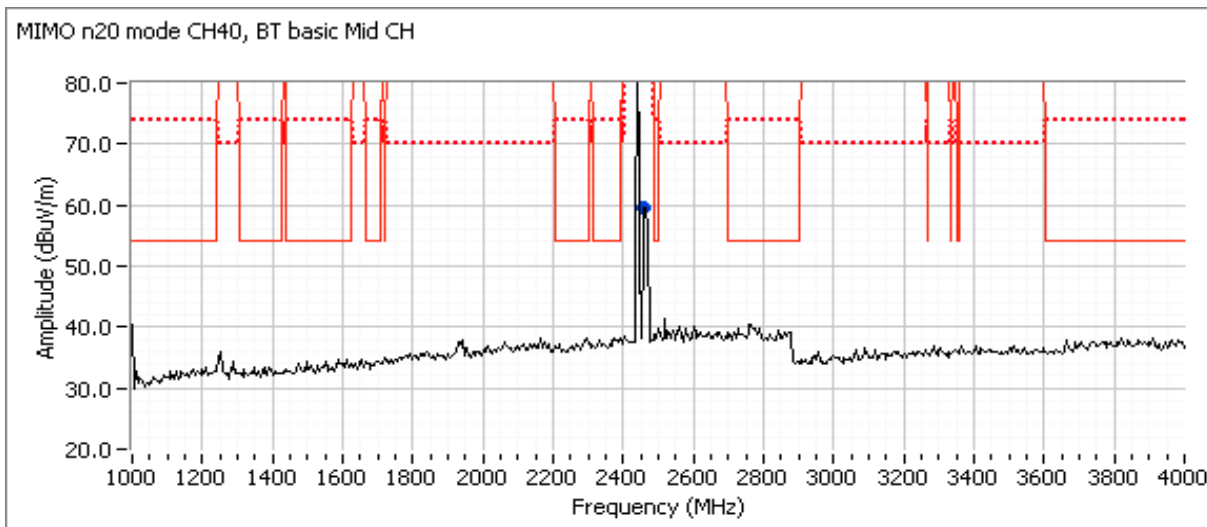



EMC Test Data

Client: Intel Corporation	Job Number: J94914
Model: 7265D2W	T-Log Number: T95472
Contact: Steve Hackett	Project Manager: Christine Krebill
Standard: FCC Part 15.247, 15.407, RSS-210	Project Coordinator: -
	Class: N/A

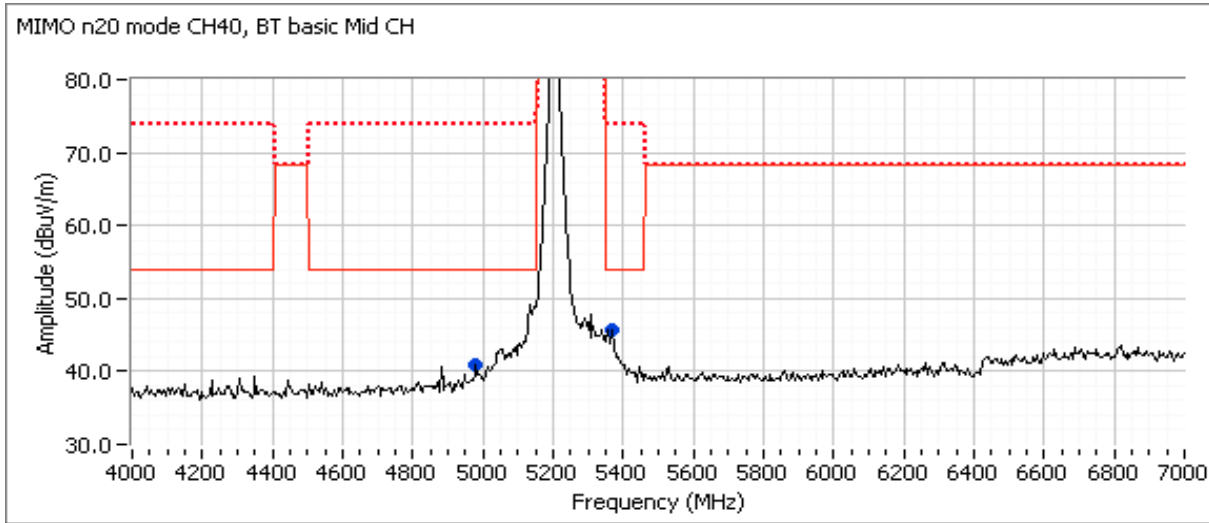

Run #12: 1-15GHz, 802.11n20 @ 5300 MHz Chain A+B, BT Basic Rate @ 2440 MHz Chain B
 Date of Test: 6/18/2014 Test Location: FT Chamber #4
 Test Engineer: R. Varelas Config Change: None

	Target (dBm)	Power Settings Measured (dBm)	Software Setting
WiFi A	16.0	16.6	32.0
WiFi B	16.0	16.5	33.0
Bluetooth	-	5.1	10.0

Note - measured power in table above is average power, for reference only.

Perform normal 7-15 GHz scan with filter for fundamental and then 1-4 and 4-7 GHz scans 20-30 cm from the product without filter.

Preliminary Measurements (Peak versus average limit)

Frequency	Level	Pol	15.209/15.247		Detector	Azimuth	Height	Comments
MHz	dB μ V/m	v/h	Limit	Margin	PK/QP/Avg	degrees	meters	
10599.970	42.3	H	68.3	-26.0	Peak	212	1.0	Harmonic of the EUT

Spurious Emissions (final measurements at 3m)

Frequency	Level	Pol	15.209 / 15.247		Detector	Azimuth	Height	Comments
MHz	dB μ V/m	v/h	Limit	Margin	PK/QP/Avg	degrees	meters	
refer to the spurious RE results								

Client:	Intel Corporation	Job Number:	J94914
Model:	7265D2W	T-Log Number:	T95472
Contact:	Steve Hackett	Project Manager:	Christine Krebill
Standard:	FCC Part 15.247, 15.407, RSS-210	Project Coordinator:	-
		Class:	N/A

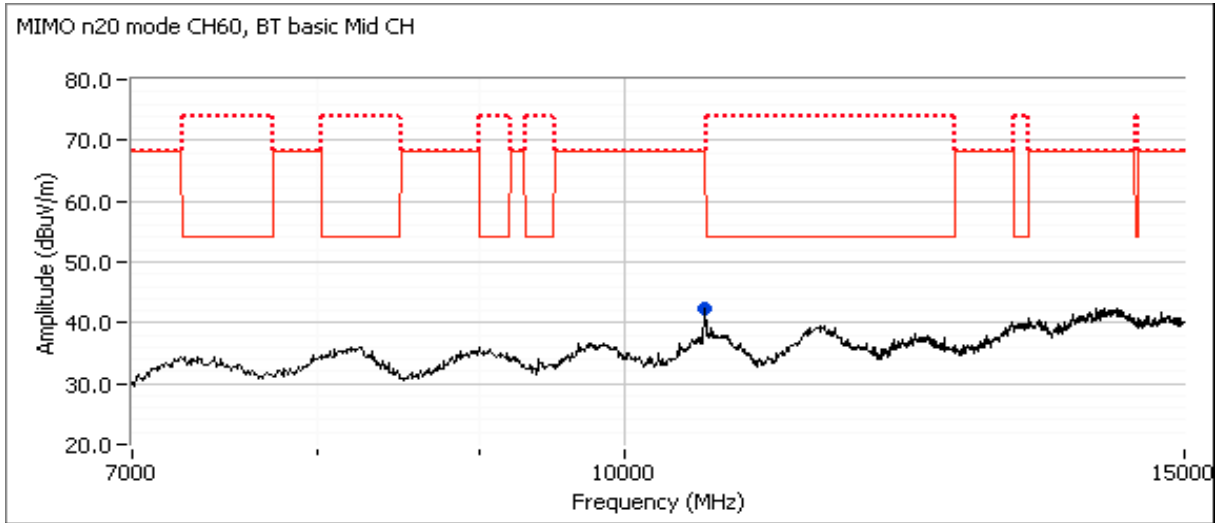

Preliminary Measurements (Peak versus average limit) at 20-30cm from EUT

Frequency	Level	Pol	15.209/15.247		Detector	Azimuth	Height	Comments
MHz	dBµV/m	v/h	Limit	Margin	Pk/QP/Avg	degrees	meters	
2460.000	63.3	V	120.0	-56.7	Peak	180	1.0	In band intermittent signal
5140.000	45.8	V	54.0	-8.2	Peak	180	1.0	
4880.000	42.0	V	54.0	-12.0	Peak	180	1.0	

Spurious Emissions (final measurements at 3m)

Frequency	Level	Pol	15.209 / 15.247		Detector	Azimuth	Height	Comments
MHz	dBµV/m	v/h	Limit	Margin	Pk/QP/Avg	degrees	meters	
no emissions found above the noise floor								

- Note 1: For emissions in restricted bands, the limit of 15.209 was used. For all other emissions, the limit was set 20dB below the level of the fundamental and measured in 100kHz.
- Note 2: Signal is not in a restricted band but the more stringent restricted band limit was used.
- Note 3: Signal is only present when Bluetooth is enabled, average correction for hopping occupancy could be applied

Client: Intel Corporation	Job Number: J94914
Model: 7265D2W	T-Log Number: T95472
Contact: Steve Hackett	Project Manager: Christine Krebill
Standard: FCC Part 15.247, 15.407, RSS-210	Project Coordinator: -
	Class: N/A

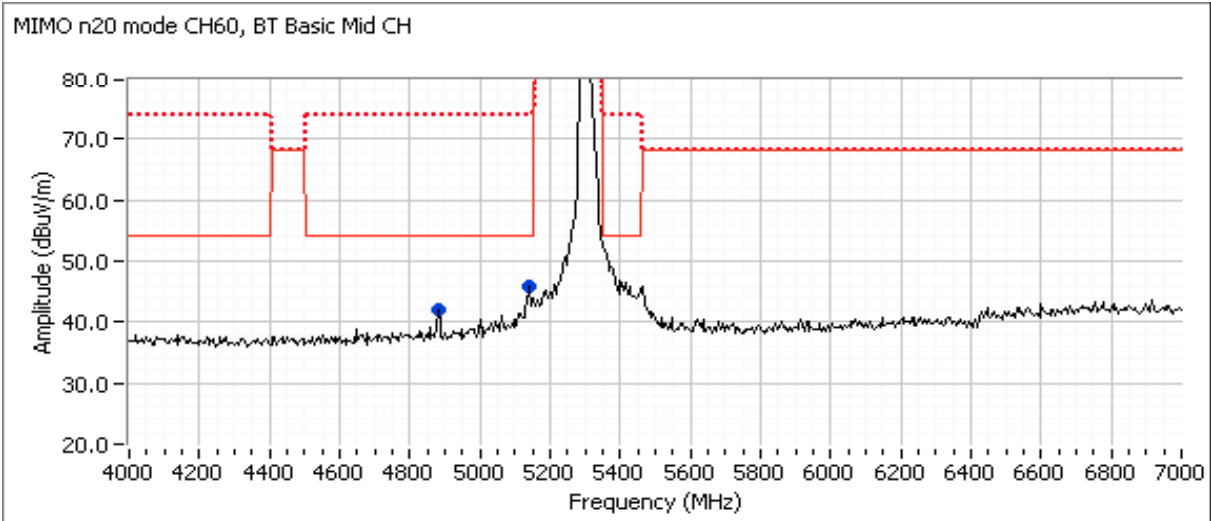
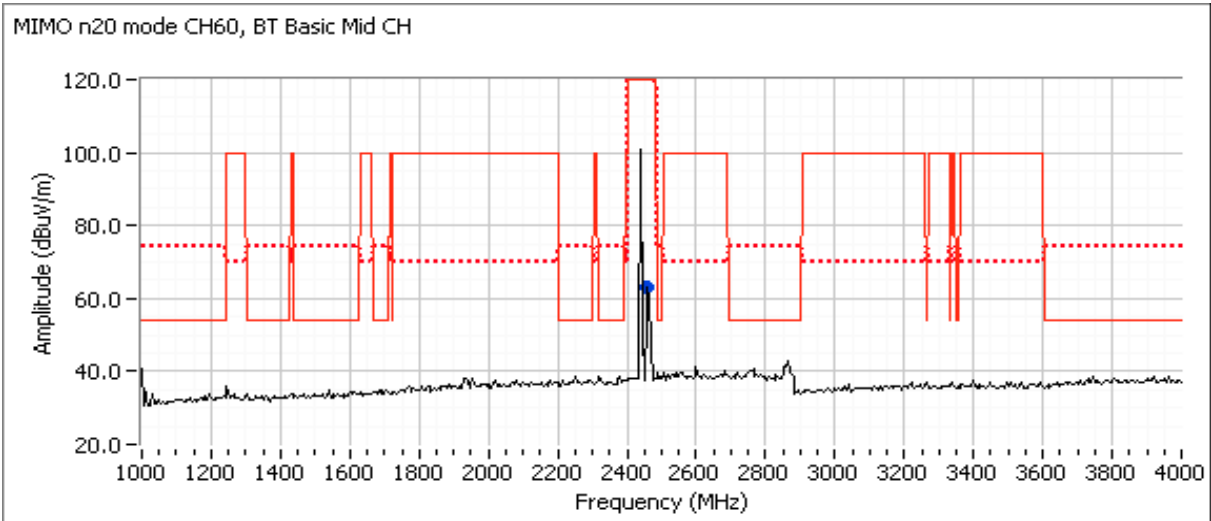



EMC Test Data

Client:	Intel Corporation	Job Number:	J94914
Model:	7265D2W	T-Log Number:	T95472
Contact:	Steve Hackett	Project Manager:	Christine Krebill
Standard:	FCC Part 15.247, 15.407, RSS-210	Project Coordinator:	-
		Class:	N/A

Run #13: 1-15GHz, 802.11n20 @ 5580 MHz Chain A+B, BT Basic Rate @ 2440 MHz Chain B
 Date of Test: 6/18/2014 Test Location: FT Chamber #4
 Test Engineer: R. Varelas Config Change: None

	Target (dBm)	Power Settings Measured (dBm)	Software Setting
WiFi A	16.0	16.6	28.5
WiFi B	16.0	16.5	29.5
Bluetooth	-	5.1	10.0

Note - measured power in table above is average power, for reference only.

Perform normal 7-15 GHz scan with filter for fundamental and then 1-4 and 4-7 GHz scans 20-30 cm from the product without filter.

Preliminary Measurements (Peak versus average limit)

Frequency	Level	Pol	15.209/15.247		Detector	Azimuth	Height	Comments
MHz	dB μ V/m	v/h	Limit	Margin	Pk/QP/Avg	degrees	meters	
11167.600	40.4	V	54.0	-13.6	Peak	165	1.0	Harmonic of the EUT

Spurious Emissions (final measurements at 3m)

Frequency	Level	Pol	15.209 / 15.247		Detector	Azimuth	Height	Comments
MHz	dB μ V/m	v/h	Limit	Margin	Pk/QP/Avg	degrees	meters	
refer to the spurious RE results								

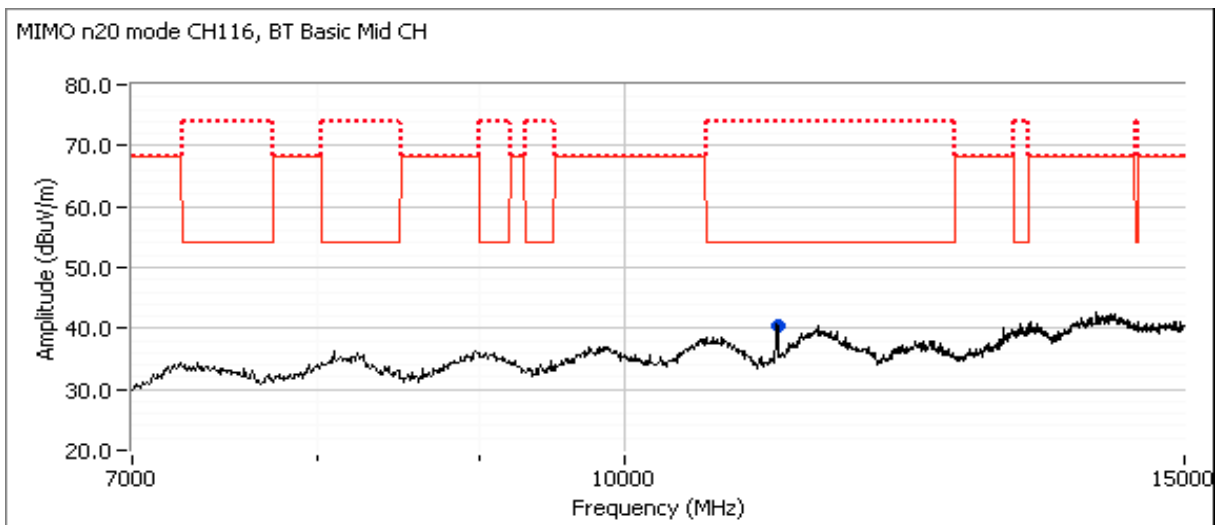



EMC Test Data

Client:	Intel Corporation	Job Number:	J94914
Model:	7265D2W	T-Log Number:	T95472
Contact:	Steve Hackett	Project Manager:	Christine Krebill
Standard:	FCC Part 15.247, 15.407, RSS-210	Project Coordinator:	-
		Class:	N/A

Preliminary Measurements (Peak versus average limit) at 20-30cm from EUT

Frequency	Level	Pol	15.209/15.247		Detector	Azimuth	Height	Comments
MHz	dB μ V/m	v/h	Limit	Margin	Pk/QP/Avg	degrees	meters	
4880.000	43.5	V	54.0	-10.5	Peak	180	1.0	
5425.000	46.2	V	54.0	-7.8	Peak	180	1.0	
2460.000	59.8	V	120.0	-60.2	Peak	180	1.0	In band intermittent signal

Spurious Emissions (final measurments at 3m)

Frequency	Level	Pol	15.209 / 15.247		Detector	Azimuth	Height	Comments
MHz	dB μ V/m	v/h	Limit	Margin	Pk/QP/Avg	degrees	meters	
no emisissions found above the noise floor								

- Note 1: For emissions in restricted bands, the limit of 15.209 was used. For all other emissions, the limit was set 20dB below the level of the fundamental and measured in 100kHz.
- Note 2: Signal is not in a restricted band but the more stringent restricted band limit was used.
- Note 3: Signal is only present when Bluetooth is enabled, average correction for hopping occupancy could be applied

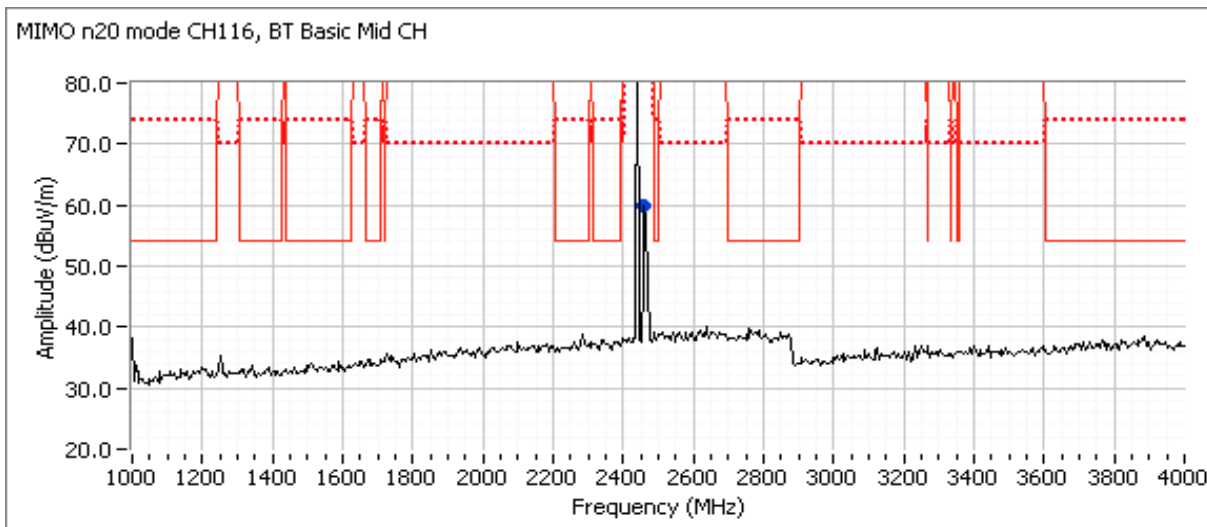



EMC Test Data

Client: Intel Corporation	Job Number: J94914
Model: 7265D2W	T-Log Number: T95472
Contact: Steve Hackett	Project Manager: Christine Krebill
Standard: FCC Part 15.247, 15.407, RSS-210	Project Coordinator: -
	Class: N/A

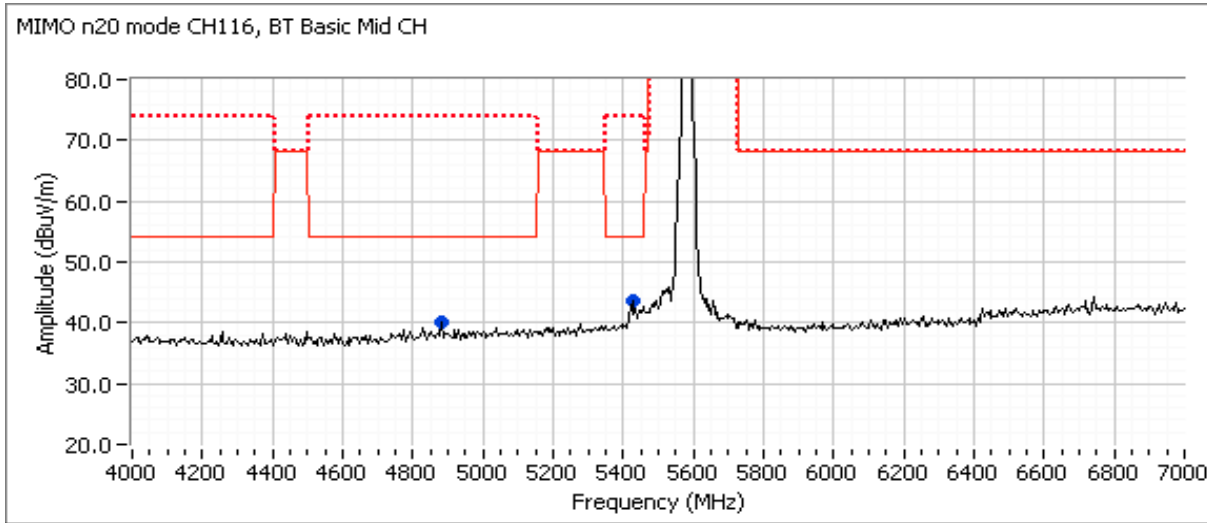

Run #14: 1-15GHz, 802.11n20 @ 5785 MHz Chain A+B, BT Basic Rate @ 2440 MHz Chain B
 Date of Test: 6/18/2014 Test Location: FT Chamber #4
 Test Engineer: R. Varelas Config Change: None

	Target (dBm)	Power Settings Measured (dBm)	Software Setting
WiFi A	16.0	16.7	34.5
WiFi B	16.0	16.5	35.5
Bluetooth	-	5.1	10.0

Note - measured power in table above is average power, for reference only.

Perform normal 7-15 GHz scan with filter for fundamental and then 1-4 and 4-7 GHz scans 20-30 cm from the product without filter.

Preliminary Measurements (Peak versus average limit)

Frequency	Level	Pol	15.209/15.247		Detector	Azimuth	Height	Comments
MHz	dB μ V/m	v/h	Limit	Margin	PK/QP/Avg	degrees	meters	
11570.260	46.3	V	54.0	-7.7	Peak	101	1.0	Harmonic of the EUT

Spurious Emissions (final measurements at 3m)

Frequency	Level	Pol	15.209 / 15.247		Detector	Azimuth	Height	Comments
MHz	dB μ V/m	v/h	Limit	Margin	PK/QP/Avg	degrees	meters	
refer to the spurious RE results								

Client: Intel Corporation	Job Number: J94914
Model: 7265D2W	T-Log Number: T95472
Contact: Steve Hackett	Project Manager: Christine Krebill
Standard: FCC Part 15.247, 15.407, RSS-210	Project Coordinator: -
	Class: N/A

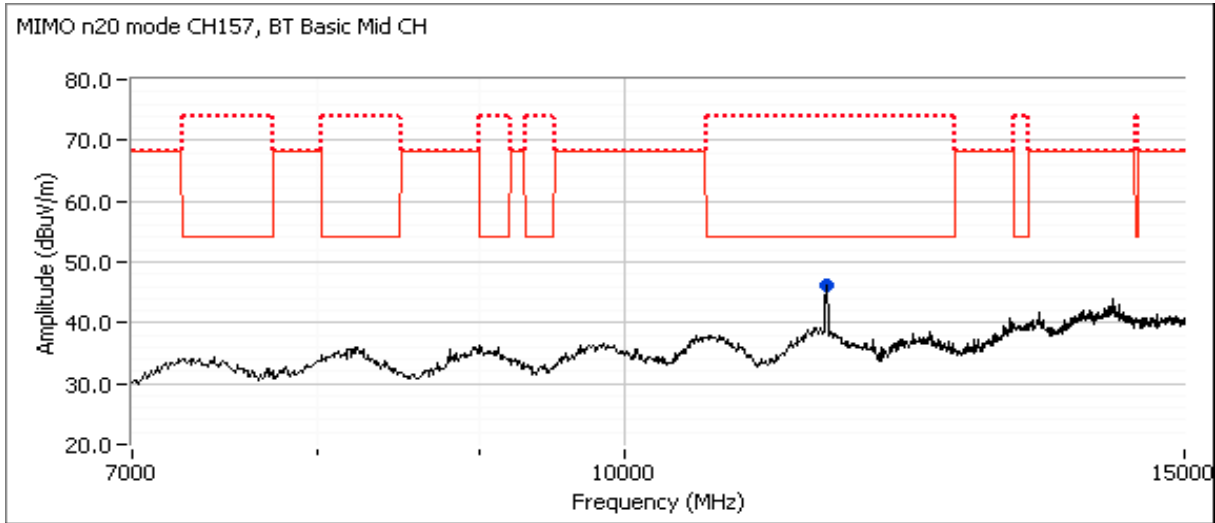

Preliminary Measurements (Peak versus average limit) at 20-30cm from EUT

Frequency	Level	Pol	15.209/15.247		Detector	Azimuth	Height	Comments
MHz	dBµV/m	v/h	Limit	Margin	PK/QP/Avg	degrees	meters	
2460.000	52.8	V	120.0	-67.2	Peak	180	1.0	In band intermittent signal

Spurious Emissions (final measurments at 3m)

Frequency	Level	Pol	15.209 / 15.247		Detector	Azimuth	Height	Comments
MHz	dBµV/m	v/h	Limit	Margin	PK/QP/Avg	degrees	meters	
Emissions is in band								

- Note 1: For emissions in restricted bands, the limit of 15.209 was used. For all other emissions, the limit was set 20dB below the level of the fundamental and measured in 100kHz.
- Note 2: Signal is not in a restricted band but the more stringent restricted band limit was used.
- Note 3: Signal is only present when Bluetooth is enabled, average correction for hopping occupancy could be applied

Client: Intel Corporation	Job Number: J94914
Model: 7265D2W	T-Log Number: T95472
Contact: Steve Hackett	Project Manager: Christine Krebill
Standard: FCC Part 15.247, 15.407, RSS-210	Project Coordinator: -
	Class: N/A

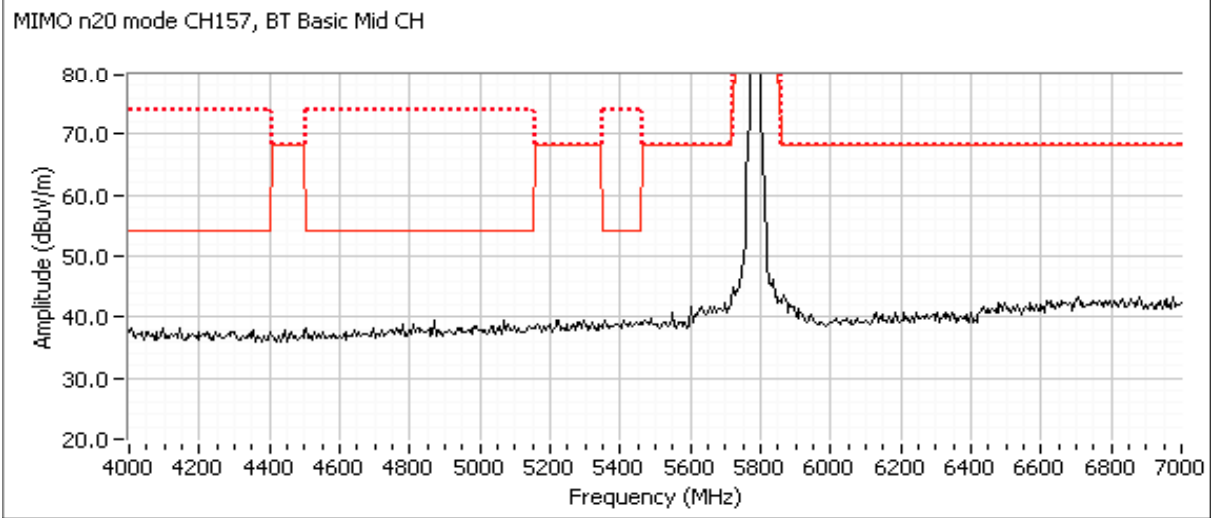
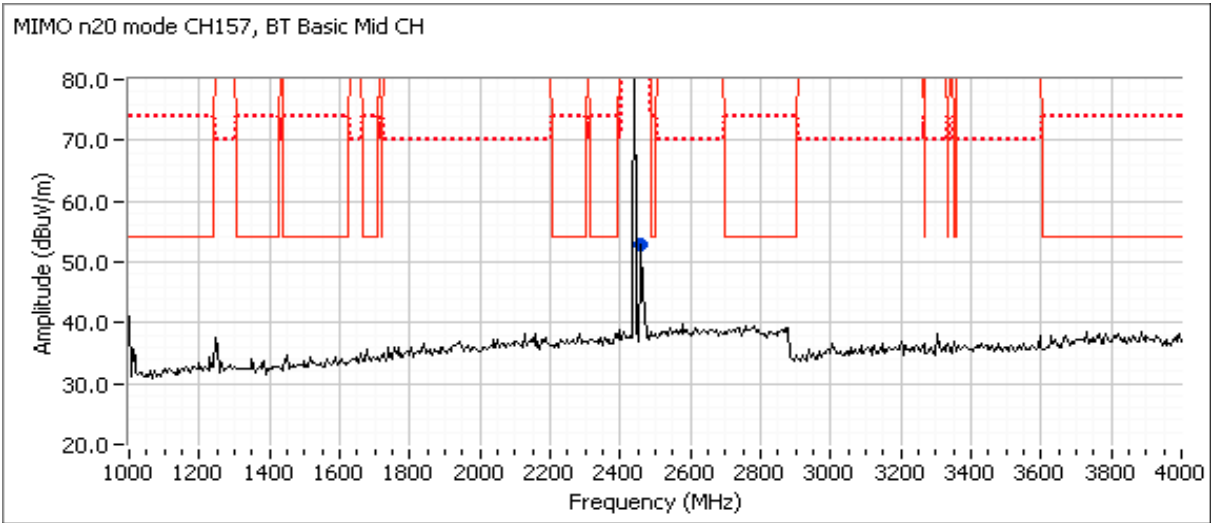



EMC Test Data

Client:	Intel Corporation	Job Number:	J94914
Model:	7265D2W	T-Log Number:	T95472
Contact:	Steve Hackett	Project Manager:	Christine Krebill
Standard:	FCC Part 15.247, 15.407, RSS-210	Project Coordinator:	-
		Class:	N/A

Radiated Emissions

(Elliott Laboratories Fremont Facility, Semi-Anechoic Chamber)

Test Specific Details

Objective: The objective of this test session is to perform final qualification testing of the EUT with respect to the specification listed above.

Date of Test: 6/17/2014
 Test Engineer: John Caizzi
 Test Location: Chamber 4

Config. Used: 1
 Config Change: none
 Host Unit Voltage 120V/60Hz

General Test Configuration

The EUT and any local support equipment were located on the turntable for radiated emissions testing. The test distance and extrapolation factor (if applicable) are detailed under each run description.

Note, preliminary testing indicates that the emissions were maximized by orientation of the EUT and elevation of the measurement antenna. Maximized testing indicated that the emissions were maximized by orientation of the EUT, elevation of the measurement

Ambient Conditions:

Temperature: 23 °C
 Rel. Humidity: 31 %

Summary of Results

MAC Address: 001500F15B3A, DRTU Tool Version 1.7.3-935, Driver version 17.1.0.11

Run #	Test Performed	Limit	Result	Margin
2	Radiated Emissions 30 - 1000 MHz, Maximized	FCC 15.209 / RSS 210	Pass	30.9 dBµV/m @ 112.94 MHz (-12.6 dB)
4	Radiated Emissions 30 - 1000 MHz, Maximized	FCC 15.209 / RSS 210	Pass	See above

Note - measurements with the WiFi and BT transmitters both operating indicate that the radiated emissions from the combination of test fixture and EUT are not affected by the module's operating frequency or mode. Additional channels and modes were therefore not necessary to show compliance with the limits.

Modifications Made During Testing

No modifications were made to the EUT during testing

Deviations From The Standard

No deviations were made from the requirements of the standard.



EMC Test Data

Client: Intel Corporation	Job Number: J94914
Model: 7265D2W	T-Log Number: T95472
Contact: Steve Hackett	Project Manager: Christine Krebill
Standard: FCC Part 15.247, 15.407, RSS-210	Project Coordinator: -
	Class: N/A

Run #1: Preliminary Radiated Emissions, 30 - 1000 MHz

Configured to Tx , 802.11b, 16.5 dBm on chain A (setting = 13.5) on channel 6, Bluetooth 5.1 dBm, 1Mb/s (setting 10 dBm) on channel 0

Test Parameters for Preliminary Scan(s)			
Frequency Range	Prescan Distance	Limit Distance	Extrapolation Factor
30 - 1000 MHz	3	3	0.0

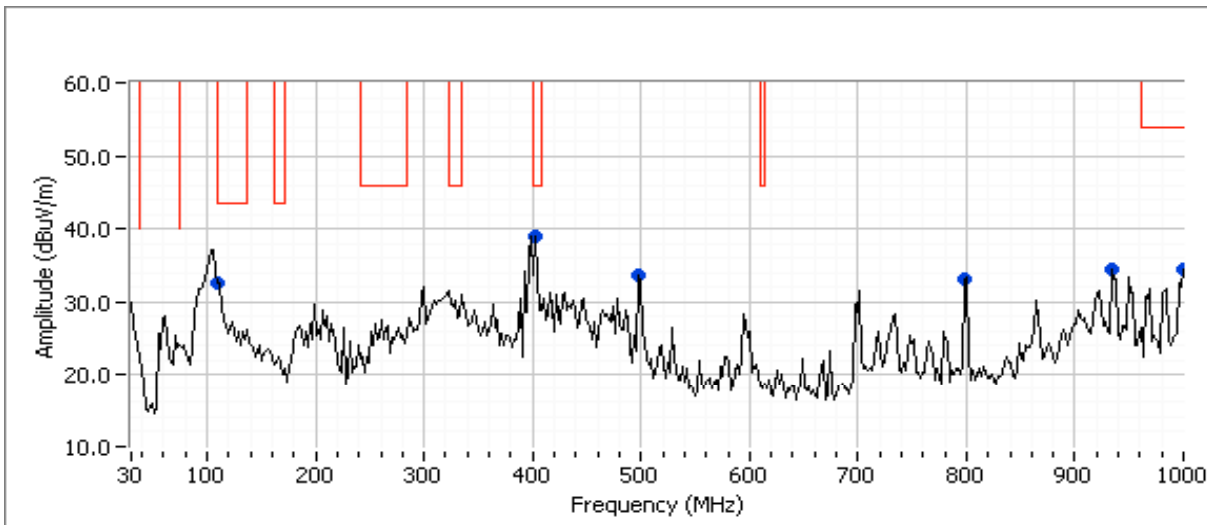

Preliminary peak readings captured during pre-scan

Frequency MHz	Level dBµV/m	Pol v/h	FCC 15.209 / RSS 210		Detector Pk/QP/Avg	Azimuth degrees	Height meters	Comments
			Limit	Margin				
112.935	32.7	V	43.5	-10.8	Peak	330	1.0	
399.925	38.9	H	46.0	-7.1	Peak	178	1.0	
497.952	33.8	H	46.0	-12.2	Peak	193	1.0	Note 1
799.457	33.2	V	46.0	-12.8	Peak	236	1.0	Note 1
933.500	34.6	H	46.0	-11.4	Peak	247	1.0	Note 1
999.347	34.5	V	54.0	-19.5	Peak	176	1.0	



EMC Test Data

Client:	Intel Corporation	Job Number:	J94914
Model:	7265D2W	T-Log Number:	T95472
Contact:	Steve Hackett	Project Manager:	Christine Krebill
Standard:	FCC Part 15.247, 15.407, RSS-210	Project Coordinator:	-
		Class:	N/A

Preliminary quasi-peak readings (no manipulation of EUT interface cables)

Frequency	Level	Pol	FCC 15.209 / RSS 210		Detector	Azimuth	Height	Comments
MHz	dB μ V/m	v/h	Limit	Margin	Pk/QP/Avg	degrees	meters	
112.935	30.9	V	43.5	-12.6	QP	45	1.00	
933.500	32.4	H	46.0	-13.6	QP	245	1.58	Note 1
799.457	30.6	V	46.0	-15.4	QP	151	1.04	Note 1
497.952	32.2	H	46.0	-13.8	QP	198	1.00	Note 1
399.925	33.3	H	46.0	-12.7	QP	182	1.00	
999.347	32.4	V	54.0	-21.6	QP	179	1.00	

Note 1: Emission in non-restricted band, but limit of 15.209 used.

Run #2: Maximized Readings From Run #1

Test Parameters for Maximized Reading(s)			
Frequency Range	Test Distance	Limit Distance	Extrapolation Factor
30 - 1000 MHz	3	3	0.0

Maximized quasi-peak readings (includes manipulation of EUT interface cables)

Frequency	Level	Pol	FCC 15.209 / RSS 210		Detector	Azimuth	Height	Comments
MHz	dB μ V/m	v/h	Limit	Margin	Pk/QP/Avg	degrees	meters	
112.935	30.9	V	43.5	-12.6	QP	45	1.00	
933.500	32.4	H	46.0	-13.6	QP	245	1.58	Note 1
799.457	30.6	V	46.0	-15.4	QP	151	1.04	Note 1
497.952	32.2	H	46.0	-13.8	QP	198	1.00	Note 1
399.925	33.3	H	46.0	-12.7	QP	182	1.00	
999.347	32.4	V	54.0	-21.6	QP	179	1.00	

Note 1: Emission in non-restricted band, but limit of 15.209 used.

Client: Intel Corporation	Job Number: J94914
Model: 7265D2W	T-Log Number: T95472
Contact: Steve Hackett	Project Manager: Christine Krebill
Standard: FCC Part 15.247, 15.407, RSS-210	Project Coordinator: -
	Class: N/A

Run #3: Preliminary Radiated Emissions, 30 - 1000 MHz
 Configured to Tx , 802.11a, 16.5 dBm on each chain (settings 25.5, 26.0) on channel 116, Bluetooth 4.7 dBm, 1Mb/s (setting 10 dBm) on Channel 78.

Test Parameters for Preliminary Scan(s)			
Frequency Range	Prescan Distance	Limit Distance	Extrapolation Factor
30 - 1000 MHz	3	3	0.0

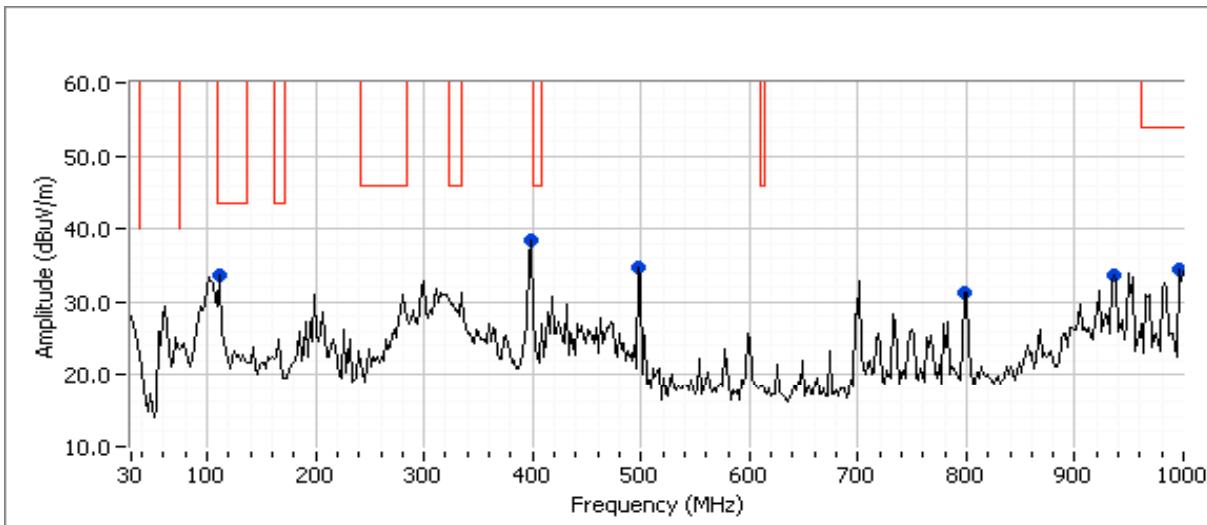

Preliminary peak readings captured during pre-scan

Frequency MHz	Level dB μ V/m	Pol v/h	FCC 15.209 / RSS 210		Detector Pk/QP/Avg	Azimuth degrees	Height meters	Comments
			Limit	Margin				
111.643	33.8	H	43.5	-9.7	Peak	89	3.0	
399.339	38.5	H	46.0	-7.5	Peak	169	1.0	Note 1
498.477	34.8	H	46.0	-11.2	Peak	199	1.0	Note 1
797.836	31.4	H	46.0	-14.6	Peak	79	1.0	Note 1
935.852	33.7	H	46.0	-12.3	Peak	249	1.0	Note 1
996.112	34.4	H	54.0	-19.6	Peak	319	1.0	

Note 1: Emission in non-restricted band, but limit of 15.209 used.



EMC Test Data

Client:	Intel Corporation	Job Number:	J94914
Model:	7265D2W	T-Log Number:	T95472
Contact:	Steve Hackett	Project Manager:	Christine Krebill
Standard:	FCC Part 15.247, 15.407, RSS-210	Project Coordinator:	-
		Class:	N/A

Preliminary quasi-peak readings (no manipulation of EUT interface cables)

Frequency	Level	Pol	FCC 15.209 / RSS 210		Detector	Azimuth	Height	Comments
MHz	dB μ V/m	v/h	Limit	Margin	Pk/QP/Avg	degrees	meters	

Run #4: Maximized Readings From Run #3

Test Parameters for Maximized Reading(s)			
Frequency Range	Test Distance	Limit Distance	Extrapolation Factor
30 - 1000 MHz	3	3	0.0

Maximized quasi-peak readings (includes manipulation of EUT interface cables)

Frequency	Level	Pol	FCC 15.209 / RSS 210		Detector	Azimuth	Height	Comments
MHz	dB μ V/m	v/h	Limit	Margin	Pk/QP/Avg	degrees	meters	



EMC Test Data

Client:	Intel Corporation	Job Number:	J94914
Model:	7265D2W	T-Log Number:	T95472
Contact:	Steve Hackett	Project Manager:	Christine Krebill
Standard:	FCC Part 15.247, 15.407, RSS-210	Project Coordinator:	-
		Class:	N/A

Conducted Emissions

(Elliott Laboratories Fremont Facility, Semi-Anechoic Chamber)

Test Specific Details

Objective: The objective of this test session is to perform final qualification testing of the EUT with respect to the specification listed above.

Date of Test: 6/20/2014
 Test Engineer: Jack Liu
 Test Location: FT Chamber# 4

Config. Used: 1
 Config Change: None
 Host Unit Voltage 120V/60Hz

General Test Configuration

The EUT on the test fixture and other support equipment was located on a wooden table inside the semi-anechoic chamber, 40 cm from a vertical coupling plane and 80cm from the LISN. A second LISN was used for all local support equipment. Remote support

Ambient Conditions:

Temperature: 24 °C
 Rel. Humidity: 38 %

Summary of Results

Run #	Test Performed	Limit	Result	Margin
1	CE, AC Power, 120V/60Hz	RSS 210 / 15.207	Pass	62.0 dBµV @ 0.152 MHz (-3.9 dB)

Modifications Made During Testing

No modifications were made to the EUT during testing

Deviations From The Standard

No deviations were made from the requirements of the standard.

Sample Notes

MAC Address: 001500F15B3A DRTU Tool Version 1.7.3-935 Driver version 17.1.0.11

Client: Intel Corporation	Job Number: J94914
Model: 7265D2W	T-Log Number: T95472
Contact: Steve Hackett	Project Manager: Christine Krebill
Standard: FCC Part 15.247, 15.407, RSS-210	Project Coordinator: -
	Class: N/A

Run #1: AC Power Port Conducted Emissions, 0.15 - 30MHz, 120V/60Hz
 Configured to Tx , 802.11a, 16.5 dBm on each chain (settings 25.5, 26.0) on channel 116, Bluetooth 5.1dBm, 1Mb/s (setting 10 dBm) on Mid Channel (2440MHz).

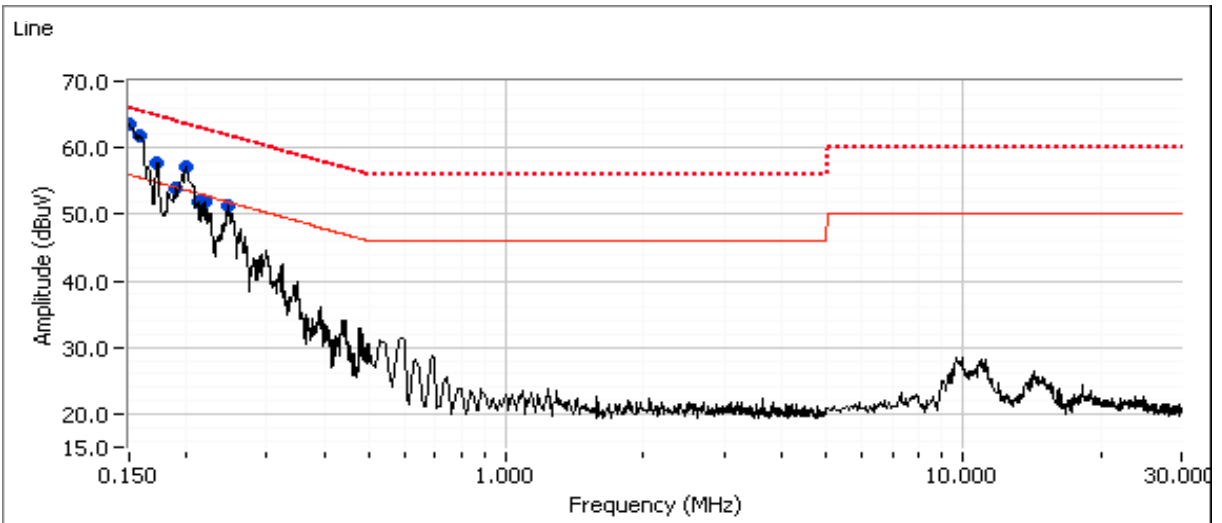
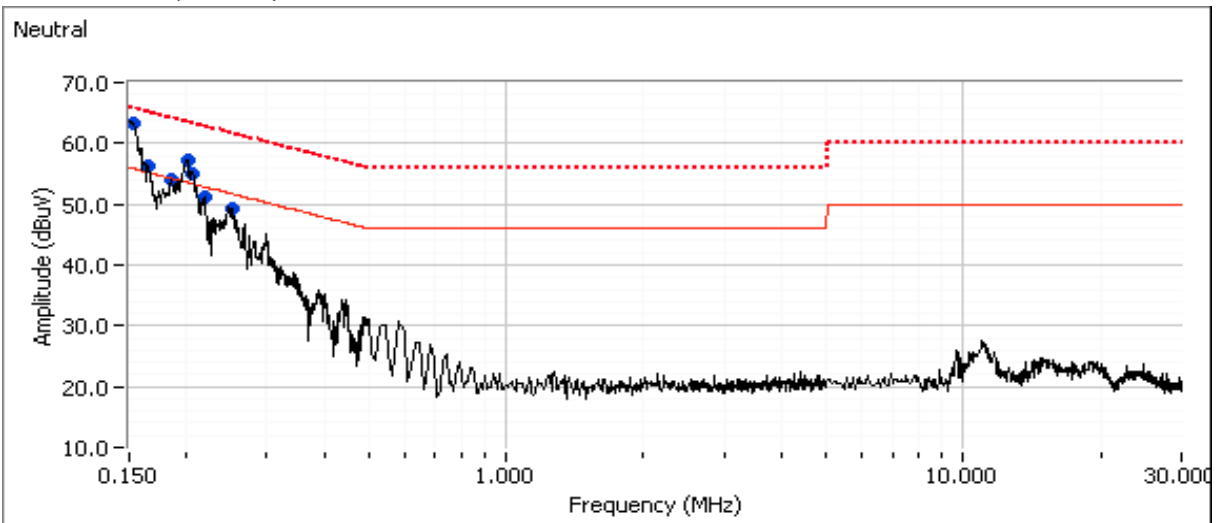



EMC Test Data

Client:	Intel Corporation	Job Number:	J94914
Model:	7265D2W	T-Log Number:	T95472
Contact:	Steve Hackett	Project Manager:	Christine Krebill
Standard:	FCC Part 15.247, 15.407, RSS-210	Project Coordinator:	-
		Class:	N/A

Preliminary peak readings captured during pre-scan (peak readings vs. average limit)

Frequency MHz	Level dB μ V	AC Line	RSS 210 / 15.207		Detector QP/Ave	Comments
			Limit	Margin		
0.200	57.1	Neutral	53.6	3.5	Peak	
0.150	63.2	Neutral	55.8	7.4	Peak	
0.162	56.2	Neutral	55.2	1.0	Peak	
0.188	53.9	Neutral	54.2	-0.3	Peak	
0.207	55.0	Neutral	53.3	1.7	Peak	
0.219	51.3	Neutral	52.9	-1.6	Peak	
0.251	49.3	Neutral	51.7	-2.4	Peak	
0.152	63.6	Line	56.0	7.6	Peak	
0.160	61.9	Line	55.6	6.3	Peak	
0.174	57.7	Line	54.8	2.9	Peak	
0.198	57.0	Line	53.6	3.4	Peak	
0.190	54.0	Line	54.0	0.0	Peak	
0.210	52.0	Line	53.1	-1.1	Peak	
0.222	51.9	Line	52.8	-0.9	Peak	
0.246	51.2	Line	51.9	-0.7	Peak	



EMC Test Data

Client:	Intel Corporation	Job Number:	J94914
Model:	7265D2W	T-Log Number:	T95472
Contact:	Steve Hackett	Project Manager:	Christine Krebill
Standard:	FCC Part 15.247, 15.407, RSS-210	Project Coordinator:	-
		Class:	N/A

Final quasi-peak and average readings

Frequency MHz	Level dB μ V	AC Line	RSS 210 / 15.207		Detector QP/Ave	Comments
			Limit	Margin		
0.152	62.0	Line	65.9	-3.9	QP	QP (1.00s)
0.152	47.8	Line	55.9	-8.1	AVG	AVG (0.10s)
0.200	54.7	Neutral	63.6	-8.9	QP	QP (1.00s)
0.198	54.4	Line	63.7	-9.3	QP	QP (1.00s)
0.160	46.1	Line	55.5	-9.4	AVG	AVG (0.10s)
0.160	56.0	Line	65.5	-9.5	QP	QP (1.00s)
0.162	55.3	Neutral	65.4	-10.1	QP	QP (1.00s)
0.210	51.6	Line	63.2	-11.6	QP	QP (1.00s)
0.190	52.3	Line	64.0	-11.7	QP	QP (1.00s)
0.162	43.1	Neutral	55.4	-12.3	AVG	AVG (0.10s)
0.174	51.9	Line	64.8	-12.9	QP	QP (1.00s)
0.150	52.9	Neutral	66.0	-13.1	QP	QP (1.00s)
0.207	50.1	Neutral	63.3	-13.2	QP	QP (1.00s)
0.200	39.6	Neutral	53.6	-14.0	AVG	AVG (0.10s)
0.188	50.1	Neutral	64.1	-14.0	QP	QP (1.00s)
0.246	47.7	Line	61.9	-14.2	QP	QP (1.00s)
0.251	47.2	Neutral	61.7	-14.5	QP	QP (1.00s)
0.174	39.2	Line	54.8	-15.6	AVG	AVG (0.10s)
0.198	37.9	Line	53.7	-15.8	AVG	AVG (0.10s)
0.210	36.8	Line	53.2	-16.4	AVG	AVG (0.10s)
0.150	39.0	Neutral	56.0	-17.0	AVG	AVG (0.10s)
0.219	45.2	Neutral	62.9	-17.7	QP	QP (1.00s)
0.222	44.8	Line	62.7	-17.9	QP	QP (1.00s)
0.207	34.7	Neutral	53.3	-18.6	AVG	AVG (0.10s)
0.251	32.0	Neutral	51.7	-19.7	AVG	AVG (0.10s)
0.190	34.2	Line	54.0	-19.8	AVG	AVG (0.10s)
0.188	34.1	Neutral	54.1	-20.0	AVG	AVG (0.10s)
0.219	32.5	Neutral	52.9	-20.4	AVG	AVG (0.10s)
0.246	31.5	Line	51.9	-20.4	AVG	AVG (0.10s)
0.222	30.9	Line	52.7	-21.8	AVG	AVG (0.10s)

End of Report

This page is intentionally blank and marks the last page of this test report.