

## *EMC Test Report*

### *Application for Grant of Equipment Authorization*

### *Industry Canada RSS-Gen Issue 3 / RSS 210 Issue 8 FCC Part 15, Subpart E*

*Model: 7265D2W*

IC CERTIFICATION #: 1000M-7265D2  
FCC ID: PD97265D2

APPLICANT: Intel Mobile Communications  
100 Center Point Circle, Suite 200  
Columbia, SC 29210, USA

TEST SITE(S): National Technical Systems - Silicon Valley  
41039 Boyce Road.  
Fremont, CA. 94538-2435

IC SITE REGISTRATION #: 2845B-3; 2845B-4, 2845B-5, 2845B-7

REPORT DATE: July 8, 2014

FINAL TEST DATES: June 5 through July 8, 2014

TOTAL NUMBER OF PAGES: 284

PROGRAM MGR /  
TECHNICAL REVIEWER:



David W. Bare  
Chief Engineer

QUALITY ASSURANCE DELEGATE /  
FINAL REPORT PREPARER:

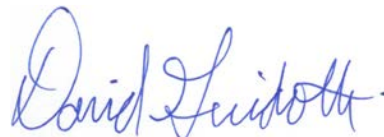

David Guidotti  
Senior Technical Writer



National Technical Systems - Silicon Valley is accredited by the A2LA, certificate number 0214.26, to perform the test(s) listed in this report, except where noted otherwise. This report and the information contained herein represent the results of testing test articles identified and selected by the client performed to specifications and/or procedures selected by the client. National Technical Systems (NTS) makes no representations, expressed or implied, that such testing is adequate (or inadequate) to demonstrate efficiency, performance, reliability, or any other characteristic of the articles being tested, or similar products. This report should not be relied upon as an endorsement or certification by NTS of the equipment tested, nor does it represent any statement whatsoever as to its merchantability or fitness of the test article, or similar products, for a particular purpose. This report shall not be reproduced except in full

**REVISION HISTORY**

Rev#	Date	Comments	Modified By
-	July 8, 2014	First release	

**TABLE OF CONTENTS**

**REVISION HISTORY .....2**  
**TABLE OF CONTENTS .....3**  
**SCOPE.....4**  
**OBJECTIVE .....4**  
**STATEMENT OF COMPLIANCE.....5**  
**DEVIATIONS FROM THE STANDARDS.....5**  
**TEST RESULTS SUMMARY .....6**  
    UNII / LELAN DEVICES .....6  
    GENERAL REQUIREMENTS APPLICABLE TO ALL BANDS.....10  
    MEASUREMENT UNCERTAINTIES.....11  
**EQUIPMENT UNDER TEST (EUT) DETAILS.....12**  
    GENERAL.....12  
    ANTENNA SYSTEM .....12  
    ENCLOSURE.....12  
    MODIFICATIONS .....12  
    SUPPORT EQUIPMENT .....12  
    EUT INTERFACE PORTS .....13  
    EUT OPERATION .....13  
**TEST SITE.....14**  
    GENERAL INFORMATION .....14  
    CONDUCTED EMISSIONS CONSIDERATIONS .....14  
    RADIATED EMISSIONS CONSIDERATIONS .....14  
**MEASUREMENT INSTRUMENTATION .....15**  
    RECEIVER SYSTEM .....15  
    INSTRUMENT CONTROL COMPUTER .....15  
    LINE IMPEDANCE STABILIZATION NETWORK (LISN).....15  
    FILTERS/ATTENUATORS .....16  
    ANTENNAS.....16  
    ANTENNA MAST AND EQUIPMENT TURNTABLE .....16  
    INSTRUMENT CALIBRATION.....16  
**TEST PROCEDURES .....17**  
    EUT AND CABLE PLACEMENT .....17  
    CONDUCTED EMISSIONS.....17  
    RADIATED EMISSIONS .....18  
    CONDUCTED EMISSIONS FROM ANTENNA PORT .....20  
    BANDWIDTH MEASUREMENTS .....20  
    SPECIFICATION LIMITS AND SAMPLE CALCULATIONS .....21  
    CONDUCTED EMISSIONS SPECIFICATION LIMITS: FCC 15.207; FCC 15.107(A), RSS GEN .....21  
    GENERAL TRANSMITTER RADIATED EMISSIONS SPECIFICATION LIMITS .....22  
    FCC 15.407 (A) OUTPUT POWER LIMITS .....22  
    OUTPUT POWER LIMITS –LELAN DEVICES .....23  
    SPURIOUS EMISSIONS LIMITS –UNII AND LELAN DEVICES .....23  
    SAMPLE CALCULATIONS - CONDUCTED EMISSIONS .....23  
    SAMPLE CALCULATIONS - RADIATED EMISSIONS .....24  
    SAMPLE CALCULATIONS - FIELD STRENGTH TO EIRP CONVERSION.....25  
**APPENDIX A TEST EQUIPMENT CALIBRATION DATA .....26**  
**APPENDIX B TEST DATA .....30**  
**END OF REPORT .....284**

## SCOPE

An electromagnetic emissions test has been performed on the Intel Mobile Communications model 7265D2W, pursuant to the following rules:

Industry Canada RSS-Gen Issue 3

RSS 210 Issue 8 “Low-power Licence-exempt Radiocommunication Devices (All Frequency Bands): Category I Equipment”

FCC Part 15, Subpart E requirements for UNII Devices

Conducted and radiated emissions data has been collected, reduced, and analyzed within this report in accordance with measurement guidelines set forth in the following reference standards and as outlined in National Technical Systems - Silicon Valley test procedures:

ANSI C63.10-2009

FCC General UNII Test Procedures KDB789033

The intentional radiator above has been tested in a simulated typical installation to demonstrate compliance with the relevant Industry Canada performance and procedural standards.

Final system data was gathered in a mode that tended to maximize emissions by varying orientation of EUT, orientation of power and I/O cabling, antenna search height, and antenna polarization.

Every practical effort was made to perform an impartial test using appropriate test equipment of known calibration. All pertinent factors have been applied to reach the determination of compliance.

## OBJECTIVE

The primary objective of the manufacturer is compliance with the regulations outlined in the previous section.

Prior to marketing in the USA, all unlicensed transmitters and transceivers require certification. Receive-only devices operating between 30 MHz and 960 MHz are subject to either certification or a manufacturer’s declaration of conformity, with all other receive-only devices exempt from the technical requirements.

Prior to marketing in Canada, Class I transmitters, receivers and transceivers require certification. Class II devices are required to meet the appropriate technical requirements but are exempt from certification requirements.

Certification is a procedure where the manufacturer submits test data and technical information to a certification body and receives a certificate or grant of equipment authorization upon successful completion of the certification body’s review of the submitted documents. Once the equipment authorization has been obtained, the label indicating compliance must be attached to all identical units, which are subsequently manufactured.

Testing was performed only on model 7265D2W. This model was considered representative of the following models:

7265D2W and 7265D2W AN

#### **STATEMENT OF COMPLIANCE**

The tested sample of Intel Mobile Communications model 7265D2W complied with the requirements of the following regulations:

RSS 210 Issue 8 “Low-power Licence-exempt Radiocommunication Devices (All Frequency Bands): Category I Equipment”, Annex 9  
FCC Part 15, Subpart E requirements for UNII Devices

Maintenance of compliance is the responsibility of the manufacturer. Any modifications to the product should be assessed to determine their potential impact on the compliance status of the device with respect to the standards detailed in this test report.

The test results recorded herein are based on a single type test of Intel Mobile Communications model 7265D2W and therefore apply only to the tested sample. The sample was selected and prepared by Steven Hackett of Intel Mobile Communications.

#### **DEVIATIONS FROM THE STANDARDS**

No deviations were made from the published requirements listed in the scope of this report.

**TEST RESULTS SUMMARY****UNII / LELAN DEVICES****Operation in the 5.15 – 5.25 GHz Band**

FCC Rule Part	Description	Measured Value / Comments	Limit / Requirement	Result
15.407(e)	Indoor operation only	Refer to user's manual	N/A	Complies
15.407 (a) (1)	Output Power	802.11a: 16.1 dBm n20: 16.6 dBm n40: 19.1 dBm ac80: 15.2 dBm (Max eirp: 0.186 W)	24dBm (250 mW) (eirp <= 36 dBm)	Complies
15.407 (a) (1)	Power Spectral Density	2.2 dBm/MHz (801.11n40 mode)	10.4 dBm/MHz <sup>1</sup>	Complies

**Operation in the 5.15 – 5.25 GHz Band**

RSS Rule Part	Description	Measured Value / Comments	Limit / Requirement	Result
	Indoor operation only	Refer to user's manual	N/A	Complies
A9.2(1) RSS GEN 4.6.1	Min 99% Bandwidth	802.11a: 16.7 MHz n20: 16.7 MHz n40: 36.3 MHz ac80: 75.6 MHz	N/A – limits output power if < 20MHz	N/A
A9.2(1)	Output Power	802.11a: 16.1 dBm n20: 16.6 dBm n40: 19.1 dBm ac80: 15.2 dBm (Max eirp: 0.186 W)	17dBm (50 mW) (eirp <= 23 dBm)	Complies
A9.5 (2)	Power Spectral Density	2.2 dBm/MHz (801.11n40 mode)	3.4 dBm/MHz <sup>2</sup>	Complies

<sup>1</sup> Reduced from 11 to 10.4 dBm/MHz as the effective antenna gain is 6.6 dBi<sup>2</sup> Reduced from 4 to 3.4 dBm/MHz as the effective antenna gain is 6.6 dBi

**Operation in the 5.25 – 5.35 GHz Band**

FCC Rule Part	Description	Measured Value / Comments	Limit / Requirement	Result (margin)
15.407(a) (2)	26dB Bandwidth	802.11a: 22.3 MHz n20: 21.7 MHz n40: 40.5 MHz ac80: 89.8 MHz	N/A – limits output power if < 20MHz	N/A
15.407(a) (2)	Output Power	802.11a: 17.1 dBm n20: 19.7 dBm n40: 19.9 dBm ac80: 14.3 dBm (Max eirp: 0.227 W)	24dBm (250mW) (eirp <= 30 dBm)	Complies
15.407(a) (2)	Power Spectral Density	5.5 dBm/MHz (802.11n20 mode)	10.3 dBm/MHz <sup>3</sup>	Complies

**Operation in the 5.25 – 5.35 GHz Band**

RSS Rule Part	Description	Measured Value / Comments	Limit / Requirement	Result (margin)
A9.2(2) RSS GEN 4.6.1	Min 99% Bandwidth	802.11a: 16.7 MHz n20: 17.9 MHz n40: 36.1 MHz ac80: 75.6 MHz	N/A – limits output power if < 20MHz	N/A
A9.2(2)	Output Power	802.11a: 17.1 dBm n20: 19.7 dBm n40: 19.9 dBm ac80: 14.3 dBm (Max eirp: 0.227 W)	24dBm (250mW) (eirp <= 30 dBm)	Complies
A9.2(2) / A9.5 (2)	Power Spectral Density	5.5 dBm/MHz (802.11n20 mode)	11 dBm/MHz	Complies

<sup>3</sup> Reduced from 11 to 10.3 dBm/MHz as the effective antenna gain is 6.7 dBi

**Operation in the 5.47 – 5.725 GHz Band**

FCC Rule Part	Description	Measured Value / Comments	Limit / Requirement	Result (margin)
15.407(a) (2)	26dB Bandwidth	802.11a: 21.6 MHz n20: 21.7 MHz n40: 41.7 MHz ac80: 80.5 MHz	N/A – limits output power if < 20MHz	N/A
15.407(a) (2)	Output Power	802.11a: 16.7 dBm n20: 19.8 dBm n40: 20.2 dBm ac80: 20.2 dBm (Max eirp: 0.320 W)	24 dBm 250mW (eirp <= 30 dBm)	Complies
15.407(a) (2))	Power Spectral Density	7.8 dBm/MHz (802.11n20 mode)	9.2 dBm/MHz <sup>4</sup>	Complies

**Operation in the 5.47 – 5.725 GHz Band**

RSS Rule Part	Description	Measured Value / Comments	Limit / Requirement	Result (margin)
	Min 99% Bandwidth	802.11a: 16.6 MHz n20: 17.9 MHz n40: 36.1 MHz ac80: 75.4 MHz	N/A – limits output power if < 20MHz	N/A
A9.2(2)	Output Power	802.11a: 16.7 dBm n20: 19.8 dBm n40: 20.2 dBm ac80: 20.2 dBm (Max eirp: 0.320 W)	24 dBm 250mW (eirp <= 30 dBm)	Complies
A9.2(2) / A9.5 (2)	Power Spectral Density	7.8 dBm/MHz (802.11n20 mode)	11 dBm/MHz	Complies
A9	Non-operation in 5600 – 5650 MHz sub band	Device passive scans only in the 5600 – 5650 MHz band –refer to Attestation from Intel		Complies

**Operation in the 5.725 – 5.850 GHz Band**

FCC Rule Part	Description	Measured Value / Comments	Limit / Requirement	Result (margin)
15.407(e)	Min 6 dB Bandwidth	802.11a: 15.1 MHz n20: 15.1 MHz n40: 35.0 MHz ac80: 75.1 MHz	>= 500 kHz	N/A
15.407(a) (3)	Output Power	802.11a: 17.1 dBm n20: 20.0 dBm n40: 20.1 dBm ac80: 14.0 dBm (Max eirp: 0.321 W)	30 dBm 1 W (eirp <= 36 dBm)	Complies
15.407(a) (3))	Power Spectral Density	8.0 dBm/MHz (802.11n20 mode)	28 dBm/MHz <sup>5</sup>	Complies

<sup>4</sup> Reduced from 11 to 9.2 dBm/MHz as the effective antenna gain is 7.8 dBi<sup>5</sup> Reduced from 30 to 28 dBm/MHz as the effective antenna gain is 8 dBi



**Requirements for all U-NII/LELAN bands**

FCC Rule Part	RSS Rule Part	Description	Measured Value / Comments	Limit / Requirement	Result
15.407	A9.5a	Modulation	Digital Modulation is used (Refer to Attestation from Intel)	Digital modulation is required	Complies
15.407(b) (5) / 15.209	A9.3	Spurious Emissions below 1GHz		Refer to page 23	Complies
15.407(b) (5) / 15.209	A9.3	Spurious Emissions above 1GHz			Complies
	A9.5 (3)	Channel Selection	Spurious emissions tested at outermost channels in each band	Device was tested on the top, bottom and center channels in each band	N/A
15.407(b)(8)			Measurements on three channels in each band		
15.407 (c)	A9.5(4)	Operation in the absence of information to transmit	Operation is discontinued in the absence of information (Refer to Attestation from Intel)	Device shall automatically discontinue operation in the absence of information to transmit	Complies
15.407 (g)	A9.5 (5)	Frequency Stability	Frequency stability is better than 20ppm (Refer to Attestation from Intel)	Signal shall remain within the allocated band	Complies
15.407 (h1)	A9.4	Transmit Power Control	TPC is not required as the device operates at below 500mW eirp	The U-NII device shall have the capability to operate with a mean EIRP value lower than 24dBm (250mW)	Complies
15.407 (h2)	A9.4	Dynamic frequency Selection (device without radar detection)	Refer to separate test report, reference R95544	Channel closing transmission time < 260ms Channel move time < 10s Non occupancy period > 30minutes	Complies
15.407(i)	-	Device Security	Refer to Attestation from Intel	Security to protect against unauthorized modification of the device	Complies
	A9.9g	User Manual information	Refer to User Manual Page 16	Warning regarding interference from Satellite Systems	Complies

**GENERAL REQUIREMENTS APPLICABLE TO ALL BANDS**

FCC Rule Part	RSS Rule part	Description	Measured Value / Comments	Limit / Requirement	Result (margin)
15.203	-	RF Connector	Unique iPex-4 connector	Unique or integral antenna required	Complies
15.207	RSS GEN Table 4	AC Conducted Emissions	62.0 dB $\mu$ V @ 0.152 MHz (-3.9 dB)	Refer to page 21	Complies
15.247 (b) (5) 15.407 (f)	RSS 102	RF Exposure Requirements	Refer to SAR report RSS 102 declaration and User Manual statements	Refer to OET 65, FCC Part 1 and RSS 102	Complies
-	RSP 100 RSS GEN 7.1.3	User Manual	Refer to User Manual, Page 17	Statement required regarding non- interference	Complies
-	RSP 100 RSS GEN 7.1.2	User Manual	Refer to User Manual page 12	Statement for products with detachable antenna	Complies

**MEASUREMENT UNCERTAINTIES**

ISO/IEC 17025 requires that an estimate of the measurement uncertainties associated with the emissions test results be included in the report. The measurement uncertainties given below are based on a 95% confidence level and were calculated in accordance with UKAS document LAB 34.

Measurement Type	Measurement Unit	Frequency Range	Expanded Uncertainty
RF power, conducted (power meter)	dBm	25 to 7000 MHz	± 0.52 dB
RF power, conducted (Spectrum analyzer)	dBm	25 to 7000 MHz	± 0.7 dB
Conducted emission of transmitter	dBm	25 to 26500 MHz	± 0.7 dB
Conducted emission of receiver	dBm	25 to 26500 MHz	± 0.7 dB
Radiated emission (substitution method)	dBm	25 to 26500 MHz	± 2.5 dB
Radiated emission (field strength)	dB $\mu$ V/m	25 to 1000 MHz	± 3.6 dB
		1000 to 40000 MHz	± 6.0 dB
Conducted Emissions (AC Power)	dB $\mu$ V	0.15 to 30 MHz	± 2.4 dB

**EQUIPMENT UNDER TEST (EUT) DETAILS****GENERAL**

The Intel Mobile Communications models 7265D2W and 7265D2W AN are 2x2 Wi-Fi and Bluetooth radio modules which support 802.11abgnac in 2x2 (MIMO) and 1x1 (SISO) modes & BT 4.0 (Basic rate, EDR and BLE modes). Since the EUT would be placed on a tabletop during operation, the EUT was treated as tabletop equipment during testing to simulate the end-user environment. The electrical rating of the EUT is 3.3 VDC.

The sample was received on June 5, 2014 and tested on June 5 through July 8, 2014. The EUT consisted of the following component(s):

Manufacturer	Model	Description	Serial Number	FCC and Canada IDs
Intel Mobile Communications	7265D2W	M.2 Card form factor Bluetooth / IEEE 802.11a/b/g/n/ac wireless network adapter	00:15:00:F1:5B:5D or 00:15:00:F1:5B:3A	PD97265D2 1000M-7265D2

**ANTENNA SYSTEM**

The EUT antenna is a two-antenna PIFA antenna system – Shanghai Universe Communication Electron Co., Ltd. One or both antennas are used for WiFi operation and one for Bluetooth operation. For Bluetooth: Tx is chain B, Rx is chain B. For WiFi, only Chain A is used for transmit in the 2.4GHz band when Bluetooth is active, both chains can be used in 5GHz bands.

**ENCLOSURE**

The EUT has no enclosure. It is designed to be installed within the enclosure of a host computer.

**MODIFICATIONS**

No modifications were made to the EUT during the time the product was at NTS Silicon Valley.

**SUPPORT EQUIPMENT**

The following equipment was used as support equipment for testing:

Company	Model	Description	Serial Number	FCC ID
Dell	DCCY	Desktop computer	BJYN64J	-
Hanns G	HX191DPBUFLF6	LCD monitor	017GR3XY00286	-
Logitech	5680157	Mouse	LNA20956449	-
Intel	NGFF Extension REV 01	Extension Board	4164912-200	-

**EUT INTERFACE PORTS**

The I/O cabling configuration during testing was as follows:

Port	Connected To	Description	Cable(s)	
			Shielded or Unshielded	Length(m)
Antenna (x2)	Antenna	RF cable	Shielded	0.3
Desktop Mini PCIe Slot	Extension Board	Ribbon	Unshielded	0.8
Desktop USB	Extension Board	Multiwire	Unshielded	1.2
Desktop AC power supply	AC Main	power cable	Unshielded	2.3
Power (test fixture)	Computer	Multiwire	Unshielded	1.5
Desktop USB	Keyboard	Multiwire	Shielded	1.0
Desktop USB	Mouse	Multiwire	Shielded	1.0
Desktop Display	Monitor	Multiwire	Shielded	1.0

**EUT OPERATION**

During emissions testing the EUT was transmitting on the frequency & at the power level selected in the proprietary DRTU control software.

**TEST SITE****GENERAL INFORMATION**

Final test measurements were taken at the test sites listed below. Pursuant to section 2.948 of the FCC's Rules and section 3.3 of RSP-100, construction, calibration, and equipment data has been filed with the Commission and with industry Canada.

Site	Designation / Registration Numbers		Location
	FCC	Canada	
Chamber 3	US0027	2845B-3	41039 Boyce Road Fremont, CA 94538-2435
Chamber 4	US0027	2845B-4	
Chamber 5	US0027	2845B-5	
Chamber 7	US0027	2845B-7	

ANSI C63.4 recommends that ambient noise at the test site be at least 6 dB below the allowable limits. Ambient levels are below this requirement. The test site(s) contain separate areas for radiated and conducted emissions testing. Considerable engineering effort has been expended to ensure that the facilities conform to all pertinent requirements of ANSI C63.4.

**CONDUCTED EMISSIONS CONSIDERATIONS**

Conducted emissions testing is performed in conformance with ANSI C63.10. Measurements are made with the EUT connected to the public power network through a nominal, standardized RF impedance, which is provided by a line impedance stabilization network, known as a LISN. A LISN is inserted in series with each current-carrying conductor in the EUT power cord.

**RADIATED EMISSIONS CONSIDERATIONS**

The FCC has determined that radiation measurements made in a shielded enclosure are not suitable for determining levels of radiated emissions. Radiated measurements are performed in an open field environment or in a semi-anechoic chamber. The test sites are maintained free of conductive objects within the CISPR defined elliptical area incorporated in ANSI C63.4 guidelines and meet the Normalized Site Attenuation (NSA) requirements of ANSI C63.4.

## MEASUREMENT INSTRUMENTATION

### RECEIVER SYSTEM

An EMI receiver as specified in CISPR 16-1-1 is used for emissions measurements. The receivers used can measure over the frequency range of 9 kHz up to 2000 MHz. These receivers allow both ease of measurement and high accuracy to be achieved. The receivers have Peak, Average, and CISPR (Quasi-peak) detectors built into their design so no external adapters are necessary. The receiver automatically sets the required bandwidth for the CISPR detector used during measurements. If the repetition frequency of the signal being measured is below 20Hz, peak measurements are made in lieu of Quasi-Peak measurements.

For measurements above the frequency range of the receivers, a spectrum analyzer is utilized because it provides visibility of the entire spectrum along with the precision and versatility required to support engineering analysis. Average measurements above 1000MHz are performed on the spectrum analyzer using the linear-average method with a resolution bandwidth of 1 MHz and a video bandwidth of 10 Hz, unless the signal is pulsed in which case the average (or video) bandwidth of the measuring instrument is reduced to onset of pulse desensitization and then increased.

### INSTRUMENT CONTROL COMPUTER

The receivers utilize either a Rohde & Schwarz EZM Spectrum Monitor/Controller or contain an internal Spectrum Monitor/Controller to view and convert the receiver measurements to the field strength at an antenna or voltage developed at the LISN measurement port, which is then compared directly with the appropriate specification limit. This provides faster, more accurate readings by performing the conversions described under Sample Calculations within the Test Procedures section of this report. Results are printed in a graphic and/or tabular format, as appropriate. A personal computer is used to record all measurements made with the receivers.

The Spectrum Monitor provides a visual display of the signal being measured. In addition, the controller or a personal computer run automated data collection programs which control the receivers. This provides added accuracy since all site correction factors, such as cable loss and antenna factors are added automatically.

### LINE IMPEDANCE STABILIZATION NETWORK (LISN)

Line conducted measurements utilize a fifty microhenry Line Impedance Stabilization Network as the monitoring point. The LISN used also contains a 250 uH CISPR adapter. This network provides for calibrated radio frequency noise measurements by the design of the internal low pass and high pass filters on the EUT and measurement ports, respectively.

#### *FILTERS/ATTENUATORS*

External filters and precision attenuators are often connected between the receiving antenna or LISN and the receiver. This eliminates saturation effects and non-linear operation due to high amplitude transient events.

#### *ANTENNAS*

A loop antenna is used below 30 MHz. For the measurement range 30 MHz to 1000 MHz either a combination of a biconical antenna and a log periodic or a bi-log antenna is used. Above 1000 MHz, horn antennas are used. The antenna calibration factors to convert the received voltage to an electric field strength are included with appropriate cable loss and amplifier gain factors to determine an overall site factor, which is then programmed into the test receivers or incorporated into the test software.

#### *ANTENNA MAST AND EQUIPMENT TURNTABLE*

The antennas used to measure the radiated electric field strength are mounted on a non-conductive antenna mast equipped with a motor-drive to vary the antenna height. Measurements below 30 MHz are made with the loop antenna at a fixed height of 1m above the ground plane.

ANSI C63.10 specifies that the test height above ground for table mounted devices shall be 80 centimeters. Floor mounted equipment shall be placed on the ground plane if the device is normally used on a conductive floor or separated from the ground plane by insulating material from 3 to 12 mm if the device is normally used on a non-conductive floor as specified in ANSI C63.4. During radiated measurements, the EUT is positioned on a motorized turntable in conformance with this requirement.

#### *INSTRUMENT CALIBRATION*

All test equipment is regularly checked to ensure that performance is maintained in accordance with the manufacturer's specifications. All antennas are calibrated at regular intervals with respect to tuned half-wave dipoles. An exhibit of this report contains the list of test equipment used and calibration information.



## TEST PROCEDURES

### EUT AND CABLE PLACEMENT

The regulations require that interconnecting cables be connected to the available ports of the unit and that the placement of the unit and the attached cables simulate the worst case orientation that can be expected from a typical installation, so far as practicable. To this end, the position of the unit and associated cabling is varied within the guidelines of ANSI C63.10, and the worst-case orientation is used for final measurements.

### CONDUCTED EMISSIONS

Conducted emissions are measured at the plug end of the power cord supplied with the EUT. Excess power cord length is wrapped in a bundle between 30 and 40 centimeters in length near the center of the cord. Preliminary measurements are made to determine the highest amplitude emission relative to the specification limit for all the modes of operation. Placement of system components and varying of cable positions are performed in each mode. A final peak mode scan is then performed in the position and mode for which the highest emission was noted on all current carrying conductors of the power cord.

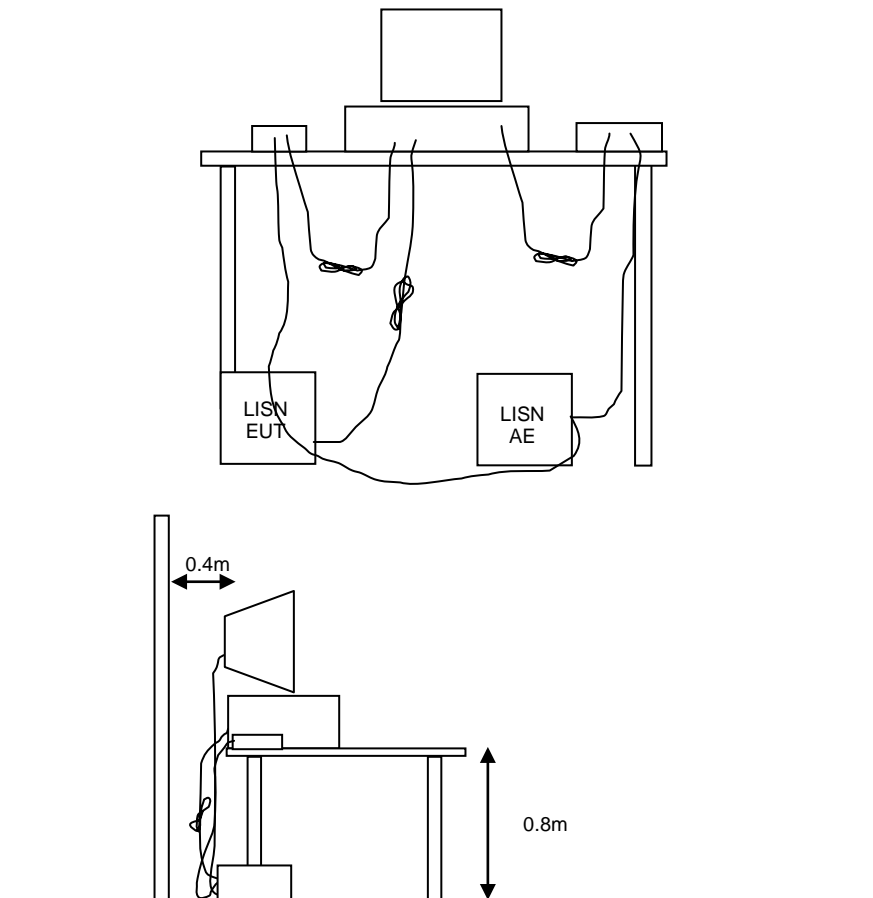

Figure 1 Typical Conducted Emissions Test Configuration

**RADIATED EMISSIONS**

A preliminary scan of the radiated emissions is performed in which all significant EUT frequencies are identified with the system in a nominal configuration. At least two scans are performed, one scan for each antenna polarization (horizontal and vertical; loop parallel and perpendicular to the EUT). During the preliminary scans, the EUT is rotated through 360°, the antenna height is varied (for measurements above 30 MHz) and cable positions are varied to determine the highest emission relative to the limit. Preliminary scans may be performed in a fully anechoic chamber for the purposes of identifying the frequencies of the highest emissions from the EUT.

A speaker is provided in the receiver to aid in discriminating between EUT and ambient emissions. Other methods used during the preliminary scan for EUT emissions involve scanning with near field magnetic loops, monitoring I/O cables with RF current clamps, and cycling power to the EUT.

Final maximization is a phase in which the highest amplitude emissions identified in the spectral search are viewed while the EUT azimuth angle is varied from 0 to 360 degrees relative to the receiving antenna. The azimuth, which results in the highest emission is then maintained while varying the antenna height from one to four meters (for measurements above 30 MHz, measurements below 30 MHz are made with the loop antenna at a fixed height of 1m). The result is the identification of the highest amplitude for each of the highest peaks. Each recorded level is corrected in the receiver using appropriate factors for cables, connectors, antennas, and preamplifier gain.

When testing above 18 GHz, the receive antenna is located at 1meter from the EUT and the antenna height is restricted to a maximum of 2.5 meters.

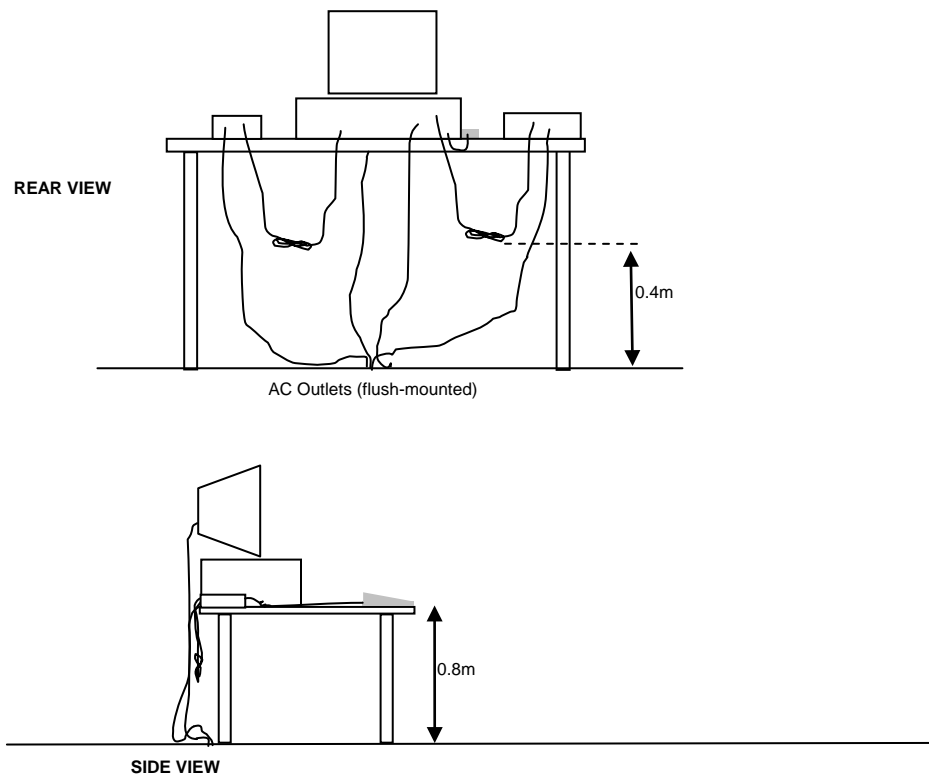

Typical Test Configuration for Radiated Field Strength Measurements

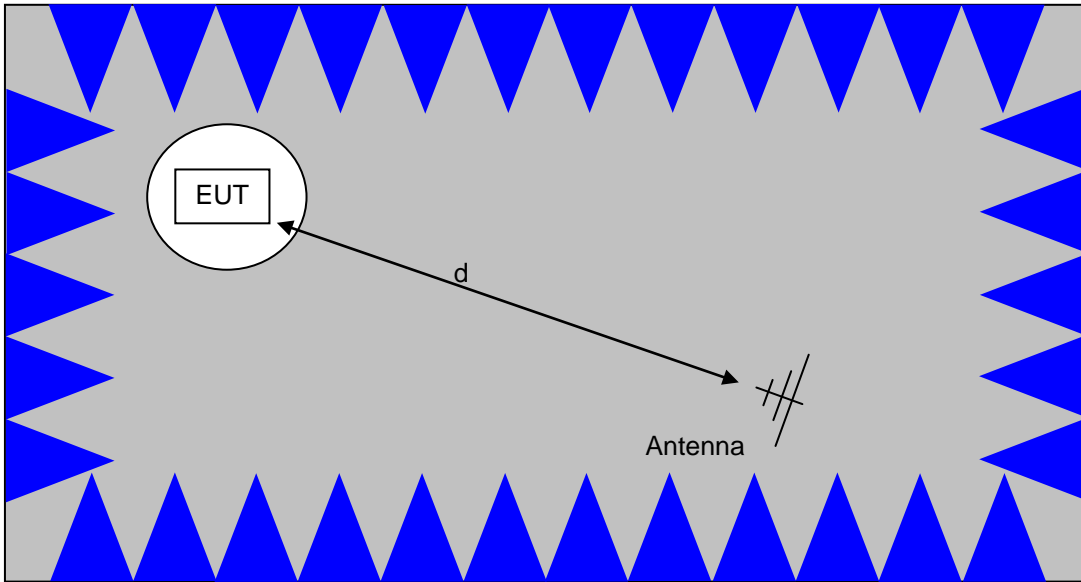

The anechoic materials on the walls and ceiling ensure compliance with the normalized site attenuation requirements of CISPR 16 / CISPR 22 / ANSI C63.4 for an alternate test site at the measurement distances used.

Floor-standing equipment is placed on the floor with insulating supports between the unit and the ground plane.

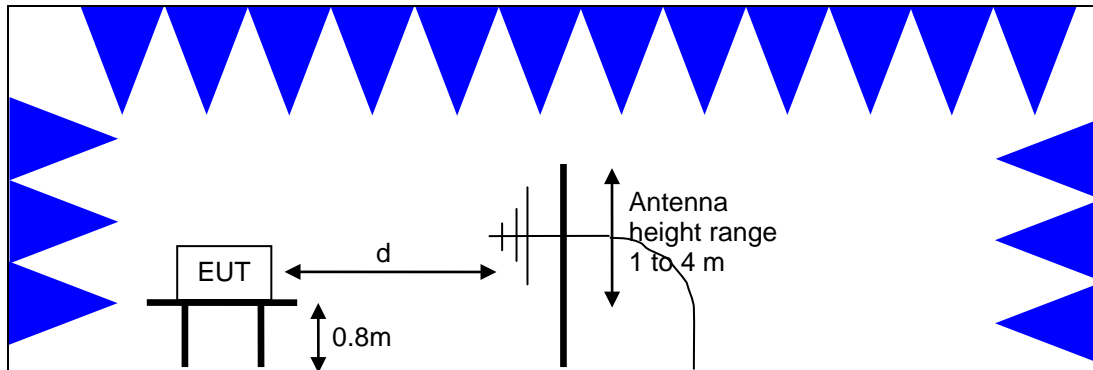

Test Configuration for Radiated Field Strength Measurements  
Semi-Anechoic Chamber, Plan and Side Views

**CONDUCTED EMISSIONS FROM ANTENNA PORT**

Direct measurements of power, bandwidth and power spectral density are performed, where possible, with the antenna port of the EUT connected to either the power meter or spectrum analyzer via a suitable attenuator and/or filter. These are used to ensure that the front end of the measurement instrument is not overloaded by the fundamental transmission.

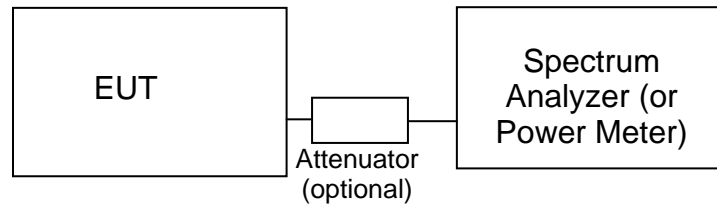
**Test Configuration for Antenna Port Measurements**

Measurement bandwidths (video and resolution) are set in accordance with the relevant standards and NTS Silicon Valley's test procedures for the type of radio being tested. When power measurements are made using a resolution bandwidth less than the signal bandwidth the power is calculated by summing the power across the signal bandwidth using either the analyzer channel power function or by capturing the trace data and calculating the power using software. In both cases the summed power is corrected to account for the equivalent noise bandwidth (ENBW) of the resolution bandwidth used.

If power averaging is used (typically for certain digital modulation techniques), the EUT is configured to transmit continuously. Power averaging is performed using either the built-in function of the analyzer or, if the analyzer does not feature power averaging, using external software. In both cases the average power is calculated over a number of sweeps (typically 100). When the EUT cannot be configured to continuously transmit then either the analyzer is configured to perform a gated sweep to ensure that the power is averaged over periods that the device is transmitting or power averaging is disabled and a max-hold feature is used.

If a power meter is used to make output power measurements the sensor head type (peak or average) is stated in the test data table.

**BANDWIDTH MEASUREMENTS**

The 6dB, 20dB, 26dB and/or 99% signal bandwidth are measured using the bandwidths recommended by ANSI C63.10 and RSS GEN.

**SPECIFICATION LIMITS AND SAMPLE CALCULATIONS**

The limits for conducted emissions are given in units of microvolts, and the limits for radiated emissions are given in units of microvolts per meter at a specified test distance. Data is measured in the logarithmic form of decibels relative to one microvolt, or dB microvolts (dBuV). For radiated emissions, the measured data is converted to the field strength at the antenna in dB microvolts per meter (dBuV/m). The results are then converted to the linear forms of uV and uV/m for comparison to published specifications.

For reference, converting the specification limits from linear to decibel form is accomplished by taking the base ten logarithm, then multiplying by 20. These limits in both linear and logarithmic form are as follows:

**CONDUCTED EMISSIONS SPECIFICATION LIMITS: FCC 15.207; FCC 15.107(a), RSS GEN**

The table below shows the limits for the emissions on the AC power line from an intentional radiator and a receiver.

Frequency (MHz)	Average Limit (dBuV)	Quasi Peak Limit (dBuV)
0.150 to 0.500	Linear decrease on logarithmic frequency axis between 56.0 and 46.0	Linear decrease on logarithmic frequency axis between 66.0 and 56.0
0.500 to 5.000	46.0	56.0
5.000 to 30.000	50.0	60.0

**GENERAL TRANSMITTER RADIATED EMISSIONS SPECIFICATION LIMITS**

The table below shows the limits for the spurious emissions from transmitters that fall in restricted bands<sup>6</sup> (with the exception of transmitters operating under FCC Part 15 Subpart D and RSS 210 Annex 9), the limits for all emissions from a low power device operating under the general rules of RSS 310 (tables 3 and 4), RSS 210 (table 2) and FCC Part 15 Subpart C section 15.209.

Frequency Range (MHz)	Limit (uV/m)	Limit (dBuV/m @ 3m)
0.009-0.490	$2400/F_{\text{KHz}} @ 300\text{m}$	$67.6-20*\log_{10}(F_{\text{KHz}}) @ 300\text{m}$
0.490-1.705	$24000/F_{\text{KHz}} @ 30\text{m}$	$87.6-20*\log_{10}(F_{\text{KHz}}) @ 30\text{m}$
1.705 to 30	30 @ 30m	29.5 @ 30m
30 to 88	100 @ 3m	40 @ 3m
88 to 216	150 @ 3m	43.5 @ 3m
216 to 960	200 @ 3m	46.0 @ 3m
Above 960	500 @ 3m	54.0 @ 3m

**FCC 15.407 (a) OUTPUT POWER LIMITS**

The table below shows the limits for output power and output power density. Where the signal bandwidth is less than 20 MHz the maximum output power is reduced to the power spectral density limit plus 10 times the log of the bandwidth (in MHz).

Operating Frequency (MHz)	Output Power	Power Spectral Density
5150 – 5250 (Client)	250mW (24 dBm)	11 dBm/MHz
5250 – 5350	250 mW (24 dBm)	11 dBm/MHz
5470 – 5725	250 mW (24 dBm)	11 dBm/MHz
5725 – 5850	1 Watts (30 dBm)	30 dBm/500kHz

For system using antennas with gains exceeding 6dBi, the output power and power spectral density limits are reduced by 1dB for every dB the antenna gain exceeds 6dBi. Fixed point-to-point applications using the 5150-5250 and 5725 – 5850 MHz bands may use antennas with gains of up to 23dBi without this limitation. If the gain exceeds 23dBi then the output power limit of 1 Watt is reduced by 1dB for every dB the gain exceeds 23dBi.

<sup>6</sup> The restricted bands are detailed in FCC 15.203, RSS 210 Table 1 and RSS 310 Table 2

**OUTPUT POWER LIMITS –LELAN DEVICES**

The table below shows the limits for output power and output power density defined by RSS 210. Where the signal bandwidth is less than 20 MHz the maximum output power is reduced to the power spectral density limit plus 10 times the log of the bandwidth (in MHz).

Operating Frequency (MHz)	Output Power	Power Spectral Density
5150 – 5250	200mW (23 dBm) eirp	10 dBm/MHz eirp
5250 – 5350	250 mW (24 dBm) <sup>7</sup> 1W (30dBm) eirp	11 dBm/MHz
5470 – 5725	250 mW (24 dBm) <sup>8</sup> 1W (30dBm) eirp	11 dBm/MHz
5725 – 5825	1 Watts (30 dBm) 4W eirp	17 dBm/MHz

In addition, the power spectral density limit shall be reduced by 1dB for every dB the highest power spectral density exceeds the “average” power spectral density ) by more than 3dB. The “average” power spectral density is determined by dividing the output power by  $10\log(\text{EBW})$  where EBW is the 99% power bandwidth.

Fixed point-to-point applications using the 5725 – 5825 MHz band may use antennas with gains of up to 23dBi without this limitation. If the gain exceeds 23dBi then the output power limit of 1 Watt is reduced by 1dB for every dB the gain exceeds 23dBi.

**SPURIOUS EMISSIONS LIMITS –UNII and LELAN DEVICES**

The spurious emissions limits for signals below 1GHz are the FCC/RSS-GEN general limits. For emissions above 1GHz, signals in restricted bands are subject to the FCC/RSS GEN general limits. All other signals have a limit of  $-27\text{dBm/MHz}$ , which is a field strength of  $68.3\text{dBuV/m/MHz}$  at a distance of 3m. For devices operating in the 5725-5850Mhz bands under the LELAN/UNII rules, the limit within 10MHz of the allocated band is increased to  $-17\text{dBm/MHz}$ .

**SAMPLE CALCULATIONS - CONDUCTED EMISSIONS**

Receiver readings are compared directly to the conducted emissions specification limit (decibel form) as follows:

$$R_r - S = M$$

where:

$R_r$  = Receiver Reading in dBuV

$S$  = Specification Limit in dBuV

$M$  = Margin to Specification in +/- dB

<sup>7</sup> If EIRP exceeds 500mW the device must employ TPC

<sup>8</sup> If EIRP exceeds 500mW the device must employ TPC

**SAMPLE CALCULATIONS - RADIATED EMISSIONS**

Receiver readings are compared directly to the specification limit (decibel form). The receiver internally corrects for cable loss, preamplifier gain, and antenna factor. The calculations are in the reverse direction of the actual signal flow, thus cable loss is added and the amplifier gain is subtracted. The Antenna Factor converts the voltage at the antenna coaxial connector to the field strength at the antenna elements.

A distance factor, when used for electric field measurements above 30MHz, is calculated by using the following formula:

$$F_d = 20 * \text{LOG}_{10} (D_m/D_s)$$

where:

$$F_d = \text{Distance Factor in dB}$$

$$D_m = \text{Measurement Distance in meters}$$

$$D_s = \text{Specification Distance in meters}$$

For electric field measurements below 30MHz the extrapolation factor is either determined by making measurements at multiple distances or a theoretical value is calculated using the formula:

$$F_d = 40 * \text{LOG}_{10} (D_m/D_s)$$

Measurement Distance is the distance at which the measurements were taken and Specification Distance is the distance at which the specification limits are based. The antenna factor converts the voltage at the antenna coaxial connector to the field strength at the antenna elements.

The margin of a given emission peak relative to the limit is calculated as follows:

$$R_c = R_r + F_d$$

and

$$M = R_c - L_s$$

where:

$$R_r = \text{Receiver Reading in dBuV/m}$$

$$F_d = \text{Distance Factor in dB}$$

$$R_c = \text{Corrected Reading in dBuV/m}$$

$$L_s = \text{Specification Limit in dBuV/m}$$

$$M = \text{Margin in dB Relative to Spec}$$



**SAMPLE CALCULATIONS - FIELD STRENGTH TO EIRP CONVERSION**

Where the radiated electric field strength is expressed in terms of the equivalent isotropic radiated power (eirp), or where a field strength measurement of output power is made in lieu of a direct measurement, the following formula is used to convert between eirp and field strength at a distance of d (meters) from the equipment under test:

$$E = \frac{1000000 \sqrt{30 P}}{d} \quad \text{microvolts per meter}$$

where P is the eirp (Watts)

For a measurement at 3m the conversion from a logarithmic value for field strength (dBuV/m) to an eirp power (dBm) is -95.3dB.

**Appendix A Test Equipment Calibration Data****Radio Antenna Port (Power and Spurious Emissions), 05-Jun-14**

<u>Manufacturer</u>	<u>Description</u>	<u>Model</u>	<u>Asset #</u>	<u>Cal Due</u>
Rohde & Schwarz	EMI Test Receiver, 20 Hz-7 GHz	ESIB7	1538	12/14/2014

**Radiated Emissions, Band edge, 05-Jun-14**

<u>Manufacturer</u>	<u>Description</u>	<u>Model</u>	<u>Asset #</u>	<u>Cal Due</u>
EMCO	Antenna, Horn, 1-18GHz	3115	868	6/19/2014
Rohde & Schwarz	EMI Test Receiver, 20 Hz-7 GHz	ESIB7	1630	6/22/2014

**Radiated Emissions, Band edge measurement, 06-Jun-14**

<u>Manufacturer</u>	<u>Description</u>	<u>Model</u>	<u>Asset #</u>	<u>Cal Due</u>
EMCO	Antenna, Horn, 1-18 GHz	3115	487	7/19/2014
Rohde & Schwarz	EMI Test Receiver, 20 Hz-7 GHz	ESIB7	1756	6/8/2014

**Radiated Emissions (Band Edge), 1,000 - 6,500 MHz, 10-Jun-14**

<u>Manufacturer</u>	<u>Description</u>	<u>Model</u>	<u>Asset #</u>	<u>Cal Due</u>
EMCO	Antenna, Horn, 1-18 GHz	3115	487	7/19/2014
Rohde & Schwarz	EMI Test Receiver, 20 Hz-40 GHz	ESIB40 (1088.7490.40)	2493	1/11/2015

**Radiated Emissions, 1,000 - 6,500 MHz, 11-Jun-14**

<u>Manufacturer</u>	<u>Description</u>	<u>Model</u>	<u>Asset #</u>	<u>Cal Due</u>
EMCO	Antenna, Horn, 1-18 GHz	3115	487	7/19/2014
Rohde & Schwarz	EMI Test Receiver, 20 Hz-40 GHz	ESIB40 (1088.7490.40)	2493	1/11/2015

**Radiated Emissions, 1,000 - 6,500 MHz, 12-Jun-14**

<u>Manufacturer</u>	<u>Description</u>	<u>Model</u>	<u>Asset #</u>	<u>Cal Due</u>
EMCO	Antenna, Horn, 1-18 GHz	3115	487	7/19/2014
Rohde & Schwarz	EMI Test Receiver, 20 Hz-40 GHz	ESIB40 (1088.7490.40)	2493	1/11/2015

**Radiated Emissions, 1,000 - 12,000 MHz, 13-Jun-14**

<u>Manufacturer</u>	<u>Description</u>	<u>Model</u>	<u>Asset #</u>	<u>Cal Due</u>
EMCO	Antenna, Horn, 1-18 GHz	3115	487	7/19/2014
Hewlett Packard	Microwave Preamplifier, 1-26.5GHz	8449B	2199	2/20/2015
Micro-Tronics	Band Reject Filter, 5725-5875 MHz	BRC50705-02	2241	9/18/2014
Hewlett Packard	SpecAn 9 kHz - 40 GHz, (SA40) Purple	8564E (84125C)	2415	2/27/2015

**Radiated Emissions, 12,000 - 40,000 MHz, 13-Jun-14**

<u>Manufacturer</u>	<u>Description</u>	<u>Model</u>	<u>Asset #</u>	<u>Cal Due</u>
Hewlett Packard	High Pass filter, 8.2 GHz (Purple System)	P/N 84300-80039	1767	11/26/2014
EMCO	Antenna, Horn, 1-18 GHz	3115	487	7/19/2014
Hewlett Packard	Microwave Preamplifier, 1-26.5GHz	8449B	2199	2/20/2015
Micro-Tronics	Band Reject Filter, 5725-5875 MHz	BRC50705-02	2241	9/18/2014
Hewlett Packard	SpecAn 9 kHz - 40 GHz, (SA40) Purple	8564E (84125C)	2415	2/27/2015
Hewlett Packard	Head (Inc W1-W4, 1946 , 1947) Purple	84125C	1772	4/25/2015
A. H. Systems	Blue System Horn, 18-40GHz	SAS-574, p/n: 2581	2159	8/8/2014

**Radiated Emissions, 1000 - 12,000 MHz, 15-Jun-14**

<u>Manufacturer</u>	<u>Description</u>	<u>Model</u>	<u>Asset #</u>	<u>Cal Due</u>
EMCO	Antenna, Horn, 1-18 GHz	3115	487	7/19/2014
Micro-Tronics	Band Reject Filter, 5470-5725 MHz	BRC50704-02	1681	8/20/2014
Hewlett Packard	Microwave Preamplifier, 1-26.5GHz	8449B	2199	2/20/2015
Micro-Tronics	Band Reject Filter, 5150-5350 MHz	BRC50703-02	2239	9/18/2014
Hewlett Packard	SpecAn 9 kHz - 40 GHz, (SA40) Purple	8564E (84125C)	2415	2/27/2015

**Radiated Emissions, 12,000 - 18,000 MHz, 16-Jun-14**

<u>Manufacturer</u>	<u>Description</u>	<u>Model</u>	<u>Asset #</u>	<u>Cal Due</u>
Hewlett Packard	High Pass filter, 8.2 GHz (Purple System)	P/N 84300-80039	1767	11/26/2014
EMCO	Antenna, Horn, 1-18 GHz	3115	487	7/19/2014
Hewlett Packard	Microwave Preamplifier, 1-26.5GHz	8449B	2199	2/20/2015
Hewlett Packard	SpecAn 9 kHz - 40 GHz, (SA40) Purple	8564E (84125C)	2415	2/27/2015

**Radiated Emissions, 30 - 1,000 MHz, 17-Jun-14**

<u>Manufacturer</u>	<u>Description</u>	<u>Model</u>	<u>Asset #</u>	<u>Cal Due</u>
Sunol Sciences	Biconilog, 30-3000 MHz	JB3	1548	8/9/2014
Rohde & Schwarz	EMI Test Receiver, 20 Hz-7 GHz	ESIB7	1630	6/22/2014
Micro-Tronics	Band Reject Filter, 5470-5725 MHz	BRC50704-02	1730	8/2/2014
Micro-Tronics	Band Reject Filter, 2400-2500 MHz	BRM50702-02	2238	9/18/2014
Com-Power	Preamplifier, 1-1000 MHz	PAM-103	2885	11/1/2014

**Radiated Emissions, 1000 - 40,000 MHz, 17-Jun-14**

<u>Manufacturer</u>	<u>Description</u>	<u>Model</u>	<u>Asset #</u>	<u>Cal Due</u>
EMCO	Antenna, Horn, 1-18 GHz	3115	487	7/19/2014
Micro-Tronics	Band Reject Filter, 5470-5725 MHz	BRC50704-02	1681	8/20/2014
Hewlett Packard	Head (Inc W1-W4, 1946 , 1947) Purple	84125C	1772	4/25/2015
A. H. Systems	Blue System Horn, 18-40GHz	SAS-574, p/n: 2581	2159	8/8/2014
Hewlett Packard	Microwave Preamplifier, 1-26.5GHz	8449B	2199	2/20/2015
Micro-Tronics	Band Reject Filter, 5150-5350 MHz	BRC50703-02	2239	9/18/2014
Hewlett Packard	SpecAn 9 kHz - 40 GHz, (SA40) Purple	8564E (84125C)	2415	2/27/2015
Hewlett Packard	High Pass filter, 8.2 GHz (Purple System)	P/N 84300-80039	1767	11/26/2014

**Radiated Emissions, 1,000- 15,000 MHz, 18-Jun-14**

<u>Manufacturer</u>	<u>Description</u>	<u>Model</u>	<u>Asset #</u>	<u>Cal Due</u>
EMCO	Antenna, Horn, 1-18 GHz	3115	487	7/19/2014
Rohde & Schwarz	EMI Test Receiver, 20 Hz-7 GHz	ESIB7	1630	6/22/2014
Micro-Tronics	Band Reject Filter, 5470-5725 MHz	BRC50704-02	1681	8/20/2014
Micro-Tronics	Band Reject Filter, 5725-5875 MHz	BRC50705-02	1682	3/13/2015
Hewlett Packard	High Pass filter, 8.2 GHz (Purple System)	P/N 84300-80039	1767	11/26/2014
Hewlett Packard	Microwave Preamplifier, 1-26.5GHz	8449B	2199	2/20/2015
Micro-Tronics	Band Reject Filter, 2400-2500 MHz	BRM50702-02	2238	9/18/2014
Micro-Tronics	Band Reject Filter, 5150-5350 MHz	BRC50703-02	2239	9/18/2014
Hewlett Packard	SpecAn 9 kHz - 40 GHz, (SA40) Purple	8564E (84125C)	2415	2/27/2015

**Radiated Emissions, 1,000- 15,000 MHz, 19-Jun-14**

<u>Manufacturer</u>	<u>Description</u>	<u>Model</u>	<u>Asset #</u>	<u>Cal Due</u>
EMCO	Antenna, Horn, 1-18 GHz	3115	487	7/19/2014
Rohde & Schwarz	EMI Test Receiver, 20 Hz-7 GHz	ESIB7	1630	6/22/2014
Micro-Tronics	Band Reject Filter, 5470-5725 MHz	BRC50704-02	1681	8/20/2014
Micro-Tronics	Band Reject Filter, 5725-5875 MHz	BRC50705-02	1682	3/13/2015
Hewlett Packard	High Pass filter, 8.2 GHz (Purple System)	P/N 84300-80039	1767	11/26/2014
Hewlett Packard	Microwave Preamplifier, 1-26.5GHz	8449B	2199	2/20/2015
Micro-Tronics	Band Reject Filter, 2400-2500 MHz	BRM50702-02	2238	9/18/2014
Micro-Tronics	Band Reject Filter, 5150-5350 MHz	BRC50703-02	2239	9/18/2014
Hewlett Packard	SpecAn 9 kHz - 40 GHz, (SA40) Purple	8564E (84125C)	2415	2/27/2015

**Conducted Emissions - AC Power Ports, 20-Jun-14**

<u>Manufacturer</u>	<u>Description</u>	<u>Model</u>	<u>Asset #</u>	<u>Cal Due</u>
EMCO	LISN, 10 kHz-100 MHz	3825/2	1293	2/13/2015
Rohde & Schwarz	Pulse Limiter	ESH3 Z2	1401	5/15/2015
Rohde & Schwarz	EMI Test Receiver, 20 Hz-7 GHz	ESIB7	1630	6/22/2014

**Radio Antenna Port (Power and Spurious Emissions), 20-Jun-14**

<u>Manufacturer</u>	<u>Description</u>	<u>Model</u>	<u>Asset #</u>	<u>Cal Due</u>
Agilent Technologies	3Hz -44GHz PSA Spectrum Analyzer	E4446A	2796	2/6/2015

**Radio Antenna Port (Power and Spurious Emissions), 01-Jul-14**

<u>Manufacturer</u>	<u>Description</u>	<u>Model</u>	<u>Asset #</u>	<u>Cal Due</u>
Agilent Technologies	PSA, Spectrum Analyzer, (installed options, 111, 115, 123, 1DS, B7J, HYX,	E4446A	2139	4/8/2015

**Radiated Emissions, 1,000 - 40,000 MHz, 08-Jul-14**

<b><u>Manufacturer</u></b>	<b><u>Description</u></b>	<b><u>Model</u></b>	<b><u>Asset #</u></b>	<b><u>Cal Due</u></b>
Hewlett Packard	SpecAn 9 kHz - 40 GHz, FT (SA40) Blue	8564E (84125C)	1393	5/6/2015
Hewlett Packard	Head (Inc flex cable, (1742,1743) Blue)	84125C	1620	5/6/2015
Hewlett Packard	Microwave Preamplifier, 1-26.5GHz	8449B	1780	11/26/2014
A. H. Systems	Purple System Horn, 18-40GHz	SAS-574, p/n: 2581	2160	7/28/2014
EMCO	Antenna, Horn, 1-18 GHz	3115	2870	8/20/2015

## Appendix B Test Data

T95472 Pages 31 - 283



# EMC Test Data

Client:	Intel Corporation	Job Number:	J94914
Product:	7265D2W	T-Log Number:	T95472
		Project Manager:	Christine Krebill
Contact:	Steve Hackett	Project Coordinator:	-
Emissions Standard(s):	FCC Part 15.247, 15.407, RSS-210	Class:	B
Immunity Standard(s):	-	Environment:	Radio

## EMC Test Data

For The

## Intel Corporation

Product

7265D2W

Date of Last Test: 7/8/2014



# EMC Test Data

Client:	Intel Corporation	Job Number:	J94914
Model:	7265D2W	T-Log Number:	T95472
		Project Manager:	Christine Krebill
Contact:	Steve Hackett	Project Coordinator:	-
Standard:	FCC Part 15.247, 15.407, RSS-210	Class:	N/A

## Power vs. Data Rate

In normal operating modes the card uses power settings stored on EEPROM to set the output power. For a given nominal output power the actual transmit power normally is reduced as the data rate increases, therefore testing was performed at the data rate in the mode with highest power to determine compliance with the requirements.

The following power measurements were made using a UNII software with RW = 1MHz VB = 3MHz RMS detector and with the device configured in a continuous transmit mode on Chain 1 at the various data rates in each mode to verify the highest power mode:

### Sample Notes

MAC Address: 001500F15B5D DRTU Tool Version 1.7.3-935 Driver version 17.1.0.11

Date of Test: 6/5/2014  
 Test Engineer: M. Birgani

Test Location: Chamber #7

## Duty Cycle

Duty cycle measurements performed on the worse case data rate for power.

Notes: Measurements taken with maximum RBW/VBW settings allowed.

Mode	Data Rate	Duty Cycle (x)	Constant DC?	T (ms)	Pwr Cor Factor*	Lin Volt Cor Factor**	Min VBW for FS (Hz)
11a	6.0Mbps	99%	Constant	2.06	0.0	0.0	485
n20	6.5Mbps	98%	Constant	1.92	0.0	0.0	521
n40	13.5Mbps	97%	Constant	0.94	0.1	0.3	1064
ac80	29.3Mbps	94%	Constant	0.44	0.3	0.6	2273

\* Correction factor when using RMS/Power averaging -  $10 \cdot \log(1/x)$

\*\* Correction factor when using linear voltage average -  $20 \cdot \log(1/x)$

T = Minimum transmission duration



Client: Intel Corporation	Job Number: J94914
Model: 7265D2W	T-Log Number: T95472
Contact: Steve Hackett	Project Manager: Christine Krebill
Standard: FCC Part 15.247, 15.407, RSS-210	Project Coordinator: -
	Class: N/A

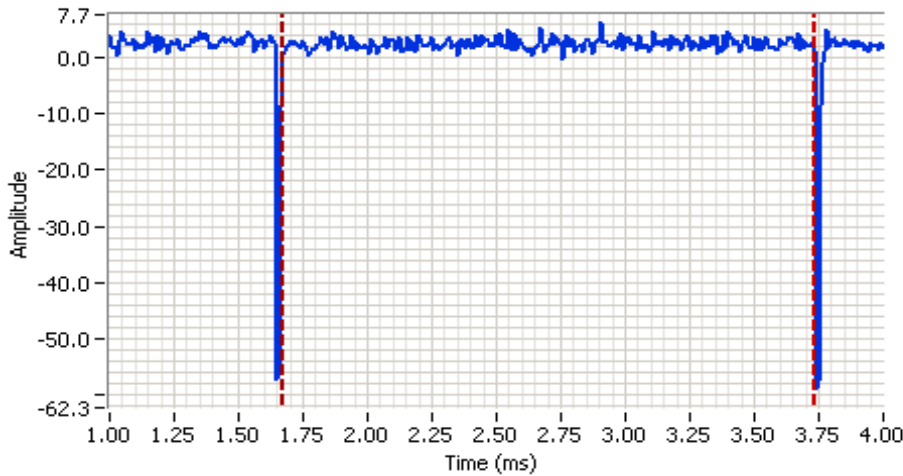

**Analyzer Settings**  
 Rohde&Schwarz,ESI  
 CF: 5180.000 MHz  
 SPAN: 0.000 MHz  
 RB: 1.000 MHz  
 VB: 1.000 MHz  
 Detector: POS  
 Attn: 20 DB  
 RL Offset: 10.0 DB  
 Sweep Time: 4.0ms  
 Ref Lvl: 18.0 DBM

**Comments**  
 802.11a 6Mbps  
 Off time: 0.03ms  
 On time: 2.06ms  
 Duty cycle: 98.6%

Cursor 1 3.7370 10.00 Delta Time (ms) 2.06

Cursor 2 1.6745 10.00 Delta Amplitude 0.00

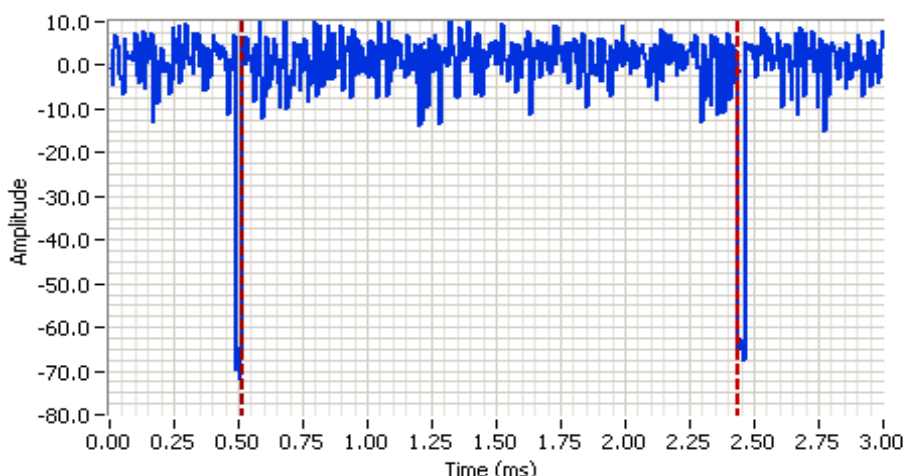

**Analyzer Settings**  
 Rohde&Schwarz,ESI  
 CF: 5180.000 MHz  
 SPAN: 0.000 MHz  
 RB: 10.000 MHz  
 VB: 10.000 MHz  
 Detector: SAMPLE  
 Attn: 20 DB  
 RL Offset: 0.0 DB  
 Sweep Time: 3.0ms  
 Ref Lvl: 9.0 DBM

**Comments**  
 802.11n 20MHz 6.5Mbps  
 Off time: 0.03ms  
 On time: 1.92ms  
 Duty cycle: 98.5%

Cursor 1 2.4359 25.00 Delta Time (ms) 1.92

Cursor 2 0.5172 25.00 Delta Amplitude 0.00



Client: Intel Corporation	Job Number: J94914
Model: 7265D2W	T-Log Number: T95472
Contact: Steve Hackett	Project Manager: Christine Krebill
Standard: FCC Part 15.247, 15.407, RSS-210	Project Coordinator: -
	Class: N/A

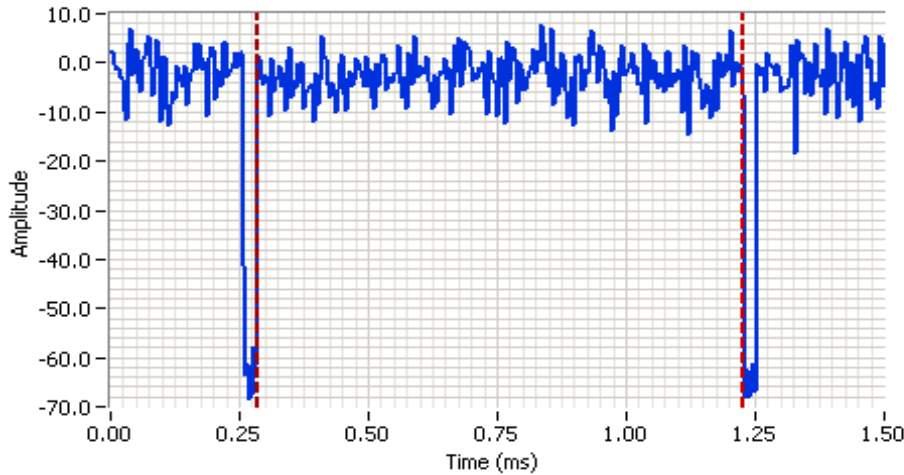

**Analyzer Settings**  
 Rohde&Schwarz,ESI  
 CF: 5190.000 MHz  
 SPAN: 0.000 MHz  
 RB: 10.000 MHz  
 VB: 10.000 MHz  
 Detector: SAMPLE  
 Attn: 20 DB  
 RL Offset: 0.0 DB  
 Sweep Time: 2.0ms  
 Ref Lvl: 9.0 DBM

**Comments**  
 802.11n 40MHz 13.5Mbps  
 Off time: 0.03ms  
 On time: 0.94ms  
 Duty cycle: 96.9%

Cursor 1 1.2268 15.00 Delta Time (ms) 0.94  
 Cursor 2 0.2844 15.00 Delta Amplitude 0.00

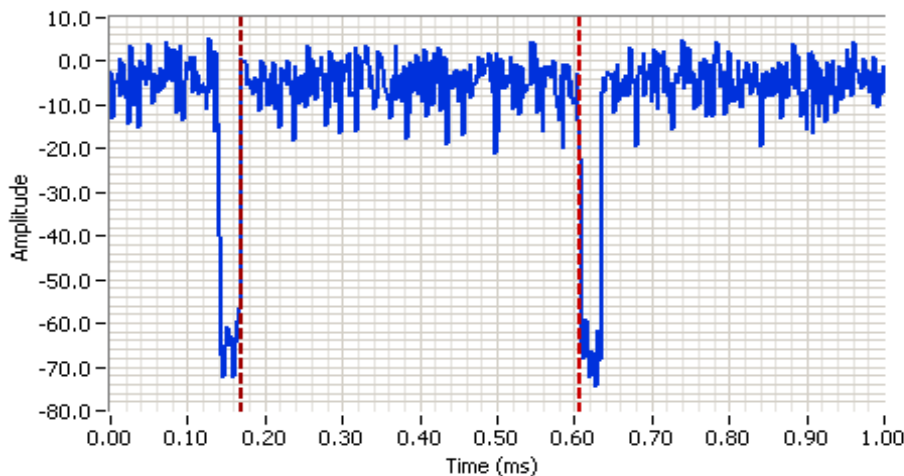

**Analyzer Settings**  
 Rohde&Schwarz,ESI  
 CF: 5210.000 MHz  
 SPAN: 0.000 MHz  
 RB: 10.000 MHz  
 VB: 10.000 MHz  
 Detector: SAMPLE  
 Attn: 20 DB  
 RL Offset: 0.0 DB  
 Sweep Time: 1.0ms  
 Ref Lvl: 9.0 DBM

**Comments**  
 802.11ac 80MHz 29.3Mbps  
 Off time: 0.03ms  
 On time: 0.44ms  
 Duty cycle: 93.6%

Cursor 1 0.6055 15.00 Delta Time (ms) 0.44  
 Cursor 2 0.1682 15.00 Delta Amplitude 0.00





# EMC Test Data

Client: Intel Corporation	Job Number: J94914
Model: 7265D2W	T-Log Number: T95472
	Project Manager: Christine Krebill
Contact: Steve Hackett	Project Coordinator: -
Standard: FCC Part 15.247, 15.407, RSS-210	Class: N/A

Mode	Data Rate	Power (dBm)	Power setting
802.11a	6	<b>9.7</b>	19.0
	9	9.6	
	12	9.6	
	18	9.6	
	24	9.5	
	36	9.5	
	48	9.4	
	54	9.4	
<<-11ac mode only			
802.11n 20MHz	6.5	<b>14.9</b>	25.0
	13	14.9	
	19.5	14.9	
	26	14.7	
	39	14.7	
	52	14.6	
	58.5	14.6	
	65	14.5	
	78	14.5	
<<-11ac mode only			
802.11n/ac 40MHz	13.5	<b>14.9</b>	25.0
	27	14.8	
	40.5	14.8	
	54	14.5	
	81	14.4	
	108	14.3	
	121.5	14.3	
	135	14.2	
	162	14.2	
180	14.1		
<<-11ac mode only <<-11ac mode only			
802.11ac 80MHz	29.3	<b>15.7</b>	25.0
	58.5	15.5	
	87.8	15.4	
	117	15.3	
	175.5	15.2	
	234	15.1	
	266.3	15.0	
	292.5	15.0	
	351	14.9	
390	14.9		

Note : Power setting - the software power setting used during testing, included for reference only.



# EMC Test Data

Client: Intel Corporation	Job Number: J94914
Model: 7265D2W	T-Log Number: T95472
	Project Manager: Christine Krebill
Contact: Steve Hackett	Project Coordinator: -
Standard: FCC Part 15.247, 15.407, RSS-210	Class: N/A

## RSS-210 (LELAN) and FCC 15.407(UNII) Antenna Port Measurements Power, PSD, Peak Excursion, Bandwidth and Spurious Emissions

### Test Specific Details

Objective: The objective of this test session is to perform final qualification testing of the EUT with respect to the specification listed above.

### Summary of Results

Run #	Test Performed	Limit	Pass / Fail	Result / Margin
1	Power, 5150 - 5250MHz	15.407(a) (1)	Pass	a: 40.7 mW n20: 45.7 mW n40: 50.0 mW ac80: 26.9 mW
1	PSD, 5150 - 5250MHz	15.407(a) (1)	Pass	a: 3.9 dBm/MHz n20: 4.3 dBm/MHz n40: 1.3 dBm/MHz ac80: -4.3 dBm/MHz
1	Power, 5250 - 5350MHz	15.407(a) (2)	Pass	a: 51.3 mW n20: 47.9 mW n40: 46.8 mW ac80: 24.0 mW
1	PSD, 5250 - 5350MHz	15.407(a) (2)	Pass	a: 4.8 dBm/MHz n20: 4.6 dBm/MHz n40: 1.2 dBm/MHz ac80: -4.8 dBm/MHz
1	Max EIRP 5250 - 5350MHz	TPC required if EIRP ≥ 500mW (27dBm). EIRP ≥ 200mW (23dBm) DFS threshold = -64dBm.	Pass	EIRP = 20.8 dBm (119.0 mW)



# EMC Test Data

Client:	Intel Corporation	Job Number:	J94914
Model:	7265D2W	T-Log Number:	T95472
Contact:	Steve Hackett	Project Manager:	Christine Krebill
Standard:	FCC Part 15.247, 15.407, RSS-210	Project Coordinator:	-
		Class:	N/A

Run #	Test Performed	Limit	Pass / Fail	Result / Margin
1	Power, 5470 - 5725MHz	15.407(a) (2)	Pass	a: 46.8 mW n20: 49.0 mW n40: 50 mW ac80: 50 mW
1	PSD, 5470 - 5725MHz	15.407(a) (2)	Pass	a: 4.4 dBm/MHz n20: 4.7 dBm/MHz n40: 1.4 dBm/MHz ac80: -1.6 dBm/MHz
1	Max EIRP 5470 - 5725MHz	TPC required if EIRP ≥ 500mW (27dBm). EIRP ≥ 200mW (23dBm) DFS threshold	Pass	EIRP = 21.8 dBm (151.8 mW)
1	Power, 5725 - 5850MHz	15.407(a) (3)	Pass	a: 50 mW n20: 50 mW n40: 50 mW ac80: 17.8 mW
1	PSD, 5725 - 5850MHz	15.407(a) (3)	Pass	a: 5.1 dBm/MHz n20: 4.7 dBm/MHz n40: 1.5 dBm/MHz ac80: -6.0 dBm/MHz
1	26dB Bandwidth	15.407 (Information only)	-	> 20MHz for all modes
1	99% Bandwidth	RSS 210 (Information only)	N/A	a: 19.7 MHz n20: 18.7 MHz n40: 41.3 MHz ac80: 75.6 MHz
2	Antenna Conducted - Out of Band Spurious	15.407(b) -27dBm/MHz		Not performed conducted, Refer to Radiated Spurious Emissions data

## General Test Configuration

When measuring the conducted emissions from the EUT's antenna port, the antenna port of the EUT was connected to the spectrum analyzer or power meter via a suitable attenuator to prevent overloading the measurement system. All measurements are corrected to allow for the external attenuators and cables used.

## Ambient Conditions:

Temperature: 21.8 °C  
Rel. Humidity: 37 %



# EMC Test Data

Client: Intel Corporation	Job Number: J94914
Model: 7265D2W	T-Log Number: T95472
	Project Manager: Christine Krebill
Contact: Steve Hackett	Project Coordinator: -
Standard: FCC Part 15.247, 15.407, RSS-210	Class: N/A

### Modifications Made During Testing

No modifications were made to the EUT during testing

### Deviations From The Standard

No deviations were made from the requirements of the standard.

### Procedure Comments:

Measurements performed in accordance with FCC KDB 789033 D02 v01, dated June 6, 2014

Mode	Data Rate	Duty Cycle (x)	Constant DC?	T (ms)	Pwr Cor Factor*	Lin Volt Cor Factor**	Min VBW for FS (Hz)
11a	6.0Mbps	99%	Constant	2.06	0.0	0.0	485
n20	6.5Mbps	98%	Constant	1.92	0.0	0.0	521
n40	13.5Mbps	97%	Constant	0.94	0.1	0.3	1064
ac80	29.3Mbps	94%	Constant	0.44	0.3	0.6	2273

### Sample Notes

MAC Address: 001500F15B5D DRTU Tool Version 1.7.3-935 Driver version 17.1.0.11





# EMC Test Data

Client:	Intel Corporation	Job Number:	J94914
Model:	7265D2W	T-Log Number:	T95472
Contact:	Steve Hackett	Project Manager:	Christine Krebill
Standard:	FCC Part 15.247, 15.407, RSS-210	Project Coordinator:	-
		Class:	N/A

## SISO Device - 5150-5250 MHz Band - FCC

Antenna Gain (dBi): 3.6      Max EIRP: 114.1 mW      20.6 dBm

Frequency (MHz)	Software Setting	26dB BW (MHz)	Duty Cycle %	Output Power <sup>1</sup> dBm			PSD <sup>2</sup> dBm/MHz			Result
				Measured	Calculated	Limit	Measured	Calculated	Limit	
<b>802.11a</b>										
5180	22.5	27.8	99.0	14.4	14.5	24.0	2.4	2.4	11.0	Pass
5200	24.5	43.4	99.0	16.1	16.1	24.0	3.9	3.9	11.0	Pass
5240	24.5	41.3	99.0	16.1	16.1	24.0	3.9	3.9	11.0	Pass
<b>802.11n 20MHz</b>										
5180	22.5	31.3	98.0	14.6	14.7	24.0	2.3	2.4	11.0	Pass
5200	25.0	45.4	98.0	16.5	16.6	24.0	4.2	4.3	11.0	Pass
5240	25.0	44.8	98.0	16.4	16.5	24.0	4.3	4.3	11.0	Pass
<b>802.11n 40MHz</b>										
5190	20.5	51.2	97.0	12.4	12.6	24.0	-3.3	-3.1	11.0	Pass
5230	25.5	87.2	97.0	16.8	17.0	24.0	1.1	1.3	11.0	Pass
<b>802.11ac 80MHz</b>										
5210	19.5	81.0	94.0	14.0	14.3	24.0	-4.6	-4.3	11.0	Pass

## SISO Device - 5150-5250 MHz Band - Industry Canada

Antenna Gain (dBi): 3.6      Max EIRP: 114.1 mW      20.6 dBm

Frequency (MHz)	Software Setting	99% BW (MHz)	Duty Cycle %	Output Power <sup>1</sup> dBm			PSD <sup>2</sup> dBm/MHz			Result
				Measured	Calculated	Limit	Measured	Calculated	Limit <sup>3</sup>	
<b>802.11a</b>										
5180	22.5	16.9	99.0	14.4	14.5	16.3	2.4	2.4	6.4	Pass
5200	24.5	16.9	99.0	16.1	16.1	16.3	3.9	3.9	6.4	Pass
5240	24.5	17.5	99.0	16.1	16.1	16.4	3.9	3.9	6.4	Pass
<b>802.11n 20MHz</b>										
5180	22.5	18.1	98.0	14.6	14.7	16.6	2.3	2.4	6.4	Pass
5200	25.0	18.6	98.0	16.5	16.6	16.7	4.2	4.3	6.4	Pass
5240	25.0	18.5	98.0	16.4	16.5	16.7	4.3	4.3	6.4	Pass
<b>802.11n 40MHz</b>										
5190	20.5	36.4	97.0	12.4	12.6	17.0	-3.3	-3.1	6.4	Pass
5230	25.5	37.1	97.0	16.8	17.0	17.0	1.1	1.3	6.4	Pass
<b>802.11ac 80MHz</b>										
5210	19.5	75.6	94.0	14.0	14.3	17.0	-4.6	-4.3	6.4	Pass



Client: Intel Corporation	Job Number: J94914
Model: 7265D2W	T-Log Number: T95472
	Project Manager: Christine Krebill
Contact: Steve Hackett	Project Coordinator: -
Standard: FCC Part 15.247, 15.407, RSS-210	Class: N/A

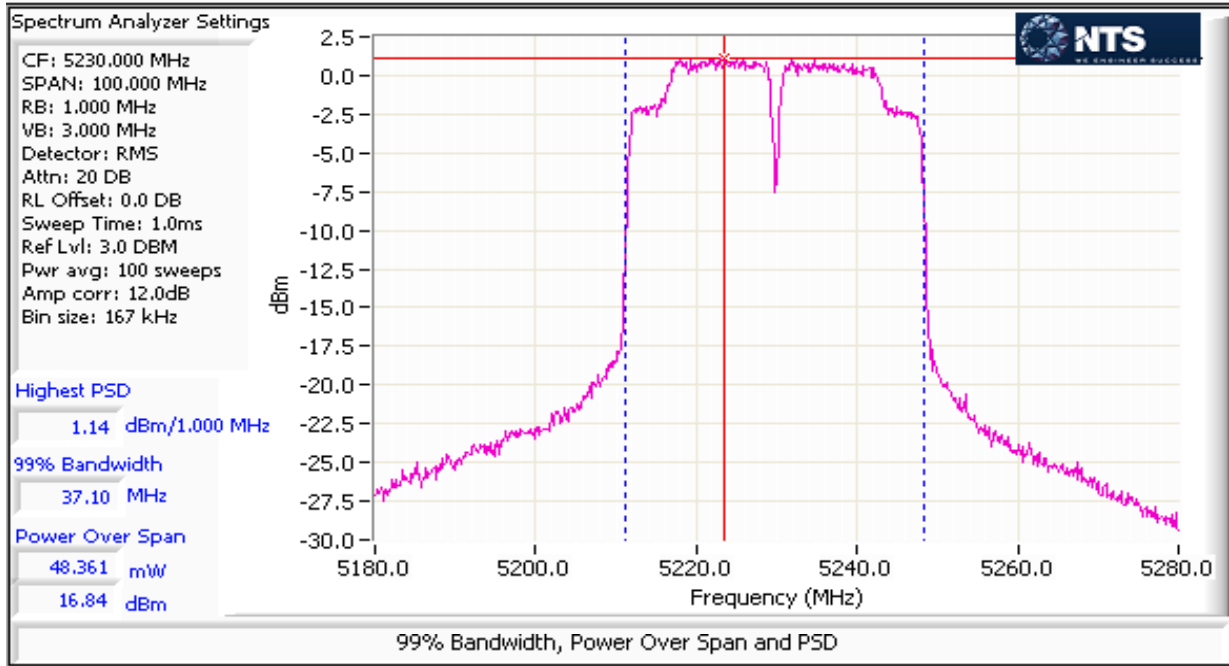



# EMC Test Data

Client:	Intel Corporation	Job Number:	J94914
Model:	7265D2W	T-Log Number:	T95472
Contact:	Steve Hackett	Project Manager:	Christine Krebill
Standard:	FCC Part 15.247, 15.407, RSS-210	Project Coordinator:	-
		Class:	N/A

## SISO Device - 5250-5350 MHz Band - FCC

Antenna Gain (dBi): 3.7 Max EIRP: 119.0 mW 20.8 dBm

Frequency (MHz)	Software Setting	26dB BW (MHz)	Duty Cycle %	Output Power <sup>1</sup> dBm			PSD <sup>2</sup> dBm/MHz			Result
				Measured	Calculated	Limit	Measured	Calculated	Limit	
<b>802.11a</b>										
5260	25.0	39.8	99.0	16.6	16.6	24.0	4.5	4.5	11.0	Pass
5300	26.0	37.3	99.0	17.0	17.1	24.0	4.8	4.8	11.0	Pass
5320	22.5	29.2	99.0	14.5	14.6	24.0	2.4	2.4	11.0	Pass
<b>802.11n 20MHz</b>										
5260	25.0	43.3	98.0	16.3	16.4	24.0	3.8	3.9	11.0	Pass
5300	26.0	39.2	98.0	16.7	16.8	24.0	4.5	4.6	11.0	Pass
5320	22.5	29.1	98.0	14.6	14.6	24.0	2.2	2.3	11.0	Pass
<b>802.11n 40MHz</b>										
5270	26.0	88.8	97.0	16.6	16.7	24.0	1.1	1.2	11.0	Pass
5310	23.0	48.0	97.0	13.7	13.9	24.0	-1.8	-1.7	11.0	Pass
<b>802.11ac 80MHz</b>										
5290	21.5	123.8	94.0	13.5	13.8	24.0	-5.1	-4.8	11.0	Pass

## SISO Device - 5250-5350 MHz Band - Industry Canada

Antenna Gain (dBi): 3.7 Max EIRP: 119.0 mW 20.8 dBm

Frequency (MHz)	Software Setting	99% BW (MHz)	Duty Cycle %	Output Power <sup>1</sup> dBm			PSD <sup>2</sup> dBm/MHz			Result
				Measured	Calculated	Limit	Measured	Calculated	Limit <sup>3</sup>	
<b>802.11a</b>										
5260	25.0	17.6	99.0	16.6	16.6	23.4	4.5	4.5	11.0	Pass
5300	26.0	17.8	99.0	17.0	17.1	23.5	4.8	4.8	11.0	Pass
5320	22.5	16.7	99.0	14.5	14.6	23.2	2.4	2.4	11.0	Pass
<b>802.11n 20MHz</b>										
5260	25.0	18.6	98.0	16.3	16.4	23.7	3.8	3.9	11.0	Pass
5300	26.0	18.7	98.0	16.7	16.8	23.7	4.5	4.6	11.0	Pass
5320	22.5	18.1	98.0	14.6	14.6	23.6	2.2	2.3	11.0	Pass
<b>802.11n 40MHz</b>										
5270	26.0	36.6	97.0	16.6	16.7	24.0	1.1	1.2	11.0	Pass
5310	23.0	36.1	97.0	13.7	13.9	24.0	-1.8	-1.7	11.0	Pass
<b>802.11ac 80MHz</b>										
5290	21.5	75.6	94.0	13.5	13.8	24.0	-5.1	-4.8	11.0	Pass

Client: Intel Corporation	Job Number: J94914
Model: 7265D2W	T-Log Number: T95472
	Project Manager: Christine Krebill
Contact: Steve Hackett	Project Coordinator: -
Standard: FCC Part 15.247, 15.407, RSS-210	Class: N/A

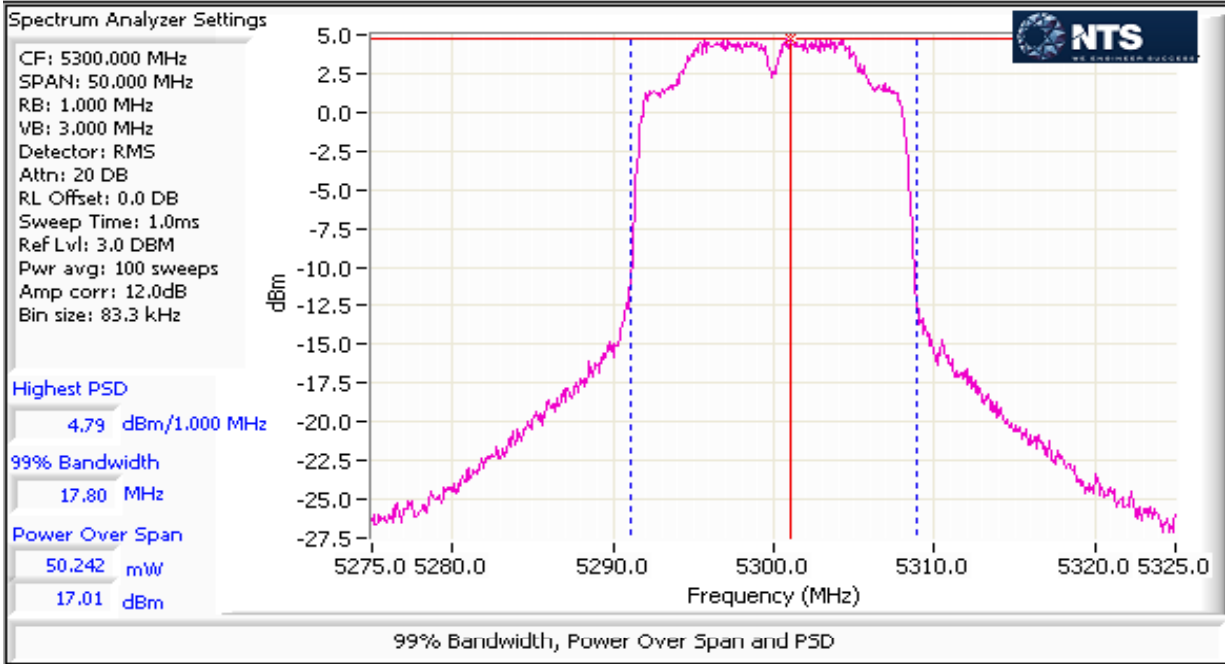



# EMC Test Data

Client:	Intel Corporation	Job Number:	J94914
Model:	7265D2W	T-Log Number:	T95472
Contact:	Steve Hackett	Project Manager:	Christine Krebill
Standard:	FCC Part 15.247, 15.407, RSS-210	Project Coordinator:	-
		Class:	N/A

SISO Device - 5470-5725 MHz Band - FCC

Antenna Gain (dBi): 4.8      Max EIRP: 151.8 mW      21.8 dBm

Frequency (MHz)	Software Setting	26dB BW (MHz)	Duty Cycle %	Output Power <sup>1</sup> dBm			PSD <sup>2</sup> dBm/MHz			Result
				Measured	Calculated	Limit	Measured	Calculated	Limit	
<b>802.11a</b>										
5500	22.5	21.6	99.0	13.9	14.0	24.0	1.9	2.0	11.0	Pass
5580	27.5	38.6	99.0	16.6	16.7	24.0	4.3	4.4	11.0	Pass
5700	23.0	20.4	99.0	13.2	13.2	24.0	1.1	1.2	11.0	Pass
<b>802.11n 20MHz</b>										
5500	22.5	22.3	98.0	14.1	14.2	24.0	1.7	1.8	11.0	Pass
5580	28.0	31.8	98.0	16.8	16.9	24.0	4.6	4.7	11.0	Pass
5700	23.0	21.7	98.0	13.1	13.2	24.0	0.8	0.9	11.0	Pass
<b>802.11ac 20MHz</b>										
<b>UNII-2ext</b>										
5720	30.0	21.8	98.0	15.9	16.0	24.0	4.4	4.5	11.0	Pass
<b>UNII-3</b>										
5720	30.0	10.9	98.0	8.6	8.6	21.4	3.4	3.5	11.0	Pass
<b>802.11n 40MHz</b>										
5510	23.0	41.8	97.0	14.0	14.2	24.0	-1.7	-1.6	11.0	Pass
5550	27.5	86.0	97.0	16.9	17.0	24.0	1.3	1.4	11.0	Pass
5670	25.5	85.2	97.0	15.3	15.4	24.0	-0.2	-0.1	11.0	Pass
<b>802.11ac 40MHz</b>										
<b>UNII-2ext</b>										
5710	30.0	51.3	97.0	16.4	16.5	24.0	1.0	1.1	11.0	Pass
<b>UNII-3</b>										
5710	30.0	18.5	97.0	4.3	4.5	23.7	-1.7	-1.6	11.0	Pass
<b>802.11ac 80MHz</b>										
5530	20.5	80.5	94.0	13.6	13.8	24.0	-5.0	-4.8	11.0	Pass
5610	27.5	142.3	94.0	16.7	17.0	24.0	-1.9	-1.6	11.0	Pass
<b>UNII-2ext</b>										
5690	28.0	105.3	94.0	16.2	16.4	24.0	-2.1	-1.8	11.0	Pass
<b>UNII-3</b>										
5690	28.0	37.5	94.0	0.9	1.1	24.0	-5.8	-5.5	11.0	Pass



# EMC Test Data

Client: Intel Corporation	Job Number: J94914
Model: 7265D2W	T-Log Number: T95472
Contact: Steve Hackett	Project Manager: Christine Krebill
Standard: FCC Part 15.247, 15.407, RSS-210	Project Coordinator: -
	Class: N/A

SISO Device - 5470-5725 MHz Band - Industry Canada

Antenna Gain (dBi): 4.8      Max EIRP: 151.8 mW      21.8 dBm

Frequency (MHz)	Software Setting	99% BW (MHz)	Duty Cycle %	Output Power <sup>1</sup> dBm			PSD <sup>2</sup> dBm/MHz			Result
				Measured	Calculated	Limit	Measured	Calculated	Limit <sup>3</sup>	
<b>802.11a</b>										
5500	22.5	16.6	99.0	13.9	14.0	23.2	1.9	2.0	11.0	Pass
5580	27.5	19.7	99.0	16.6	16.7	23.9	4.3	4.4	11.0	Pass
5700	23.0	16.7	99.0	13.2	13.2	23.2	1.1	1.2	11.0	Pass
<b>802.11n 20MHz</b>										
5500	22.5	17.9	98.0	14.1	14.2	23.5	1.7	1.8	11.0	Pass
5580	28.0	18.1	98.0	16.8	16.9	23.6	4.6	4.7	11.0	Pass
5700	23.0	17.9	98.0	13.1	13.2	23.5	0.8	0.9	11.0	Pass
<b>802.11ac 20MHz</b>										
<b>UNII-2ext</b>										
5720	30.0	14.1	98.0	15.9	16.0	22.5	4.4	4.5	11.0	Pass
<b>UNII-3</b>										
5720	30.0	7.2	98.0	8.6	8.6	19.6	3.4	3.5	10.6	Pass
<b>802.11n 40MHz</b>										
5510	23.0	36.1	97.0	14.0	14.2	24.0	-1.7	-1.6	11.0	Pass
5550	27.5	41.1	97.0	16.9	17.0	24.0	1.3	1.4	11.0	Pass
5670	25.5	36.3	97.0	15.3	15.4	24.0	-0.2	-0.1	11.0	Pass
<b>802.11ac 40MHz</b>										
<b>UNII-2ext</b>										
5710	30.0	33.1	97.0	16.4	16.5	24.0	1.0	1.1	11.0	Pass
<b>UNII-3</b>										
5710	30.0	11.1	97.0	4.3	4.5	21.4	-1.7	-1.6	9.6	Pass
<b>802.11ac 80MHz</b>										
5530	20.5	75.4	94.0	13.6	13.8	24.0	-5.0	-4.8	11.0	Pass
<b>UNII-2ext</b>										
5690	28.0	73.6	94.0	16.2	16.4	24.0	-2.1	-1.8	11.0	Pass
<b>UNII-3</b>										
5690	28.0	34.8	94.0	0.9	1.1	24.0	-5.8	-5.5	5.3	Pass

Client: Intel Corporation	Job Number: J94914
Model: 7265D2W	T-Log Number: T95472
Contact: Steve Hackett	Project Manager: Christine Krebill
Standard: FCC Part 15.247, 15.407, RSS-210	Project Coordinator: -
	Class: N/A

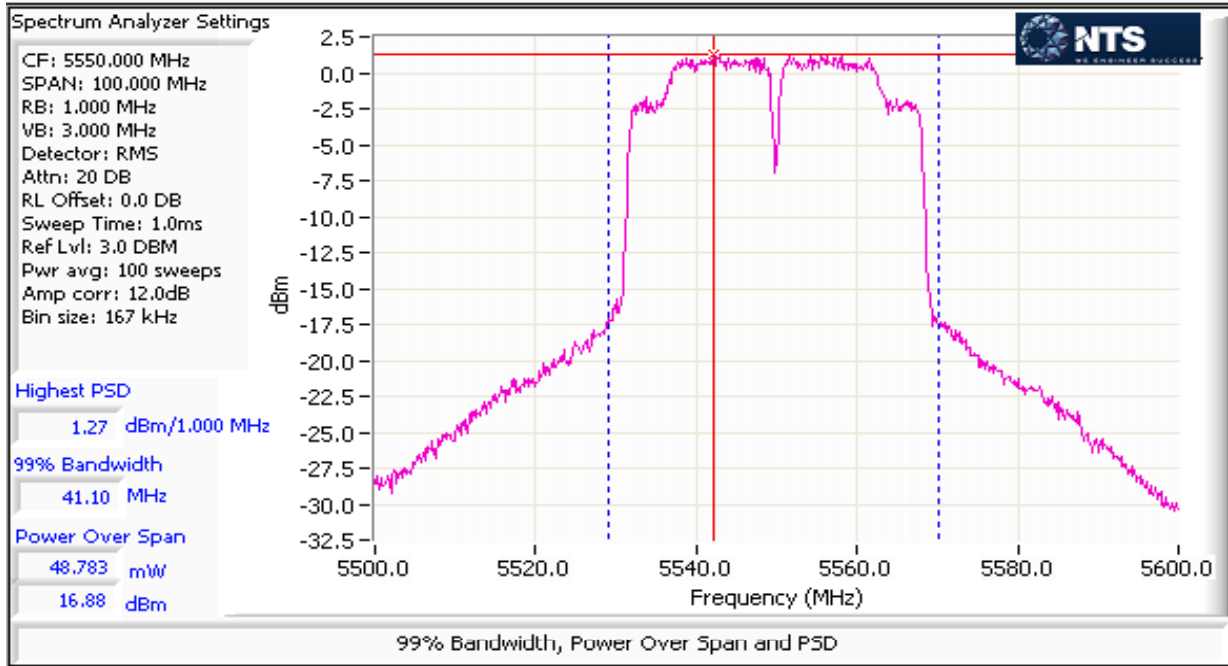



# EMC Test Data

Client: Intel Corporation	Job Number: J94914
Model: 7265D2W	T-Log Number: T95472
Contact: Steve Hackett	Project Manager: Christine Krebill
Standard: FCC Part 15.247, 15.407, RSS-210	Project Coordinator: -
	Class: N/A

SISO Device - 5725-5850 MHz Band - FCC Only

Antenna Gain (dBi): 5      Max EIRP: 159.3 mW      22.0 dBm

Frequency (MHz)	Software Setting	6dB BW (MHz)	Duty Cycle %	Output Power <sup>1</sup> dBm			PSD <sup>2</sup> dBm/MHz			Result
				Measured	Calculated	Limit	Measured	Calculated	Limit	
<b>802.11a</b>										
5745	29.5	-	99.0	16.7	17.0	30.0	5.1	5.1	30.0	Pass
5785	30.5	15.1	99.0	16.8	16.8	30.0	4.5	4.6	30.0	Pass
5825	30.0	-	99.0	16.6	16.6	30.0	4.6	4.6	30.0	Pass
<b>802.11n 20MHz</b>										
5745	29.0	-	98.0	16.8	16.9	30.0	4.5	4.6	30.0	Pass
5785	30.0	15.1	98.0	16.9	17.0	30.0	4.6	4.7	30.0	Pass
5825	30.5	-	98.0	16.5	16.6	30.0	4.2	4.3	30.0	Pass
<b>802.11n 40MHz</b>										
5755	25.5	35.0	97.0	15.0	15.1	30.0	-0.6	-0.4	30.0	Pass
5795	30.5	-	97.0	16.9	17.0	30.0	1.4	1.5	30.0	Pass
<b>802.11ac80</b>										
5775	20.5	75.1	94.0	12.3	12.5	30.0	-6.3	-6.0	30.0	Pass

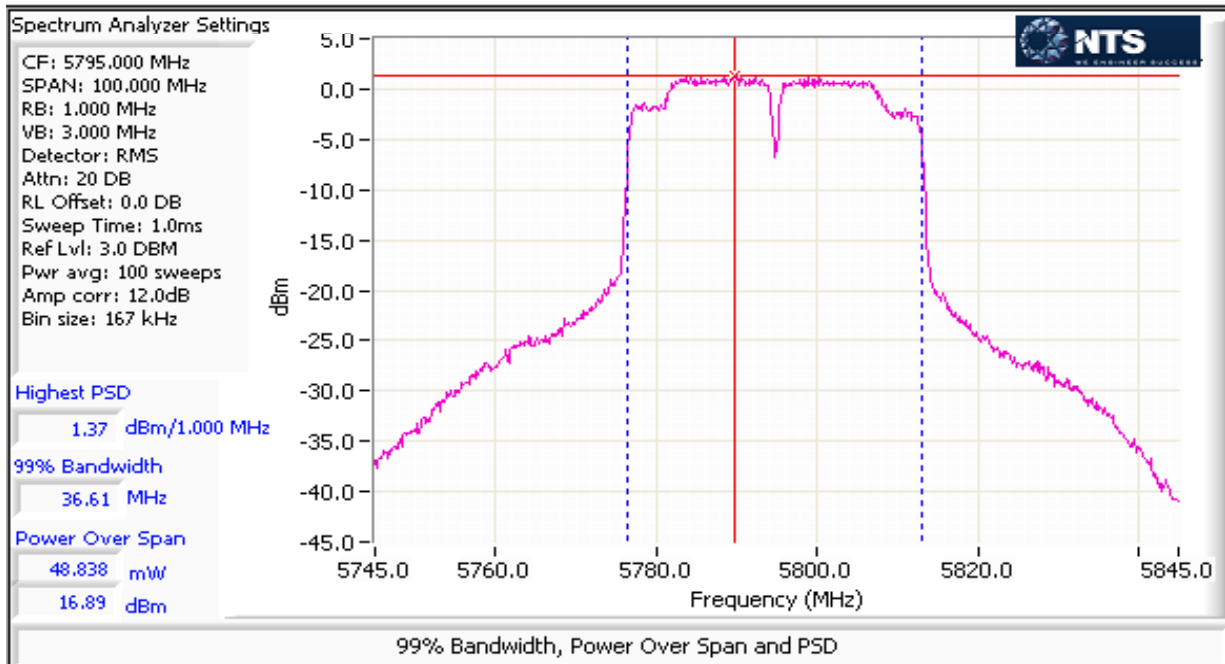



# EMC Test Data

Client:	Intel Corporation	Job Number:	J94914
Model:	7265D2W	T-Log Number:	T95472
Contact:	Steve Hackett	Project Manager:	Christine Krebill
Standard:	FCC Part 15.247, 15.407, RSS-210	Project Coordinator:	-
		Class:	N/A

## RSS-210 (LELAN) and FCC 15.407(UNII) Antenna Port Measurements Power, PSD, Peak Excursion, Bandwidth and Spurious Emissions

### Test Specific Details

Objective: The objective of this test session is to perform final qualification testing of the EUT with respect to the specification listed above.

### Summary of Results

Run #	Test Performed	Limit	Pass / Fail	Result / Margin
1	Power, 5150 - 5250MHz	15.407(a) (1)	Pass	a: 42.7 mW n20: 45.7 mW n40: 49.0 mW ac80: 27.5 mW
1	PSD, 5150 - 5250MHz	15.407(a) (1)	Pass	a: 4.2 dBm/MHz n20: 4.4 dBm/MHz n40: 1.5 dBm/MHz ac80: -4.3 dBm/MHz
1	Power, 5250 - 5350MHz	15.407(a) (2)	Pass	a: 47.9 mW n20: 47.9 mW n40: 47.9 mW ac80: 26.9 mW
1	PSD, 5250 - 5350MHz	15.407(a) (2)	Pass	a: 4.7 dBm/MHz n20: 4.4 dBm/MHz n40: 1.2 dBm/MHz ac80: -4.0 dBm/MHz
1	Max EIRP 5250 - 5350MHz	TPC required if EIRP ≥ 500mW (27dBm). EIRP ≥ 200mW (23dBm) DFS threshold = -64dBm.	Pass	EIRP = 20.5 dBm (113.3 mW)





# EMC Test Data

Client:	Intel Corporation	Job Number:	J94914
Model:	7265D2W	T-Log Number:	T95472
Contact:	Steve Hackett	Project Manager:	Christine Krebill
Standard:	FCC Part 15.247, 15.407, RSS-210	Project Coordinator:	-
		Class:	N/A

Run #	Test Performed	Limit	Pass / Fail	Result / Margin
1	Power, 5470 - 5725MHz	15.407(a) (2)	Pass	a: 46.8 mW n20: 49.0 mW n40: 47.9 mW ac80: 50 mW
1	PSD, 5470 - 5725MHz	15.407(a) (2)	Pass	a: 4.6 dBm/MHz n20: 4.6 dBm/MHz n40: 1.1 dBm/MHz ac80: -1.7 dBm/MHz
1	Max EIRP 5470 - 5725MHz	TPC required if EIRP ≥ 500mW (27dBm). EIRP ≥ 200mW (23dBm) DFS threshold	Pass	EIRP = 21.7 dBm (147.5 mW)
1	Power, 5725 - 5850MHz	15.407(a) (3)	Pass	a: 51.3 mW n20: 51.3 mW n40: 38.0 mW ac80: 14.8 mW
1	PSD, 5725 - 5850MHz	15.407(a) (3)	Pass	a: 5.1 dBm/MHz n20: 4.9 dBm/MHz n40: 0.2 dBm/MHz ac80: -6.8 dBm/MHz
1	26dB Bandwidth	15.407 (Information only)	-	> 20MHz for all modes
1	99% Bandwidth	RSS 210 (Information only)	N/A	a: 20.0 MHz n20: 18.5 MHz n40: 40.4 MHz ac80: 75.6 MHz
2	Antenna Conducted - Out of Band Spurious	15.407(b) -27dBm/MHz		Not performed conducted, Refer to Radiated Spurious Emissions data



# EMC Test Data

Client:	Intel Corporation	Job Number:	J94914
Model:	7265D2W	T-Log Number:	T95472
Contact:	Steve Hackett	Project Manager:	Christine Krebill
Standard:	FCC Part 15.247, 15.407, RSS-210	Project Coordinator:	-
		Class:	N/A

## General Test Configuration

When measuring the conducted emissions from the EUT's antenna port, the antenna port of the EUT was connected to the spectrum analyzer or power meter via a suitable attenuator to prevent overloading the measurement system. All measurements are corrected to allow for the external attenuators and cables used.

## Ambient Conditions:

Temperature: 22.1 °C  
 Rel. Humidity: 37 %

## Modifications Made During Testing

No modifications were made to the EUT during testing

## Deviations From The Standard

No deviations were made from the requirements of the standard.

## Procedure Comments:

Measurements performed in accordance with FCC KDB 789033 D02 v01, dated June 6, 2014

Mode	Data Rate	Duty Cycle (x)	Constant DC?	T (ms)	Pwr Cor Factor*	Lin Volt Cor Factor**	Min VBW for FS (Hz)
11a	6.0Mbps	99%	Constant	2.06	0.0	0.0	485
n20	6.5Mbps	98%	Constant	1.92	0.0	0.0	521
n40	13.5Mbps	97%	Constant	0.94	0.1	0.3	1064
ac80	29.3Mbps	94%	Constant	0.44	0.3	0.6	2273

## Sample Notes

MAC Address: 001500F15B5D DRTU Tool Version 1.7.3-935 Driver version 17.1.0.11





# EMC Test Data

Client: Intel Corporation	Job Number: J94914
Model: 7265D2W	T-Log Number: T95472
Contact: Steve Hackett	Project Manager: Christine Krebill
Standard: FCC Part 15.247, 15.407, RSS-210	Project Coordinator: -
	Class: N/A

### SISO Device - 5150-5250 MHz Band - FCC

Antenna Gain (dBi): 3.6      Max EIRP: 104.7 mW      20.2 dBm

Frequency (MHz)	Software Setting	26dB BW (MHz)	Duty Cycle %	Output Power <sup>1</sup> dBm			PSD <sup>2</sup> dBm/MHz			Result
				Measured	Calculated	Limit	Measured	Calculated	Limit	
<b>802.11a</b>										
5180	23.5	21.7	99.0	14.7	14.8	24.0	2.5	2.5	11.0	Pass
5200	25.0	38.8	99.0	15.9	16.0	24.0	3.9	3.9	11.0	Pass
5240	25.5	36.3	99.0	16.3	16.3	24.0	4.2	4.2	11.0	Pass
<b>802.11n 20MHz</b>										
5180	23.5	23.3	98.0	14.8	14.9	24.0	2.5	2.6	11.0	Pass
5200	25.5	37.5	98.0	16.4	16.4	24.0	4.1	4.2	11.0	Pass
5240	26.0	42.0	98.0	16.5	16.6	24.0	4.3	4.4	11.0	Pass
<b>802.11n 40MHz</b>										
5190	23.0	41.2	97.0	14.1	14.2	24.0	-1.7	-1.5	11.0	Pass
5230	26.5	81.8	97.0	16.7	16.9	24.0	1.4	1.5	11.0	Pass
<b>802.11ac 80MHz</b>										
5210	21.0	81.3	94.0	14.1	14.4	24.0	-4.5	-4.3	11.0	Pass

### SISO Device - 5150-5250 MHz Band - Industry Canada

Antenna Gain (dBi): 3.6      Max EIRP: 104.7 mW      20.2 dBm

Frequency (MHz)	Software Setting	99% BW (MHz)	Duty Cycle %	Output Power <sup>1</sup> dBm			PSD <sup>2</sup> dBm/MHz			Result
				Measured	Calculated	Limit	Measured	Calculated	Limit <sup>3</sup>	
<b>802.11a</b>										
5180	23.5	16.7	99.0	14.7	14.8	16.2	2.5	2.5	6.4	Pass
5200	25.0	16.7	99.0	15.9	16.0	16.2	3.9	3.9	6.4	Pass
5240	25.5	17.1	99.0	16.3	16.3	16.3	4.2	4.2	6.4	Pass
<b>802.11n 20MHz</b>										
5180	23.5	17.9	98.0	14.8	14.9	16.5	2.5	2.6	6.4	Pass
5200	25.5	18.3	98.0	16.4	16.4	16.6	4.1	4.2	6.4	Pass
5240	26.0	18.4	98.0	16.5	16.6	16.6	4.3	4.4	6.4	Pass
<b>802.11n 40MHz</b>										
5190	23.0	36.3	97.0	14.1	14.2	17.0	-1.7	-1.5	6.4	Pass
5230	26.5	36.8	97.0	16.7	16.9	17.0	1.4	1.5	6.4	Pass
<b>802.11ac 80MHz</b>										
5210	21.0	75.6	94.0	14.1	14.4	17.0	-4.5	-4.3	6.4	Pass

Client: Intel Corporation	Job Number: J94914
Model: 7265D2W	T-Log Number: T95472
	Project Manager: Christine Krebill
Contact: Steve Hackett	Project Coordinator: -
Standard: FCC Part 15.247, 15.407, RSS-210	Class: N/A

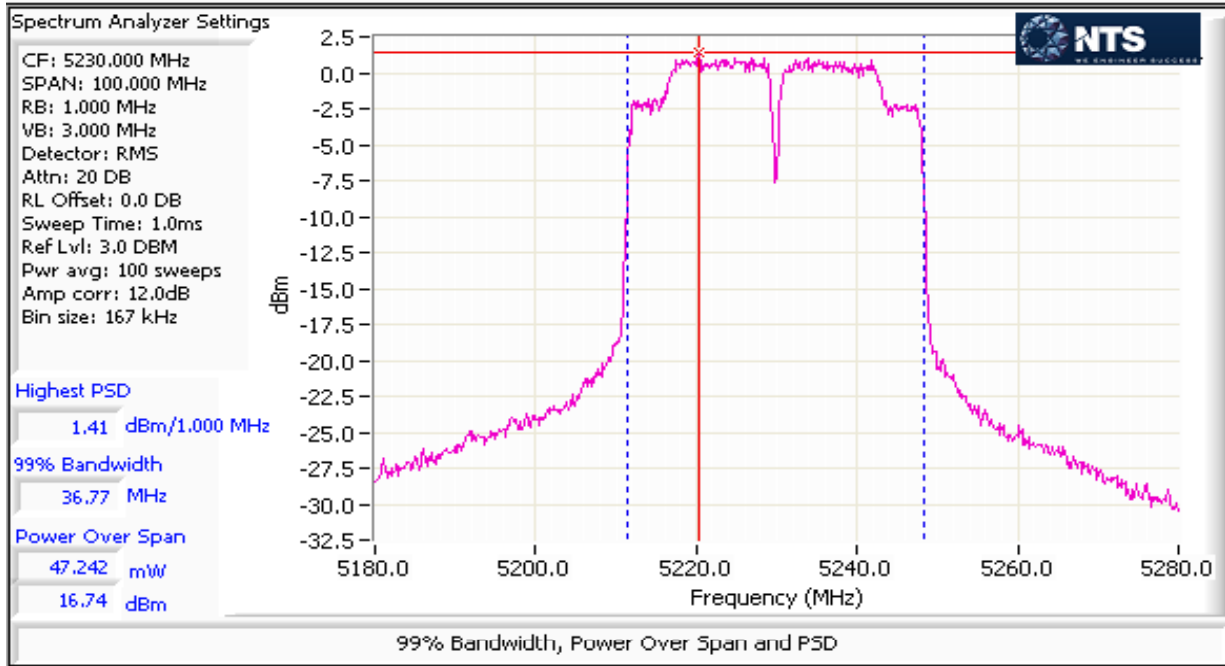



# EMC Test Data

Client:	Intel Corporation	Job Number:	J94914
Model:	7265D2W	T-Log Number:	T95472
Contact:	Steve Hackett	Project Manager:	Christine Krebill
Standard:	FCC Part 15.247, 15.407, RSS-210	Project Coordinator:	-
		Class:	N/A

## SISO Device - 5250-5350 MHz Band - FCC

Antenna Gain (dBi): 3.7      Max EIRP: 113.3 mW      20.5 dBm

Frequency (MHz)	Software Setting	26dB BW (MHz)	Duty Cycle %	Output Power <sup>1</sup> dBm			PSD <sup>2</sup> dBm/MHz			Result
				Measured	Calculated	Limit	Measured	Calculated	Limit	
<b>802.11a</b>										
5260	26.0	36.8	99.0	16.3	16.4	24.0	4.2	4.3	11.0	Pass
5300	26.5	36.3	99.0	16.8	16.8	24.0	4.6	4.7	11.0	Pass
5320	23.5	22.3	99.0	14.6	14.7	24.0	2.7	2.8	11.0	Pass
<b>802.11n 20MHz</b>										
5260	26.0	37.9	98.0	16.4	16.4	24.0	4.2	4.3	11.0	Pass
5300	26.5	36.3	98.0	16.7	16.8	24.0	4.3	4.4	11.0	Pass
5320	23.5	21.7	98.0	14.6	14.7	24.0	2.2	2.3	11.0	Pass
<b>802.11n 40MHz</b>										
5270	27.0	70.3	97.0	16.7	16.8	24.0	1.0	1.2	11.0	Pass
5310	23.5	40.5	97.0	14.4	14.5	24.0	-1.4	-1.2	11.0	Pass
<b>802.11ac 80MHz</b>										
5290	23.5	89.8	94.0	14.1	14.3	24.0	-4.3	-4.0	11.0	Pass

## SISO Device - 5250-5350 MHz Band - Industry Canada

Antenna Gain (dBi): 3.7      Max EIRP: 113.3 mW      20.5 dBm

Frequency (MHz)	Software Setting	99% BW (MHz)	Duty Cycle %	Output Power <sup>1</sup> dBm			PSD <sup>2</sup> dBm/MHz			Result
				Measured	Calculated	Limit	Measured	Calculated	Limit <sup>3</sup>	
<b>802.11a</b>										
5260	26.0	17.3	99.0	16.3	16.4	23.4	4.2	4.3	11.0	Pass
5300	26.5	17.3	99.0	16.8	16.8	23.4	4.6	4.7	11.0	Pass
5320	23.5	16.7	99.0	14.6	14.7	23.2	2.7	2.8	11.0	Pass
<b>802.11n 20MHz</b>										
5260	26.0	18.4	98.0	16.4	16.4	23.6	4.2	4.3	11.0	Pass
5300	26.5	18.5	98.0	16.7	16.8	23.7	4.3	4.4	11.0	Pass
5320	23.5	17.9	98.0	14.6	14.7	23.5	2.2	2.3	11.0	Pass
<b>802.11n 40MHz</b>										
5270	27.0	37.1	97.0	16.7	16.8	24.0	1.0	1.2	11.0	Pass
5310	23.5	36.3	97.0	14.4	14.5	24.0	-1.4	-1.2	11.0	Pass
<b>802.11ac 80MHz</b>										
5290	23.5	75.6	94.0	14.1	14.3	24.0	-4.3	-4.0	11.0	Pass

Client: Intel Corporation	Job Number: J94914
Model: 7265D2W	T-Log Number: T95472
	Project Manager: Christine Krebill
Contact: Steve Hackett	Project Coordinator: -
Standard: FCC Part 15.247, 15.407, RSS-210	Class: N/A

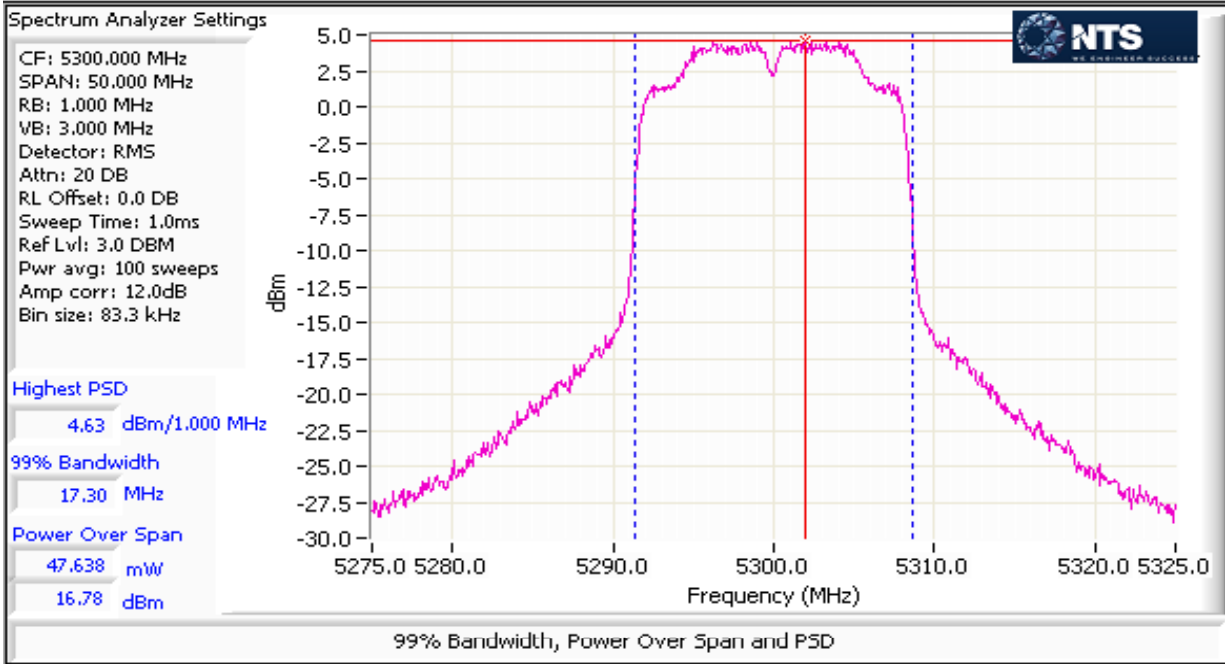



# EMC Test Data

Client:	Intel Corporation	Job Number:	J94914
Model:	7265D2W	T-Log Number:	T95472
Contact:	Steve Hackett	Project Manager:	Christine Krebill
Standard:	FCC Part 15.247, 15.407, RSS-210	Project Coordinator:	-
		Class:	N/A

SISO Device - 5470-5725 MHz Band - FCC

Antenna Gain (dBi): 4.8      Max EIRP: 147.5 mW      21.7 dBm

Frequency (MHz)	Software Setting	26dB BW (MHz)	Duty Cycle %	Output Power <sup>1</sup> dBm			PSD <sup>2</sup> dBm/MHz			Result
				Measured	Calculated	Limit	Measured	Calculated	Limit	
<b>802.11a</b>										
5500	24.0	22.0	99.0	14.1	14.2	24.0	2.0	2.0	11.0	Pass
5580	28.5	30.4	99.0	16.7	16.7	24.0	4.5	4.6	11.0	Pass
5700	24.0	23.8	99.0	13.3	13.3	24.0	1.0	1.1	11.0	Pass
<b>802.11n 20MHz</b>										
5500	24.0	22.5	98.0	14.1	14.2	24.0	1.8	1.8	11.0	Pass
5580	29.5	31.3	98.0	16.8	16.9	24.0	4.5	4.6	11.0	Pass
5700	24.0	23.2	98.0	13.2	13.2	24.0	0.9	1.0	11.0	Pass
<b>802.11ac 20MHz</b>										
<b>UNII-2ext</b>										
5720	30.5	20.5	98.0	13.6	13.7	24.0	4.3	4.4	11.0	Pass
<b>UNII-3</b>										
5720	30.5	10.4	98.0	13.9	14.0	21.2	4.7	4.8	11.0	Pass
<b>802.11n 40MHz</b>										
5510	24.5	41.7	97.0	14.5	14.6	24.0	-1.1	-0.9	11.0	Pass
5550	28.0	60.5	97.0	16.7	16.8	24.0	1.0	1.1	11.0	Pass
5670	29.0	56.7	97.0	16.0	16.1	24.0	0.5	0.6	11.0	Pass
<b>802.11ac 40MHz</b>										
<b>UNII-2ext</b>										
5710	30.5	50.8	97.0	15.8	15.9	24.0	1.1	1.2	11.0	Pass
<b>UNII-3</b>										
5710	30.5	19.3	97.0	9.6	9.7	23.9	1.2	1.3	11.0	Pass
<b>802.11ac 80MHz</b>										
5530	21.5	81.0	94.0	13.7	14.0	24.0	-4.9	-4.7	11.0	Pass
5610	28.5	128.0	94.0	16.7	17.0	24.0	-1.9	-1.7	11.0	Pass
<b>UNII-2ext</b>										
5690	29.5	104.5	94.0	16.1	16.4	24.0	-2.1	-1.9	11.0	Pass
<b>UNII-3</b>										
5690	29.5	31.5	94.0	4.8	5.0	24.0	-5.4	-5.1	11.0	Pass





# EMC Test Data

Client:	Intel Corporation	Job Number:	J94914
Model:	7265D2W	T-Log Number:	T95472
Contact:	Steve Hackett	Project Manager:	Christine Krebill
Standard:	FCC Part 15.247, 15.407, RSS-210	Project Coordinator:	-
		Class:	N/A

SISO Device - 5470-5725 MHz Band - Industry Canada

Antenna Gain (dBi): 4.8

Max EIRP: 147.5 mW

21.7 dBm

Frequency (MHz)	Software Setting	99% BW (MHz)	Duty Cycle %	Output Power <sup>1</sup> dBm			PSD <sup>2</sup> dBm/MHz			Result
				Measured	Calculated	Limit	Measured	Calculated	Limit <sup>3</sup>	
<b>802.11a</b>										
5500	24.0	16.7	99.0	14.1	14.2	23.2	2.0	2.0	11.0	Pass
5580	28.5	20.0	99.0	16.7	16.7	24.0	4.5	4.6	11.0	Pass
5700	24.0	16.7	99.0	13.3	13.3	23.2	1.0	1.1	11.0	Pass
<b>802.11n 20MHz</b>										
5500	24.0	17.9	98.0	14.1	14.2	23.5	1.8	1.8	11.0	Pass
5580	29.5	18.2	98.0	16.8	16.9	23.6	4.5	4.6	11.0	Pass
5700	24.0	17.9	98.0	13.2	13.2	23.5	0.9	1.0	11.0	Pass
<b>802.11ac 20MHz</b>										
<b>UNII-2ext</b>										
5720	30.5	9.7	98.0	13.6	13.7	20.9	4.3	4.4	11.0	Pass
<b>UNII-3</b>										
5720	30.5	9.4	98.0	13.9	14.0	20.7	4.7	4.8	11.0	Pass
<b>802.11n 40MHz</b>										
5510	24.5	36.1	97.0	14.5	14.6	24.0	-1.1	-0.9	11.0	Pass
5550	28.0	40.4	97.0	16.7	16.8	24.0	1.0	1.1	11.0	Pass
5670	29.0	36.4	97.0	16.0	16.1	24.0	0.5	0.6	11.0	Pass
<b>802.11ac 40MHz</b>										
<b>UNII-2ext</b>										
5710	30.5	28.5	97.0	15.8	15.9	24.0	1.1	1.2	11.0	Pass
<b>UNII-3</b>										
5710	30.5	14.2	97.0	9.6	9.7	22.5	1.2	1.3	10.9	Pass
<b>802.11ac 80MHz</b>										
5530	21.5	75.6	94.0	13.7	14.0	24.0	-4.9	-4.7	11.0	Pass
<b>UNII-2ext</b>										
5690	29.5	70.9	94.0	16.1	16.4	24.0	-2.1	-1.9	11.0	Pass
<b>UNII-3</b>										
5690	29.5	36.3	94.0	4.8	5.0	24.0	-5.4	-5.1	8.5	Pass

Client: Intel Corporation	Job Number: J94914
Model: 7265D2W	T-Log Number: T95472
	Project Manager: Christine Krebill
Contact: Steve Hackett	Project Coordinator: -
Standard: FCC Part 15.247, 15.407, RSS-210	Class: N/A

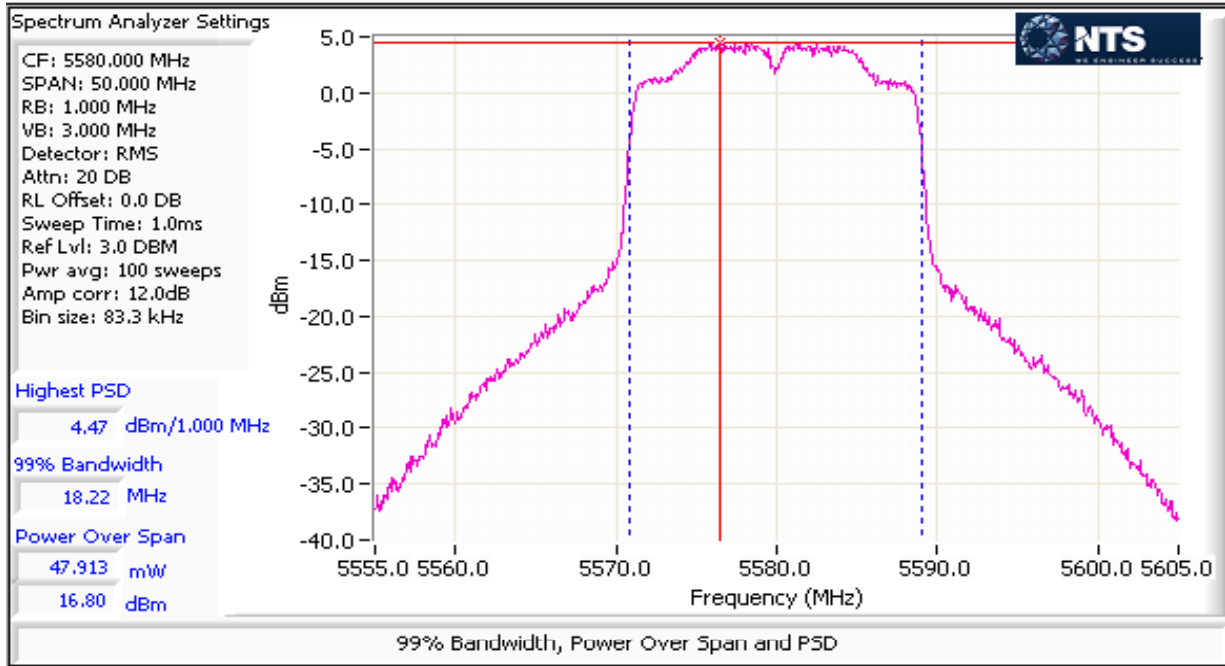



# EMC Test Data

Client: Intel Corporation	Job Number: J94914
Model: 7265D2W	T-Log Number: T95472
Contact: Steve Hackett	Project Manager: Christine Krebill
Standard: FCC Part 15.247, 15.407, RSS-210	Project Coordinator: -
	Class: N/A

SISO Device - 5725-5850 MHz Band - FCC Only

Antenna Gain (dBi): 5      Max EIRP: 162.7 mW      22.1 dBm

Frequency (MHz)	Software Setting	6dB BW (MHz)	Duty Cycle %	Output Power <sup>1</sup> dBm			PSD <sup>2</sup> dBm/MHz			Result
				Measured	Calculated	Limit	Measured	Calculated	Limit	
<b>802.11a</b>										
5745	30.0	15.1	99.0	16.7	16.8	30.0	4.8	4.8	30.0	Pass
5785	31.5	15.1	99.0	17.1	17.1	30.0	5.0	5.1	30.0	Pass
5825	31.5	15.6	99.0	16.9	16.9	30.0	4.7	4.8	30.0	Pass
<b>802.11n 20MHz</b>										
5745	30.0	15.1	98.0	16.7	16.8	30.0	4.5	4.5	30.0	Pass
5785	31.5	16.3	98.0	17.0	17.1	30.0	4.8	4.9	30.0	Pass
5825	31.5	15.1	98.0	16.9	16.9	30.0	4.5	4.6	30.0	Pass
<b>802.11n 40MHz</b>										
5755	25.0	33.8	97.0	14.3	14.4	30.0	-1.3	-1.1	30.0	Pass
5795	27.5	35.0	97.0	15.7	15.8	30.0	0.1	0.2	30.0	Pass
<b>802.11ac80</b>										
5775	20.5	73.8	94.0	11.4	11.7	30.0	-7.0	-6.8	30.0	Pass

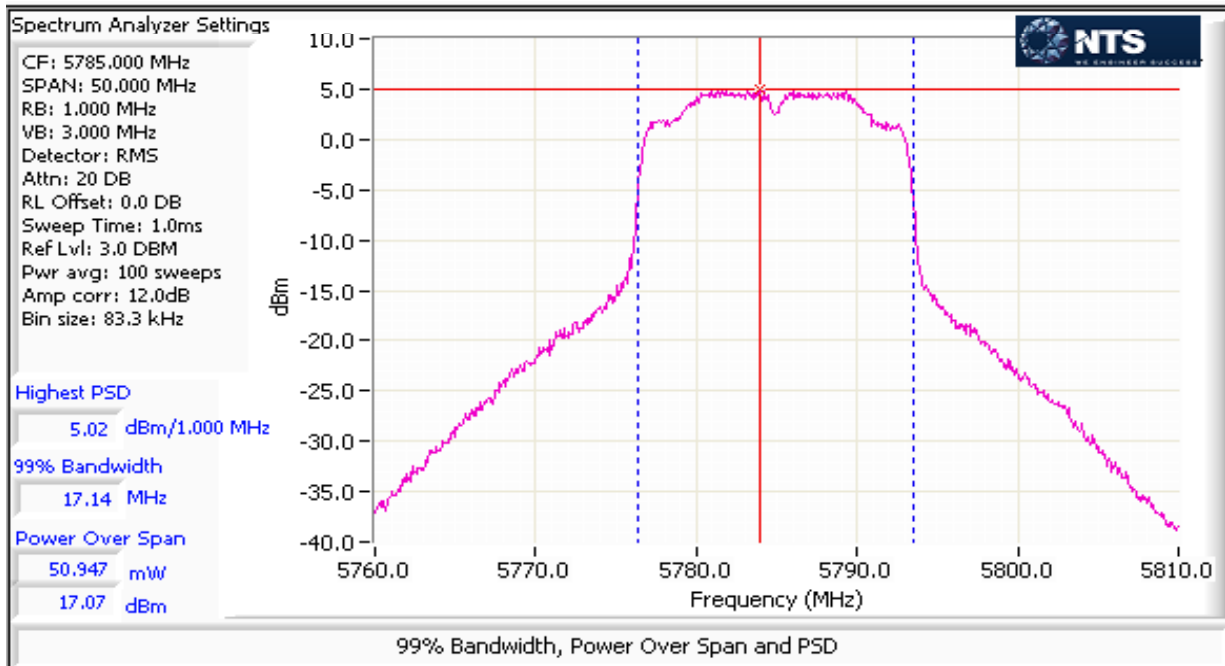



# EMC Test Data

Client:	Intel Corporation	Job Number:	J94914
Model:	7265D2W	T-Log Number:	T95472
		Project Manager:	Christine Krebill
Contact:	Steve Hackett	Project Coordinator:	-
Standard:	FCC Part 15.247, 15.407, RSS-210	Class:	N/A

## RSS-210 (LELAN) and FCC 15.407(UNII) Antenna Port Measurements Power, PSD, Peak Excursion, Bandwidth and Spurious Emissions

### Test Specific Details

Objective: The objective of this test session is to perform final qualification testing of the EUT with respect to the specification listed above.

### Summary of Results

Run #	Test Performed	Limit	Pass / Fail	Result / Margin
1	Power, 5150 - 5250MHz	15.407(a) (1)	Pass	n20: 36.3 mW n40: 81.3 mW ac80: 33.1 mW
1	PSD, 5150 - 5250MHz	15.407(a) (1)	Pass	n20: 3.3 dBm/MHz n40: 3.4 dBm/MHz ac80: -3.4 dBm/MHz
1	Power, 5250 - 5350MHz	15.407(a) (2)	Pass	n20: 93.3 mW n40: 97.7 mW ac80: 25.1 mW
1	PSD, 5250 - 5350MHz	15.407(a) (2)	Pass	n20: 7.4 dBm/MHz n40: 4.2 dBm/MHz ac80: -4.2 dBm/MHz
1	Max EIRP 5250 - 5350MHz	TPC required if EIRP ≥ 500mW (27dBm). EIRP ≥ 200mW (23dBm) DFS threshold = -64dBm.	Pass	EIRP = 23.2 dBm (210.9 mW)



# EMC Test Data

Client:	Intel Corporation	Job Number:	J94914
Model:	7265D2W	T-Log Number:	T95472
Contact:	Steve Hackett	Project Manager:	Christine Krebill
Standard:	FCC Part 15.247, 15.407, RSS-210	Project Coordinator:	-
		Class:	N/A

Run #	Test Performed	Limit	Pass / Fail	Result / Margin
1	Power, 5470 - 5725MHz	15.407(a) (2)	Pass	n20: 95.5 mW n40: 104.7 mW ac80: 104.7 mW
1	PSD, 5470 - 5725MHz	15.407(a) (2)	Pass	n20: 7.4 dBm/MHz n40: 4.7 dBm/MHz ac80: 1.7 dBm/MHz
1	Max EIRP 5470 - 5725MHz	TPC required if EIRP ≥ 500mW (27dBm). EIRP ≥ 200mW (23dBm) DFS threshold	Pass	EIRP = 25.0 dBm (319.8 mW)
1	Power, 5725 - 5850MHz	15.407(a) (3)	Pass	n20: 100 mW n40: 49.0 mW ac80: 25.1 mW
1	PSD, 5725 - 5850MHz	15.407(a) (3)	Pass	n20: 8.0 dBm/MHz n40: 4.4 dBm/MHz ac80: -4.4 dBm/MHz
1	26dB Bandwidth	15.407 (Information only)	-	These measurements are covered by the single chain data
1	99% Bandwidth	RSS 210 (Information only)	N/A	
2	Antenna Conducted - Out of Band Spurious	15.407(b) -27dBm/MHz		



# EMC Test Data

Client:	Intel Corporation	Job Number:	J94914
Model:	7265D2W	T-Log Number:	T95472
Contact:	Steve Hackett	Project Manager:	Christine Krebill
Standard:	FCC Part 15.247, 15.407, RSS-210	Project Coordinator:	-
		Class:	N/A

## General Test Configuration

When measuring the conducted emissions from the EUT's antenna port, the antenna port of the EUT was connected to the spectrum analyzer or power meter via a suitable attenuator to prevent overloading the measurement system. All measurements are corrected to allow for the external attenuators and cables used.

## Ambient Conditions:

Temperature: 21.8 °C  
 Rel. Humidity: 36 %

## Modifications Made During Testing

No modifications were made to the EUT during testing

## Deviations From The Standard

No deviations were made from the requirements of the standard.

## Procedure Comments:

Measurements performed in accordance with FCC KDB 789033 D02 v01, dated June 6, 2014

Mode	Data Rate	Duty Cycle (x)	Constant DC?	T (ms)	Pwr Cor Factor*	Lin Volt Cor Factor**	Min VBW for FS (Hz)
n20	6.5Mbps	98%	Constant	1.92	0.0	0.0	521
n40	13.5Mbps	97%	Constant	0.94	0.1	0.3	1064
ac80	29.3Mbps	94%	Constant	0.44	0.3	0.6	2273

## Sample Notes

MAC Address: 001500F15B5D DRTU Tool Version 1.7.3-935 Driver version 17.1.0.11





# EMC Test Data

Client:	Intel Corporation	Job Number:	J94914
Model:	7265D2W	T-Log Number:	T95472
Contact:	Steve Hackett	Project Manager:	Christine Krebill
Standard:	FCC Part 15.247, 15.407, RSS-210	Project Coordinator:	-
		Class:	N/A

## Antenna Gain Information

Freq	Antenna Gain (dBi) / Chain				BF	MultiChain Legacy	CDD	Sectorized / Xpol	Dir G (PWR)	Dir G (PSD)
	1	2	3	4						
5150-5250	3.6	3.6			No	No	Yes	No	3.6	6.6
5250-5350	3.7	3.7			No	No	Yes	No	3.7	6.7
5470-5725	4.8	4.8			No	No	Yes	No	4.8	7.8
5725-5825	5	5			No	No	Yes	No	5.0	8.0

### For devices that support CDD modes

Min # of spatial streams: 1  
 Max # of spatial streams: 2

Notes:	BF = beamforming mode supported, Multichain Legacy = 802.11 legacy data rates supported for multichain transmissions, CDD = Cyclic Delay Diversity (or Cyclic Shift Diversity) modes supported, Sectorized / Xpol = antennas are sectorized or cross polarized.
Notes:	Dir G (PWR) = total gain (Gant + Array Gain) for power calculations; Dir G (PSD) = total gain for PSD calculations Both are based on FCC KDB 662911. Depending on the modes supported, the Array Gain value for power could be different from the PSD value.





# EMC Test Data

Client: Intel Corporation	Job Number: J94914
Model: 7265D2W	T-Log Number: T95472
Contact: Steve Hackett	Project Manager: Christine Krebill
Standard: FCC Part 15.247, 15.407, RSS-210	Project Coordinator: -
	Class: N/A

## MIMO Device - 5150-5250 MHz Band - FCC

Mode: n20

Max EIRP (mW): 83.8

Frequency (MHz)	Chain	Software Setting	26dB BW (MHz)	Duty Cycle %	Power <sup>1</sup> dBm	Total Power mW	Total Power dBm	FCC Limit dBm	Max Power (W)	Result		
5180	1	22.5 / 22.5	31.3	98	12.4	34.5	15.4	24.0	0.037	Pass		
	3											
	4											
	2				12.3							
5200	1	22.0/23.5	45.4	98	12.6	36.4	15.6	24.0		0.037	Pass	
	3											
	4											
	2				12.6							
5240	1	22.5/23.0	44.8	98	12.5	36.6	15.6	24.0			0.037	Pass
	3											
	4											
	2				12.7							

## MIMO Device - 5150-5250 MHz Band - Industry Canada

Mode: n20

Max EIRP (mW): 83.4

Frequency (MHz)	Chain	Software Setting	99% BW (MHz)	Duty Cycle %	Power <sup>1</sup> dBm	Total Power dBm	Total Power dBm (eirp)	IC limit dBm (eirp)	Max Power (W)	Result		
5180	1	22.5 / 22.5	16.7	98	12.4	15.4	19.0	22.2	0.037	Pass		
	3											
	4											
	2				12.3							
5200	1	22.0/23.5	17.9	98	12.6	15.6	19.2	22.5		0.037	Pass	
	3											
	4											
	2				12.6							
5240	1	22.5/23.0	18.0	98	12.5	15.6	19.2	22.5			0.037	Pass
	3											
	4											
	2				12.7							

Client: Intel Corporation	Job Number: J94914
Model: 7265D2W	T-Log Number: T95472
Contact: Steve Hackett	Project Manager: Christine Krebill
Standard: FCC Part 15.247, 15.407, RSS-210	Project Coordinator: -
	Class: N/A

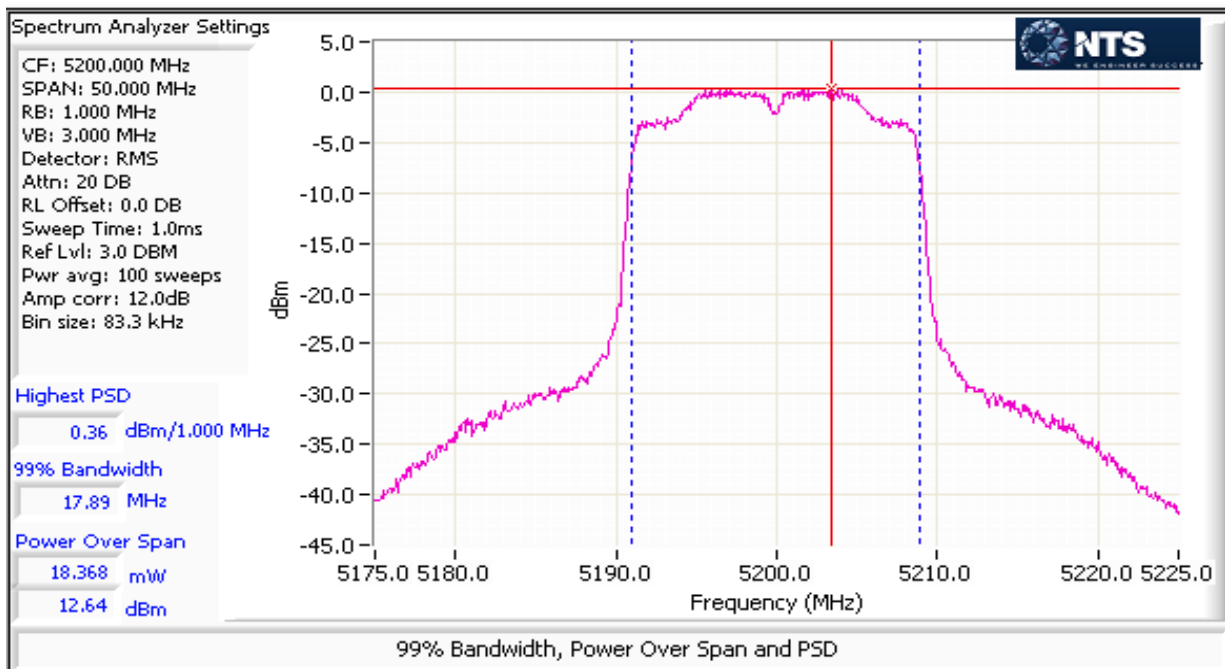
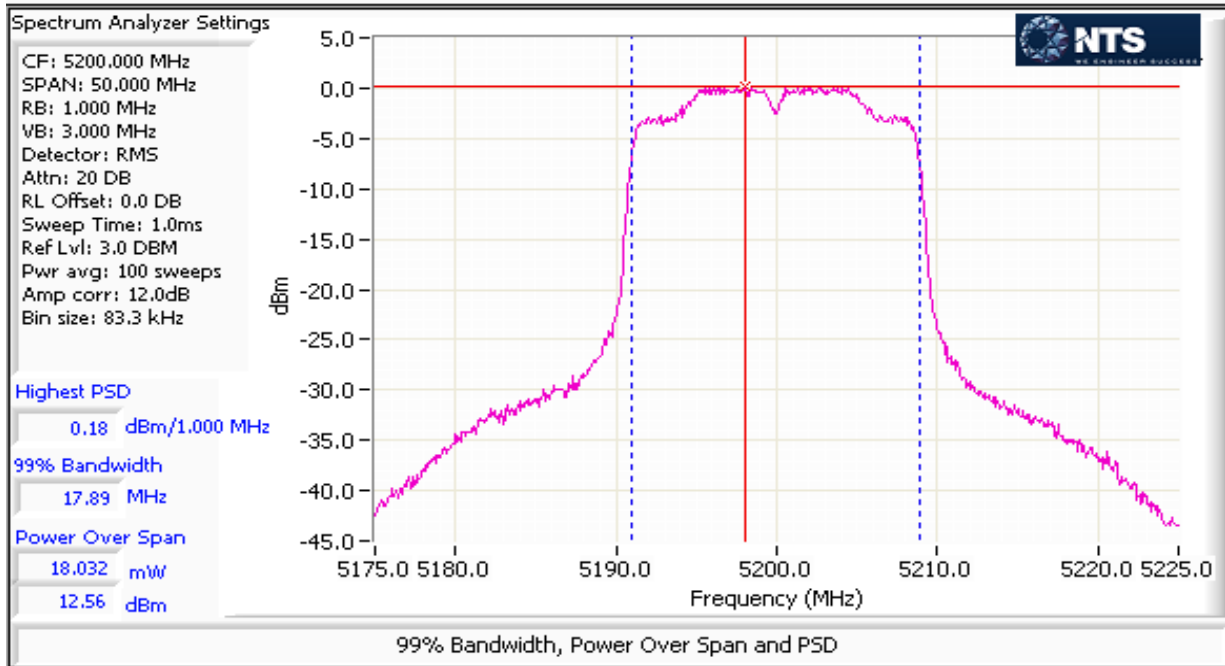



# EMC Test Data

Client: Intel Corporation	Job Number: J94914
Model: 7265D2W	T-Log Number: T95472
	Project Manager: Christine Krebill
Contact: Steve Hackett	Project Coordinator: -
Standard: FCC Part 15.247, 15.407, RSS-210	Class: N/A

5150-5250 PSD - FCC/IC  
Mode: n20

Frequency (MHz)	Chain	Software Setting	99% BW (MHz)	Duty Cycle %	PSD dBm/MHz	Total PSD <sup>1</sup> mW/MHz	Total PSD <sup>1</sup> dBm/MHz	FCC Limit dBm/MHz	IC Limit dBm/MHz	Result
5180	1	22.5 / 22.5	16.7	98	0.1	2.1	3.3	10.4	3.4	Pass
	3									
	4									
	2				0.5					
5200	1	22.0/23.5	17.9	98	0.2	2.1	3.3	10.4	3.4	Pass
	3									
	4									
	2				0.4					
5240	1	22.5/23.0	18.0	98	0.2	2.1	3.3	10.4	3.4	Pass
	3									
	4									
	2				0.3					



# EMC Test Data

Client: Intel Corporation	Job Number: J94914
Model: 7265D2W	T-Log Number: T95472
Contact: Steve Hackett	Project Manager: Christine Krebill
Standard: FCC Part 15.247, 15.407, RSS-210	Project Coordinator: -
	Class: N/A

## MIMO Device - 5150-5250 MHz Band - FCC

Mode: n40

Max EIRP (mW): 186.0

Frequency (MHz)	Chain	Software Setting	26dB BW (MHz)	Duty Cycle %	Power dBm	Total Power <sup>1</sup> mW	dBm	FCC Limit dBm	Max Power (W)	Result
5190	1	19.5/21.0	51.2	97	10.6	23.9	13.8	24.0	0.081	Pass
	3									
	4									
	2				10.7					
5230	1	25.0/27.5	87.2	97	15.8	81.2	19.1	24.0		
	3									
	4									
	2				16.1					

## MIMO Device - 5150-5250 MHz Band - Industry Canada

Mode: n40

Max EIRP (mW): 186.0

Frequency (MHz)	Chain	Software Setting	99% BW (MHz)	Duty Cycle %	Power <sup>1</sup> dBm	Total Power dBm	dBm (eirp)	IC limit dBm (eirp)	Max Power (W)	Result
5190	1	19.5/21.0	36.3	97	10.6	13.8	17.4	23.0	0.081	Pass
	3									
	4									
	2				10.7					
5230	1	25.0/27.5	36.8	97	15.8	19.1	22.7	23.0		
	3									
	4									
	2				16.1					

## 5150-5250 PSD - FCC/IC

Mode: n40

Frequency (MHz)	Chain	Software Setting	99% BW (MHz)	Duty Cycle %	PSD dBm/MHz	Total PSD <sup>1</sup> mW/MHz	dBm/MHz	FCC Limit dBm/MHz	IC Limit dBm/MHz	Result
5190	1	19.5/21.0	36.3	97	-5.1	0.6	-1.9	10.4	3.4	Pass
	3									
	4									
	2				-5.0					
5230	1	25.0/27.5	36.8	97	0.1	2.2	3.4	10.4	3.4	
	3									
	4									
	2				0.4					

Client: Intel Corporation	Job Number: J94914
Model: 7265D2W	T-Log Number: T95472
Contact: Steve Hackett	Project Manager: Christine Krebill
Standard: FCC Part 15.247, 15.407, RSS-210	Project Coordinator: -
	Class: N/A

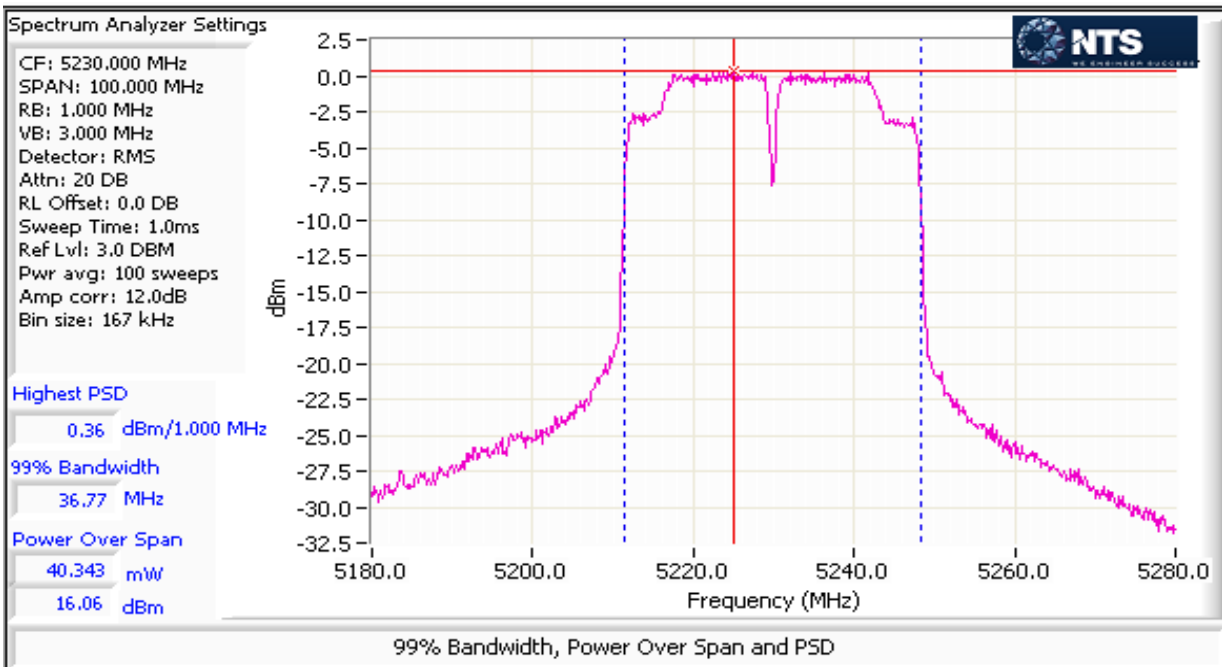
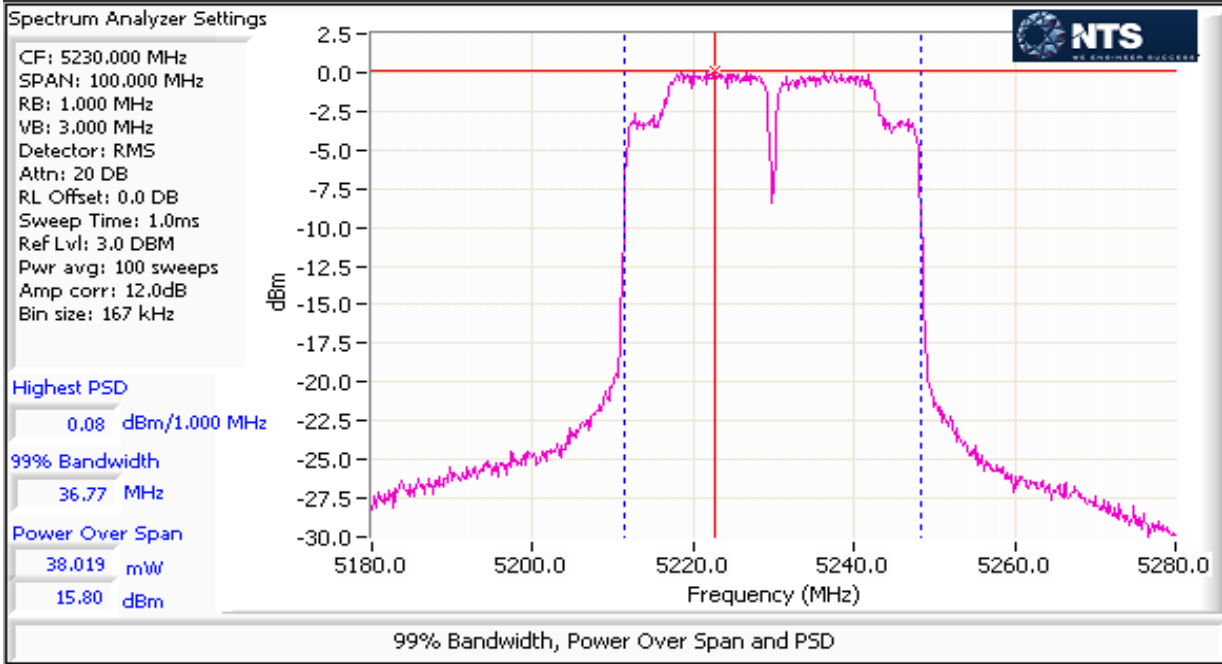



# EMC Test Data

Client: Intel Corporation	Job Number: J94914
Model: 7265D2W	T-Log Number: T95472
Contact: Steve Hackett	Project Manager: Christine Krebill
Standard: FCC Part 15.247, 15.407, RSS-210	Project Coordinator: -
	Class: N/A

## MIMO Device - 5150-5250 MHz Band - FCC

Mode: ac80

Max EIRP (mW): 75.1

Frequency (MHz)	Chain	Software Setting	26dB BW (MHz)	Duty Cycle %	Power dBm	Total Power <sup>1</sup> mW	dBm	FCC Limit dBm	Max Power (W)	Result
5210	1	19.5/20.0	81.3	94	12.0	32.8	15.2	24.0	0.033	Pass
	3									
	4									
	2				11.8					

## MIMO Device - 5150-5250 MHz Band - Industry Canada

Mode: ac80

Max EIRP (mW): 75.1

Frequency (MHz)	Chain	Software Setting	99% BW (MHz)	Duty Cycle %	Power <sup>1</sup> dBm	Total Power dBm	dBm (eirp)	IC limit dBm (eirp)	Max Power (W)	Result
5210	1	19.5/20.0	75.6	94	12.0	15.2	18.8	23.0	0.033	Pass
	3									
	4									
	2				11.8					

## 5150-5250 PSD - FCC/IC

Mode: ac80

Frequency (MHz)	Chain	Software Setting	99% BW (MHz)	Duty Cycle %	PSD dBm/MHz	Total PSD <sup>1</sup> mW/MHz	dBm/MHz	FCC Limit dBm/MHz	IC Limit dBm/MHz	Result
5210	1	19.5/20.0	75.6	94	-6.5	0.5	-3.4	10.4	3.4	Pass
	3									
	4									
	2				-6.7					

Client: Intel Corporation	Job Number: J94914
Model: 7265D2W	T-Log Number: T95472
Contact: Steve Hackett	Project Manager: Christine Krebill
Standard: FCC Part 15.247, 15.407, RSS-210	Project Coordinator: -
	Class: N/A

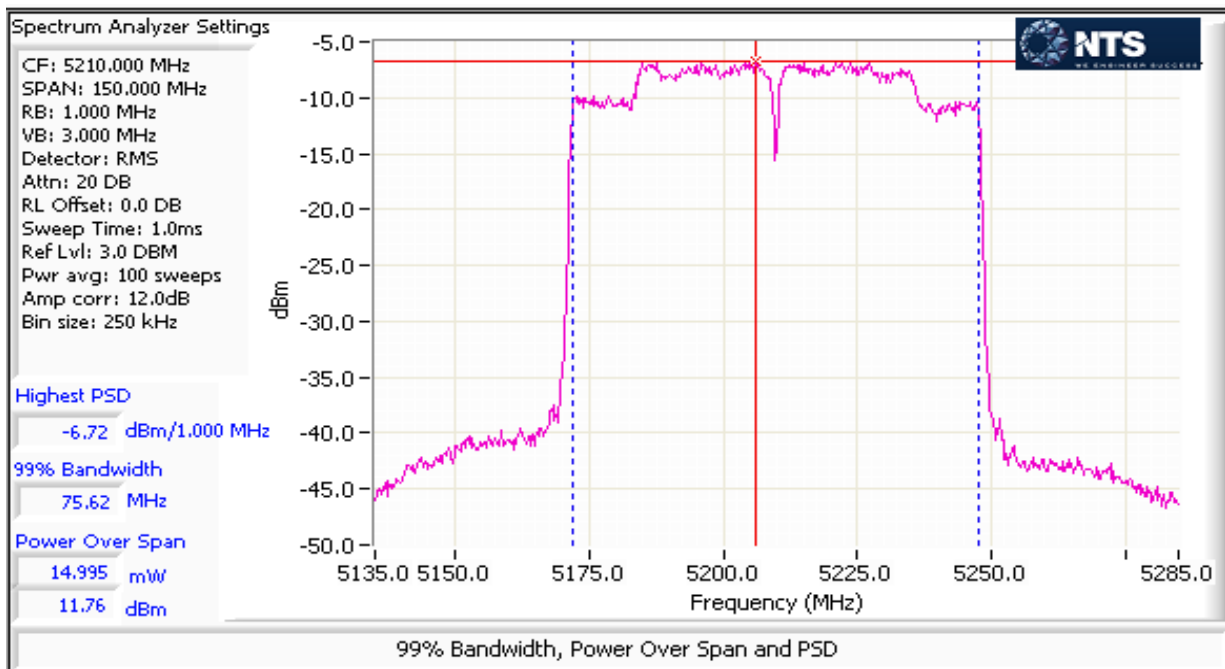
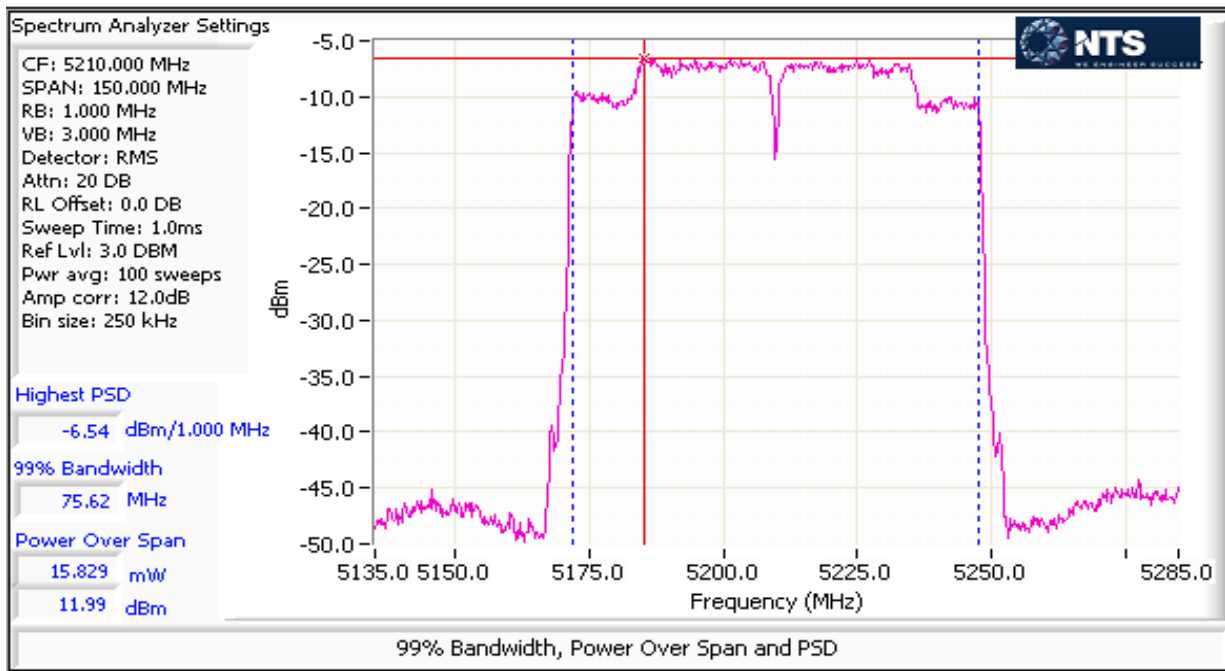



# EMC Test Data

Client: Intel Corporation	Job Number: J94914
Model: 7265D2W	T-Log Number: T95472
Contact: Steve Hackett	Project Manager: Christine Krebill
Standard: FCC Part 15.247, 15.407, RSS-210	Project Coordinator: -
	Class: N/A

## MIMO Device - 5250-5350 MHz Band - FCC

Mode: n20

Max EIRP (mW): 218.0

Frequency (MHz)	Chain	Software Setting	26dB BW (MHz)	Duty Cycle %	Power dBm	Total Power <sup>1</sup> mW	FCC Limit dBm	Max Power (W)	Result	
5260	1	28.5/29.0	43.3	98	16.3	86.3	19.4	0.093	Pass	
	3									
	4									
	2				16.4					
5300	1	29.0/29.5	29.2	98	16.7	93.0	19.7		24.0	Pass
	3									
	4									
	2				16.7					
5320	1	22.5/23.0	29.1	98	12.8	36.8	15.7		24.0	Pass
	3									
	4									
	2				12.5					

## MIMO Device - 5250-5350 MHz Band - Industry Canada

Mode: n20

Max EIRP (mW): 218.0

Frequency (MHz)	Chain	Software Setting	99% BW (MHz)	Duty Cycle %	Power <sup>1</sup> dBm	Total Power dBm	dBm (eirp)	IC limit dBm	Max Power (W)	Result
5260	1	28.5/29.0	18.1	98	16.3	19.4	23.1	23.6	0.093	Pass
	3									
	4									
	2				16.4					
5300	1	29.0/29.5	18.2	98	16.7	19.7	23.4	23.6		Pass
	3									
	4									
	2				16.7					
5320	1	22.5/23.0	18.0	98	12.8	15.7	19.4	23.5		Pass
	3									
	4									
	2				12.5					



Client: Intel Corporation	Job Number: J94914
Model: 7265D2W	T-Log Number: T95472
Contact: Steve Hackett	Project Manager: Christine Krebill
Standard: FCC Part 15.247, 15.407, RSS-210	Project Coordinator: -
	Class: N/A

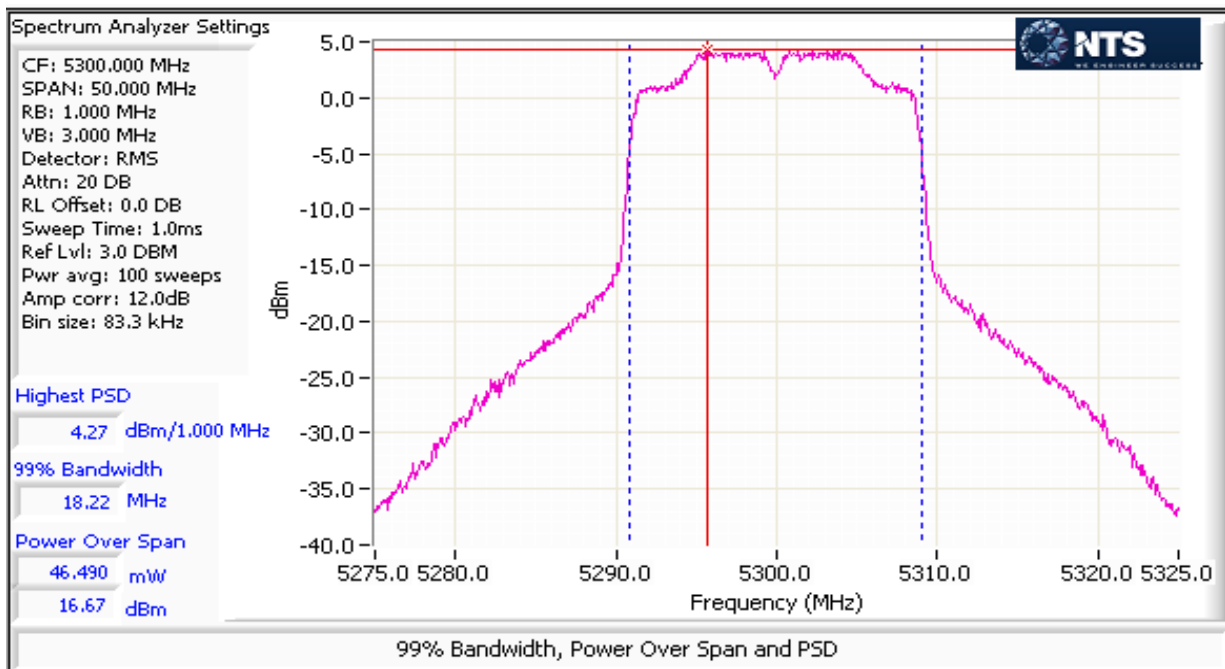
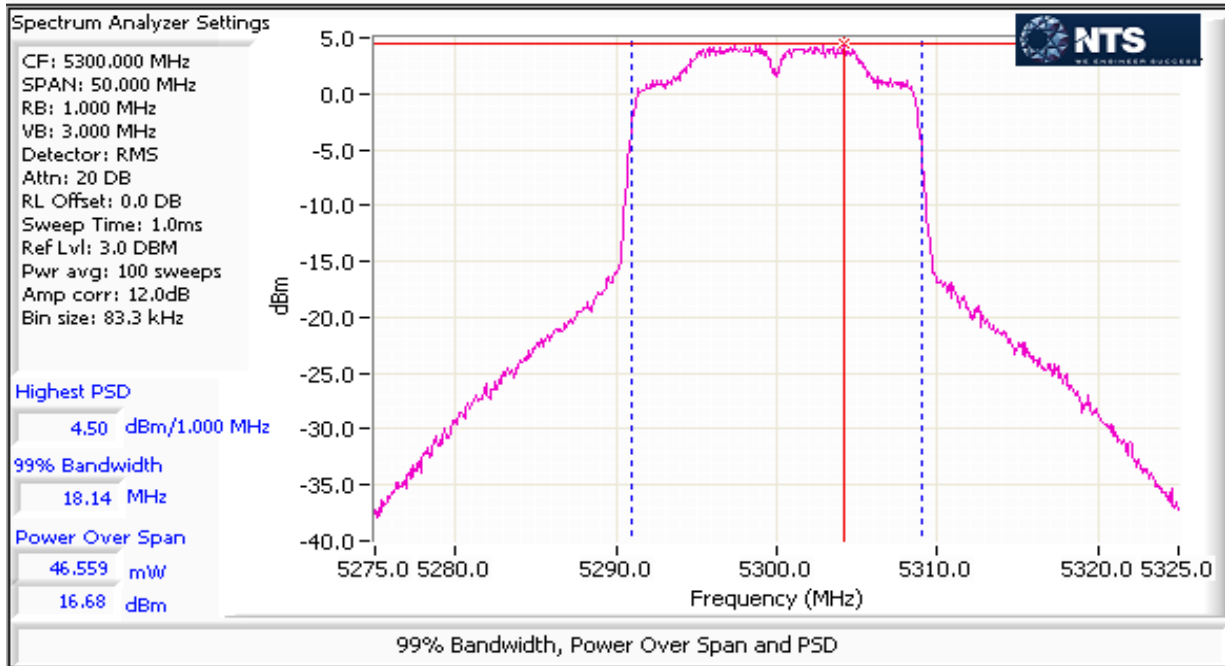



# EMC Test Data

Client: Intel Corporation	Job Number: J94914
Model: 7265D2W	T-Log Number: T95472
	Project Manager: Christine Krebill
Contact: Steve Hackett	Project Coordinator: -
Standard: FCC Part 15.247, 15.407, RSS-210	Class: N/A

5250-5350 PSD - FCC/IC  
Mode: n20

Frequency (MHz)	Chain	Software Setting	99% BW (MHz)	Duty Cycle %	PSD dBm/MHz	Total PSD <sup>1</sup> mW/MHz	Total PSD <sup>1</sup> dBm/MHz	FCC Limit dBm/MHz	IC Limit dBm/MHz	Result
5260	1	28.5/29.0	18.1	98	4.0	5.1	7.1	10.3	11.0	Pass
	3									
	4									
	2				4.1					
5300	1	29.0/29.5	18.2	98	4.5	5.5	7.4	10.3	11.0	Pass
	3									
	4									
	2				4.3					
5320	1	22.5/23.0	18.0	98	0.5	2.2	3.4	10.3	11.0	Pass
	3									
	4									
	2				0.3					



# EMC Test Data

Client:	Intel Corporation	Job Number:	J94914
Model:	7265D2W	T-Log Number:	T95472
Contact:	Steve Hackett	Project Manager:	Christine Krebill
Standard:	FCC Part 15.247, 15.407, RSS-210	Project Coordinator:	-
		Class:	N/A

## MIMO Device - 5250-5350 MHz Band - FCC

Mode: n40

Max EIRP (mW): 226.9

Frequency (MHz)	Chain	Software Setting	26dB BW (MHz)	Duty Cycle %	Power dBm	Total Power <sup>1</sup> mW	dBm	FCC Limit dBm	Max Power (W)	Result
5270	1	28.0/29.0	88.8	97	16.7	96.8	19.9	24.0	0.097	Pass
	3									
	4									
	2				16.7					
5310	1	22.5/22.5	48	97	12.4	34.9	15.4	24.0		
	3									
	4									
	2				12.2					

## MIMO Device - 5250-5350 MHz Band - Industry Canada

Mode: n40

Max EIRP (mW): 226.9

Frequency (MHz)	Chain	Software Setting	99% BW (MHz)	Duty Cycle %	Power <sup>1</sup> dBm	Total Power dBm	dBm (eirp)	IC limit dBm	Max Power (W)	Result
5270	1	28.0/29.0	36.6	97	16.7	19.9	23.6	24.0	0.097	Pass
	3									
	4									
	2				16.7					
5310	1	22.5/22.5	36.4	97	12.4	15.4	19.1	24.0		
	3									
	4									
	2				12.2					

## MIMO Device 5250-5350 PSD - FCC/IC

Mode: n40

Frequency (MHz)	Chain	Software Setting	99% BW (MHz)	Duty Cycle %	PSD dBm/MHz	Total PSD <sup>1</sup> mW/MHz	dBm/MHz	FCC Limit dBm/MHz	IC Limit dBm/MHz	Result
5270	1	28.0/29.0	36.6	97	1.1	2.7	4.2	10.3	11.0	Pass
	3									
	4									
	2				1.0					
5310	1	22.5/22.5	36.4	97	-3.3	0.9	-0.2	10.3	11.0	
	3									
	4									
	2				-3.5					

Client: Intel Corporation	Job Number: J94914
Model: 7265D2W	T-Log Number: T95472
Contact: Steve Hackett	Project Manager: Christine Krebill
Standard: FCC Part 15.247, 15.407, RSS-210	Project Coordinator: -
	Class: N/A

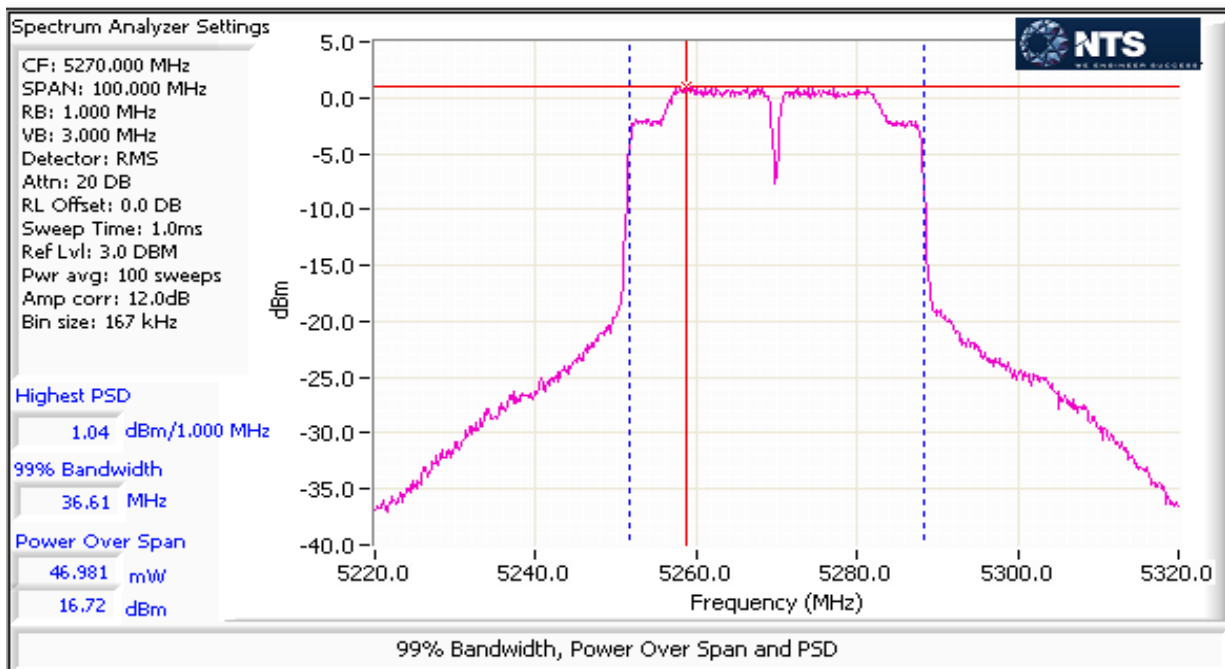
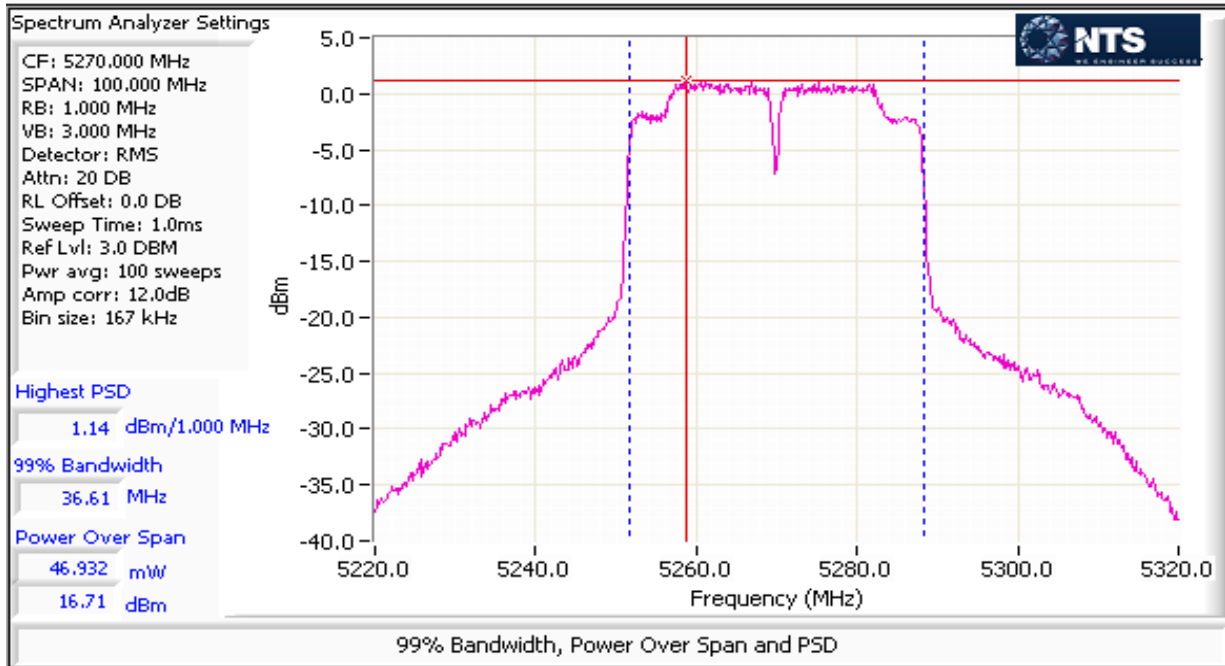



# EMC Test Data

Client:	Intel Corporation	Job Number:	J94914
Model:	7265D2W	T-Log Number:	T95472
Contact:	Steve Hackett	Project Manager:	Christine Krebill
Standard:	FCC Part 15.247, 15.407, RSS-210	Project Coordinator:	-
		Class:	N/A

## MIMO Device - 5250-5350 MHz Band - FCC

Mode: ac80

Max EIRP (mW): 59.4

Frequency (MHz)	Chain	Software Setting	26dB BW (MHz)	Duty Cycle %	Power dBm	Total Power <sup>1</sup> mW	dBm	FCC Limit dBm	Max Power (W)	Result
5290	1	20.5/20.5	123.8	94	11.3	25.3	14.0	24.0	0.025	Pass
	3									
	4									
	2				10.2					

## MIMO Device - 5250-5350 MHz Band - Industry Canada

Mode: ac80

Max EIRP (mW): 59.4

Frequency (MHz)	Chain	Software Setting	99% BW (MHz)	Duty Cycle %	Power <sup>1</sup> dBm	Total Power dBm	dBm (eirp)	IC limit dBm (eirp)	Max Power (W)	Result
5290	1	20.5/20.5	75.6	94	11.3	14.0	17.7	23.0	0.025	Pass
	3									
	4									
	2				10.2					

## MIMO Device 5250-5350 PSD - FCC/IC

Mode: ac80

Frequency (MHz)	Chain	Software Setting	99% BW (MHz)	Duty Cycle %	PSD dBm/MHz	Total PSD <sup>1</sup> mW/MHz	dBm/MHz	FCC Limit dBm/MHz	IC Limit dBm/MHz	Result
5290	1	20.5/20.5	75.6	94	-7.0	0.4	-4.2	10.3	11.0	Pass
	3									
	4									
	2				-8.1					

Client: Intel Corporation	Job Number: J94914
Model: 7265D2W	T-Log Number: T95472
Contact: Steve Hackett	Project Manager: Christine Krebill
Standard: FCC Part 15.247, 15.407, RSS-210	Project Coordinator: -
	Class: N/A

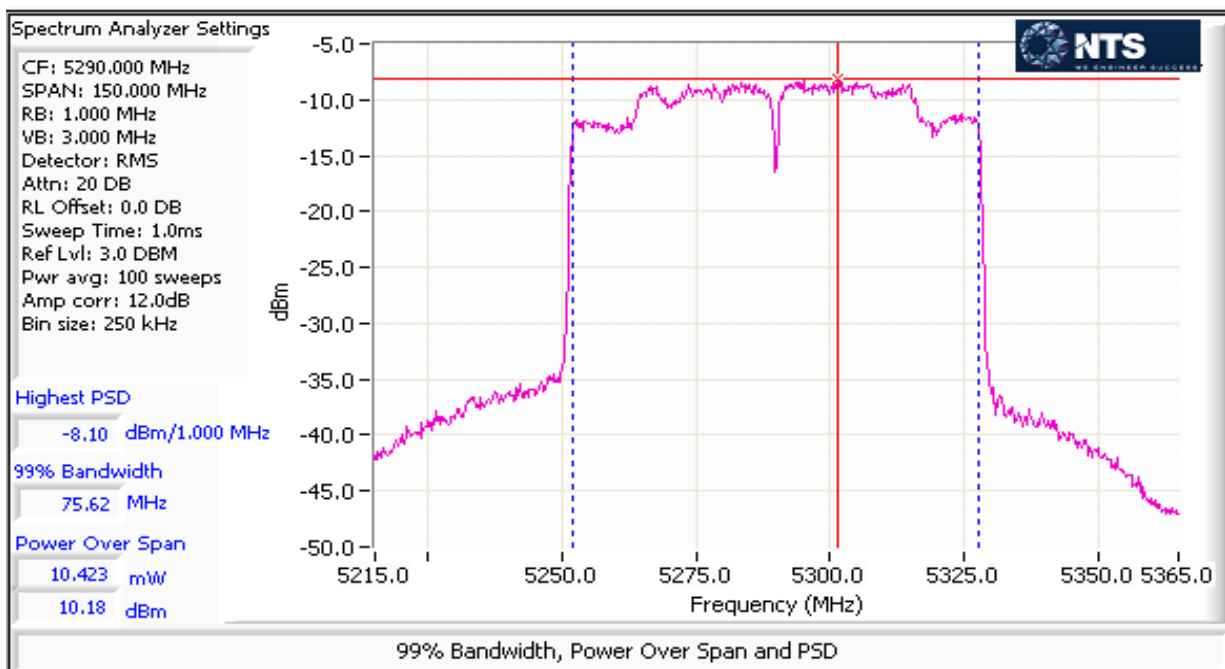
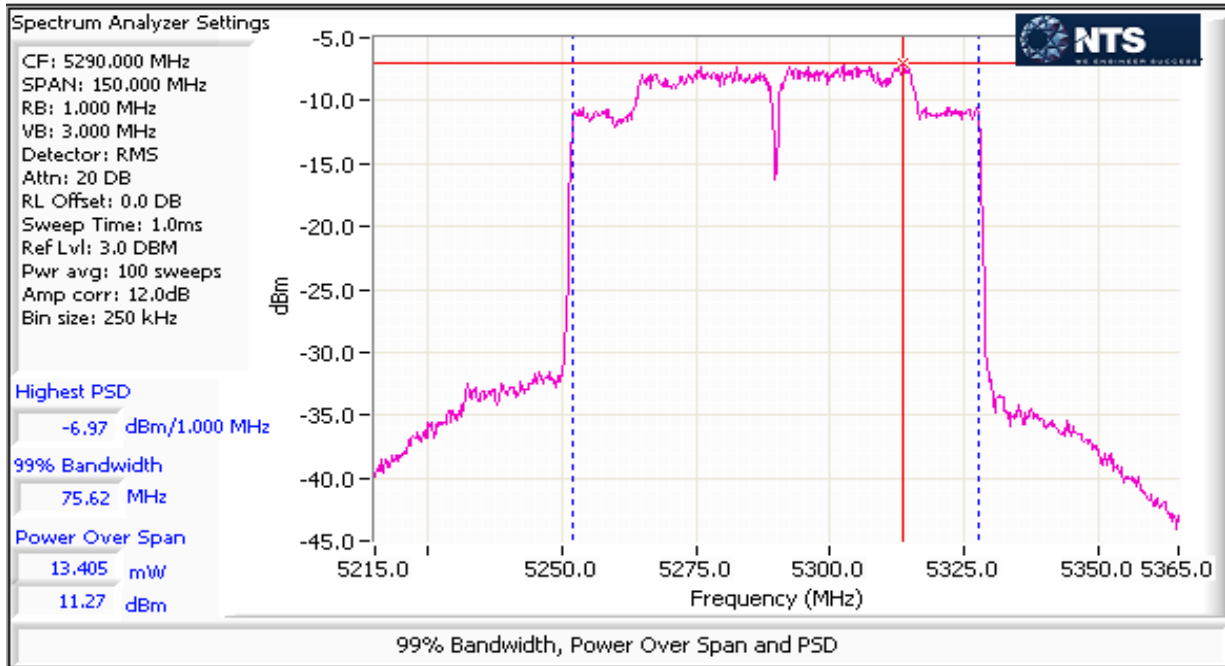



# EMC Test Data

Client: Intel Corporation	Job Number: J94914
Model: 7265D2W	T-Log Number: T95472
	Project Manager: Christine Krebill
Contact: Steve Hackett	Project Coordinator: -
Standard: FCC Part 15.247, 15.407, RSS-210	Class: N/A

MIMO Device - 5470-5725 MHz Band - FCC

Mode: n20

Max EIRP (mW): 286.8

Frequency (MHz)	Chain	Software Setting	26dB BW (MHz)	Duty Cycle %	Power dBm	Total Power <sup>1</sup> mW	FCC Limit dBm	Max Power (W)	Result		
5500	1	22.5/23.0	22.5	98	12.0	31.4	15.0	0.095	Pass		
	3										
	4										
	2				11.9						
5580	1	31.0/32.0	31.8	98	16.7	95.0	19.8		0.095	Pass	
	3										
	4										
	2				16.8						
5700	1	23.0/24.0	23.2	98	11.2	27.3	14.4			0.095	Pass
	3										
	4										
	2				11.5						
802.11ac 20MHz											
UNII-2ext											
5720	1	32.5/33.0	21.8	98	16.2	82.6	19.2	0.095			Pass
	3										
	4										
	2				16.2						
UNII-3											
5720	1	32.5/33.0	10.9	98	9.0	16.0	12.1		0.095		Pass
	3										
	4										
	2				9.1						



# EMC Test Data

Client: Intel Corporation	Job Number: J94914
Model: 7265D2W	T-Log Number: T95472
	Project Manager: Christine Krebill
Contact: Steve Hackett	Project Coordinator: -
Standard: FCC Part 15.247, 15.407, RSS-210	Class: N/A

MIMO Device - 5470-5725 MHz Band - Industry Canada

Mode: n20

Max EIRP (mW): 286.8

Frequency (MHz)	Chain	Software Setting	99% BW (MHz)	Duty Cycle %	Power <sup>1</sup> dBm	Total Power dBm	dBm (eirp)	IC limit dBm	Max Power (W)	Result		
5500	1	22.5/23.0	17.9	98	12.0	15.0	19.8	23.5	0.095	Pass		
	3											
	4											
	2				11.9							
5580	1	31.0/32.0	18.2	98	16.7	19.8	24.6	23.6		0.095	Pass	
	3											
	4											
	2				16.8							
5700	1	23.0/24.0	17.9	98	11.2	14.4	19.2	23.5			0.095	Pass
	3											
	4											
	2				11.5							
802.11ac 20MHz												
UNII-2ext												
5720	1	32.5/33.0	14.2	98	16.2	19.2	24.0	22.5	0.095			Pass
	3											
	4											
	2				16.2							
UNII-3												
5720	1	32.5/33.0	9.0	98	9.0	12.1	16.9	20.5		0.095		Pass
	3											
	4											
	2				9.1							



Client: Intel Corporation	Job Number: J94914
Model: 7265D2W	T-Log Number: T95472
Contact: Steve Hackett	Project Manager: Christine Krebill
Standard: FCC Part 15.247, 15.407, RSS-210	Project Coordinator: -
	Class: N/A

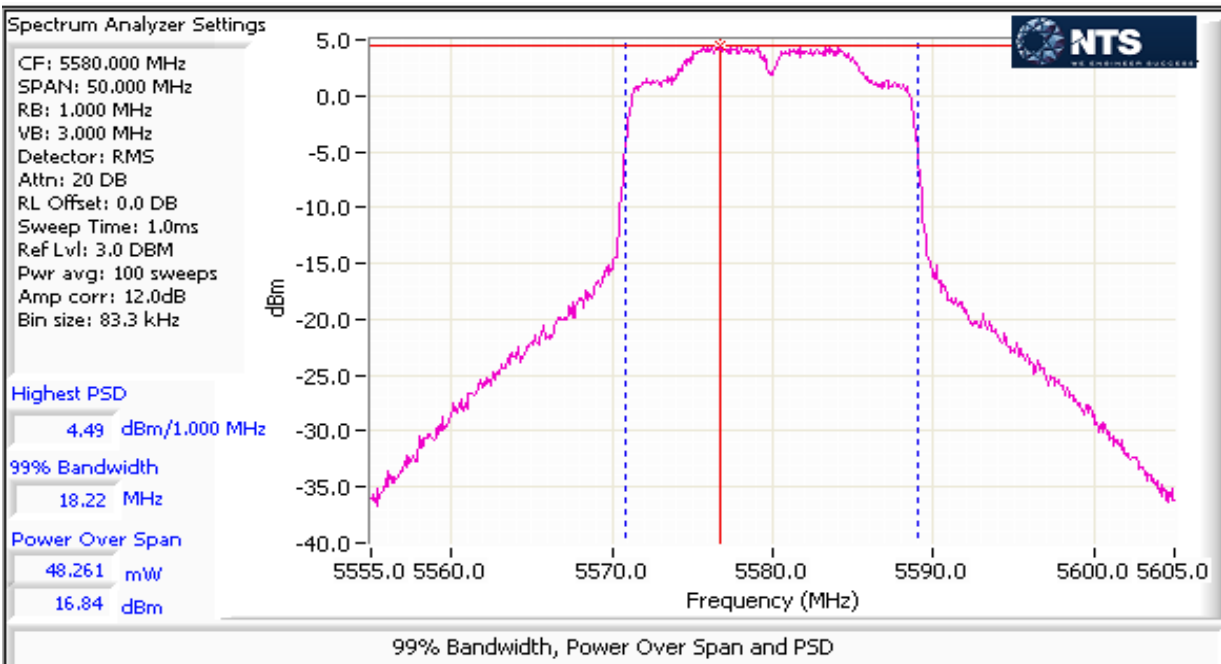
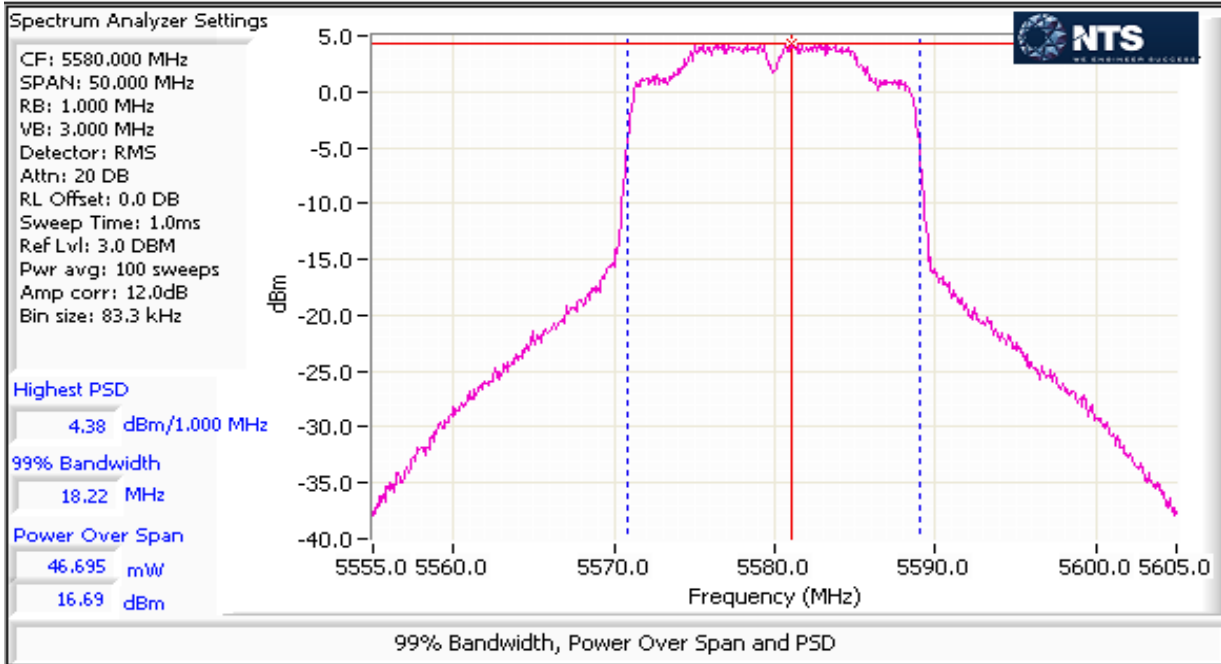



# EMC Test Data

Client: Intel Corporation	Job Number: J94914
Model: 7265D2W	T-Log Number: T95472
Contact: Steve Hackett	Project Manager: Christine Krebill
Standard: FCC Part 15.247, 15.407, RSS-210	Project Coordinator: -
	Class: N/A

5470-5725 PSD - FCC/IC  
Mode: n20

Frequency (MHz)	Chain	Software Setting	99% BW (MHz)	Duty Cycle %	PSD dBm/MHz	Total PSD <sup>1</sup> mW/MHz	Total PSD <sup>1</sup> dBm/MHz	FCC Limit dBm/MHz	IC Limit dBm/MHz	Result
5500	1	22.5/23.0	17.9	98	-0.3	1.8	2.6	9.2	11.0	Pass
	3									
	4									
	2									
5580	1	31.0/32.0	18.2	98	4.4	5.6	7.4	9.2	11.0	Pass
	3									
	4									
	2									
5700	1	23.0/24.0	17.9	98	-1.2	1.6	2.0	9.2	11.0	Pass
	3									
	4									
	2									

802.11ac 20MHz

UNII-2ext

5720	1	32.5/33.0	14.2	98	4.8	6.0	7.8	9.2	11.0	Pass
	3									
	4									
	2									

UNII-3

5720	1	32.5/33.0	8.1	98	3.5	4.6	6.6	9.2	10.3	Pass
	3									
	4									
	2									



# EMC Test Data

Client: Intel Corporation	Job Number: J94914
Model: 7265D2W	T-Log Number: T95472
Contact: Steve Hackett	Project Manager: Christine Krebill
Standard: FCC Part 15.247, 15.407, RSS-210	Project Coordinator: -
	Class: N/A

**MIMO Device - 5470-5725 MHz Band - FCC**

Mode: n40

Max EIRP (mW): 318.2

Frequency (MHz)	Chain	Software Setting	26dB BW (MHz)	Duty Cycle %	Power dBm	Total Power <sup>1</sup> mW	FCC Limit dBm	Max Power (W)	Result		
5510	1	22.0 / 23.0	41.8	97	11.9	32.7	15.1	0.105	Pass		
	3										
	4										
	2				12.1						
5550	1	30.0 / 31.0	86.0	97	17.1	105.4	20.2		0.105	Pass	
	3										
	4										
	2				17.1						
5670	1	30.5 / 31.5	85.2	97	16.7	96.1	19.8			0.105	Pass
	3										
	4										
	2				16.7						
<b>802.11ac 40MHz</b>											
<b>UNII-2ext</b>											
5710	1	31.5 / 31.5	51.3	97	16.4	90.0	19.5	0.105			Pass
	3										
	4										
	2				16.4						
<b>UNII-3</b>											
5710	1	31.5 / 31.5	18.5	97	4.5	5.6	7.5		0.105		Pass
	3										
	4										
	2				4.2						



# EMC Test Data

Client: Intel Corporation	Job Number: J94914
Model: 7265D2W	T-Log Number: T95472
Contact: Steve Hackett	Project Manager: Christine Krebill
Standard: FCC Part 15.247, 15.407, RSS-210	Project Coordinator: -
	Class: N/A

MIMO Device - 5470-5725 MHz Band - Industry Canada

Mode: n40

Max EIRP (mW): 318.2

Frequency (MHz)	Chain	Software Setting	99% BW (MHz)	Duty Cycle %	Power <sup>1</sup> dBm	Total Power dBm	dBm (eirp)	IC limit dBm	Max Power (W)	Result				
5510	1	22.0 / 23.0	36.3	97	11.9	15.1	19.9	24.0	0.105	Pass				
	3													
	4													
	2				12.1									
5550	1	30.0 / 31.0	36.4	97	17.1	20.2	25.0	24.0			0.105	Pass		
	3													
	4													
	2				17.1									
5670	1	30.5 / 31.5	36.4	97	16.7	19.8	24.6	24.0					0.105	Pass
	3													
	4													
	2				16.7									
802.11ac 40MHz														
UNII-2ext														
5710	1	31.5 / 31.5	33.1	97	16.4	19.5	24.3	24.0	0.105	Pass				
	3													
	4													
	2				16.4									
UNII-3														
5710	1	31.5 / 31.5	11.7	97	4.5	7.5	12.3	21.7			0.105	Pass		
	3													
	4													
	2				4.2									

Client: Intel Corporation	Job Number: J94914
Model: 7265D2W	T-Log Number: T95472
Contact: Steve Hackett	Project Manager: Christine Krebill
Standard: FCC Part 15.247, 15.407, RSS-210	Project Coordinator: -
	Class: N/A

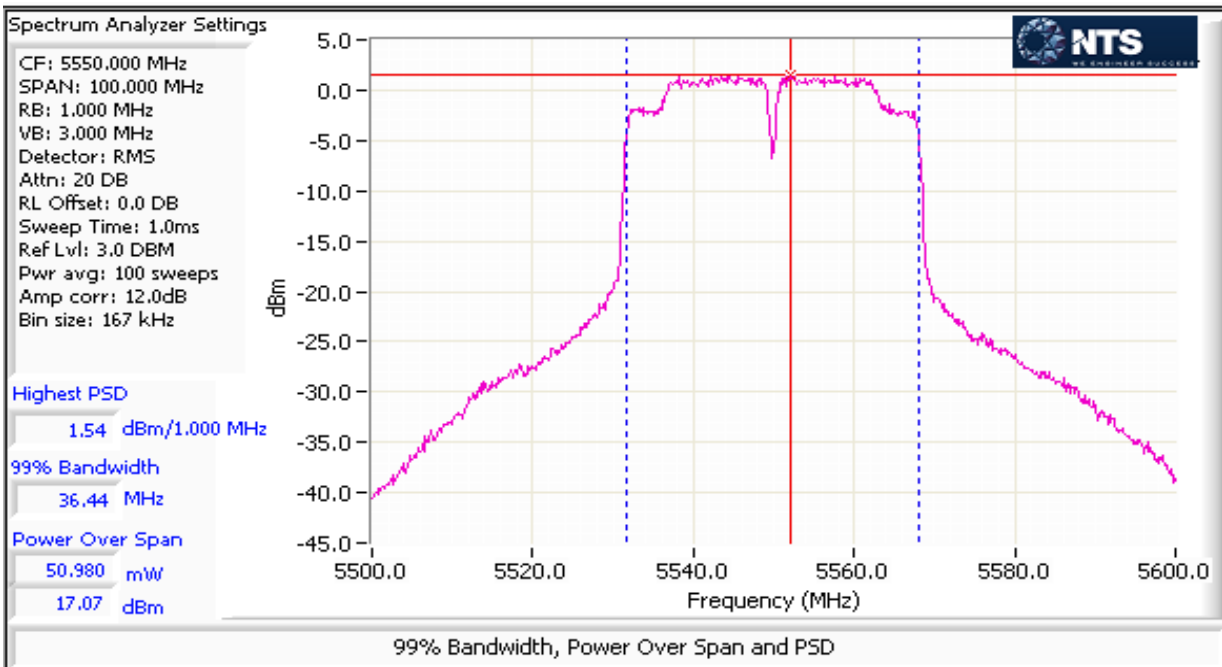
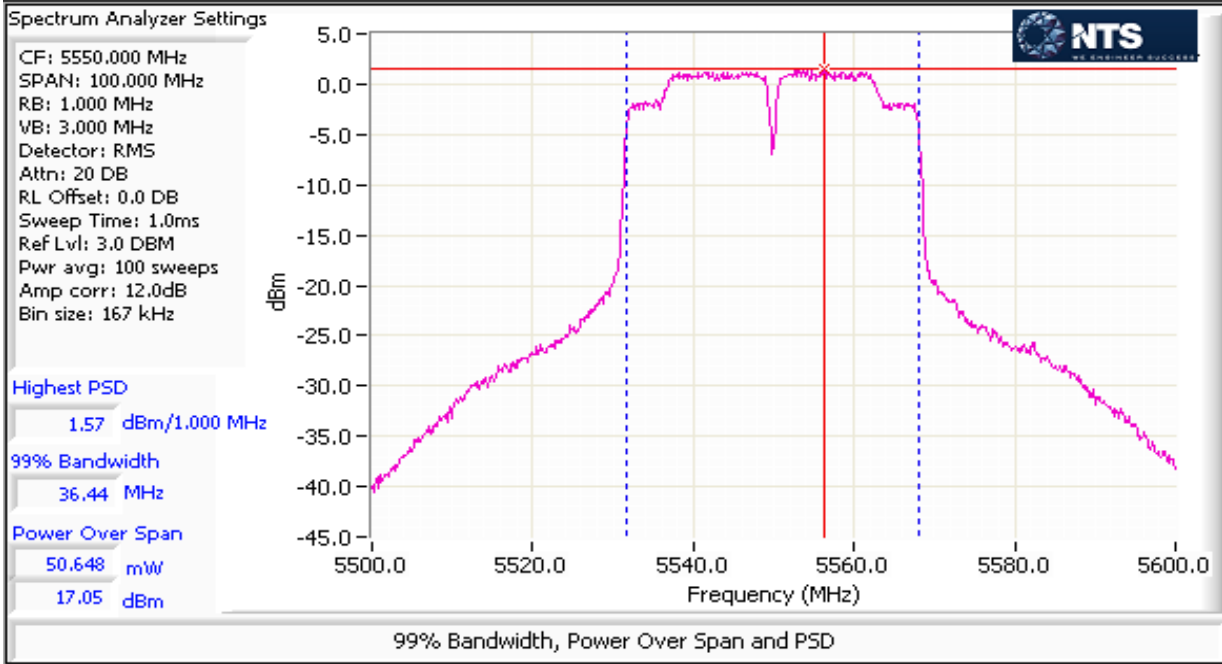



# EMC Test Data

Client: Intel Corporation	Job Number: J94914
Model: 7265D2W	T-Log Number: T95472
Contact: Steve Hackett	Project Manager: Christine Krebill
Standard: FCC Part 15.247, 15.407, RSS-210	Project Coordinator: -
	Class: N/A

MIMO Device 5470-5725 PSD - FCC/IC  
Mode: n40

Frequency (MHz)	Chain	Software Setting	99% BW (MHz)	Duty Cycle %	PSD dBm/MHz	Total PSD <sup>1</sup> mW/MHz	Total PSD <sup>1</sup> dBm/MHz	FCC Limit dBm/MHz	IC Limit dBm/MHz	Result
5510	1	22.0 / 23.0	36.3	97	-3.7	0.9	-0.5	9.2	11.0	Pass
	3									
	4									
	2									
5550	1	30.0 / 31.0	36.4	97	1.6	2.9	4.7	9.2	11.0	Pass
	3									
	4									
	2									
5670	1	30.5 / 31.5	36.4	97	1.3	2.7	4.4	9.2	11.0	Pass
	3									
	4									
	2									

802.11ac 40MHz

UNII-2ext

5710	1	31.0 / 31.5	33.1	97	1.2	2.7	4.4	9.2	11.0	Pass
	3									
	4									
	2									

UNII-3

5710	1	31.0 / 31.5	11.7	97	-1.7	1.4	1.3	9.2	9.5	Pass
	3									
	4									
	2									



# EMC Test Data

Client: Intel Corporation	Job Number: J94914
Model: 7265D2W	T-Log Number: T95472
Contact: Steve Hackett	Project Manager: Christine Krebill
Standard: FCC Part 15.247, 15.407, RSS-210	Project Coordinator: -
	Class: N/A

**MIMO Device - 5470-5725 MHz Band - FCC**

Mode: ac80

Max EIRP (mW): 319.8

Frequency (MHz)	Chain	Software Setting	26dB BW (MHz)	Duty Cycle %	Power dBm	Total Power <sup>1</sup> mW	FCC Limit dBm	Max Power (W)	Result	
5530	1	20.0 / 20.0	81.0	94	11.6	27.6	14.4	0.106	Pass	
	3									
	4									
	2				10.7					
5610	1	30.5 / 31.0	142.3	94	17.0	105.9	20.2		Pass	
	3									
	4									
	2				16.9					
<b>802.11ac 80MHz UNII-2ext</b>										
5690	1	31.5/32.5	105.3	94	16.3	90.7	19.6		Pass	
	3									
	4									
	2				16.3					
<b>UNII-3</b>										
5690	1	31.5/32.5	37.5	94	1.0	2.7	4.3	Pass		
	3									
	4									
	2				1.2					



# EMC Test Data

Client: Intel Corporation	Job Number: J94914
Model: 7265D2W	T-Log Number: T95472
Contact: Steve Hackett	Project Manager: Christine Krebill
Standard: FCC Part 15.247, 15.407, RSS-210	Project Coordinator: -
	Class: N/A

**MIMO Device - 5470-5725 MHz Band - Industry Canada**

Mode: ac80

Max EIRP (mW): 319.8

Frequency (MHz)	Chain	Software Setting	99% BW (MHz)	Duty Cycle %	Power <sup>1</sup> dBm	Total Power dBm	Total Power dBm (eirp)	IC limit dBm (eirp)	Max Power (W)	Result	
5530	1	20.0 / 20.0	75.6	94	11.6	14.4	19.2	24.0	0.106	Pass	
	3										
	4										
	2				10.7						
5610	1	30.5 / 31.0	75.6	94	17.0	20.2	25.0	24.0		Pass	
	3										
	4										
	2				16.9						
<b>802.11ac 80MHz UNII-2ext</b>											
5690	1	31.5/32.5	72.9	94	16.3	19.6	24.4	24.0		Pass	
	3										
	4										
	2				16.3						
<b>UNII-3</b>											
5690	1	31.5/32.5	36.1	94	1.0	4.3	9.1	24.0	Pass		
	3										
	4										
	2				1.2						



Client: Intel Corporation	Job Number: J94914
Model: 7265D2W	T-Log Number: T95472
Contact: Steve Hackett	Project Manager: Christine Krebill
Standard: FCC Part 15.247, 15.407, RSS-210	Project Coordinator: -
	Class: N/A

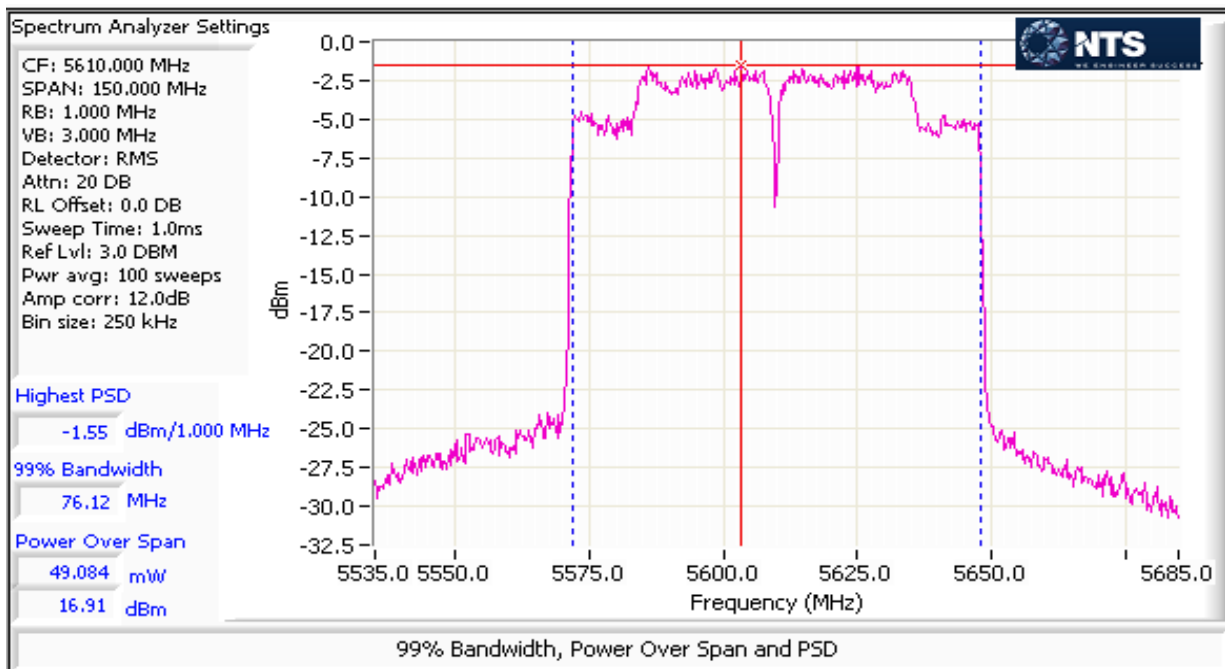
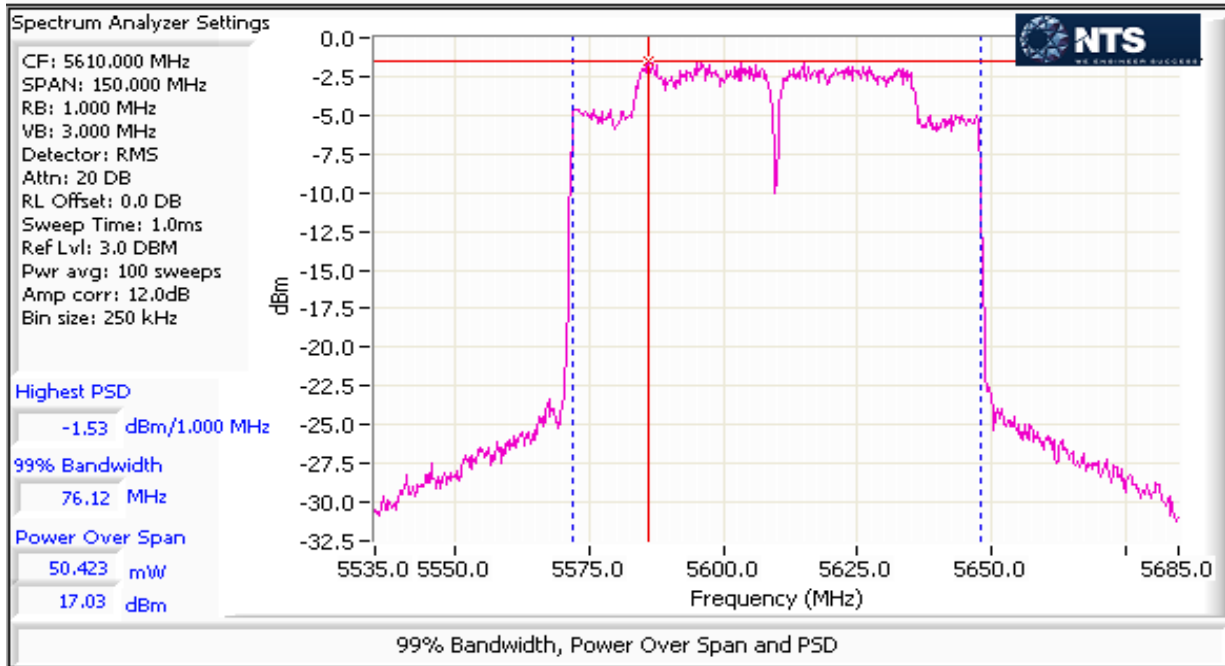



# EMC Test Data

Client: Intel Corporation	Job Number: J94914
Model: 7265D2W	T-Log Number: T95472
Contact: Steve Hackett	Project Manager: Christine Krebill
Standard: FCC Part 15.247, 15.407, RSS-210	Project Coordinator: -
	Class: N/A

MIMO Device 5470-5725 PSD - FCC/IC (5610 MHz is for FCC only)  
 Mode: ac80

Frequency (MHz)	Chain	Software Setting	99% BW (MHz)	Duty Cycle %	PSD dBm/MHz	Total PSD <sup>1</sup> mW/MHz	Total PSD <sup>1</sup> dBm/MHz	FCC Limit dBm/MHz	IC Limit dBm/MHz	Result
5530	1	20.0 / 20.0	75.62	94	-6.8	0.4	-4.0	9.2	11.0	Pass
	3									
	4									
	2									
5610	1	30.5 / 31.0	76.12	94	-1.5	1.5	1.7	9.2	11.0	Pass
	3									
	4									
	2									

802.11ac 80MHz

UNII-2ext

5690	1	31.5/32.5	72.85	94	-1.9	1.4	1.5	9.2	11.0	Pass
	3									
	4									
	2									

UNII-3

5690	1	31.5/32.5	36.14	94	-5.5	0.6	-2.1	9.2	4.9	Pass
	3									
	4									
	2									



# EMC Test Data

Client:	Intel Corporation	Job Number:	J94914
Model:	7265D2W	T-Log Number:	T95472
Contact:	Steve Hackett	Project Manager:	Christine Krebill
Standard:	FCC Part 15.247, 15.407, RSS-210	Project Coordinator:	-
		Class:	N/A

## MIMO Device - 5725-5850 MHz Band - FCC Only

Mode: n20

Max EIRP (mW): 233.4

Frequency (MHz)	Chain	Software Setting		Duty Cycle %	Power dBm	Total Power <sup>1</sup>		FCC Limit dBm	Max Power (W)	Result
						mW	dBm			
5745	1	32.0 / 31.5		98	16.6	85.1	19.3	30.0	0.100	Pass
	3									
	4									
	2				16.0					
5785	1	32.5 / 32.5		98	17.0	99.5	20.0	30.0		Pass
	3									
	4									
	2				17.0					
5825	1	33.0 / 33.0		98	16.9	95.0	19.8	30.0		Pass
	3									
	4									
	2				16.7					

## 5725-5850 PSD - FCC

Mode: n20

Frequency (MHz)	Chain	Software Setting		Duty Cycle %	PSD dBm/MHz	Total PSD <sup>1</sup>		FCC Limit dBm/MHz	Result
						mW/MHz	dBm/MHz		
5745	1	32.0 / 31.5		98	4.6	5.3	7.3	28.0	Pass
	3								
	4								
	2				3.8				
5785	1	32.5 / 32.5		98	4.9	6.3	8.0	28.0	Pass
	3								
	4								
	2				5.1				
5825	1	33.0 / 33.0		98	4.6	5.6	7.4	28.0	Pass
	3								
	4								
	2				4.3				

Client: Intel Corporation	Job Number: J94914
Model: 7265D2W	T-Log Number: T95472
Contact: Steve Hackett	Project Manager: Christine Krebill
Standard: FCC Part 15.247, 15.407, RSS-210	Project Coordinator: -
	Class: N/A

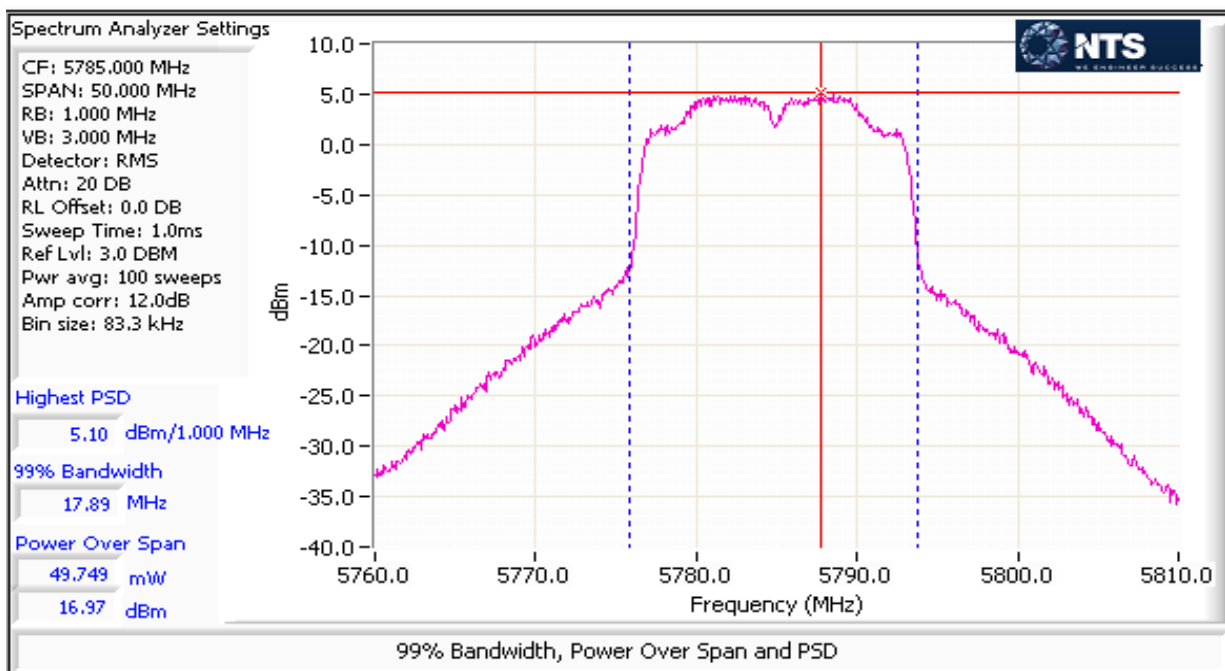
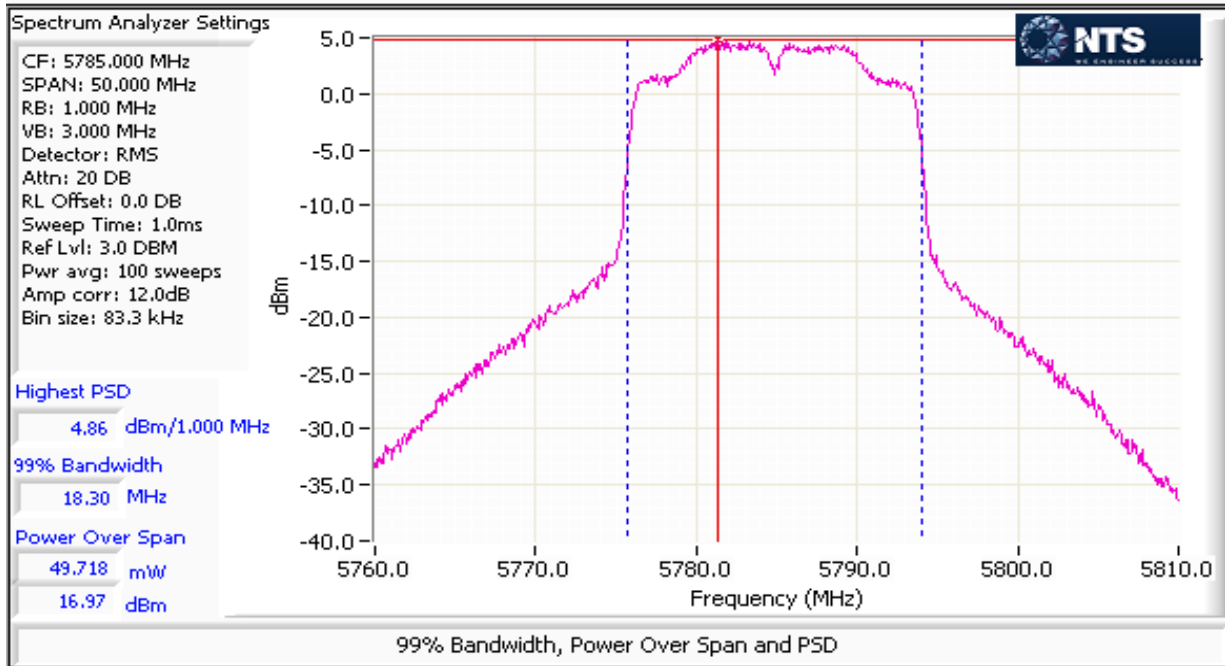



# EMC Test Data

Client:	Intel Corporation	Job Number:	J94914
Model:	7265D2W	T-Log Number:	T95472
Contact:	Steve Hackett	Project Manager:	Christine Krebill
Standard:	FCC Part 15.247, 15.407, RSS-210	Project Coordinator:	-
		Class:	N/A

## MIMO Device - 5725-5850 MHz Band - FCC Only

Mode: n40

Max EIRP (mW): 320.7

Frequency (MHz)	Chain	Software Setting		Duty Cycle %	Power dBm	Total Power <sup>1</sup> mW	dBm	FCC Limit dBm	Max Power (W)	Result
5755	1	24.5 / 23.5		97	12.4	34.1	15.3	30.0	0.101	Pass
	3									
	4									
	2				12.0					
5795	1	33.5 / 34.0		97	17.1	101.4	20.1	30.0		
	3									
	4									
	2				16.8					

## 5725-5850 PSD - FCC Only

Mode: n40

Frequency (MHz)	Chain	Software Setting		Duty Cycle %	PSD dBm/MHz	Total PSD <sup>1</sup> mW/MHz	dBm/MHz	FCC Limit dBm/MHz	Result
5755	1	24.5 / 23.5		97	-3.2	0.9	-0.2	28.0	Pass
	3								
	4								
	2				-3.6				
5795	1	33.5 / 34.0		97	1.5	2.8	4.4	28.0	Pass
	3								
	4								
	2				1.1				

Client: Intel Corporation	Job Number: J94914
Model: 7265D2W	T-Log Number: T95472
Contact: Steve Hackett	Project Manager: Christine Krebill
Standard: FCC Part 15.247, 15.407, RSS-210	Project Coordinator: -
	Class: N/A

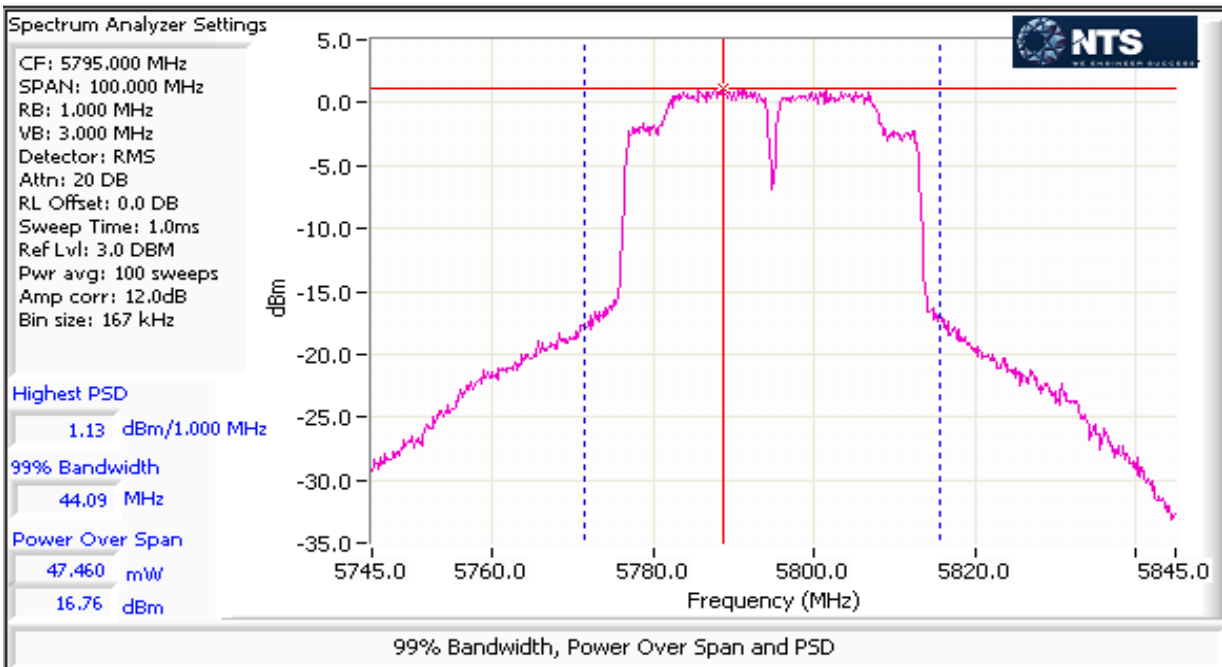
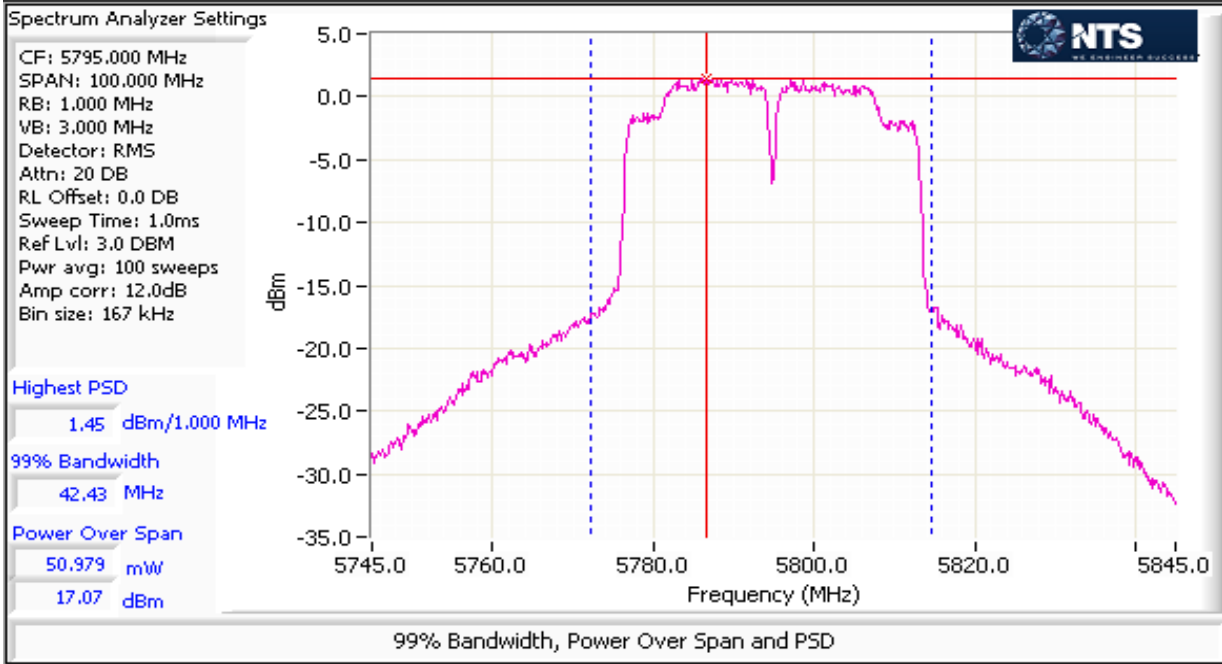



# EMC Test Data

Client:	Intel Corporation	Job Number:	J94914
Model:	7265D2W	T-Log Number:	T95472
Contact:	Steve Hackett	Project Manager:	Christine Krebill
Standard:	FCC Part 15.247, 15.407, RSS-210	Project Coordinator:	-
		Class:	N/A

## MIMO Device - 5725-5850 MHz Band - FCC Only

Mode: ac80

Max EIRP (mW): 78.7

Frequency (MHz)	Chain	Software Setting		Duty Cycle %	Power dBm	Total Power <sup>1</sup> mW	dBm	FCC Limit dBm	Max Power (W)	Result
5775	1	21.5 / 21.5		94	10.9	24.9	14.0	30.0	0.025	Pass
	3									
	4									
	2				10.5					

## 5725-5850 PSD - FCC Only

Mode: ac80

Frequency (MHz)	Chain	Software Setting		Duty Cycle %	PSD dBm/MHz	Total PSD <sup>1</sup> mW/MHz	dBm/MHz	FCC Limit dBm/MHz	Result
5775	1	22.0 / 21.5		94	-7.3	0.4	-4.4	28.0	Pass
	3								
	4								
	2				-8.0				

Client: Intel Corporation	Job Number: J94914
Model: 7265D2W	T-Log Number: T95472
Contact: Steve Hackett	Project Manager: Christine Krebill
Standard: FCC Part 15.247, 15.407, RSS-210	Project Coordinator: -
	Class: N/A

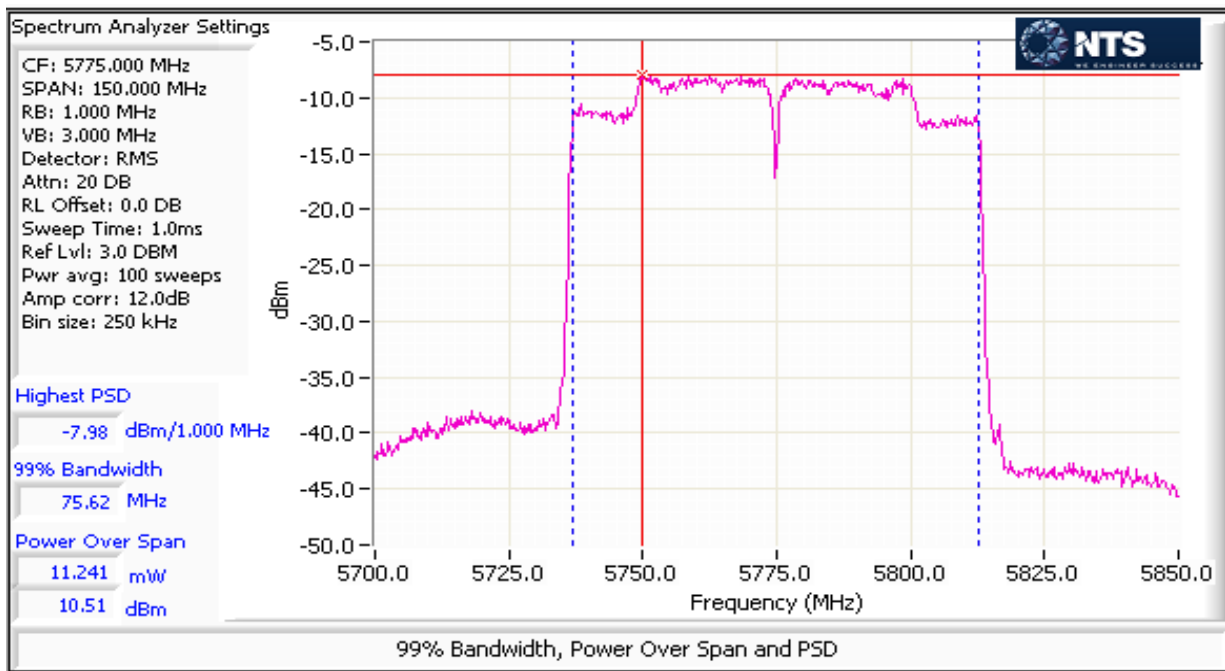
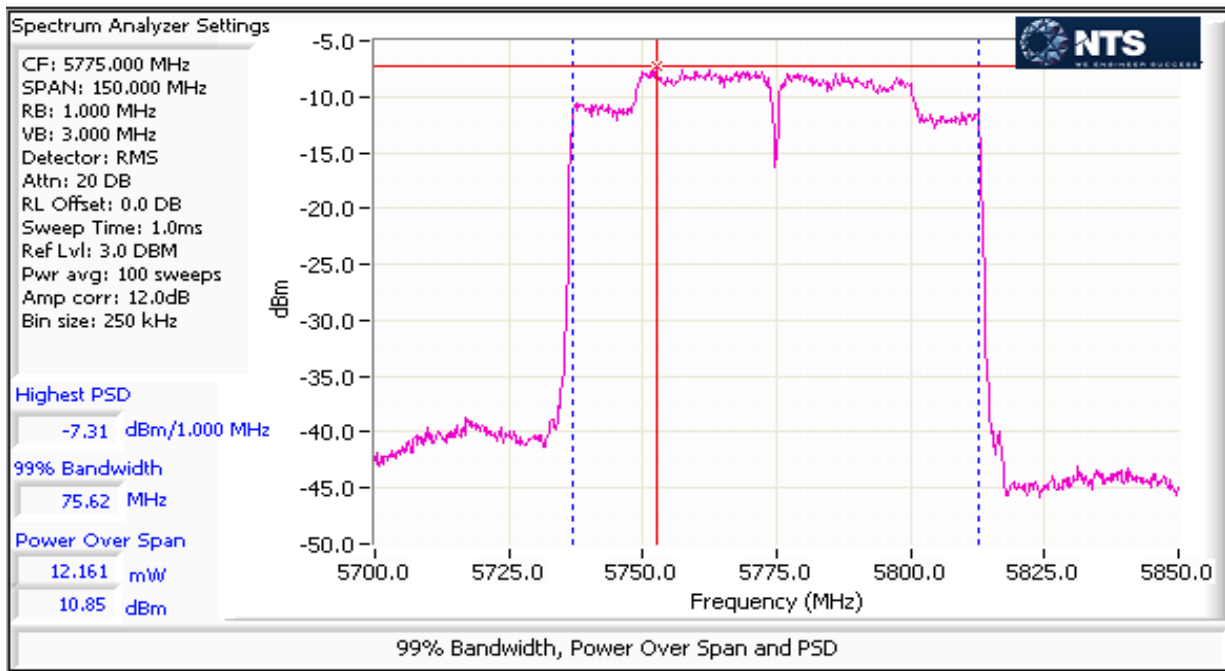





# EMC Test Data

Client:	Intel Corporation	Job Number:	J94914
Model:	7265D2W	T-Log Number:	T95472
Contact:	Steve Hackett	Project Manager:	Christine Krebill
Standard:	FCC Part 15.247, 15.407, RSS-210	Project Coordinator:	-
		Class:	N/A

## RSS 210 and FCC 15.407 (UNII) Radiated Spurious Emissions

### Test Specific Details

Objective: The objective of this test session is to perform final qualification testing of the EUT with respect to the specification listed above.

### General Test Configuration

The EUT and all local support equipment were located on the turntable for radiated spurious emissions testing. For radiated emissions testing the measurement antenna was located 3 meters from the EUT, unless otherwise noted.

### Ambient Conditions:

Temperature: 20-24 °C  
Rel. Humidity: 30-45 %

### Summary of Results

Run #	Mode	Channel	Power Setting	Measured Power	Test Performed	Limit	Result / Margin
20MHz Bandwith Modes							
1	a	36 - 5180MHz	22.5 (14)	14.1	Restricted Band Edge at 5150 MHz	15.209	52.3 dBµV/m @ 5150.0 MHz (-1.7 dB)
2	a	64 - 5320MHz	22 (13.5)	13.6	Restricted Band Edge at 5350 MHz	15.209	52.9 dBµV/m @ 5350.0 MHz (-1.1 dB)
3	a	100 - 5500MHz	22 (13.5)	13.6	Restricted Band Edge at 5460 MHz	15.209	43.5 dBµV/m @ 5446.2 MHz (-10.5 dB)
	a	100 - 5500MHz	22 (13.5)	13.6	Band Edge 5460 - 5470 MHz	15E	58.8 dBµV/m @ 5463.2 MHz (-9.5 dB)
	a	140 - 5700MHz	22 (13.0)	13.2	Band Edge 5725MHz	15E	55.2 dBµV/m @ 5726.1 MHz (-13.1 dB)
4	n20	36 - 5180MHz	21.5 (14.0)	14.2	Restricted Band Edge at 5150 MHz	15.209	52.4 dBµV/m @ 5150.0 MHz (-1.6 dB)
5	n20	64 - 5320MHz	21.5 (13.5)	13.6	Restricted Band Edge at 5350 MHz	15.209	52.2 dBµV/m @ 5350.0 MHz (-1.8 dB)
6	n20	100 - 5500MHz	22 (13.5)	13.6	Restricted Band Edge at 5460 MHz	15.209	42.5 dBµV/m @ 5458.0 MHz (-11.5 dB)
	n20	100 - 5500MHz	22 (13.5)	13.6	Band Edge 5460 - 5470 MHz	15E	57.2 dBµV/m @ 5466.6 MHz (-11.1 dB)
	n20	140 - 5700MHz	23 (13.0)	13.2	Band Edge 5725MHz	15E	55.7 dBµV/m @ 5726.8 MHz (-12.6 dB)



# EMC Test Data

Client: Intel Corporation	Job Number: J94914
Model: 7265D2W	T-Log Number: T95472
Contact: Steve Hackett	Project Manager: Christine Krebill
Standard: FCC Part 15.247, 15.407, RSS-210	Project Coordinator: -
	Class: N/A

## Summary of Results

Run #	Mode	Channel	Power Setting	Measured Power	Test Performed	Limit	Result / Margin
<b>40MHz Bandwith Modes</b>							
7	n40	38 - 5190MHz	20.0	11.9	Restricted Band Edge at 5150 MHz	15.209	48.8 dBµV/m @ 5150.0 MHz (-5.2 dB)
8	n40	62 - 5310MHz	21.5	13.4	Restricted Band Edge at 5350 MHz	15.209	50.9 dBµV/m @ 5350.0 MHz (-3.1 dB)
9	n40	102 - 5510MHz	22.0	13.4	Restricted Band Edge at 5460 MHz	15.209	43.1 dBµV/m @ 5460.0 MHz (-10.9 dB)
	n40	102 - 5510MHz	22.0	13.4	Band Edge 5460 - 5470 MHz	15E	61.3 dBµV/m @ 5469.0 MHz (-7.0 dB)
	n40	134 - 5670MHz	25.5	15.1	Band Edge 5725MHz	15E	66.6 dBµV/m @ 5725.6 MHz (-1.7 dB)
<b>80MHz Bandwith Modes</b>							
10	ac80	42 - 5210MHz	20.5	13.6	Restricted Band Edge at 5150 MHz	15.209	48.3 dBµV/m @ 5142.6 MHz (-5.7 dB)
11	ac80	58 - 5290MHz	21.5	13.0	Restricted Band Edge at 5350 MHz	15.209	51.5 dBµV/m @ 5350.0 MHz (-2.5 dB)
12	ac80	106 - 5530MHz	23.0	13.5	Restricted Band Edge at 5460 MHz	15.209	49.9 dBµV/m @ 5458.7 MHz (-4.1 dB)
	ac80	106 - 5530MHz	23.0	13.6	Band Edge 5460 - 5470 MHz	15E	66.5 dBµV/m @ 5460.8 MHz (-1.8 dB)

### Modifications Made During Testing

No modifications were made to the EUT during testing

### Deviations From The Standard

No deviations were made from the requirements of the standard.

Note - measured powers are average power measured with a power meter, for reference only.



# EMC Test Data

Client:	Intel Corporation	Job Number:	J94914
Model:	7265D2W	T-Log Number:	T95472
		Project Manager:	Christine Krebill
Contact:	Steve Hackett	Project Coordinator:	-
Standard:	FCC Part 15.247, 15.407, RSS-210	Class:	N/A

## Procedure Comments:

Measurements performed in accordance with FCC KDB 789033  
 Peak measurements performed with: RBW=1MHz, VBW=3MHz, peak detector, max hold, auto sweep time  
 Unless otherwise stated/noted, emission has duty cycle  $\geq 98\%$  and was measured using RBW=1MHz, VBW=10Hz, peak detector, linear average mode, auto sweep time, max hold.

Mode	Data Rate	Duty Cycle (x)	Constant DC?	T (ms)	Pwr Cor Factor*	Lin Volt Cor Factor**	Min VBW for FS (Hz)
11a	6.0Mbps	99%	Constant	2.06	0.0	0.0	485
n20	6.5Mbps	98%	Constant	1.92	0.0	0.0	521
n40	13.5Mbps	97%	Constant	0.94	0.1	0.3	1064
ac80	29.3Mbps	94%	Constant	0.44	0.3	0.6	2273

## Sample Notes

MAC Address: 001500F15B3A DRTU Tool Version 1.7.3-935 Driver version 17.1.0.11

Antenna: Skycross WiMax/WLAN

## Measurement Specific Notes:

Note 1:	For emissions outside of the restricted bands the limit is -27dBm/MHz eirp (68.3dBuV/m). The measurement method required is a peak measurement (RB=1MHz, VB $\geq$ 3MHz, peak detector). Per KDB 789033 2) c) (i), compliance can be demonstrated by meeting the average and peak limits of 15.209, as an alternative.
Note 2:	Emission has duty cycle $\geq 98\%$ , average measurement performed: RBW=1MHz, VBW=3MHz, RMS, Power averaging, auto sweep, trace average 100 traces
Note 3:	Emission has duty cycle $< 98\%$ , but constant, average measurement performed: RBW=1MHz, VBW=10Hz, peak detector, linear averaging, auto sweep, trace average 100 * 1/DC traces, measurement corrected by Linear Voltage correction factor
Note 4:	Emission has duty cycle $< 98\%$ and is NOT constant, average measurement performed: RBW=1MHz, VBW $>$ 1/T, peak detector, linear average mode, sweep time auto, max hold. Max hold for 50*(1/DC) traces
Note 5:	Emission has duty cycle $< 98\%$ , but constant, average measurement performed: RBW=1MHz, VBW=3MHz, RMS, Power averaging, auto sweep, trace average 100 * 1/DC traces, measurement corrected by Pwr correction factor
Note 6:	Plots of the average and peak bandedge do not account for any duty cycle correction. Refer to the tabluar results for final measurements.



# EMC Test Data

Client: Intel Corporation	Job Number: J94914
Model: 7265D2W	T-Log Number: T95472
Contact: Steve Hackett	Project Manager: Christine Krebill
Standard: FCC Part 15.247, 15.407, RSS-210	Project Coordinator: -
	Class: N/A

## Run #1: Radiated Bandedge Measurements, 5150-5250MHz

Date of Test: 6/5/2014  
 Test Engineer: Deniz Demirci  
 Test Location: FT Ch#4

Config. Used: 1  
 Config Change: None  
 EUT Voltage: N/A

Channel: 36 - 5180 MHz  
 Tx Chain: A  
 Mode: a  
 Data Rate: 6.0Mbps

Power Settings		
Target (dBm)	Measured (dBm)	Software Setting
14.0	14.1	22.5

### 5150 MHz Band Edge Signal Radiated Field Strength

Frequency MHz	Level dB $\mu$ V/m	Pol v/h	FCC 15.209		Detector Pk/QP/Avg	Azimuth degrees	Height meters	Comments
			Limit	Margin				
5150.000	52.3	V	54.0	-1.7	AVG	139	1.7	POS; RB 1 MHz; VB: 10 Hz
5148.160	70.2	V	74.0	-3.8	PK	139	1.7	POS; RB 1 MHz; VB: 3 MHz
5150.000	51.5	V	54.0	-2.5	AVG	144	1.8	POS; RB 1 MHz; VB: 10 Hz
5149.840	68.2	V	74.0	-5.8	PK	144	1.8	POS; RB 1 MHz; VB: 3 MHz

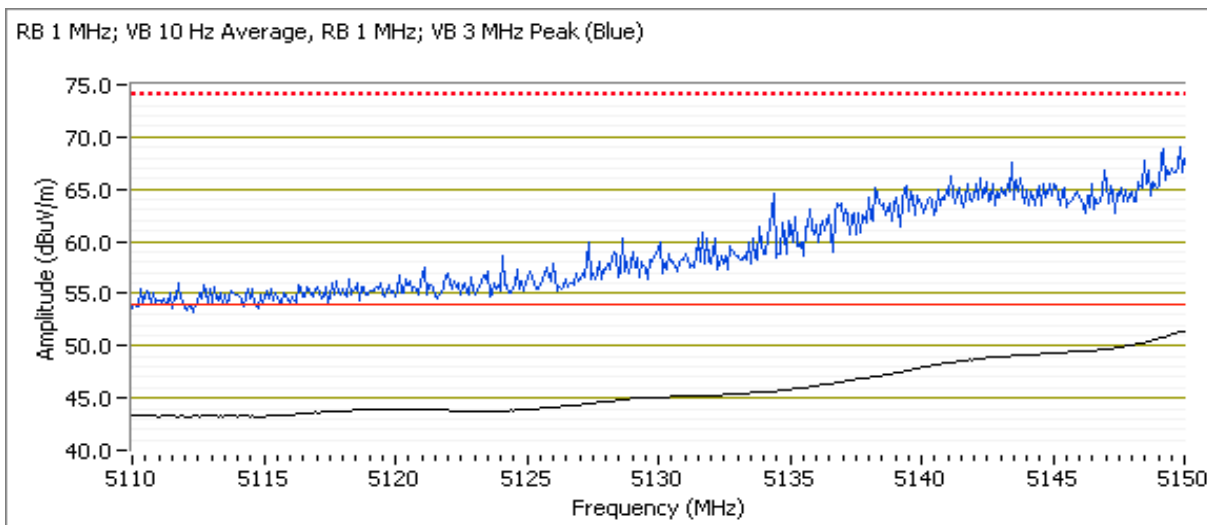



# EMC Test Data

Client: Intel Corporation	Job Number: J94914
Model: 7265D2W	T-Log Number: T95472
Contact: Steve Hackett	Project Manager: Christine Krebill
Standard: FCC Part 15.247, 15.407, RSS-210	Project Coordinator: -
	Class: N/A

## Run #2: Radiated Bandedge Measurements, 5250-5350MHz

Date of Test: 6/5/2014  
 Test Engineer: Deniz Demirci  
 Test Location: FT Ch#4

Config. Used: 1  
 Config Change: None  
 EUT Voltage: N/A

Channel: 64 - 5320MHz  
 Tx Chain: A  
 Mode: a  
 Data Rate: 6.0Mbps

Power Settings		
Target (dBm)	Measured (dBm)	Software Setting
13.5	13.6	22.0

### 5350 MHz Band Edge Signal Radiated Field Strength

Frequency MHz	Level dB $\mu$ V/m	Pol v/h	FCC 15.209		Detector Pk/QP/Avg	Azimuth degrees	Height meters	Comments
			Limit	Margin				
5350.000	52.9	V	54.0	-1.1	AVG	146	1.7	POS; RB 1 MHz; VB: 10 Hz
5353.770	67.9	V	74.0	-6.1	PK	146	1.7	POS; RB 1 MHz; VB: 3 MHz
5350.080	52.2	H	54.0	-1.8	AVG	129	0.9	POS; RB 1 MHz; VB: 10 Hz
5352.320	67.2	H	74.0	-6.8	PK	129	0.9	POS; RB 1 MHz; VB: 3 MHz

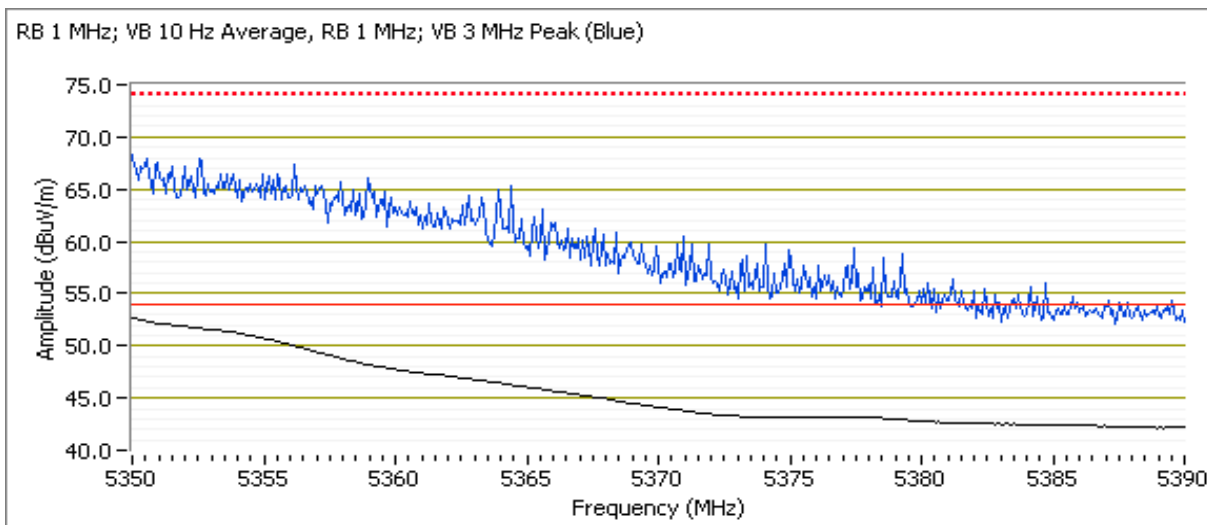



# EMC Test Data

Client: Intel Corporation	Job Number: J94914
Model: 7265D2W	T-Log Number: T95472
Contact: Steve Hackett	Project Manager: Christine Krebill
Standard: FCC Part 15.247, 15.407, RSS-210	Project Coordinator: -
	Class: N/A

## Run #3: Radiated Bandedge Measurements, 5470-5725MHz

Date of Test: 6/5/2014  
 Test Engineer: Deniz Demirci  
 Test Location: FT Ch#4

Config. Used: 1  
 Config Change: None  
 EUT Voltage: N/A

Channel: 100 - 5500MHz  
 Tx Chain: A  
 Mode: a  
 Data Rate: 6.0Mbps

Power Settings		
Target (dBm)	Measured (dBm)	Software Setting
13.5	13.6	22.0

## 5460 MHz Band Edge Signal Radiated Field Strength

Frequency MHz	Level dB $\mu$ V/m	Pol v/h	FCC 15.209		Detector Pk/QP/Avg	Azimuth degrees	Height meters	Comments
			Limit	Margin				
5446.210	43.5	V	54.0	-10.5	AVG	151	1.6	POS; RB 1 MHz; VB: 10 Hz
5459.120	55.1	V	74.0	-18.9	PK	151	1.6	POS; RB 1 MHz; VB: 3 MHz
5445.890	42.6	H	54.0	-11.4	AVG	123	1.0	POS; RB 1 MHz; VB: 10 Hz
5426.010	54.7	H	74.0	-19.3	PK	123	1.0	POS; RB 1 MHz; VB: 3 MHz

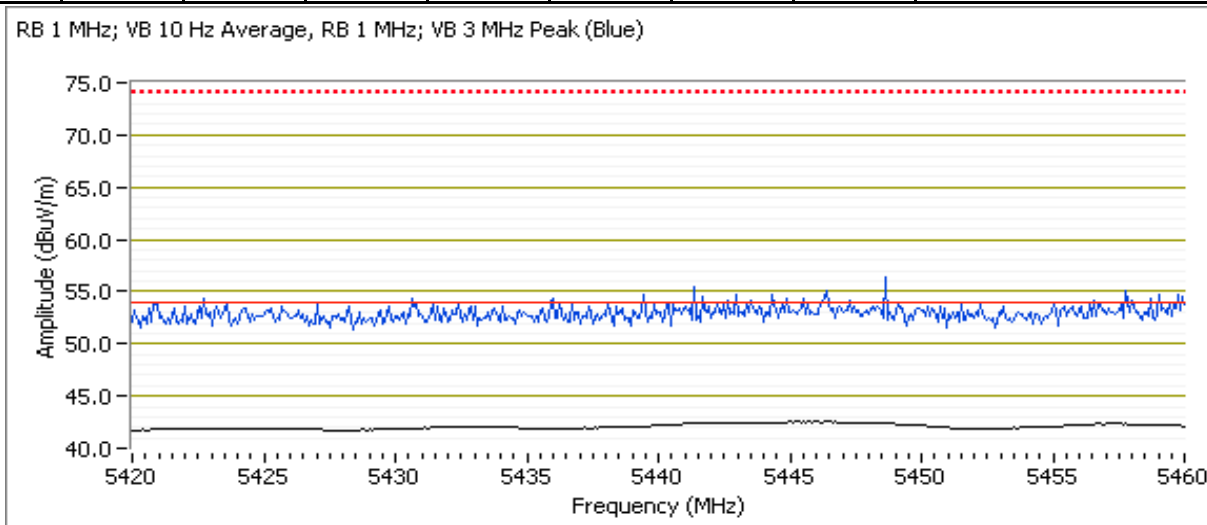



# EMC Test Data

Client: Intel Corporation	Job Number: J94914
Model: 7265D2W	T-Log Number: T95472
Contact: Steve Hackett	Project Manager: Christine Krebill
Standard: FCC Part 15.247, 15.407, RSS-210	Project Coordinator: -
	Class: N/A

## 5470 MHz Band Edge Signal Radiated Field Strength

Frequency MHz	Level dB $\mu$ V/m	Pol v/h	15.E		Detector Pk/QP/Avg	Azimuth degrees	Height meters	Comments
			Limit	Margin				
5463.170	58.8	V	68.3	-9.5	PK	151	1.6	POS; RB 1 MHz; VB: 3 MHz
5466.950	57.8	H	68.3	-10.5	PK	123	1.0	POS; RB 1 MHz; VB: 3 MHz

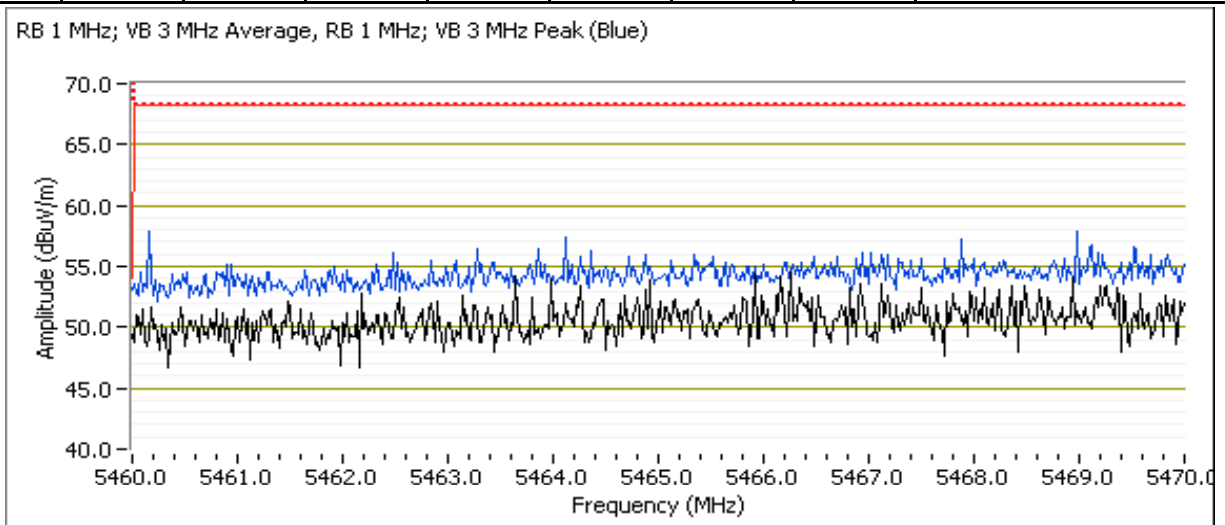



# EMC Test Data

Client:	Intel Corporation	Job Number:	J94914
Model:	7265D2W	T-Log Number:	T95472
Contact:	Steve Hackett	Project Manager:	Christine Krebill
Standard:	FCC Part 15.247, 15.407, RSS-210	Project Coordinator:	-
		Class:	N/A

Channel: 140 - 5700MHz  
 Tx Chain: A  
 Mode: a  
 Data Rate: 6.0Mbps

Power Settings		
Target (dBm)	Measured (dBm)	Software Setting
13.0	13.2	22.5

### 5725 MHz Band Edge Signal Radiated Field Strength

Frequency MHz	Level dB $\mu$ V/m	Pol v/h	15.E		Detector Pk/QP/Avg	Azimuth degrees	Height meters	Comments
			Limit	Margin				
5726.120	55.2	H	68.3	-13.1	PK	105	1.0	POS; RB 1 MHz; VB: 3 MHz
5726.600	54.7	V	68.3	-13.6	PK	127	1.1	POS; RB 1 MHz; VB: 3 MHz

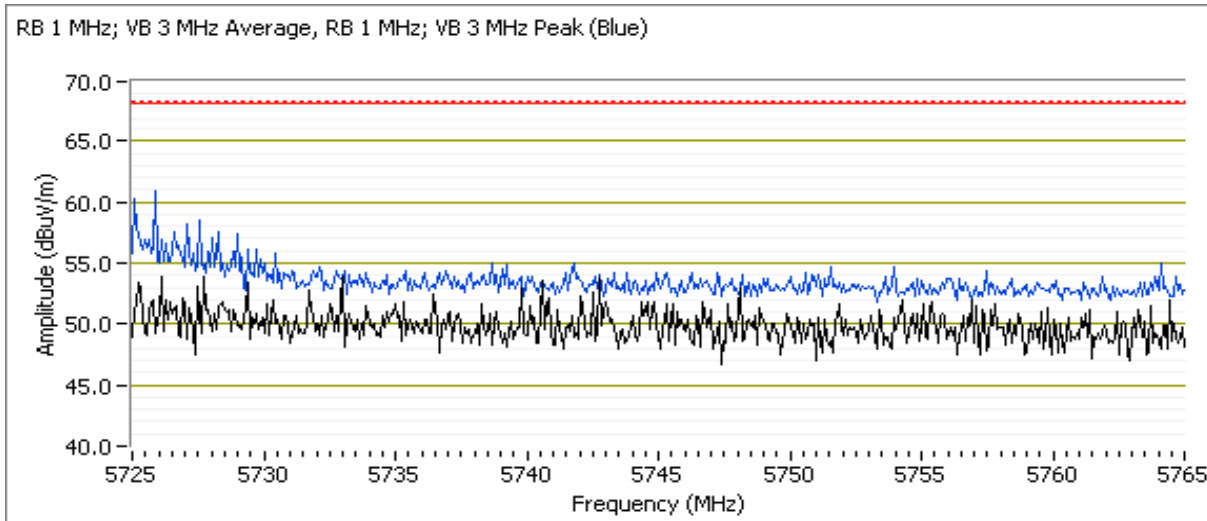





# EMC Test Data

Client: Intel Corporation	Job Number: J94914
Model: 7265D2W	T-Log Number: T95472
Contact: Steve Hackett	Project Manager: Christine Krebill
Standard: FCC Part 15.247, 15.407, RSS-210	Project Coordinator: -
	Class: N/A

## Run #4: Radiated Bandedge Measurements, 5150-5250MHz

Date of Test: 6/5/2014 0:00  
 Test Engineer: Joseph Cadigal  
 Test Location: FT Chamber#4

Config. Used: 1  
 Config Change: None  
 EUT Voltage: N/A

Channel: 36 - 5180 MHz  
 Tx Chain: A  
 Mode: n20  
 Data Rate: 6.5Mbps

Power Settings		
Target (dBm)	Measured (dBm)	Software Setting
14.0	14.2	21.5

### 5150 MHz Band Edge Signal Radiated Field Strength

Frequency MHz	Level dB $\mu$ V/m	Pol v/h	FCC 15.209		Detector Pk/QP/Avg	Azimuth degrees	Height meters	Comments
			Limit	Margin				
5150.000	52.4	H	54.0	-1.6	AVG	109	0.9	POS; RB 1 MHz; VB: 10 Hz
5149.360	65.7	H	74.0	-8.3	PK	109	0.9	POS; RB 1 MHz; VB: 3 MHz
5150.000	43.0	V	54.0	-11.0	AVG	108	1.5	POS; RB 1 MHz; VB: 10 Hz
5147.440	53.2	V	74.0	-20.8	PK	108	1.5	POS; RB 1 MHz; VB: 3 MHz

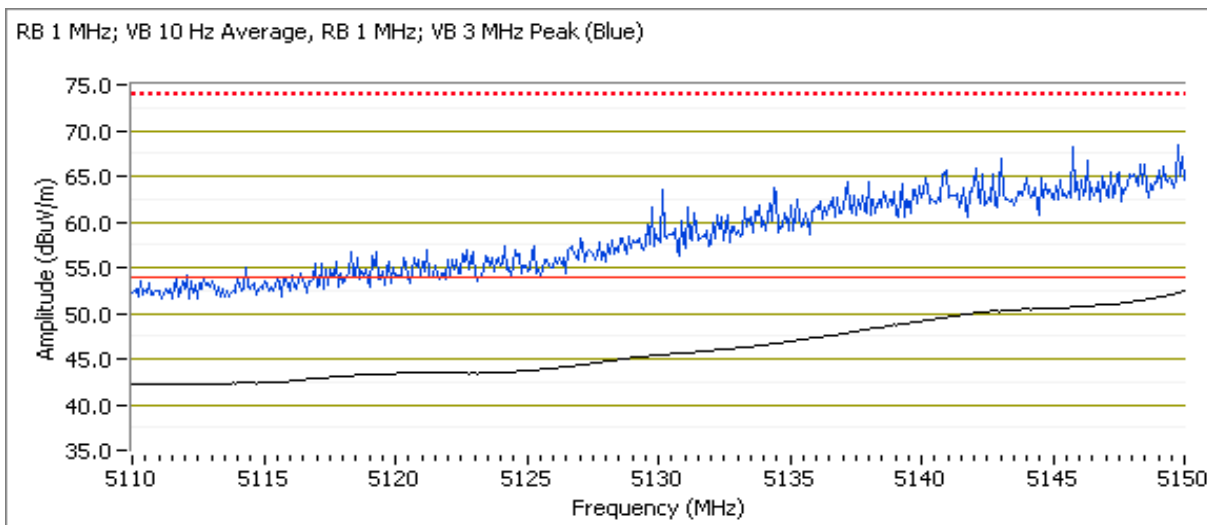



# EMC Test Data

Client: Intel Corporation	Job Number: J94914
Model: 7265D2W	T-Log Number: T95472
Contact: Steve Hackett	Project Manager: Christine Krebill
Standard: FCC Part 15.247, 15.407, RSS-210	Project Coordinator: -
	Class: N/A

## Run #5: Radiated Bandedge Measurements, 5250-5350MHz

Date of Test: 6/5/2014 0:00  
 Test Engineer: Joseph Cadigal  
 Test Location: FT Chamber#4

Config. Used: 1  
 Config Change: None  
 EUT Voltage: N/A

Channel: 64 - 5320MHz  
 Tx Chain: A  
 Mode: n20  
 Data Rate: 6.5Mbps

Power Settings		
Target (dBm)	Measured (dBm)	Software Setting
13.5	13.6	21.5

### 5350 MHz Band Edge Signal Radiated Field Strength

Frequency MHz	Level dB $\mu$ V/m	Pol v/h	FCC 15.209		Detector Pk/QP/Avg	Azimuth degrees	Height meters	Comments
			Limit	Margin				
5350.000	52.2	H	54.0	-1.8	AVG	104	1.1	POS; RB 1 MHz; VB: 10 Hz
5358.340	66.9	H	74.0	-7.1	PK	104	1.1	POS; RB 1 MHz; VB: 3 MHz
5350.000	50.4	V	54.0	-3.6	AVG	174	1.7	POS; RB 1 MHz; VB: 10 Hz
5350.400	64.5	V	74.0	-9.5	PK	174	1.7	POS; RB 1 MHz; VB: 3 MHz

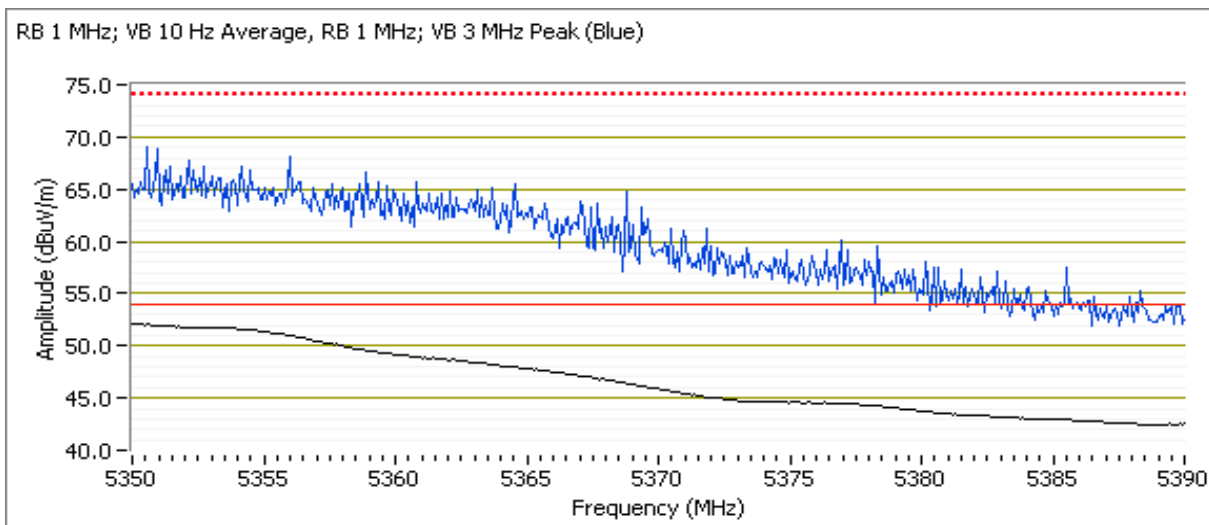



# EMC Test Data

Client: Intel Corporation	Job Number: J94914
Model: 7265D2W	T-Log Number: T95472
Contact: Steve Hackett	Project Manager: Christine Krebill
Standard: FCC Part 15.247, 15.407, RSS-210	Project Coordinator: -
	Class: N/A

## Run #6: Radiated Bandedge Measurements, 5470-5725MHz

Date of Test: 6/5/2014 0:00  
 Test Engineer: Joseph Cadigal  
 Test Location: FT Chamber#4

Config. Used: 1  
 Config Change: None  
 EUT Voltage: N/A

Channel: 100 - 5500MHz  
 Tx Chain: A  
 Mode: n20  
 Data Rate: 6.5Mbps

Power Settings		
Target (dBm)	Measured (dBm)	Software Setting
13.5	13.6	22.0

## 5460 MHz Band Edge Signal Radiated Field Strength

Frequency MHz	Level dB $\mu$ V/m	Pol v/h	FCC 15.209		Detector Pk/QP/Avg	Azimuth degrees	Height meters	Comments
			Limit	Margin				
5458.000	42.5	H	54.0	-11.5	AVG	104	1.9	POS; RB 1 MHz; VB: 10 Hz
5447.980	53.8	H	74.0	-20.2	PK	104	1.9	POS; RB 1 MHz; VB: 3 MHz
5446.450	41.9	V	54.0	-12.1	AVG	264	1.0	POS; RB 1 MHz; VB: 10 Hz
5443.010	53.4	V	74.0	-20.6	PK	264	1.0	POS; RB 1 MHz; VB: 3 MHz

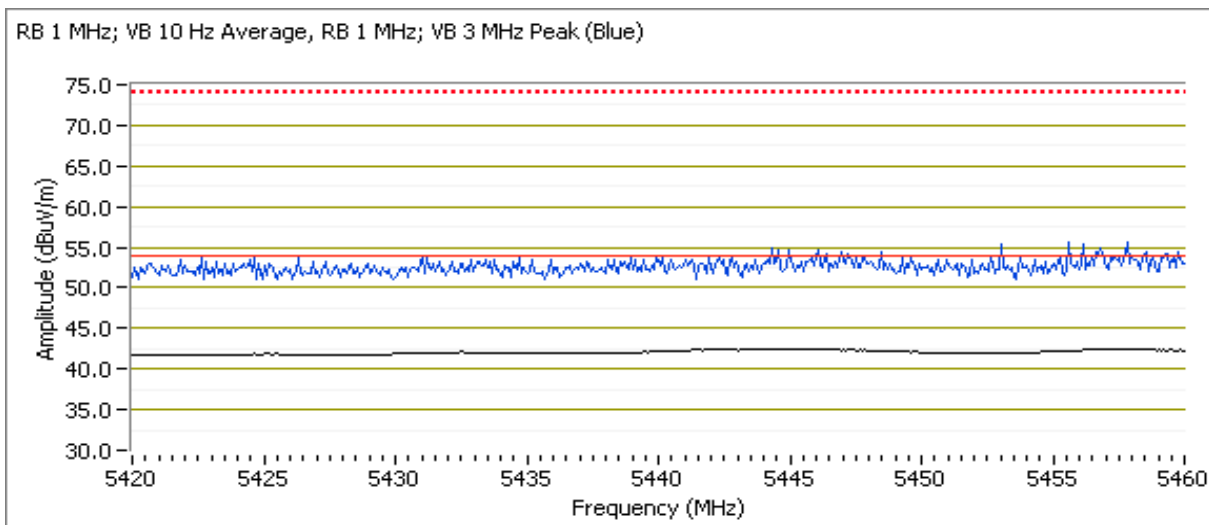



# EMC Test Data

Client: Intel Corporation	Job Number: J94914
Model: 7265D2W	T-Log Number: T95472
Contact: Steve Hackett	Project Manager: Christine Krebill
Standard: FCC Part 15.247, 15.407, RSS-210	Project Coordinator: -
	Class: N/A

## 5470 MHz Band Edge Signal Radiated Field Strength

Frequency MHz	Level dB $\mu$ V/m	Pol v/h	15.E		Detector Pk/QP/Avg	Azimuth degrees	Height meters	Comments
			Limit	Margin				
5466.630	57.2	H	68.3	-11.1	PK	104	1.9	POS; RB 1 MHz; VB: 3 MHz
5461.200	54.5	V	68.3	-13.8	PK	266	1.0	POS; RB 1 MHz; VB: 3 MHz

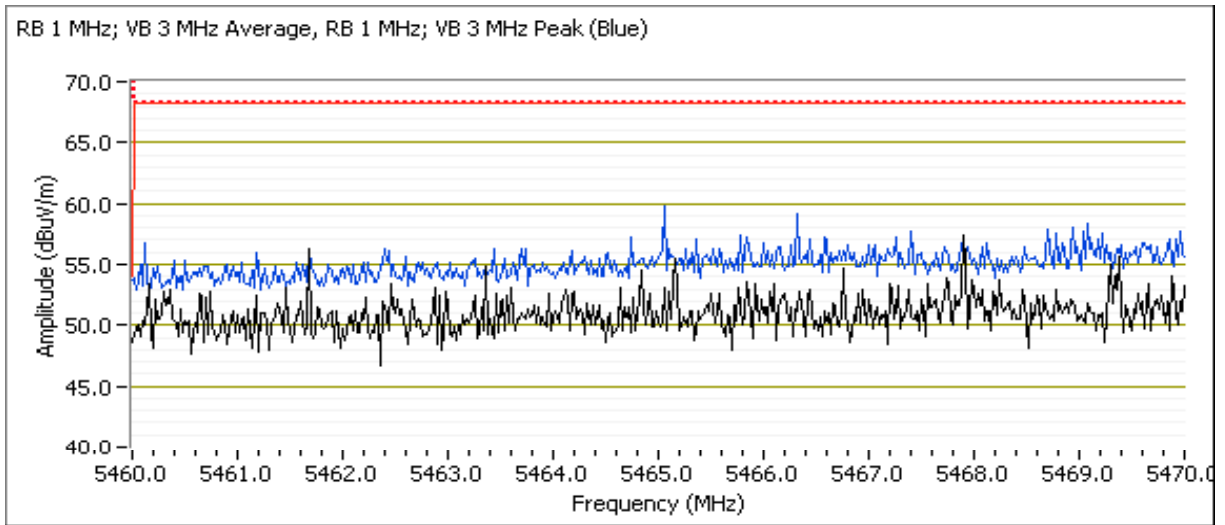



# EMC Test Data

Client:	Intel Corporation	Job Number:	J94914
Model:	7265D2W	T-Log Number:	T95472
Contact:	Steve Hackett	Project Manager:	Christine Krebill
Standard:	FCC Part 15.247, 15.407, RSS-210	Project Coordinator:	-
		Class:	N/A

Channel: 140 - 5700MHz  
 Tx Chain: A  
 Mode: n20  
 Data Rate: 6.5Mbps

Power Settings		
Target (dBm)	Measured (dBm)	Software Setting
13.0	13.2	23.0

### 5725 MHz Band Edge Signal Radiated Field Strength

Frequency	Level	Pol	15.E		Detector	Azimuth	Height	Comments
MHz	dB $\mu$ V/m	v/h	Limit	Margin	Pk/QP/Avg	degrees	meters	
5726.840	55.7	H	68.3	-12.6	PK	128	1.6	POS; RB 1 MHz; VB: 3 MHz
5725.240	55.2	V	68.3	-13.1	PK	130	1.1	POS; RB 1 MHz; VB: 3 MHz

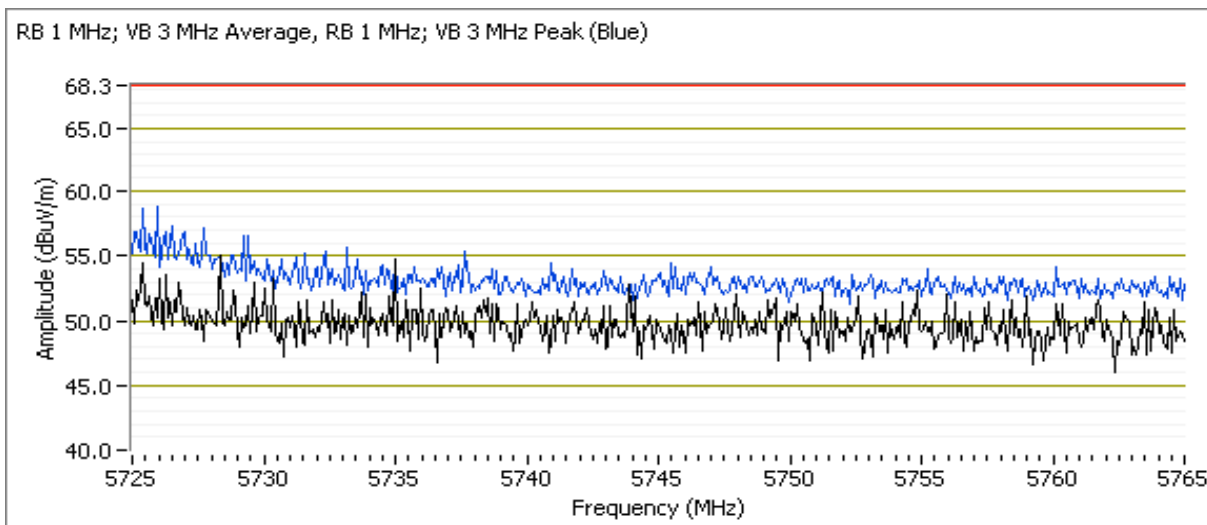



# EMC Test Data

Client: Intel Corporation	Job Number: J94914
Model: 7265D2W	T-Log Number: T95472
Contact: Steve Hackett	Project Manager: Christine Krebill
Standard: FCC Part 15.247, 15.407, RSS-210	Project Coordinator: -
	Class: N/A

## Run #7: Radiated Bandedge Measurements, 5150-5250MHz

Date of Test: 6/6/2014  
 Test Engineer: M. Birgani  
 Test Location: Chamber #3

Config. Used: 1  
 Config Change: -  
 EUT Voltage: 120V, 60Hz

Channel: 38 - 5190 MHz  
 Tx Chain: A  
 Mode: n40  
 Data Rate: 13.5Mbps

Power Settings		
Target (dBm)	Measured (dBm)	Software Setting
12.0	11.9	20.0

### 5150 MHz Band Edge Signal Radiated Field Strength

Frequency MHz	Level dB $\mu$ V/m	Pol v/h	FCC 15.209		Detector Pk/QP/Avg	Azimuth degrees	Height meters	Comments
			Limit	Margin				
5150.000	48.8	V	54.0	-5.2	AVG	106	2.3	Note 3, POS; RB 1MHz; VB: 10Hz
5149.920	47.6	H	54.0	-6.4	AVG	253	1.3	Note 3, POS; RB 1MHz; VB: 10Hz
5149.440	62.5	V	74.0	-11.5	PK	106	2.3	POS; RB 1 MHz; VB: 3 MHz
5150.000	62.5	H	74.0	-11.5	PK	253	1.3	POS; RB 1 MHz; VB: 3 MHz

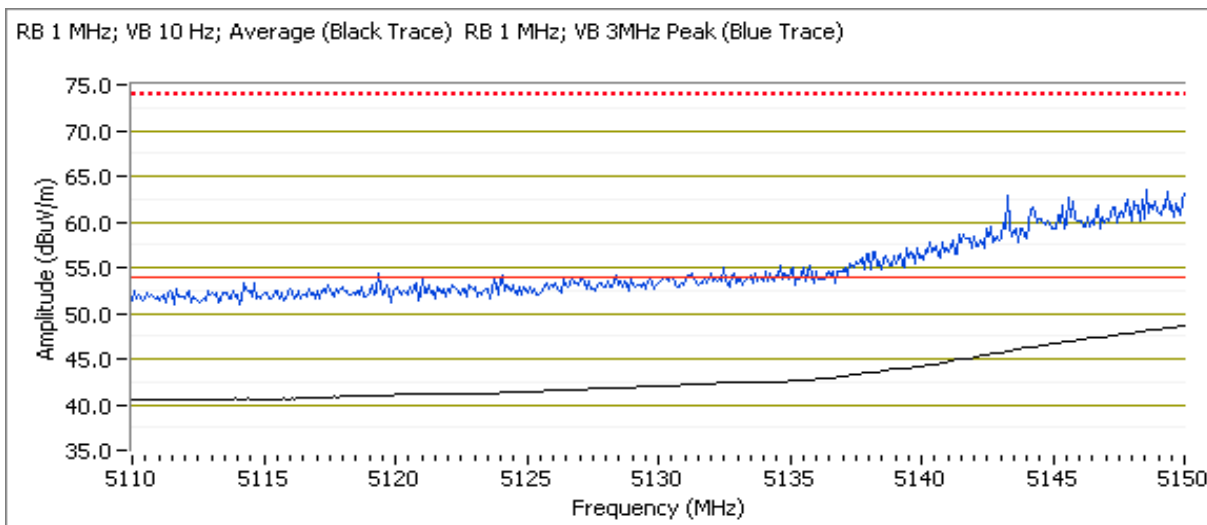



# EMC Test Data

Client: Intel Corporation	Job Number: J94914
Model: 7265D2W	T-Log Number: T95472
Contact: Steve Hackett	Project Manager: Christine Krebill
Standard: FCC Part 15.247, 15.407, RSS-210	Project Coordinator: -
	Class: N/A

## Run #8: Radiated Bandedge Measurements, 5250-5350MHz

Date of Test: 6/6/2014  
 Test Engineer: M. Birgani  
 Test Location: Chamber #3

Config. Used: 1  
 Config Change: -  
 EUT Voltage: 120V, 60Hz

Channel: 62 - 5310MHz  
 Tx Chain: A  
 Mode: n40  
 Data Rate: 13.5Mbps

Power Settings		
Target (dBm)	Measured (dBm)	Software Setting
13.5	13.4	21.5

### 5350 MHz Band Edge Signal Radiated Field Strength

Frequency	Level	Pol	FCC 15.209		Detector	Azimuth	Height	Comments
MHz	dB $\mu$ V/m	v/h	Limit	Margin	Pk/QP/Avg	degrees	meters	
5350.000	50.9	H	54.0	-3.1	AVG	261	2.3	Note 3, POS; RB 1MHz; VB: 10Hz
5350.000	49.8	V	54.0	-4.2	AVG	282	1.3	Note 3, POS; RB 1MHz; VB: 10Hz
5352.080	63.6	H	74.0	-10.4	PK	261	2.3	POS; RB 1 MHz; VB: 3 MHz
5350.160	61.0	V	74.0	-13.0	PK	282	1.3	POS; RB 1 MHz; VB: 3 MHz

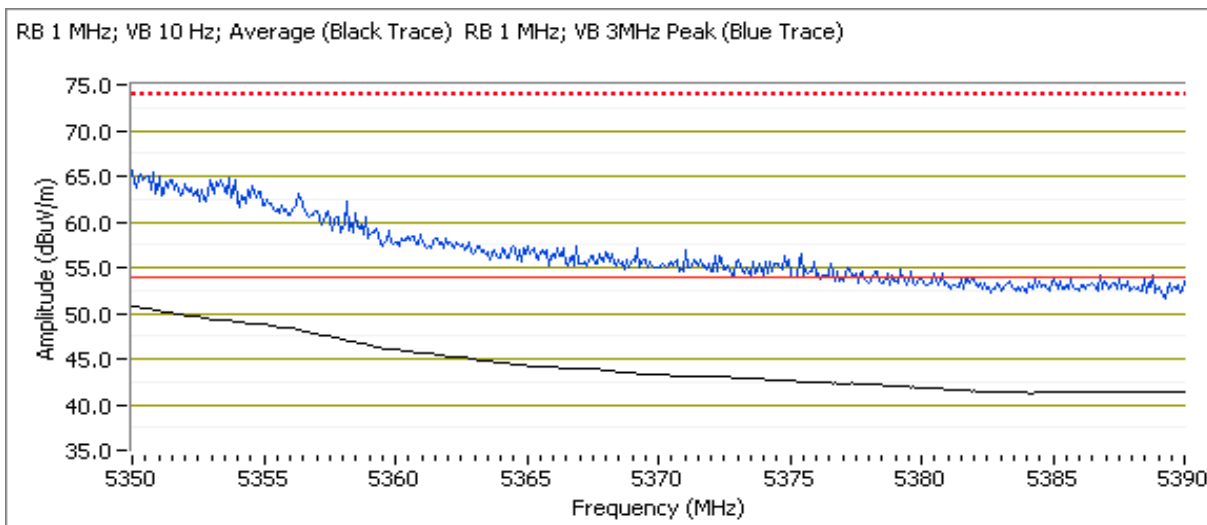



# EMC Test Data

Client: Intel Corporation	Job Number: J94914
Model: 7265D2W	T-Log Number: T95472
Contact: Steve Hackett	Project Manager: Christine Krebill
Standard: FCC Part 15.247, 15.407, RSS-210	Project Coordinator: -
	Class: N/A

## Run #9: Radiated Bandedge Measurements, 5470-5725MHz

Date of Test: 6/6/2014  
 Test Engineer: M. Birgani  
 Test Location: Chamber #3

Config. Used: 1  
 Config Change: -  
 EUT Voltage: 120V, 60Hz

Channel: 102 - 5510MHz  
 Tx Chain: A  
 Mode: n40  
 Data Rate: 13.5Mbps

Power Settings		
Target (dBm)	Measured (dBm)	Software Setting
13.5	13.4	22.0

## 5460 MHz Band Edge Signal Radiated Field Strength

Frequency MHz	Level dB $\mu$ V/m	Pol v/h	FCC 15.209		Detector Pk/QP/Avg	Azimuth degrees	Height meters	Comments
			Limit	Margin				
5460.000	43.1	H	54.0	-10.9	AVG	265	2.2	Note 3, POS; RB 1MHz; VB: 10Hz
5460.000	42.6	V	54.0	-11.4	AVG	181	1.0	Note 3, POS; RB 1MHz; VB: 10Hz
5459.440	56.3	H	74.0	-17.7	PK	265	2.2	POS; RB 1 MHz; VB: 3 MHz
5428.740	54.8	V	74.0	-19.2	PK	181	1.0	POS; RB 1 MHz; VB: 3 MHz

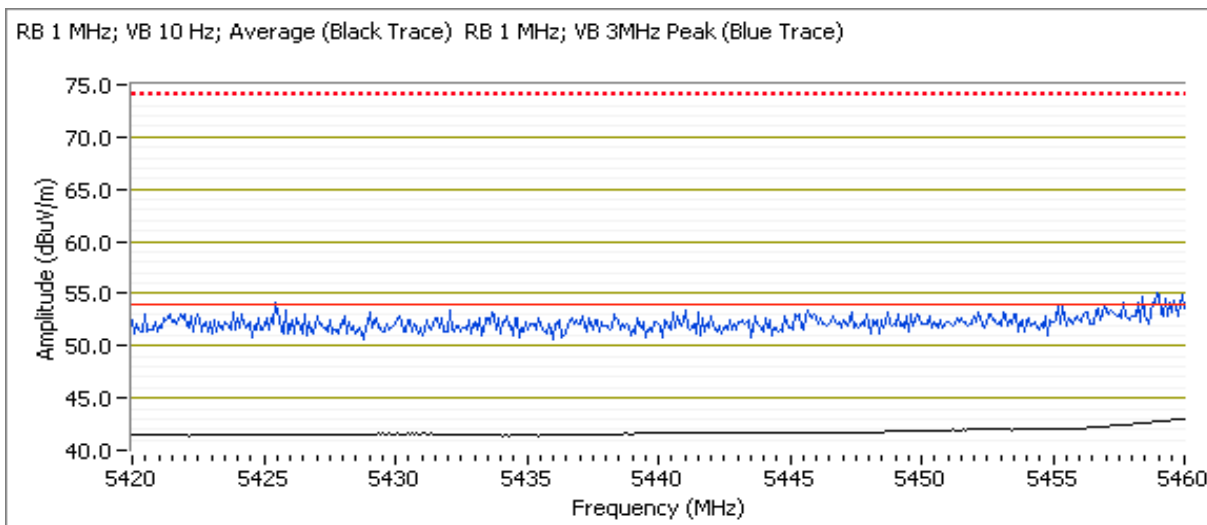





# EMC Test Data

Client: Intel Corporation	Job Number: J94914
Model: 7265D2W	T-Log Number: T95472
Contact: Steve Hackett	Project Manager: Christine Krebill
Standard: FCC Part 15.247, 15.407, RSS-210	Project Coordinator: -
	Class: N/A

## 5470 MHz Band Edge Signal Radiated Field Strength

Frequency MHz	Level dB $\mu$ V/m	Pol v/h	15.E		Detector Pk/QP/Avg	Azimuth degrees	Height meters	Comments
			Limit	Margin				
5469.020	61.3	H	68.3	-7.0	PK	265	2.2	POS; RB 1 MHz; VB: 3 MHz
5467.740	59.3	V	68.3	-9.0	PK	181	1.0	POS; RB 1 MHz; VB: 3 MHz

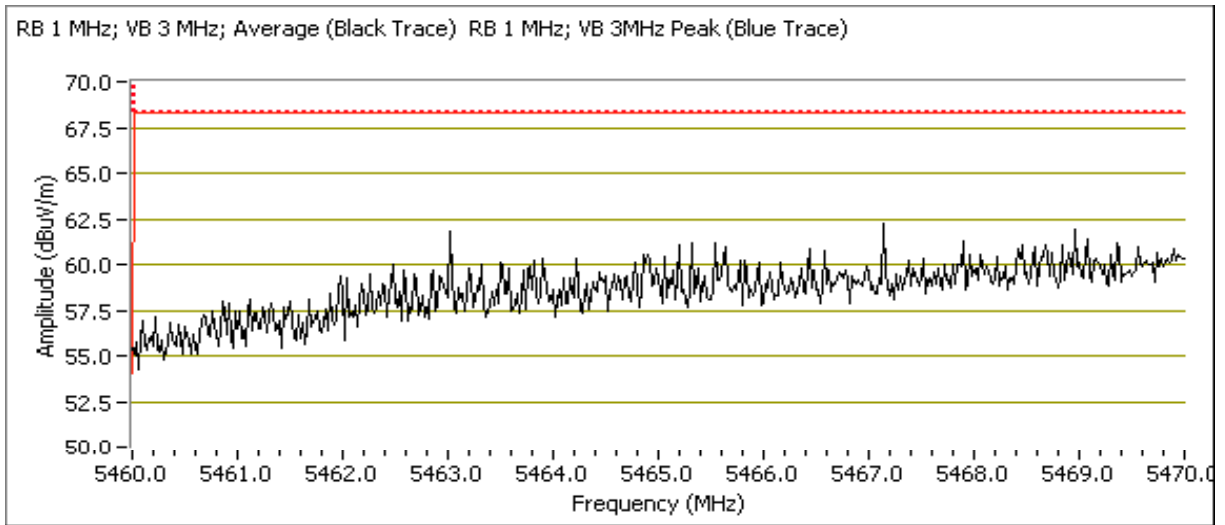



# EMC Test Data

Client: Intel Corporation	Job Number: J94914
Model: 7265D2W	T-Log Number: T95472
	Project Manager: Christine Krebill
Contact: Steve Hackett	Project Coordinator: -
Standard: FCC Part 15.247, 15.407, RSS-210	Class: N/A

Channel: 134 - 5670MHz  
 Tx Chain: A  
 Mode: n40  
 Data Rate: 13.5Mbps

Power Settings		
Target (dBm)	Measured (dBm)	Software Setting
16.5	15.1	25.5

### 5725 MHz Band Edge Signal Radiated Field Strength

Frequency	Level	Pol	15.E		Detector	Azimuth	Height	Comments
MHz	dB $\mu$ V/m	v/h	Limit	Margin	Pk/QP/Avg	degrees	meters	
5725.640	66.6	H	68.3	-1.7	PK	259	1.0	POS; RB 1 MHz; VB: 3 MHz
5727.400	60.8	V	68.3	-7.5	PK	181	1.0	POS; RB 1 MHz; VB: 3 MHz

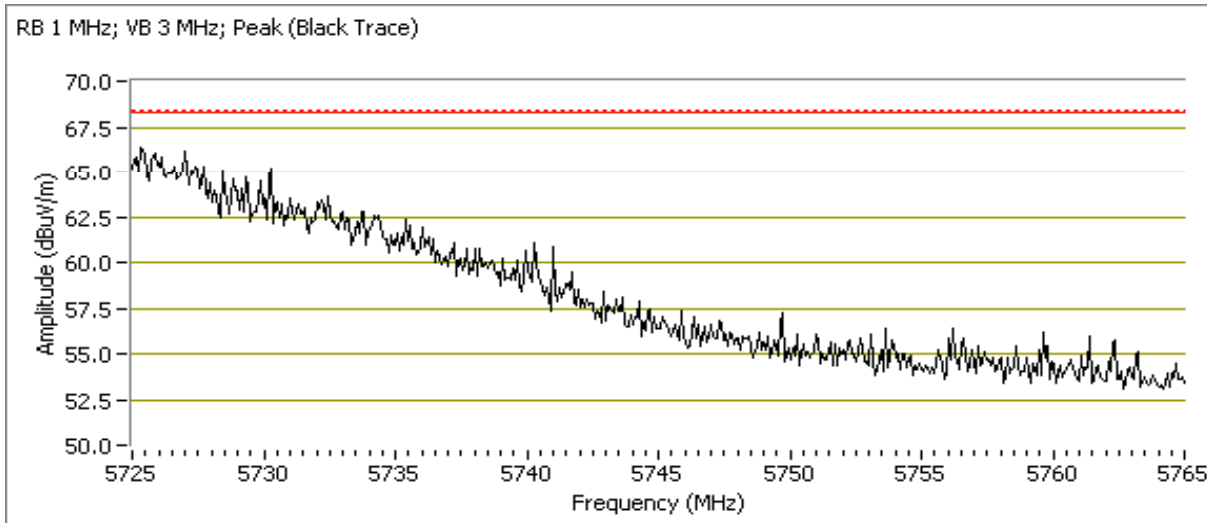



# EMC Test Data

Client: Intel Corporation	Job Number: J94914
Model: 7265D2W	T-Log Number: T95472
Contact: Steve Hackett	Project Manager: Christine Krebill
Standard: FCC Part 15.247, 15.407, RSS-210	Project Coordinator: -
	Class: N/A

## Run #10: Radiated Bandedge Measurements, 5150-5250MHz

Date of Test: 6/6/2014  
 Test Engineer: M. Birgani  
 Test Location: Chamber #3

Config. Used: 1  
 Config Change: -  
 EUT Voltage: 120V, 60Hz

Channel: 42 - 5210MHz  
 Tx Chain: A  
 Mode: ac80  
 Data Rate: 29.3Mbps

Power Settings		
Target (dBm)	Measured (dBm)	Software Setting
13.5	13.6	20.6

### 5150 MHz Band Edge Signal Radiated Field Strength

Frequency MHz	Level dB $\mu$ V/m	Pol v/h	FCC 15.209		Detector Pk/QP/Avg	Azimuth degrees	Height meters	Comments
			Limit	Margin				
5142.630	48.3	H	54.0	-5.7	AVG	228	1.1	Note 3, POS; RB 1MHz; VB: 10Hz
5141.580	48.2	V	54.0	-5.8	AVG	110	2.7	Note 3, POS; RB 1MHz; VB: 10Hz
5145.030	64.0	H	74.0	-10.0	PK	228	1.1	POS; RB 1 MHz; VB: 3 MHz
5139.740	63.1	V	74.0	-10.9	PK	110	2.7	POS; RB 1 MHz; VB: 3 MHz

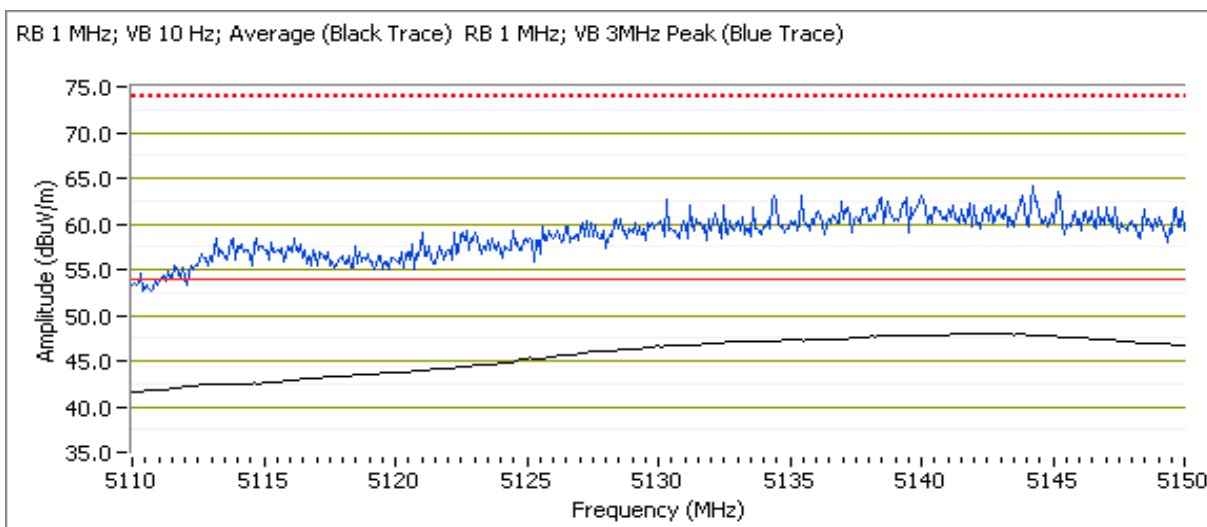



# EMC Test Data

Client: Intel Corporation	Job Number: J94914
Model: 7265D2W	T-Log Number: T95472
Contact: Steve Hackett	Project Manager: Christine Krebill
Standard: FCC Part 15.247, 15.407, RSS-210	Project Coordinator: -
	Class: N/A

## Run #11: Radiated Bandedge Measurements, 5250-5350MHz

Date of Test: 6/6/2014  
 Test Engineer: M. Birgani  
 Test Location: Chamber #3

Config. Used: 1  
 Config Change: -  
 EUT Voltage: 120V, 60Hz

Channel: 58 - 5290MHz  
 Tx Chain: A  
 Mode: ac80  
 Data Rate: 29.3Mbps

Power Settings		
Target (dBm)	Measured (dBm)	Software Setting
13.5	13.0	21.5

### 5350 MHz Band Edge Signal Radiated Field Strength

Frequency MHz	Level dB $\mu$ V/m	Pol v/h	FCC 15.209		Detector Pk/QP/Avg	Azimuth degrees	Height meters	Comments
			Limit	Margin				
5350.000	51.5	H	54.0	-2.5	AVG	228	1.1	Note 3, POS; RB 1MHz; VB: 10Hz
5357.540	49.2	V	54.0	-4.8	AVG	118	2.7	Note 3, POS; RB 1MHz; VB: 10Hz
5353.610	64.8	H	74.0	-9.2	PK	228	1.1	POS; RB 1 MHz; VB: 3 MHz
5354.650	64.3	V	74.0	-9.7	PK	118	2.7	POS; RB 1 MHz; VB: 3 MHz

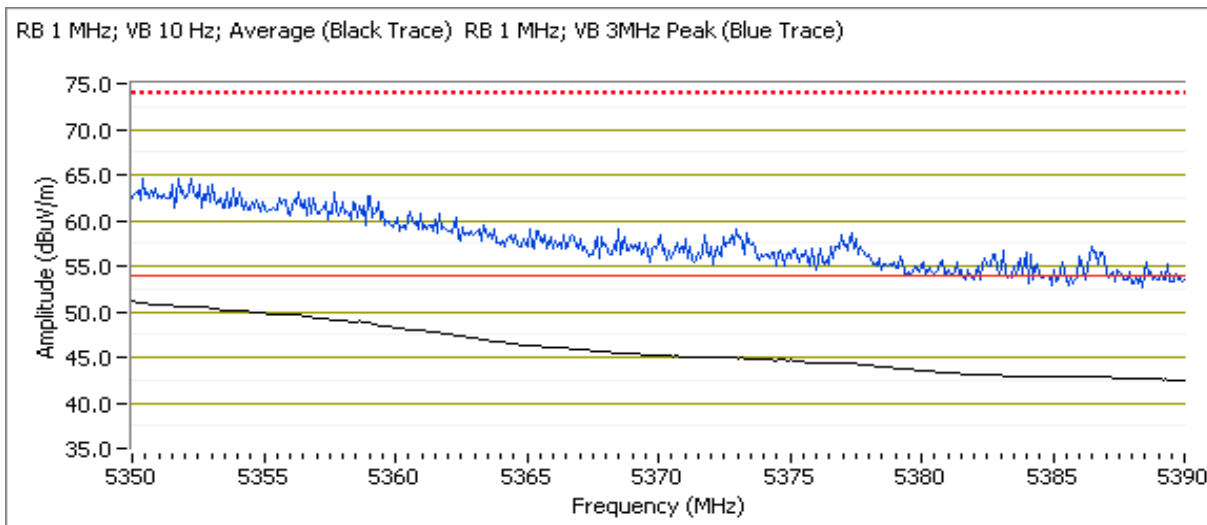



# EMC Test Data

Client: Intel Corporation	Job Number: J94914
Model: 7265D2W	T-Log Number: T95472
Contact: Steve Hackett	Project Manager: Christine Krebill
Standard: FCC Part 15.247, 15.407, RSS-210	Project Coordinator: -
	Class: N/A

## Run #12: Radiated Bandedge Measurements, 5470-5725MHz

Date of Test: 6/6/2014  
 Test Engineer: M. Birgani  
 Test Location: Chamber #3

Config. Used: 1  
 Config Change: -  
 EUT Voltage: 120V, 60Hz

Channel: 106 - 5530MHz  
 Tx Chain: A  
 Mode: ac80  
 Data Rate: 29.3Mbps

Power Settings		
Target (dBm)	Measured (dBm)	Software Setting
13.5	13.6	23.0

### 5460 MHz Band Edge Signal Radiated Field Strength

Frequency MHz	Level dB $\mu$ V/m	Pol v/h	FCC 15.209		Detector Pk/QP/Avg	Azimuth degrees	Height meters	Comments
			Limit	Margin				
5458.720	49.9	H	54.0	-4.1	AVG	140	1.0	POS; RB 1 MHz; VB: 10 Hz
5458.720	48.7	V	54.0	-5.3	AVG	215	1.0	POS; RB 1 MHz; VB: 10 Hz
5459.200	64.8	H	74.0	-9.2	PK	140	1.0	POS; RB 1 MHz; VB: 3 MHz
5457.270	64.1	V	74.0	-9.9	PK	215	1.0	POS; RB 1 MHz; VB: 3 MHz

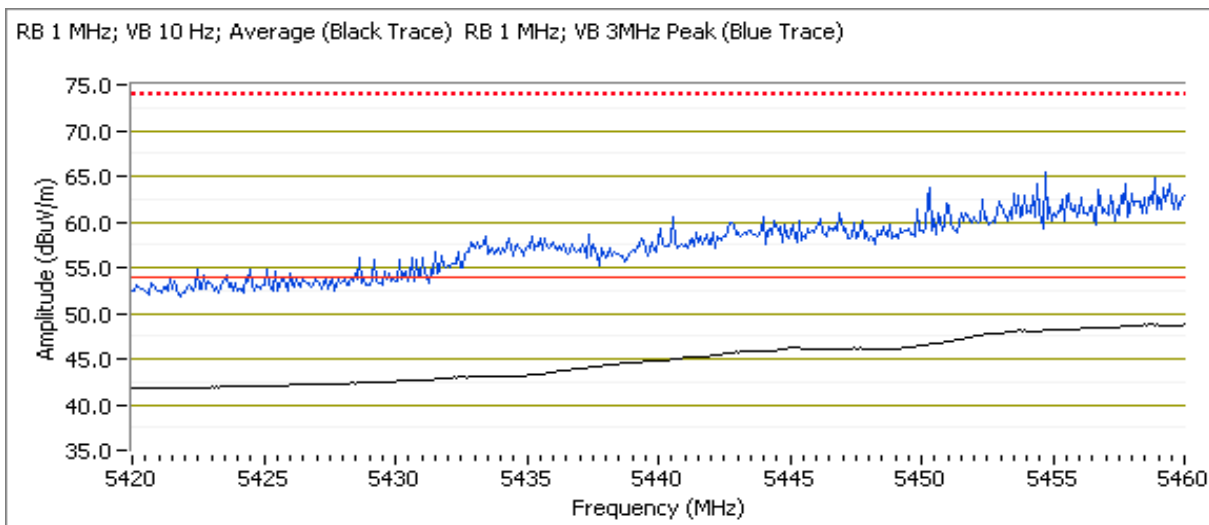



# EMC Test Data

Client: Intel Corporation	Job Number: J94914
Model: 7265D2W	T-Log Number: T95472
Contact: Steve Hackett	Project Manager: Christine Krebill
Standard: FCC Part 15.247, 15.407, RSS-210	Project Coordinator: -
	Class: N/A

## 5470 MHz Band Edge Signal Radiated Field Strength

Frequency MHz	Level dB $\mu$ V/m	Pol v/h	15.E		Detector Pk/QP/Avg	Azimuth degrees	Height meters	Comments
			Limit	Margin				
5460.760	66.5	H	68.3	-1.8	PK	140	1.0	POS; RB 1 MHz; VB: 3 MHz
5461.940	65.4	V	68.3	-2.9	PK	215	1.0	POS; RB 1 MHz; VB: 3 MHz

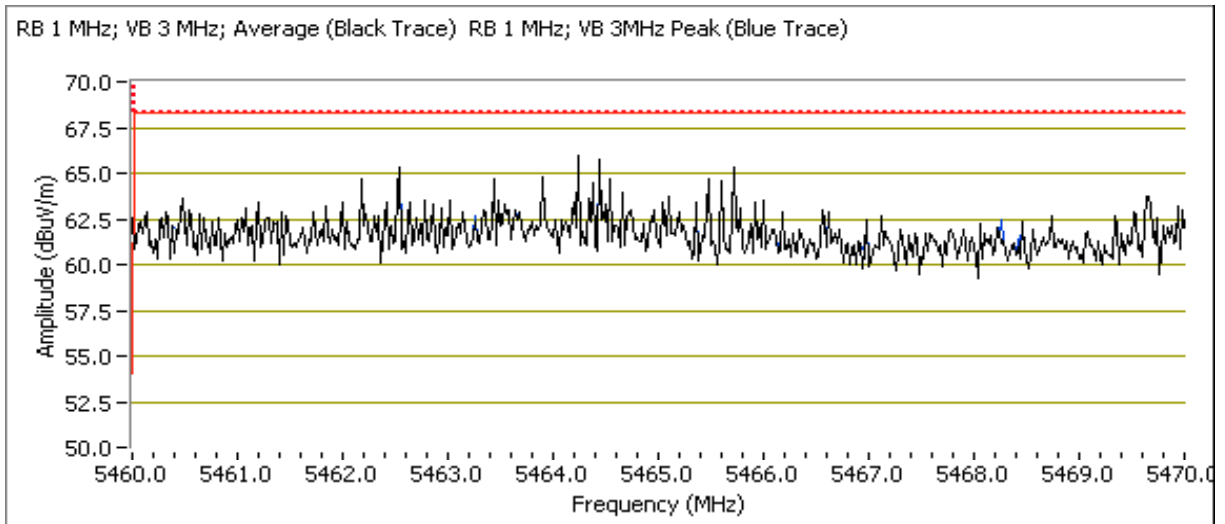



# EMC Test Data

Client:	Intel Corporation	Job Number:	J94914
Model:	7265D2W	T-Log Number:	T95472
Contact:	Steve Hackett	Project Manager:	Christine Krebill
Standard:	FCC Part 15.247, 15.407, RSS-210	Project Coordinator:	-
		Class:	N/A

## RSS 210 and FCC 15.407 (UNII) Radiated Spurious Emissions

### Test Specific Details

Objective: The objective of this test session is to perform final qualification testing of the EUT with respect to the specification listed above.

### General Test Configuration

The EUT and all local support equipment were located on the turntable for radiated spurious emissions testing. For radiated emissions testing the measurement antenna was located 3 meters from the EUT, unless otherwise noted.

**Ambient Conditions:** Temperature: 23-25 °C  
Rel. Humidity: 30-35 %

### Summary of Results

Run #	Mode	Channel	Power Setting	Measured Power	Test Performed	Limit	Result / Margin
<b>20MHz Bandwith Modes</b>							
1	a	36 - 5180MHz	23.5	14.0	Restricted Band Edge at 5150 MHz	15.209	48.0 dBµV/m @ 5150.0 MHz (-6.0 dB)
2	a	64 - 5320MHz	23.5	13.7	Restricted Band Edge at 5350 MHz	15.209	44.8 dBµV/m @ 5350.0 MHz (-9.2 dB)
3	a	100 - 5500MHz	23.0	13.6	Restricted Band Edge at 5460 MHz	15.209	44.4 dBµV/m @ 5460.0 MHz (-9.6 dB)
	a	100 - 5500MHz	23.0	13.6	Band Edge 5460 - 5470 MHz	15E	57.6 dBµV/m @ 5469.6 MHz (-10.7 dB)
	a	140 - 5700MHz	23.5	13.0	Band Edge 5725MHz	15E	57.5 dBµV/m @ 5756.6 MHz (-10.8 dB)
4	n20	36 - 5180MHz	24.0	14.3	Restricted Band Edge at 5150 MHz	15.209	46.9 dBµV/m @ 5150.0 MHz (-7.1 dB)
5	n20	64 - 5320MHz	23.5	13.7	Restricted Band Edge at 5350 MHz	15.209	46.6 dBµV/m @ 5350.0 MHz (-7.4 dB)
6	n20	100 - 5500MHz	23.0	13.6	Restricted Band Edge at 5460 MHz	15.209	45.6 dBµV/m @ 5460.0 MHz (-8.4 dB)
	n20	100 - 5500MHz	23.0	13.6	Band Edge 5460 - 5470 MHz	15E	64.2 dBµV/m @ 5469.2 MHz (-4.1 dB)
	n20	140 - 5700MHz	23.5	13.0	Band Edge 5725MHz	15E	57.6 dBµV/m @ 5725.2 MHz (-10.7 dB)



# EMC Test Data

Client: Intel Corporation	Job Number: J94914
Model: 7265D2W	T-Log Number: T95472
Contact: Steve Hackett	Project Manager: Christine Krebill
Standard: FCC Part 15.247, 15.407, RSS-210	Project Coordinator: -
	Class: N/A

## Summary of Results

Run #	Mode	Channel	Power Setting	Measured Power	Test Performed	Limit	Result / Margin
<b>40MHz Bandwith Modes</b>							
7	n40	38 - 5190MHz	23.0	13.4	Restricted Band Edge at 5150 MHz	15.209	46.4 dBµV/m @ 5150.0 MHz (-7.6 dB)
8	n40	62 - 5310MHz	23.5	13.7	Restricted Band Edge at 5350 MHz	15.209	47.3 dBµV/m @ 5350.0 MHz (-6.7 dB)
9	n40	102 - 5510MHz	23.5	14.0	Restricted Band Edge at 5460 MHz	15.209	45.5 dBµV/m @ 5460.0 MHz (-8.5 dB)
	n40	102 - 5510MHz	23.5	14.0	Band Edge 5460 - 5470 MHz	15E	62.2 dBµV/m @ 5467.3 MHz (-6.1 dB)
	n40	134 - 5670MHz	28.0	15.7	Band Edge 5725MHz	15E	67.7 dBµV/m @ 5726.0 MHz (-0.6 dB)
<b>80MHz Bandwith Modes</b>							
10	ac80	42 - 5210MHz	21.0	13.6	Restricted Band Edge at 5150 MHz	15.209	49.7 dBµV/m @ 5143.7 MHz (-4.3 dB)
11	ac80	58 - 5290MHz	23.5	13.8	Restricted Band Edge at 5350 MHz	15.209	53.7 dBµV/m @ 5352.2 MHz (-0.3 dB)
11	ac80	58 - 5290MHz	23.0	13.5	Restricted Band Edge at 5350 MHz	15.209	53.3 dBµV/m @ 5350.0 MHz (-0.7 dB)
12	ac80	106 - 5530MHz	22.0	13.6	Restricted Band Edge at 5460 MHz	15.209	51.7 dBµV/m @ 5459.9 MHz (-2.3 dB)
	ac80	106 - 5530MHz	22.0	13.6	Band Edge 5460 - 5470 MHz	15E	67.2 dBµV/m @ 5464.0 MHz (-1.1 dB)

### Modifications Made During Testing

No modifications were made to the EUT during testing

### Deviations From The Standard

No deviations were made from the requirements of the standard.

Note - measured powers are average power measured with a power meter, for reference only.





# EMC Test Data

Client:	Intel Corporation	Job Number:	J94914
Model:	7265D2W	T-Log Number:	T95472
		Project Manager:	Christine Krebill
Contact:	Steve Hackett	Project Coordinator:	-
Standard:	FCC Part 15.247, 15.407, RSS-210	Class:	N/A

## Procedure Comments:

Measurements performed in accordance with FCC KDB 789033

Peak measurements performed with: RBW=1MHz, VBW=3MHz, peak detector, max hold, auto sweep time

Unless otherwise stated/noted, emission has duty cycle  $\geq 98\%$  and was measured using RBW=1MHz, VBW=10Hz, peak detector, linear average mode, auto sweep time, max hold.

Mode	Data Rate	Duty Cycle (x)	Constant DC?	T (ms)	Pwr Cor Factor*	Lin Volt Cor Factor**	Min VBW for FS (Hz)
11a	6.0Mbps	99%	Constant	2.06	0.0	0.0	485
n20	6.5Mbps	98%	Constant	1.92	0.0	0.0	521
n40	13.5Mbps	97%	Constant	0.94	0.1	0.3	1064
ac80	29.3Mbps	94%	Constant	0.44	0.3	0.6	2273

## Sample Notes

MAC Address: 001500F15B3A DRTU Tool Version 1.7.3-935 Driver version 17.1.0.11

Antenna: Skycross WiMax/WLAN

## Measurement Specific Notes:

Note 1:	For emissions outside of the restricted bands the limit is -27dBm/MHz eirp (68.3dBuV/m). The measurement method required is a peak measurement (RB=1MHz, VB $\geq$ 3MHz, peak detector). Per KDB 789033 2) c) (i), compliance can be demonstrated by meeting the average and peak limits of 15.209, as an alternative.
Note 2:	Emission has duty cycle $\geq 98\%$ , average measurement performed: RBW=1MHz, VBW=3MHz, RMS, Power averaging, auto sweep, trace average 100 traces
Note 3:	Emission has duty cycle $< 98\%$ , but constant, average measurement performed: RBW=1MHz, VBW=10Hz, peak detector, linear averaging, auto sweep, trace average 100 * 1/DC traces, measurement corrected by Linear Voltage correction factor
Note 4:	Emission has duty cycle $< 98\%$ and is NOT constant, average measurement performed: RBW=1MHz, VBW $>$ 1/T, peak detector, linear average mode, sweep time auto, max hold. Max hold for 50*(1/DC) traces
Note 5:	Emission has duty cycle $< 98\%$ , but constant, average measurement performed: RBW=1MHz, VBW=3MHz, RMS, Power averaging, auto sweep, trace average 100 * 1/DC traces, measurement corrected by Pwr correction factor
Note 6:	Plots of the average and peak bandedge do not account for any duty cycle correction. Refer to the tabluar results for final measurements.



# EMC Test Data

Client: Intel Corporation	Job Number: J94914
Model: 7265D2W	T-Log Number: T95472
Contact: Steve Hackett	Project Manager: Christine Krebill
Standard: FCC Part 15.247, 15.407, RSS-210	Project Coordinator: -
	Class: N/A

## Run #1: Radiated Bandedge Measurements, 5150-5250MHz

Date of Test: 06/10/14  
 Test Location: Chamber #5

Config. Used: 1  
 Test Engineer: J. Liu

Channel: 36 - 5180 MHz  
 Tx Chain: B  
 Mode: a  
 Data Rate: 6.0Mbps

Power Settings		
Target (dBm)	Measured (dBm)	Software Setting
14.0	14.0	23.5

### 5150 MHz Band Edge Signal Radiated Field Strength

Frequency MHz	Level dB $\mu$ V/m	Pol v/h	FCC 15.209		Detector Pk/QP/Avg	Azimuth degrees	Height meters	Comments
			Limit	Margin				
5150.000	48.0	H	54.0	-6.0	AVG	102	1.0	POS; RB 1 MHz; VB: 10 Hz
5148.960	63.8	H	74.0	-10.2	PK	102	1.0	POS; RB 1 MHz; VB: 3 MHz
5150.000	46.5	V	54.0	-7.5	AVG	136	1.7	POS; RB 1 MHz; VB: 10 Hz
5146.230	60.7	V	74.0	-13.3	PK	136	1.7	POS; RB 1 MHz; VB: 3 MHz

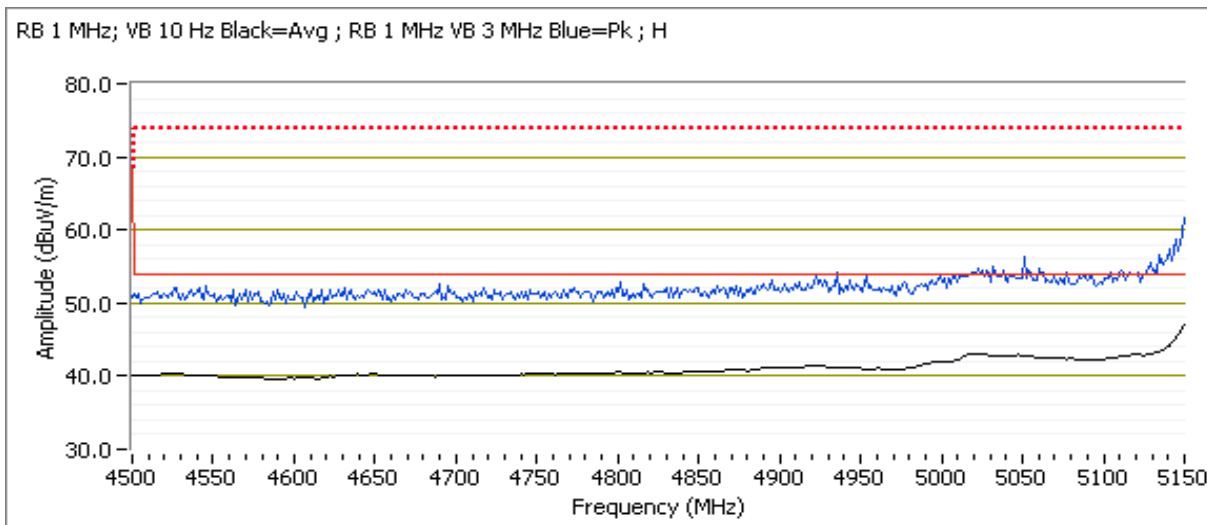



# EMC Test Data

Client: Intel Corporation	Job Number: J94914
Model: 7265D2W	T-Log Number: T95472
Contact: Steve Hackett	Project Manager: Christine Krebill
Standard: FCC Part 15.247, 15.407, RSS-210	Project Coordinator: -
	Class: N/A

## Run #2: Radiated Bandedge Measurements, 5250-5350MHz

Date of Test: 06/10/14  
 Test Location: Chamber #5

Config. Used: 1  
 Test Engineer: J. Liu

Channel: 64 - 5320MHz  
 Tx Chain: B  
 Mode: a  
 Data Rate: 6.0Mbps

Power Settings		
Target (dBm)	Measured (dBm)	Software Setting
13.5	13.7	23.5

### 5350 MHz Band Edge Signal Radiated Field Strength

Frequency MHz	Level dB $\mu$ V/m	Pol v/h	FCC 15.209		Detector Pk/QP/Avg	Azimuth degrees	Height meters	Comments
			Limit	Margin				
5350.000	44.8	H	54.0	-9.2	AVG	99	1.3	POS; RB 1 MHz; VB: 10 Hz
5454.270	57.3	H	74.0	-16.7	PK	99	1.3	POS; RB 1 MHz; VB: 3 MHz
5389.920	43.7	V	54.0	-10.3	AVG	68	1.0	POS; RB 1 MHz; VB: 10 Hz
5367.960	56.1	V	74.0	-17.9	PK	68	1.0	POS; RB 1 MHz; VB: 3 MHz

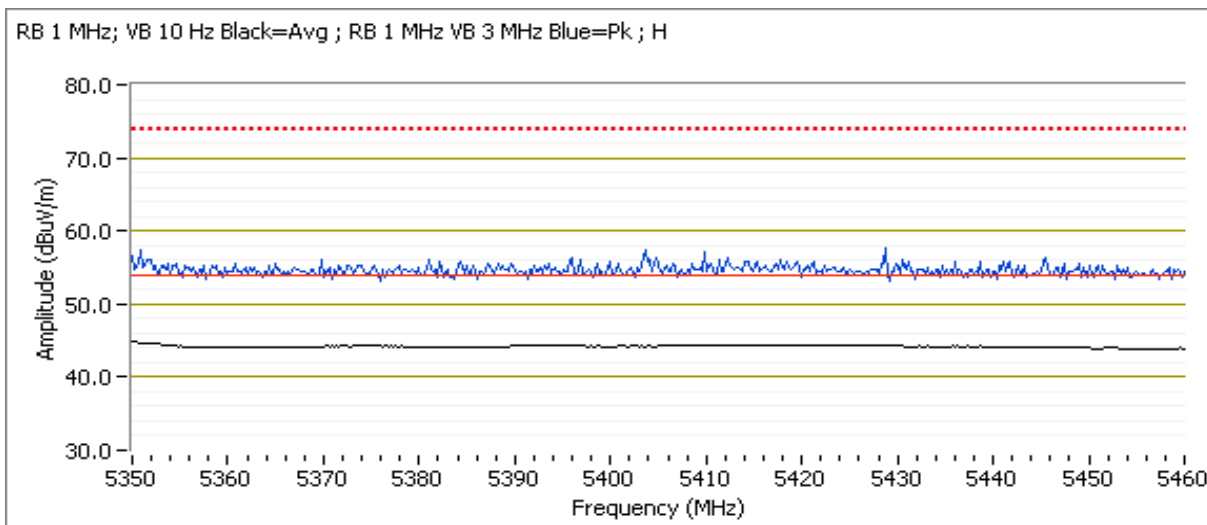



# EMC Test Data

Client: Intel Corporation	Job Number: J94914
Model: 7265D2W	T-Log Number: T95472
Contact: Steve Hackett	Project Manager: Christine Krebill
Standard: FCC Part 15.247, 15.407, RSS-210	Project Coordinator: -
	Class: N/A

## Run #3: Radiated Bandedge Measurements, 5470-5725MHz

Date of Test: 06/10/14  
 Test Location: Chamber #5

Config. Used: 1  
 Test Engineer: J. Liu

Channel: 100 - 5500MHz  
 Tx Chain: B  
 Mode: a  
 Data Rate: 6.0Mbps

Power Settings		
Target (dBm)	Measured (dBm)	Software Setting
13.5	13.6	23.0

### 5460 MHz Band Edge Signal Radiated Field Strength

Frequency MHz	Level dB $\mu$ V/m	Pol v/h	FCC 15.209		Detector Pk/QP/Avg	Azimuth degrees	Height meters	Comments
			Limit	Margin				
5460.000	44.4	H	54.0	-9.6	AVG	101	1.2	POS; RB 1 MHz; VB: 10 Hz
5448.980	57.0	H	74.0	-17.0	PK	101	1.2	POS; RB 1 MHz; VB: 3 MHz
5410.620	43.9	V	54.0	-10.1	AVG	356	1.6	POS; RB 1 MHz; VB: 10 Hz
5398.720	56.8	V	74.0	-17.2	PK	356	1.6	POS; RB 1 MHz; VB: 3 MHz

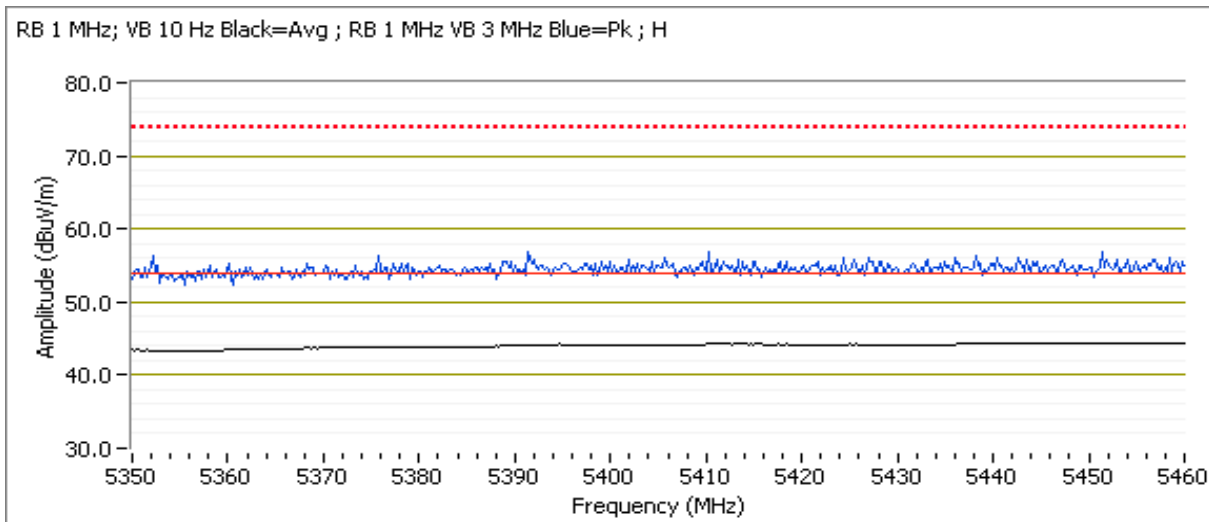



# EMC Test Data

Client: Intel Corporation	Job Number: J94914
Model: 7265D2W	T-Log Number: T95472
Contact: Steve Hackett	Project Manager: Christine Krebill
Standard: FCC Part 15.247, 15.407, RSS-210	Project Coordinator: -
	Class: N/A

### 5470 MHz Band Edge Signal Radiated Field Strength

Frequency MHz	Level dB $\mu$ V/m	Pol v/h	15.E		Detector Pk/QP/Avg	Azimuth degrees	Height meters	Comments
			Limit	Margin				
5469.600	57.6	H	68.3	-10.7	PK	102	1.0	POS; RB 1 MHz; VB: 3 MHz
5469.620	57.1	V	68.3	-11.2	PK	357	1.0	POS; RB 1 MHz; VB: 3 MHz

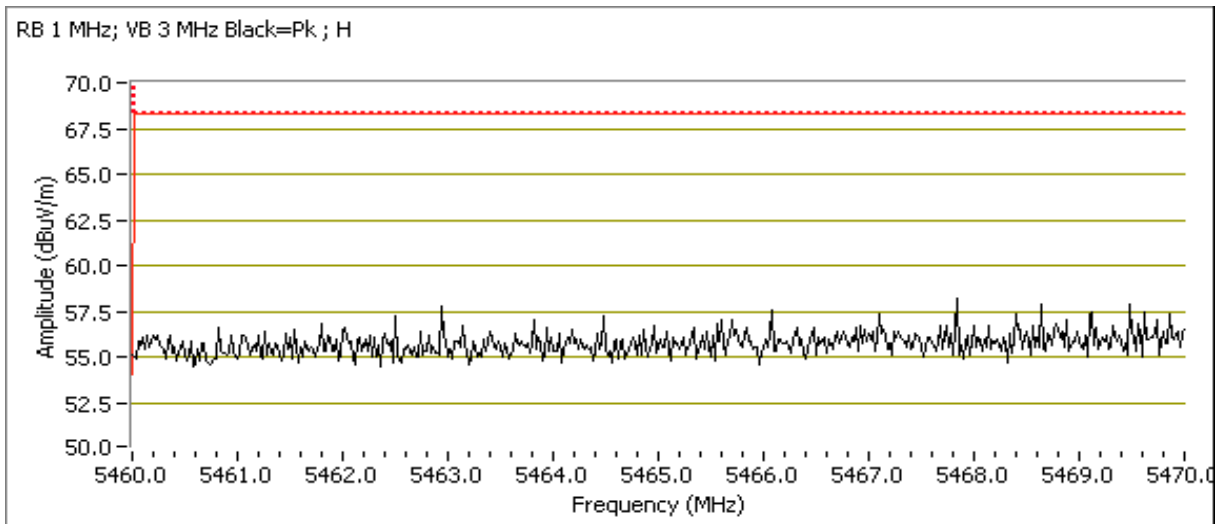



# EMC Test Data

Client:	Intel Corporation	Job Number:	J94914
Model:	7265D2W	T-Log Number:	T95472
Contact:	Steve Hackett	Project Manager:	Christine Krebill
Standard:	FCC Part 15.247, 15.407, RSS-210	Project Coordinator:	-
		Class:	N/A

Channel: 140 - 5700MHz  
 Tx Chain: B  
 Mode: a  
 Data Rate: 6.0Mbps

Power Settings		
Target (dBm)	Measured (dBm)	Software Setting
13.0	13.0	23.5

### 5725 MHz Band Edge Signal Radiated Field Strength

Frequency	Level	Pol	15.E		Detector	Azimuth	Height	Comments
MHz	dB $\mu$ V/m	v/h	Limit	Margin	Pk/QP/Avg	degrees	meters	
5756.580	57.5	H	68.3	-10.8	PK	102	1.2	POS; RB 1 MHz; VB: 3 MHz
5763.080	55.8	V	68.3	-12.5	PK	230	2.0	POS; RB 1 MHz; VB: 3 MHz

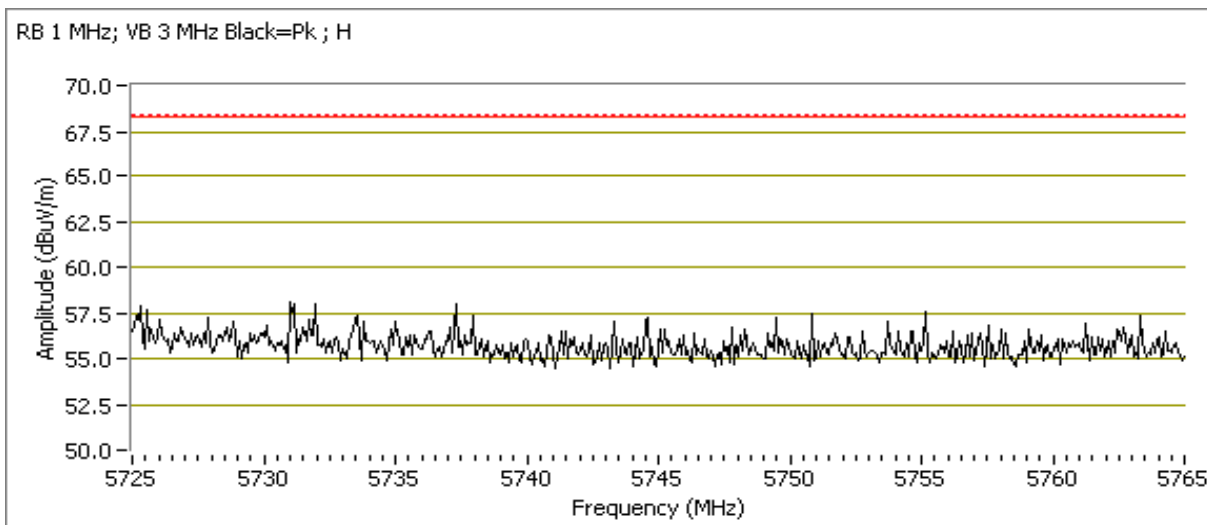



# EMC Test Data

Client: Intel Corporation	Job Number: J94914
Model: 7265D2W	T-Log Number: T95472
Contact: Steve Hackett	Project Manager: Christine Krebill
Standard: FCC Part 15.247, 15.407, RSS-210	Project Coordinator: -
	Class: N/A

## Run #4: Radiated Bandedge Measurements, 5150-5250MHz

Date of Test: 06/10/14  
 Test Location: Chamber #5

Config. Used: 1  
 Test Engineer: J. Liu

Channel: 36 - 5180 MHz  
 Tx Chain: B  
 Mode: n20  
 Data Rate: 6.5Mbps

Power Settings		
Target (dBm)	Measured (dBm)	Software Setting
14.0	14.3	24.0

### 5150 MHz Band Edge Signal Radiated Field Strength

Frequency MHz	Level dB $\mu$ V/m	Pol v/h	FCC 15.209		Detector Pk/QP/Avg	Azimuth degrees	Height meters	Comments
			Limit	Margin				
5150.000	46.9	H	54.0	-7.1	AVG	97	1.0	POS; RB 1 MHz; VB: 10 Hz
5148.880	62.4	H	74.0	-11.6	PK	97	1.0	POS; RB 1 MHz; VB: 3 MHz
5150.000	46.5	V	54.0	-7.5	AVG	134	1.7	POS; RB 1 MHz; VB: 10 Hz
5146.390	61.8	V	74.0	-12.2	PK	134	1.7	POS; RB 1 MHz; VB: 3 MHz

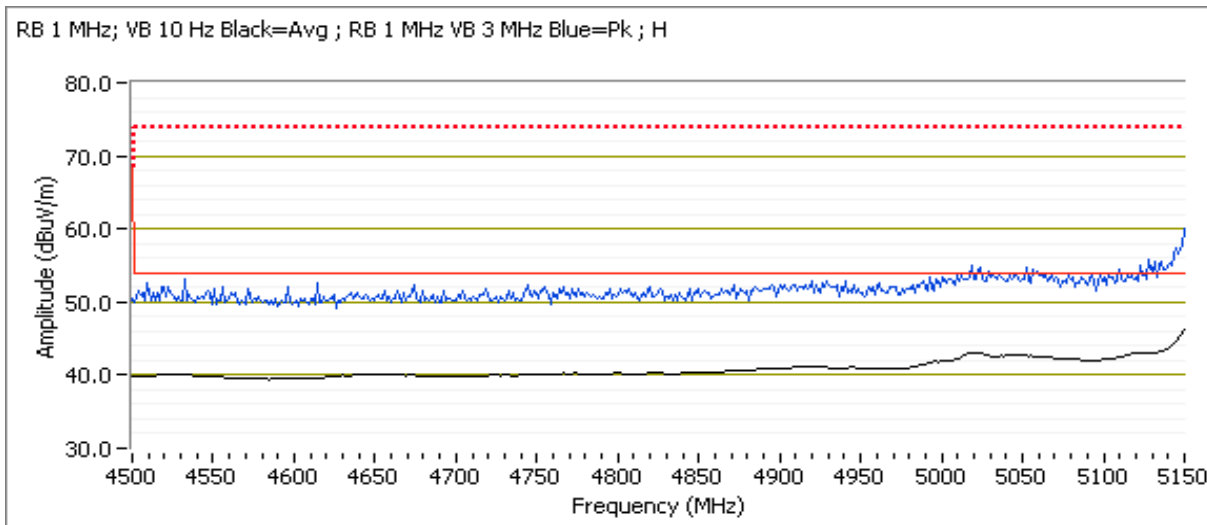



# EMC Test Data

Client: Intel Corporation	Job Number: J94914
Model: 7265D2W	T-Log Number: T95472
Contact: Steve Hackett	Project Manager: Christine Krebill
Standard: FCC Part 15.247, 15.407, RSS-210	Project Coordinator: -
	Class: N/A

## Run #5: Radiated Bandedge Measurements, 5250-5350MHz

Date of Test: 06/10/14  
 Test Location: Chamber #5

Config. Used: 1  
 Test Engineer: J. Liu

Channel: 64 - 5320MHz  
 Tx Chain: B  
 Mode: n20  
 Data Rate: 6.5Mbps

Power Settings		
Target (dBm)	Measured (dBm)	Software Setting
13.5	13.7	23.5

### 5350 MHz Band Edge Signal Radiated Field Strength

Frequency MHz	Level dB $\mu$ V/m	Pol v/h	FCC 15.209		Detector Pk/QP/Avg	Azimuth degrees	Height meters	Comments
			Limit	Margin				
5350.000	46.6	H	54.0	-7.4	AVG	97	1.4	POS; RB 1 MHz; VB: 10 Hz
5351.680	59.9	H	74.0	-14.1	PK	97	1.4	POS; RB 1 MHz; VB: 3 MHz
5350.080	44.7	V	54.0	-9.3	AVG	125	1.6	POS; RB 1 MHz; VB: 10 Hz
5352.160	58.5	V	74.0	-15.5	PK	125	1.6	POS; RB 1 MHz; VB: 3 MHz

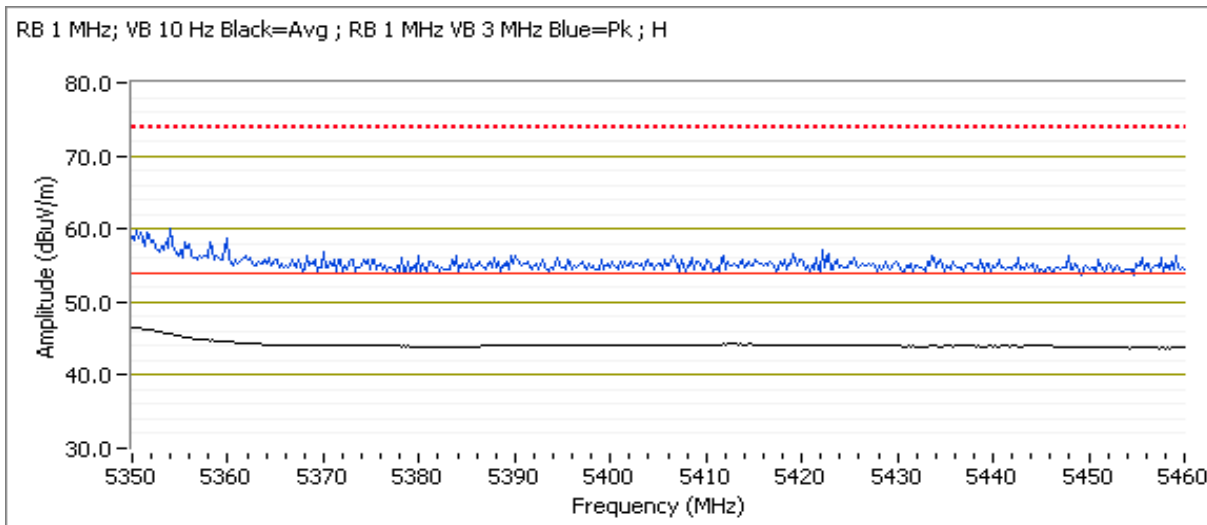





# EMC Test Data

Client: Intel Corporation	Job Number: J94914
Model: 7265D2W	T-Log Number: T95472
Contact: Steve Hackett	Project Manager: Christine Krebill
Standard: FCC Part 15.247, 15.407, RSS-210	Project Coordinator: -
	Class: N/A

## Run #6: Radiated Bandedge Measurements, 5470-5725MHz

Date of Test: 06/10/14  
 Test Location: Chamber #5

Config. Used: 1  
 Test Engineer: J. Liu

Channel: 100 - 5500MHz  
 Tx Chain: B  
 Mode: n20  
 Data Rate: 6.5Mbps

Power Settings		
Target (dBm)	Measured (dBm)	Software Setting
13.5	13.6	23.0

### 5460 MHz Band Edge Signal Radiated Field Strength

Frequency MHz	Level dB $\mu$ V/m	Pol v/h	FCC 15.209		Detector Pk/QP/Avg	Azimuth degrees	Height meters	Comments
			Limit	Margin				
5460.000	45.6	H	54.0	-8.4	AVG	94	1.1	POS; RB 1 MHz; VB: 10 Hz
5459.120	58.9	H	74.0	-15.1	PK	94	1.1	POS; RB 1 MHz; VB: 3 MHz
5423.290	43.8	V	54.0	-10.2	AVG	0	1.0	POS; RB 1 MHz; VB: 10 Hz
5435.950	56.4	V	74.0	-17.6	PK	0	1.0	POS; RB 1 MHz; VB: 3 MHz

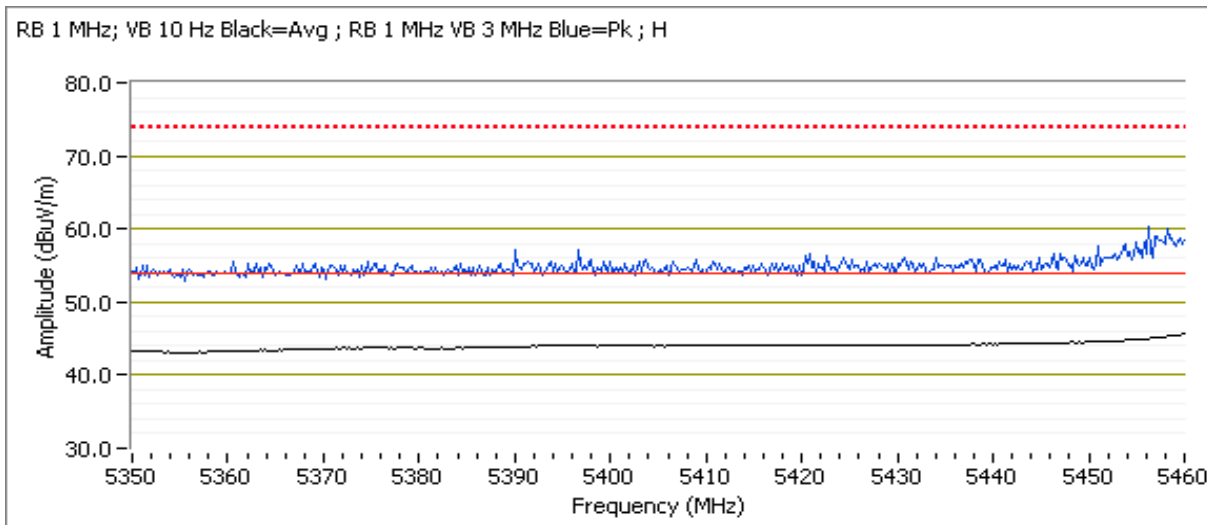



# EMC Test Data

Client: Intel Corporation	Job Number: J94914
Model: 7265D2W	T-Log Number: T95472
Contact: Steve Hackett	Project Manager: Christine Krebill
Standard: FCC Part 15.247, 15.407, RSS-210	Project Coordinator: -
	Class: N/A

### 5470 MHz Band Edge Signal Radiated Field Strength

Frequency MHz	Level dB $\mu$ V/m	Pol v/h	15.E		Detector Pk/QP/Avg	Azimuth degrees	Height meters	Comments
			Limit	Margin				
5469.220	64.2	H	68.3	-4.1	PK	95	1.0	POS; RB 1 MHz; VB: 3 MHz
5469.120	59.9	V	68.3	-8.4	PK	257	1.0	POS; RB 1 MHz; VB: 3 MHz

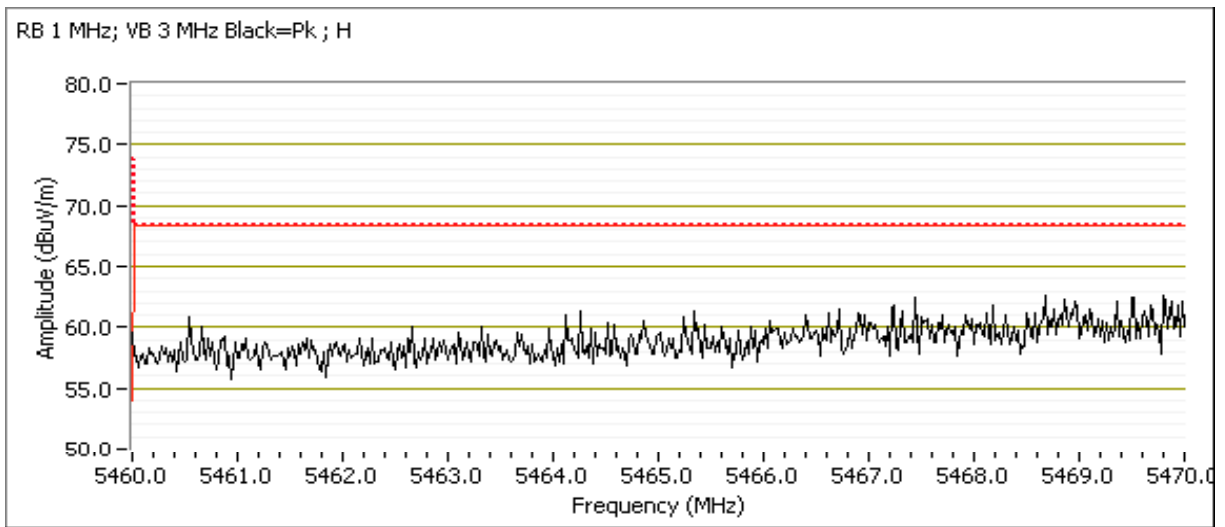



# EMC Test Data

Client:	Intel Corporation	Job Number:	J94914
Model:	7265D2W	T-Log Number:	T95472
Contact:	Steve Hackett	Project Manager:	Christine Krebill
Standard:	FCC Part 15.247, 15.407, RSS-210	Project Coordinator:	-
		Class:	N/A

Channel: 140 - 5700MHz  
 Tx Chain: B  
 Mode: n20  
 Data Rate: 6.5Mbps

Power Settings		
Target (dBm)	Measured (dBm)	Software Setting
13.0	13.0	23.5

### 5725 MHz Band Edge Signal Radiated Field Strength

Frequency	Level	Pol	15.E		Detector	Azimuth	Height	Comments
MHz	dB $\mu$ V/m	v/h	Limit	Margin	Pk/QP/Avg	degrees	meters	
5725.160	57.6	H	68.3	-10.7	PK	100	1.2	POS; RB 1 MHz; VB: 3 MHz
5760.350	56.9	V	68.3	-11.4	PK	211	1.2	POS; RB 1 MHz; VB: 3 MHz

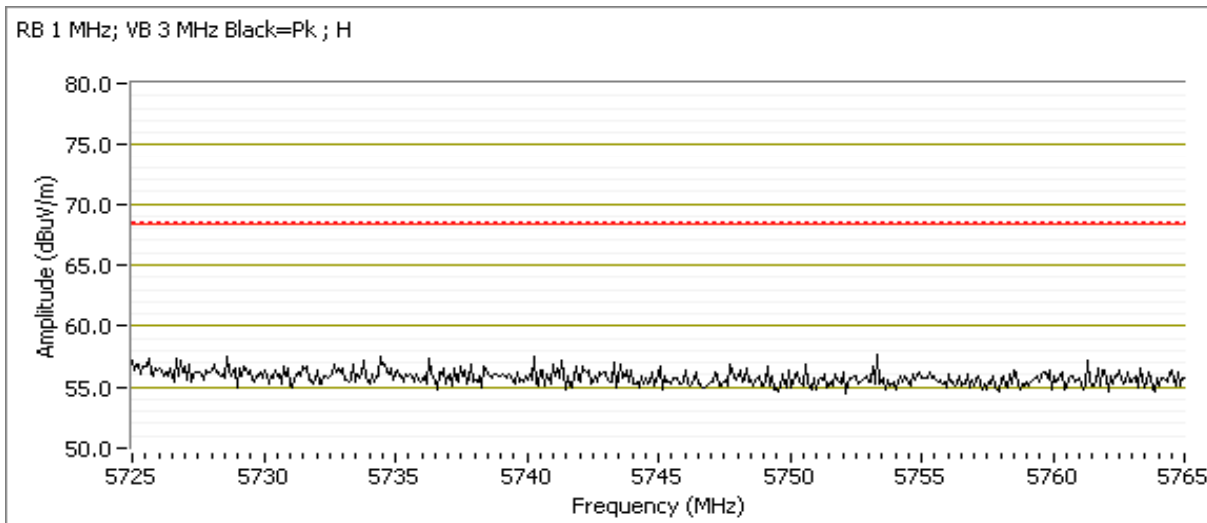



# EMC Test Data

Client: Intel Corporation	Job Number: J94914
Model: 7265D2W	T-Log Number: T95472
Contact: Steve Hackett	Project Manager: Christine Krebill
Standard: FCC Part 15.247, 15.407, RSS-210	Project Coordinator: -
	Class: N/A

## Run #7: Radiated Bandedge Measurements, 5150-5250MHz

Date of Test: 06/10/14  
 Test Location: Chamber #5

Config. Used: 1  
 Test Engineer: J. Liu

Channel: 38 - 5190 MHz  
 Tx Chain: B  
 Mode: n40  
 Data Rate: 13.5Mbps

Power Settings		
Target (dBm)	Measured (dBm)	Software Setting
13.5	13.4	23.0

### 5150 MHz Band Edge Signal Radiated Field Strength

Frequency MHz	Level dB $\mu$ V/m	Pol v/h	FCC 15.209		Detector Pk/QP/Avg	Azimuth degrees	Height meters	Comments
			Limit	Margin				
5150.000	46.4	H	54.0	-7.6	AVG	99	1.0	Note 3, POS; RB 1MHz; VB: 10Hz
5148.880	58.6	H	74.0	-15.4	PK	99	1.0	POS; RB 1 MHz; VB: 3 MHz
5149.120	44.9	V	54.0	-9.1	AVG	131	1.5	Note 3, POS; RB 1MHz; VB: 10Hz
5147.920	56.5	V	74.0	-17.5	PK	131	1.5	POS; RB 1 MHz; VB: 3 MHz

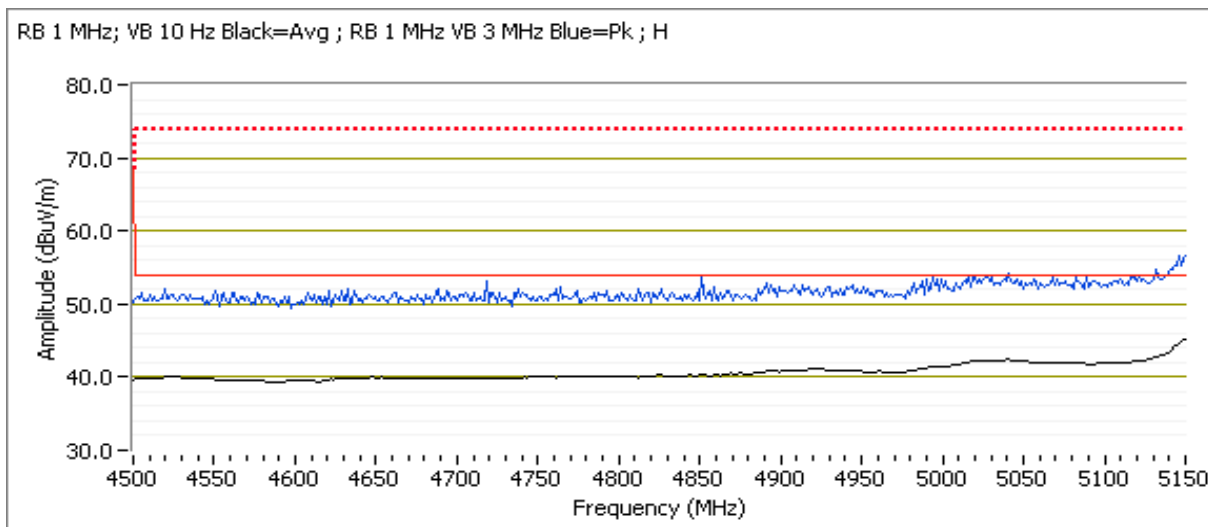



# EMC Test Data

Client: Intel Corporation	Job Number: J94914
Model: 7265D2W	T-Log Number: T95472
Contact: Steve Hackett	Project Manager: Christine Krebill
Standard: FCC Part 15.247, 15.407, RSS-210	Project Coordinator: -
	Class: N/A

## Run #8: Radiated Bandedge Measurements, 5250-5350MHz

Date of Test: 06/10/14  
 Test Location: Chamber #5

Config. Used: 1  
 Test Engineer: R. Varelas

Channel: 62 - 5310MHz  
 Tx Chain: B  
 Mode: n40  
 Data Rate: 13.5Mbps

Power Settings		
Target (dBm)	Measured (dBm)	Software Setting
13.5	13.7	23.5

### 5350 MHz Band Edge Signal Radiated Field Strength

Frequency MHz	Level dB $\mu$ V/m	Pol v/h	FCC 15.209		Detector Pk/QP/Avg	Azimuth degrees	Height meters	Comments
			Limit	Margin				
5350.000	47.3	H	54.0	-6.7	AVG	100	1.2	Note 3, POS; RB 1MHz; VB: 10Hz
5350.080	58.7	H	74.0	-15.3	PK	100	1.2	POS; RB 1 MHz; VB: 3 MHz
5350.080	45.1	V	54.0	-8.9	AVG	118	1.7	Note 3, POS; RB 1MHz; VB: 10Hz
5374.770	56.7	V	74.0	-17.3	PK	118	1.7	POS; RB 1 MHz; VB: 3 MHz

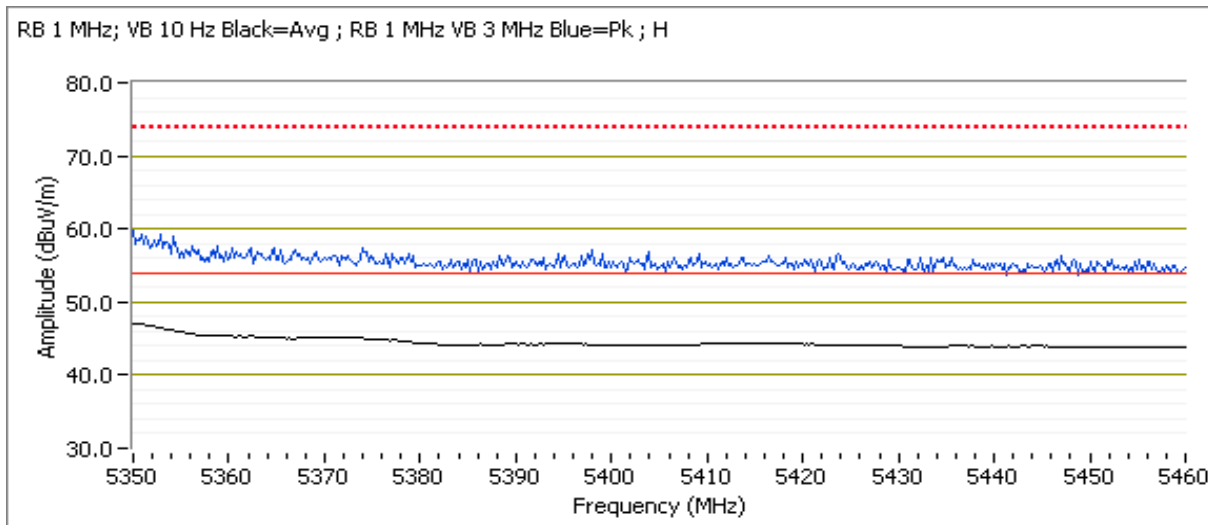



# EMC Test Data

Client: Intel Corporation	Job Number: J94914
Model: 7265D2W	T-Log Number: T95472
Contact: Steve Hackett	Project Manager: Christine Krebill
Standard: FCC Part 15.247, 15.407, RSS-210	Project Coordinator: -
	Class: N/A

## Run #9: Radiated Bandedge Measurements, 5470-5725MHz

Date of Test: 06/10/14  
 Test Location: Chamber #5

Config. Used: 1  
 Test Engineer: R. Varelas

Channel: 102 - 5510MHz  
 Tx Chain: B  
 Mode: n40  
 Data Rate: 13.5Mbps

Power Settings		
Target (dBm)	Measured (dBm)	Software Setting
14.0	14.0	23.5

### 5460 MHz Band Edge Signal Radiated Field Strength

Frequency MHz	Level dB $\mu$ V/m	Pol v/h	FCC 15.209		Detector Pk/QP/Avg	Azimuth degrees	Height meters	Comments
			Limit	Margin				
5460.000	45.5	H	54.0	-8.5	AVG	138	1.0	Note 3, POS; RB 1MHz; VB: 10Hz
5458.560	56.6	H	74.0	-17.4	PK	138	1.0	POS; RB 1 MHz; VB: 3 MHz
5459.680	45.0	V	54.0	-9.0	AVG	239	1.0	Note 3, POS; RB 1MHz; VB: 10Hz
5448.220	56.2	V	74.0	-17.8	PK	239	1.0	POS; RB 1 MHz; VB: 3 MHz

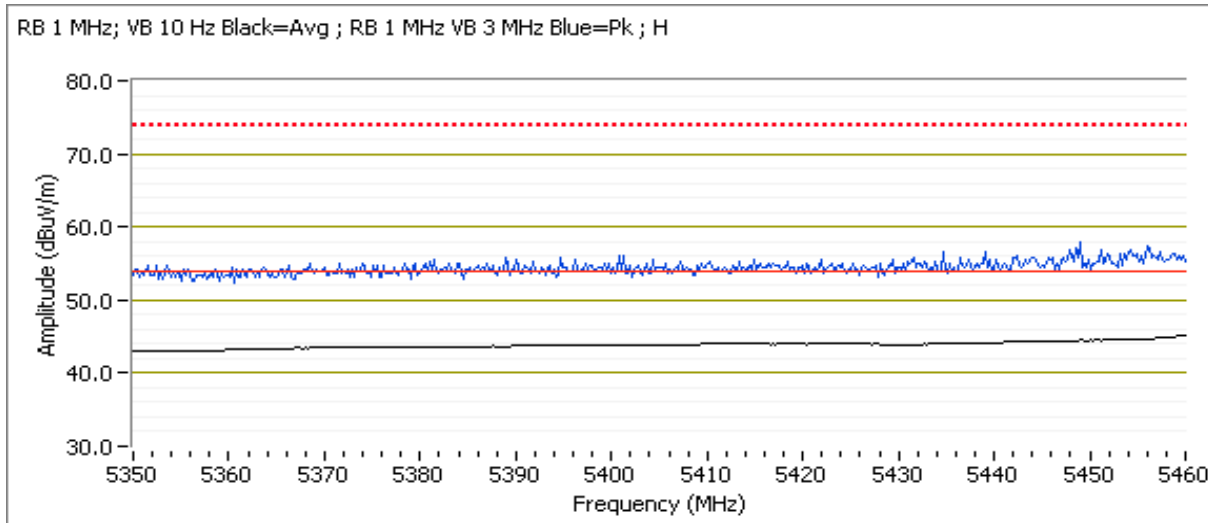



# EMC Test Data

Client: Intel Corporation	Job Number: J94914
Model: 7265D2W	T-Log Number: T95472
Contact: Steve Hackett	Project Manager: Christine Krebill
Standard: FCC Part 15.247, 15.407, RSS-210	Project Coordinator: -
	Class: N/A

### 5470 MHz Band Edge Signal Radiated Field Strength

Frequency MHz	Level dB $\mu$ V/m	Pol v/h	15.E		Detector Pk/QP/Avg	Azimuth degrees	Height meters	Comments
			Limit	Margin				
5467.330	62.2	H	68.3	-6.1	PK	138	1.0	POS; RB 1 MHz; VB: 3 MHz
5467.350	59.1	V	68.3	-9.2	PK	239	1.0	POS; RB 1 MHz; VB: 3 MHz

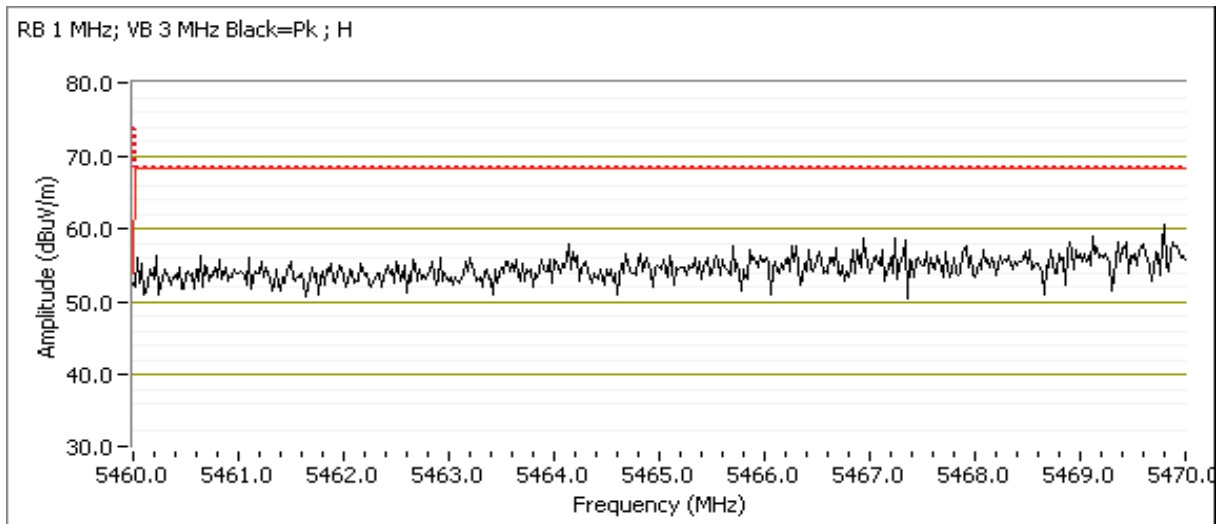



# EMC Test Data

Client: Intel Corporation	Job Number: J94914
Model: 7265D2W	T-Log Number: T95472
Contact: Steve Hackett	Project Manager: Christine Krebill
Standard: FCC Part 15.247, 15.407, RSS-210	Project Coordinator: -
	Class: N/A

Channel: 140 - 5700MHz  
 Tx Chain: B  
 Mode: n40  
 Data Rate: 13.5Mbps

Power Settings		
Target (dBm)	Measured (dBm)	Software Setting
16.5	15.7	28.0

### 5725 MHz Band Edge Signal Radiated Field Strength

Frequency	Level	Pol	15.E		Detector	Azimuth	Height	Comments
MHz	dB $\mu$ V/m	v/h	Limit	Margin	Pk/QP/Avg	degrees	meters	
5726.040	67.7	H	68.3	-0.6	PK	100	1.2	POS; RB 1 MHz; VB: 3 MHz
5728.130	65.8	V	68.3	-2.5	PK	230	1.1	POS; RB 1 MHz; VB: 3 MHz

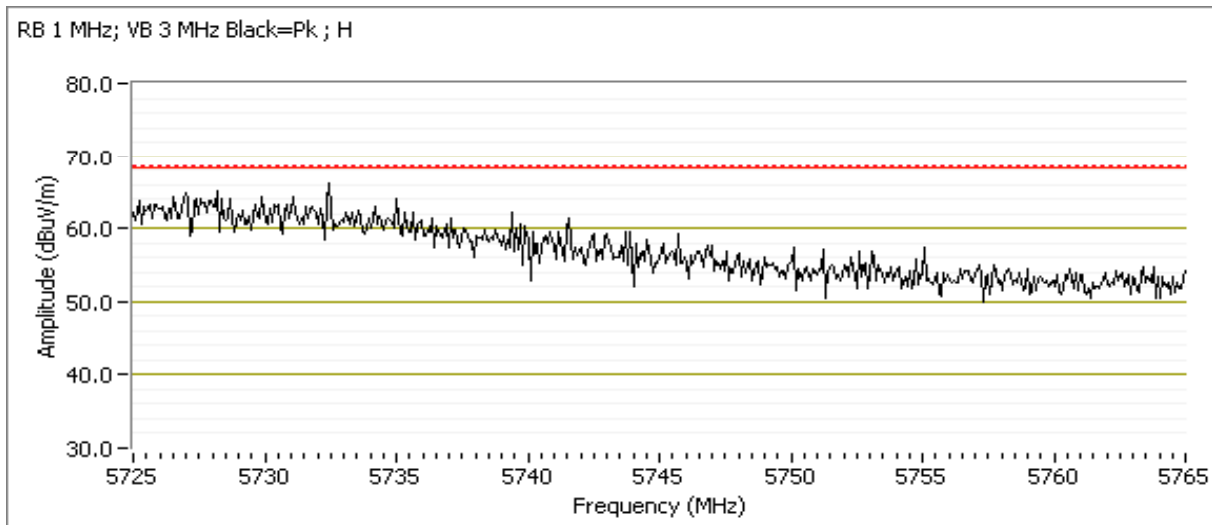





# EMC Test Data

Client: Intel Corporation	Job Number: J94914
Model: 7265D2W	T-Log Number: T95472
Contact: Steve Hackett	Project Manager: Christine Krebill
Standard: FCC Part 15.247, 15.407, RSS-210	Project Coordinator: -
	Class: N/A

## Run #10: Radiated Bandedge Measurements, 5150-5250MHz

Date of Test: 06/10/14  
 Test Location: Chamber #5

Config. Used: 1  
 Test Engineer: R. Varelas

Channel: 42 - 5210MHz  
 Tx Chain: B  
 Mode: ac80  
 Data Rate: 29.3Mbps

Power Settings		
Target (dBm)	Measured (dBm)	Software Setting
13.5	13.6	21.0

### 5150 MHz Band Edge Signal Radiated Field Strength

Frequency MHz	Level dB $\mu$ V/m	Pol v/h	FCC 15.209		Detector Pk/QP/Avg	Azimuth degrees	Height meters	Comments
			Limit	Margin				
5143.670	49.7	H	54.0	-4.3	AVG	105	1.0	Note 3, POS; RB 1MHz; VB: 10Hz
5146.070	63.5	H	74.0	-10.5	PK	105	1.0	POS; RB 1 MHz; VB: 3 MHz
5145.190	46.7	V	54.0	-7.3	AVG	122	1.3	Note 3, POS; RB 1MHz; VB: 10Hz
5145.110	58.9	V	74.0	-15.1	PK	122	1.3	POS; RB 1 MHz; VB: 3 MHz

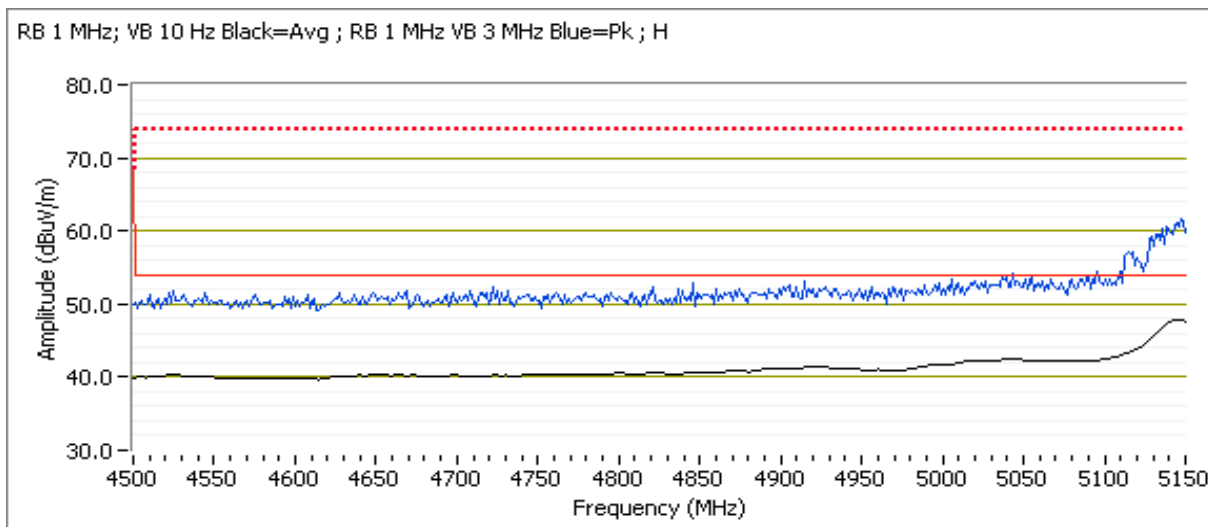



# EMC Test Data

Client: Intel Corporation	Job Number: J94914
Model: 7265D2W	T-Log Number: T95472
Contact: Steve Hackett	Project Manager: Christine Krebill
Standard: FCC Part 15.247, 15.407, RSS-210	Project Coordinator: -
	Class: N/A

## Run #11: Radiated Bandedge Measurements, 5250-5350MHz

Date of Test: 06/10/14  
 Test Location: Chamber #5

Config. Used: 1  
 Test Engineer: R. Varelas

Channel: 58 - 5290MHz  
 Tx Chain: B  
 Mode: ac80  
 Data Rate: 29.3Mbps

Power Settings		
Target (dBm)	Measured (dBm)	Software Setting
13.5	13.5	23.0

### 5350 MHz Band Edge Signal Radiated Field Strength

Frequency MHz	Level dB $\mu$ V/m	Pol v/h	FCC 15.209		Detector Pk/QP/Avg	Azimuth degrees	Height meters	Comments
			Limit	Margin				
5350.000	53.3	H	54.0	-0.7	AVG	97	1.0	Note 3, POS; RB 1MHz; VB: 10Hz
5351.520	65.9	H	74.0	-8.1	PK	97	1.0	POS; RB 1 MHz; VB: 3 MHz
5350.000	50.1	V	54.0	-3.9	AVG	121	1.6	Note 3, POS; RB 1MHz; VB: 10Hz
5352.480	62.6	V	74.0	-11.4	PK	121	1.6	POS; RB 1 MHz; VB: 3 MHz

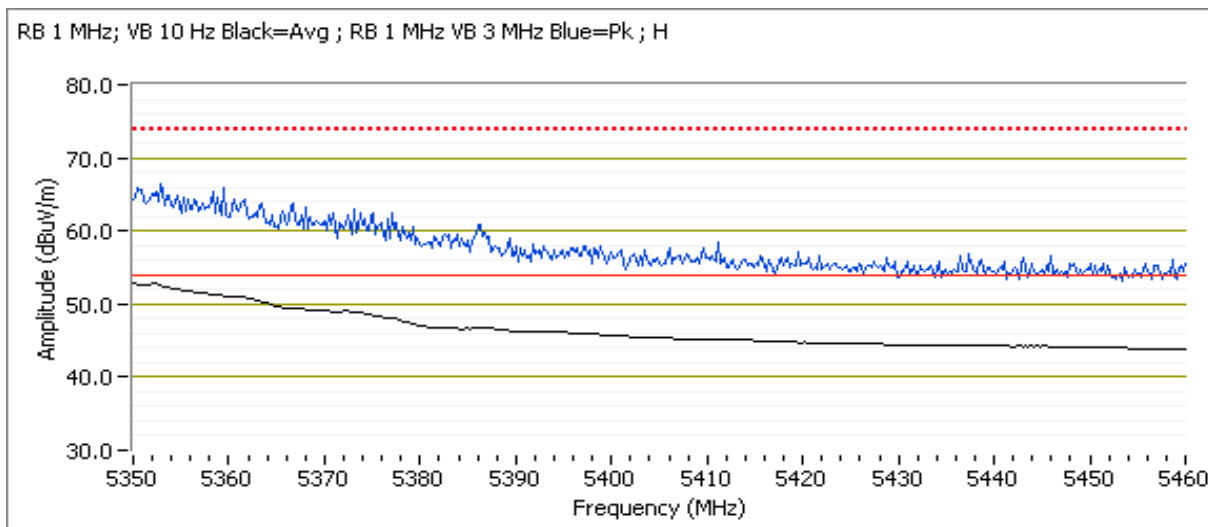



# EMC Test Data

Client: Intel Corporation	Job Number: J94914
Model: 7265D2W	T-Log Number: T95472
Contact: Steve Hackett	Project Manager: Christine Krebill
Standard: FCC Part 15.247, 15.407, RSS-210	Project Coordinator: -
	Class: N/A

## Run #12: Radiated Bandedge Measurements, 5470-5725MHz

Date of Test: 06/10/14  
 Test Location: Chamber #5

Config. Used: 1  
 Test Engineer: R. Varelas

Channel: 106 - 5530MHz  
 Tx Chain: B  
 Mode: ac80  
 Data Rate: 29.3Mbps

Power Settings		
Target (dBm)	Measured (dBm)	Software Setting
13.5	13.6	22.0

### 5460 MHz Band Edge Signal Radiated Field Strength

Frequency MHz	Level dB $\mu$ V/m	Pol v/h	FCC 15.209		Detector Pk/QP/Avg	Azimuth degrees	Height meters	Comments
			Limit	Margin				
5459.920	51.7	H	54.0	-2.3	AVG	95	1.1	Note 3, POS; RB 1MHz; VB: 10Hz
5458.320	65.6	H	74.0	-8.4	PK	95	1.1	POS; RB 1 MHz; VB: 3 MHz
5458.880	48.7	V	54.0	-5.3	AVG	228	1.2	Note 3, POS; RB 1MHz; VB: 10Hz
5458.560	60.7	V	74.0	-13.3	PK	228	1.2	POS; RB 1 MHz; VB: 3 MHz

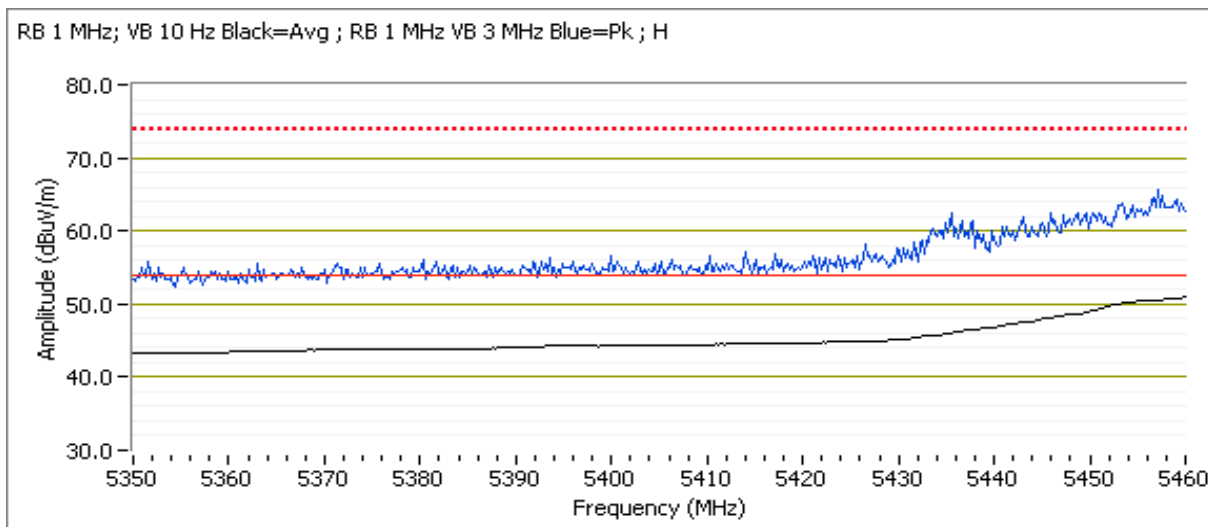



# EMC Test Data

Client: Intel Corporation	Job Number: J94914
Model: 7265D2W	T-Log Number: T95472
Contact: Steve Hackett	Project Manager: Christine Krebill
Standard: FCC Part 15.247, 15.407, RSS-210	Project Coordinator: -
	Class: N/A

## 5470 MHz Band Edge Signal Radiated Field Strength

Frequency MHz	Level dB $\mu$ V/m	Pol v/h	15.E		Detector Pk/QP/Avg	Azimuth degrees	Height meters	Comments
			Limit	Margin				
5463.970	67.2	H	68.3	-1.1	PK	95	1.1	POS; RB 1 MHz; VB: 3 MHz
5466.290	62.5	V	68.3	-5.8	PK	228	1.2	POS; RB 1 MHz; VB: 3 MHz

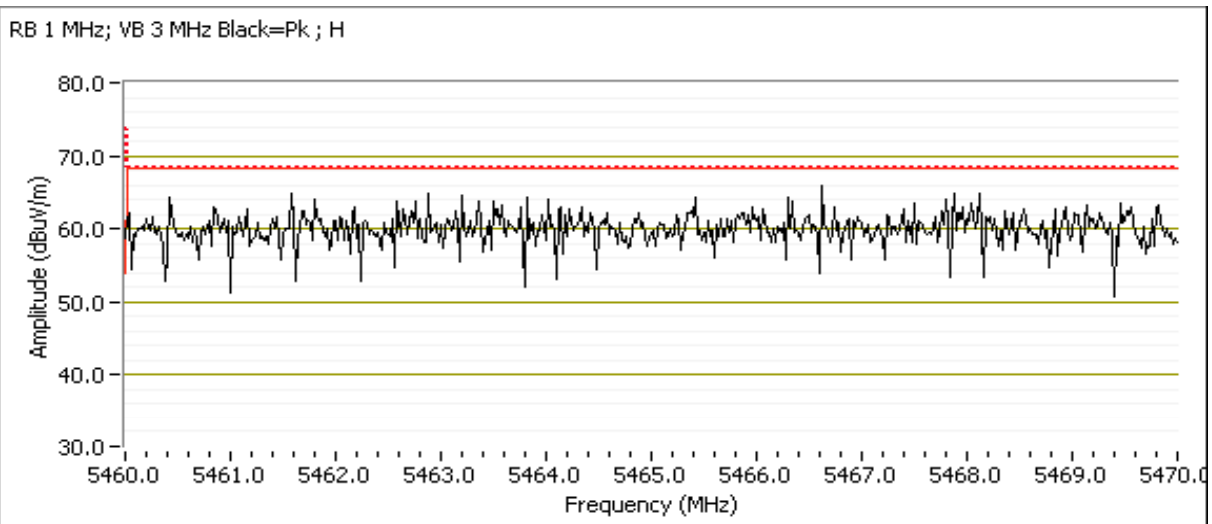



# EMC Test Data

Client:	Intel Corporation	Job Number:	J94914
Model:	7265D2W	T-Log Number:	T95472
Contact:	Steve Hackett	Project Manager:	Christine Krebill
Standard:	FCC Part 15.247, 15.407, RSS-210	Project Coordinator:	-
		Class:	N/A

## RSS 210 and FCC 15.407 (UNII) Radiated Spurious Emissions

### Test Specific Details

Objective: The objective of this test session is to perform final qualification testing of the EUT with respect to the specification listed above.

### General Test Configuration

The EUT and all local support equipment were located on the turntable for radiated spurious emissions testing. For radiated emissions testing the measurement antenna was located 3 meters from the EUT, unless otherwise noted.

### Ambient Conditions:

Temperature: 22.4 °C  
Rel. Humidity: 39 %

### Summary of Results

Run #	Mode	Channel	Power Setting	Measured Power	Test Performed	Limit	Result / Margin
<b>20MHz Bandwith Modes</b>							
1	n20	36 - 5180MHz	21.0, 23.0	11.8, 11.7	Restricted Band Edge at 5150 MHz	15.209	48.8 dBµV/m @ 5150.0 MHz (-5.2 dB)
2	n20	64 - 5320MHz	21.0, 23.0	11.7, 11.7	Restricted Band Edge at 5350 MHz	15.209	45.6 dBµV/m @ 5350.0 MHz (-8.4 dB)
3	n20	100 - 5500MHz	21.5, 22.5	11.8, 11.6	Restricted Band Edge at 5460 MHz	15.209	44.6 dBµV/m @ 5443.7 MHz (-9.4 dB)
	n20	100 - 5500MHz	21.5, 22.5	11.8, 11.6	Band Edge 5460 - 5470 MHz	15E	57.7 dBµV/m @ 5467.6 MHz (-10.6 dB)
	n20	140 - 5700MHz	22.5, 23.5	11.1, 11.2	Band Edge 5725MHz	15E	65.1 dBµV/m @ 5726.5 MHz (-3.2 dB)
<b>40MHz Bandwith Modes</b>							
4	n40	38 - 5190MHz	19.5, 21.5	10.1, 10.2	Restricted Band Edge at 5150 MHz	15.209	48.4 dBµV/m @ 5150.0 MHz (-5.6 dB)
5	n40	62 - 5310MHz	21.0, 23.0	11.7, 11.6	Restricted Band Edge at 5350 MHz	15.209	52.9 dBµV/m @ 5350.0 MHz (-1.1 dB)
6	n40	102 - 5510MHz	21.5, 23.0	11.6, 11.8	Restricted Band Edge at 5460 MHz	15.209	45.7 dBµV/m @ 5458.7 MHz (-8.3 dB)
	n40	102 - 5510MHz	21.5, 23.0	11.6, 11.8	Band Edge 5460 - 5470 MHz	15E	61.6 dBµV/m @ 5468.6 MHz (-6.7 dB)
	n40	134 - 5670MHz	31.5, 33.0	16.5, 16.6	Band Edge 5725MHz	15E	65.3 dBµV/m @ 5726.1 MHz (-3.0 dB)



# EMC Test Data

Client: Intel Corporation	Job Number: J94914
Model: 7265D2W	T-Log Number: T95472
Contact: Steve Hackett	Project Manager: Christine Krebill
Standard: FCC Part 15.247, 15.407, RSS-210	Project Coordinator: -
	Class: N/A

80MHz Bandwith Modes							
7	ac80	42 - 5210MHz	21.5, 22.0	11.6, 11.2	Restricted Band Edge at 5150 MHz	15.209	53.5 dBµV/m @ 5147.7 MHz (-0.5 dB)
8	ac80	58 - 5290MHz	22.0, 22.0	11.2, 9.6	Restricted Band Edge at 5350 MHz	15.209	53.3 dBµV/m @ 5352.3 MHz (-0.7 dB)
9	ac80	106 - 5530MHz	22.5, 22.5	11.2, 10.6	Restricted Band Edge at 5460 MHz	15.209	52.0 dBµV/m @ 5458.8 MHz (-2.0 dB)
	ac80	106 - 5530MHz			Band Edge 5460 - 5470 MHz	15E	53.3 dBµV/m @ 5467.6 MHz (-0.7 dB)

### Modifications Made During Testing

No modifications were made to the EUT during testing

### Deviations From The Standard

No deviations were made from the requirements of the standard.

Note - measured powers are average power measured with a power meter, for reference only.

### Procedure Comments:

Measurements performed in accordance with FCC KDB 789033

Peak measurements performed with: RBW=1MHz, VBW=3MHz, peak detector, max hold, auto sweep time

Unless otherwise stated/noted, emission has duty cycle ≥ 98% and was measured using RBW=1MHz, VBW=10Hz, peak detector, linear average mode, auto sweep time, max hold.

Mode	Data Rate	Duty Cycle (x)	Constant DC?	T (ms)	Pwr Cor Factor*	Lin Volt Cor Factor**	Min VBW for FS (Hz)
n20	6.5Mbps	98%	Constant	1.92	0.0	0.0	521
n40	13.5Mbps	97%	Constant	0.94	0.1	0.3	1064
ac80	29.3Mbps	94%	Constant	0.44	0.3	0.6	2273

### Sample Notes

MAC Address: 001500F15B3A DRTU Tool Version 1.7.3-935 Driver version 17.1.0.11

Antenna: Skycross WiMax/WLAN



# EMC Test Data

Client:	Intel Corporation	Job Number:	J94914
Model:	7265D2W	T-Log Number:	T95472
Contact:	Steve Hackett	Project Manager:	Christine Krebill
Standard:	FCC Part 15.247, 15.407, RSS-210	Project Coordinator:	-
		Class:	N/A

## Measurement Specific Notes:

Note 1:	For emissions outside of the restricted bands the limit is -27dBm/MHz eirp (68.3dBuV/m). The measurement method required is a peak measurement (RB=1MHz, VB≥3MHz, peak detector). Per KDB 789033 2) c) (i), compliance can be demonstrated by meeting the average and peak limits of 15.209, as an alternative.
Note 2:	Emission has duty cycle ≥ 98%, average measurement performed: RBW=1MHz, VBW=3MHz, RMS, Power averaging, auto sweep, trace average 100 traces
Note 3:	Emission has duty cycle < 98%, but constant, average measurement performed: RBW=1MHz, VBW=10Hz, peak detector, linear averaging, auto sweep, trace average 100 * 1/DC traces, measurement corrected by Linear Voltage correction factor
Note 4:	Emission has duty cycle < 98% and is NOT constant, average measurement performed: RBW=1MHz, VBW> 1/T, peak detector, linear average mode, sweep time auto, max hold. Max hold for 50*(1/DC) traces
Note 5:	Emission has duty cycle < 98%, but constant, average measurement performed: RBW=1MHz, VBW=3MHz, RMS, Power averaging, auto sweep, trace average 100 * 1/DC traces, measurement corrected by Pwr correction factor
Note 6:	Plots of the average and peak bandedge do not account for any duty cycle correction. Refer to the tabluar results for final measurements.



# EMC Test Data

Client: Intel Corporation	Job Number: J94914
Model: 7265D2W	T-Log Number: T95472
Contact: Steve Hackett	Project Manager: Christine Krebill
Standard: FCC Part 15.247, 15.407, RSS-210	Project Coordinator: -
	Class: N/A

## Run #1: Radiated Bandedge Measurements, 5150-5250MHz

Date of Test: 06/10/14  
 Test Location: Chamber #5

Config. Used: 1  
 Test Engineer: R. Varelas

Channel: 36 - 5180 MHz  
 Tx Chain: A+B  
 Mode: n20  
 Data Rate: 6.5Mbps

Chain	Target (dBm)				Power Settings Measured (dBm)				Software Setting
	A	B	C	Total	A	B	C	Total	
	11.5	11.5		14.5	11.8	11.7		14.8	21.0, 23.0

### 5150 MHz Band Edge Signal Radiated Field Strength

Frequency MHz	Level dB $\mu$ V/m	Pol v/h	FCC 15.209		Detector Pk/QP/Avg	Azimuth degrees	Height meters	Comments
			Limit	Margin				
5150.000	48.8	H	54.0	-5.2	AVG	111	1.0	POS; RB 1 MHz; VB: 10 Hz
5143.670	61.9	H	74.0	-12.1	PK	111	1.0	POS; RB 1 MHz; VB: 3 MHz
5150.000	45.7	V	54.0	-8.3	AVG	120	1.3	POS; RB 1 MHz; VB: 10 Hz
5143.830	57.4	V	74.0	-16.6	PK	120	1.3	POS; RB 1 MHz; VB: 3 MHz

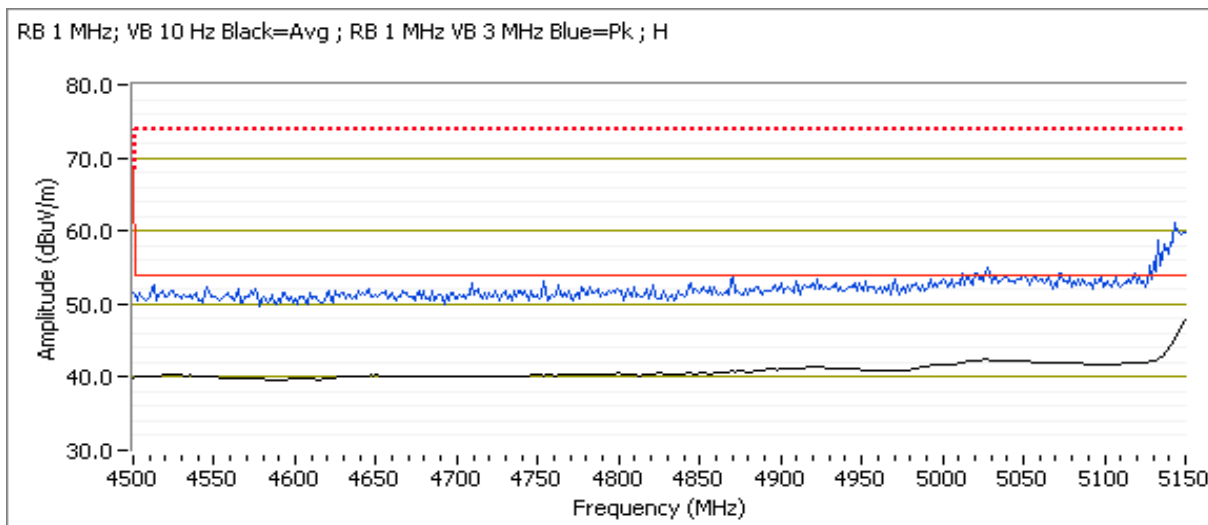





# EMC Test Data

Client: Intel Corporation	Job Number: J94914
Model: 7265D2W	T-Log Number: T95472
Contact: Steve Hackett	Project Manager: Christine Krebill
Standard: FCC Part 15.247, 15.407, RSS-210	Project Coordinator: -
	Class: N/A

## Run #2: Radiated Bandedge Measurements, 5250-5350MHz

Date of Test: 06/10/14  
 Test Engineer: Chamber #5

Config. Used: 1  
 Test Engineer: R. Varelas

Channel: 64 - 5320MHz  
 Tx Chain: A+B  
 Mode: n20  
 Data Rate: 6.5Mbps

Chain	Target (dBm)				Power Settings Measured (dBm)				Software Setting
	A	B	C	Total	A	B	C	Total	
	11.5	11.5		14.5	11.7	11.7		14.7	21.0, 23.0

### 5350 MHz Band Edge Signal Radiated Field Strength

Frequency MHz	Level dB $\mu$ V/m	Pol v/h	FCC 15.209		Detector Pk/QP/Avg	Azimuth degrees	Height meters	Comments
			Limit	Margin				
5350.000	45.6	H	54.0	-8.4	AVG	100	1.0	POS; RB 1 MHz; VB: 10 Hz
5353.610	57.4	H	74.0	-16.6	PK	100	1.0	POS; RB 1 MHz; VB: 3 MHz
5389.840	43.8	V	54.0	-10.2	AVG	311	1.0	POS; RB 1 MHz; VB: 10 Hz
5373.810	56.1	V	74.0	-17.9	PK	311	1.0	POS; RB 1 MHz; VB: 3 MHz

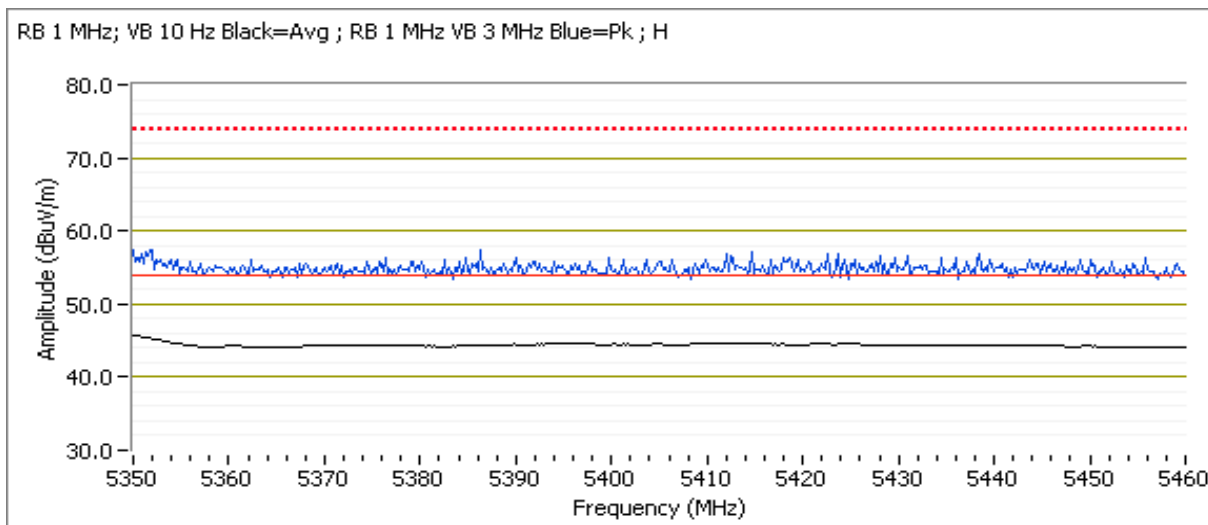



# EMC Test Data

Client: Intel Corporation	Job Number: J94914
Model: 7265D2W	T-Log Number: T95472
Contact: Steve Hackett	Project Manager: Christine Krebill
Standard: FCC Part 15.247, 15.407, RSS-210	Project Coordinator: -
	Class: N/A

## Run #3: Radiated Bandedge Measurements, 5470-5725MHz

Date of Test: 06/10/14  
 Test Engineer: Chamber #5

Config. Used: 1  
 Test Engineer: R. Varelas

Channel: 100 - 5500MHz  
 Tx Chain: A+B  
 Mode: n20  
 Data Rate: 6.5Mbps

Chain	Target (dBm)				Power Settings Measured (dBm)				Software Setting
	A	B	C	Total	A	B	C	Total	
	11.5	11.5		14.5	11.8	11.6		14.7	21.5, 22.5

## 5460 MHz Band Edge Signal Radiated Field Strength

Frequency MHz	Level dB $\mu$ V/m	Pol v/h	FCC 15.209		Detector Pk/QP/Avg	Azimuth degrees	Height meters	Comments
			Limit	Margin				
5443.730	44.6	H	54.0	-9.4	AVG	101	1.0	POS; RB 1 MHz; VB: 10 Hz
5430.340	55.5	H	74.0	-18.5	PK	101	1.0	POS; RB 1 MHz; VB: 3 MHz
5424.810	44.1	V	54.0	-9.9	AVG	267	1.0	POS; RB 1 MHz; VB: 10 Hz
5430.500	57.5	V	74.0	-16.5	PK	267	1.0	POS; RB 1 MHz; VB: 3 MHz

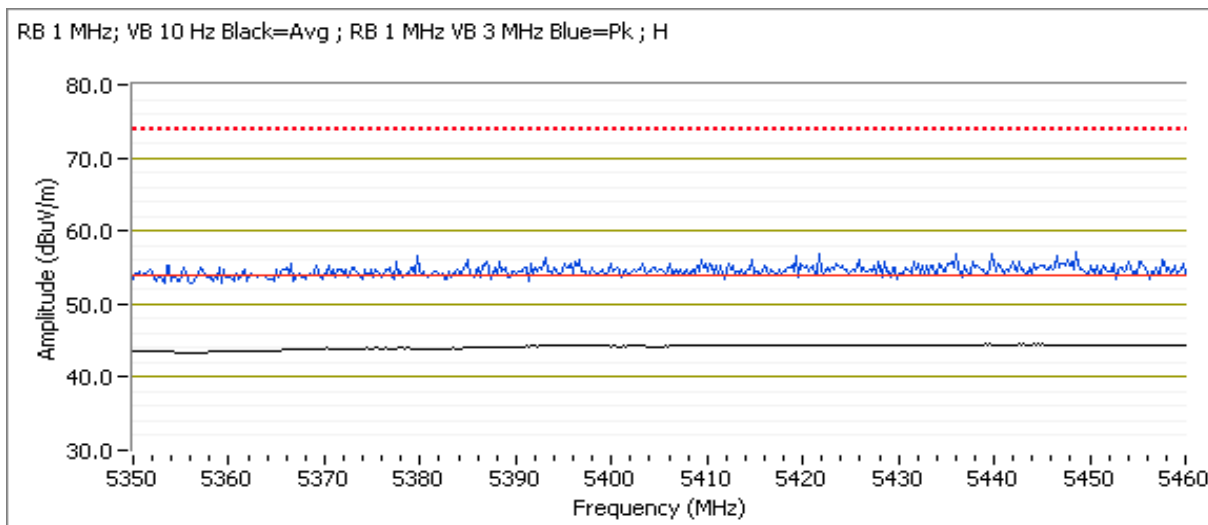



# EMC Test Data

Client: Intel Corporation	Job Number: J94914
Model: 7265D2W	T-Log Number: T95472
Contact: Steve Hackett	Project Manager: Christine Krebill
Standard: FCC Part 15.247, 15.407, RSS-210	Project Coordinator: -
	Class: N/A

### 5470 MHz Band Edge Signal Radiated Field Strength

Frequency MHz	Level dB $\mu$ V/m	Pol v/h	15.E		Detector Pk/QP/Avg	Azimuth degrees	Height meters	Comments
			Limit	Margin				
5467.620	57.7	H	68.3	-10.6	PK	101	1.0	POS; RB 1 MHz; VB: 3 MHz
5460.160	56.5	V	68.3	-11.8	PK	267	1.0	POS; RB 1 MHz; VB: 3 MHz

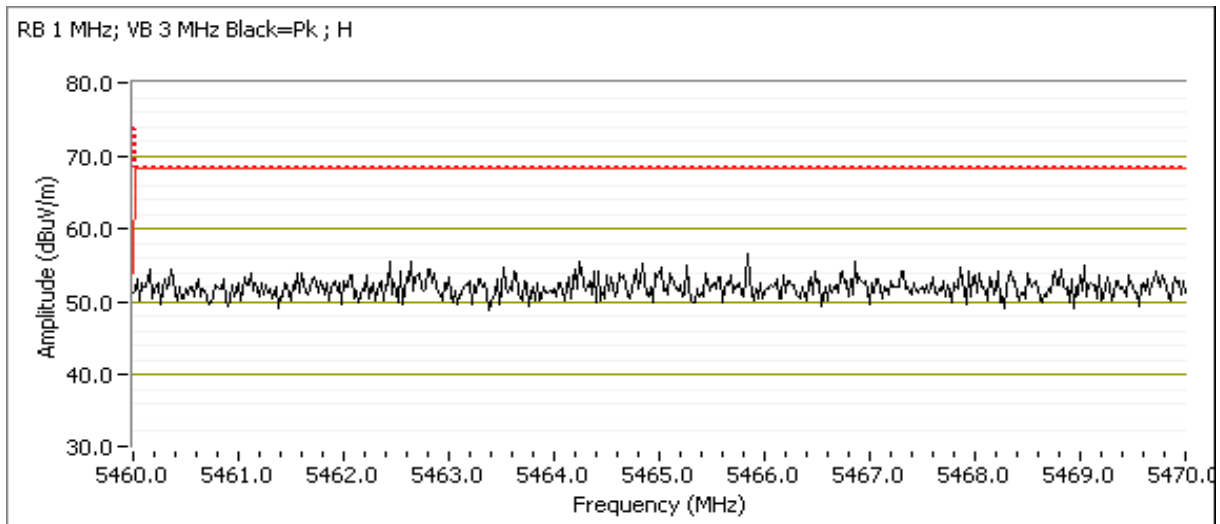



# EMC Test Data

Client: Intel Corporation	Job Number: J94914
Model: 7265D2W	T-Log Number: T95472
Contact: Steve Hackett	Project Manager: Christine Krebill
Standard: FCC Part 15.247, 15.407, RSS-210	Project Coordinator: -
	Class: N/A

Date of Test: 06/11/14  
 Test Location: Chamber #5

Config. Used: 1  
 Test Engineer: J. Liu

Channel: 140 - 5700MHz  
 Tx Chain: A+B  
 Mode: n20  
 Data Rate: 6.5Mbps

Chain	Target (dBm)				Power Settings Measured (dBm)				Software Setting
	A	B	C	Total	A	B	C	Total	
	11.0	11.0		14.0	11.1	11.2		14.2	22.5, 23.5

### 5725 MHz Band Edge Signal Radiated Field Strength

Frequency	Level	Pol	15.E		Detector	Azimuth	Height	Comments
MHz	dB $\mu$ V/m	v/h	Limit	Margin	Pk/QP/Avg	degrees	meters	
5726.520	65.1	H	68.3	-3.2	PK	101	1.2	POS; RB 1 MHz; VB: 3 MHz
5735.900	61.1	V	68.3	-7.2	PK	233	1.1	POS; RB 1 MHz; VB: 3 MHz

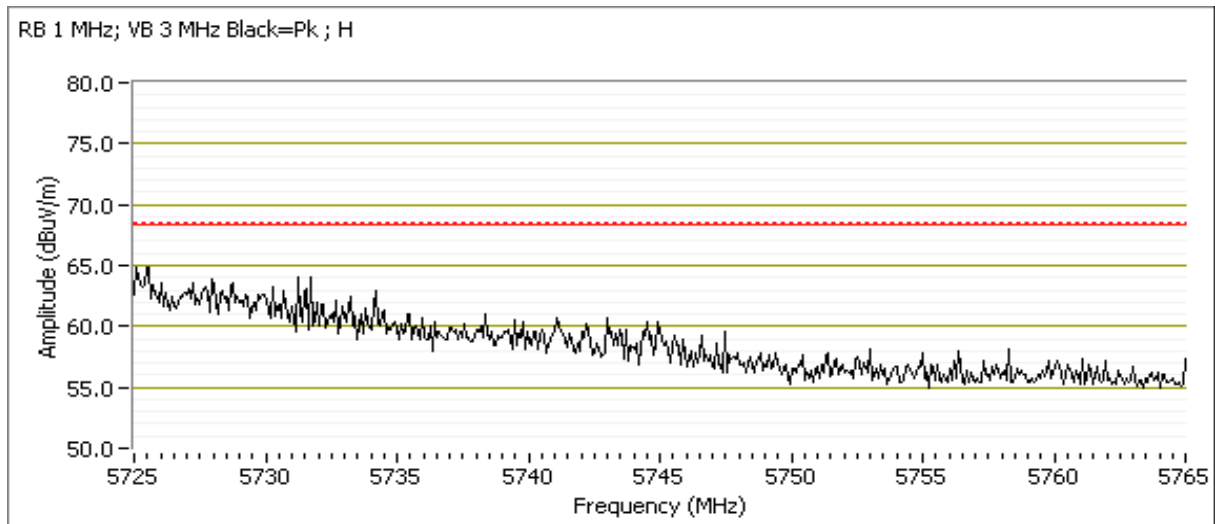



# EMC Test Data

Client: Intel Corporation	Job Number: J94914
Model: 7265D2W	T-Log Number: T95472
Contact: Steve Hackett	Project Manager: Christine Krebill
Standard: FCC Part 15.247, 15.407, RSS-210	Project Coordinator: -
	Class: N/A

## Run #4: Radiated Bandedge Measurements, 5150-5250MHz

Date of Test: 06/11/14  
 Test Location: Chamber #5

Config. Used: 1  
 Test Engineer: J. Liu

Channel: 38 - 5190 MHz  
 Tx Chain: A+B  
 Mode: n40  
 Data Rate: 13.5Mbps

Chain	Target (dBm)				Measured (dBm)				Software Setting
	A	B	C	Total	A	B	C	Total	
	10.0	10.0		13.0	10.1	10.2		13.2	19.5, 21.5

### 5150 MHz Band Edge Signal Radiated Field Strength

Frequency MHz	Level dB $\mu$ V/m	Pol v/h	FCC 15.209		Detector Pk/QP/Avg	Azimuth degrees	Height meters	Comments
			Limit	Margin				
5150.000	48.4	H	54.0	-5.6	AVG	104	1.0	Note 3, POS; RB 1MHz; VB: 10Hz
5146.470	61.2	H	74.0	-12.8	PK	104	1.0	POS; RB 1 MHz; VB: 3 MHz
5150.000	47.5	V	54.0	-6.5	AVG	133	1.6	Note 3, POS; RB 1MHz; VB: 10Hz
5148.640	60.0	V	74.0	-14.0	PK	133	1.6	POS; RB 1 MHz; VB: 3 MHz

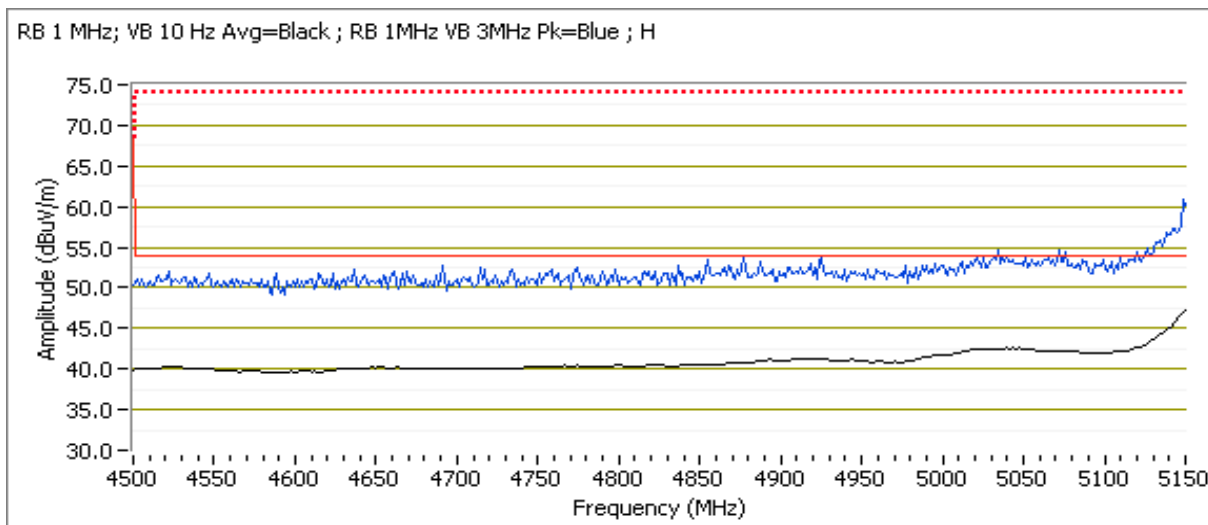



# EMC Test Data

Client: Intel Corporation	Job Number: J94914
Model: 7265D2W	T-Log Number: T95472
Contact: Steve Hackett	Project Manager: Christine Krebill
Standard: FCC Part 15.247, 15.407, RSS-210	Project Coordinator: -
	Class: N/A

## Run #5: Radiated Bandedge Measurements, 5250-5350MHz

Date of Test: 06/11/14  
 Test Location: Chamber #5

Config. Used: 1  
 Test Engineer: J. Liu

Channel: 62 - 5310MHz  
 Tx Chain: A+B  
 Mode: n40  
 Data Rate: 13.5Mbps

Chain	Target (dBm)				Measured (dBm)				Software Setting
	A	B	C	Total	A	B	C	Total	
	11.5	11.5		14.5	11.7	11.6		14.7	21.0, 23.0

## 5350 MHz Band Edge Signal Radiated Field Strength

Frequency MHz	Level dB $\mu$ V/m	Pol v/h	FCC 15.209		Detector Pk/QP/Avg	Azimuth degrees	Height meters	Comments
			Limit	Margin				
5350.000	52.9	H	54.0	-1.1	AVG	103	1.0	Note 3, POS; RB 1MHz; VB: 10Hz
5351.360	66.4	H	74.0	-7.6	PK	103	1.0	POS; RB 1 MHz; VB: 3 MHz
5350.000	48.6	V	54.0	-5.4	AVG	30	1.0	Note 3, POS; RB 1MHz; VB: 10Hz
5353.130	59.4	V	74.0	-14.6	PK	30	1.0	POS; RB 1 MHz; VB: 3 MHz

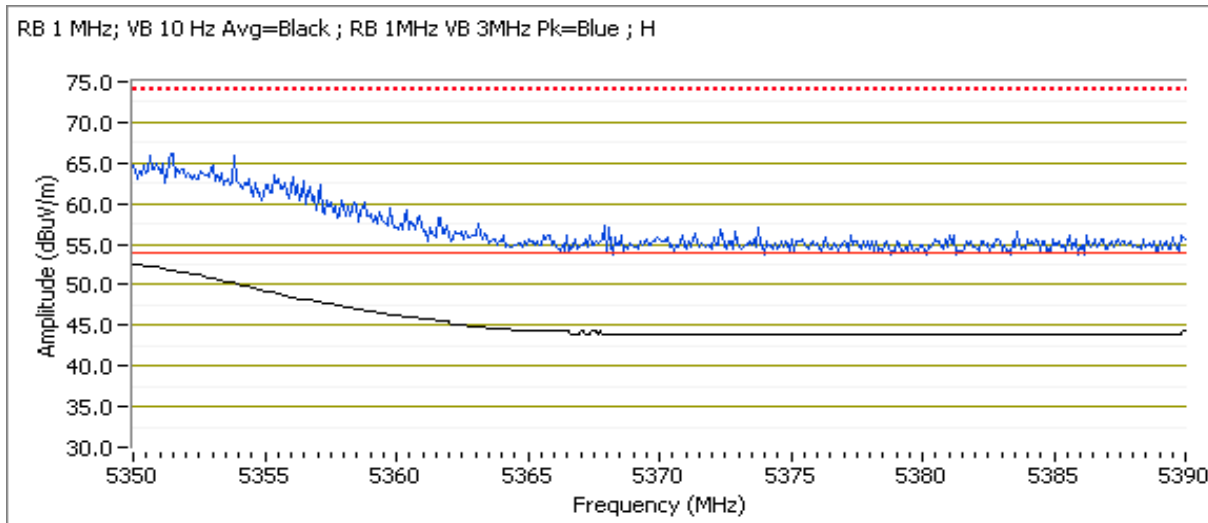



# EMC Test Data

Client: Intel Corporation	Job Number: J94914
Model: 7265D2W	T-Log Number: T95472
Contact: Steve Hackett	Project Manager: Christine Krebill
Standard: FCC Part 15.247, 15.407, RSS-210	Project Coordinator: -
	Class: N/A

## Run #6: Radiated Bandedge Measurements, 5470-5725MHz

Date of Test: 06/11/14  
 Test Location: Chamber #5

Config. Used: 1  
 Test Engineer: J. Liu

Channel: 102 - 5510MHz  
 Tx Chain: A+B  
 Mode: n40  
 Data Rate: 13.5Mbps

Chain	Power Settings								Software Setting
	Target (dBm)				Measured (dBm)				
	A	B	C	Total	A	B	C	Total	
	11.5	11.5		14.5	11.6	11.8		14.7	21.5, 23.0

## 5460 MHz Band Edge Signal Radiated Field Strength

Frequency MHz	Level dB $\mu$ V/m	Pol v/h	FCC 15.209		Detector Pk/QP/Avg	Azimuth degrees	Height meters	Comments
			Limit	Margin				
5458.720	45.7	H	54.0	-8.3	AVG	103	1.0	Note 3, POS; RB 1MHz; VB: 10Hz
5452.950	58.2	H	74.0	-15.8	PK	103	1.0	POS; RB 1 MHz; VB: 3 MHz
5425.450	44.4	V	54.0	-9.6	AVG	195	1.0	Note 3, POS; RB 1MHz; VB: 10Hz
5440.280	56.5	V	74.0	-17.5	PK	195	1.0	POS; RB 1 MHz; VB: 3 MHz

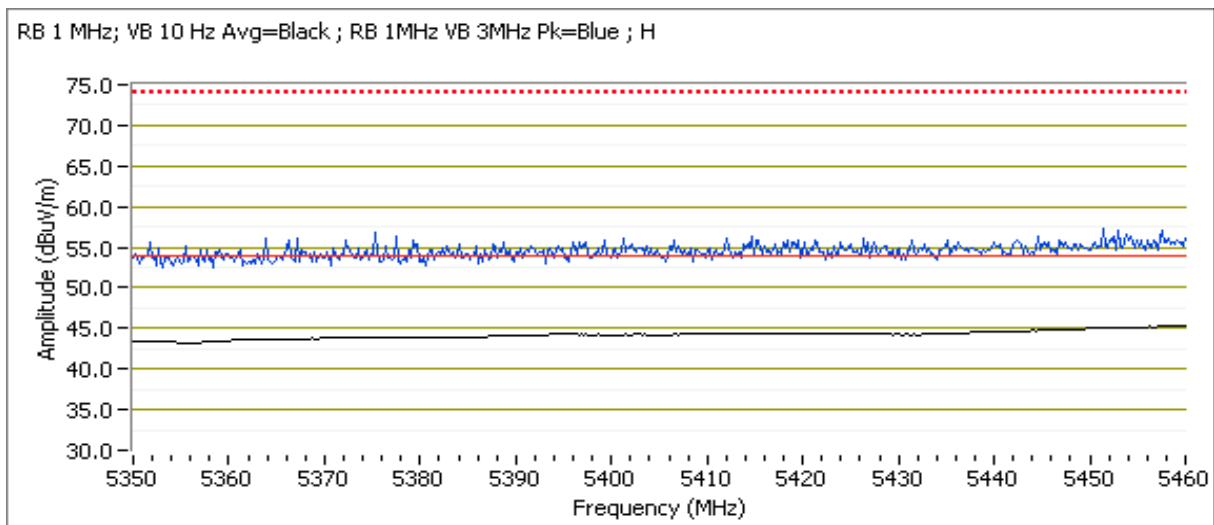



# EMC Test Data

Client:	Intel Corporation	Job Number:	J94914
Model:	7265D2W	T-Log Number:	T95472
Contact:	Steve Hackett	Project Manager:	Christine Krebill
Standard:	FCC Part 15.247, 15.407, RSS-210	Project Coordinator:	-
		Class:	N/A

## 5470 MHz Band Edge Signal Radiated Field Strength

Frequency MHz	Level dB $\mu$ V/m	Pol v/h	15.E		Detector Pk/QP/Avg	Azimuth degrees	Height meters	Comments
			Limit	Margin				
5468.560	61.6	H	68.3	-6.7	PK	96	1.3	POS; RB 1 MHz; VB: 3 MHz
5466.870	58.8	V	68.3	-9.5	PK	256	1.0	POS; RB 1 MHz; VB: 3 MHz

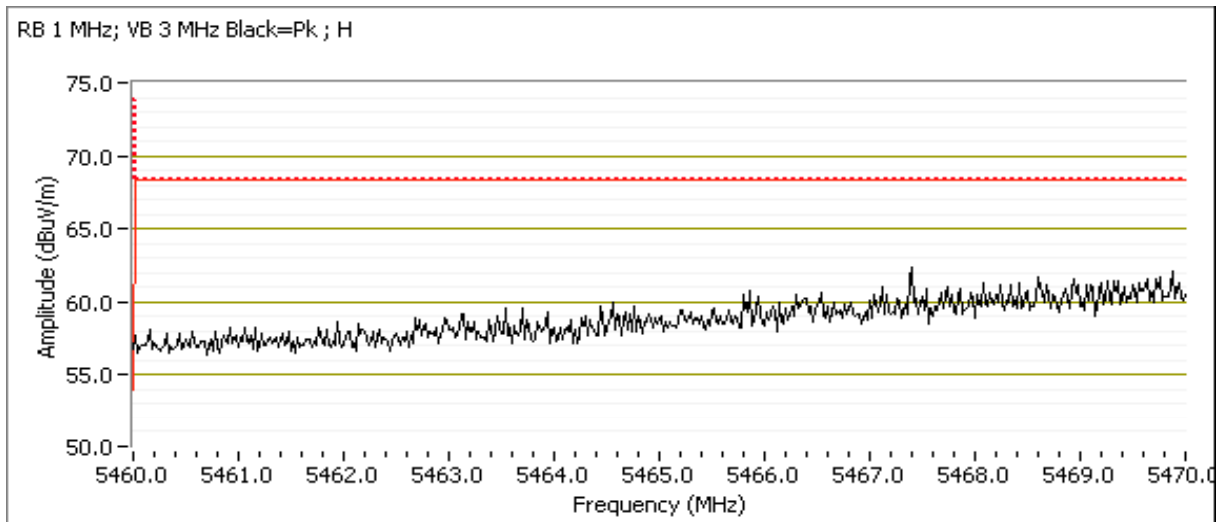





# EMC Test Data

Client: Intel Corporation	Job Number: J94914
Model: 7265D2W	T-Log Number: T95472
Contact: Steve Hackett	Project Manager: Christine Krebill
Standard: FCC Part 15.247, 15.407, RSS-210	Project Coordinator: -
	Class: N/A

Channel: 134 - 5670MHz  
 Tx Chain: A+B  
 Mode: n40  
 Data Rate: 13.5Mbps

Chain	Power Settings								Software Setting
	Target (dBm)				Measured (dBm)				
	A	B	C	Total	A	B	C	Total	
	16.5	16.5		19.5	16.5	16.6		19.6	31.5, 33.0

### 5725 MHz Band Edge Signal Radiated Field Strength

Frequency	Level	Pol	15.E		Detector	Azimuth	Height	Comments
MHz	dB $\mu$ V/m	v/h	Limit	Margin	PK/QP/Avg	degrees	meters	
5726.120	65.3	H	68.3	-3.0	PK	94	1.2	POS; RB 1 MHz; VB: 3 MHz
5728.450	64.7	V	68.3	-3.6	PK	190	1.0	POS; RB 1 MHz; VB: 3 MHz

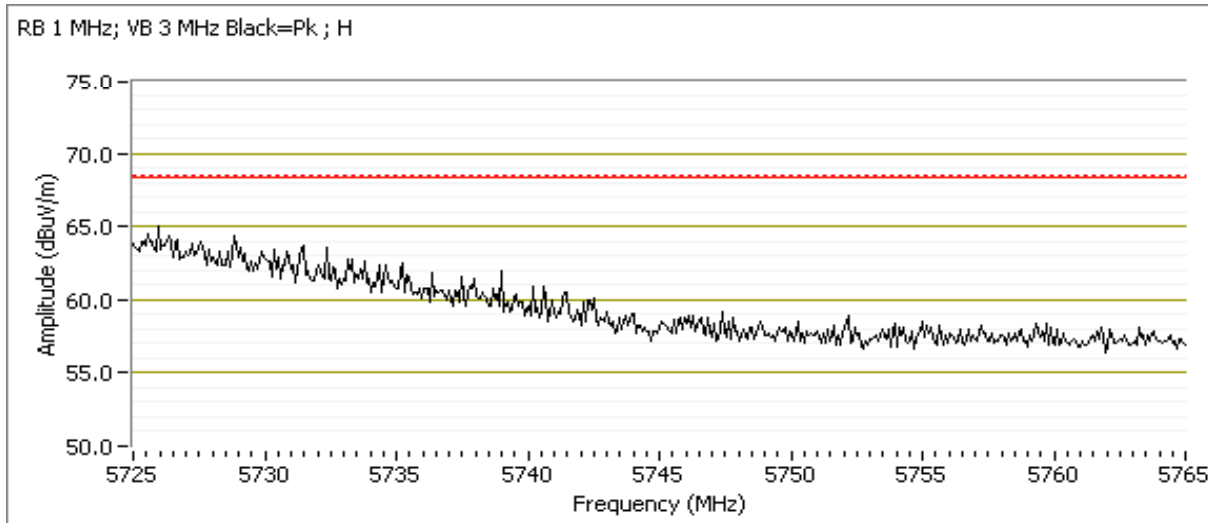



# EMC Test Data

Client: Intel Corporation	Job Number: J94914
Model: 7265D2W	T-Log Number: T95472
	Project Manager: Christine Krebill
Contact: Steve Hackett	Project Coordinator: -
Standard: FCC Part 15.247, 15.407, RSS-210	Class: N/A

## Run #7: Radiated Bandedge Measurements, 5150-5250MHz

Date of Test: 06/11/14  
 Test Location: Chamber #5

Config. Used: 1  
 Test Engineer: J. Liu

Channel: 42 - 5210MHz  
 Tx Chain: A+B  
 Mode: ac80  
 Data Rate: 29.3Mbps

Chain	Power Settings								Software Setting
	Target (dBm)				Measured (dBm)				
	A	B	C	Total	A	B	C	Total	
	11.5	11.5		14.5	11.6	11.2		14.4	21.5, 22.0

### 5150 MHz Band Edge Signal Radiated Field Strength

Frequency MHz	Level dB $\mu$ V/m	Pol v/h	FCC 15.209		Detector Pk/QP/Avg	Azimuth degrees	Height meters	Comments
			Limit	Margin				
5147.680	53.5	H	54.0	-0.5	AVG	102	1.0	Note 3, POS; RB 1MHz; VB: 10Hz
5145.390	68.9	H	74.0	-5.1	PK	102	1.0	POS; RB 1 MHz; VB: 3 MHz
5147.600	52.0	V	54.0	-2.0	AVG	126	1.7	Note 3, POS; RB 1MHz; VB: 10Hz
5144.310	66.1	V	74.0	-7.9	PK	126	1.7	POS; RB 1 MHz; VB: 3 MHz



# EMC Test Data

Client: Intel Corporation	Job Number: J94914
Model: 7265D2W	T-Log Number: T95472
Contact: Steve Hackett	Project Manager: Christine Krebill
Standard: FCC Part 15.247, 15.407, RSS-210	Project Coordinator: -
	Class: N/A

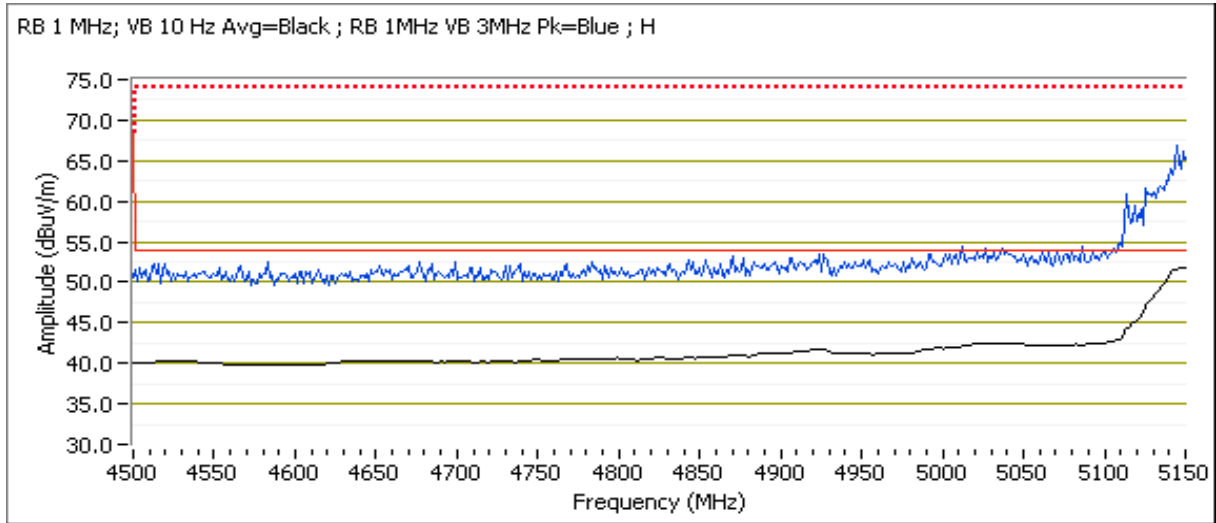



# EMC Test Data

Client: Intel Corporation	Job Number: J94914
Model: 7265D2W	T-Log Number: T95472
	Project Manager: Christine Krebill
Contact: Steve Hackett	Project Coordinator: -
Standard: FCC Part 15.247, 15.407, RSS-210	Class: N/A

## Run #8: Radiated Bandedge Measurements, 5250-5350MHz

Date of Test: 06/11/14  
 Test Location: Chamber #5

Config. Used: 1  
 Test Engineer: J. Liu

Channel: 58 - 5290MHz  
 Tx Chain: A+B  
 Mode: ac80  
 Data Rate: 29.3Mbps

Chain	Power Settings								Software Setting
	Target (dBm)				Measured (dBm)				
	A	B	C	Total	A	B	C	Total	
	11.5	11.5		14.5	11.2	9.6		13.5	22.0, 22.0

## 5350 MHz Band Edge Signal Radiated Field Strength

Frequency MHz	Level dB $\mu$ V/m	Pol v/h	FCC 15.209		Detector Pk/QP/Avg	Azimuth degrees	Height meters	Comments
			Limit	Margin				
5352.250	53.3	H	54.0	-0.7	AVG	102	1.0	Note 3, POS; RB 1MHz; VB: 10Hz
5350.500	67.5	H	74.0	-6.5	PK	102	1.0	POS; RB 1 MHz; VB: 3 MHz
5352.480	51.1	V	54.0	-2.9	AVG	119	1.4	Note 3, POS; RB 1MHz; VB: 10Hz
5352.480	64.6	V	74.0	-9.4	PK	119	1.4	POS; RB 1 MHz; VB: 3 MHz

Client: Intel Corporation	Job Number: J94914
Model: 7265D2W	T-Log Number: T95472
	Project Manager: Christine Krebill
Contact: Steve Hackett	Project Coordinator: -
Standard: FCC Part 15.247, 15.407, RSS-210	Class: N/A

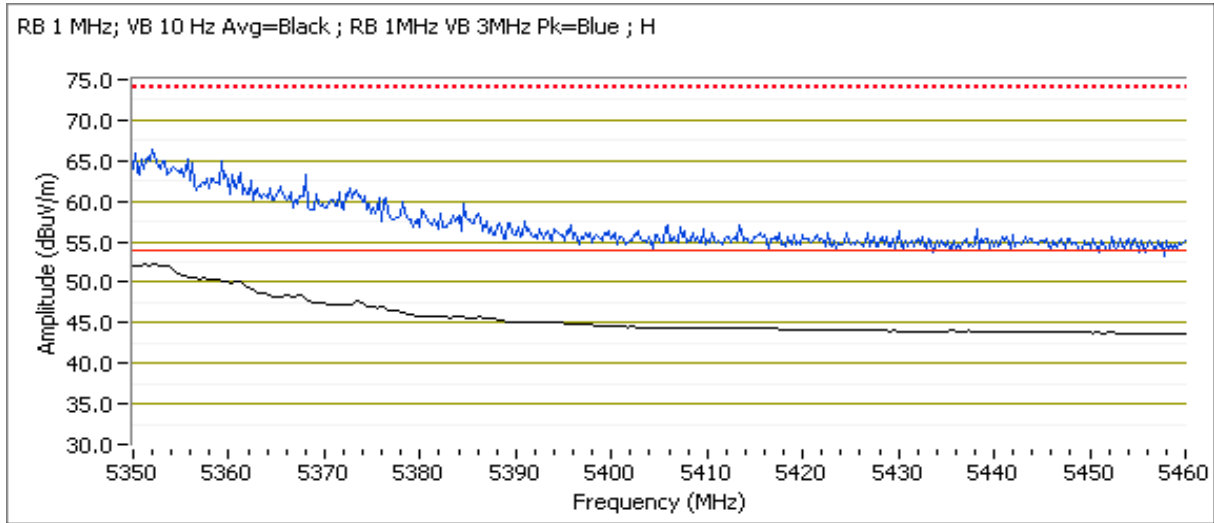



# EMC Test Data

Client: Intel Corporation	Job Number: J94914
Model: 7265D2W	T-Log Number: T95472
Contact: Steve Hackett	Project Manager: Christine Krebill
Standard: FCC Part 15.247, 15.407, RSS-210	Project Coordinator: -
	Class: N/A

## Run #9: Radiated Bandedge Measurements, 5470-5725MHz

Date of Test: 06/11/14  
 Test Location: Chamber #5

Config. Used: 1  
 Test Engineer: J. Liu

Channel: 106 - 5530MHz  
 Tx Chain: A+B  
 Mode: ac80  
 Data Rate: 29.3Mbps

Chain	Power Settings								
	Target (dBm)				Measured (dBm)				Software Setting
	A	B	C	Total	A	B	C	Total	
	11.5	11.5		14.5	11.2	10.6		13.9	22.5, 22.5

## 5460 MHz Band Edge Signal Radiated Field Strength

Frequency MHz	Level dB $\mu$ V/m	Pol v/h	FCC 15.209		Detector Pk/QP/Avg	Azimuth degrees	Height meters	Comments
			Limit	Margin				
5458.840	52.0	H	54.0	-2.0	AVG	101	1.1	Note 3, POS; RB 1MHz; VB: 10Hz
5456.670	67.6	H	74.0	-6.4	PK	101	1.1	POS; RB 1 MHz; VB: 3 MHz
5458.800	48.4	V	54.0	-5.6	AVG	232	1.0	Note 3, POS; RB 1MHz; VB: 10Hz
5453.830	62.5	V	74.0	-11.5	PK	232	1.0	POS; RB 1 MHz; VB: 3 MHz

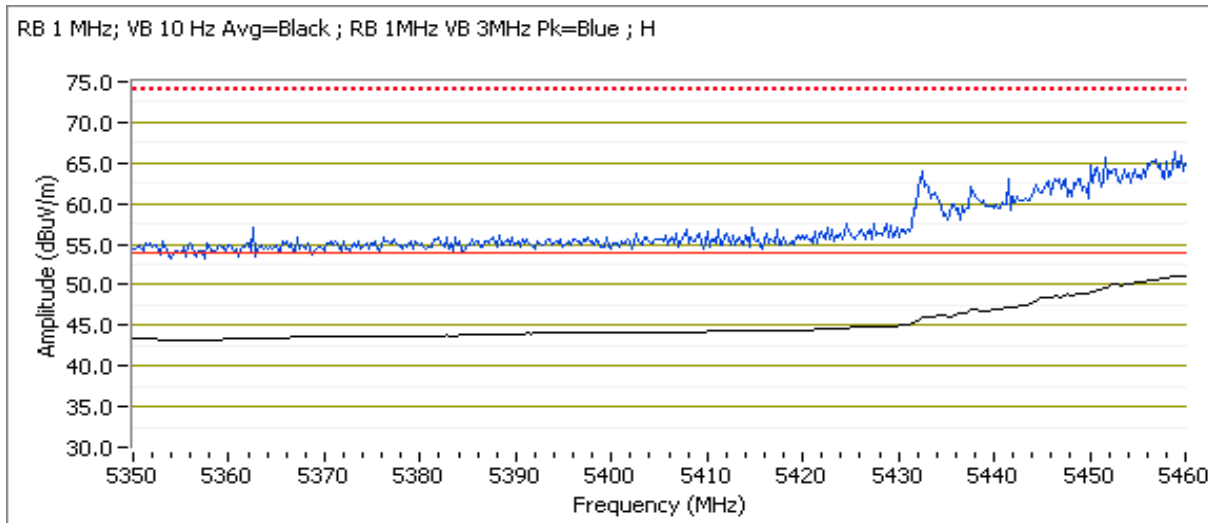



# EMC Test Data

Client:	Intel Corporation	Job Number:	J94914
Model:	7265D2W	T-Log Number:	T95472
Contact:	Steve Hackett	Project Manager:	Christine Krebill
Standard:	FCC Part 15.247, 15.407, RSS-210	Project Coordinator:	-
		Class:	N/A

## 5470 MHz Band Edge Signal Radiated Field Strength

Frequency MHz	Level dB $\mu$ V/m	Pol v/h	15.E		Detector Pk/QP/Avg	Azimuth degrees	Height meters	Comments
			Limit	Margin				
5467.600	53.3	H	54.0	-0.7	AVG	99	1.1	Notes 1&3, POS; RB 1MHz; VB: 10Hz
5468.440	68.9	H	74.0	-5.1	PK	99	1.1	Note 1, POS; RB 1 MHz; VB: 3 MHz
5467.760	49.5	V	54.0	-4.5	AVG	265	1.0	Notes 1&3, POS; RB 1MHz; VB: 10Hz
5466.630	65.0	V	74.0	-9.0	PK	265	1.0	Note 1, POS; RB 1 MHz; VB: 3 MHz

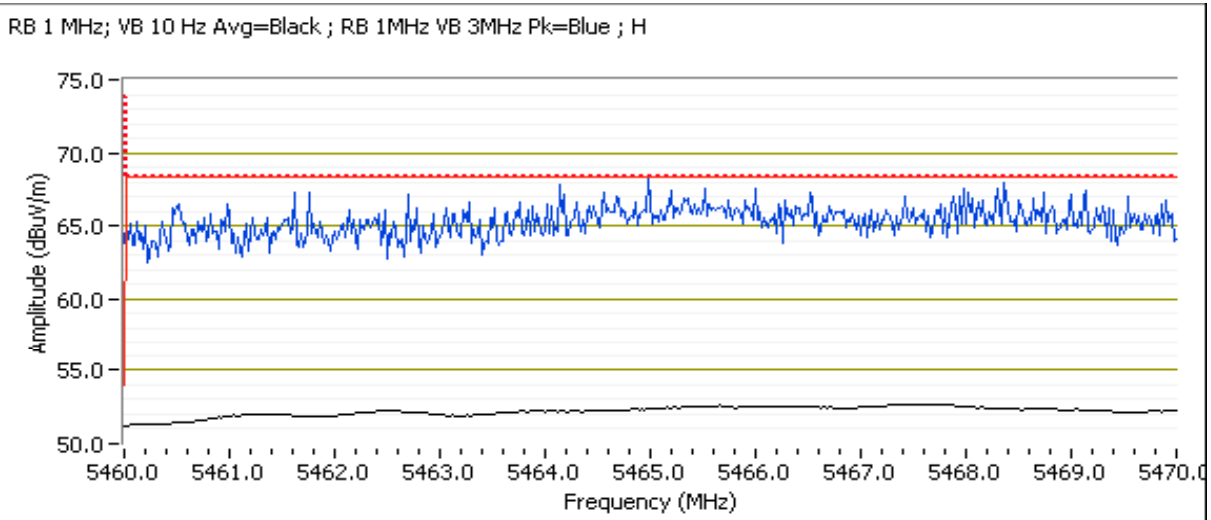



# EMC Test Data

Client:	Intel Corporation	Job Number:	J94914
Model:	7265D2W	T-Log Number:	T95472
Contact:	Steve Hackett	Project Manager:	Christine Krebill
Standard:	FCC Part 15.247, 15.407, RSS-210	Project Coordinator:	-
		Class:	N/A

## RSS 210 and FCC 15.407 (UNII) Radiated Spurious Emissions

### Test Specific Details

Objective: The objective of this test session is to perform final qualification testing of the EUT with respect to the specification listed above.

### General Test Configuration

The EUT and all local support equipment were located on the turntable for radiated spurious emissions testing. For radiated emissions testing the measurement antenna was located 3 meters from the EUT, unless otherwise noted.

### Ambient Conditions:

Temperature: 22.4 °C  
Rel. Humidity: 35 %

### Summary of Results

Run #	Mode	Channel	Power Setting	Measured Power	Test Performed	Limit	Result / Margin
Scans on "center" channel in all four OFDM modes to determine the worst case mode.							
1	a - Chain A	40 - 5200MHz	26.0	16.2	Radiated Emissions, 1 - 40 GHz	FCC 15.209 / 15 E	48.8 dBµV/m @ 20799.9 MHz (-5.2 dB)
	a - Chain B	40 - 5200MHz	28.5	16.2	Radiated Emissions, 1 - 40 GHz	FCC 15.209 / 15 E	48.2 dBµV/m @ 20799.9 MHz (-5.8 dB)
	n20 - Chain A+B	40 - 5200MHz	30.5 / 31.5	16.1 / 16.1	Radiated Emissions, 1 - 40 GHz	FCC 15.209 / 15 E	48.0 dBµV/m @ 15599.8 MHz (-6.0 dB)
	n40 - Chain A+B	38 - 5190MHz	31.5 / 32.5	16.6 / 16.5	Radiated Emissions, 1 - 40 GHz	FCC 15.209 / 15 E	47.4 dBµV/m @ 20759.9 MHz (-6.6 dB)
	ac80 - Chain A+B	42 - 5210MHz	21.0 / 22.0	13.5 / 13.5	Radiated Emissions, 1 - 40 GHz	FCC 15.209 / 15 E	47.1 dBµV/m @ 20839.9 MHz (-6.9 dB)
Measurements on low and high channels in worst-case OFDM mode.							
2	n20 - Chain A+B	36 - 5180MHz	22.0 / 23.5	11.6 / 11.5	Radiated Emissions, 1 - 40 GHz	FCC 15.209 / 15 E	47.8 dBµV/m @ 20719.9 MHz (-6.2 dB)
	n20 - Chain A+B	48 - 5240MHz	29.0 / 30.0	16.1 / 16.2	Radiated Emissions, 1 - 40 GHz	FCC 15.209 / 15 E	45.9 dBµV/m @ 20959.9 MHz (-8.1 dB)





# EMC Test Data

Client:	Intel Corporation	Job Number:	J94914
Model:	7265D2W	T-Log Number:	T95472
Contact:	Steve Hackett	Project Manager:	Christine Krebill
Standard:	FCC Part 15.247, 15.407, RSS-210	Project Coordinator:	-
		Class:	N/A

Run #	Mode	Channel	Power Setting	Measured Power	Test Performed	Limit	Result / Margin
Scans on "center" channel in all four OFDM modes to determine the worst case mode.							
3	a - Chain A	60 - 5300MHz	27.0	16.2	Radiated Emissions, 1 - 40 GHz	FCC 15.209 / 15 E	44.8 dBµV/m @ 15899.1 MHz (-9.2 dB)
	a - Chain B	60 - 5300MHz	29.0	16.2	Radiated Emissions, 1 - 40 GHz	FCC 15.209 / 15 E	47.4 dBµV/m @ 15902.2 MHz (-6.6 dB)
	n20 - Chain A+B	60 - 5300MHz	31.5 / 32.5	16.0 / 16.0	Radiated Emissions, 1 - 40 GHz	FCC 15.209 / 15 E	51.6 dBµV/m @ 15903.0 MHz (-2.4 dB)
	n40 - Chain A+B	54 - 5270MHz	30.5 / 32.0	16.6 / 16.5	Radiated Emissions, 1 - 40 GHz	FCC 15.209 / 15 E	45.0 dBµV/m @ 21080.0 MHz (-9.0 dB)
	ac80 - Chain A+B	58 - 5290MHz	21.5 / 23.5	13.6 / 13.6	Radiated Emissions, 1 - 40 GHz	FCC 15.209 / 15 E	45.9 dBµV/m @ 21159.9 MHz (-8.1 dB)
Measurements on low and high channels in worst-case OFDM mode.							
4	n20 - Chain A+B	52 - 5260MHz	29.0 / 30.0	16.0 / 16.1	Radiated Emissions, 1 - 40 GHz	FCC 15.209 / 15 E	45.8 dBµV/m @ 21039.8 MHz (-8.2 dB)
	n20 - Chain A+B	64 - 5320MHz	22.5 / 24.0	11.7 / 11.6	Radiated Emissions, 1 - 40 GHz	FCC 15.209 / 15 E	45.9 dBµV/m @ 21279.9 MHz (-8.1 dB)
Scans on "center" channel in all four OFDM modes to determine the worst case mode.							
5	a - Chain A	116 - 5580MHz	25.5	16.6	Radiated Emissions, 1 - 40 GHz	FCC 15.209 / 15 E	47.4 dBµV/m @ 22319.8 MHz (-6.6 dB)
	a - Chain B	116 - 5580MHz	26.0	16.6	Radiated Emissions, 1 - 40 GHz	FCC 15.209 / 15 E	47.0 dBµV/m @ 22319.9 MHz (-7.0 dB)
	n20 - Chain A+B	116 - 5580MHz	28.5 / 29.5	16.5 / 16.6	Radiated Emissions, 1 - 40 GHz	FCC 15.209 / 15 E	46.2 dBµV/m @ 22319.9 MHz (-7.8 dB)
	n40 - Chain A+B	110 - 5550MHz	28.0 / 29.0	16.6 / 16.6	Radiated Emissions, 1 - 40 GHz	FCC 15.209 / 15 E	45.7 dBµV/m @ 22199.9 MHz (-8.3 dB)
	ac80 - Chain A+B	122 - 5610MHz	28.0 / 28.5	16.6 / 16.5	Radiated Emissions, 1 - 40 GHz	FCC 15.209 / 15 E	46.8 dBµV/m @ 22440.0 MHz (-7.2 dB)
Measurements on low and high channels in worst-case OFDM mode plus highest ac mode channel.							
6	a - Chain B	100 - 5500MHz	23.5	13.7	Radiated Emissions, 1 - 40 GHz	FCC 15.209 / 15 E	44.5 dBµV/m @ 22799.5 MHz (-9.5 dB)
	a - Chain B	140 - 5700MHz	24.0	13.2	Radiated Emissions, 1 - 40 GHz	FCC 15.209 / 15 E	45.8 dBµV/m @ 22799.8 MHz (-8.2 dB)
	ac20	144 - 5720MHz	33.0 / 34.0	16.5 / 16.6	Radiated Emissions, 1 - 40 GHz	FCC 15.209 / 15 E	49.7 dBµV/m @ 22879.9 MHz (-4.3 dB)



# EMC Test Data

Client:	Intel Corporation	Job Number:	J94914
Model:	7265D2W	T-Log Number:	T95472
		Project Manager:	Christine Krebill
Contact:	Steve Hackett	Project Coordinator:	-
Standard:	FCC Part 15.247, 15.407, RSS-210	Class:	N/A

### Modifications Made During Testing

No modifications were made to the EUT during testing

### Deviations From The Standard

No deviations were made from the requirements of the standard.

Note - measured powers are average power measured with a power meter, for reference only.

### Procedure Comments:

Measurements performed in accordance with FCC KDB 789033

Peak measurements performed with: RBW=1MHz, VBW=3MHz, peak detector, max hold, auto sweep time

Unless otherwise stated/noted, emission has duty cycle  $\geq 98\%$  and was measured using RBW=1MHz, VBW=10Hz, peak detector, linear average mode, auto sweep time, max hold.

Mode	Data Rate	Duty Cycle (x)	Constant DC?	T (ms)	Pwr Cor Factor*	Lin Volt Cor Factor**	Min VBW for FS (Hz)
11a	6.0Mbps	99%	Constant	2.06	0.0	0.0	485
n20	6.5Mbps	98%	Constant	1.92	0.0	0.0	521
n40	13.5Mbps	97%	Constant	0.94	0.1	0.3	1064
ac80	29.3Mbps	94%	Constant	0.44	0.3	0.6	2273



## EMC Test Data

Client:	Intel Corporation	Job Number:	J94914
Model:	7265D2W	T-Log Number:	T95472
		Project Manager:	Christine Krebill
Contact:	Steve Hackett	Project Coordinator:	-
Standard:	FCC Part 15.247, 15.407, RSS-210	Class:	N/A

### Sample Notes

MAC Address: 001500F15B3A DRTU Tool Version 1.7.3-935 Driver version 17.1.0.11

Antenna: Skycross WiMax/WLAN

### Measurement Specific Notes:

Note 1:	For emissions outside of the restricted bands the limit is -27dBm/MHz eirp (68.3dBuV/m). The measurement method required is a peak measurement (RB=1MHz, VB≥3MHz, peak detector). Per KDB 789033 2) c) (i), compliance can be demonstrated by meeting the average and peak limits of 15.209, as an alternative.
Note 2:	Emission has duty cycle ≥ 98%, average measurement performed: RBW=1MHz, VBW=3MHz, RMS, Power averaging, auto sweep, trace average 100 traces
Note 3:	Emission has duty cycle < 98%, but constant, average measurement performed: RBW=1MHz, VBW=10Hz, peak detector, linear averaging, auto sweep, trace average 100 * 1/DC traces, measurement corrected by Linear Voltage correction factor
Note 4:	Emission has duty cycle ≥ 98%, average measurement performed: RBW=1MHz, VBW=10Hz, Peak detector, linear averaging, auto sweep, trace average 100 traces
Note 5:	Emission has duty cycle < 98% and is NOT constant, average measurement performed: RBW=1MHz, VBW> 1/T, peak detector, linear average mode, sweep time auto, max hold. Max hold for 50*(1/DC) traces
Note 6:	Emission has duty cycle < 98%, but constant, average measurement performed: RBW=1MHz, VBW=3MHz, RMS, Power averaging, auto sweep, trace average 100 * 1/DC traces, measurement corrected by Pwr correction factor
Note 7:	Plots of the average and peak bandedge do not account for any duty cycle correction. Refer to the tabular results for final measurements.



Client: Intel Corporation	Job Number: J94914
Model: 7265D2W	T-Log Number: T95472
	Project Manager: Christine Krebill
Contact: Steve Hackett	Project Coordinator: -
Standard: FCC Part 15.247, 15.407, RSS-210	Class: N/A

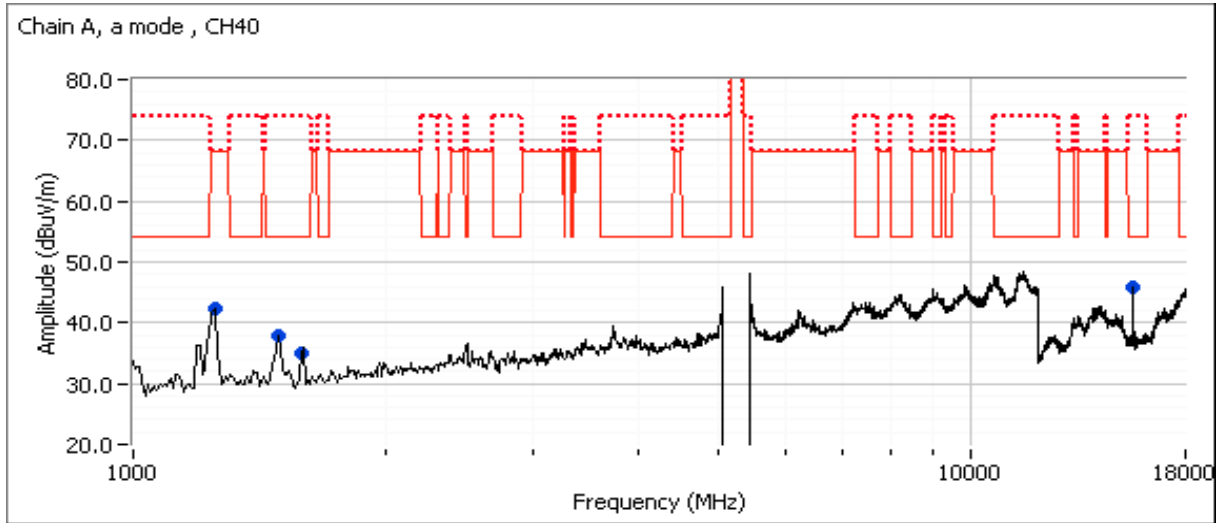



# EMC Test Data

Client: Intel Corporation	Job Number: J94914
Model: 7265D2W	T-Log Number: T95472
Contact: Steve Hackett	Project Manager: Christine Krebill
Standard: FCC Part 15.247, 15.407, RSS-210	Project Coordinator: -
	Class: N/A

## Run #1b: Center Channel

Channel: 40 Mode: a  
 Tx Chain: B Data Rate: 6.0Mbps

Power Settings		
Target (dBm)	Measured (dBm)	Software Setting
16.0	16.2	28.5

Frequency MHz	Level dB $\mu$ V/m	Pol v/h	15.209 / 15E		Detector Pk/QP/Avg	Azimuth degrees	Height meters	Comments
			Limit	Margin				
20799.900	48.2	V	54.0	-5.8	AVG	116	1.2	RB 1 MHz;VB 10 Hz;Peak
20799.830	57.0	V	74.0	-17.0	PK	116	1.2	RB 1 MHz;VB 3 MHz;Peak
11530.410	44.4	H	54.0	-9.6	PK	17	1.5	Noise floor
11530.410	57.1	H	74.0	-16.9	PK	17	1.5	Noise floor
1247.340	53.0	V	68.3	-15.3	PK	143	1.4	RB 1 MHz;VB 3 MHz;Peak
1497.200	30.5	V	54.0	-23.5	AVG	146	1.4	RB 1 MHz;VB 10 Hz;Peak
1480.270	47.6	V	74.0	-26.4	PK	146	1.4	RB 1 MHz;VB 3 MHz;Peak
1598.940	30.5	V	54.0	-23.5	AVG	77	1.6	RB 1 MHz;VB 10 Hz;Peak
1594.470	45.7	V	74.0	-28.3	PK	77	1.6	RB 1 MHz;VB 3 MHz;Peak
15599.000	44.1	V	54.0	-9.9	AVG	182	1.0	RB 1 MHz;VB 10 Hz;Peak
15590.470	55.9	V	74.0	-18.1	PK	182	1.0	RB 1 MHz;VB 3 MHz;Peak

- Note: Scans made between 18 - 40 GHz with the measurement antenna moved around the card and its antennas 20-50cm from the device and emissions recorded in this frequency range were maximized at 3m.
- Note 1: For emissions in restricted bands, the limit of 15.209 was used which requires average and peak measurements.
- Note 2: For emissions outside of the restricted bands the limit is -27dBm/MHz eirp (68.3dBuV/m). The measurement method required is a peak measurement (RB=1MHz, VB $\geq$ 3MHz, peak detector).

Client: Intel Corporation	Job Number: J94914
Model: 7265D2W	T-Log Number: T95472
	Project Manager: Christine Krebill
Contact: Steve Hackett	Project Coordinator: -
Standard: FCC Part 15.247, 15.407, RSS-210	Class: N/A

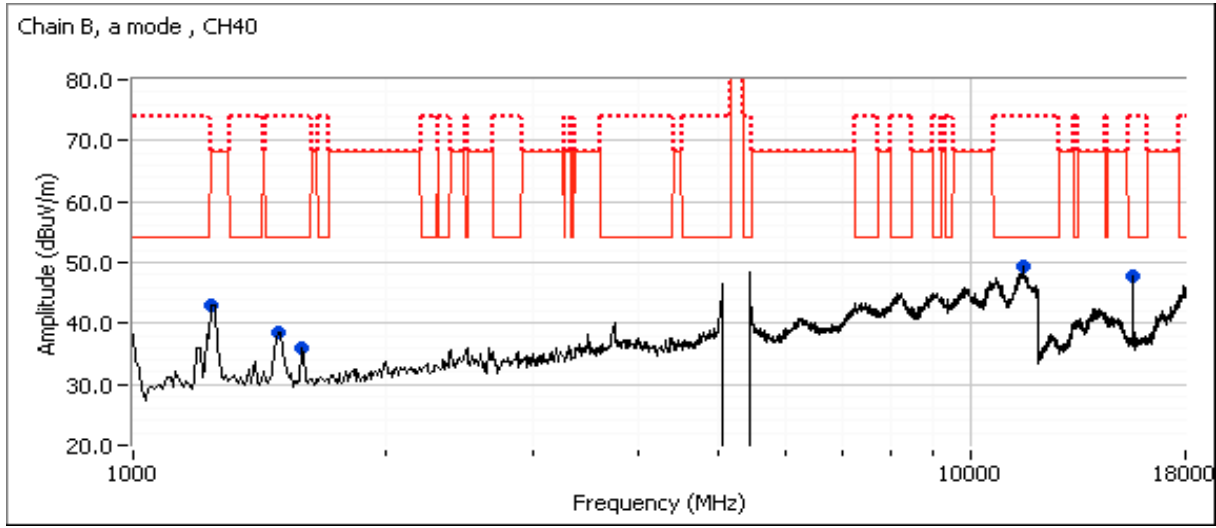



# EMC Test Data

Client:	Intel Corporation	Job Number:	J94914
Model:	7265D2W	T-Log Number:	T95472
Contact:	Steve Hackett	Project Manager:	Christine Krebill
Standard:	FCC Part 15.247, 15.407, RSS-210	Project Coordinator:	-
		Class:	N/A

## Run #1c: Center Channel

Channel: 40                      Mode: 11n20  
 Tx Chain: A+B                      Data Rate: 6.5Mbps

Chain	Power Settings								Software Setting
	Target (dBm)				Measured (dBm)				
	A	B	C	Total	A	B	C	Total	
	16.0	16.0		19.0	16.1	16.1		19.1	30.5 / 31.5

Frequency	Level	Pol	15.209 / 15E		Detector	Azimuth	Height	Comments
MHz	dB $\mu$ V/m	v/h	Limit	Margin	Pk/QP/Avg	degrees	meters	
15599.800	48.0	V	54.0	-6.0	AVG	197	1.0	RB 1 MHz;VB 10 Hz;Peak
15603.670	60.4	V	74.0	-13.6	PK	197	1.0	RB 1 MHz;VB 3 MHz;Peak
20799.820	45.7	V	54.0	-8.3	AVG	113	1.0	RB 1 MHz;VB 10 Hz;Peak
20800.170	55.0	V	74.0	-19.0	PK	113	1.0	RB 1 MHz;VB 3 MHz;Peak
1245.730	54.5	V	68.3	-13.8	PK	176	2.5	RB 1 MHz;VB 3 MHz;Peak
1497.470	29.8	H	54.0	-24.2	AVG	49	1.5	RB 1 MHz;VB 10 Hz;Peak
1493.340	51.5	H	74.0	-22.5	PK	49	1.5	RB 1 MHz;VB 3 MHz;Peak
3731.400	33.0	V	54.0	-21.0	AVG	169	1.2	RB 1 MHz;VB 10 Hz;Peak
3739.470	49.6	V	74.0	-24.4	PK	169	1.2	RB 1 MHz;VB 3 MHz;Peak

- Note: Scans made between 18 - 40 GHz with the measurement antenna moved around the card and its antennas 20-50cm from the device and emissions recorded in this frequency range were maximized at 3m.
- Note 1: For emissions in restricted bands, the limit of 15.209 was used which requires average and peak measurements.
- Note 2: For emissions outside of the restricted bands the limit is -27dBm/MHz eirp (68.3dBuV/m). The measurement method required is a peak measurement (RB=1MHz, VB $\geq$ 3MHz, peak detector).



Client: Intel Corporation	Job Number: J94914
Model: 7265D2W	T-Log Number: T95472
	Project Manager: Christine Krebill
Contact: Steve Hackett	Project Coordinator: -
Standard: FCC Part 15.247, 15.407, RSS-210	Class: N/A

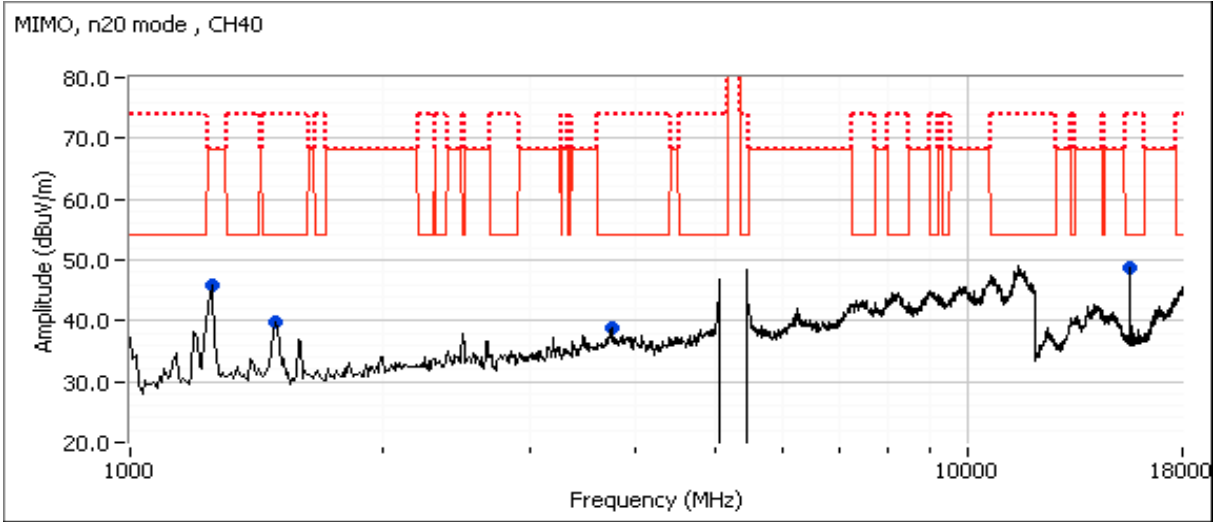



# EMC Test Data

Client:	Intel Corporation	Job Number:	J94914
Model:	7265D2W	T-Log Number:	T95472
Contact:	Steve Hackett	Project Manager:	Christine Krebill
Standard:	FCC Part 15.247, 15.407, RSS-210	Project Coordinator:	-
		Class:	N/A

## Run #1d: Center Channel

Channel: 38                      Mode: 11n40  
 Tx Chain: A+B                      Data Rate: 13.5Mbps

Chain	Power Settings								Software Setting
	Target (dBm)				Measured (dBm)				
	A	B	C	Total	A	B	C	Total	
	16.5	16.5		19.5	16.6	16.5		19.6	31.5 / 32.5

Frequency	Level	Pol	15.209 / 15E		Detector	Azimuth	Height	Comments
MHz	dB $\mu$ V/m	v/h	Limit	Margin	Pk/QP/Avg	degrees	meters	
20759.870	47.4	V	54.0	-6.6	AVG	112	1.7	Note 3
20760.050	55.8	V	74.0	-18.2	PK	112	1.7	RB 1 MHz;VB 3 MHz;Peak
1495.540	28.4	V	54.0	-25.6	AVG	360	1.0	RB 1 MHz;VB 10 Hz;Peak
1497.400	49.7	V	74.0	-24.3	PK	360	1.0	RB 1 MHz;VB 3 MHz;Peak
1000.070	24.5	V	54.0	-29.5	AVG	105	0.9	RB 1 MHz;VB 10 Hz;Peak
1000.070	43.8	V	74.0	-30.2	PK	105	0.9	RB 1 MHz;VB 3 MHz;Peak
1248.670	49.4	V	68.3	-18.9	PK	174	0.9	RB 1 MHz;VB 3 MHz;Peak
15562.330	42.0	V	54.0	-12.0	AVG	197	1.0	RB 1 MHz;VB 10 Hz;Peak
15554.930	52.7	V	74.0	-21.3	PK	197	1.0	RB 1 MHz;VB 3 MHz;Peak

- Note: Scans made between 18 - 40 GHz with the measurement antenna moved around the card and its antennas 20-50cm from the device and emissions recorded in this frequency range were maximized at 3m.
- Note 1: For emissions in restricted bands, the limit of 15.209 was used which requires average and peak measurements.
- Note 2: For emissions outside of the restricted bands the limit is -27dBm/MHz eirp (68.3dBuV/m). The measurement method required is a peak measurement (RB=1MHz, VB $\geq$ 3MHz, peak detector).

Client: Intel Corporation	Job Number: J94914
Model: 7265D2W	T-Log Number: T95472
	Project Manager: Christine Krebill
Contact: Steve Hackett	Project Coordinator: -
Standard: FCC Part 15.247, 15.407, RSS-210	Class: N/A

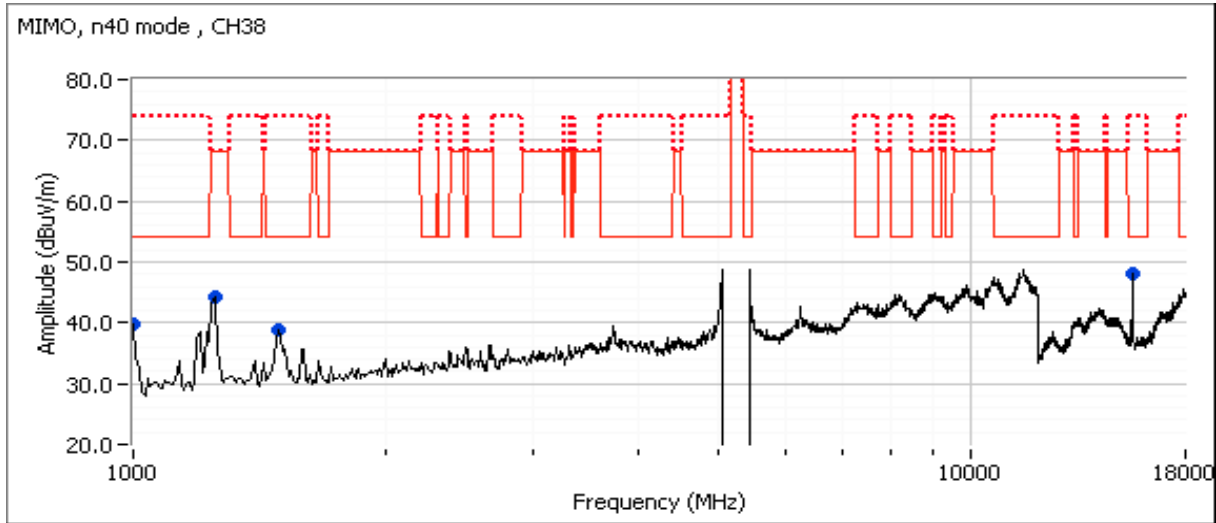



# EMC Test Data

Client: Intel Corporation	Job Number: J94914
Model: 7265D2W	T-Log Number: T95472
Contact: Steve Hackett	Project Manager: Christine Krebill
Standard: FCC Part 15.247, 15.407, RSS-210	Project Coordinator: -
	Class: N/A

## Run #1e: Center Channel

Channel: 42                      Mode: ac80  
 Tx Chain: A+B                      Data Rate: 29.3Mbps

Chain	Power Settings								Software Setting
	Target (dBm)				Measured (dBm)				
	A	B	C	Total	A	B	C	Total	
	13.5	13.5		16.5	13.5	13.5		16.5	21.0 / 22.0

Frequency	Level	Pol	15.209 / 15E		Detector	Azimuth	Height	Comments
MHz	dB $\mu$ V/m	v/h	Limit	Margin	Pk/QP/Avg	degrees	meters	
20839.880	47.1	V	54.0	-6.9	AVG	117	1.2	Note 3
20839.850	55.7	V	74.0	-18.3	PK	117	1.2	RB 1 MHz;VB 3 MHz;Peak
1495.200	29.9	H	54.0	-24.1	AVG	49	1.3	RB 1 MHz;VB 10 Hz;Peak
1494.070	52.8	H	74.0	-21.2	PK	49	1.3	RB 1 MHz;VB 3 MHz;Peak
3735.670	32.4	H	54.0	-21.6	AVG	299	1.2	RB 1 MHz;VB 10 Hz;Peak
3739.670	48.5	H	74.0	-25.5	PK	299	1.2	RB 1 MHz;VB 3 MHz;Peak
1247.270	47.0	H	68.3	-21.3	PK	105	2.0	RB 1 MHz;VB 3 MHz;Peak

- Note: Scans made between 18 - 40 GHz with the measurement antenna moved around the card and its antennas 20-50cm from the device and emissions recorded in this frequency range were maximized at 3m.
- Note 1: For emissions in restricted bands, the limit of 15.209 was used which requires average and peak measurements.
- Note 2: For emissions outside of the restricted bands the limit is -27dBm/MHz eirp (68.3dBuV/m). The measurement method required is a peak measurement (RB=1MHz, VB $\geq$ 3MHz, peak detector).

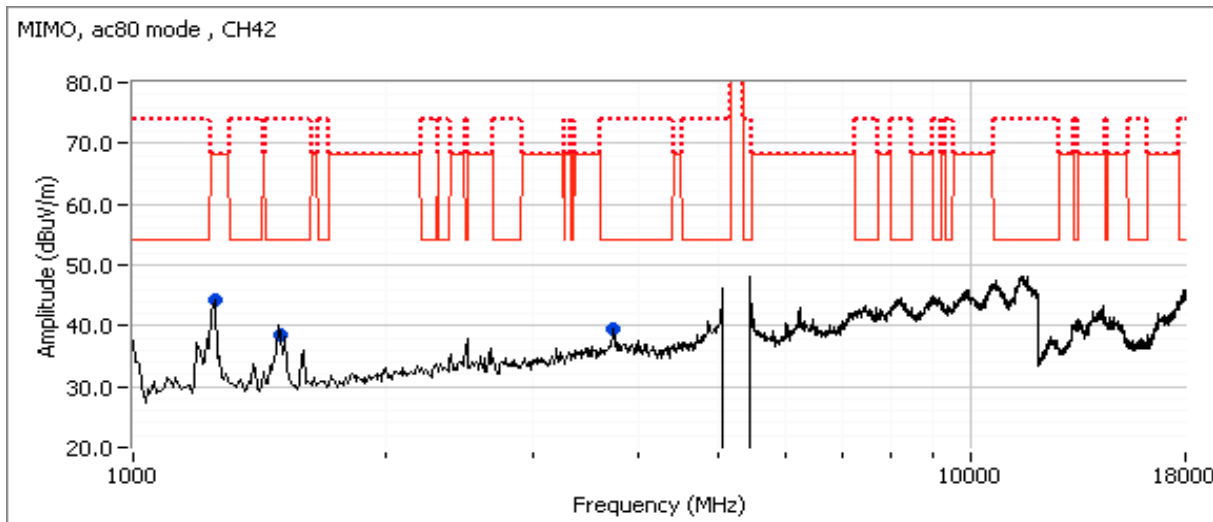



# EMC Test Data

Client:	Intel Corporation	Job Number:	J94914
Model:	7265D2W	T-Log Number:	T95472
Contact:	Steve Hackett	Project Manager:	Christine Krebill
Standard:	FCC Part 15.247, 15.407, RSS-210	Project Coordinator:	-
		Class:	N/A

Run #2: Radiated Spurious Emissions, 1,000 - 40000 MHz. Operating Mode: Worse case from Run #1  
 Date of Test: 6/16/2014 0:00 Config. Used: 1  
 Test Engineer: Rafael Varelas Config Change: None  
 Test Location: FT Chamber4 EUT Voltage: 120V

Run #2a: Low Channel

Channel: 36 Mode: 11n20  
 Tx Chain: A+B Data Rate: 6.5Mbps

Chain	Target (dBm)				Power Settings Measured (dBm)				Software Setting
	A	B	C	Total	A	B	C	Total	
	11.5	11.5		14.5	11.6	11.5		14.6	22.0, 23.5

Frequency	Level	Pol	15.209 / 15.247		Detector	Azimuth	Height	Comments
MHz	dB $\mu$ V/m	v/h	Limit	Margin	Pk/QP/Avg	degrees	meters	
20719.900	47.8	V	54.0	-6.2	AVG	118	1.8	RB 1 MHz;VB 10 Hz;Peak
20719.650	56.0	V	74.0	-18.0	PK	118	1.8	RB 1 MHz;VB 3 MHz;Peak
1594.220	29.5	V	54.0	-24.5	AVG	84	1.4	RB 1 MHz;VB 10 Hz;Peak
1592.820	43.8	V	74.0	-30.2	PK	84	1.4	RB 1 MHz;VB 3 MHz;Peak
1195.340	30.2	V	54.0	-23.8	AVG	259	1.2	RB 1 MHz;VB 10 Hz;Peak
1194.760	52.5	V	74.0	-21.5	PK	259	1.2	RB 1 MHz;VB 3 MHz;Peak
15540.070	38.1	V	54.0	-15.9	AVG	176	1.0	RB 1 MHz;VB 10 Hz;Peak
15543.270	50.3	V	74.0	-23.7	PK	176	1.0	RB 1 MHz;VB 3 MHz;Peak

Note: Scans made between 18 - 40 GHz with the measurement antenna moved around the card and its antennas 20-50cm from the device and emissions recorded in this frequency range were maximized at 3m.

Client: Intel Corporation	Job Number: J94914
Model: 7265D2W	T-Log Number: T95472
	Project Manager: Christine Krebill
Contact: Steve Hackett	Project Coordinator: -
Standard: FCC Part 15.247, 15.407, RSS-210	Class: N/A

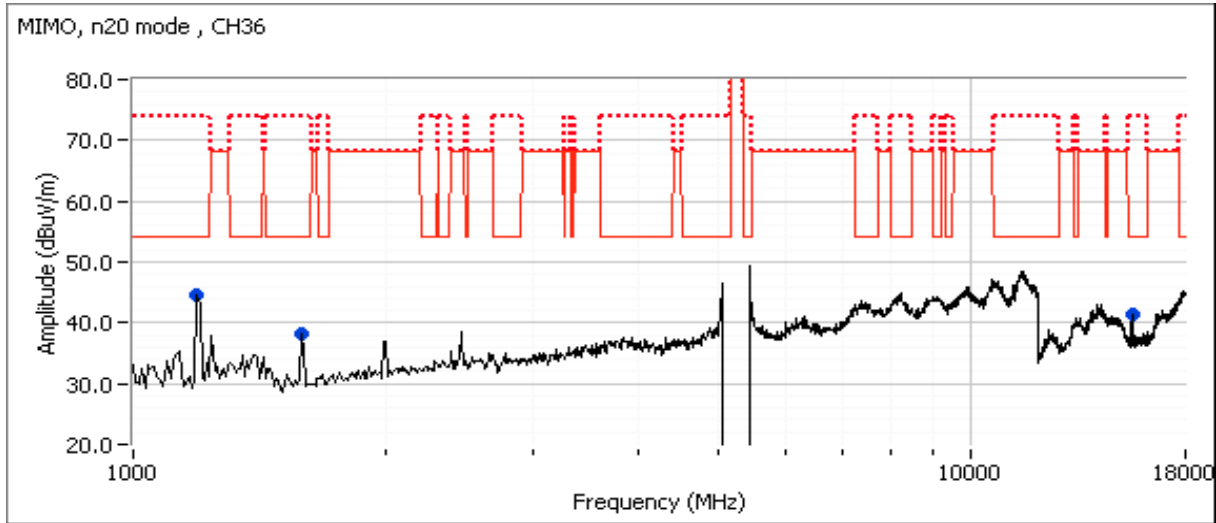



# EMC Test Data

Client: Intel Corporation	Job Number: J94914
Model: 7265D2W	T-Log Number: T95472
Contact: Steve Hackett	Project Manager: Christine Krebill
Standard: FCC Part 15.247, 15.407, RSS-210	Project Coordinator: -
	Class: N/A

## Run #2b: High Channel

Channel: 48                      Mode: 11n20  
 Tx Chain: A+B                  Data Rate: 6.5Mbps

Chain	Power Settings								Software Setting
	Target (dBm)				Measured (dBm)				
	A	B	C	Total	A	B	C	Total	
	16.0	16.0		19.0	16.1	16.2		19.2	29.0, 30.0

Frequency	Level	Pol	15.209 / 15.247		Detector	Azimuth	Height	Comments
MHz	dB $\mu$ V/m	v/h	Limit	Margin	PK/QP/Avg	degrees	meters	
20959.880	45.9	V	54.0	-8.1	AVG	117	1.7	RB 1 MHz;VB 10 Hz;Peak
20958.950	56.2	V	74.0	-17.8	PK	117	1.7	RB 1 MHz;VB 3 MHz;Peak
1243.430	42.1	H	68.3	-26.2	PK	126	1.0	RB 1 MHz;VB 3 MHz;Peak
1602.570	28.6	H	54.0	-25.4	AVG	100	2.0	RB 1 MHz;VB 10 Hz;Peak
1600.610	39.6	H	74.0	-34.4	PK	100	2.0	RB 1 MHz;VB 3 MHz;Peak
15719.870	41.2	V	54.0	-12.8	AVG	181	0.9	RB 1 MHz;VB 10 Hz;Peak
15721.800	53.1	V	74.0	-20.9	PK	181	0.9	RB 1 MHz;VB 3 MHz;Peak

Note: Scans made between 18 - 40 GHz with the measurement antenna moved around the card and its antennas 20-50cm from the device and emissions recorded in this frequency range were maximized at 3m.

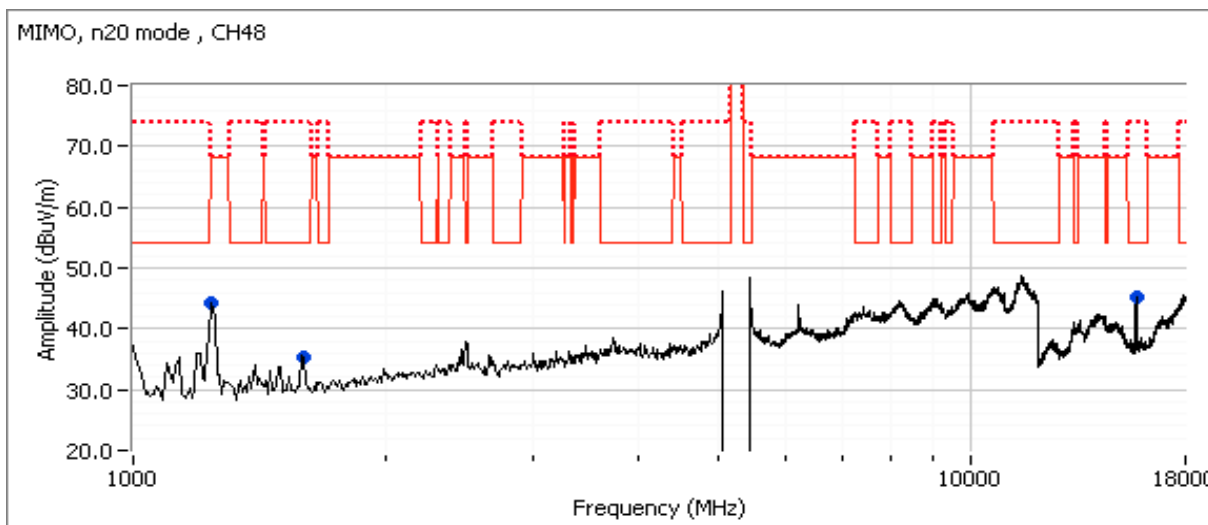





Client: Intel Corporation	Job Number: J94914
Model: 7265D2W	T-Log Number: T95472
	Project Manager: Christine Krebill
Contact: Steve Hackett	Project Coordinator: -
Standard: FCC Part 15.247, 15.407, RSS-210	Class: N/A

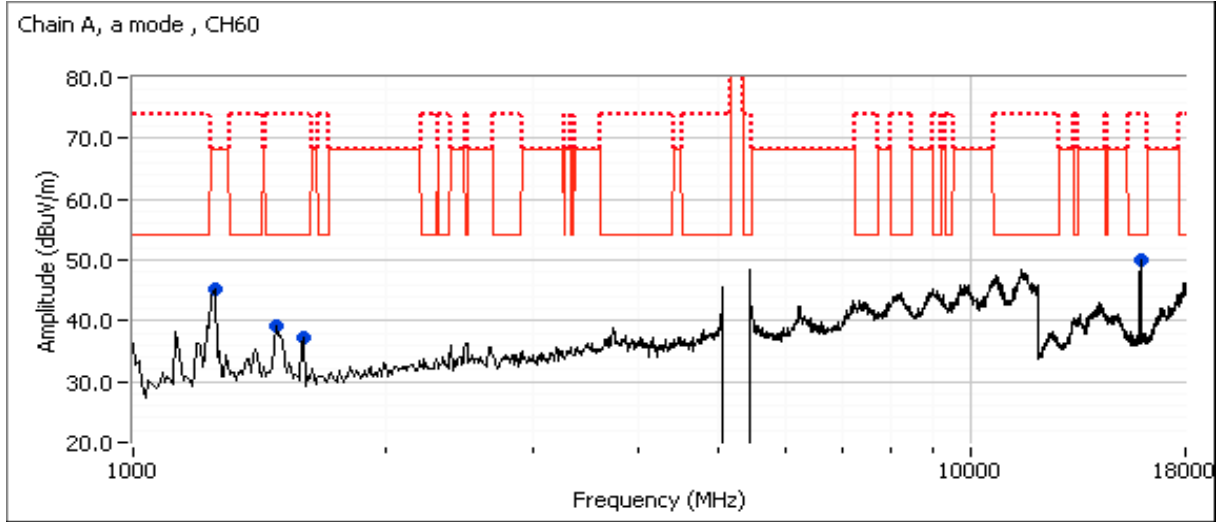



# EMC Test Data

Client: Intel Corporation	Job Number: J94914
Model: 7265D2W	T-Log Number: T95472
	Project Manager: Christine Krebill
Contact: Steve Hackett	Project Coordinator: -
Standard: FCC Part 15.247, 15.407, RSS-210	Class: N/A

## Run #3b: Center Channel

Channel: 60                      Mode: a  
 Tx Chain: B                      Data Rate: 6.0Mbps

Power Settings		
Target (dBm)	Measured (dBm)	Software Setting
16.0	16.2	29.0

Frequency MHz	Level dB $\mu$ V/m	Pol v/h	15.209 / 15E		Detector Pk/QP/Avg	Azimuth degrees	Height meters	Comments
			Limit	Margin				
15902.200	47.4	V	54.0	-6.6	AVG	148	1.1	RB 1 MHz;VB 10 Hz;Peak
15902.000	59.0	V	74.0	-15.0	PK	148	1.1	RB 1 MHz;VB 3 MHz;Peak
21199.820	45.7	V	54.0	-8.3	AVG	76	1.5	RB 1 MHz;VB 10 Hz;Peak
21205.000	56.9	V	74.0	-17.1	PK	76	1.5	RB 1 MHz;VB 3 MHz;Peak
1245.580	32.4	V	68.3	-35.9	AVG	179	2.4	RB 1 MHz;VB 10 Hz;Peak
1598.200	31.6	V	54.0	-22.4	AVG	77	1.4	RB 1 MHz;VB 10 Hz;Peak
1599.290	45.6	V	74.0	-28.4	PK	77	1.4	RB 1 MHz;VB 3 MHz;Peak
1488.180	28.2	H	54.0	-25.8	AVG	48	1.2	RB 1 MHz;VB 10 Hz;Peak
1487.050	39.7	H	74.0	-34.3	PK	48	1.2	RB 1 MHz;VB 3 MHz;Peak
10625.270	43.2	H	54.0	-10.8	AVG	210	1.0	Noise floor
10611.000	54.5	H	74.0	-19.5	PK	210	1.0	Noise floor

- Note: Scans made between 18 - 40 GHz with the measurement antenna moved around the card and its antennas 20-50cm from the device and emissions recorded in this frequency range were maximized at 3m.
- Note 1: For emissions in restricted bands, the limit of 15.209 was used which requires average and peak measurements.
- Note 2: For emissions outside of the restricted bands the limit is -27dBm/MHz eirp (68.3dB $\mu$ V/m). The measurement method required is a peak measurement (RB=1MHz, VB $\geq$ 3MHz, peak detector).

Client: Intel Corporation	Job Number: J94914
Model: 7265D2W	T-Log Number: T95472
	Project Manager: Christine Krebill
Contact: Steve Hackett	Project Coordinator: -
Standard: FCC Part 15.247, 15.407, RSS-210	Class: N/A

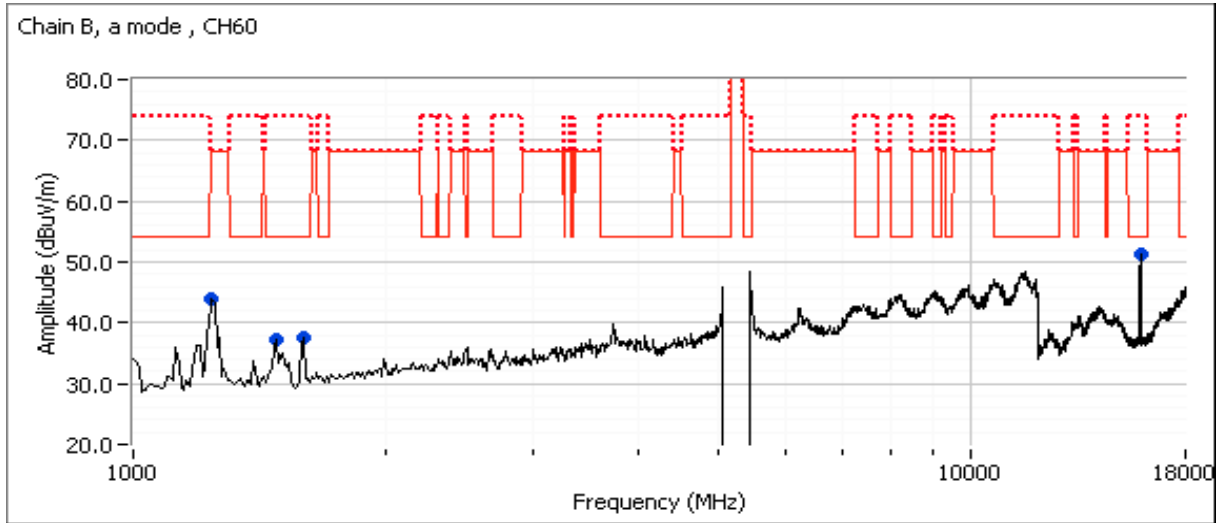



# EMC Test Data

Client: Intel Corporation	Job Number: J94914
Model: 7265D2W	T-Log Number: T95472
	Project Manager: Christine Krebill
Contact: Steve Hackett	Project Coordinator: -
Standard: FCC Part 15.247, 15.407, RSS-210	Class: N/A

## Run #3c: Center Channel

Channel: 60                      Mode: 11n20  
 Tx Chain: A+B                  Data Rate: 6.5Mbps

Chain	Power Settings								Software Setting
	Target (dBm)				Measured (dBm)				
	A	B	C	Total	A	B	C	Total	
	16.0	16.0		19.0	16.0	16.0		19.0	31.5,32.5

Frequency	Level	Pol	15.209 / 15E		Detector	Azimuth	Height	Comments
MHz	dB $\mu$ V/m	v/h	Limit	Margin	Pk/QP/Avg	degrees	meters	
15903.000	51.6	V	54.0	-2.4	AVG	191	1.0	RB 1 MHz;VB 10 Hz;Peak
15906.730	64.9	V	74.0	-9.1	PK	191	1.0	RB 1 MHz;VB 3 MHz;Peak
21199.900	45.5	V	54.0	-8.5	AVG	120	1.6	RB 1 MHz;VB 10 Hz;Peak
21199.420	57.3	V	74.0	-16.7	PK	120	1.6	RB 1 MHz;VB 3 MHz;Peak
3737.370	32.5	V	54.0	-21.5	AVG	199	2.0	RB 1 MHz;VB 10 Hz;Peak
3747.440	47.2	V	74.0	-26.8	PK	199	2.0	RB 1 MHz;VB 3 MHz;Peak
1245.190	29.9	V	68.3	-38.4	AVG	173	0.9	RB 1 MHz;VB 10 Hz;Peak
1498.550	29.2	H	54.0	-24.8	AVG	82	1.2	RB 1 MHz;VB 10 Hz;Peak
1499.420	51.3	H	74.0	-22.7	PK	82	1.2	RB 1 MHz;VB 3 MHz;Peak
10615.140	43.2	H	54.0	-10.8	AVG	279	1.0	Noise floor
10614.970	54.3	H	74.0	-19.7	PK	279	1.0	Noise floor

- Note: Scans made between 18 - 40 GHz with the measurement antenna moved around the card and its antennas 20-50cm from the device and emissions recorded in this frequency range were maximized at 3m.
- Note 1: For emissions in restricted bands, the limit of 15.209 was used which requires average and peak measurements.
- Note 2: For emissions outside of the restricted bands the limit is -27dBm/MHz eirp (68.3dBuV/m). The measurement method required is a peak measurement (RB=1MHz, VB≥3MHz, peak detector).

Client: Intel Corporation	Job Number: J94914
Model: 7265D2W	T-Log Number: T95472
	Project Manager: Christine Krebill
Contact: Steve Hackett	Project Coordinator: -
Standard: FCC Part 15.247, 15.407, RSS-210	Class: N/A

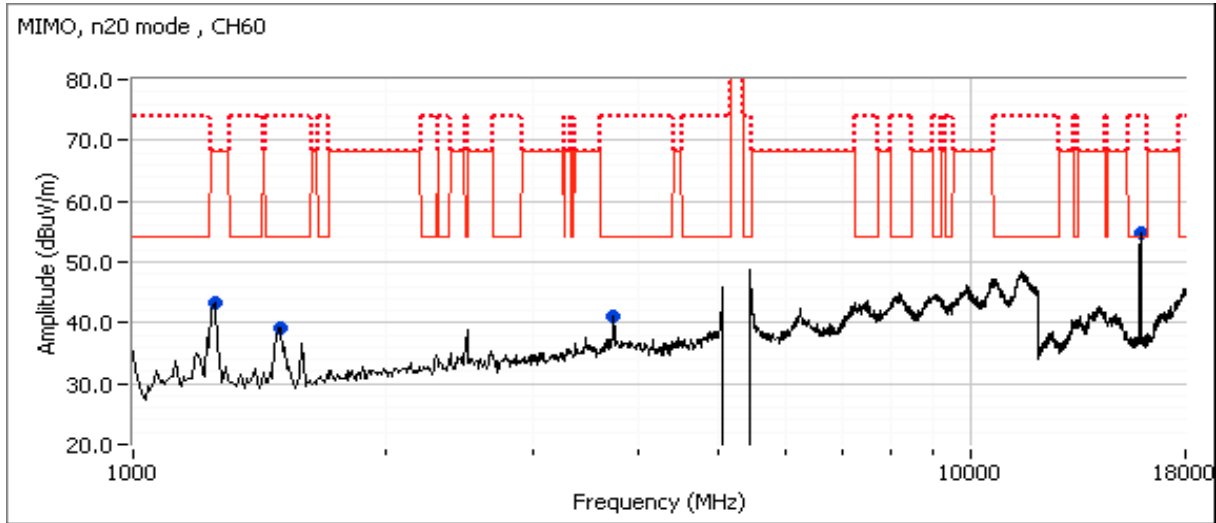



# EMC Test Data

Client:	Intel Corporation	Job Number:	J94914
Model:	7265D2W	T-Log Number:	T95472
Contact:	Steve Hackett	Project Manager:	Christine Krebill
Standard:	FCC Part 15.247, 15.407, RSS-210	Project Coordinator:	-
		Class:	N/A

## Run #3d: Center Channel

Channel: 54                      Mode: 11n40  
 Tx Chain: A+B                      Data Rate: 13.5Mbps

Chain	Power Settings								Software Setting
	Target (dBm)				Measured (dBm)				
	A	B	C	Total	A	B	C	Total	
	16.5	16.5		19.5	16.6	16.5		19.6	30.5, 32.0

Frequency	Level	Pol	15.209 / 15E		Detector	Azimuth	Height	Comments
MHz	dB $\mu$ V/m	v/h	Limit	Margin	Pk/QP/Avg	degrees	meters	
21080.000	45.0	V	54.0	-9.0	AVG	114	1.0	Note 3
21076.520	56.2	V	74.0	-17.8	PK	114	1.0	RB 1 MHz;VB 3 MHz;Peak
1596.120	30.1	V	54.0	-23.9	AVG	322	1.0	RB 1 MHz;VB 10 Hz;Peak
1595.520	43.3	V	74.0	-30.7	PK	322	1.0	RB 1 MHz;VB 3 MHz;Peak
1249.270	48.2	V	68.3	-20.1	PK	169	1.0	RB 1 MHz;VB 3 MHz;Peak
10541.870	53.4	V	68.3	-14.9	PK	143	1.0	Noise floor
1479.890	27.8	H	54.0	-26.2	AVG	73	1.0	RB 1 MHz;VB 10 Hz;Peak
1478.950	42.7	H	74.0	-31.3	PK	73	1.0	RB 1 MHz;VB 3 MHz;Peak
15812.270	43.2	V	54.0	-10.8	AVG	172	1.0	RB 1 MHz;VB 10 Hz;Peak
15826.270	55.7	V	74.0	-18.3	PK	172	1.0	RB 1 MHz;VB 3 MHz;Peak

- Note: Scans made between 18 - 40 GHz with the measurement antenna moved around the card and its antennas 20-50cm from the device and emissions recorded in this frequency range were maximized at 3m.
- Note 1: For emissions in restricted bands, the limit of 15.209 was used which requires average and peak measurements.
- Note 2: For emissions outside of the restricted bands the limit is -27dBm/MHz eirp (68.3dBuV/m). The measurement method required is a peak measurement (RB=1MHz, VB $\geq$ 3MHz, peak detector).

Client:	Intel Corporation	Job Number:	J94914
Model:	7265D2W	T-Log Number:	T95472
Contact:	Steve Hackett	Project Manager:	Christine Krebill
Standard:	FCC Part 15.247, 15.407, RSS-210	Project Coordinator:	-
		Class:	N/A

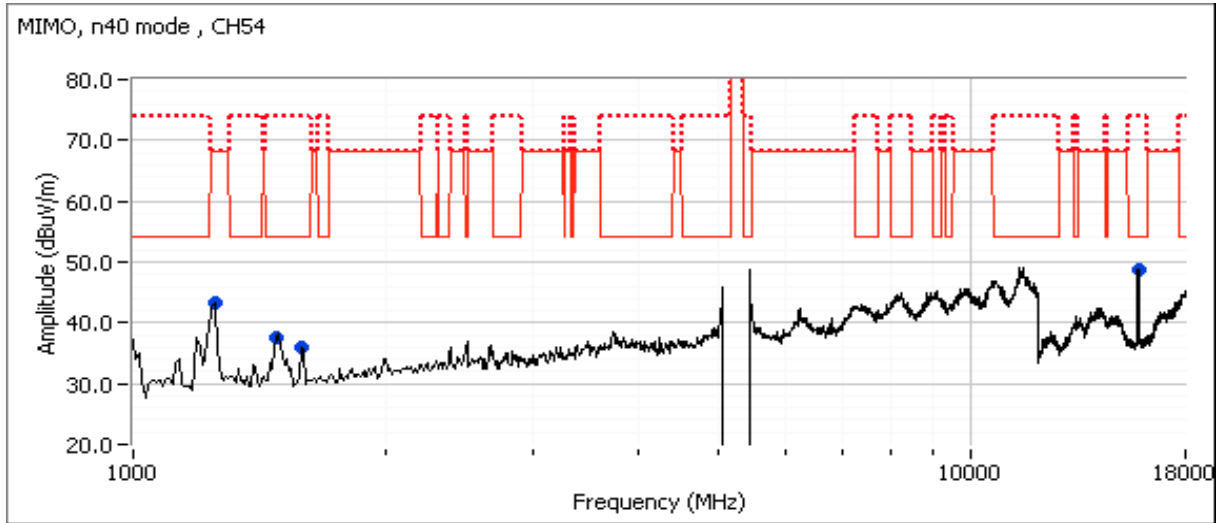



# EMC Test Data

Client:	Intel Corporation	Job Number:	J94914
Model:	7265D2W	T-Log Number:	T95472
Contact:	Steve Hackett	Project Manager:	Christine Krebill
Standard:	FCC Part 15.247, 15.407, RSS-210	Project Coordinator:	-
		Class:	N/A

## Run #3e: Center Channel

Channel: 58                      Mode: ac80  
 Tx Chain: A+B                      Data Rate: 29.3Mbps

Chain	Power Settings								Software Setting
	Target (dBm)				Measured (dBm)				
	A	B	C	Total	A	B	C	Total	
	13.5	13.5		16.5	13.6	13.6		16.6	21.5, 23.5

Frequency	Level	Pol	15.209 / 15E		Detector	Azimuth	Height	Comments
MHz	dB $\mu$ V/m	v/h	Limit	Margin	Pk/QP/Avg	degrees	meters	
21159.850	45.9	V	54.0	-8.1	AVG	80	1.0	Note 3
21162.300	55.5	V	74.0	-18.5	PK	80	1.0	RB 1 MHz;VB 3 MHz;Peak
1132.710	34.1	V	54.0	-19.9	AVG	289	1.3	RB 1 MHz;VB 10 Hz;Peak
1131.910	45.9	V	74.0	-28.1	PK	289	1.3	RB 1 MHz;VB 3 MHz;Peak
1249.360	48.9	V	68.3	-19.4	PK	186	1.0	RB 1 MHz;VB 3 MHz;Peak
1496.510	30.5	H	54.0	-23.5	AVG	63	1.3	RB 1 MHz;VB 10 Hz;Peak
1496.150	50.9	H	74.0	-23.1	PK	63	1.3	RB 1 MHz;VB 3 MHz;Peak
10580.580	55.7	H	68.3	-12.6	PK	46	1.0	Noise floor
15902.330	32.9	V	54.0	-21.1	AVG	150	1.0	RB 1 MHz;VB 10 Hz;Peak
15902.600	46.7	V	74.0	-27.3	PK	150	1.0	RB 1 MHz;VB 3 MHz;Peak

- Note: Scans made between 18 - 40 GHz with the measurement antenna moved around the card and its antennas 20-50cm from the device and emissions recorded in this frequency range were maximized at 3m.
- Note 1: For emissions in restricted bands, the limit of 15.209 was used which requires average and peak measurements.
- Note 2: For emissions outside of the restricted bands the limit is -27dBm/MHz eirp (68.3dBuV/m). The measurement method required is a peak measurement (RB=1MHz, VB≥3MHz, peak detector).



Client: Intel Corporation	Job Number: J94914
Model: 7265D2W	T-Log Number: T95472
	Project Manager: Christine Krebill
Contact: Steve Hackett	Project Coordinator: -
Standard: FCC Part 15.247, 15.407, RSS-210	Class: N/A

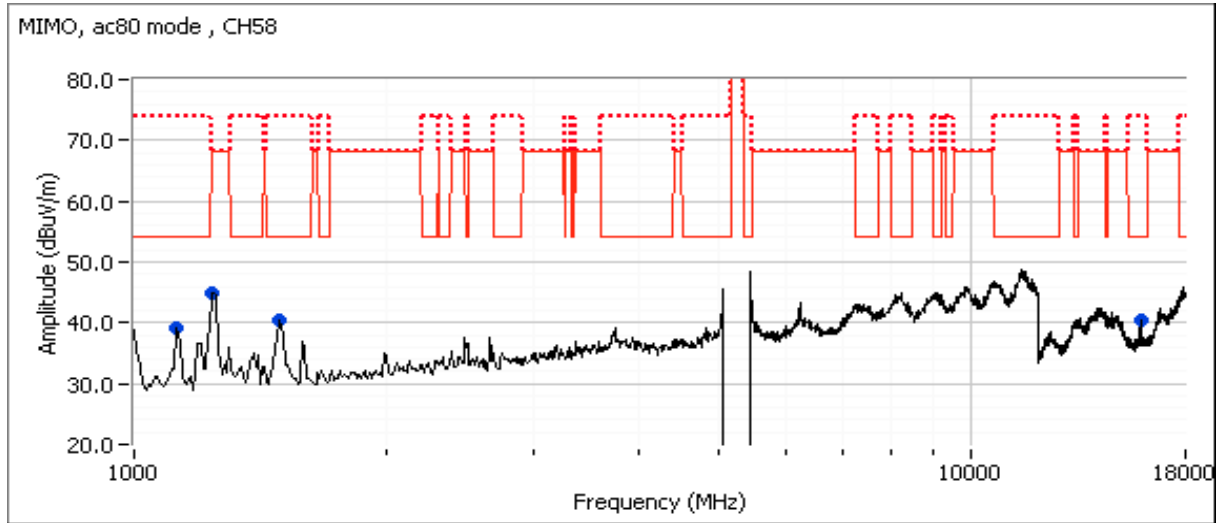



# EMC Test Data

Client:	Intel Corporation	Job Number:	J94914
Model:	7265D2W	T-Log Number:	T95472
Contact:	Steve Hackett	Project Manager:	Christine Krebill
Standard:	FCC Part 15.247, 15.407, RSS-210	Project Coordinator:	-
		Class:	N/A

Run #4: Radiated Spurious Emissions, 1,000 - 40000 MHz. Operating Mode: Worse case from Run #3  
 Date of Test: 6/16/2014 0:00 Config. Used: 1  
 Test Engineer: Rafael Varelas Config Change: None  
 Test Location: FT Chamber4 EUT Voltage: 120V

Run #4a: Low Channel

Channel: 52 Mode: 11n20  
 Tx Chain: A+B Data Rate: 6.5Mbps

Chain	Target (dBm)				Power Settings Measured (dBm)				Software Setting
	A	B	C	Total	A	B	C	Total	
	16.0	16.0		19.0	16.0	16.1		19.1	29.0, 30.0

Frequency	Level	Pol	15.209 / 15.247		Detector	Azimuth	Height	Comments
MHz	dB $\mu$ V/m	v/h	Limit	Margin	Pk/QP/Avg	degrees	meters	
21039.830	45.8	V	54.0	-8.2	AVG	115	1.7	RB 1 MHz;VB 10 Hz;Peak
21041.250	56.2	V	74.0	-17.8	PK	115	1.7	RB 1 MHz;VB 3 MHz;Peak
1494.210	28.2	H	54.0	-25.8	AVG	106	1.7	RB 1 MHz;VB 10 Hz;Peak
1492.730	44.6	H	74.0	-29.4	PK	106	1.7	RB 1 MHz;VB 3 MHz;Peak
1243.260	39.9	H	68.3	-28.4	PK	224	1.1	RB 1 MHz;VB 3 MHz;Peak
15780.130	43.6	V	54.0	-10.4	AVG	134	1.0	RB 1 MHz;VB 10 Hz;Peak
15778.070	56.3	V	74.0	-17.7	PK	134	1.0	RB 1 MHz;VB 3 MHz;Peak

Note: Scans made between 18 - 40 GHz with the measurement antenna moved around the card and its antennas 20-50cm from the device and emissions recorded in this frequency range were maximized at 3m.

Client:	Intel Corporation	Job Number:	J94914
Model:	7265D2W	T-Log Number:	T95472
Contact:	Steve Hackett	Project Manager:	Christine Krebill
Standard:	FCC Part 15.247, 15.407, RSS-210	Project Coordinator:	-
		Class:	N/A

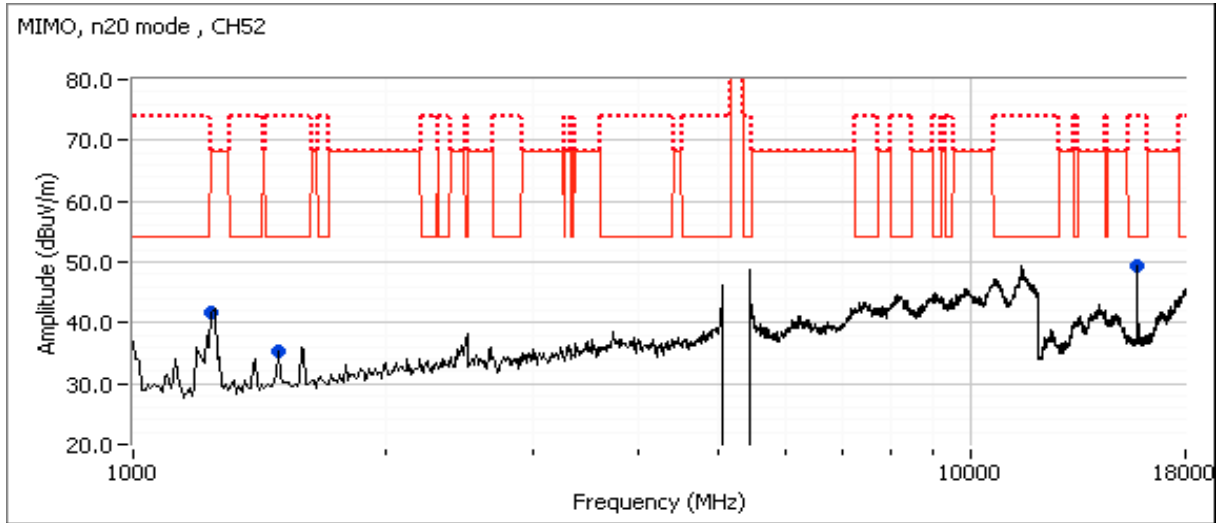



# EMC Test Data

Client: Intel Corporation	Job Number: J94914
Model: 7265D2W	T-Log Number: T95472
Contact: Steve Hackett	Project Manager: Christine Krebill
Standard: FCC Part 15.247, 15.407, RSS-210	Project Coordinator: -
	Class: N/A

## Run #4b: High Channel

Channel: 64                      Mode: 11n20  
 Tx Chain: A+B                      Data Rate: 6.5Mbps

Chain	Power Settings								Software Setting
	Target (dBm)				Measured (dBm)				
	A	B	C	Total	A	B	C	Total	
	11.5	11.5		14.5	11.7	11.6		14.7	22.5, 24.0

Frequency	Level	Pol	15.209 / 15.247		Detector	Azimuth	Height	Comments
MHz	dB $\mu$ V/m	v/h	Limit	Margin	PK/QP/Avg	degrees	meters	
21279.850	45.9	V	54.0	-8.1	AVG	80	1.4	RB 1 MHz;VB 10 Hz;Peak
21279.800	56.3	V	74.0	-17.7	PK	80	1.4	RB 1 MHz;VB 3 MHz;Peak
1593.160	30.7	V	54.0	-23.3	AVG	66	1.5	RB 1 MHz;VB 10 Hz;Peak
1593.610	44.8	V	74.0	-29.2	PK	66	1.5	RB 1 MHz;VB 3 MHz;Peak
1243.680	44.3	H	68.3	-24.0	PK	212	1.0	RB 1 MHz;VB 3 MHz;Peak
15958.530	39.1	V	54.0	-14.9	AVG	160	1.0	RB 1 MHz;VB 10 Hz;Peak
15954.730	51.8	V	74.0	-22.2	PK	160	1.0	RB 1 MHz;VB 3 MHz;Peak

Note: Scans made between 18 - 40 GHz with the measurement antenna moved around the card and its antennas 20-50cm from the device and emissions recorded in this frequency range were maximized at 3m.

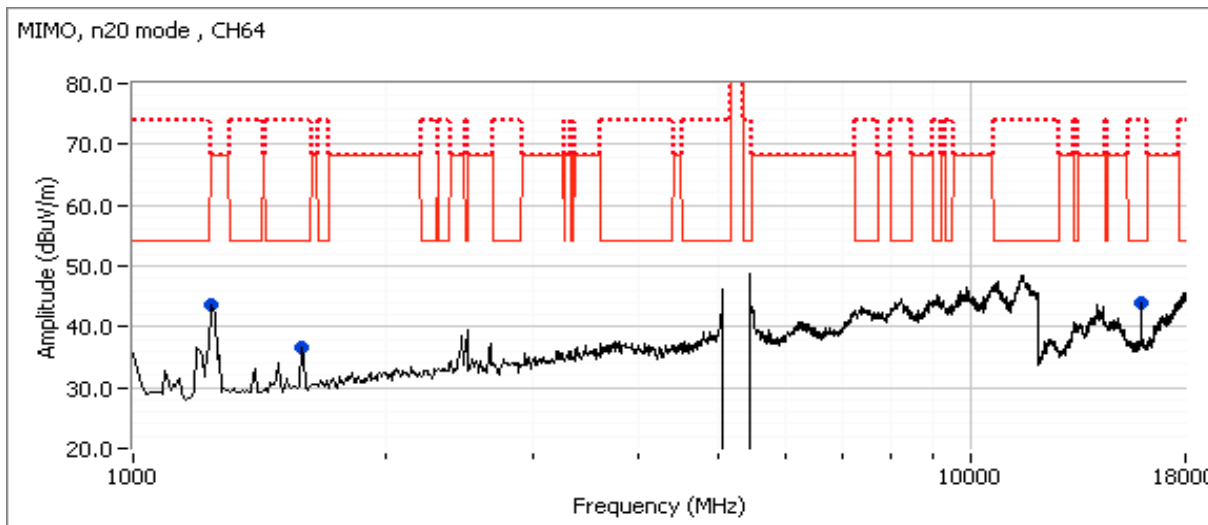



Client: Intel Corporation	Job Number: J94914
Model: 7265D2W	T-Log Number: T95472
	Project Manager: Christine Krebill
Contact: Steve Hackett	Project Coordinator: -
Standard: FCC Part 15.247, 15.407, RSS-210	Class: N/A

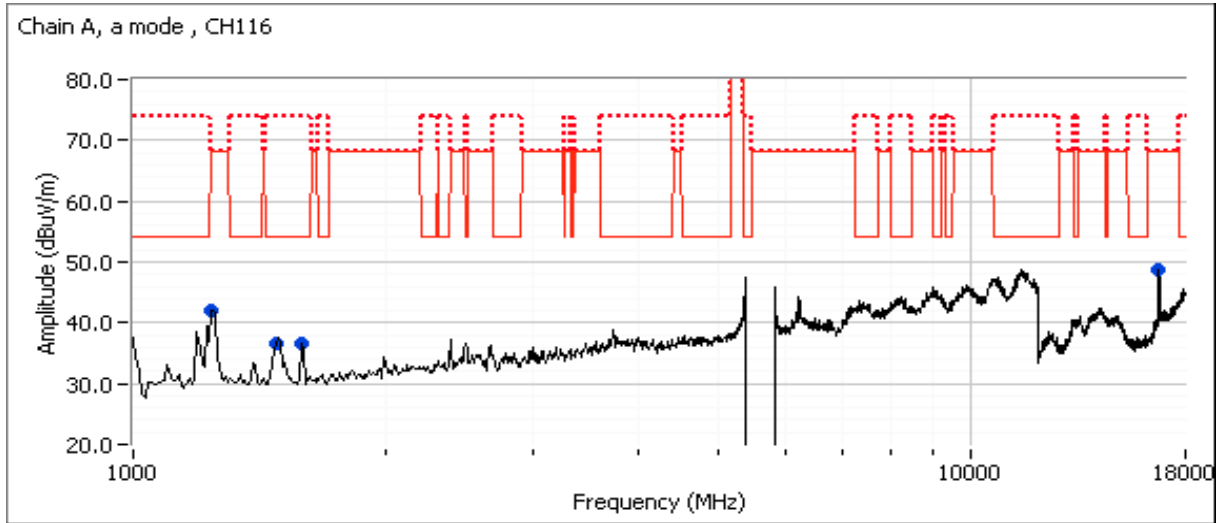



# EMC Test Data

Client: Intel Corporation	Job Number: J94914
Model: 7265D2W	T-Log Number: T95472
	Project Manager: Christine Krebill
Contact: Steve Hackett	Project Coordinator: -
Standard: FCC Part 15.247, 15.407, RSS-210	Class: N/A

## Run #5b: Center Channel

Channel: 116                      Mode: a  
 Tx Chain: B                      Data Rate: 6.0Mbps

Power Settings		
Target (dBm)	Measured (dBm)	Software Setting
16.5	16.6	26.0

Frequency MHz	Level dB $\mu$ V/m	Pol v/h	15.209 / 15E		Detector Pk/QP/Avg	Azimuth degrees	Height meters	Comments
			Limit	Margin				
22319.900	47.0	V	54.0	-7.0	AVG	125	1.0	RB 1 MHz;VB 10 Hz;Peak
22319.540	56.9	V	74.0	-17.1	PK	125	1.0	RB 1 MHz;VB 3 MHz;Peak
1248.010	48.5	V	68.3	-19.8	PK	173	1.0	RB 1 MHz;VB 3 MHz;Peak
1593.490	31.8	V	54.0	-22.2	AVG	85	1.4	RB 1 MHz;VB 10 Hz;Peak
1594.110	45.3	V	74.0	-28.7	PK	85	1.4	RB 1 MHz;VB 3 MHz;Peak
1487.770	28.7	H	54.0	-25.3	AVG	52	1.4	RB 1 MHz;VB 10 Hz;Peak
1487.390	42.3	H	74.0	-31.7	PK	52	1.4	RB 1 MHz;VB 3 MHz;Peak
11150.610	41.6	V	54.0	-12.4	AVG	285	1.0	Noise floor
11149.760	52.3	V	74.0	-21.7	PK	285	1.0	Noise floor
16742.330	61.2	V	68.3	-7.1	PK	166	0.9	RB 1 MHz;VB 3 MHz;Peak

- Note: Scans made between 18 - 40 GHz with the measurement antenna moved around the card and its antennas 20-50cm from the device and emissions recorded in this frequency range were maximized at 3m.
- Note 1: For emissions in restricted bands, the limit of 15.209 was used which requires average and peak measurements.
- Note 2: For emissions outside of the restricted bands the limit is -27dBm/MHz eirp (68.3dBuV/m). The measurement method required is a peak measurement (RB=1MHz, VB $\geq$ 3MHz, peak detector).

Client: Intel Corporation	Job Number: J94914
Model: 7265D2W	T-Log Number: T95472
	Project Manager: Christine Krebill
Contact: Steve Hackett	Project Coordinator: -
Standard: FCC Part 15.247, 15.407, RSS-210	Class: N/A

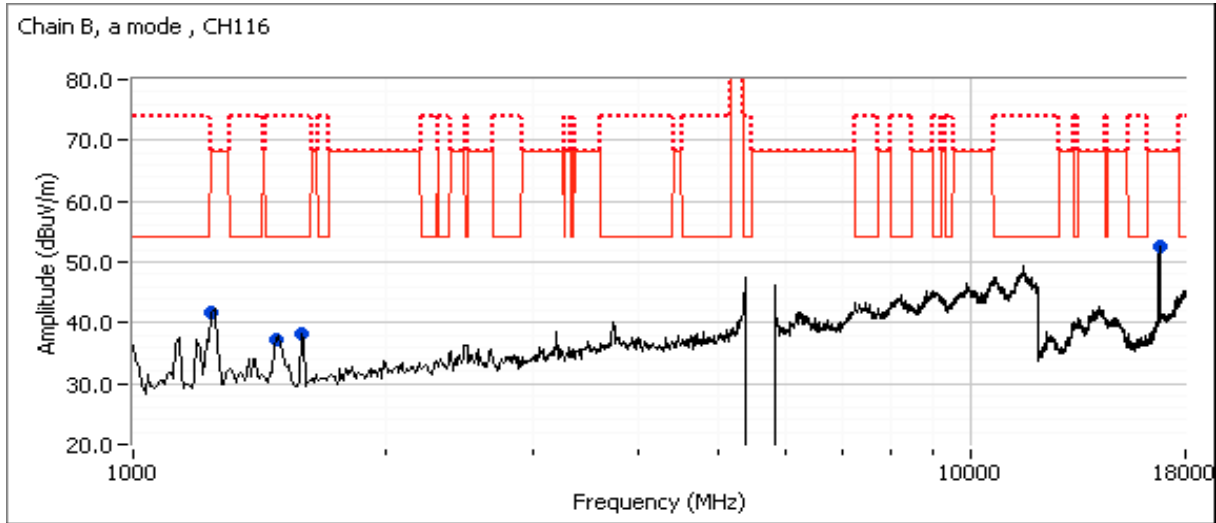





# EMC Test Data

Client: Intel Corporation	Job Number: J94914
Model: 7265D2W	T-Log Number: T95472
Contact: Steve Hackett	Project Manager: Christine Krebill
Standard: FCC Part 15.247, 15.407, RSS-210	Project Coordinator: -
	Class: N/A

## Run #5c: Center Channel

Channel: 116                      Mode: 11n20  
 Tx Chain: A+B                      Data Rate: 6.5Mbps

Chain	Power Settings								Software Setting
	Target (dBm)				Measured (dBm)				
	A	B	C	Total	A	B	C	Total	
	16.5	16.5		19.5	16.5	16.6		19.6	28.5, 29.5

Frequency	Level	Pol	15.209 / 15E		Detector	Azimuth	Height	Comments
MHz	dB $\mu$ V/m	v/h	Limit	Margin	Pk/QP/Avg	degrees	meters	
22319.850	46.2	V	54.0	-7.8	AVG	122	1.4	RB 1 MHz;VB 10 Hz;Peak
22320.700	56.1	V	74.0	-17.9	PK	122	1.4	RB 1 MHz;VB 3 MHz;Peak
1248.320	52.3	V	68.3	-16.0	PK	165	2.4	RB 1 MHz;VB 3 MHz;Peak
1596.430	30.7	V	54.0	-23.3	AVG	69	1.5	RB 1 MHz;VB 10 Hz;Peak
1599.190	43.3	V	74.0	-30.7	PK	69	1.5	RB 1 MHz;VB 3 MHz;Peak
1488.260	28.3	H	54.0	-25.7	AVG	45	1.2	RB 1 MHz;VB 10 Hz;Peak
1487.800	41.7	H	74.0	-32.3	PK	45	1.2	RB 1 MHz;VB 3 MHz;Peak
11151.510	41.6	V	54.0	-12.4	AVG	249	1.0	Noise floor
11150.310	53.1	V	74.0	-20.9	PK	249	1.0	Noise floor
16738.000	59.3	V	68.3	-9.0	PK	169	1.0	RB 1 MHz;VB 3 MHz;Peak

- Note: Scans made between 18 - 40 GHz with the measurement antenna moved around the card and its antennas 20-50cm from the device and emissions recorded in this frequency range were maximized at 3m.
- Note 1: For emissions in restricted bands, the limit of 15.209 was used which requires average and peak measurements.
- Note 2: For emissions outside of the restricted bands the limit is -27dBm/MHz eirp (68.3dBuV/m). The measurement method required is a peak measurement (RB=1MHz, VB≥3MHz, peak detector).

Client: Intel Corporation	Job Number: J94914
Model: 7265D2W	T-Log Number: T95472
	Project Manager: Christine Krebill
Contact: Steve Hackett	Project Coordinator: -
Standard: FCC Part 15.247, 15.407, RSS-210	Class: N/A

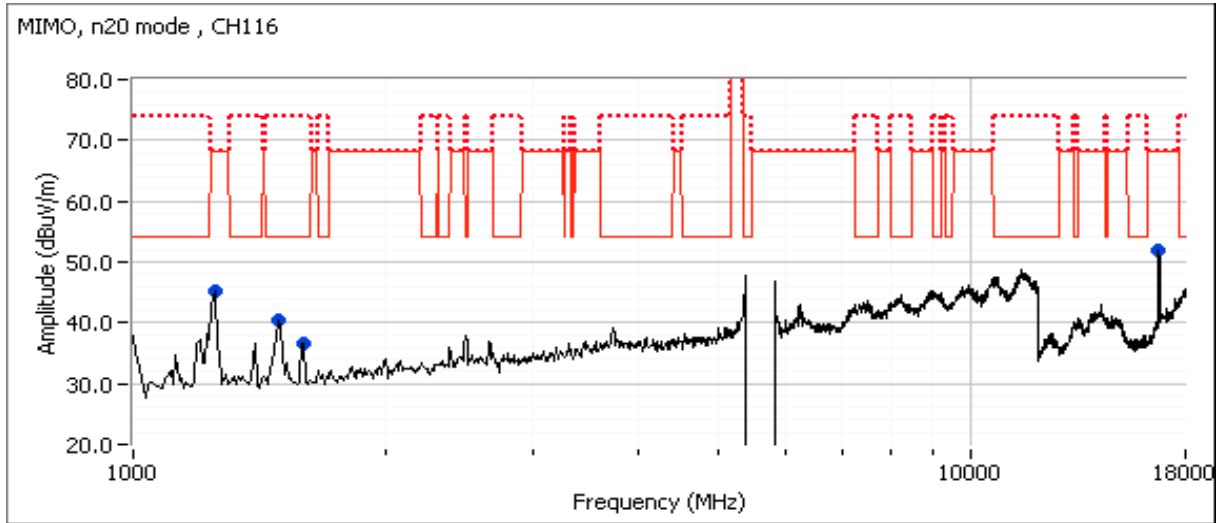



# EMC Test Data

Client: Intel Corporation	Job Number: J94914
Model: 7265D2W	T-Log Number: T95472
	Project Manager: Christine Krebill
Contact: Steve Hackett	Project Coordinator: -
Standard: FCC Part 15.247, 15.407, RSS-210	Class: N/A

## Run #5d: Center Channel

Channel: 110                      Mode: 11n40  
 Tx Chain: A+B                      Data Rate: 13.5Mbps

Chain	Power Settings								Software Setting
	Target (dBm)				Measured (dBm)				
	A	B	C	Total	A	B	C	Total	
	16.5	16.5		19.5	16.6	16.6		19.6	28.0 / 29.0

Frequency	Level	Pol	15.209 / 15E		Detector	Azimuth	Height	Comments
MHz	dB $\mu$ V/m	v/h	Limit	Margin	Pk/QP/Avg	degrees	meters	
22199.870	45.7	V	54.0	-8.3	AVG	120	1.0	Note 3
22199.780	55.0	V	74.0	-19.0	PK	120	1.0	RB 1 MHz;VB 3 MHz;Peak
1496.800	29.7	H	54.0	-24.3	AVG	43	1.5	RB 1 MHz;VB 10 Hz;Peak
1499.340	52.3	H	74.0	-21.7	PK	43	1.5	RB 1 MHz;VB 3 MHz;Peak
1593.800	31.0	V	54.0	-23.0	AVG	85	1.5	RB 1 MHz;VB 10 Hz;Peak
1593.140	45.6	V	74.0	-28.4	PK	85	1.5	RB 1 MHz;VB 3 MHz;Peak
1000.060	25.8	V	54.0	-28.2	AVG	33	1.5	RB 1 MHz;VB 10 Hz;Peak
1000.060	46.0	V	74.0	-28.0	PK	33	1.5	RB 1 MHz;VB 3 MHz;Peak
1246.940	53.2	V	68.3	-15.1	PK	128	1.2	RB 1 MHz;VB 3 MHz;Peak
16643.450	53.6	V	68.3	-14.7	PK	167	1.0	RB 1 MHz;VB 3 MHz;Peak

- Note: Scans made between 18 - 40 GHz with the measurement antenna moved around the card and its antennas 20-50cm from the device and emissions recorded in this frequency range were maximized at 3m.
- Note 1: For emissions in restricted bands, the limit of 15.209 was used which requires average and peak measurements.
- Note 2: For emissions outside of the restricted bands the limit is -27dBm/MHz eirp (68.3dBuV/m). The measurement method required is a peak measurement (RB=1MHz, VB≥3MHz, peak detector).

Client: Intel Corporation	Job Number: J94914
Model: 7265D2W	T-Log Number: T95472
	Project Manager: Christine Krebill
Contact: Steve Hackett	Project Coordinator: -
Standard: FCC Part 15.247, 15.407, RSS-210	Class: N/A

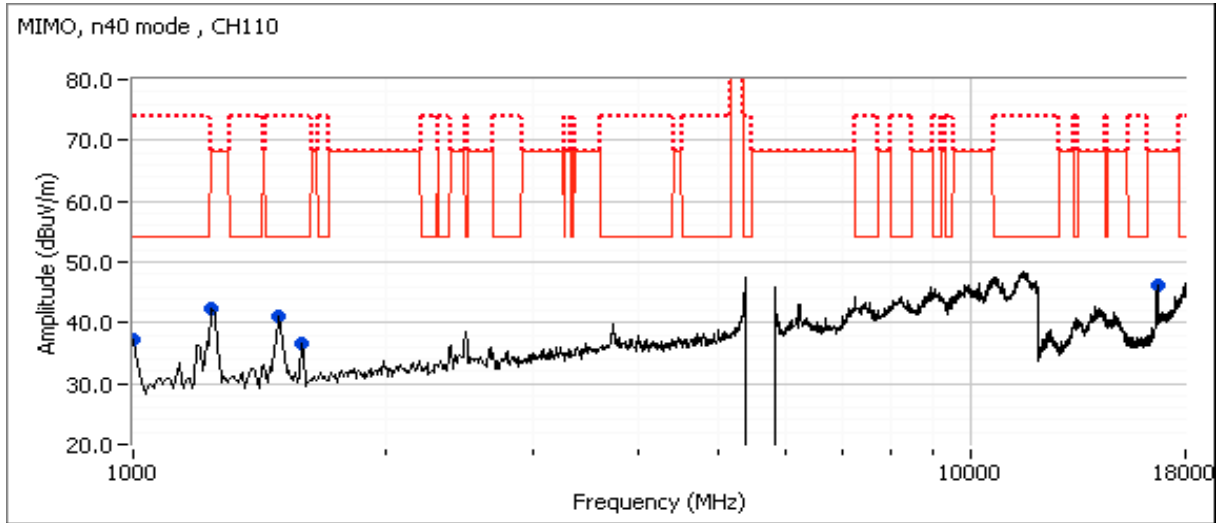



# EMC Test Data

Client:	Intel Corporation	Job Number:	J94914
Model:	7265D2W	T-Log Number:	T95472
Contact:	Steve Hackett	Project Manager:	Christine Krebill
Standard:	FCC Part 15.247, 15.407, RSS-210	Project Coordinator:	-
		Class:	N/A

Run #5e: Center Channel

Channel: 122                      Mode: ac80  
 Tx Chain: A+B                      Data Rate: 29.3Mbps

Chain	Power Settings								Software Setting
	Target (dBm)				Measured (dBm)				
	A	B	C	Total	A	B	C	Total	
	16.5	16.5		19.5	16.6	16.5		19.6	28.0 / 28.5

Frequency	Level	Pol	15.209 / 15E		Detector	Azimuth	Height	Comments
MHz	dB $\mu$ V/m	v/h	Limit	Margin	Pk/QP/Avg	degrees	meters	
22439.980	46.8	V	54.0	-7.2	AVG	130	1.5	Note 3
22439.530	55.7	V	74.0	-18.3	PK	130	1.5	RB 1 MHz;VB 3 MHz;Peak
1496.070	27.8	H	54.0	-26.2	AVG	45	1.3	RB 1 MHz;VB 10 Hz;Peak
1493.600	52.6	H	74.0	-21.4	PK	45	1.3	RB 1 MHz;VB 3 MHz;Peak
1594.730	30.6	V	54.0	-23.4	AVG	74	1.4	RB 1 MHz;VB 10 Hz;Peak
1597.730	45.3	V	74.0	-28.7	PK	74	1.4	RB 1 MHz;VB 3 MHz;Peak
1017.870	25.7	V	54.0	-28.3	AVG	193	1.7	RB 1 MHz;VB 10 Hz;Peak
1015.110	39.5	V	74.0	-34.5	PK	193	1.7	RB 1 MHz;VB 3 MHz;Peak
1248.070	49.8	V	68.3	-18.5	PK	181	1.0	RB 1 MHz;VB 3 MHz;Peak
16862.670	57.6	V	68.3	-10.7	PK	166	1.0	RB 1 MHz;VB 3 MHz;Peak

- Note: Scans made between 18 - 40 GHz with the measurement antenna moved around the card and its antennas 20-50cm from the device and emissions recorded in this frequency range were maximized at 3m.
- Note 1: For emissions in restricted bands, the limit of 15.209 was used which requires average and peak measurements.
- Note 2: For emissions outside of the restricted bands the limit is -27dBm/MHz eirp (68.3dBuV/m). The measurement method required is a peak measurement (RB=1MHz, VB≥3MHz, peak detector).

Client: Intel Corporation	Job Number: J94914
Model: 7265D2W	T-Log Number: T95472
	Project Manager: Christine Krebill
Contact: Steve Hackett	Project Coordinator: -
Standard: FCC Part 15.247, 15.407, RSS-210	Class: N/A

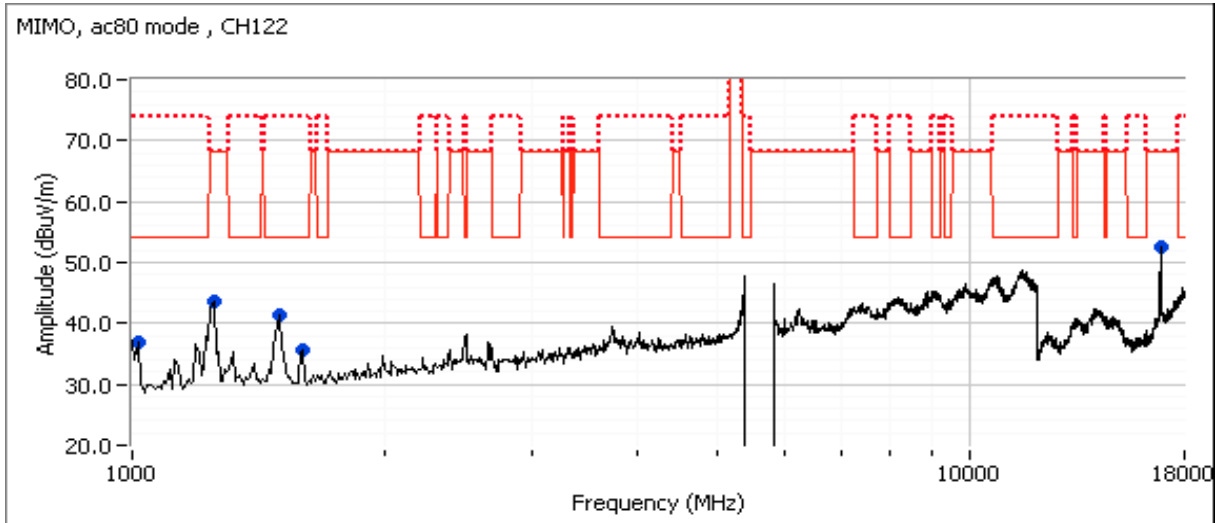



# EMC Test Data

Client: Intel Corporation	Job Number: J94914
Model: 7265D2W	T-Log Number: T95472
Contact: Steve Hackett	Project Manager: Christine Krebill
Standard: FCC Part 15.247, 15.407, RSS-210	Project Coordinator: -
	Class: N/A

Run #6: Radiated Spurious Emissions, 1,000 - 40000 MHz. Operating Mode: Worse case from Run #5

Date of Test: 6/16/2014 0:00  
 Test Engineer: Rafael Varelas  
 Test Location: FT Chamber4  
 Config. Used: 1  
 Config Change: None  
 EUT Voltage: 120V

Run #6a: Low Channel

Channel: 100 Mode: a  
 Tx Chain: B Data Rate: 6.0Mbps

Power Settings		
Target (dBm)	Measured (dBm)	Software Setting
13.5	13.7	23.5

Frequency MHz	Level dB $\mu$ V/m	Pol v/h	15.209 / 15.247		Detector Pk/QP/Avg	Azimuth degrees	Height meters	Comments
			Limit	Margin				
22799.480	44.5	V	54.0	-9.5	AVG	112	1.0	RB 1 MHz;VB 10 Hz;Peak
22805.000	56.3	V	74.0	-17.7	PK	112	1.0	RB 1 MHz;VB 3 MHz;Peak
16496.000	52.1	V	68.3	-16.2	PK	181	1.0	RB 1 MHz;VB 3 MHz;Peak
1249.770	47.4	H	68.3	-20.9	PK	202	1.0	RB 1 MHz;VB 3 MHz;Peak
1591.260	28.1	V	54.0	-25.9	AVG	72	1.5	RB 1 MHz;VB 10 Hz;Peak
1590.080	39.0	V	74.0	-35.0	PK	72	1.5	RB 1 MHz;VB 3 MHz;Peak

Note: Scans made between 18 - 40 GHz with the measurement antenna moved around the card and its antennas 20-50cm from the device and emissions recorded in this frequency range were maximized at 3m.

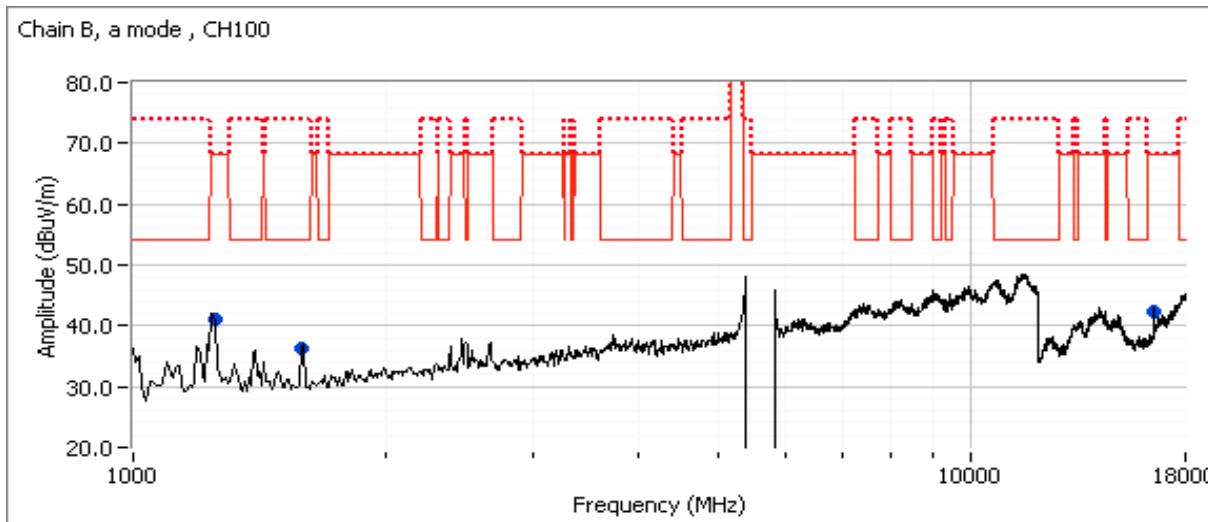



# EMC Test Data

Client: Intel Corporation	Job Number: J94914
Model: 7265D2W	T-Log Number: T95472
Contact: Steve Hackett	Project Manager: Christine Krebill
Standard: FCC Part 15.247, 15.407, RSS-210	Project Coordinator: -
	Class: N/A

## Run #6b: High Channel

Channel: 140      Mode: a  
 Tx Chain: B      Data Rate: 6.0Mbps

Power Settings		
Target (dBm)	Measured (dBm)	Software Setting
13.0	13.2	24.0

Frequency MHz	Level dB $\mu$ V/m	Pol v/h	15.209 / 15.247		Detector Pk/QP/Avg	Azimuth degrees	Height meters	Comments
			Limit	Margin				
22799.830	45.8	V	54.0	-8.2	AVG	132	1.0	RB 1 MHz;VB 10 Hz;Peak
22797.580	56.7	V	74.0	-17.3	PK	132	1.0	RB 1 MHz;VB 3 MHz;Peak
1245.870	47.1	H	68.3	-21.2	PK	199	0.9	RB 1 MHz;VB 3 MHz;Peak
1593.850	28.5	V	54.0	-25.5	AVG	56	1.8	RB 1 MHz;VB 10 Hz;Peak
1593.010	41.6	V	74.0	-32.4	PK	56	1.8	RB 1 MHz;VB 3 MHz;Peak
17100.330	53.3	H	68.3	-15.0	PK	252	1.0	RB 1 MHz;VB 3 MHz;Peak

Note: Scans made between 18 - 40 GHz with the measurement antenna moved around the card and its antennas 20-50cm from the device and emissions recorded in this frequency range were maximized at 3m.

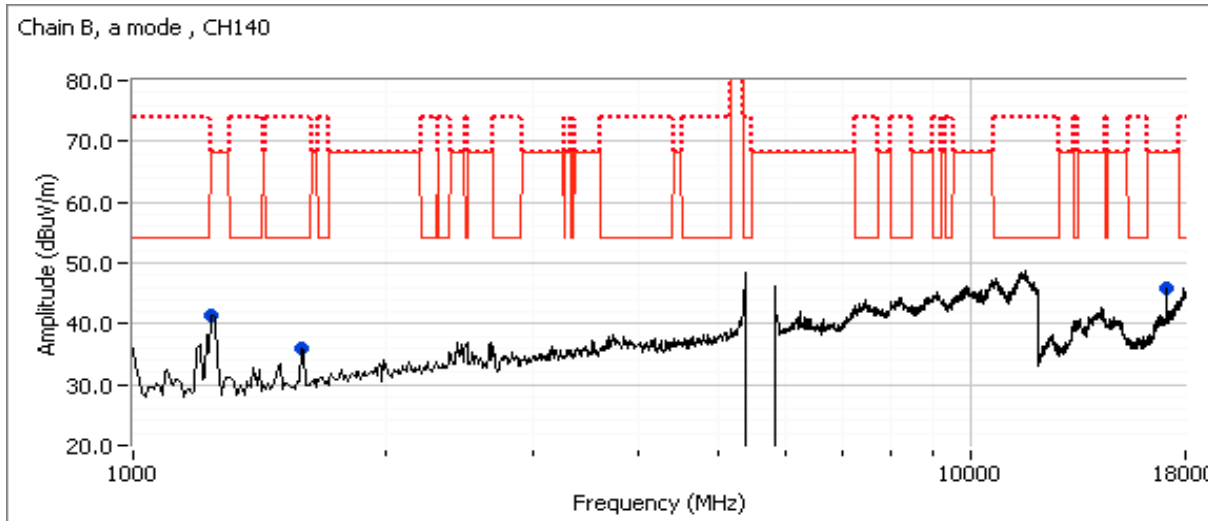





# EMC Test Data

Client: Intel Corporation	Job Number: J94914
Model: 7265D2W	T-Log Number: T95472
Contact: Steve Hackett	Project Manager: Christine Krebill
Standard: FCC Part 15.247, 15.407, RSS-210	Project Coordinator: -
	Class: N/A

## Run #6c: High Channel

Channel: 144                      Mode: ac20  
 Tx Chain: A+B                      Data Rate:

Chain	Power Settings								Software Setting
	Target (dBm)				Measured (dBm)				
	A	B	C	Total	A	B	C	Total	
	16.5	16.5		19.5	16.5	16.6		19.6	33.0, 34.0

Frequency	Level	Pol	15.209 / 15.247		Detector	Azimuth	Height	Comments
MHz	dB $\mu$ V/m	v/h	Limit	Margin	Pk/QP/Avg	degrees	meters	
22879.930	49.7	V	54.0	-4.3	AVG	95	1.4	RB 1 MHz;VB 10 Hz;Peak
22879.900	57.3	V	74.0	-16.7	PK	95	1.4	RB 1 MHz;VB 3 MHz;Peak
22879.970	46.2	H	54.0	-7.8	AVG	140	1.0	RB 1 MHz;VB 10 Hz;Peak
22879.800	56.0	H	74.0	-18.0	PK	140	1.0	RB 1 MHz;VB 3 MHz;Peak
1491.610	28.1	H	54.0	-25.9	AVG	107	1.0	RB 1 MHz;VB 10 Hz;Peak
1490.270	40.4	H	74.0	-33.6	PK	107	1.0	RB 1 MHz;VB 3 MHz;Peak
1244.710	48.0	V	68.3	-20.3	PK	52	1.4	RB 1 MHz;VB 3 MHz;Peak
17163.870	61.7	V	68.3	-6.6	PK	155	1.0	RB 1 MHz;VB 3 MHz;Peak

Note: Scans made between 18 - 40 GHz with the measurement antenna moved around the card and its antennas 20-50cm from the device and emissions recorded in this frequency range were maximized at 3m.

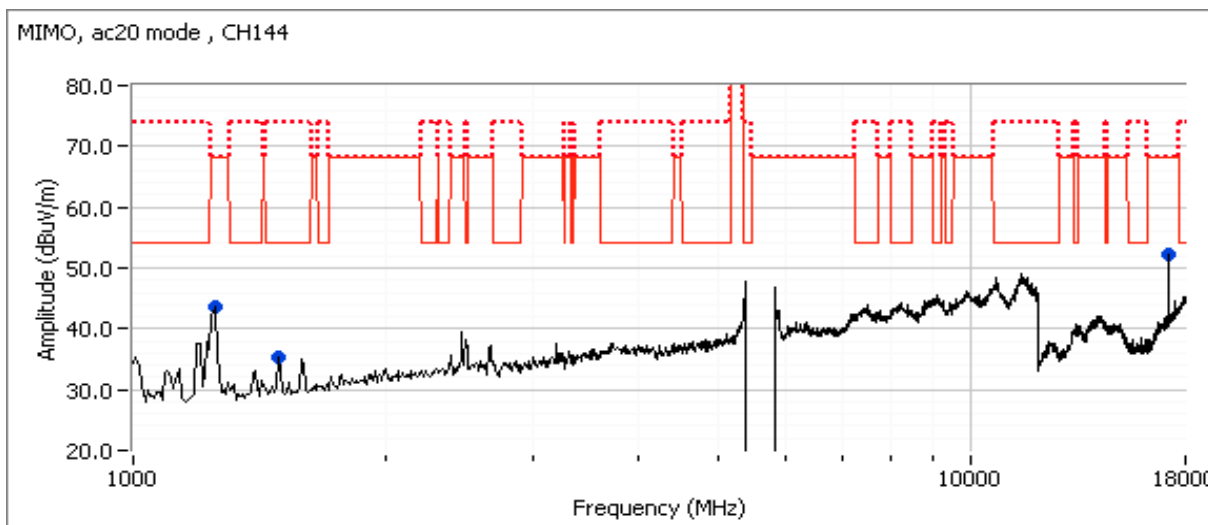



# EMC Test Data

Client:	Intel Corporation	Job Number:	J94914
Model:	7265D2W	T-Log Number:	T95472
		Project Manager:	Christine Krebill
Contact:	Steve Hackett	Project Coordinator:	-
Standard:	FCC Part 15.247, 15.407, RSS-210	Class:	N/A

## RSS 210 and FCC 15.247 (DTS) Radiated Spurious Emissions

### Test Specific Details

Objective: The objective of this test session is to perform final qualification testing of the EUT with respect to the specification listed above.

### General Test Configuration

The EUT and all local support equipment were located on the turntable for radiated spurious emissions testing. For radiated emissions testing the measurement antenna was located 3 meters from the EUT, unless otherwise noted.

### Ambient Conditions:

Temperature: 21.7 °C  
Rel. Humidity: 38 %

### Summary of Results - Device Operating in the 5725-5850 MHz Band

Run #	Mode	Channel	Power Setting	Measured Power	Test Performed	Limit	Result / Margin
1	a	149 - 5745MHz	30.0	16.7	Band Edge (5725 MHz)	FCC Part 15.407(b)(4)	69.6 dBµV/m @ 5723.8 MHz (-8.7 dB)
	a	165 - 5825MHz	30.0	16.6	Band Edge (5850 MHz)	FCC Part 15.407(b)(4)	65.4 dBµV/m @ 5863.3 MHz (-2.9 dB)
2	n20	149 - 5745MHz	31.0	16.7	Band Edge (5725 MHz)	FCC Part 15.407(b)(4)	73.1 dBµV/m @ 5724.2 MHz (-5.2 dB)
	n20	165 - 5825MHz	31.0	16.6	Band Edge (5850 MHz)	FCC Part 15.407(b)(4)	67.7 dBµV/m @ 5861.0 MHz (-0.6 dB)
3	n40	151 - 5755MHz	27.0	14.8	Band Edge (5725 MHz)	FCC Part 15.407(b)(4)	67.1 dBµV/m @ 5713.1 MHz (-1.2 dB)
	n40	159 - 5795MHz	30.5	16.7	Band Edge (5850 MHz)	FCC Part 15.407(b)(4)	66.5 dBµV/m @ 5860.5 MHz (-1.8 dB)
4	ac80	155 - 5775MHz	22.0	12.0	Band Edge (5725 MHz)	FCC Part 15.407(b)(4)	67.3 dBµV/m @ 5702.9 MHz (-1.0 dB)
			22.0	12.0	Band Edge (5850 MHz)	FCC Part 15.407(b)(4)	63.8 dBµV/m @ 5860.2 MHz (-4.5 dB)



# EMC Test Data

Client:	Intel Corporation	Job Number:	J94914
Model:	7265D2W	T-Log Number:	T95472
		Project Manager:	Christine Krebill
Contact:	Steve Hackett	Project Coordinator:	-
Standard:	FCC Part 15.247, 15.407, RSS-210	Class:	N/A

### Modifications Made During Testing

No modifications were made to the EUT during testing

### Deviations From The Standard

No deviations were made from the requirements of the standard.

Note - measured powers are average power measured with a power meter, for reference only.

### Sample Notes

MAC Address: 001500F15B3A DRTU Tool Version 1.7.3-935 Driver version 17.1.0.11

Antenna: Skycross WiMax/WLAN

### Procedure Comments:

Measurements performed in accordance with FCC KDB 558074

Peak measurements performed with: RBW=1MHz, VBW=3MHz, peak detector, max hold, auto sweep time

Unless otherwise stated/noted, emission has duty cycle  $\geq 98\%$  and was measured using RBW=1MHz, VBW=10Hz, peak detector, linear average mode, auto sweep time, max hold.

Mode	Data Rate	Duty Cycle (x)	Constant DC?	T (ms)	Pwr Cor Factor*	Lin Volt Cor Factor**	Min VBW for FS (Hz)
11a	6.0Mbps	99%	Constant	2.06	0.0	0.0	485
n20	6.5Mbps	98%	Constant	1.92	0.0	0.0	521
n40	13.5Mbps	97%	Constant	0.94	0.1	0.3	1064
ac80	29.3Mbps	94%	Constant	0.44	0.3	0.6	2273

### Measurement Specific Notes:

Note 1:	For emissions outside of the restricted bands the limit is -27dBm/MHz eirp (68.3dBuV/m) (or -17dBm/MHz eirp (78.3dBuV/m)). The measurement method required is a peak measurement (RB=1MHz, VB $\geq$ 3MHz, peak detector). Per KDB 789033 D02 G) 2) (c), compliance can be demonstrated by meeting the average and peak limits of 15.209, as an alternative.
---------	--



# EMC Test Data

Client: Intel Corporation	Job Number: J94914
Model: 7265D2W	T-Log Number: T95472
Contact: Steve Hackett	Project Manager: Christine Krebill
Standard: FCC Part 15.247, 15.407, RSS-210	Project Coordinator: -
	Class: N/A

## Run #1: Radiated Bandedge Measurements

Date of Test: 6/11/2014 0:00  
 Test Engineer: Rafael Varelas  
 Test Location: FT Chamber #5

Config. Used: 1  
 Config Change: None  
 EUT Voltage: 120V

Channel: 149 Mode: a  
 Tx Chain: A Data Rate: 6.0Mbps

Power Settings		
Target (dBm)	Measured (dBm)	Software Setting
16.5	16.7	30.0

## 5715 MHz - Band Edge Signal Field Strength - Direct measurement of field strength

Frequency MHz	Level dB $\mu$ V/m	Pol v/h	15.407(b)(4)		Detector Pk/QP/Avg	Azimuth degrees	Height meters	Comments
			Limit	Margin				
5711.750	59.1	H	68.3	-9.2	PK	29	1.0	POS; RB 1 MHz; VB: 3 MHz
5713.620	58.7	V	68.3	-9.6	PK	188	1.0	POS; RB 1 MHz; VB: 3 MHz

## 5725 MHz - Band Edge Signal Field Strength - Direct measurement of field strength

Frequency MHz	Level dB $\mu$ V/m	Pol v/h	15.407(b)(4)		Detector Pk/QP/Avg	Azimuth degrees	Height meters	Comments
			Limit	Margin				
5723.820	69.6	H	78.3	-8.7	PK	29	1.0	POS; RB 1 MHz; VB: 3 MHz
5723.440	69.1	V	78.3	-9.2	PK	188	1.0	POS; RB 1 MHz; VB: 3 MHz

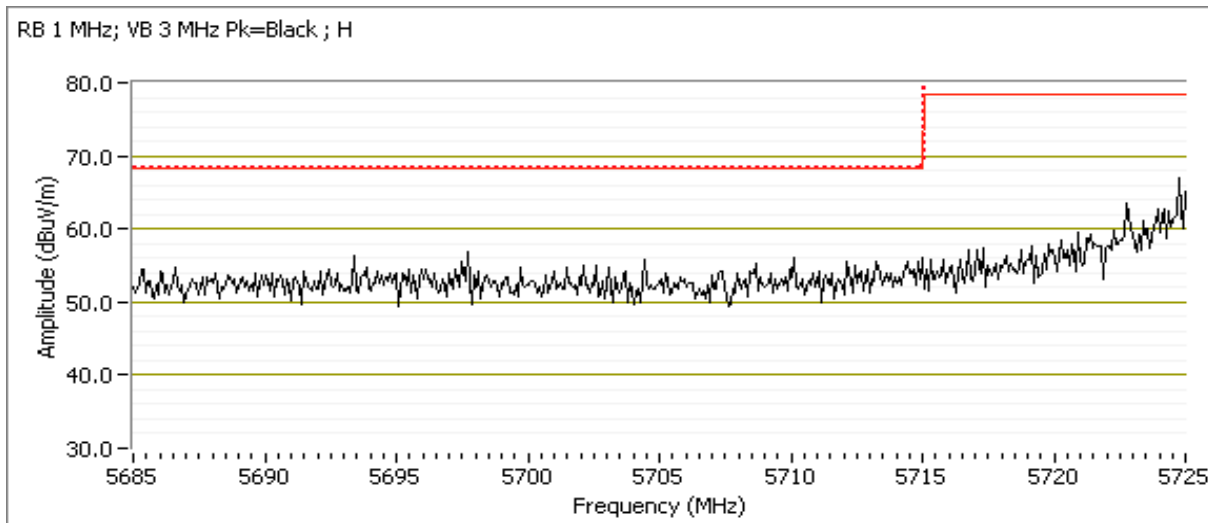



# EMC Test Data

Client: Intel Corporation	Job Number: J94914
Model: 7265D2W	T-Log Number: T95472
Contact: Steve Hackett	Project Manager: Christine Krebill
Standard: FCC Part 15.247, 15.407, RSS-210	Project Coordinator: -
	Class: N/A

Channel: 165                      Mode: a  
 Tx Chain: A                      Data Rate: 6.0Mbps

Power Settings		
Target (dBm)	Measured (dBm)	Software Setting
16.5	16.6	30.0

### 5850 MHz- Band Edge Signal Field Strength - Direct measurement of field strength

Frequency	Level	Pol	15.407(b)(4)		Detector	Azimuth	Height	Comments
MHz	dB $\mu$ V/m	v/h	Limit	Margin	Pk/QP/Avg	degrees	meters	
5850.680	70.6	H	78.3	-7.7	PK	257	1.3	POS; RB 1 MHz; VB: 3 MHz
5850.580	71.4	V	78.3	-6.9	PK	202	1.1	POS; RB 1 MHz; VB: 3 MHz

### 5860 MHz- Band Edge Signal Field Strength - Direct measurement of field strength

Frequency	Level	Pol	15.407(b)(4)		Detector	Azimuth	Height	Comments
MHz	dB $\mu$ V/m	v/h	Limit	Margin	Pk/QP/Avg	degrees	meters	
5863.310	65.4	H	68.3	-2.9	Pk	257	1.3	POS; RB 1 MHz; VB: 3 MHz
5860.000	63.9	V	68.3	-4.4	Pk	202	1.1	POS; RB 1 MHz; VB: 3 MHz

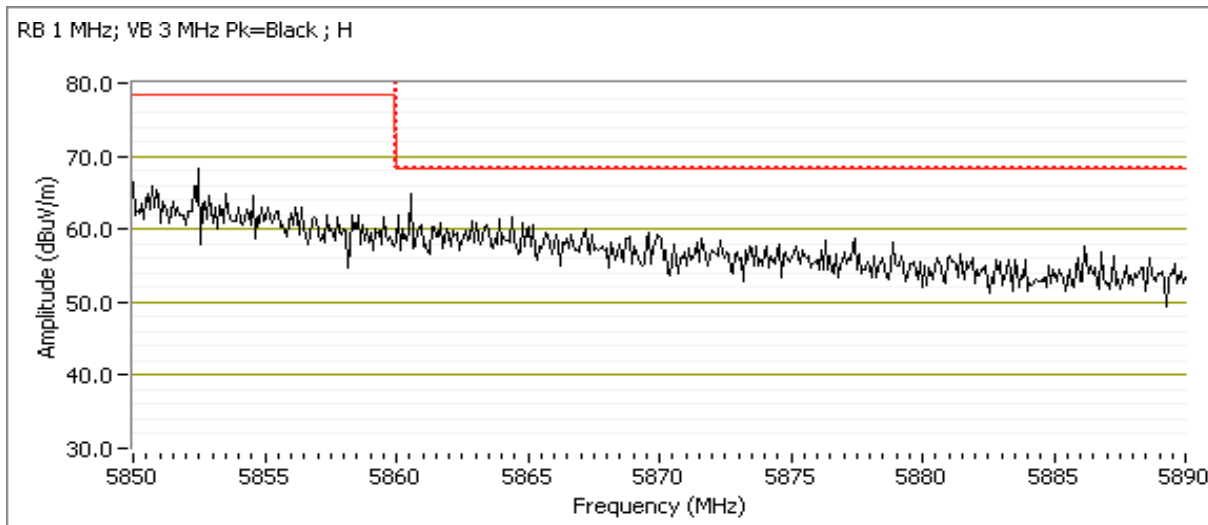



# EMC Test Data

Client: Intel Corporation	Job Number: J94914
Model: 7265D2W	T-Log Number: T95472
Contact: Steve Hackett	Project Manager: Christine Krebill
Standard: FCC Part 15.247, 15.407, RSS-210	Project Coordinator: -
	Class: N/A

### Run #2: Radiated Bandedge Measurements

Date of Test: 6/11/2014 0:00  
 Test Engineer: Rafael Varelas  
 Test Location: FT Chamber #5

Config. Used: 1  
 Config Change: None  
 EUT Voltage: 120V

Channel: 149 Mode: n20  
 Tx Chain: A Data Rate: 6.5Mbps

Power Settings		
Target (dBm)	Measured (dBm)	Software Setting
16.5	16.7	31.0

### 5715 MHz - Band Edge Signal Field Strength - Direct measurement of field strength

Frequency MHz	Level dB $\mu$ V/m	Pol v/h	15.407(b)(4)		Detector Pk/QP/Avg	Azimuth degrees	Height meters	Comments
			Limit	Margin				
5713.920	59.5	H	68.3	-8.8	PK	29	1.0	POS; RB 1 MHz; VB: 3 MHz
5713.260	62.7	V	68.3	-5.6	PK	188	1.0	POS; RB 1 MHz; VB: 3 MHz

### 5725 MHz - Band Edge Signal Field Strength - Direct measurement of field strength

Frequency MHz	Level dB $\mu$ V/m	Pol v/h	15.407(b)(4)		Detector Pk/QP/Avg	Azimuth degrees	Height meters	Comments
			Limit	Margin				
5724.800	71.4	H	78.3	-6.9	Pk	29	1.0	POS; RB 1 MHz; VB: 3 MHz
5724.180	73.1	V	78.3	-5.2	Pk	188	1.0	POS; RB 1 MHz; VB: 3 MHz

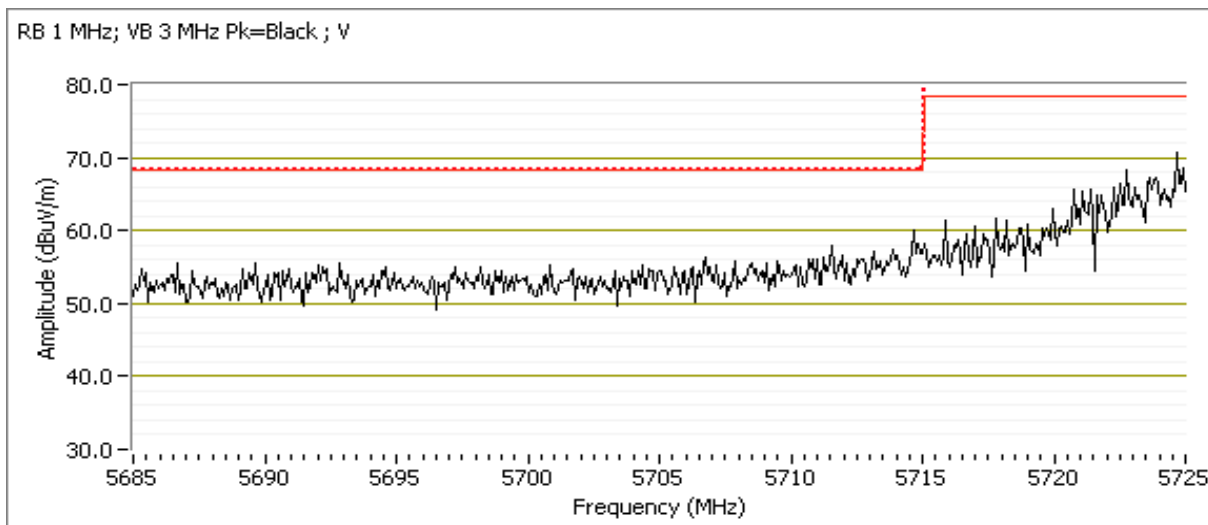



# EMC Test Data

Client: Intel Corporation	Job Number: J94914
Model: 7265D2W	T-Log Number: T95472
Contact: Steve Hackett	Project Manager: Christine Krebill
Standard: FCC Part 15.247, 15.407, RSS-210	Project Coordinator: -
	Class: N/A

Channel: 165      Mode: n20  
 Tx Chain: A      Data Rate: 6.5Mbps

Power Settings		
Target (dBm)	Measured (dBm)	Software Setting
16.5	16.6	31.0

### 5850 MHz- Band Edge Signal Field Strength - Direct measurement of field strength

Frequency	Level	Pol	15.407(b)(4)		Detector	Azimuth	Height	Comments
MHz	dB $\mu$ V/m	v/h	Limit	Margin	Pk/QP/Avg	degrees	meters	
5852.480	72.8	H	78.3	-5.5	Pk	259	1.3	POS; RB 1 MHz; VB: 3 MHz
5851.000	72.7	V	78.3	-5.6	Pk	200	1.0	POS; RB 1 MHz; VB: 3 MHz

### 5860 MHz- Band Edge Signal Field Strength - Direct measurement of field strength

Frequency	Level	Pol	15.407(b)(4)		Detector	Azimuth	Height	Comments
MHz	dB $\mu$ V/m	v/h	Limit	Margin	Pk/QP/Avg	degrees	meters	
5860.600	67.2	H	68.3	-1.1	Pk	259	1.3	POS; RB 1 MHz; VB: 3 MHz
5860.960	67.7	V	68.3	-0.6	Pk	200	1.0	POS; RB 1 MHz; VB: 3 MHz

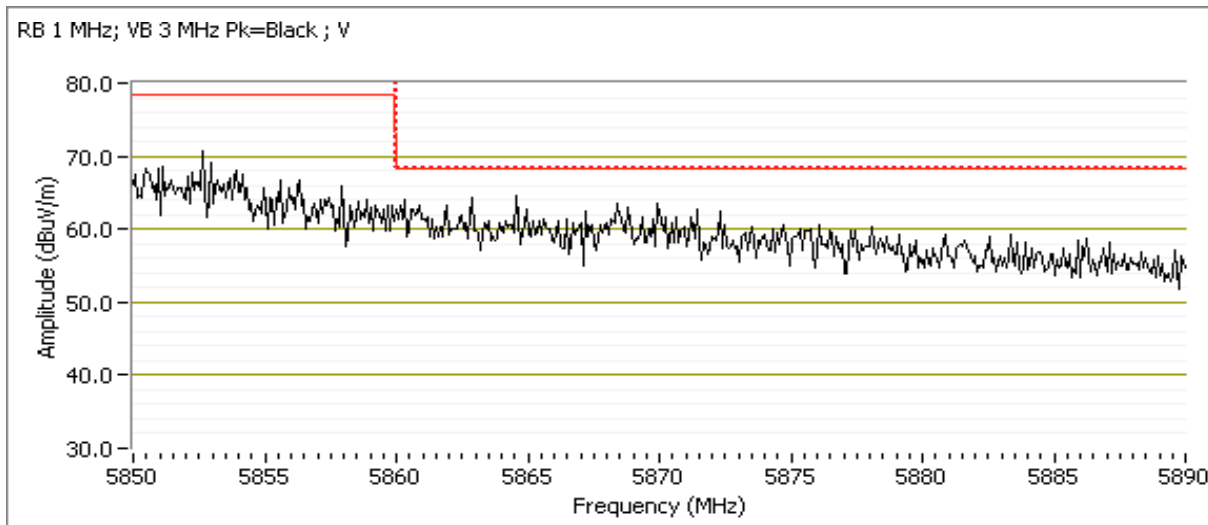



# EMC Test Data

Client: Intel Corporation	Job Number: J94914
Model: 7265D2W	T-Log Number: T95472
	Project Manager: Christine Krebill
Contact: Steve Hackett	Project Coordinator: -
Standard: FCC Part 15.247, 15.407, RSS-210	Class: N/A

### Run #3: Radiated Bandedge Measurements

Date of Test: 6/11/2014 0:00  
 Test Engineer: Rafael Varelas  
 Test Location: FT Chamber #5

Config. Used: 1  
 Config Change: None  
 EUT Voltage: 120V

Channel: 151 Mode: n40  
 Tx Chain: A Data Rate: 13.5Mbps

Power Settings		
Target (dBm)	Measured (dBm)	Software Setting
16.5	14.8	27.0

### 5715 MHz - Band Edge Signal Field Strength - Direct measurement of field strength

Frequency MHz	Level dB $\mu$ V/m	Pol v/h	15.407(b)(4)		Detector Pk/QP/Avg	Azimuth degrees	Height meters	Comments
			Limit	Margin				
5713.140	67.1	V	68.3	-1.2	Pk	196	1.0	setting 27.0
5713.920	64.3	H	68.3	-4.0	Pk	27	1.0	setting 27.0

### 5725 MHz - Band Edge Signal Field Strength - Direct measurement of field strength

Frequency MHz	Level dB $\mu$ V/m	Pol v/h	15.407(b)(4)		Detector Pk/QP/Avg	Azimuth degrees	Height meters	Comments
			Limit	Margin				
5719.470	70.3	V	78.3	-8.0	Pk	30	1.0	setting 27.0
5724.720	67.9	H	78.3	-10.4	Pk	27	1.0	setting 27.0

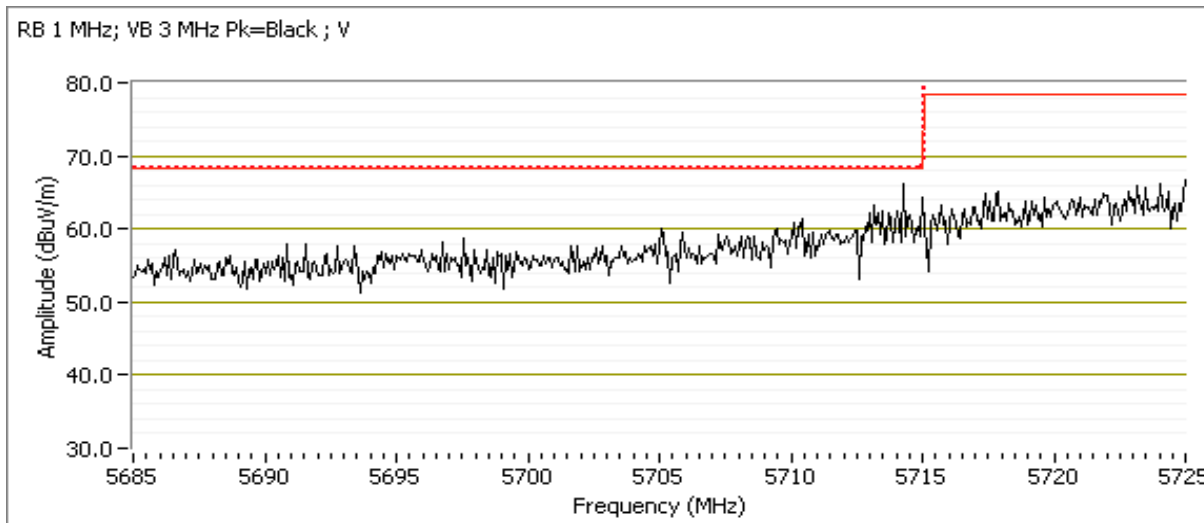





# EMC Test Data

Client: Intel Corporation	Job Number: J94914
Model: 7265D2W	T-Log Number: T95472
Contact: Steve Hackett	Project Manager: Christine Krebill
Standard: FCC Part 15.247, 15.407, RSS-210	Project Coordinator: -
	Class: N/A

Channel: 159 Mode: n40  
 Tx Chain: A Data Rate: 13.5Mbps

Power Settings		
Target (dBm)	Measured (dBm)	Software Setting
16.5	16.7	30.5

### 5850 MHz- Band Edge Signal Field Strength - Direct measurement of field strength

Frequency	Level	Pol	15.407(b)(4)		Detector	Azimuth	Height	Comments
MHz	dB $\mu$ V/m	v/h	Limit	Margin	Pk/QP/Avg	degrees	meters	
5850.040	70.6	V	78.3	-7.7	Pk	199	1.0	POS; RB 1 MHz; VB: 3 MHz
5850.180	69.7	H	78.3	-8.6	Pk	255	1.3	POS; RB 1 MHz; VB: 3 MHz

### 5860 MHz- Band Edge Signal Field Strength - Direct measurement of field strength

Frequency	Level	Pol	15.407(b)(4)		Detector	Azimuth	Height	Comments
MHz	dB $\mu$ V/m	v/h	Limit	Margin	Pk/QP/Avg	degrees	meters	
5860.480	66.5	V	68.3	-1.8	Pk	199	1.0	POS; RB 1 MHz; VB: 3 MHz
5860.960	65.4	H	68.3	-2.9	PK	255	1.3	POS; RB 1 MHz; VB: 3 MHz

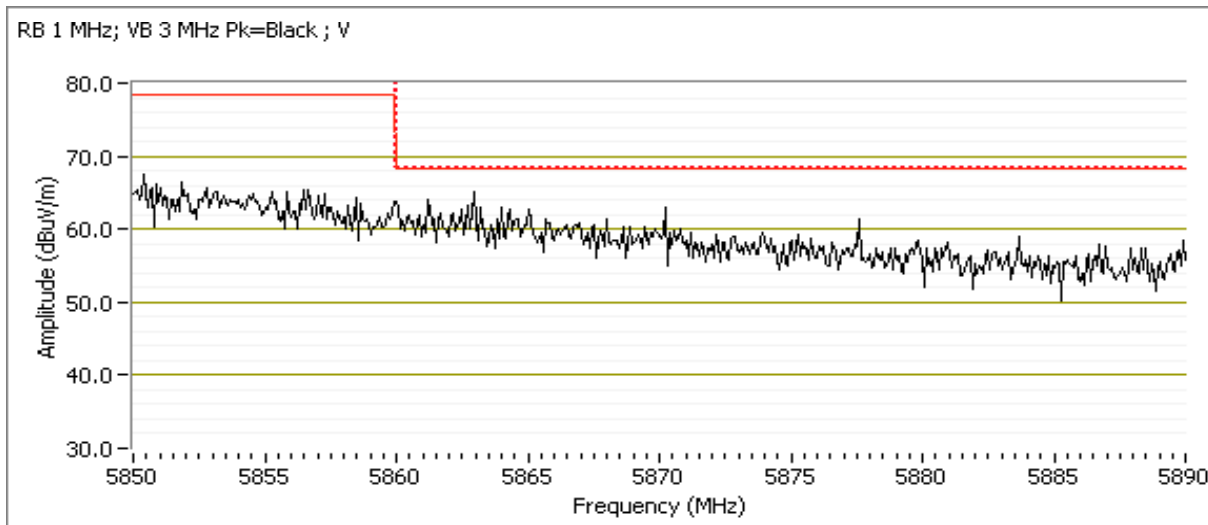



# EMC Test Data

Client: Intel Corporation	Job Number: J94914
Model: 7265D2W	T-Log Number: T95472
Contact: Steve Hackett	Project Manager: Christine Krebill
Standard: FCC Part 15.247, 15.407, RSS-210	Project Coordinator: -
	Class: N/A

### Run #4: Radiated Bandedge Measurements

Date of Test: 6/11/2014 0:00  
 Test Engineer: Rafael Varelas  
 Test Location: FT Chamber #5

Config. Used: 1  
 Config Change: None  
 EUT Voltage: 120V

Channel: 155 Mode: ac80  
 Tx Chain: A Data Rate: 29.3Mbps

Power Settings		
Target (dBm)	Measured (dBm)	Software Setting
16.5	12.0	22.0

Pass

### 5715 MHz - Band Edge Signal Field Strength - Direct measurement of field strength

Frequency	Level	Pol	15.407(b)(4)		Detector	Azimuth	Height	Comments
MHz	dB $\mu$ V/m	v/h	Limit	Margin	Pk/QP/Avg	degrees	meters	
5702.880	67.3	V	68.3	-1.0	Pk	112	1.0	POS; RB 1 MHz; VB: 3 MHz
5708.390	66.0	H	68.3	-2.3	Pk	227	1.0	POS; RB 1 MHz; VB: 3 MHz

### 5725 MHz - Band Edge Signal Field Strength - Direct measurement of field strength

Frequency	Level	Pol	15.407(b)(4)		Detector	Azimuth	Height	Comments
MHz	dB $\mu$ V/m	v/h	Limit	Margin	Pk/QP/Avg	degrees	meters	
5715.660	66.9	V	78.3	-11.4	Pk	112	1.0	POS; RB 1 MHz; VB: 3 MHz
5716.020	65.2	H	78.3	-13.1	Pk	227	1.0	POS; RB 1 MHz; VB: 3 MHz

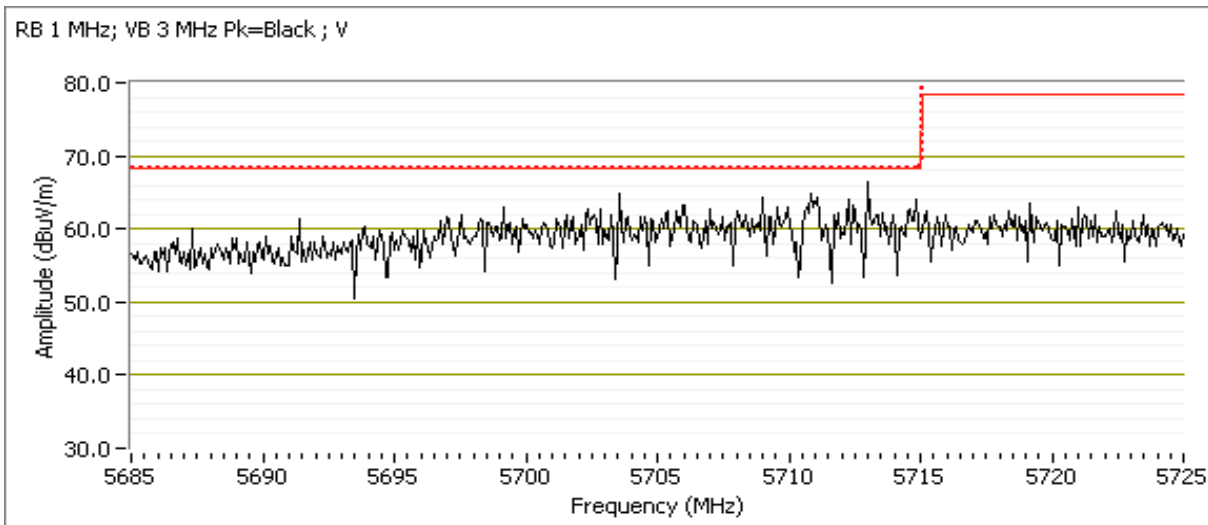



# EMC Test Data

Client: Intel Corporation	Job Number: J94914
Model: 7265D2W	T-Log Number: T95472
Contact: Steve Hackett	Project Manager: Christine Krebill
Standard: FCC Part 15.247, 15.407, RSS-210	Project Coordinator: -
	Class: N/A

## 5850 MHz- Band Edge Signal Field Strength - Direct measurement of field strength

Frequency MHz	Level dB $\mu$ V/m	Pol v/h	15.407(b)(4)		Detector Pk/QP/Avg	Azimuth degrees	Height meters	Comments
			Limit	Margin				
5850.900	67.0	V	78.3	-11.3	Pk	207	1.1	POS; RB 1 MHz; VB: 3 MHz
5850.100	64.4	H	78.3	-13.9	Pk	0	1.0	POS; RB 1 MHz; VB: 3 MHz

## 5860 MHz- Band Edge Signal Field Strength - Direct measurement of field strength

Frequency MHz	Level dB $\mu$ V/m	Pol v/h	15.407(b)(4)		Detector Pk/QP/Avg	Azimuth degrees	Height meters	Comments
			Limit	Margin				
5860.240	63.8	V	68.3	-4.5	Pk	207	1.1	POS; RB 1 MHz; VB: 3 MHz
5862.890	61.7	H	68.3	-6.6	Pk	0	1.0	POS; RB 1 MHz; VB: 3 MHz

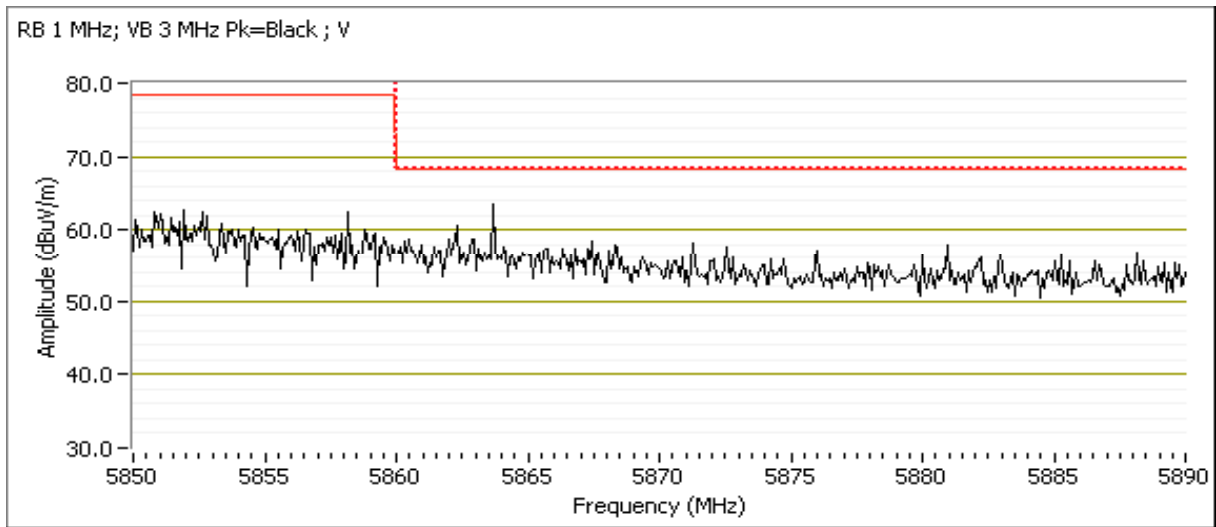



# EMC Test Data

Client:	Intel Corporation	Job Number:	J94914
Model:	7265D2W	T-Log Number:	T95472
Contact:	Steve Hackett	Project Manager:	Christine Krebill
Standard:	FCC Part 15.247, 15.407, RSS-210	Project Coordinator:	-
		Class:	N/A

## RSS 210 and FCC 15.247 (DTS) Radiated Spurious Emissions

### Test Specific Details

Objective: The objective of this test session is to perform final qualification testing of the EUT with respect to the specification listed above.

### General Test Configuration

The EUT and all local support equipment were located on the turntable for radiated spurious emissions testing. For radiated emissions testing the measurement antenna was located 3 meters from the EUT, unless otherwise noted.

### Ambient Conditions:

Temperature: 20.9 °C  
Rel. Humidity: 39 %

### Summary of Results - Device Operating in the 5725-5850 MHz Band

Run #	Mode	Channel	Power Setting	Measured Power	Test Performed	Limit	Result / Margin
1	a	149 - 5745MHz	32.0	16.6	Band Edge (5725 MHz)	FCC Part 15.407(b)(4)	76.9 dBµV/m @ 5725.0 MHz (-1.4 dB)
	a	165 - 5825MHz	32.5	16.7	Band Edge (5850 MHz)	FCC Part 15.407(b)(4)	58.9 dBµV/m @ 5860.2 MHz (-9.4 dB)
2	n20	149 - 5745MHz	32.0	16.5	Band Edge (5725 MHz)	FCC Part 15.407(b)(4)	77.4 dBµV/m @ 5724.4 MHz (-0.9 dB)
	n20	165 - 5825MHz	32.5	16.6	Band Edge (5850 MHz)	FCC Part 15.407(b)(4)	59.8 dBµV/m @ 5861.2 MHz (-8.5 dB)
3	n40	151 - 5755MHz	27.0	14.1	Band Edge (5725 MHz)	FCC Part 15.407(b)(4)	67.4 dBµV/m @ 5714.2 MHz (-0.9 dB)
	n40	159 - 5795MHz	31.5	15.4	Band Edge (5850 MHz)	FCC Part 15.407(b)(4)	67.4 dBµV/m @ 5862.6 MHz (-0.9 dB)
4	ac80	155 - 5775MHz	22.5	11.3	Band Edge (5725 MHz)	FCC Part 15.407(b)(4)	67.4 dBµV/m @ 5707.6 MHz (-0.9 dB)
			22.5	11.3	Band Edge (5850 MHz)	FCC Part 15.407(b)(4)	61.0 dBµV/m @ 5862.7 MHz (-7.3 dB)



## EMC Test Data

Client:	Intel Corporation	Job Number:	J94914
Model:	7265D2W	T-Log Number:	T95472
		Project Manager:	Christine Krebill
Contact:	Steve Hackett	Project Coordinator:	-
Standard:	FCC Part 15.247, 15.407, RSS-210	Class:	N/A

### Modifications Made During Testing

No modifications were made to the EUT during testing

### Deviations From The Standard

No deviations were made from the requirements of the standard.

Note - measured powers are average power measured with a power meter, for reference only.

### Sample Notes

a and n20

MAC Address: 001500F15B5D DRTU Tool Version 1.7.3-935 Driver version 17.1.0.11

n40 and ac80

MAC Address: 001500F15B3A DRTU Tool Version 1.7.3-935 Driver version 17.1.0.11

Antenna: Skycross WiMax/WLAN



# EMC Test Data

Client:	Intel Corporation	Job Number:	J94914
Model:	7265D2W	T-Log Number:	T95472
		Project Manager:	Christine Krebill
Contact:	Steve Hackett	Project Coordinator:	-
Standard:	FCC Part 15.247, 15.407, RSS-210	Class:	N/A

## Procedure Comments:

Measurements performed in accordance with FCC KDB 558074

Peak measurements performed with: RBW=1MHz, VBW=3MHz, peak detector, max hold, auto sweep time

Unless otherwise stated/noted, emission has duty cycle  $\geq 98\%$  and was measured using RBW=1MHz, VBW=10Hz, peak detector, linear average mode, auto sweep time, max hold.

Mode	Data Rate	Duty Cycle (x)	Constant DC?	T (ms)	Pwr Cor Factor*	Lin Volt Cor Factor**	Min VBW for FS (Hz)
11a	6.0Mbps	99%	Constant	2.06	0.0	0.0	485
n20	6.5Mbps	98%	Constant	1.92	0.0	0.0	521
n40	13.5Mbps	97%	Constant	0.94	0.1	0.3	1064
ac80	29.3Mbps	94%	Constant	0.44	0.3	0.6	2273

## Measurement Specific Notes:

Note 1:	For emissions outside of the restricted bands the limit is -27dBm/MHz eirp (68.3dBuV/m) (or -17dBm/MHz eirp (78.3dBuV/m)). The measurement method required is a peak measurement (RB=1MHz, VB $\geq$ 3MHz, peak detector). Per KDB 789033 D02 G) 2) (c), compliance can be demonstrated by meeting the average and peak limits of 15.209, as an alternative.
---------	--



# EMC Test Data

Client: Intel Corporation	Job Number: J94914
Model: 7265D2W	T-Log Number: T95472
Contact: Steve Hackett	Project Manager: Christine Krebill
Standard: FCC Part 15.247, 15.407, RSS-210	Project Coordinator: -
	Class: N/A

### Run #1: Radiated Bandedge Measurements

Date of Test: 6/25/2014 0:00  
 Test Engineer: Rafael Varelas  
 Test Location: FT Chamber #5

Config. Used: 1  
 Config Change: None  
 EUT Voltage: 120V

Channel: 149 Mode: a  
 Tx Chain: B Data Rate: 6.0Mbps

Power Settings		
Target (dBm)	Measured (dBm)	Software Setting
16.5	16.6	32.0

### 5715 MHz - Band Edge Signal Field Strength - Direct measurement of field strength

Frequency	Level	Pol	15.407(b)(4)		Detector	Azimuth	Height	Comments
MHz	dB $\mu$ V/m	v/h	Limit	Margin	PK/QP/Avg	degrees	meters	
5713.800	59.0	V	68.3	-9.3	PK	152	1.0	POS; RB 1 MHz; VB: 3 MHz
5714.520	61.4	H	68.3	-6.9	PK	92	1.3	POS; RB 1 MHz; VB: 3 MHz

### 5725 MHz - Band Edge Signal Field Strength - Direct measurement of field strength

Frequency	Level	Pol	15.407(b)(4)		Detector	Azimuth	Height	Comments
MHz	dB $\mu$ V/m	v/h	Limit	Margin	PK/QP/Avg	degrees	meters	
5724.980	76.9	H	78.3	-1.4	PK	92	1.3	POS; RB 1 MHz; VB: 3 MHz
5724.280	74.4	V	78.3	-3.9	PK	152	1.0	POS; RB 1 MHz; VB: 3 MHz

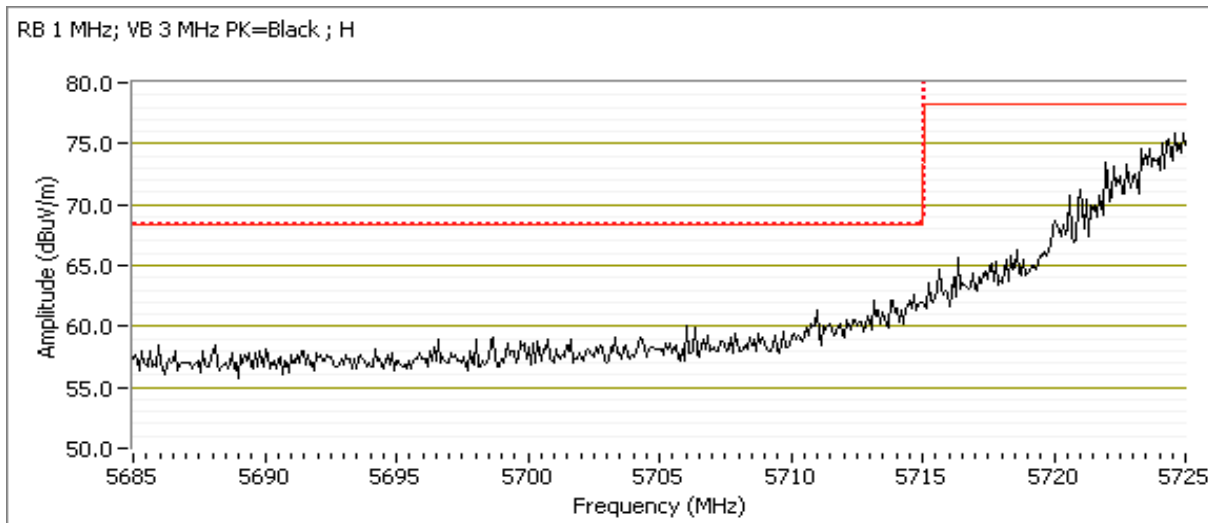



# EMC Test Data

Client: Intel Corporation	Job Number: J94914
Model: 7265D2W	T-Log Number: T95472
Contact: Steve Hackett	Project Manager: Christine Krebill
Standard: FCC Part 15.247, 15.407, RSS-210	Project Coordinator: -
	Class: N/A

Date of Test: 6/25/2014 0:00  
 Test Engineer: Rafael Varelas  
 Test Location: FT Chamber #5

Config. Used: 1  
 Config Change: None  
 EUT Voltage: 120V

Channel: 165 Mode: a  
 Tx Chain: B Data Rate: 6.0Mbps

Power Settings		
Target (dBm)	Measured (dBm)	Software Setting
16.5	16.7	32.5

### 5850 MHz- Band Edge Signal Field Strength - Direct measurement of field strength

Frequency MHz	Level dB $\mu$ V/m	Pol v/h	15.407(b)(4)		Detector Pk/QP/Avg	Azimuth degrees	Height meters	Comments
			Limit	Margin				
5850.560	63.1	H	78.3	-15.2	PK	99	1.2	POS; RB 1 MHz; VB: 3 MHz
5852.220	63.1	V	78.3	-15.2	PK	179	1.0	POS; RB 1 MHz; VB: 3 MHz

### 5860 MHz- Band Edge Signal Field Strength - Direct measurement of field strength

Frequency MHz	Level dB $\mu$ V/m	Pol v/h	15.407(b)(4)		Detector Pk/QP/Avg	Azimuth degrees	Height meters	Comments
			Limit	Margin				
5860.180	58.9	H	68.3	-9.4	PK	99	1.2	POS; RB 1 MHz; VB: 3 MHz
5861.860	58.7	V	68.3	-9.6	PK	179	1.0	POS; RB 1 MHz; VB: 3 MHz

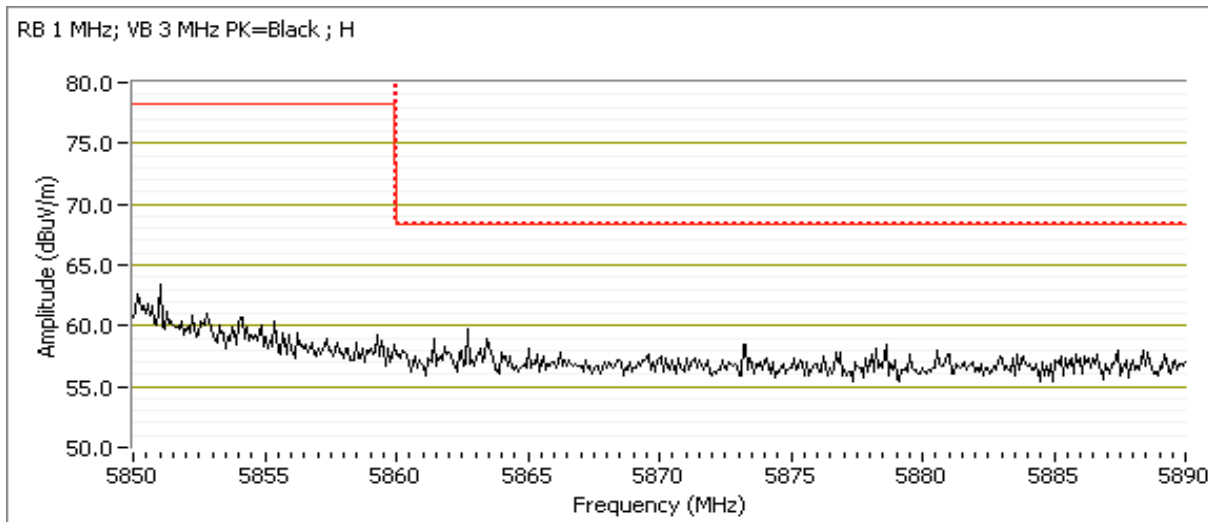

Run #2: Radiated Bandedge Measurements





# EMC Test Data

Client: Intel Corporation	Job Number: J94914
Model: 7265D2W	T-Log Number: T95472
Contact: Steve Hackett	Project Manager: Christine Krebill
Standard: FCC Part 15.247, 15.407, RSS-210	Project Coordinator: -
	Class: N/A

Date of Test: 6/25/2014 0:00      Config. Used: 1  
 Test Engineer: Rafael Varelas      Config Change: None  
 Test Location: FT Chamber #5      EUT Voltage: 120V

Channel: 149      Mode: n20  
 Tx Chain: B      Data Rate: 6.5Mbps

Power Settings		
Target (dBm)	Measured (dBm)	Software Setting
16.5	16.5	32.0

### 5715 MHz - Band Edge Signal Field Strength - Direct measurement of field strength

Frequency	Level	Pol	15.407(b)(4)		Detector	Azimuth	Height	Comments
MHz	dB $\mu$ V/m	v/h	Limit	Margin	PK/QP/Avg	degrees	meters	
5712.290	66.1	H	68.3	-2.2	PK	94	1.3	POS; RB 1 MHz; VB: 3 MHz
5714.100	63.2	V	68.3	-5.1	PK	168	1.0	POS; RB 1 MHz; VB: 3 MHz

### 5725 MHz - Band Edge Signal Field Strength - Direct measurement of field strength

Frequency	Level	Pol	15.407(b)(4)		Detector	Azimuth	Height	Comments
MHz	dB $\mu$ V/m	v/h	Limit	Margin	PK/QP/Avg	degrees	meters	
5724.380	77.4	H	78.3	-0.9	PK	94	1.3	POS; RB 1 MHz; VB: 3 MHz
5724.460	76.0	V	78.3	-2.3	PK	168	1.0	POS; RB 1 MHz; VB: 3 MHz

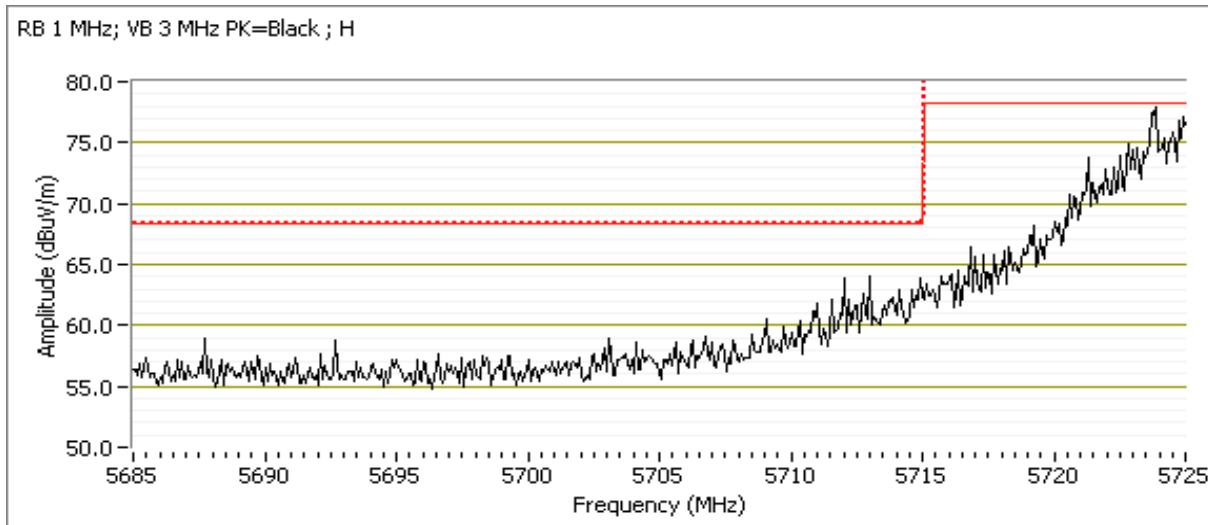



# EMC Test Data

Client: Intel Corporation	Job Number: J94914
Model: 7265D2W	T-Log Number: T95472
Contact: Steve Hackett	Project Manager: Christine Krebill
Standard: FCC Part 15.247, 15.407, RSS-210	Project Coordinator: -
	Class: N/A

Channel: 165      Mode: n20  
 Tx Chain: B      Data Rate: 6.5Mbps

Power Settings		
Target (dBm)	Measured (dBm)	Software Setting
16.5	16.6	32.5

### 5850 MHz- Band Edge Signal Field Strength - Direct measurement of field strength

Frequency MHz	Level dB $\mu$ V/m	Pol v/h	15.407(b)(4)		Detector Pk/QP/Avg	Azimuth degrees	Height meters	Comments
			Limit	Margin				
5852.460	63.6	H	78.3	-14.7	PK	93	1.2	POS; RB 1 MHz; VB: 3 MHz
5850.560	63.4	V	78.3	-14.9	PK	220	1.1	POS; RB 1 MHz; VB: 3 MHz

### 5860 MHz- Band Edge Signal Field Strength - Direct measurement of field strength

Frequency MHz	Level dB $\mu$ V/m	Pol v/h	15.407(b)(4)		Detector Pk/QP/Avg	Azimuth degrees	Height meters	Comments
			Limit	Margin				
5861.200	59.8	H	68.3	-8.5	PK	93	1.2	POS; RB 1 MHz; VB: 3 MHz
5874.790	58.1	V	68.3	-10.2	PK	220	1.1	POS; RB 1 MHz; VB: 3 MHz

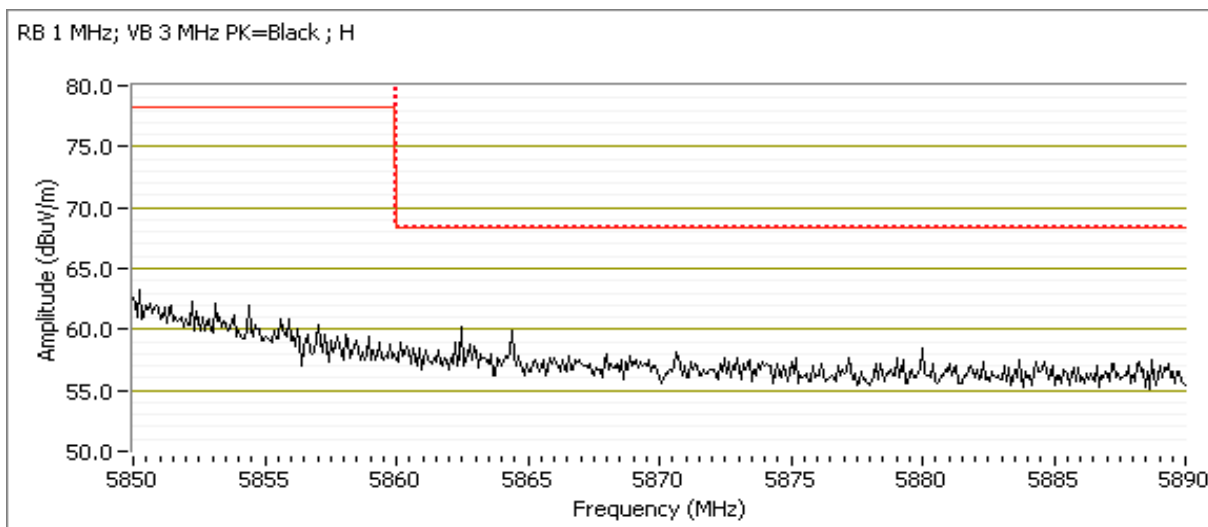



# EMC Test Data

Client: Intel Corporation	Job Number: J94914
Model: 7265D2W	T-Log Number: T95472
Contact: Steve Hackett	Project Manager: Christine Krebill
Standard: FCC Part 15.247, 15.407, RSS-210	Project Coordinator: -
	Class: N/A

### Run #3: Radiated Bandedge Measurements

Date of Test: 6/12/2014 0:00

Config. Used: 1

Test Engineer: Jack Liu

Config Change: None

Test Location: FT Chamber #5

EUT Voltage: 120V

Channel: 151

Mode: n40

Tx Chain: B

Data Rate: 13.5Mbps

Power Settings		
Target (dBm)	Measured (dBm)	Software Setting
16.5	14.1	27.0

### 5715 MHz - Band Edge Signal Field Strength - Direct measurement of field strength

Frequency MHz	Level dB $\mu$ V/m	Pol v/h	15.407(b)(4)		Detector Pk/QP/Avg	Azimuth degrees	Height meters	Comments
			Limit	Margin				
5723.140	71.6	H	78.3	-6.7	PK	90	1.3	POS; RB 1 MHz; VB: 3 MHz
5723.640	69.7	V	78.3	-8.6	PK	220	1.0	POS; RB 1 MHz; VB: 3 MHz

### 5725 MHz - Band Edge Signal Field Strength - Direct measurement of field strength

Frequency MHz	Level dB $\mu$ V/m	Pol v/h	15.407(b)(4)		Detector Pk/QP/Avg	Azimuth degrees	Height meters	Comments
			Limit	Margin				
5714.220	67.4	H	68.3	-0.9	PK	90	1.3	POS; RB 1 MHz; VB: 3 MHz
5711.210	65.0	V	68.3	-3.3	PK	220	1.0	POS; RB 1 MHz; VB: 3 MHz

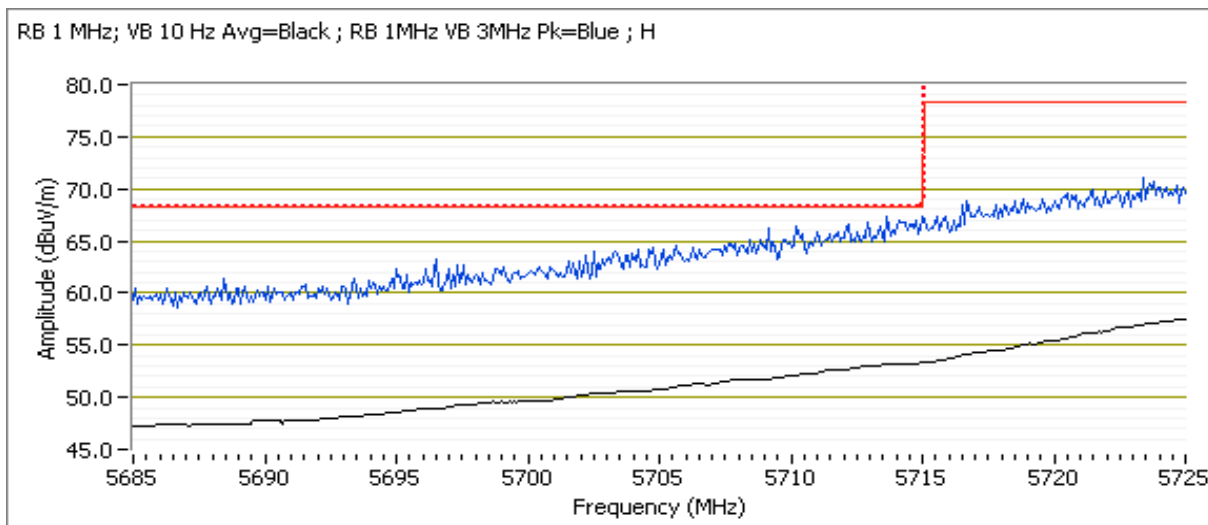



# EMC Test Data

Client: Intel Corporation	Job Number: J94914
Model: 7265D2W	T-Log Number: T95472
Contact: Steve Hackett	Project Manager: Christine Krebill
Standard: FCC Part 15.247, 15.407, RSS-210	Project Coordinator: -
	Class: N/A

Channel: 159      Mode: n40  
 Tx Chain: B      Data Rate: 13.5Mbps

Power Settings		
Target (dBm)	Measured (dBm)	Software Setting
16.5	15.4	31.5

### 5850 MHz- Band Edge Signal Field Strength - Direct measurement of field strength

Frequency MHz	Level dB $\mu$ V/m	Pol v/h	15.407(b)(4)		Detector Pk/QP/Avg	Azimuth degrees	Height meters	Comments
			Limit	Margin				
5850.100	72.8	H	78.3	-5.5	PK	121	1.1	POS; RB 1 MHz; VB: 3 MHz
5850.080	72.0	V	78.3	-6.3	PK	183	1.0	POS; RB 1 MHz; VB: 3 MHz

### 5860 MHz- Band Edge Signal Field Strength - Direct measurement of field strength

Frequency MHz	Level dB $\mu$ V/m	Pol v/h	15.407(b)(4)		Detector Pk/QP/Avg	Azimuth degrees	Height meters	Comments
			Limit	Margin				
5862.580	67.4	V	68.3	-0.9	PK	183	1.0	POS; RB 1 MHz; VB: 3 MHz
5860.420	67.8	H	68.3	-0.5	PK	121	1.1	POS; RB 1 MHz; VB: 3 MHz

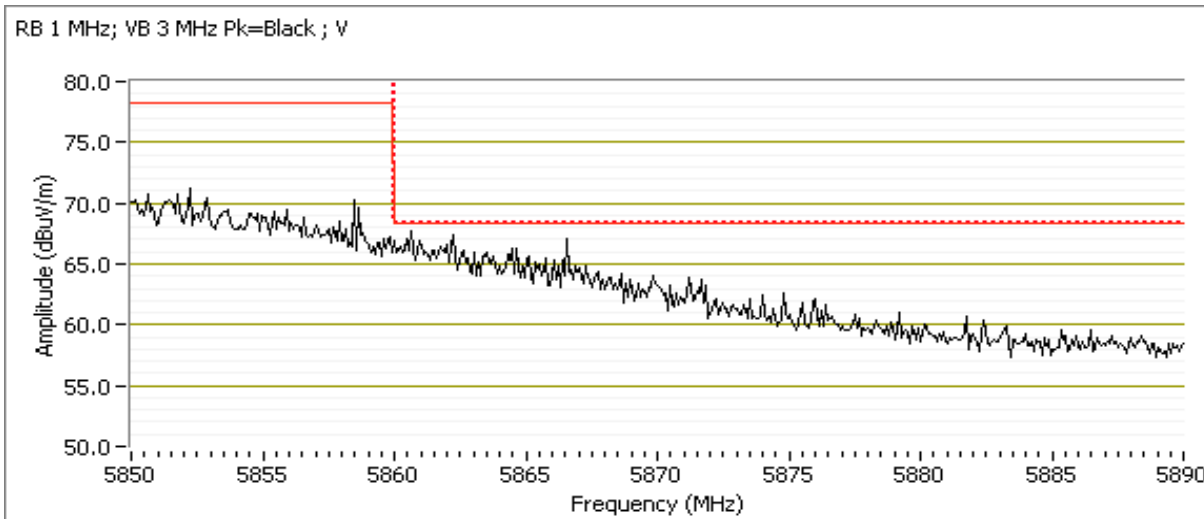



# EMC Test Data

Client: Intel Corporation	Job Number: J94914
Model: 7265D2W	T-Log Number: T95472
Contact: Steve Hackett	Project Manager: Christine Krebill
Standard: FCC Part 15.247, 15.407, RSS-210	Project Coordinator: -
	Class: N/A

### Run #4: Radiated Bandedge Measurements

Date of Test: 6/12/2014 0:00  
 Test Engineer: Rafael Varelas  
 Test Location: FT Chamber #5

Config. Used: 1  
 Config Change: None  
 EUT Voltage: 120V

Channel: 155 Mode: ac80  
 Tx Chain: B Data Rate: 29.3Mbps

Power Settings		
Target (dBm)	Measured (dBm)	Software Setting
16.5	11.3	22.5

### 5715 MHz - Band Edge Signal Field Strength - Direct measurement of field strength

Frequency MHz	Level dB $\mu$ V/m	Pol v/h	15.407(b)(4)		Detector Pk/QP/Avg	Azimuth degrees	Height meters	Comments
			Limit	Margin				
5707.600	67.4	H	68.3	-0.9	PK	95	1.2	POS; RB 1 MHz; VB: 3 MHz
5703.100	65.5	V	68.3	-2.8	PK	219	1.0	POS; RB 1 MHz; VB: 3 MHz

### 5725 MHz - Band Edge Signal Field Strength - Direct measurement of field strength

Frequency MHz	Level dB $\mu$ V/m	Pol v/h	15.407(b)(4)		Detector Pk/QP/Avg	Azimuth degrees	Height meters	Comments
			Limit	Margin				
5716.820	67.3	H	78.3	-11.0	PK	95	1.2	POS; RB 1 MHz; VB: 3 MHz
5720.990	65.6	V	78.3	-12.7	PK	219	1.0	POS; RB 1 MHz; VB: 3 MHz

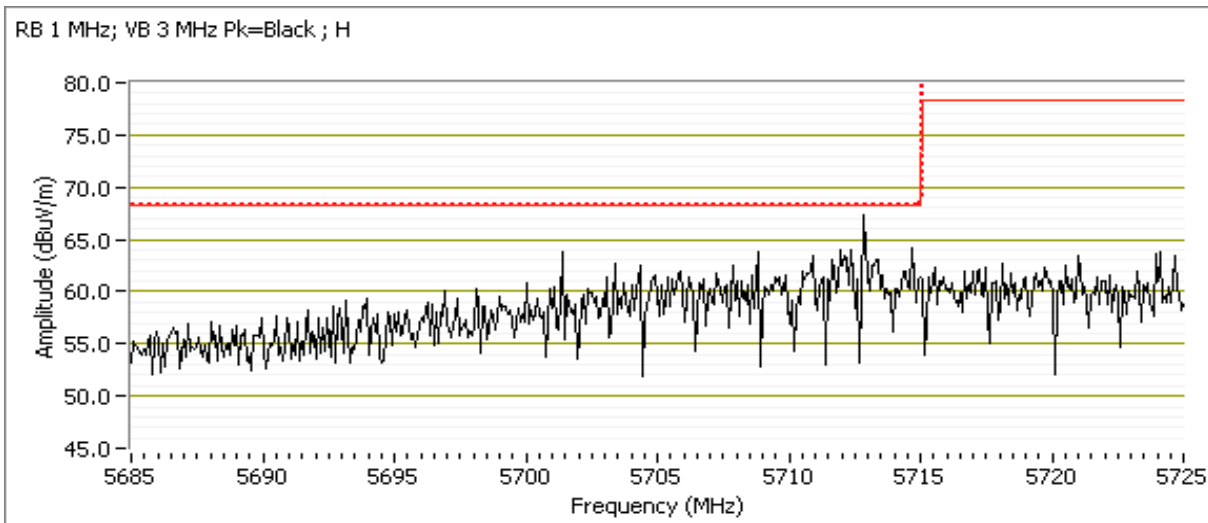



# EMC Test Data

Client: Intel Corporation	Job Number: J94914
Model: 7265D2W	T-Log Number: T95472
Contact: Steve Hackett	Project Manager: Christine Krebill
Standard: FCC Part 15.247, 15.407, RSS-210	Project Coordinator: -
	Class: N/A

### 5850 MHz- Band Edge Signal Field Strength - Direct measurement of field strength

Frequency MHz	Level dB $\mu$ V/m	Pol v/h	15.407(b)(4)		Detector Pk/QP/Avg	Azimuth degrees	Height meters	Comments
			Limit	Margin				
5858.380	61.5	H	78.3	-16.8	PK	54	1.3	pwr setting 22.5
5851.660	60.5	V	78.3	-17.8	PK	179	1.0	pwr setting 22.5

### 5860 MHz- Band Edge Signal Field Strength - Direct measurement of field strength

Frequency MHz	Level dB $\mu$ V/m	Pol v/h	15.407(b)(4)		Detector Pk/QP/Avg	Azimuth degrees	Height meters	Comments
			Limit	Margin				
5862.710	61.0	H	68.3	-7.3	PK	54	1.3	pwr setting 22.5
5871.960	59.2	V	68.3	-9.1	PK	179	1.0	pwr setting 22.5

RB 1 MHz; VB 3 MHz Pk=Black ; H

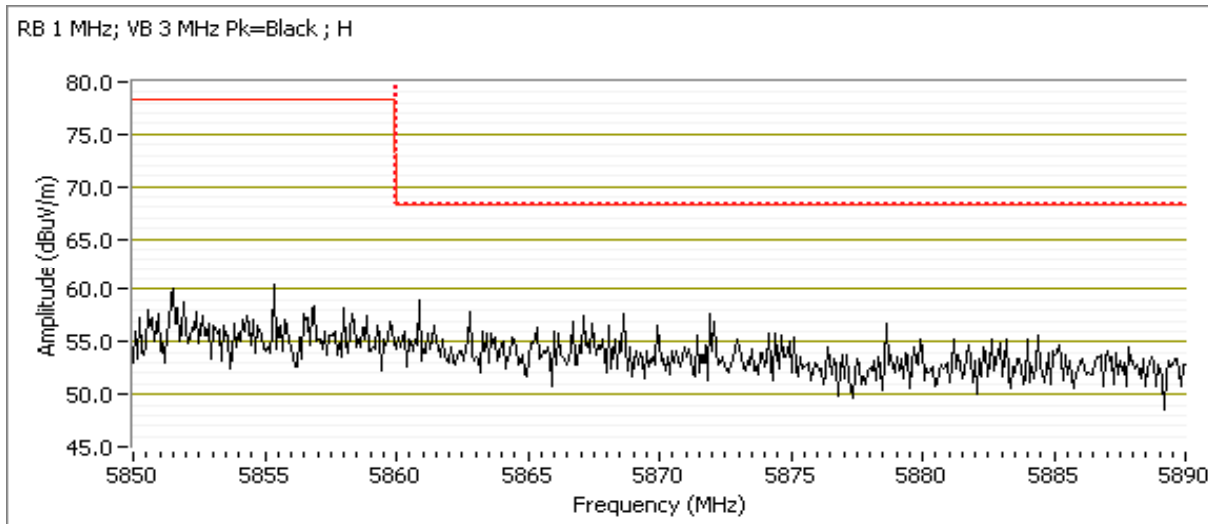



# EMC Test Data

Client: Intel Corporation	Job Number: J94914
Model: 7265D2W	T-Log Number: T95472
	Project Manager: Christine Krebill
Contact: Steve Hackett	Project Coordinator: -
Standard: FCC Part 15.247, 15.407, RSS-210	Class: N/A

## RSS 210 and FCC 15.247 (DTS) Radiated Spurious Emissions

### Test Specific Details

Objective: The objective of this test session is to perform final qualification testing of the EUT with respect to the specification listed above.

### General Test Configuration

The EUT and all local support equipment were located on the turntable for radiated spurious emissions testing. For radiated emissions testing the measurement antenna was located 3 meters from the EUT, unless otherwise noted.

### Ambient Conditions:

Temperature: 21.5 °C  
Rel. Humidity: 37 %

### Summary of Results - Device Operating in the 5725-5850 MHz Band

Run #	Mode	Channel	Power Setting	Measured Power	Test Performed	Limit	Result / Margin
1	n20	149 - 5745MHz	33.5, 34.0	16.3, 15.7	Band Edge (5725 MHz)	FCC Part 15.407(b)(4)	67.5 dBµV/m @ 5712.9 MHz (-0.8 dB)
	n20	165 - 5825MHz	34.5, 35.0	16.7, 16.6	Band Edge (5850 MHz)	FCC Part 15.407(b)(4)	66.2 dBµV/m @ 5861.7 MHz (-2.1 dB)
2	n40	151 - 5755MHz	25.0, 25.5	12.0, 11.3	Band Edge (5725 MHz)	FCC Part 15.407(b)(4)	67.1 dBµV/m @ 5713.9 MHz (-1.2 dB)
	n40	159 - 5795MHz	34.0, 35.0	16.5, 16.6	Band Edge (5850 MHz)	FCC Part 15.407(b)(4)	66.1 dBµV/m @ 5860.1 MHz (-2.2 dB)
3	ac80	155 - 5775MHz	22.5, 23.0	10.4, 10.1	Band Edge (5725 MHz)	FCC Part 15.407(b)(4)	67.2 dBµV/m @ 5710.0 MHz (-1.1 dB)
			22.5, 23.0	10.4, 10.1	Band Edge (5850 MHz)	FCC Part 15.407(b)(4)	63.6 dBµV/m @ 5862.7 MHz (-4.7 dB)



# EMC Test Data

Client:	Intel Corporation	Job Number:	J94914
Model:	7265D2W	T-Log Number:	T95472
Contact:	Steve Hackett	Project Manager:	Christine Krebill
Standard:	FCC Part 15.247, 15.407, RSS-210	Project Coordinator:	-
		Class:	N/A

### Modifications Made During Testing

No modifications were made to the EUT during testing

### Deviations From The Standard

No deviations were made from the requirements of the standard.

Note - measured powers are average power measured with a power meter, for reference only.

### Sample Notes

MAC Address: 001500F15B3A DRTU Tool Version 1.7.3-935 Driver version 17.1.0.11

Antenna: Skycross WiMax/WLAN

### Procedure Comments:

Measurements performed in accordance with FCC KDB 558074

Peak measurements performed with: RBW=1MHz, VBW=3MHz, peak detector, max hold, auto sweep time

Unless otherwise stated/noted, emission has duty cycle  $\geq 98\%$  and was measured using RBW=1MHz, VBW=10Hz, peak detector, linear average mode, auto sweep time, max hold.

Mode	Data Rate	Duty Cycle (x)	Constant DC?	T (ms)	Pwr Cor Factor*	Lin Volt Cor Factor**	Min VBW for FS (Hz)
n20	6.5Mbps	98%	Constant	1.92	0.0	0.0	521
n40	13.5Mbps	97%	Constant	0.94	0.1	0.3	1064
ac80	29.3Mbps	94%	Constant	0.44	0.3	0.6	2273

### Measurement Specific Notes:

Note 1:	For emissions outside of the restricted bands the limit is -27dBm/MHz eirp (68.3dBuV/m) (or -17dBm/MHz eirp (78.3dBuV/m)). The measurement method required is a peak measurement (RB=1MHz, VB $\geq$ 3MHz, peak detector). Per KDB 789033 D02 G) 2) (c), compliance can be demonstrated by meeting the average and peak limits of 15.209, as an alternative.
---------	--





# EMC Test Data

Client: Intel Corporation	Job Number: J94914
Model: 7265D2W	T-Log Number: T95472
Contact: Steve Hackett	Project Manager: Christine Krebill
Standard: FCC Part 15.247, 15.407, RSS-210	Project Coordinator: -
	Class: N/A

Run #1: Radiated Bandedge Measurements  
 Date of Test: 6/12/2014 0:00      Config. Used: 1  
 Test Engineer: Rafael Varelas      Config Change: None  
 Test Location: FT Chamber #5      EUT Voltage: 120V

Channel: 149      Mode: n20  
 Tx Chain: A+B      Data Rate: 6.5Mbps

Chain	A	B	C	Total	A	B	C	Total	
	16.5	16.5		19.5	16.3	15.7		19.0	33.5,34.0

### 5715 MHz - Band Edge Signal Field Strength - Direct measurement of field strength

Frequency	Level	Pol	15.407(b)(4)		Detector	Azimuth	Height	Comments
MHz	dB $\mu$ V/m	v/h	Limit	Margin	Pk/QP/Avg	degrees	meters	
5712.900	67.5	H	68.3	-0.8	PK	94	1.3	POS; RB 1 MHz; VB: 3 MHz
5713.800	65.7	V	68.3	-2.6	PK	180	1.0	POS; RB 1 MHz; VB: 3 MHz

### 5725 MHz - Band Edge Signal Field Strength - Direct measurement of field strength

Frequency	Level	Pol	15.407(b)(4)		Detector	Azimuth	Height	Comments
MHz	dB $\mu$ V/m	v/h	Limit	Margin	Pk/QP/Avg	degrees	meters	
5723.320	77.4	H	78.3	-0.9	PK	94	1.3	POS; RB 1 MHz; VB: 3 MHz
5724.520	75.0	V	78.3	-3.3	PK	180	1.0	POS; RB 1 MHz; VB: 3 MHz

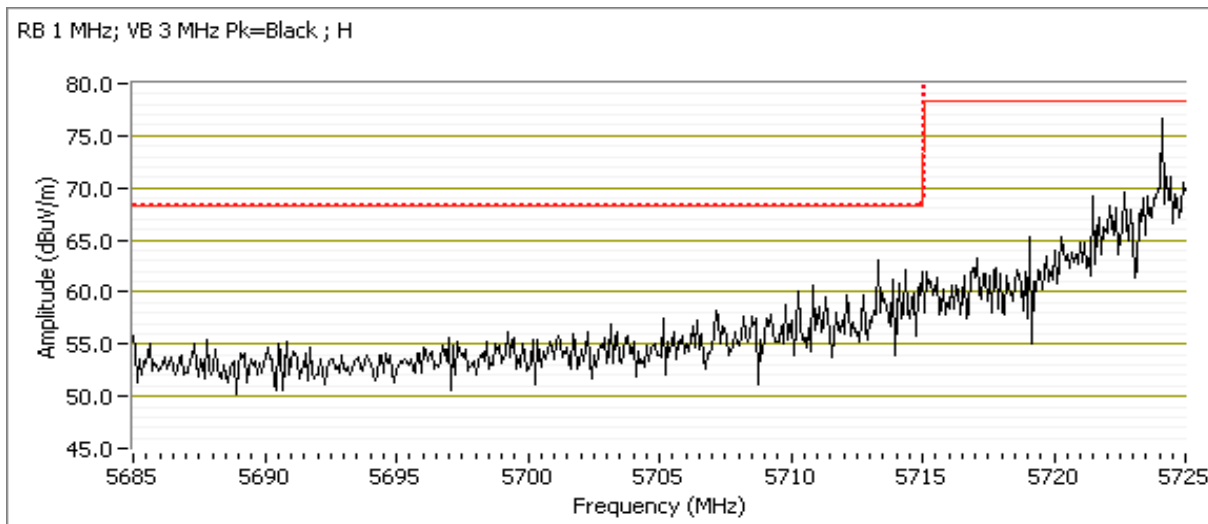



# EMC Test Data

Client: Intel Corporation	Job Number: J94914
Model: 7265D2W	T-Log Number: T95472
Contact: Steve Hackett	Project Manager: Christine Krebill
Standard: FCC Part 15.247, 15.407, RSS-210	Project Coordinator: -
	Class: N/A

Channel: 165                      Mode: n20  
 Tx Chain: A+B                      Data Rate: 6.5Mbps

Chain	Power Settings								Software Setting
	Target (dBm)				Measured (dBm)				
	A	B	C	Total	A	B	C	Total	
	16.5	16.5		19.5	16.7	16.6		19.7	34.5, 35.0

### 5850 MHz- Band Edge Signal Field Strength - Direct measurement of field strength

Frequency	Level	Pol	15.407(b)(4)		Detector	Azimuth	Height	Comments
MHz	dB $\mu$ V/m	v/h	Limit	Margin	Pk/QP/Avg	degrees	meters	
5850.160	72.4	H	78.3	-5.9	PK	254	1.0	POS; RB 1 MHz; VB: 3 MHz
5850.680	75.2	V	78.3	-3.1	PK	212	1.1	POS; RB 1 MHz; VB: 3 MHz

### 5860 MHz- Band Edge Signal Field Strength - Direct measurement of field strength

Frequency	Level	Pol	15.407(b)(4)		Detector	Azimuth	Height	Comments
MHz	dB $\mu$ V/m	v/h	Limit	Margin	Pk/QP/Avg	degrees	meters	
5861.680	66.2	V	68.3	-2.1	PK	212	1.1	POS; RB 1 MHz; VB: 3 MHz
5861.200	63.6	H	68.3	-4.7	PK	254	1.0	POS; RB 1 MHz; VB: 3 MHz

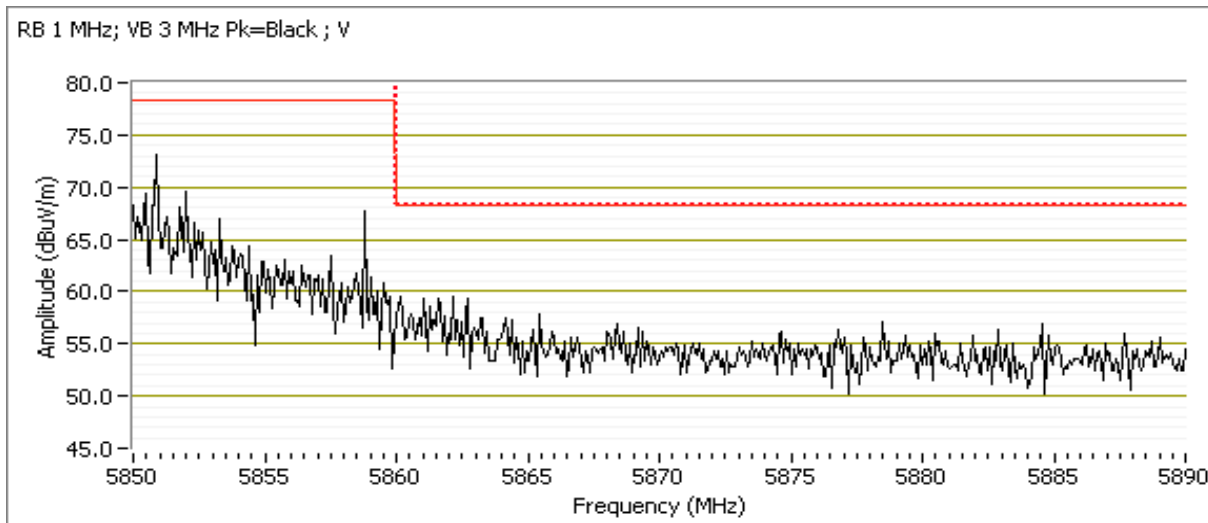



# EMC Test Data

Client: Intel Corporation	Job Number: J94914
Model: 7265D2W	T-Log Number: T95472
Contact: Steve Hackett	Project Manager: Christine Krebill
Standard: FCC Part 15.247, 15.407, RSS-210	Project Coordinator: -
	Class: N/A

### Run #2: Radiated Bandedge Measurements

Date of Test: 6/12/2014 0:00

Test Engineer: Rafael Varelas

Test Location: FT Chamber #5

Config. Used: 1

Config Change: None

EUT Voltage: 120V

Channel: 151                      Mode: n40  
 Tx Chain: A+B                      Data Rate: 13.5Mbps

Chain	Power Settings								Software Setting
	Target (dBm)				Measured (dBm)				
	A	B	C	Total	A	B	C	Total	
	16.5	16.5		19.5	12.0	11.3		14.7	25.0, 25.5

### 5715 MHz - Band Edge Signal Field Strength - Direct measurement of field strength

Frequency	Level	Pol	15.407(b)(4)		Detector	Azimuth	Height	Comments
MHz	dB $\mu$ V/m	v/h	Limit	Margin	Pk/QP/Avg	degrees	meters	
5713.860	67.1	V	68.3	-1.2	PK	220	1.0	POS; RB 1 MHz; VB: 3 MHz
5707.790	67.5	H	68.3	-0.8	PK	45	1.2	POS; RB 1 MHz; VB: 3 MHz

### 5725 MHz - Band Edge Signal Field Strength - Direct measurement of field strength

Frequency	Level	Pol	15.407(b)(4)		Detector	Azimuth	Height	Comments
MHz	dB $\mu$ V/m	v/h	Limit	Margin	Pk/QP/Avg	degrees	meters	
5724.180	69.5	V	78.3	-8.8	PK	220	1.0	POS; RB 1 MHz; VB: 3 MHz
5723.560	70.9	H	78.3	-7.4	PK	45	1.2	POS; RB 1 MHz; VB: 3 MHz

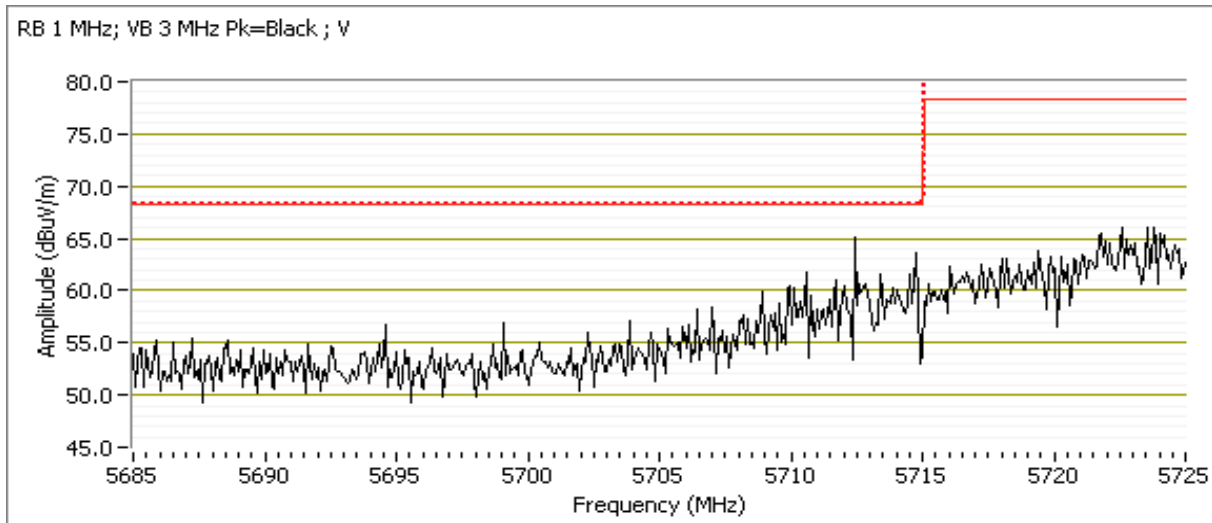



# EMC Test Data

Client: Intel Corporation	Job Number: J94914
Model: 7265D2W	T-Log Number: T95472
Contact: Steve Hackett	Project Manager: Christine Krebill
Standard: FCC Part 15.247, 15.407, RSS-210	Project Coordinator: -
	Class: N/A

Channel: 159                      Mode: n40  
 Tx Chain: A+B                      Data Rate: 13.5Mbps

Chain	Power Settings								Software Setting
	Target (dBm)				Measured (dBm)				
	A	B	C	Total	A	B	C	Total	
	16.5	16.5		19.5	16.5	16.6		19.6	34.0, 35.0

### 5850 MHz- Band Edge Signal Field Strength - Direct measurement of field strength

Frequency	Level	Pol	15.407(b)(4)		Detector	Azimuth	Height	Comments
MHz	dB $\mu$ V/m	v/h	Limit	Margin	Pk/QP/Avg	degrees	meters	
5853.290	68.7	V	78.3	-9.6	PK	224	1.0	POS; RB 1 MHz; VB: 3 MHz
5850.360	66.4	H	78.3	-11.9	PK	0	1.1	POS; RB 1 MHz; VB: 3 MHz

### 5860 MHz- Band Edge Signal Field Strength - Direct measurement of field strength

Frequency	Level	Pol	15.407(b)(4)		Detector	Azimuth	Height	Comments
MHz	dB $\mu$ V/m	v/h	Limit	Margin	Pk/QP/Avg	degrees	meters	
5860.120	66.1	V	68.3	-2.2	PK	224	1.0	POS; RB 1 MHz; VB: 3 MHz
5861.560	63.5	H	68.3	-4.8	PK	0.0	1.1	POS; RB 1 MHz; VB: 3 MHz

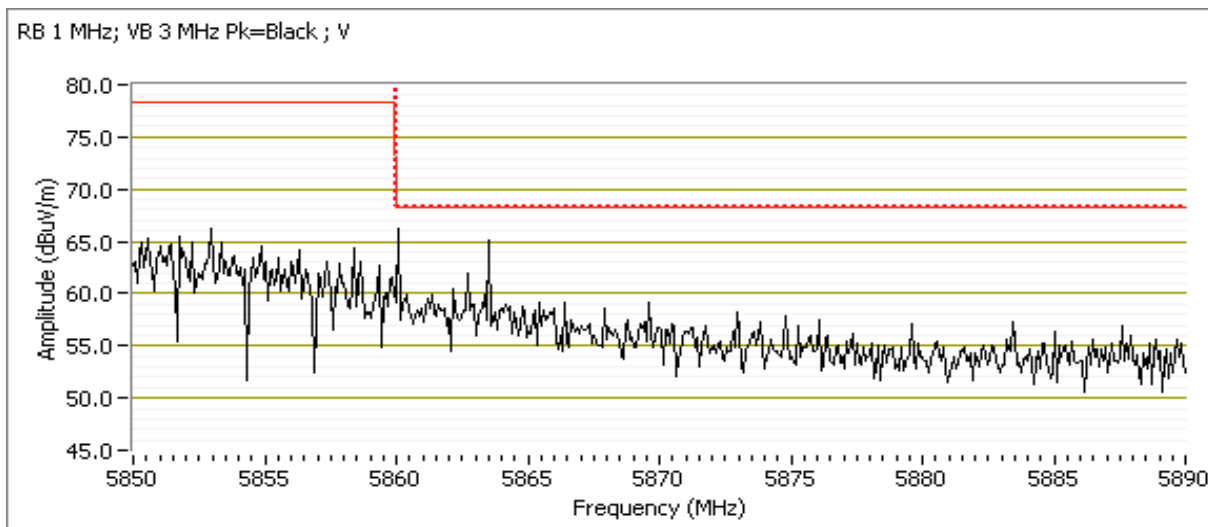



# EMC Test Data

Client: Intel Corporation	Job Number: J94914
Model: 7265D2W	T-Log Number: T95472
Contact: Steve Hackett	Project Manager: Christine Krebill
Standard: FCC Part 15.247, 15.407, RSS-210	Project Coordinator: -
	Class: N/A

### Run #3: Radiated Bandedge Measurements

Date of Test: 6/12/2014 0:00

Config. Used: 1

Test Engineer: Rafael Varelas

Config Change: None

Test Location: FT Chamber #5

EUT Voltage: 120V

Channel: 155                      Mode: ac80  
 Tx Chain: A+B                      Data Rate: 29.3Mbps

Chain	Power Settings								Software Setting
	Target (dBm)				Measured (dBm)				
	A	B	C	Total	A	B	C	Total	
	16.5	16.5		19.5	10.4	10.1		13.3	22.5, 23.0

### 5715 MHz - Band Edge Signal Field Strength - Direct measurement of field strength

Frequency	Level	Pol	15.407(b)(4)		Detector	Azimuth	Height	Comments
MHz	dB $\mu$ V/m	v/h	Limit	Margin	Pk/QP/Avg	degrees	meters	
5709.950	67.2	V	68.3	-1.1	PK	216	1.0	POS; RB 1 MHz; VB: 3 MHz
5711.390	66.8	H	68.3	-1.5	PK	99	1.3	POS; RB 1 MHz; VB: 3 MHz

### 5725 MHz - Band Edge Signal Field Strength - Direct measurement of field strength

Frequency	Level	Pol	15.407(b)(4)		Detector	Azimuth	Height	Comments
MHz	dB $\mu$ V/m	v/h	Limit	Margin	Pk/QP/Avg	degrees	meters	
5717.690	67.4	V	78.3	-10.9	PK	216	1.0	POS; RB 1 MHz; VB: 3 MHz
5717.060	67.1	H	78.3	-11.2	PK	99	1.3	POS; RB 1 MHz; VB: 3 MHz

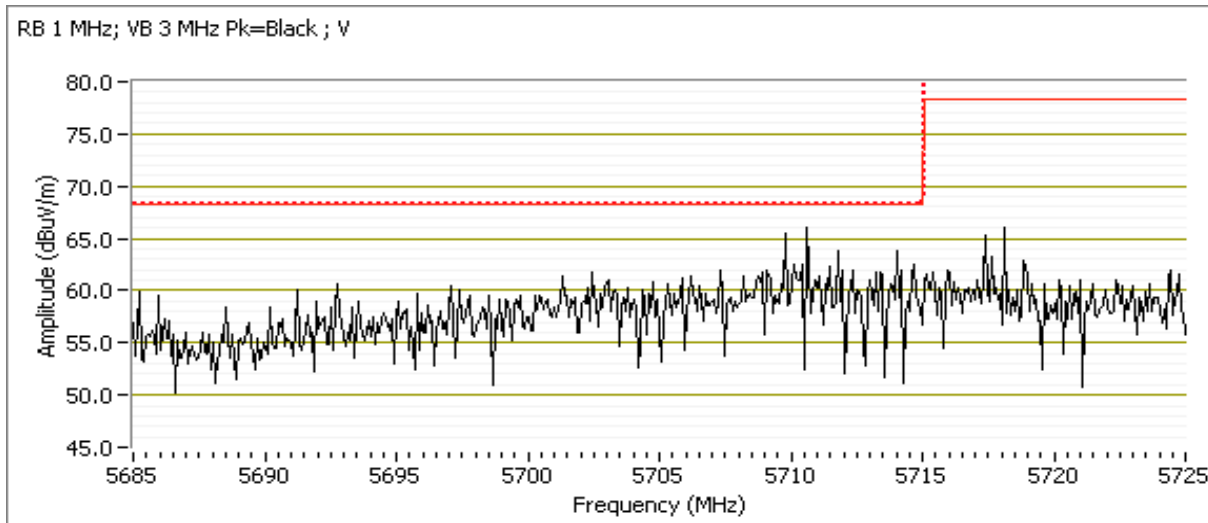



# EMC Test Data

Client: Intel Corporation	Job Number: J94914
Model: 7265D2W	T-Log Number: T95472
Contact: Steve Hackett	Project Manager: Christine Krebill
Standard: FCC Part 15.247, 15.407, RSS-210	Project Coordinator: -
	Class: N/A

### 5850 MHz- Band Edge Signal Field Strength - Direct measurement of field strength

Frequency MHz	Level dB $\mu$ V/m	Pol v/h	15.407(b)(4)		Detector Pk/QP/Avg	Azimuth degrees	Height meters	Comments
			Limit	Margin				
5857.350	65.1	V	78.3	-13.2	PK	208	1.1	POS; RB 1 MHz; VB: 3 MHz
5858.140	63.5	H	78.3	-14.8	PK	6	1.2	POS; RB 1 MHz; VB: 3 MHz

### 5860 MHz- Band Edge Signal Field Strength - Direct measurement of field strength

Frequency MHz	Level dB $\mu$ V/m	Pol v/h	15.407(b)(4)		Detector Pk/QP/Avg	Azimuth degrees	Height meters	Comments
			Limit	Margin				
5862.650	63.6	V	68.3	-4.7	PK	208	1.1	POS; RB 1 MHz; VB: 3 MHz
5860.120	62.1	H	68.3	-6.2	PK	6	1.2	POS; RB 1 MHz; VB: 3 MHz

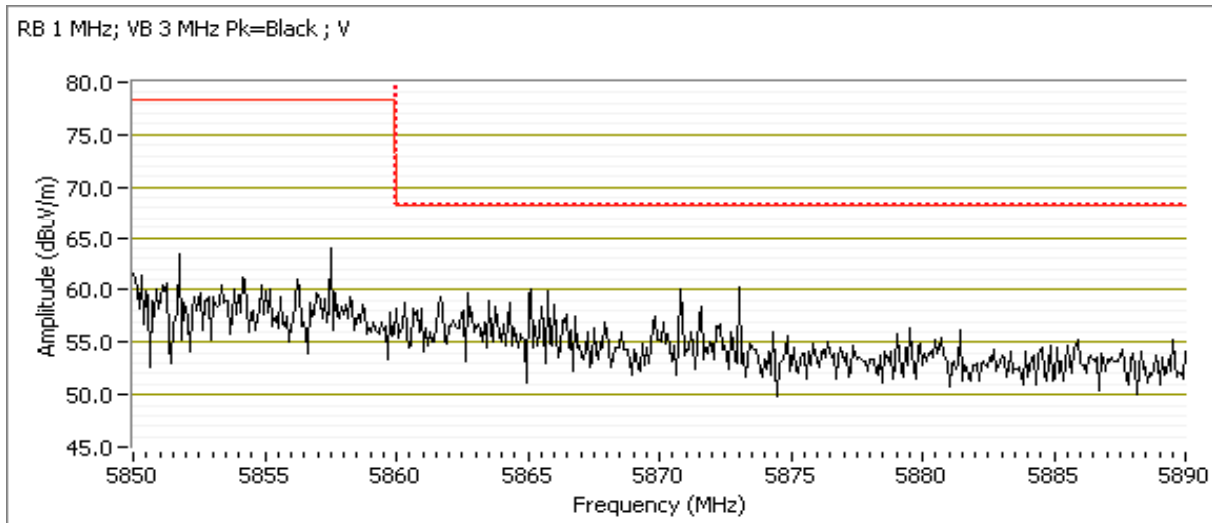



# EMC Test Data

Client:	Intel Corporation	Job Number:	J94914
Model:	7265D2W	T-Log Number:	T95472
Contact:	Steve Hackett	Project Manager:	Christine Krebill
Standard:	FCC Part 15.247, 15.407, RSS-210	Project Coordinator:	-
		Class:	N/A

## RSS 210 and FCC 15.247 (DTS) Radiated Spurious Emissions

### Test Specific Details

Objective: The objective of this test session is to perform final qualification testing of the EUT with respect to the specification listed above.

### General Test Configuration

The EUT and all local support equipment were located on the turntable for radiated spurious emissions testing. For radiated emissions testing the measurement antenna was located 3 meters from the EUT, unless otherwise noted.

### Ambient Conditions:

Temperature: 22.4 °C  
Rel. Humidity: 35 %

### Summary of Results - Device Operating in the 5725-5850 MHz Band

Run #	Mode	Channel	Target Power	Power Setting	Test Performed	Limit	Result / Margin
Scans on center channel in all three OFDM modes to determine the worst case mode.							
1	a - Chain A	157 - 5785MHz	16.5	30.0	Radiated Emissions, 1 - 40 GHz	FCC Part 15.209 / 15.407(b)(4)	62.2 dBµV/m @ 17355.4 MHz (-6.1 dB)
	a - Chain B	157 - 5785MHz	16.5	31.5	Radiated Emissions, 1 - 40 GHz	FCC Part 15.209 / 15.407(b)(4)	61.0 dBµV/m @ 17359.3 MHz (-7.3 dB)
	n20 - Chain A+B	157 - 5785MHz	16.5	34.5 / 35.5	Radiated Emissions, 1 - 40 GHz	FCC Part 15.209 / 15.407(b)(4)	59.4 dBµV/m @ 17372.6 MHz (-8.9 dB)
	n40 - Chain A+B	159 - 5795MHz	16.5	34.0 / 35.0	Radiated Emissions, 1 - 40 GHz	FCC Part 15.209 / 15.407(b)(4)	62.7 dBµV/m @ 17379.3 MHz (-5.6 dB)
	ac80 - Chain A+B	155 - 5775MHz	16.5	28.5 / 29.0	Radiated Emissions, 1 - 40 GHz	FCC Part 15.209 / 15.407(b)(4)	61.2 dBµV/m @ 17313.9 MHz (-7.1 dB)
worse case from 1							
2	n40 - Chain A+B	151 - 5755MHz	16.5	34.0, 34.5	Radiated Emissions, 1 - 40 GHz	FCC Part 15.209 / 15.407(b)(4)	62.4 dBµV/m @ 17249.1 MHz (-5.9 dB)
3	a - Chain A	165 - 5825MHz	16.5	30.0	Radiated Emissions, 1 - 40 GHz	FCC Part 15.209 / 15.407(b)(4)	67.5 dBµV/m @ 17481.2 MHz (-0.8 dB)

### Modifications Made During Testing

No modifications were made to the EUT during testing

### Deviations From The Standard

No deviations were made from the requirements of the standard.



# EMC Test Data

Client:	Intel Corporation	Job Number:	J94914
Model:	7265D2W	T-Log Number:	T95472
		Project Manager:	Christine Krebill
Contact:	Steve Hackett	Project Coordinator:	-
Standard:	FCC Part 15.247, 15.407, RSS-210	Class:	N/A

Note - measured powers are average power measured with a power meter, for reference only.

## Sample Notes

MAC Address: 001500F15B3A DRTU Tool Version 1.7.3-935 Driver version 17.1.0.11

Antenna: Skycross WiMax/WLAN

## Procedure Comments:

Measurements performed in accordance with FCC KDB 558074

Peak measurements performed with: RBW=1MHz, VBW=3MHz, peak detector, max hold, auto sweep time

Unless otherwise stated/noted, emission has duty cycle  $\geq 98\%$  and was measured using RBW=1MHz, VBW=10Hz, peak detector, linear average mode, auto sweep time, max hold.

5.0GHz band reject filter used

Mode	Data Rate	Duty Cycle (x)	Constant DC?	T (ms)	Pwr Cor Factor*	Lin Volt Cor Factor**	Min VBW for FS (Hz)
11a	6.0Mbps	99%	Constant	2.06	0.0	0.0	485
n20	6.5Mbps	98%	Constant	1.92	0.0	0.0	521
n40	13.5Mbps	97%	Constant	0.94	0.1	0.3	1064
ac80	29.3Mbps	94%	Constant	0.44	0.3	0.6	2273

## Measurement Specific Notes:

Note 1:	Emission in non-restricted band, but limit of 15.209 used.
Note 2:	Emission has duty cycle $\geq 98\%$ , average measurement performed: RBW=1MHz, VBW=3MHz, RMS, Power averaging, auto sweep, trace average 100 traces
Note 3:	Emission has duty cycle $< 98\%$ , but constant, average measurement performed: RBW=1MHz, VBW=10Hz, peak detector, linear averaging, auto sweep, trace average 100 traces, measurement corrected by Linear Voltage correction factor
Note 4:	Emission has duty cycle $\geq 98\%$ , average measurement performed: RBW=1MHz, VBW=10Hz, Peak detector, linear averaging, auto sweep, trace average 100 traces
Note 5:	Emission has duty cycle $< 98\%$ and is NOT constant, average measurement performed: RBW=1MHz, VBW $> 1/T$ , peak detector, linear average mode, sweep time auto, max hold. Max hold for $50 \cdot (1/DC)$ traces
Note 6:	Emission has duty cycle $< 98\%$ , but constant, average measurement performed: RBW=1MHz, VBW=3MHz, RMS, Power averaging, auto sweep, trace average 100 traces, measurement corrected by Pwr correction factor





# EMC Test Data

Client: Intel Corporation	Job Number: J94914
Model: 7265D2W	T-Log Number: T95472
Contact: Steve Hackett	Project Manager: Christine Krebill
Standard: FCC Part 15.247, 15.407, RSS-210	Project Coordinator: -
	Class: N/A

Run #1: Radiated Spurious Emissions, 1,000 - 40000 MHz. Operating Mode: Determination of worse case OFDM mode  
 Date of Test: 6/13/2014 0:00 Config. Used: 1  
 Test Engineer: J. Liu / R. Varelas Config Change: None  
 Test Location: FT chamber5 EUT Voltage: 120V

### Run #1a: Center Channel

Channel: 157 Mode: a  
 Tx Chain: A Data Rate: 6.0Mbps

Power Settings		
Target (dBm)	Measured (dBm)	Software Setting
16.5	16.7	30.0

Frequency MHz	Level dB $\mu$ V/m	Pol v/h	15.209 / 15.407		Detector Pk/QP/Avg	Azimuth degrees	Height meters	Comments
			Limit	Margin				
17355.350	62.2	H	68.3	-6.1	PK	230	1.0	RB 1 MHz;VB 3 MHz;Peak
1132.400	31.6	V	54.0	-22.4	AVG	127	1.0	RB 1 MHz;VB 10 Hz;Peak
1138.930	45.7	V	74.0	-28.3	PK	127	1.0	RB 1 MHz;VB 3 MHz;Peak
1199.000	30.4	V	54.0	-23.6	AVG	226	1.7	RB 1 MHz;VB 10 Hz;Peak
1198.870	50.4	V	74.0	-23.6	PK	226	1.7	RB 1 MHz;VB 3 MHz;Peak
1599.400	26.9	V	54.0	-27.1	AVG	242	1.4	RB 1 MHz;VB 10 Hz;Peak
1595.870	45.2	V	74.0	-28.8	PK	242	1.4	RB 1 MHz;VB 3 MHz;Peak

Note: Scans made between 18 - 40 GHz with the measurement antenna moved around the card and its antennas 20-50cm from the device indicated there were no significant emissions in this frequency range

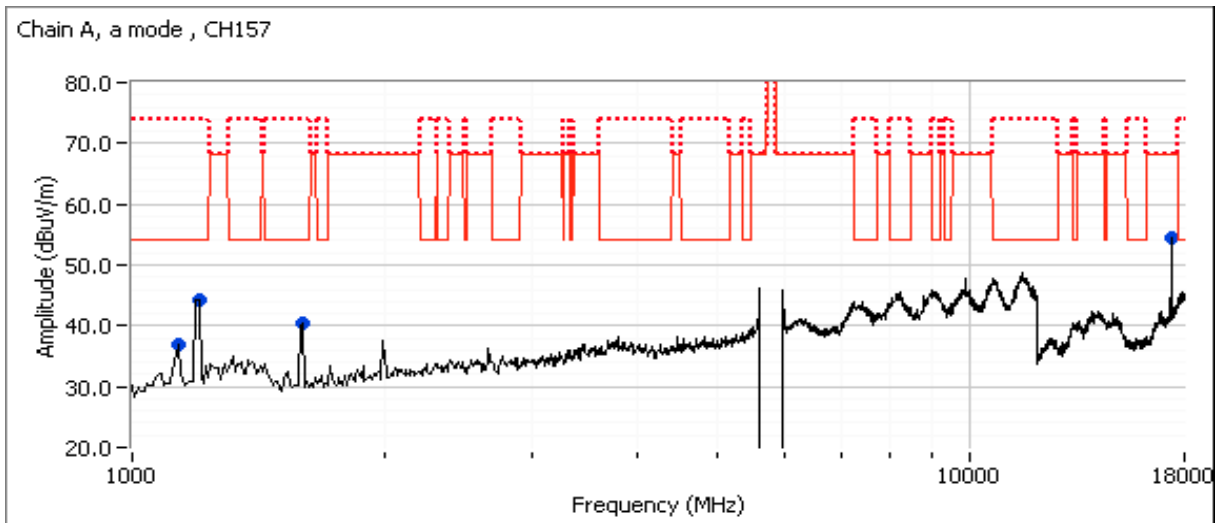



# EMC Test Data

Client: Intel Corporation	Job Number: J94914
Model: 7265D2W	T-Log Number: T95472
Contact: Steve Hackett	Project Manager: Christine Krebill
Standard: FCC Part 15.247, 15.407, RSS-210	Project Coordinator: -
	Class: N/A

## Run #1b: Center Channel

Channel: 157                      Mode: a  
 Tx Chain: B                      Data Rate: 6.0Mbps

Power Settings		
Target (dBm)	Measured (dBm)	Software Setting
16.5	16.5	31.5

Frequency MHz	Level dB $\mu$ V/m	Pol v/h	15.209 / 15.407		Detector Pk/QP/Avg	Azimuth degrees	Height meters	Comments
			Limit	Margin				
17359.290	61.0	V	68.3	-7.3	PK	245	1.0	RB 1 MHz;VB 3 MHz;Peak
23136.010	57.4	V	68.3	-10.9	PK	110	1.4	RB 1 MHz;VB 3 MHz;Peak
23139.600	56.2	H	68.3	-12.1	PK	150	0.9	RB 1 MHz;VB 3 MHz;Peak
1248.270	28.0	V	68.3	-40.3	AVG	117	2.5	RB 1 MHz;VB 10 Hz;Peak
1245.330	47.2	V	68.3	-21.1	PK	117	2.5	RB 1 MHz;VB 3 MHz;Peak
1594.400	29.4	V	54.0	-24.6	AVG	310	2.0	RB 1 MHz;VB 10 Hz;Peak
1596.600	44.8	V	74.0	-29.2	PK	310	2.0	RB 1 MHz;VB 3 MHz;Peak
1196.740	29.0	V	54.0	-25.0	AVG	293	1.1	RB 1 MHz;VB 10 Hz;Peak
1196.540	45.9	V	74.0	-28.1	PK	293	1.1	RB 1 MHz;VB 3 MHz;Peak

Note: Scans made between 18 - 40 GHz with the measurement antenna moved around the card and its antennas 20-50cm from the device indicated there were no significant emissions in this frequency range

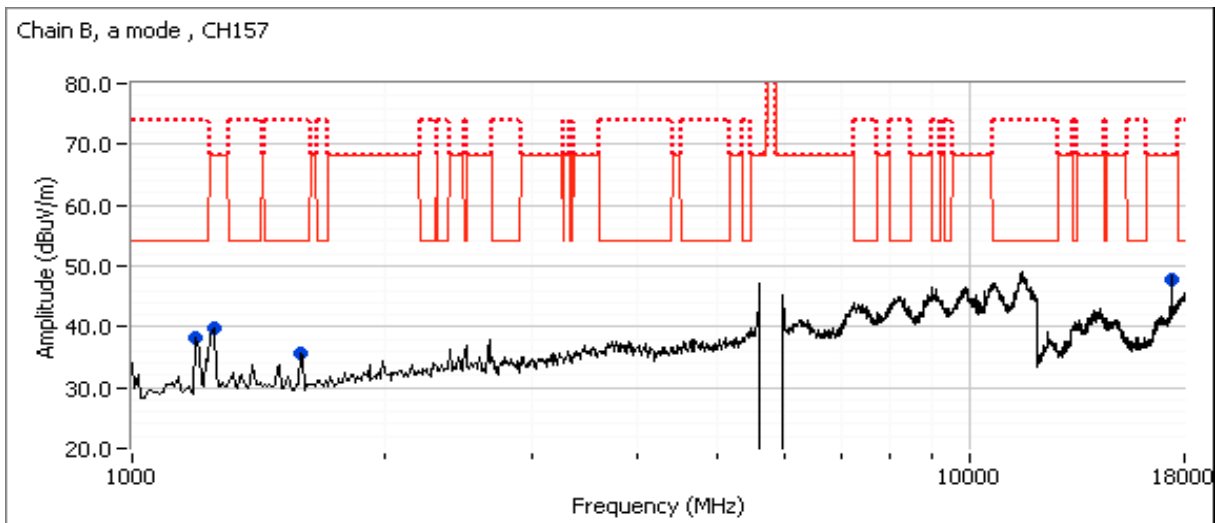



# EMC Test Data

Client: Intel Corporation	Job Number: J94914
Model: 7265D2W	T-Log Number: T95472
Contact: Steve Hackett	Project Manager: Christine Krebill
Standard: FCC Part 15.247, 15.407, RSS-210	Project Coordinator: -
	Class: N/A

Run #1c: Center Channel

Channel: 157                      Mode: n20  
 Tx Chain: A+B                      Data Rate: 6.5Mbps

Chain	Power Settings								Software Setting
	Target (dBm)				Measured (dBm)				
	A	B	C	Total	A	B	C	Total	
	16.5	16.5		19.5	16.7	16.5		19.6	34.5 / 35.5

Frequency	Level	Pol	15.209 / 15.407		Detector	Azimuth	Height	Comments
MHz	dB $\mu$ V/m	v/h	Limit	Margin	Pk/QP/Avg	degrees	meters	
17372.600	59.4	H	68.3	-8.9	PK	293	0.9	RB 1 MHz;VB 3 MHz;Peak
11565.970	41.8	V	54.0	-12.2	AVG	192	1.1	Noise floor
11539.830	54.5	V	74.0	-19.5	PK	192	1.1	RB 1 MHz;VB 3 MHz;Peak
1000.070	26.4	V	54.0	-27.6	AVG	192	1.0	RB 1 MHz;VB 10 Hz;Peak
1000.020	46.9	V	74.0	-27.1	PK	192	1.0	RB 1 MHz;VB 3 MHz;Peak
1248.340	47.8	V	68.3	-20.5	PK	101	1.0	RB 1 MHz;VB 3 MHz;Peak
1196.940	29.8	V	54.0	-24.2	AVG	249	1.0	RB 1 MHz;VB 10 Hz;Peak
1197.470	50.6	V	74.0	-23.4	PK	249	1.0	RB 1 MHz;VB 3 MHz;Peak

Note: Scans made between 18 - 40 GHz with the measurement antenna moved around the card and its antennas 20-50cm from the device indicated there were no significant emissions in this frequency range

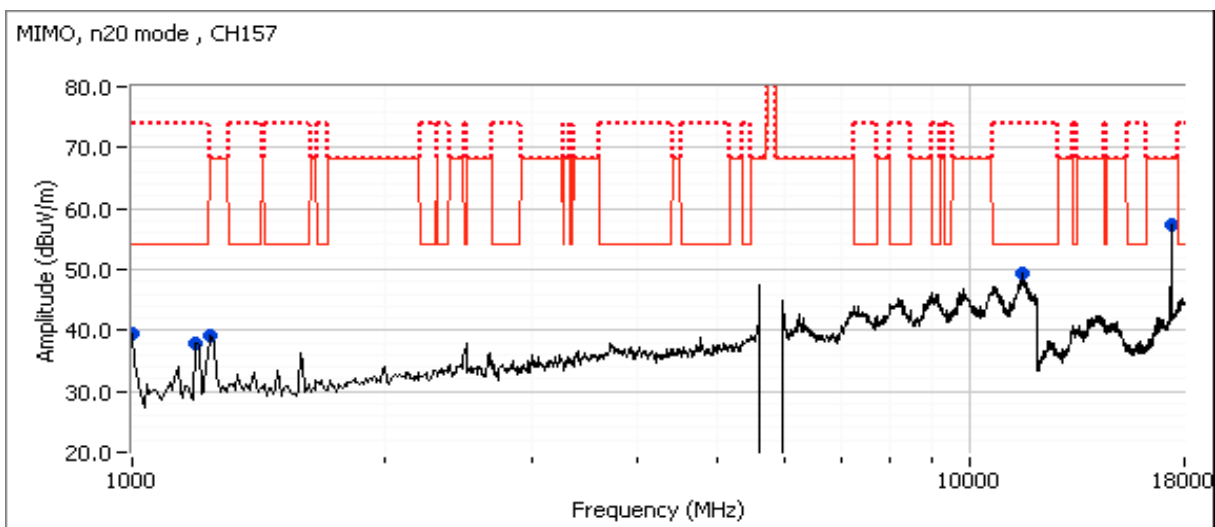



# EMC Test Data

Client: Intel Corporation	Job Number: J94914
Model: 7265D2W	T-Log Number: T95472
Contact: Steve Hackett	Project Manager: Christine Krebill
Standard: FCC Part 15.247, 15.407, RSS-210	Project Coordinator: -
	Class: N/A

Run #1d: Center Channel

Channel: 159                      Mode: n40  
 Tx Chain: A+B                      Data Rate: 13.5Mbps

Chain	Power Settings								Software Setting
	Target (dBm)				Measured (dBm)				
	A	B	C	Total	A	B	C	Total	
	16.5	16.5		19.5	16.5	16.6		19.6	34.0 / 35.0

Frequency	Level	Pol	15.209 / 15.407		Detector	Azimuth	Height	Comments
MHz	dB $\mu$ V/m	v/h	Limit	Margin	Pk/QP/Avg	degrees	meters	
17379.270	62.7	H	68.3	-5.6	PK	162	1.1	RB 1 MHz;VB 3 MHz;Peak
23180.250	56.8	V	68.3	-11.5	PK	147	1.0	RB 1 MHz;VB 3 MHz;Peak
1597.900	30.6	V	54.0	-23.4	AVG	74	1.5	RB 1 MHz;VB 10 Hz;Peak
1594.930	45.2	V	74.0	-28.8	PK	74	1.5	RB 1 MHz;VB 3 MHz;Peak
1248.670	45.0	V	68.3	-23.3	PK	252	1.9	RB 1 MHz;VB 3 MHz;Peak
11589.400	42.9	H	54.0	-11.1	AVG	162	1.1	Noise floor
11606.000	55.1	H	74.0	-18.9	PK	162	1.1	RB 1 MHz;VB 3 MHz;Peak
1195.600	30.6	V	54.0	-23.4	AVG	242	1.0	RB 1 MHz;VB 10 Hz;Peak
1196.930	52.9	V	74.0	-21.1	PK	242	1.0	RB 1 MHz;VB 3 MHz;Peak
1000.020	27.7	V	54.0	-26.3	AVG	180	1.3	RB 1 MHz;VB 10 Hz;Peak
1000.070	39.9	V	74.0	-34.1	PK	180	1.3	RB 1 MHz;VB 3 MHz;Peak

Note: Scans made between 18 - 40 GHz with the measurement antenna moved around the card and its antennas 20-50cm from the device indicated there were no significant emissions in this frequency range

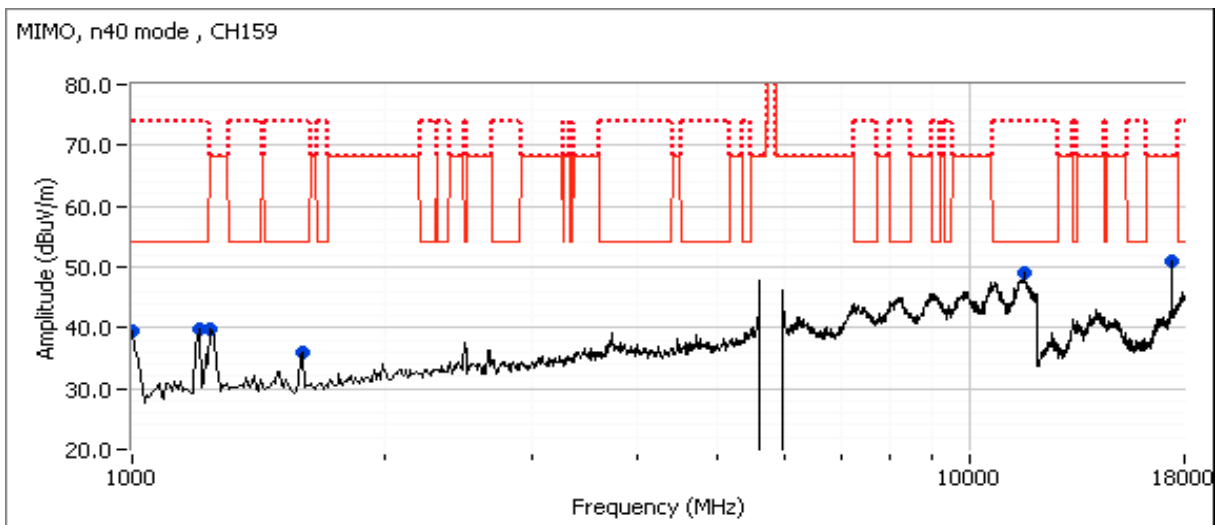



# EMC Test Data

Client:	Intel Corporation	Job Number:	J94914
Model:	7265D2W	T-Log Number:	T95472
Contact:	Steve Hackett	Project Manager:	Christine Krebill
Standard:	FCC Part 15.247, 15.407, RSS-210	Project Coordinator:	-
		Class:	N/A

## Run #1e: Center Channel

Channel: 155                      Mode: ac80  
 Tx Chain: A+B                      Data Rate: 29.3Mbps

Chain	Power Settings								Software Setting
	Target (dBm)				Measured (dBm)				
	A	B	C	Total	A	B	C	Total	
	16.5	16.5		19.5	16.7	16.6		19.7	28.5 / 29.0

Frequency	Level	Pol	15.209 / 15.407		Detector	Azimuth	Height	Comments
MHz	dB $\mu$ V/m	v/h	Limit	Margin	Pk/QP/Avg	degrees	meters	
17313.920	61.2	H	68.3	-7.1	PK	159	0.9	RB 1 MHz;VB 3 MHz;Peak
1595.730	30.3	V	54.0	-23.7	AVG	92	1.3	RB 1 MHz;VB 10 Hz;Peak
1599.400	45.1	V	74.0	-28.9	PK	92	1.3	RB 1 MHz;VB 3 MHz;Peak
11618.400	44.4	V	54.0	-9.6	AVG	100	1.3	Noise floor
11610.600	55.6	V	74.0	-18.4	PK	100	1.3	RB 1 MHz;VB 3 MHz;Peak
1244.540	48.0	V	68.3	-20.3	PK	109	1.0	RB 1 MHz;VB 3 MHz;Peak
1000.000	26.7	V	54.0	-27.3	AVG	252	1.9	RB 1 MHz;VB 10 Hz;Peak
1000.030	43.9	V	74.0	-30.1	PK	252	1.9	RB 1 MHz;VB 3 MHz;Peak
1130.400	29.8	V	54.0	-24.2	AVG	303	1.3	RB 1 MHz;VB 10 Hz;Peak
1125.800	44.7	V	74.0	-29.3	PK	303	1.3	RB 1 MHz;VB 3 MHz;Peak
17309.130	60.6	V	68.3	-7.7	PK	160	1.0	RB 1 MHz;VB 3 MHz;Peak

Note: Scans made between 18 - 40 GHz with the measurement antenna moved around the card and its antennas 20-50cm from the device indicated there were no significant emissions in this frequency range

Client: Intel Corporation	Job Number: J94914
Model: 7265D2W	T-Log Number: T95472
	Project Manager: Christine Krebill
Contact: Steve Hackett	Project Coordinator: -
Standard: FCC Part 15.247, 15.407, RSS-210	Class: N/A

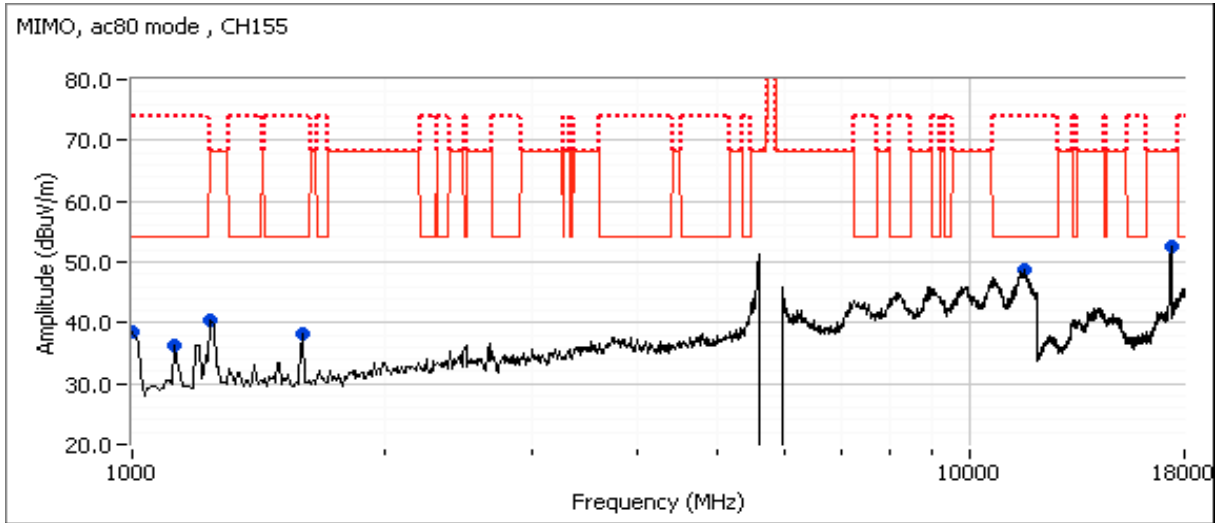



# EMC Test Data

Client:	Intel Corporation	Job Number:	J94914
Model:	7265D2W	T-Log Number:	T95472
Contact:	Steve Hackett	Project Manager:	Christine Krebill
Standard:	FCC Part 15.247, 15.407, RSS-210	Project Coordinator:	-
		Class:	N/A

Run #2: Radiated Spurious Emissions, 1,000 - 40000 MHz. Operating Mode: Worse case from Run #1  
 Date of Test: 6/13/2014 0:00 Config. Used: 1  
 Test Engineer: R. Varelas Config Change: None  
 Test Location: FT chamber 5 EUT Voltage: 120V

Run #2a: Low Channel

Channel: 151 Mode: n40  
 Tx Chain: A+B Data Rate: 13.5Mbps

Chain	Power Settings								Software Setting
	Target (dBm)				Measured (dBm)				
	A	B	C	Total	A	B	C	Total	
	16.5	16.5		19.5	16.7	16.6		19.7	34.0, 34.5

Frequency	Level	Pol	15.209 / 15.407		Detector	Azimuth	Height	Comments
MHz	dB $\mu$ V/m	v/h	Limit	Margin	Pk/QP/Avg	degrees	meters	
17249.070	62.4	H	68.3	-5.9	PK	239	1.0	RB 1 MHz;VB 3 MHz;Peak
23019.950	46.4	V	54.0	-7.6	AVG	150	1.0	Note 3
23019.820	55.8	V	74.0	-18.2	PK	150	1.0	RB 1 MHz;VB 3 MHz;Peak
1598.210	29.6	V	54.0	-24.4	AVG	299	0.9	RB 1 MHz;VB 10 Hz;Peak
1594.880	49.2	V	74.0	-24.8	PK	299	0.9	RB 1 MHz;VB 3 MHz;Peak
11526.600	44.5	V	54.0	-9.5	AVG	117	1.8	Noise floor
11500.330	55.3	V	74.0	-18.7	PK	117	1.8	RB 1 MHz;VB 3 MHz;Peak
1196.810	31.7	V	54.0	-22.3	AVG	249	0.9	RB 1 MHz;VB 10 Hz;Peak
1196.510	55.0	V	74.0	-19.0	PK	249	0.9	RB 1 MHz;VB 3 MHz;Peak

Note: Scans made between 18 - 40 GHz with the measurement antenna moved around the card and its antennas 20-50cm from the device indicated there were no significant emissions in this frequency range

Client: Intel Corporation	Job Number: J94914
Model: 7265D2W	T-Log Number: T95472
	Project Manager: Christine Krebill
Contact: Steve Hackett	Project Coordinator: -
Standard: FCC Part 15.247, 15.407, RSS-210	Class: N/A

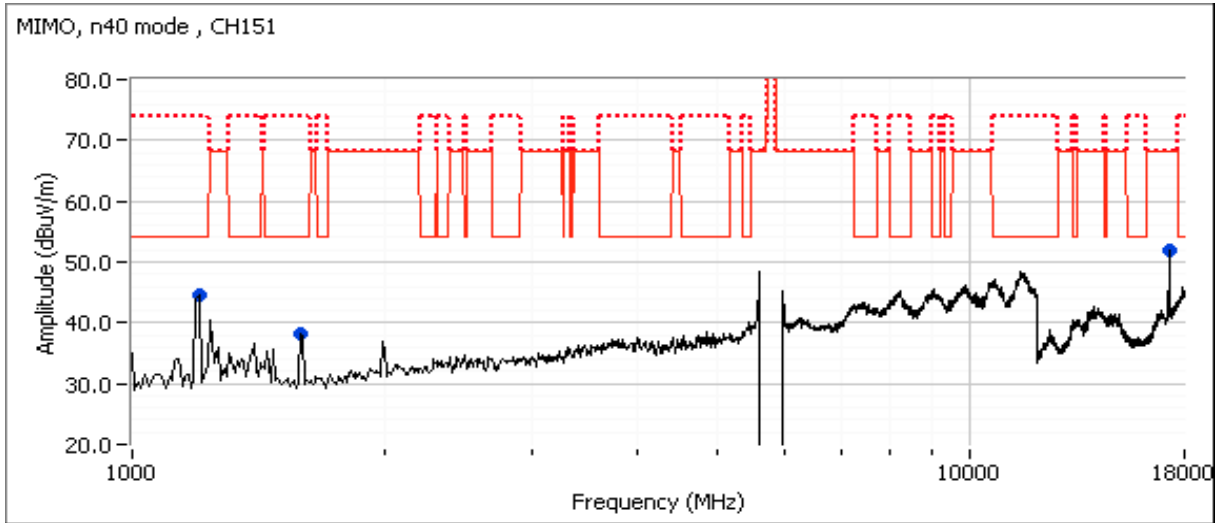





# EMC Test Data

Client: Intel Corporation	Job Number: J94914
Model: 7265D2W	T-Log Number: T95472
Contact: Steve Hackett	Project Manager: Christine Krebill
Standard: FCC Part 15.247, 15.407, RSS-210	Project Coordinator: -
	Class: N/A

Run #3: Radiated Spurious Emissions, 1,000 - 40000 MHz. Operating Mode: a mode  
 Date of Test: 7/8/2014 0:00 Config. Used: 1  
 Test Engineer: J. Liu Config Change: None  
 Test Location: FT chamber5 EUT Voltage: 120V

Channel: 165 Mode: a  
 Tx Chain: A Data Rate: 6.0Mbps

Power Settings		
Target (dBm)	Measured (dBm)	Software Setting
16.5	16.6	30.0

Frequency MHz	Level dB $\mu$ V/m	Pol v/h	15.209 / 15.407		Detector Pk/QP/Avg	Azimuth degrees	Height meters	Comments
			Limit	Margin				
17481.200	67.5	H	68.3	-0.8	PK	142	1.3	RB 1 MHz;VB 3 MHz;Peak
1597.800	27.5	V	54.0	-26.5	AVG	92	2.2	RB 1 MHz;VB 10 Hz;Peak
1596.800	44.6	V	74.0	-29.4	PK	92	2.2	RB 1 MHz;VB 3 MHz;Peak
1196.800	34.3	V	54.0	-19.7	AVG	302	1.0	RB 1 MHz;VB 10 Hz;Peak
1197.070	50.1	V	74.0	-23.9	PK	302	1.0	RB 1 MHz;VB 3 MHz;Peak
1247.870	29.7	H	54.0	-24.3	AVG	148	1.0	RB 1 MHz;VB 10 Hz;Peak; Note 1
1248.470	51.9	H	74.0	-22.1	PK	148	1.0	RB 1 MHz;VB 3 MHz;Peak; Note 1

Note: Scans made between 18 - 40 GHz with the measurement antenna moved around the card and its antennas 20-50cm from the device indicated there were no significant emissions in this frequency range

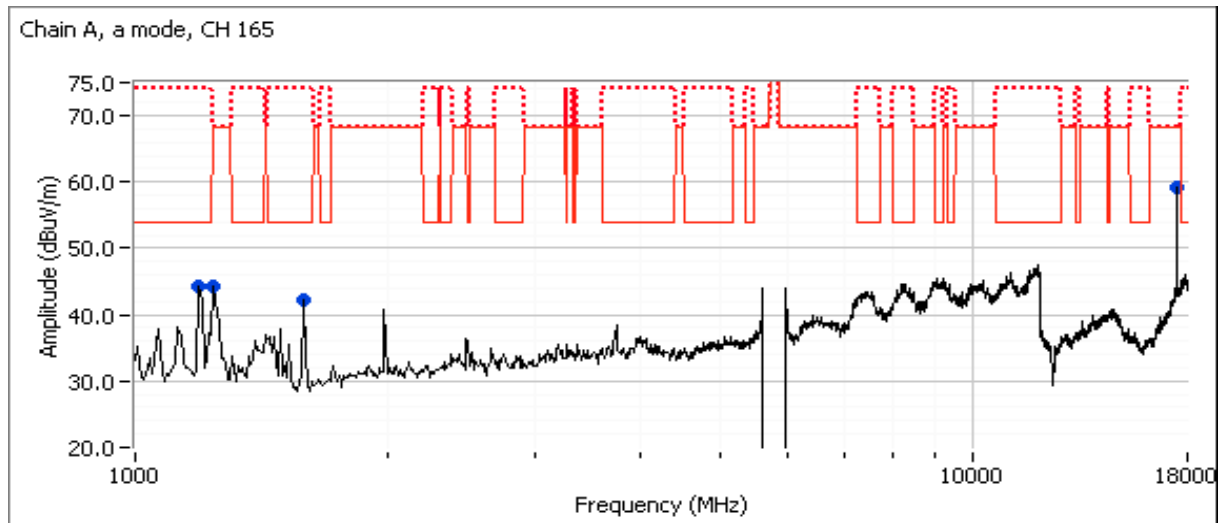



# EMC Test Data

Client:	Intel Corporation	Job Number:	J94914
Model:	7265D2W	T-Log Number:	T95472
Contact:	Steve Hackett	Project Manager:	Christine Krebill
Standard:	FCC Part 15.247, 15.407, RSS-210	Project Coordinator:	-
		Class:	N/A

## RSS 210 and FCC 15.247 (DTS) Radiated Spurious Emissions

### Test Specific Details

Objective: The objective of this test session is to perform final qualification testing of the EUT with respect to the specification listed above.

### General Test Configuration

The EUT and all local support equipment were located on the turntable for radiated spurious emissions testing. For radiated emissions testing the measurement antenna was located 3 meters from the EUT.

For Bluetooth: Tx is chain B, Rx is chain B. For WiFi, only Chain A is used for transmit in the 2.4GHz band when Bluetooth is active, both chains can be used in 5GHz bands.

### Ambient Conditions:

Temperature: 24 °C  
Rel. Humidity: 39 %

### Summary of Results

MAC Address: 001500F15B3A DRTU Tool Version 1.7.3-935 Driver version 17.1.0.11

Run #	Mode	Channel	Power Setting	Measured Power	Test Performed	Limit	Result / Margin
1	BT 1Mb/s 802.11b	2402MHz 2412MHz	10 14.5	4.8 17.6	Radiated Emissions 1- 10 GHz	FCC 15.247	56.8 dBµV/m @ 1199.1 MHz (-17.2 dB)
2	BT 1Mb/s 802.11b	2480MHz 2462MHz	10 14.0	5.0 17.7		FCC 15.247	43.5 dBµV/m @ 4924.0 MHz (-10.5 dB)
3	BT 1Mb/s 802.11g	2402MHz 2412MHz	10 20.5	4.8 17.7		FCC 15.247	56.3 dBµV/m @ 1196.0 MHz (-17.7 dB)
4	BT 1Mb/s 802.11g	2480MHz 2462MHz	10 19.5	5.0 17.5		FCC 15.247	53.3 dBµV/m @ 1198.7 MHz (-20.7 dB)



# EMC Test Data

Client:	Intel Corporation	Job Number:	J94914
Model:	7265D2W	T-Log Number:	T95472
Contact:	Steve Hackett	Project Manager:	Christine Krebill
Standard:	FCC Part 15.247, 15.407, RSS-210	Project Coordinator:	-
		Class:	N/A

Run #	Mode	Channel	Power Setting	Measured Power	Test Performed	Limit	Result / Margin
WiFi mode for the following runs based on worst case mode from runs 1 through 4							
5	BT 1Mb/s 802.11b	2402MHz 2437MHz	10 14	4.8 17.7	Radiated Emissions 1- 10 GHz	FCC 15.247	46.1 dBµV/m @ 2366.1 MHz (-7.9 dB)
6	BT 1Mb/s 802.11b	2440MHz 2412MHz	10 14.5	5.1 17.6		FCC 15.247	41.9 dBµV/m @ 2356.8 MHz (-12.1 dB)
7	BT 1Mb/s 802.11b	2440MHz 2462MHz	10 14	5.1 17.7	Radiated Emissions 1- 10 GHz	FCC 15.247	41.3 dBµV/m @ 4924.0 MHz (-12.7 dB)
8	BT 1Mb/s 802.11b	2480MHz 2437MHz	10 14	5.0 17.7		FCC 15.247	41.1 dBµV/m @ 4874.0 MHz (-12.9 dB)
WiFi mode and channel and Bluetooth channel based on the worst case mode from runs 1 through 8							
9	BT 3Mb/s 802.11b	2440 MHz 2462 MHz	6 14	1.2 17.7	Radiated Emissions 1- 10 GHz	FCC 15.247	41.4 dBµV/m @ 4924.0 MHz (-12.6 dB)
10	BTLE 802.11b	2440 MHz 2462 MHz	Default 14	3.2 17.7		FCC 15.247	43.5 dBµV/m @ 4924.0 MHz (-10.5 dB)
WiFi mode - 802.11n 20MHz with both chains active at 16.5 dBm per chain, center channel in each 5GHz band. Bluetooth on center channel, 1Mb/s mode							
11	BT 1Mb/s 802.11n20	2440MHz 5200MHz	10 31.0 / 32.0	5.1 16.6 / 16.5	Radiated Emissions 1- 15 GHz	FCC 15.247	No intermodulation founded Other Emissions refer to the spurious RE results
12	BT 1Mb/s 802.11n20	2440MHz 5300MHz	10 32.0 / 33.0	5.1 16.6 / 16.5		FCC 15.247	No intermodulation founded Other Emissions refer to the spurious RE results
13	BT 1Mb/s 802.11n20	2440MHz 5580MHz	10 28.5 / 29.5	5.1 16.5 / 16.6		FCC 15.247	No intermodulation founded Other Emissions refer to the spurious RE results
14	BT 1Mb/s 802.11n20	2440MHz 5785MHz	10 34.5 / 35.5	5.1 16.7 / 16.5		FCC 15.247	No intermodulation founded Other Emissions refer to the spurious RE results



# EMC Test Data

Client:	Intel Corporation	Job Number:	J94914
Model:	7265D2W	T-Log Number:	T95472
Contact:	Steve Hackett	Project Manager:	Christine Krebill
Standard:	FCC Part 15.247, 15.407, RSS-210	Project Coordinator:	-
		Class:	N/A

### Modifications Made During Testing

No modifications were made to the EUT during testing

### Deviations From The Standard

No deviations were made from the requirements of the standard.

### Notes:

Bluetooth uses a frequency hopping algorithm that means that the device, during normal operation, is only on a specific channel for a short period of time. The average correction factor is calculated as follows:

A maximum length packet has a duration of 5 time slots.

The hopping rate is 1600 hops/second so the maximum dwell time is 5/1600 seconds, or 3.125ms.

With a minimum of 20 hopping channels a channel will not be used more than 4 times in any 100ms period.

The maximum dwell time in a 100ms period is  $4 \times 3.125\text{ms} = 12.5\text{ms}$ .

The average correction factor is, therefore,  $20\log(12.5/100) = -18\text{dB}$

As this is a hopping radio this correction factor can be applied to the average value of the signal provided the average value was measured with the device continuously transmitting. DA 00-0705 permits the use of the average correction on the measured average value for frequency hopping radios.

All measurements in this data sheet do not include the average correction factor.

Antenna: Skycross WiMax/WLAN



# EMC Test Data

Client: Intel Corporation	Job Number: J94914
Model: 7265D2W	T-Log Number: T95472
	Project Manager: Christine Krebill
Contact: Steve Hackett	Project Coordinator: -
Standard: FCC Part 15.247, 15.407, RSS-210	Class: N/A

Run #1: 1-10GHz, 802.11b @ 2412 MHz Chain A, BT Basic Rate @ 2402 MHz Chain B  
 Date of Test: 6/18/2014 Test Location: FT Chamber #4  
 Test Engineer: Jack Liu Config Change: None

	Target (dBm)	Power Settings Measured (dBm)	Software Setting
Chain A	16.5	17.6	14.5
Chain B	-	4.8	10.0

Note - measured power in table above is average power, for reference only.

Perform normal 1-10 GHz scan with filter for fundamental and then 2-3 GHz scan 20-30 cm from the product without filter.

**Preliminary Measurements (Peak versus average limit)**

Frequency	Level	Pol	15.209/15.247		Detector	Azimuth	Height	Comments
MHz	dB $\mu$ V/m	v/h	Limit	Margin	Pk/QP/Avg	degrees	meters	
1200.000	46.6	V	54.0	-7.4	Peak	220	1.0	
1825.000	52.6	V	70.0	-17.4	Peak	60	2.2	
1591.670	42.4	V	54.0	-11.6	Peak	260	1.6	

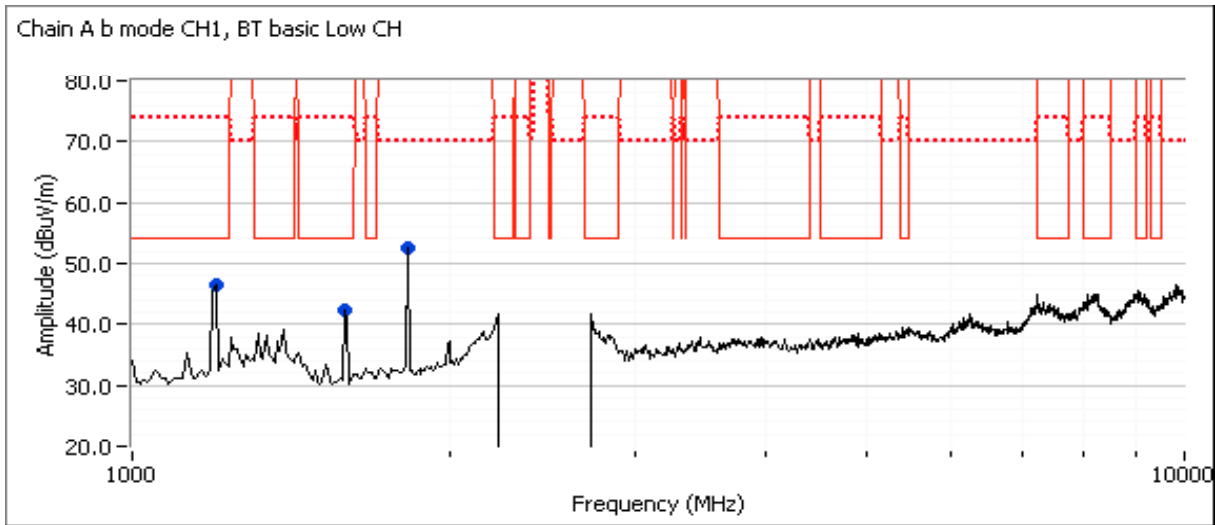



# EMC Test Data

Client: Intel Corporation	Job Number: J94914
Model: 7265D2W	T-Log Number: T95472
Contact: Steve Hackett	Project Manager: Christine Krebill
Standard: FCC Part 15.247, 15.407, RSS-210	Project Coordinator: -
	Class: N/A

### Spurious Emissions excluding allocated band (final measurements at 3m)

Frequency	Level	Pol	15.209 / 15.247		Detector	Azimuth	Height	Comments
MHz	dB $\mu$ V/m	v/h	Limit	Margin	PK/QP/Avg	degrees	meters	
1196.800	31.4	V	54.0	-22.6	AVG	237	1.0	RB 1 MHz;VB 10 Hz;Peak
1199.130	56.8	V	74.0	-17.2	PK	237	1.0	RB 1 MHz;VB 3 MHz;Peak
1819.800	27.3	V	54.0	-26.7	AVG	195	1.9	Note 2
1819.600	39.2	V	74.0	-34.8	PK	195	1.9	Note 2
1594.340	31.2	V	54.0	-22.8	AVG	61	1.6	RB 1 MHz;VB 10 Hz;Peak
1594.940	47.0	V	74.0	-27.0	PK	61	1.6	RB 1 MHz;VB 3 MHz;Peak

### Preliminary Measurements (Peak versus average limit) at 20-30cm from EUT

Frequency	Level	Pol	15.209/15.247		Detector	Azimuth	Height	Comments
MHz	dB $\mu$ V/m	v/h	Limit	Margin	PK/QP/Avg	degrees	meters	
2460.920	55.9	H	-	-	Peak	180	1.0	In band intermittent signal
2573.150	43.6	H	54.0	-10.4	Peak	180	1.0	Note 2

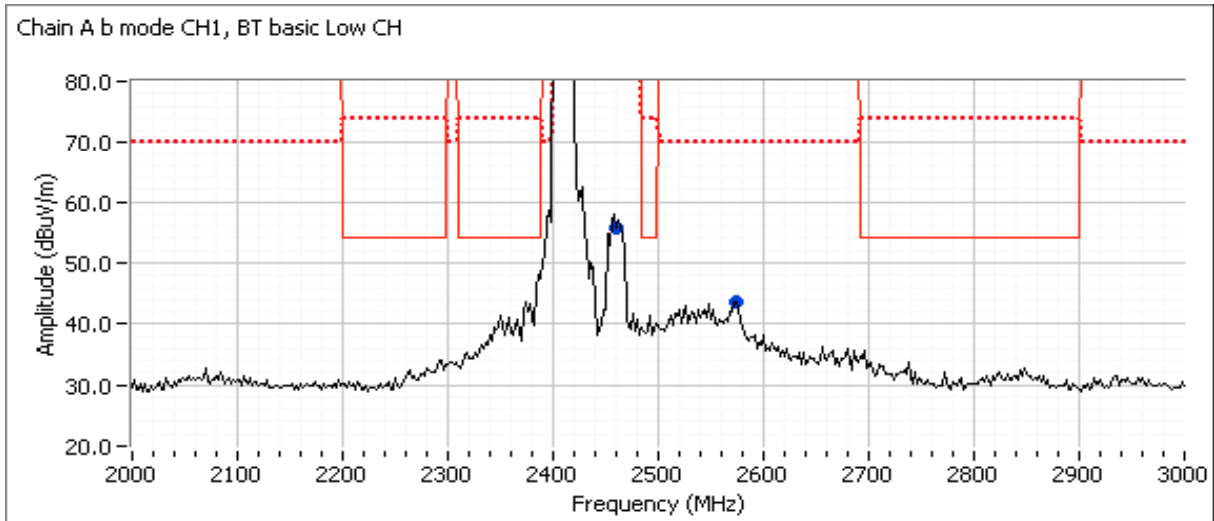

### Spurious Emissions near allocated band (final measurements at 3m)

Frequency	Level	Pol	15.209 / 15.247		Detector	Azimuth	Height	Comments
MHz	dB $\mu$ V/m	v/h	Limit	Margin	PK/QP/Avg	degrees	meters	
2573.150	43.6	H	54.0	-10.4	Peak	180	1.0	Note 2

No intermodulation founded

- Note 1: For emissions in restricted bands, the limit of 15.209 was used. For all other emissions, the limit was set 20dB below the level of the fundamental and measured in 100kHz.
- Note 2: Signal is not in a restricted band but the more stringent restricted band limit was used.
- Note 3: Signal is only present when Bluetooth is enabled, average correction for hopping occupancy could be applied



# EMC Test Data

Client: Intel Corporation	Job Number: J94914
Model: 7265D2W	T-Log Number: T95472
	Project Manager: Christine Krebill
Contact: Steve Hackett	Project Coordinator: -
Standard: FCC Part 15.247, 15.407, RSS-210	Class: N/A

Run #2: 1-10GHz, 802.11b @ 2462 MHz Chain A, BT Basic Rate @ 2480 MHz Chain B  
 Date of Test: 6/18/2014 Test Location: FT Chamber #4  
 Test Engineer: Jack Liu / R. Varelas Config Change: None

	Target (dBm)	Power Settings	
		Measured (dBm)	Software Setting
Chain A	16.5	17.7	14.0
Chain B	-	5.0	10.0

Note - measured power in table above is average power, for reference only.

Perform normal 1-10 GHz scan with filter for fundamental and then 2-3 GHz scan 20-30 cm from the product without filter.

**Preliminary Measurements (Peak versus average limit)**

Frequency	Level	Pol	15.209/15.247		Detector	Azimuth	Height	Comments
MHz	dB $\mu$ V/m	v/h	Limit	Margin	PK/QP/Avg	degrees	meters	
1191.670	43.8	H	54.0	-10.2	Peak	113	1.5	
1591.670	38.7	V	54.0	-15.3	Peak	126	2.0	
4925.000	46.2	V	54.0	-7.8	Peak	143	1.5	

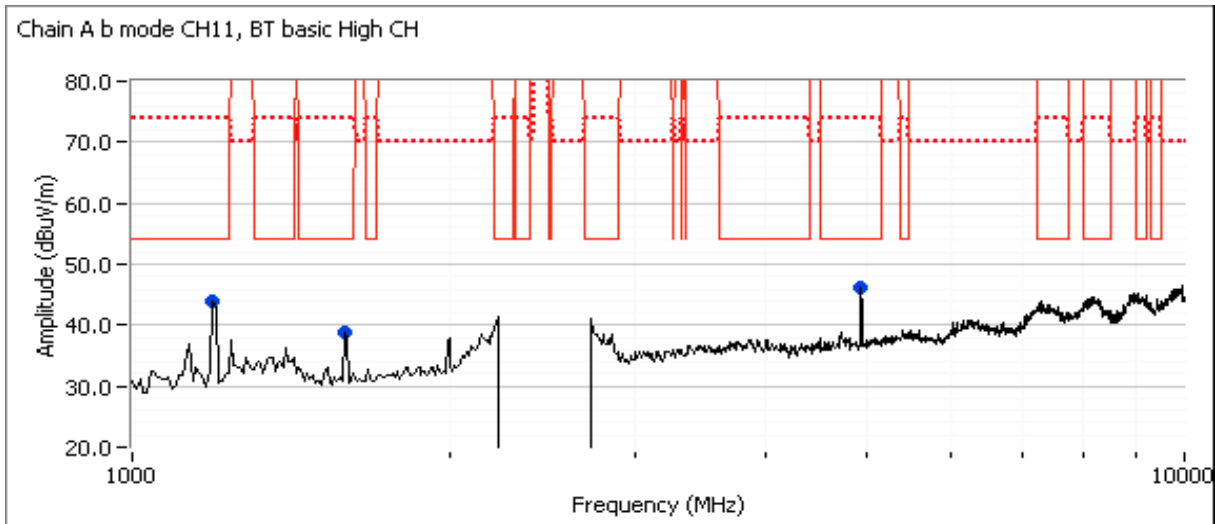



# EMC Test Data

Client: Intel Corporation	Job Number: J94914
Model: 7265D2W	T-Log Number: T95472
Contact: Steve Hackett	Project Manager: Christine Krebill
Standard: FCC Part 15.247, 15.407, RSS-210	Project Coordinator: -
	Class: N/A

### Spurious Emissions excluding allocated band (final measurements at 3m)

Frequency MHz	Level dB $\mu$ V/m	Pol v/h	15.209 / 15.247		Detector Pk/QP/Avg	Azimuth degrees	Height meters	Comments
			Limit	Margin				
4923.980	43.5	V	54.0	-10.5	AVG	207	1.0	RB 1 MHz;VB 10 Hz;Peak
4924.070	49.0	V	74.0	-25.0	PK	207	1.0	RB 1 MHz;VB 3 MHz;Peak
1174.670	30.3	H	54.0	-23.7	AVG	252	1.7	RB 1 MHz;VB 10 Hz;Peak
1195.670	48.7	H	74.0	-25.3	PK	252	1.7	RB 1 MHz;VB 3 MHz;Peak
1597.800	30.3	V	54.0	-23.7	AVG	284	1.8	RB 1 MHz;VB 10 Hz;Peak
1597.470	48.6	V	74.0	-25.4	PK	284	1.8	RB 1 MHz;VB 3 MHz;Peak

### Preliminary Measurements (Peak versus average limit) at 20-30cm from EUT

Frequency MHz	Level dB $\mu$ V/m	Pol v/h	15.209/15.247		Detector Pk/QP/Avg	Azimuth degrees	Height meters	Comments
			Limit	Margin				
2488.980	53.1	H	-	-	Peak	180	1.0	Refer to Band Edge test result
2623.250	41.0	H	54.0	-13.0	Peak	180	1.0	Note 2

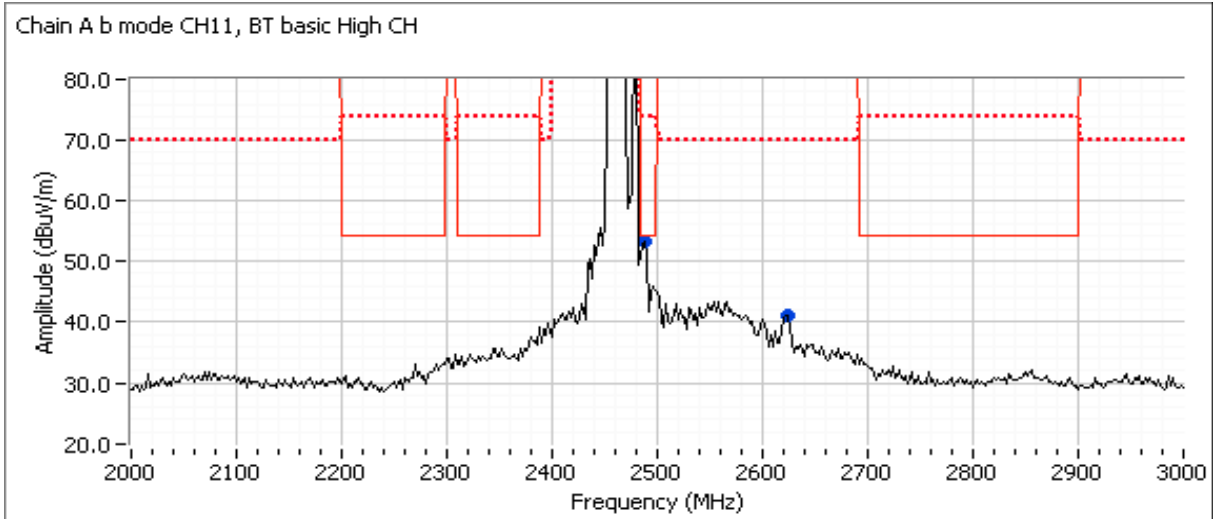

### Spurious Emissions near allocated band (final measurements at 3m)

Frequency MHz	Level dB $\mu$ V/m	Pol v/h	15.209 / 15.247		Detector Pk/QP/Avg	Azimuth degrees	Height meters	Comments
			Limit	Margin				
2623.250	41.0	H	54.0	-13.0	Peak	180	1.0	Note 2

No intermodulation founded

- Note 1: For emissions in restricted bands, the limit of 15.209 was used. For all other emissions, the limit was set 20dB below the level of the fundamental and measured in 100kHz.
- Note 2: Signal is not in a restricted band but the more stringent restricted band limit was used.
- Note 3: Signal is only present when Bluetooth is enabled, average correction for hopping occupancy could be applied.





# EMC Test Data

Client: Intel Corporation	Job Number: J94914
Model: 7265D2W	T-Log Number: T95472
	Project Manager: Christine Krebill
Contact: Steve Hackett	Project Coordinator: -
Standard: FCC Part 15.247, 15.407, RSS-210	Class: N/A

Run #3: 1-10GHz, 802.11g @ 2412 MHz Chain A, BT Basic Rate @ 2402 MHz Chain B  
 Date of Test: 6/18/2014 Test Location: FT Chamber #4  
 Test Engineer: Jack Liu / R. Varelas Config Change: None

	Power Settings		
	Target (dBm)	Measured (dBm)	Software Setting
Chain A	14.0	17.7	20.5
Chain B	-	5.0	10.0

Note - measured power in table above is average power, for reference only.

Perform normal 1-10 GHz scan with filter for fundamental and then 2-3 GHz scan 20-30 cm from the product without filter.

**Preliminary Measurements (Peak versus average limit)**

Frequency	Level	Pol	15.209/15.247		Detector	Azimuth	Height	Comments
MHz	dB $\mu$ V/m	v/h	Limit	Margin	Pk/QP/Avg	degrees	meters	
1191.670	46.3	V	54.0	-7.7	Peak	232	1.0	
1241.670	40.0	H	70.0	-30.0	Peak	216	1.0	
1591.670	40.4	V	54.0	-13.6	Peak	108	2.0	

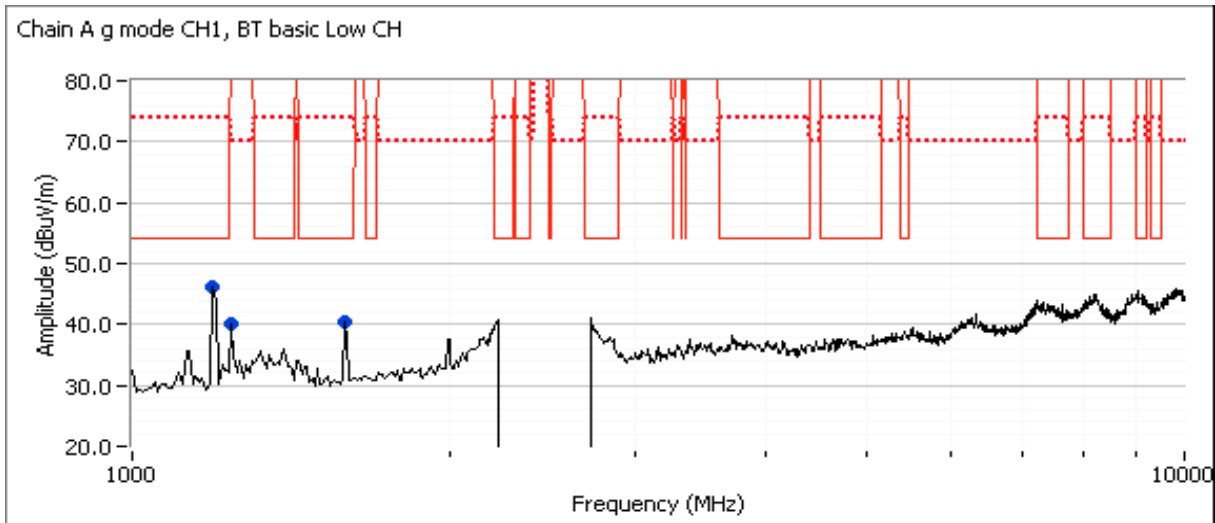



# EMC Test Data

Client: Intel Corporation	Job Number: J94914
Model: 7265D2W	T-Log Number: T95472
Contact: Steve Hackett	Project Manager: Christine Krebill
Standard: FCC Part 15.247, 15.407, RSS-210	Project Coordinator: -
	Class: N/A

### Spurious Emissions excluding allocated band (final measurements at 3m)

Frequency MHz	Level dB $\mu$ V/m	Pol v/h	15.209 / 15.247		Detector Pk/QP/Avg	Azimuth degrees	Height meters	Comments
			Limit	Margin				
1197.000	31.8	V	54.0	-22.2	AVG	227	1.0	RB 1 MHz;VB 10 Hz;Peak
1196.000	56.3	V	74.0	-17.7	PK	227	1.0	RB 1 MHz;VB 3 MHz;Peak
1260.940	29.1	H	54.0	-24.9	AVG	129	1.4	Note 2
1241.070	42.8	H	74.0	-31.2	PK	129	1.4	Note 2
1594.540	30.9	V	54.0	-23.1	AVG	80	1.5	RB 1 MHz;VB 10 Hz;Peak
1594.070	46.2	V	74.0	-27.8	PK	80	1.5	RB 1 MHz;VB 3 MHz;Peak

### Preliminary Measurements (Peak versus average limit) at 20-30cm from EUT

Frequency MHz	Level dB $\mu$ V/m	Pol v/h	15.209/15.247		Detector Pk/QP/Avg	Azimuth degrees	Height meters	Comments
			Limit	Margin				
2462.930	55.3	V	-	-	Peak	180	1.0	In band intermittent signal
2384.770	54.8	V	-	-	Peak	180	1.0	Refer to Band Edge test result

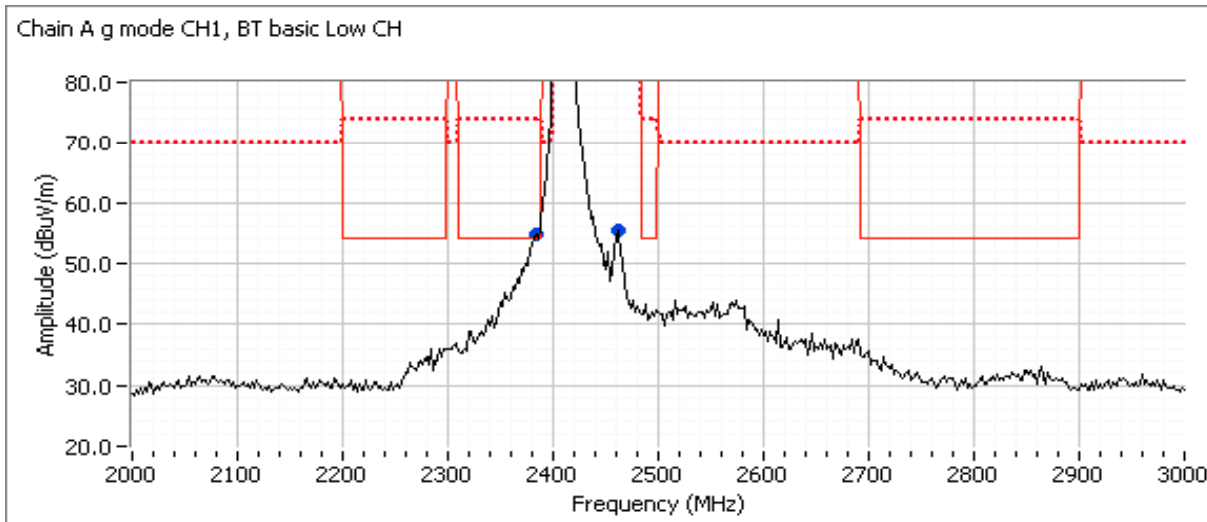

### Spurious Emissions near allocated band (final measurements at 3m)

Frequency MHz	Level dB $\mu$ V/m	Pol v/h	15.209 / 15.247		Detector Pk/QP/Avg	Azimuth degrees	Height meters	Comments
			Limit	Margin				

No intermodulation founded

- Note 1: For emissions in restricted bands, the limit of 15.209 was used. For all other emissions, the limit was set 20dB below the level of the fundamental and measured in 100kHz.
- Note 2: Signal is not in a restricted band but the more stringent restricted band limit was used.
- Note 3: Signal is only present when Bluetooth is enabled, average correction for hopping occupancy could be applied



# EMC Test Data

Client: Intel Corporation	Job Number: J94914
Model: 7265D2W	T-Log Number: T95472
	Project Manager: Christine Krebill
Contact: Steve Hackett	Project Coordinator: -
Standard: FCC Part 15.247, 15.407, RSS-210	Class: N/A

Run #4: 1-10GHz, 802.11g @ 2462 MHz Chain A, BT Basic Rate @ 2480 MHz Chain B  
 Date of Test: 6/18/2014 Test Location: FT Chamber #4  
 Test Engineer: Jack Liu / R. Varelas Config Change: None

	Power Settings		
	Target (dBm)	Measured (dBm)	Software Setting
Chain A	12.5	17.5	19.5
Chain B	-	5.0	10.0

Note - measured power in table above is average power, for reference only.

Perform normal 1-10 GHz scan with filter for fundamental and then 2-3 GHz scan 20-30 cm from the product without filter.

### Preliminary Measurements (Peak versus average limit)

Frequency	Level	Pol	15.209/15.247		Detector	Azimuth	Height	Comments
MHz	dB $\mu$ V/m	v/h	Limit	Margin	PK/QP/Avg	degrees	meters	
1600.000	40.2	V	54.0	-13.8	Peak	221	1.5	
1200.000	43.9	V	54.0	-10.1	Peak	259	1.0	

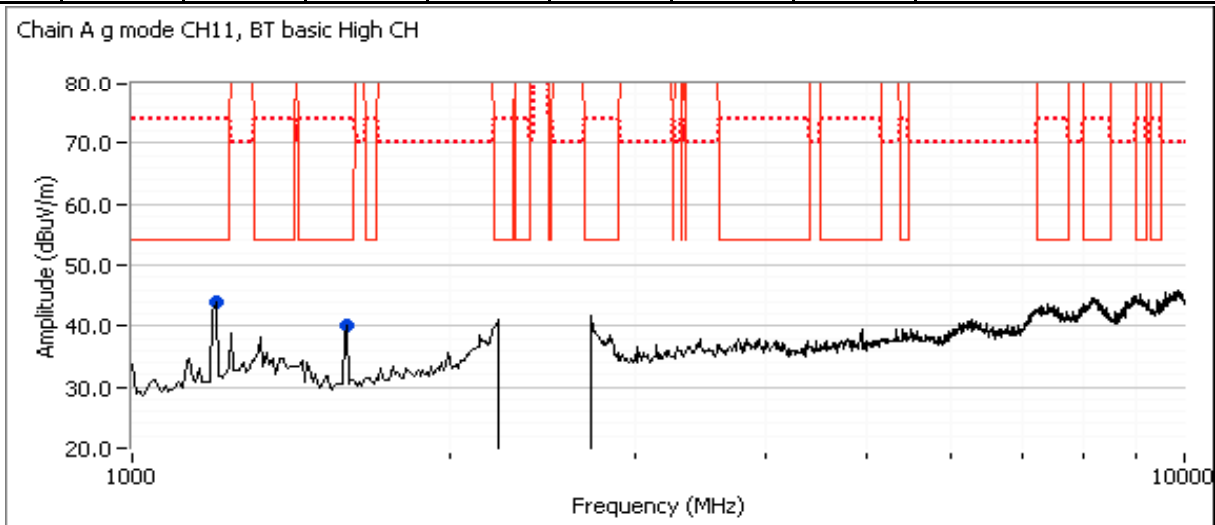

### Spurious Emissions excluding allocated band (final measurements at 3m)

Frequency	Level	Pol	15.209 / 15.247		Detector	Azimuth	Height	Comments
MHz	dB $\mu$ V/m	v/h	Limit	Margin	PK/QP/Avg	degrees	meters	
1598.670	31.1	V	54.0	-22.9	AVG	62	1.5	RB 1 MHz;VB 10 Hz;Peak
1593.930	47.7	V	74.0	-26.3	PK	62	1.5	RB 1 MHz;VB 3 MHz;Peak
1202.800	32.9	V	54.0	-21.1	AVG	268	1.2	RB 1 MHz;VB 10 Hz;Peak
1198.730	53.3	V	74.0	-20.7	PK	268	1.2	RB 1 MHz;VB 3 MHz;Peak



# EMC Test Data

Client: Intel Corporation	Job Number: J94914
Model: 7265D2W	T-Log Number: T95472
Contact: Steve Hackett	Project Manager: Christine Krebill
Standard: FCC Part 15.247, 15.407, RSS-210	Project Coordinator: -
	Class: N/A

### Preliminary Measurements (Peak versus average limit) at 20-30cm from EUT

Frequency	Level	Pol	15.209/15.247		Detector	Azimuth	Height	Comments
MHz	dB $\mu$ V/m	v/h	Limit	Margin	Pk/QP/Avg	degrees	meters	
2490.980	55.6	V	-	-	Peak	180	1.0	Refer to Band Edge test result

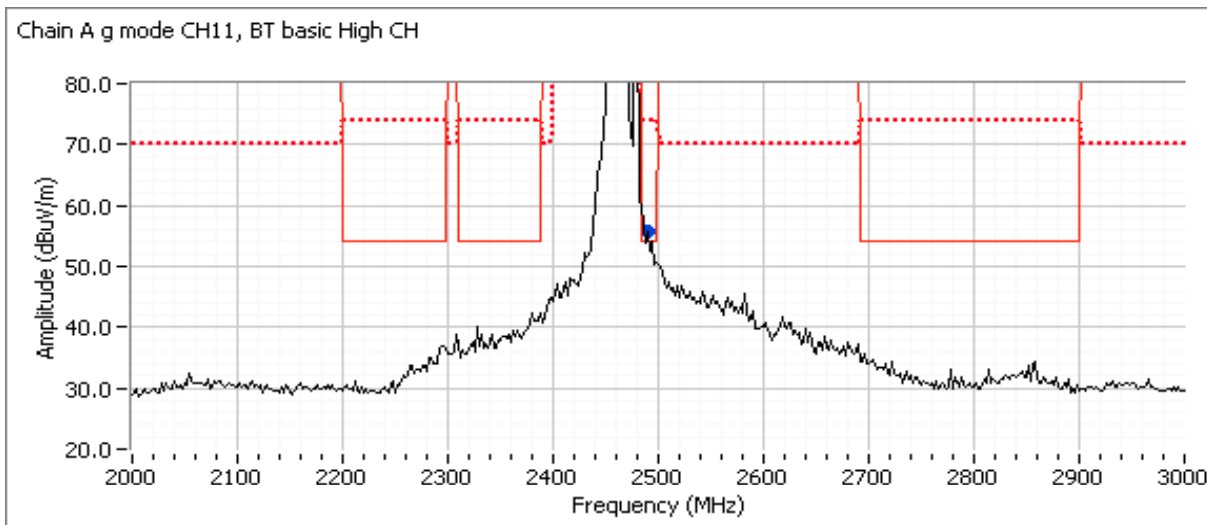

### Spurious Emissions near allocated band (final measurements at 3m)

Frequency	Level	Pol	15.209 / 15.247		Detector	Azimuth	Height	Comments
MHz	dB $\mu$ V/m	v/h	Limit	Margin	Pk/QP/Avg	degrees	meters	

No intermodulation founded

- Note 1: For emissions in restricted bands, the limit of 15.209 was used. For all other emissions, the limit was set 20dB below the level of the fundamental and measured in 100kHz.
- Note 2: Signal is not in a restricted band but the more stringent restricted band limit was used.
- Note 3: Signal is only present when Bluetooth is enabled, average correction for hopping occupancy could be applied



# EMC Test Data

Client: Intel Corporation	Job Number: J94914
Model: 7265D2W	T-Log Number: T95472
	Project Manager: Christine Krebill
Contact: Steve Hackett	Project Coordinator: -
Standard: FCC Part 15.247, 15.407, RSS-210	Class: N/A

Run #5: 1-10GHz, 802.11b @ 2437 MHz Chain A, BT Basic Rate @ 2402 MHz Chain B  
 Date of Test: 6/19/2014 Test Location: FT Chamber 4  
 Test Engineer: Jack Liu / R. Varelas Config Change: None

	Target (dBm)	Power Settings Measured (dBm)	Software Setting
Chain A	17.5	17.7	14.0
Chain B	-	4.8	10.0

Note - measured power in table above is average power, for reference only.

Perform normal 1-10 GHz scan with filter for fundamental and then 2-3 GHz scan 20-30 cm from the product without filter.

### Preliminary Measurements (Peak versus average limit)

Frequency	Level	Pol	15.209/15.247		Detector	Azimuth	Height	Comments
MHz	dB $\mu$ V/m	v/h	Limit	Margin	PK/QP/Avg	degrees	meters	
1195.120	44.6	H	54.0	-9.4	Peak	114	1.3	
1594.440	41.2	V	54.0	-12.8	Peak	227	1.6	
4874.170	42.4	V	54.0	-11.6	Peak	141	1.3	

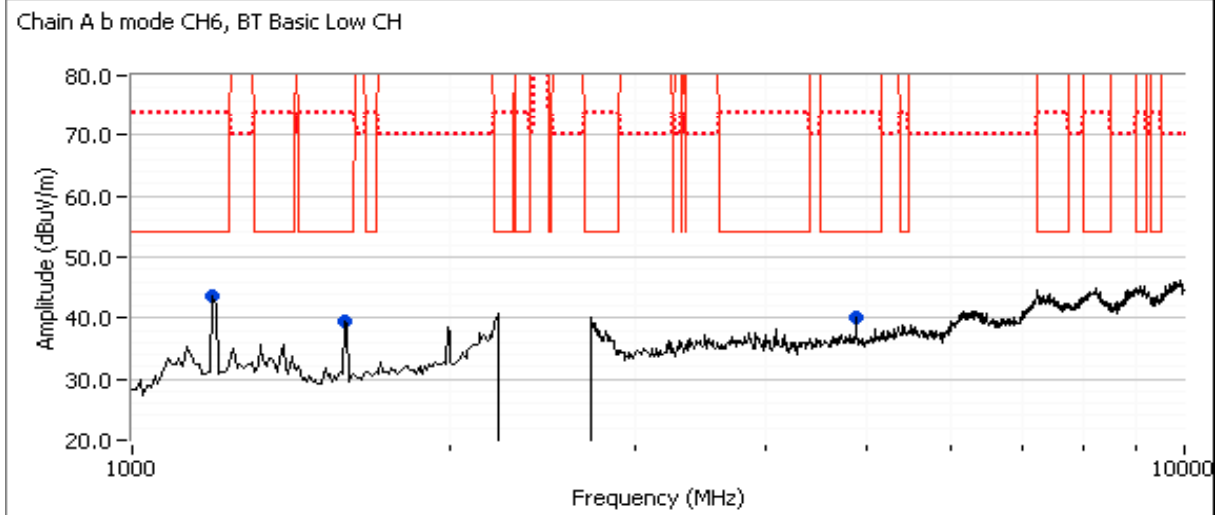

### Spurious Emissions excluding allocated band (final measurements at 3m)

Frequency	Level	Pol	15.209 / 15.247		Detector	Azimuth	Height	Comments
MHz	dB $\mu$ V/m	v/h	Limit	Margin	PK/QP/Avg	degrees	meters	
4873.970	40.2	V	54.0	-13.8	AVG	154	1.9	RB 1 MHz;VB 10 Hz;Peak
4873.870	46.9	V	74.0	-27.1	PK	154	1.9	RB 1 MHz;VB 3 MHz;Peak
1594.510	30.4	V	54.0	-23.6	AVG	223	1.3	RB 1 MHz;VB 10 Hz;Peak
1596.370	46.1	V	74.0	-27.9	PK	223	1.3	RB 1 MHz;VB 3 MHz;Peak
1196.570	30.7	H	54.0	-23.3	AVG	116	1.6	RB 1 MHz;VB 10 Hz;Peak
1194.630	53.7	H	74.0	-20.3	PK	116	1.6	RB 1 MHz;VB 3 MHz;Peak



# EMC Test Data

Client: Intel Corporation	Job Number: J94914
Model: 7265D2W	T-Log Number: T95472
Contact: Steve Hackett	Project Manager: Christine Krebill
Standard: FCC Part 15.247, 15.407, RSS-210	Project Coordinator: -
	Class: N/A

### Preliminary Measurements (Peak versus average limit) at 100cm from EUT

Frequency	Level	Pol	15.209/15.247		Detector	Azimuth	Height	Comments
MHz	dB $\mu$ V/m	v/h	Limit	Margin	Pk/QP/Avg	degrees	meters	
2368.740	49.2	H	54.0	-4.8	Peak	210	1.5	

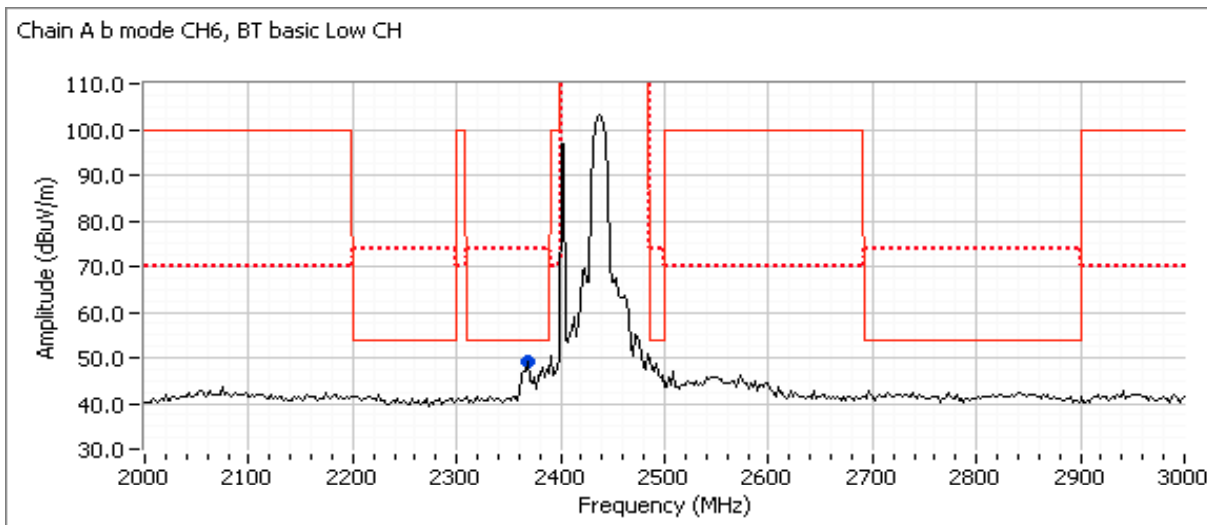

### Spurious Emissions near allocated band (final measurements at 3m)

Frequency	Level	Pol	15.209 / 15.247		Detector	Azimuth	Height	Comments
MHz	dB $\mu$ V/m	v/h	Limit	Margin	Pk/QP/Avg	degrees	meters	
2366.050	46.1	H	54.0	-7.9	AVG	155	1.4	POS; RB 1 MHz; VB: 10 Hz
2366.300	54.2	H	74.0	-19.8	PK	155	1.4	POS; RB 1 MHz; VB: 3 MHz

- Note 1: For emissions in restricted bands, the limit of 15.209 was used. For all other emissions, the limit was set 20dB below the level of the fundamental and measured in 100kHz.
- Note 1: For emissions in restricted bands, the limit of 15.209 was used. For all other emissions, the limit was set 30dB below the level of the fundamental and measured in 100kHz.
- Note 2: Signal is not in a restricted band but the more stringent restricted band limit was used.
- Note 3: Signal is only present when Bluetooth is enabled, average correction for hopping occupancy could be applied



# EMC Test Data

Client:	Intel Corporation	Job Number:	J94914
Model:	7265D2W	T-Log Number:	T95472
Contact:	Steve Hackett	Project Manager:	Christine Krebill
Standard:	FCC Part 15.247, 15.407, RSS-210	Project Coordinator:	-
		Class:	N/A

Run #6: 1-10GHz, 802.11b @ 2412 MHz Chain A, BT Basic Rate @ 2440 MHz Chain B  
 Date of Test: 6/19/2014 Test Location: FT Chamber 4  
 Test Engineer: Jack Liu Config Change: None

	Target (dBm)	Power Settings	
		Measured (dBm)	Software Setting
Chain A	16.5	17.6	14.5
Chain B	-	5.1	10.0

Note - measured power in table above is average power, for reference only.

Perform normal 1-10 GHz scan with filter for fundamental and then 2-3 GHz scan 20-30 cm from the product without filter.

### Preliminary Measurements (Peak versus average limit)

Frequency	Level	Pol	15.209/15.247		Detector	Azimuth	Height	Comments
MHz	dB $\mu$ V/m	v/h	Limit	Margin	PK/QP/Avg	degrees	meters	
1198.140	44.7	V	54.0	-9.3	Peak	275	1.3	
1590.120	40.7	V	54.0	-13.3	Peak	87	1.9	

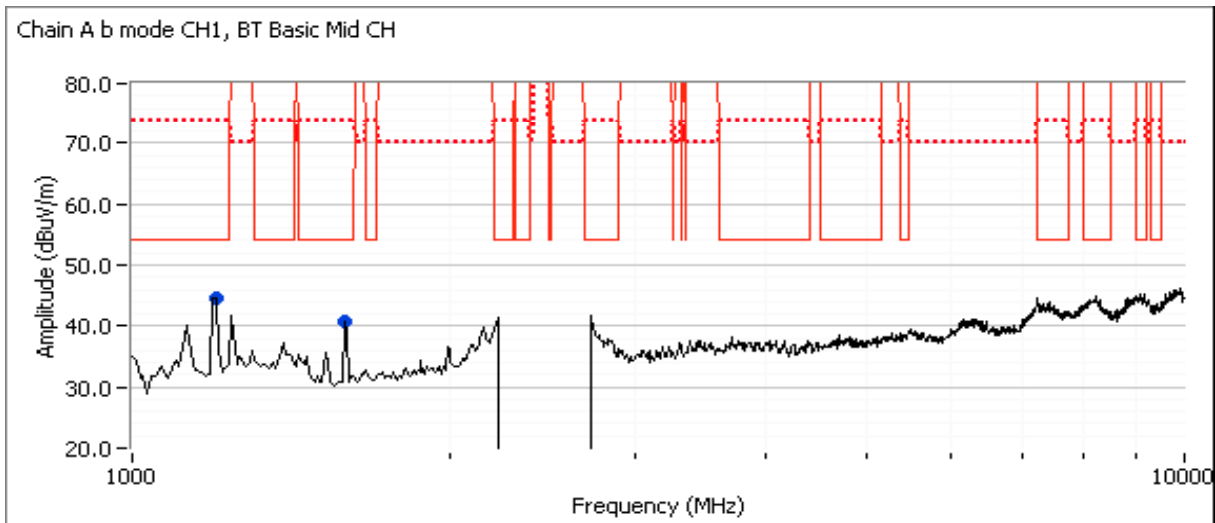

### Spurious Emissions excluding allocated band (final measurements at 3m)

Frequency	Level	Pol	15.209 / 15.247		Detector	Azimuth	Height	Comments
MHz	dB $\mu$ V/m	v/h	Limit	Margin	PK/QP/Avg	degrees	meters	
1198.160	31.0	V	54.0	-23.0	AVG	277	1.0	RB 1 MHz;VB 10 Hz;Peak
1199.340	50.0	V	74.0	-24.0	PK	277	1.0	RB 1 MHz;VB 3 MHz;Peak
1591.090	28.8	V	54.0	-25.2	AVG	93	1.0	RB 1 MHz;VB 10 Hz;Peak
1590.570	41.2	V	74.0	-32.8	PK	93	1.0	RB 1 MHz;VB 3 MHz;Peak



# EMC Test Data

Client: Intel Corporation	Job Number: J94914
Model: 7265D2W	T-Log Number: T95472
Contact: Steve Hackett	Project Manager: Christine Krebill
Standard: FCC Part 15.247, 15.407, RSS-210	Project Coordinator: -
	Class: N/A

### Preliminary Measurements (Peak versus average limit) at 100cm from EUT

Frequency	Level	Pol	15.209/15.247		Detector	Azimuth	Height	Comments
MHz	dB $\mu$ V/m	v/h	Limit	Margin	Pk/QP/Avg	degrees	meters	
2386.770	52.5	H	-	-	Peak	203	1.0	Refer to Band Edge test result
2352.710	44.9	H	54.0	-9.1	Peak	204	1.5	

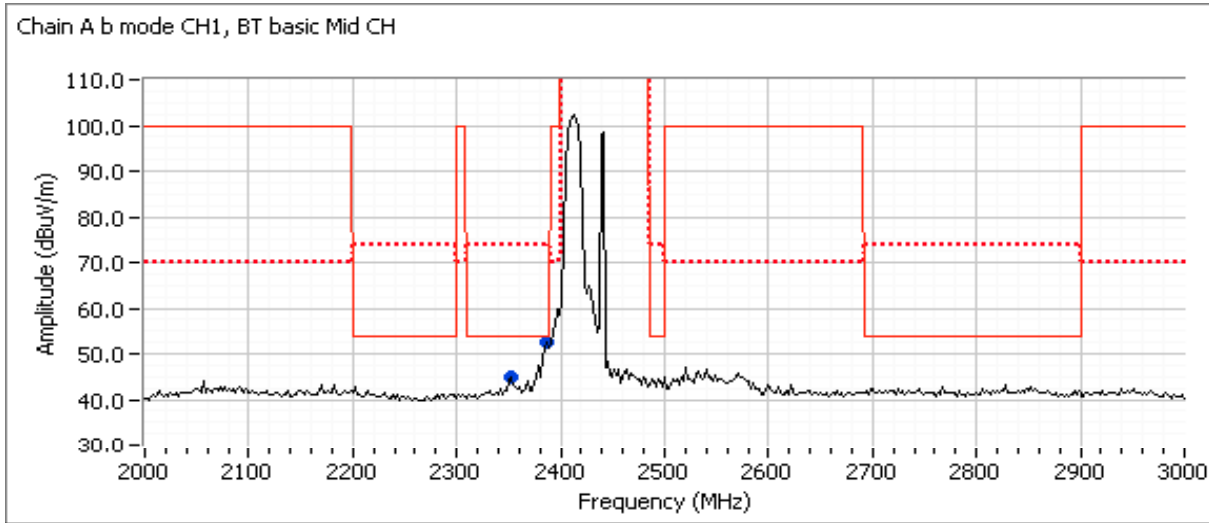

### Spurious Emissions near allocated band (final measurements at 3m)

Frequency	Level	Pol	15.209 / 15.247		Detector	Azimuth	Height	Comments
MHz	dB $\mu$ V/m	v/h	Limit	Margin	Pk/QP/Avg	degrees	meters	
2356.760	41.9	H	54.0	-12.1	AVG	204	1.6	POS; RB 1 MHz; VB: 10 Hz
2356.600	51.1	H	74.0	-22.9	PK	204	1.6	POS; RB 1 MHz; VB: 3 MHz

- Note 1: For emissions in restricted bands, the limit of 15.209 was used. For all other emissions, the limit was set 20dB below the level of the fundamental and measured in 100kHz.
- Note 1: For emissions in restricted bands, the limit of 15.209 was used. For all other emissions, the limit was set 30dB below the level of the fundamental and measured in 100kHz.
- Note 2: Signal is not in a restricted band but the more stringent restricted band limit was used.
- Note 3: Signal is only present when Bluetooth is enabled, average correction for hopping occupancy could be applied





# EMC Test Data

Client:	Intel Corporation	Job Number:	J94914
Model:	7265D2W	T-Log Number:	T95472
Contact:	Steve Hackett	Project Manager:	Christine Krebill
Standard:	FCC Part 15.247, 15.407, RSS-210	Project Coordinator:	-
		Class:	N/A

Run #7: 1-10GHz, 802.11b @ 2462 MHz Chain A, BT Basic Rate @ 2440 MHz Chain B  
 Date of Test: 6/19/2014 Test Location: FT Chamber 4  
 Test Engineer: Jack Liu Config Change: None

	Target (dBm)	Power Settings Measured (dBm)	Software Setting
Chain A	16.5	17.6	14.5
Chain B	-	5.1	10.0

Note - measured power in table above is average power, for reference only.

Perform normal 1-10 GHz scan with filter for fundamental and then 2-3 GHz scan 20-30 cm from the product without filter.

### Preliminary Measurements (Peak versus average limit)

Frequency	Level	Pol	15.209/15.247		Detector	Azimuth	Height	Comments
MHz	dB $\mu$ V/m	v/h	Limit	Margin	PK/QP/Avg	degrees	meters	
1195.250	45.3	H	54.0	-8.7	Peak	111	1.3	
1590.780	39.5	H	54.0	-14.5	Peak	103	1.0	
4924.000	43.7	H	54.0	-10.3	Peak	189	1.6	

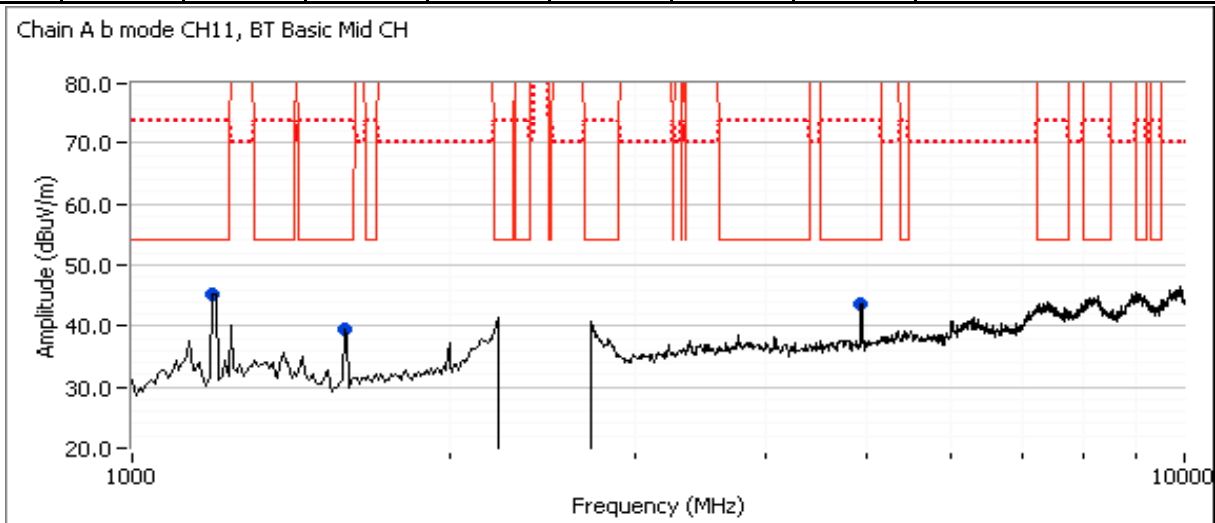

### Spurious Emissions excluding allocated band (final measurements at 3m)

Frequency	Level	Pol	15.209 / 15.247		Detector	Azimuth	Height	Comments
MHz	dB $\mu$ V/m	v/h	Limit	Margin	PK/QP/Avg	degrees	meters	
4923.960	41.3	H	54.0	-12.7	AVG	147	1.0	RB 1 MHz;VB 10 Hz;Peak
4924.020	46.9	H	74.0	-27.1	PK	147	1.0	RB 1 MHz;VB 3 MHz;Peak
1196.560	29.9	H	54.0	-24.1	AVG	116	1.6	RB 1 MHz;VB 10 Hz;Peak
1196.320	53.6	H	74.0	-20.4	PK	116	1.6	RB 1 MHz;VB 3 MHz;Peak
1592.010	29.2	H	54.0	-24.8	AVG	101	1.0	RB 1 MHz;VB 10 Hz;Peak
1592.100	40.7	H	74.0	-33.3	PK	101	1.0	RB 1 MHz;VB 3 MHz;Peak



# EMC Test Data

Client: Intel Corporation	Job Number: J94914
Model: 7265D2W	T-Log Number: T95472
Contact: Steve Hackett	Project Manager: Christine Krebill
Standard: FCC Part 15.247, 15.407, RSS-210	Project Coordinator: -
	Class: N/A

### Preliminary Measurements (Peak versus average limit) at 20-30cm from EUT

Frequency	Level	Pol	15.209/15.247		Detector	Azimuth	Height	Comments
MHz	dB $\mu$ V/m	v/h	Limit	Margin	PK/QP/Avg	degrees	meters	
2488.980	54.7	H	-	-	Peak	182	1.0	Refer to Band Edge test result

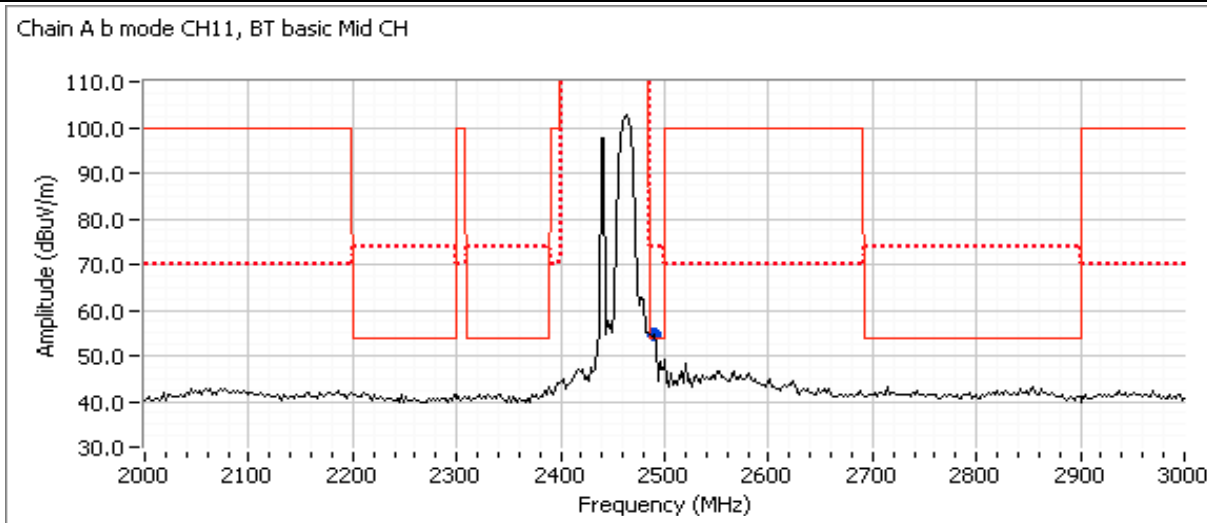

### Spurious Emissions near allocated band (final measurements at 3m)

Frequency	Level	Pol	15.209 / 15.247		Detector	Azimuth	Height	Comments
MHz	dB $\mu$ V/m	v/h	Limit	Margin	PK/QP/Avg	degrees	meters	

No intermodulation founded

- Note 1: For emissions in restricted bands, the limit of 15.209 was used. For all other emissions, the limit was set 20dB below the level of the fundamental and measured in 100kHz.
- Note 1: For emissions in restricted bands, the limit of 15.209 was used. For all other emissions, the limit was set 30dB below the level of the fundamental and measured in 100kHz.
- Note 2: Signal is not in a restricted band but the more stringent restricted band limit was used.
- Note 3: Signal is only present when Bluetooth is enabled, average correction for hopping occupancy could be applied



# EMC Test Data

Client: Intel Corporation	Job Number: J94914
Model: 7265D2W	T-Log Number: T95472
	Project Manager: Christine Krebill
Contact: Steve Hackett	Project Coordinator: -
Standard: FCC Part 15.247, 15.407, RSS-210	Class: N/A

Run #8: 1-10GHz, 802.11b @ 2437 MHz Chain A, BT Basic Rate @ 2480 MHz Chain B  
 Date of Test: 6/19/2014 Test Location: FT Chamber 4  
 Test Engineer: Jack Liu Config Change: None

	Target (dBm)	Power Settings Measured (dBm)	Software Setting
Chain A	16.5	17.7	14.0
Chain B	-	5.0	10.0

Note - measured power in table above is average power, for reference only.

Perform normal 1-10 GHz scan with filter for fundamental and then 2-3 GHz scan 20-30 cm from the product without filter.

### Preliminary Measurements (Peak versus average limit)

Frequency	Level	Pol	15.209/15.247		Detector	Azimuth	Height	Comments
MHz	dB $\mu$ V/m	v/h	Limit	Margin	PK/QP/Avg	degrees	meters	
1192.970	44.7	V	54.0	-9.3	Peak	224	1.0	
1594.110	41.0	H	54.0	-13.0	Peak	120	1.0	
4874.080	42.6	V	54.0	-11.4	Peak	154	1.9	

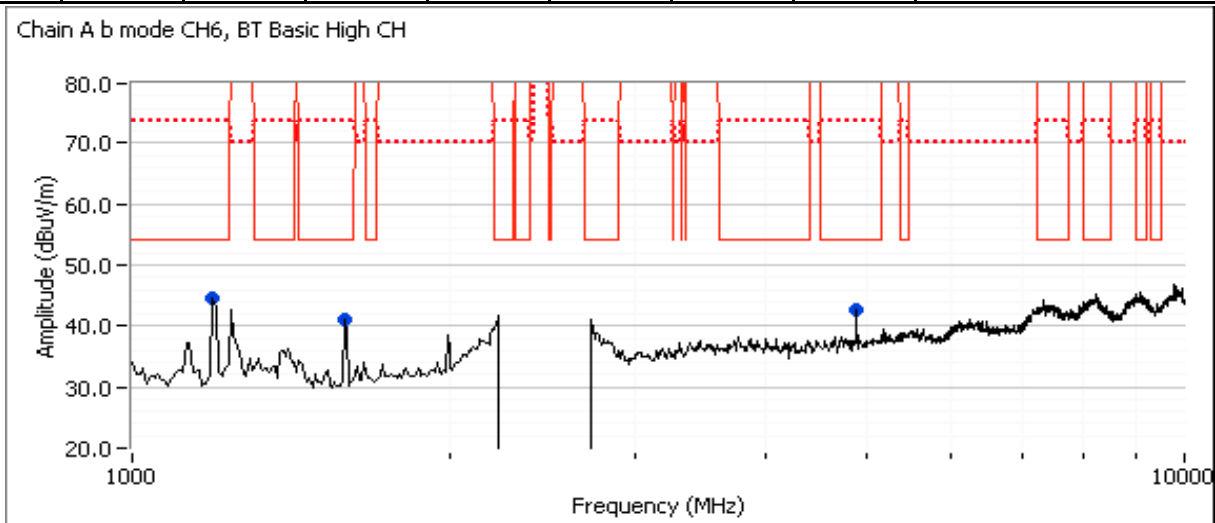

### Spurious Emissions excluding allocated band (final measurements at 3m)

Frequency	Level	Pol	15.209 / 15.247		Detector	Azimuth	Height	Comments
MHz	dB $\mu$ V/m	v/h	Limit	Margin	PK/QP/Avg	degrees	meters	
4874.020	41.1	V	54.0	-12.9	AVG	154	1.9	RB 1 MHz;VB 10 Hz;Peak
4874.190	47.0	V	74.0	-27.0	PK	154	1.9	RB 1 MHz;VB 3 MHz;Peak
1595.050	31.7	H	54.0	-22.3	AVG	121	1.0	RB 1 MHz;VB 10 Hz;Peak
1593.860	49.9	H	74.0	-24.1	PK	121	1.0	RB 1 MHz;VB 3 MHz;Peak
1194.440	32.5	V	54.0	-21.5	AVG	225	1.0	RB 1 MHz;VB 10 Hz;Peak
1194.200	54.0	V	74.0	-20.0	PK	225	1.0	RB 1 MHz;VB 3 MHz;Peak



# EMC Test Data

Client: Intel Corporation	Job Number: J94914
Model: 7265D2W	T-Log Number: T95472
Contact: Steve Hackett	Project Manager: Christine Krebill
Standard: FCC Part 15.247, 15.407, RSS-210	Project Coordinator: -
	Class: N/A

### Preliminary Measurements (Peak versus average limit) at 20-30cm from EUT

Frequency	Level	Pol	15.209/15.247		Detector	Azimuth	Height	Comments
MHz	dB $\mu$ V/m	v/h	Limit	Margin	PK/QP/Avg	degrees	meters	

No emission founded

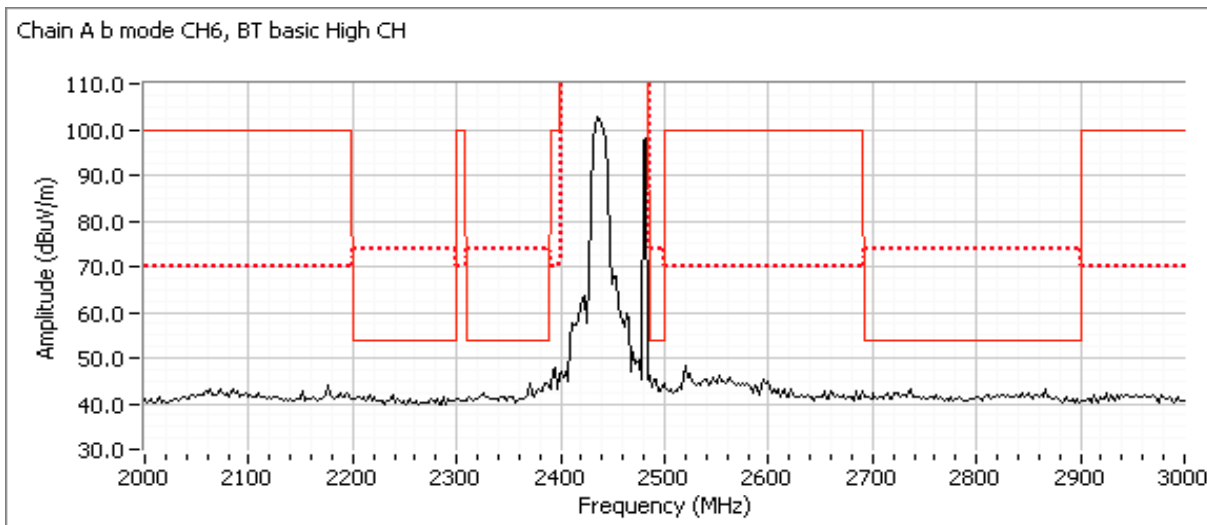

### Spurious Emissions near allocated band (final measurements at 3m)

Frequency	Level	Pol	15.209 / 15.247		Detector	Azimuth	Height	Comments
MHz	dB $\mu$ V/m	v/h	Limit	Margin	PK/QP/Avg	degrees	meters	

No intermodulation founded

- Note 1: For emissions in restricted bands, the limit of 15.209 was used. For all other emissions, the limit was set 20dB below the level of the fundamental and measured in 100kHz.
- Note 1: For emissions in restricted bands, the limit of 15.209 was used. For all other emissions, the limit was set 30dB below the level of the fundamental and measured in 100kHz.
- Note 2: Signal is not in a restricted band but the more stringent restricted band limit was used.
- Note 3: Signal is only present when Bluetooth is enabled, average correction for hopping occupancy could be applied



# EMC Test Data

Client: Intel Corporation	Job Number: J94914
Model: 7265D2W	T-Log Number: T95472
Contact: Steve Hackett	Project Manager: Christine Krebill
Standard: FCC Part 15.247, 15.407, RSS-210	Project Coordinator: -
	Class: N/A

Run #9: 1-10GHz, 802.11b @ 2412 MHz Chain A, BT EDR Rate @ 2440 MHz Chain B  
 Date of Test: 6/19/2014 Test Location: FT Chamber 4  
 Test Engineer: Jack Liu Config Change: None

	Power Settings		
	Target (dBm)	Measured (dBm)	Software Setting
Chain A	16.5	17.7	14.0
Chain B	-	1.2	6.0

Note - measured power in table above is average power, for reference only.

Perform normal 1-10 GHz scan with filter for fundamental and then 2-3 GHz scan 100 cm from the product without filter.

### Preliminary Measurements (Peak versus average limit)

Frequency MHz	Level dB $\mu$ V/m	Pol v/h	15.209/15.247		Detector Pk/QP/Avg	Azimuth degrees	Height meters	Comments
			Limit	Margin				
1245.000	46.2	H	70.0	-23.8	Peak	119	1.3	
1593.170	38.0	H	54.0	-16.0	Peak	124	1.0	
4924.030	45.2	V	54.0	-8.8	Peak	115	1.3	

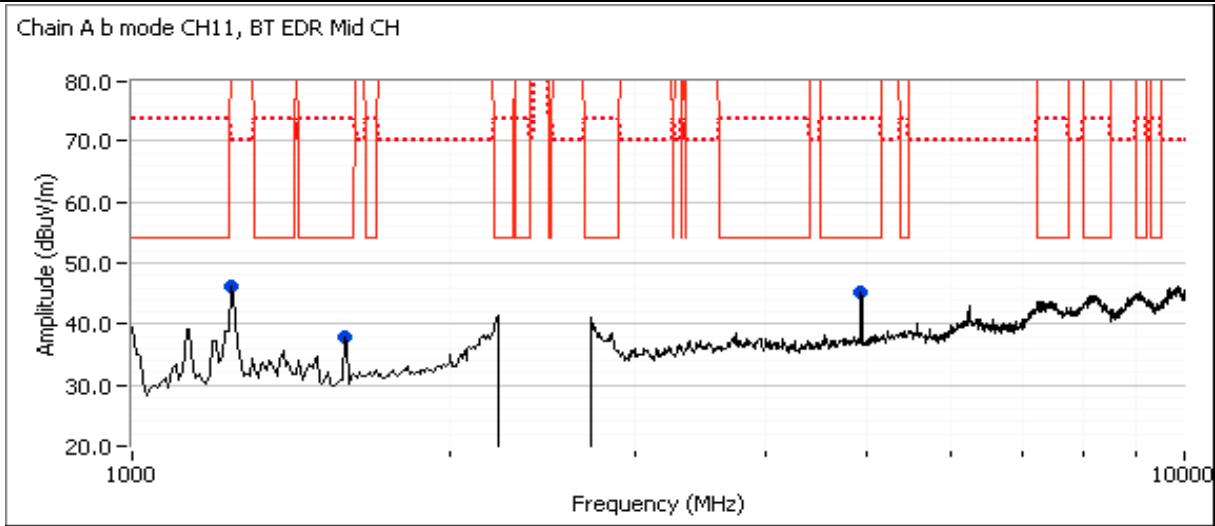

### Spurious Emissions excluding allocated band (final measurements at 3m)

Frequency MHz	Level dB $\mu$ V/m	Pol v/h	15.209 / 15.247		Detector Pk/QP/Avg	Azimuth degrees	Height meters	Comments
			Limit	Margin				
4923.970	41.4	V	54.0	-12.6	AVG	146	1.9	RB 1 MHz;VB 10 Hz;Peak
4923.840	47.1	V	74.0	-26.9	PK	146	1.9	RB 1 MHz;VB 3 MHz;Peak
1593.770	32.0	H	54.0	-22.0	AVG	122	1.0	RB 1 MHz;VB 10 Hz;Peak
1592.460	47.7	H	74.0	-26.3	PK	122	1.0	RB 1 MHz;VB 3 MHz;Peak
1244.940	52.4	H	68.3	-15.9	PK	117	0.9	RB 1 MHz;VB 3 MHz;Peak



# EMC Test Data

Client: Intel Corporation	Job Number: J94914
Model: 7265D2W	T-Log Number: T95472
Contact: Steve Hackett	Project Manager: Christine Krebill
Standard: FCC Part 15.247, 15.407, RSS-210	Project Coordinator: -
	Class: N/A

### Preliminary Measurements (Peak versus average limit) at 20-30cm from EUT

Frequency	Level	Pol	15.209/15.247		Detector	Azimuth	Height	Comments
MHz	dB $\mu$ V/m	v/h	Limit	Margin	Pk/QP/Avg	degrees	meters	

No intermodulation founded

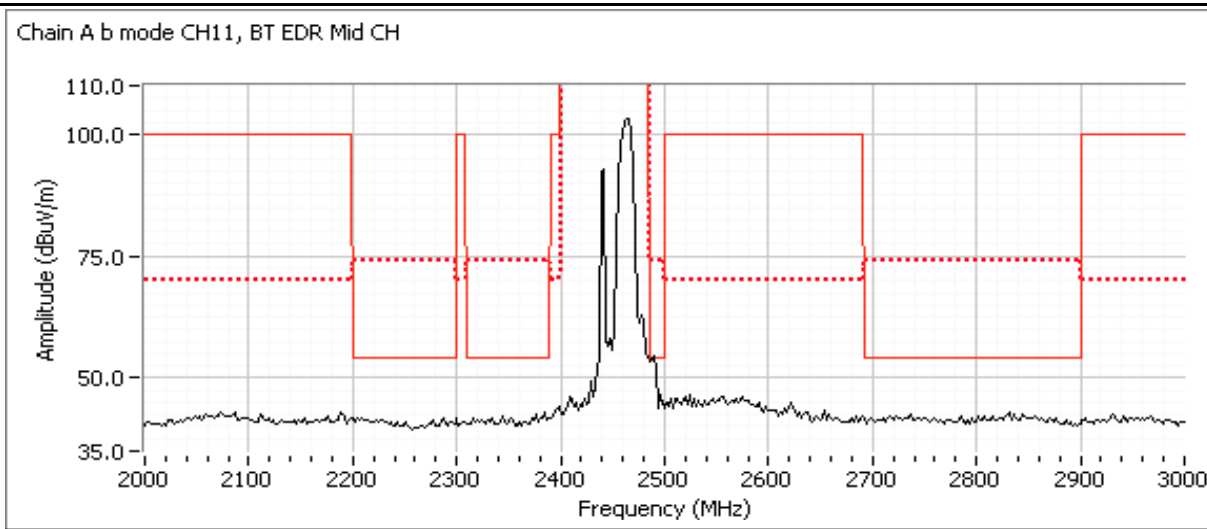

### Spurious Emissions near allocated band (final measurements at 3m)

Frequency	Level	Pol	15.209 / 15.247		Detector	Azimuth	Height	Comments
MHz	dB $\mu$ V/m	v/h	Limit	Margin	Pk/QP/Avg	degrees	meters	

No intermodulation founded

- Note 1: For emissions in restricted bands, the limit of 15.209 was used. For all other emissions, the limit was set 20dB below the level of the fundamental and measured in 100kHz.
- Note 1: For emissions in restricted bands, the limit of 15.209 was used. For all other emissions, the limit was set 30dB below the level of the fundamental and measured in 100kHz.
- Note 2: Signal is not in a restricted band but the more stringent restricted band limit was used.
- Note 3: Signal is only present when Bluetooth is enabled, average correction for hopping occupancy could be applied

Client: Intel Corporation	Job Number: J94914
Model: 7265D2W	T-Log Number: T95472
	Project Manager: Christine Krebill
Contact: Steve Hackett	Project Coordinator: -
Standard: FCC Part 15.247, 15.407, RSS-210	Class: N/A

Run #10: 1-10GHz, 802.11b @ 2412 MHz Chain A, BTLE @ 2440 MHz Chain B  
 Date of Test: 6/19/2014 Test Location: FT Chamber 4  
 Test Engineer: Jack Liu Config Change: None

	Target (dBm)	Power Settings Measured (dBm)	Software Setting
Chain A	16.5	17.7	14.0
Chain B	-	3.2	Default

Note - measured power in table above is average power, for reference only.

Perform normal 1-10 GHz scan with filter for fundamental and then 2-3 GHz scan 100 cm from the product without filter.

**Preliminary Measurements (Peak versus average limit)**

Frequency	Level	Pol	15.209/15.247		Detector	Azimuth	Height	Comments
MHz	dB $\mu$ V/m	v/h	Limit	Margin	Pk/QP/Avg	degrees	meters	
1242.560	45.5	H	70.0	-24.5	Peak	308	1.6	
1598.530	38.2	V	54.0	-15.8	Peak	60	1.6	
4924.030	46.4	V	54.0	-7.6	Peak	125	2.2	

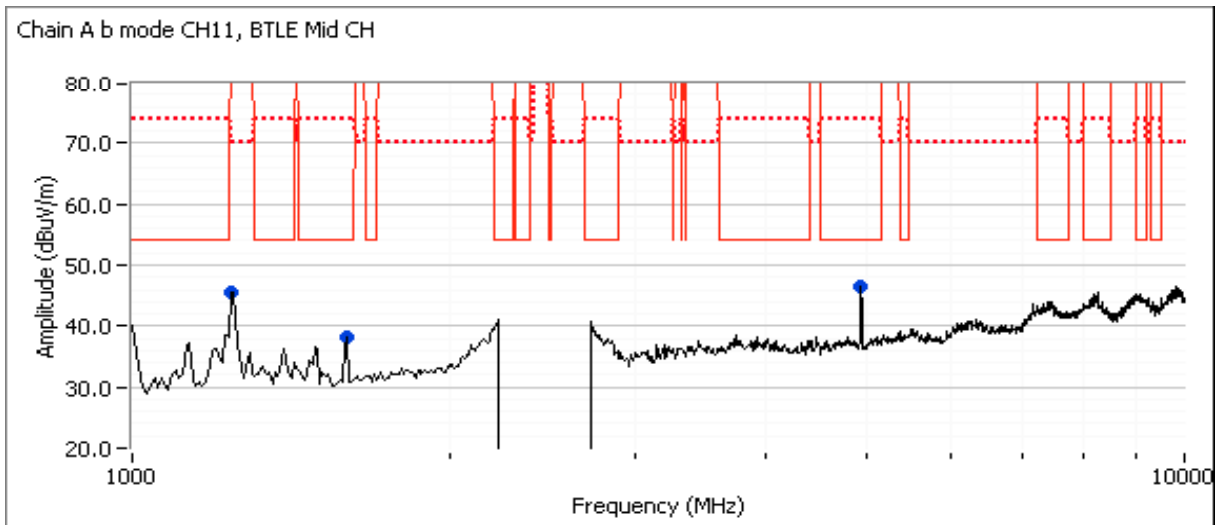

**Spurious Emissions excluding allocated band (final measurements at 3m)**

Frequency	Level	Pol	15.209 / 15.247		Detector	Azimuth	Height	Comments
MHz	dB $\mu$ V/m	v/h	Limit	Margin	Pk/QP/Avg	degrees	meters	
4923.990	43.5	V	54.0	-10.5	AVG	157	1.9	RB 1 MHz;VB 10 Hz;Peak
4923.950	48.4	V	74.0	-25.6	PK	157	1.9	RB 1 MHz;VB 3 MHz;Peak
1243.960	48.4	H	68.3	-19.9	PK	306	1.6	RB 1 MHz;VB 3 MHz;Peak
1598.280	31.6	V	54.0	-22.4	AVG	58	1.5	RB 1 MHz;VB 10 Hz;Peak
1598.740	44.6	V	74.0	-29.4	PK	58	1.5	RB 1 MHz;VB 3 MHz;Peak



# EMC Test Data

Client: Intel Corporation	Job Number: J94914
Model: 7265D2W	T-Log Number: T95472
Contact: Steve Hackett	Project Manager: Christine Krebill
Standard: FCC Part 15.247, 15.407, RSS-210	Project Coordinator: -
	Class: N/A

### Preliminary Measurements (Peak versus average limit) at 20-30cm from EUT

Frequency	Level	Pol	15.209/15.247		Detector	Azimuth	Height	Comments
MHz	dB $\mu$ V/m	v/h	Limit	Margin	Pk/QP/Avg	degrees	meters	

No intermodulation founded

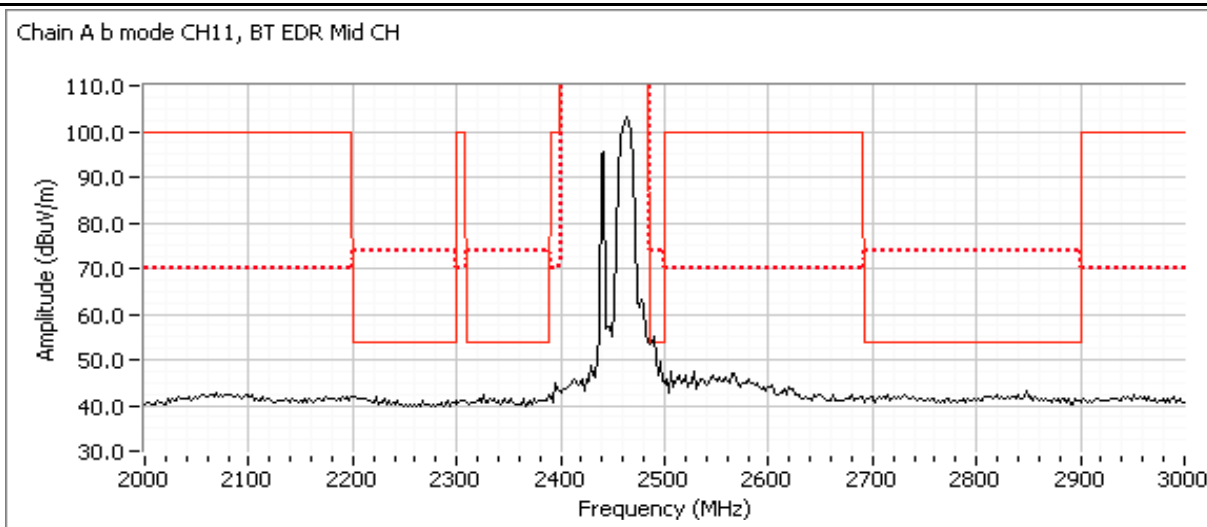

### Spurious Emissions near allocated band (final measurements at 3m)

Frequency	Level	Pol	15.209 / 15.247		Detector	Azimuth	Height	Comments
MHz	dB $\mu$ V/m	v/h	Limit	Margin	Pk/QP/Avg	degrees	meters	

No intermodulation founded

- Note 1: For emissions in restricted bands, the limit of 15.209 was used. For all other emissions, the limit was set 20dB below the level of the fundamental and measured in 100kHz.
- Note 1: For emissions in restricted bands, the limit of 15.209 was used. For all other emissions, the limit was set 30dB below the level of the fundamental and measured in 100kHz.
- Note 2: Signal is not in a restricted band but the more stringent restricted band limit was used.
- Note 3: Signal is only present when Bluetooth is enabled, average correction for hopping occupancy could be applied





# EMC Test Data

Client:	Intel Corporation	Job Number:	J94914
Model:	7265D2W	T-Log Number:	T95472
Contact:	Steve Hackett	Project Manager:	Christine Krebill
Standard:	FCC Part 15.247, 15.407, RSS-210	Project Coordinator:	-
		Class:	N/A

Run #11: 1-15GHz, 802.11n20 @ 5200 MHz Chain A+B, BT Basic Rate @ 2440 MHz Chain B  
 Date of Test: 6/18/2014 Test Location: FT Chamber #4  
 Test Engineer: Jack Liu / R. Varelas Config Change: None

	Target (dBm)	Power Settings Measured (dBm)	Software Setting
WiFi A	16.0	16.6	31.0
WiFi B	16.0	16.5	32.0
Bluetooth	-	5.1	10.0

Note - measured power in table above is average power, for reference only.

Perform normal 7-15 GHz scan with filter for fundamental and then 1-4 and 4-7 GHz scans 20-30 cm from the product without filter.

### Preliminary Measurements (Peak versus average limit)

Frequency	Level	Pol	15.209/15.247		Detector	Azimuth	Height	Comments
MHz	dB $\mu$ V/m	v/h	Limit	Margin	PK/QP/Avg	degrees	meters	
10401.330	39.0	H	68.3	-29.3	Peak	126	1.0	Harmonic of the EUT

### Spurious Emissions (final measurements at 3m)

Frequency	Level	Pol	15.209 / 15.247		Detector	Azimuth	Height	Comments
MHz	dB $\mu$ V/m	v/h	Limit	Margin	PK/QP/Avg	degrees	meters	
refer to the spurious RE results								

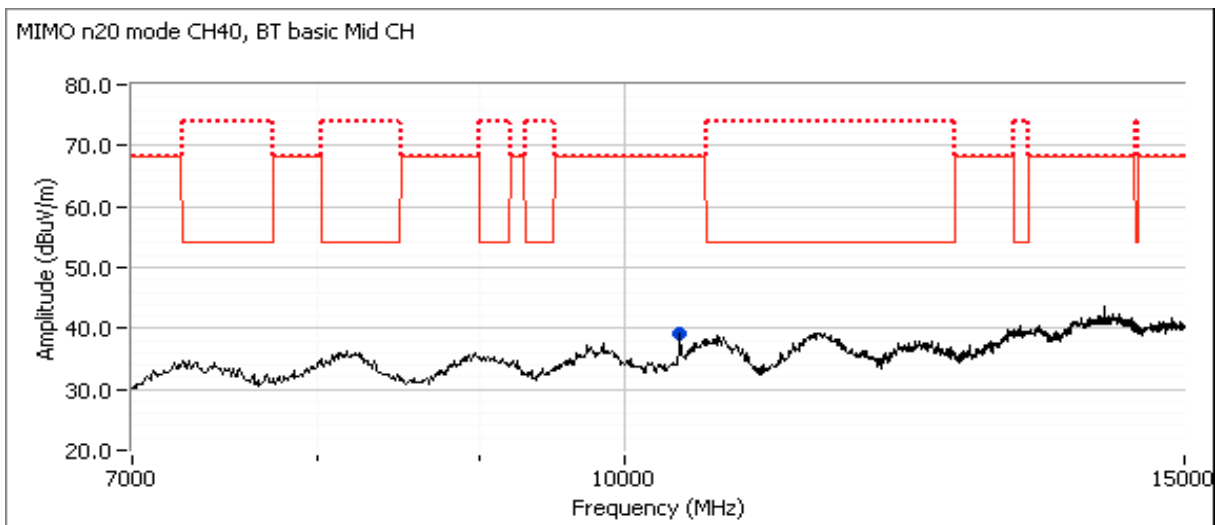



# EMC Test Data

Client: Intel Corporation	Job Number: J94914
Model: 7265D2W	T-Log Number: T95472
Contact: Steve Hackett	Project Manager: Christine Krebill
Standard: FCC Part 15.247, 15.407, RSS-210	Project Coordinator: -
	Class: N/A

### Preliminary Measurements (Peak versus average limit) at 20-30cm from EUT

Frequency	Level	Pol	15.209/15.247		Detector	Azimuth	Height	Comments
MHz	dB $\mu$ V/m	v/h	Limit	Margin	Pk/QP/Avg	degrees	meters	
5370.000	45.6	V	54.0	-8.4	Peak	180	1.0	
4980.000	40.9	V	54.0	-13.1	Peak	180	1.0	
2460.000	59.6	V	120.0	-60.4	Peak	180	1.0	emission is in band

### Spurious Emissions (final measurments at 3m)

Frequency	Level	Pol	15.209 / 15.247		Detector	Azimuth	Height	Comments
MHz	dB $\mu$ V/m	v/h	Limit	Margin	Pk/QP/Avg	degrees	meters	
no emisissions found above the noise floor								

- Note 1: For emissions in restricted bands, the limit of 15.209 was used. For all other emissions, the limit was set 20dB below the level of the fundamental and measured in 100kHz.
- Note 2: Signal is not in a restricted band but the more stringent restricted band limit was used.
- Note 3: Signal is only present when Bluetooth is enabled, average correction for hopping occupancy could be applied

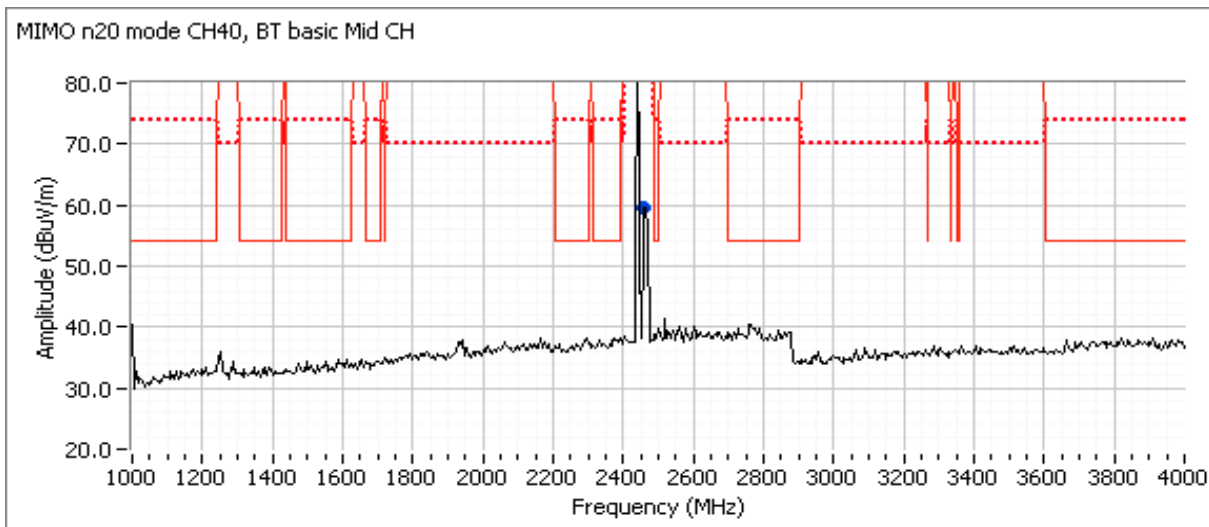

Client: Intel Corporation	Job Number: J94914
Model: 7265D2W	T-Log Number: T95472
Contact: Steve Hackett	Project Manager: Christine Krebill
Standard: FCC Part 15.247, 15.407, RSS-210	Project Coordinator: -
	Class: N/A

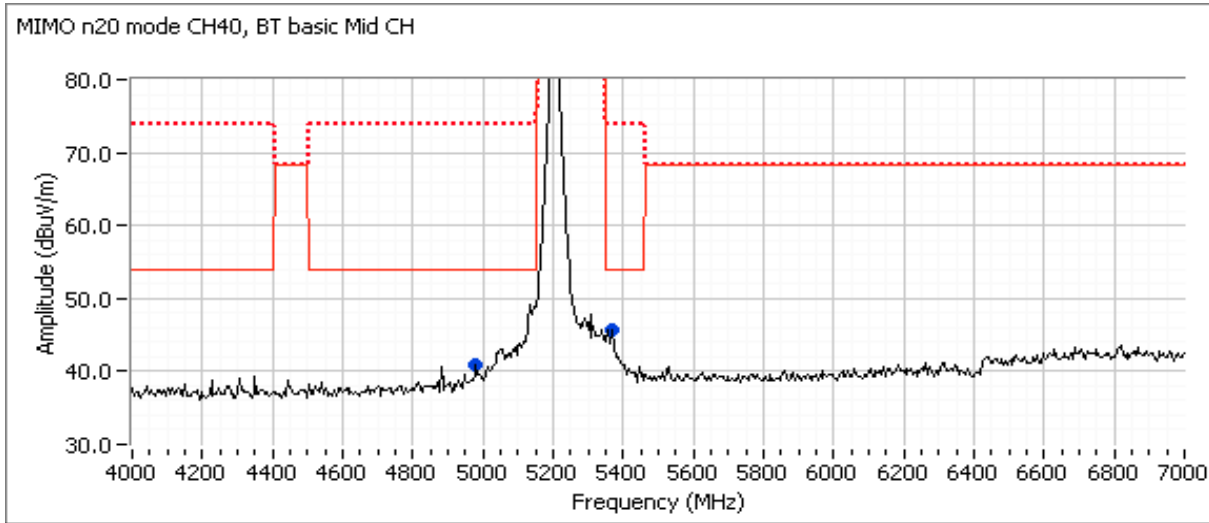

Run #12: 1-15GHz, 802.11n20 @ 5300 MHz Chain A+B, BT Basic Rate @ 2440 MHz Chain B  
 Date of Test: 6/18/2014 Test Location: FT Chamber #4  
 Test Engineer: R. Varelas Config Change: None

	Target (dBm)	Power Settings Measured (dBm)	Software Setting
WiFi A	16.0	16.6	32.0
WiFi B	16.0	16.5	33.0
Bluetooth	-	5.1	10.0

Note - measured power in table above is average power, for reference only.

Perform normal 7-15 GHz scan with filter for fundamental and then 1-4 and 4-7 GHz scans 20-30 cm from the product without filter.

**Preliminary Measurements (Peak versus average limit)**

Frequency	Level	Pol	15.209/15.247		Detector	Azimuth	Height	Comments
MHz	dB $\mu$ V/m	v/h	Limit	Margin	PK/QP/Avg	degrees	meters	
10599.970	42.3	H	68.3	-26.0	Peak	212	1.0	Harmonic of the EUT

**Spurious Emissions (final measurements at 3m)**

Frequency	Level	Pol	15.209 / 15.247		Detector	Azimuth	Height	Comments
MHz	dB $\mu$ V/m	v/h	Limit	Margin	PK/QP/Avg	degrees	meters	
refer to the spurious RE results								

Client:	Intel Corporation	Job Number:	J94914
Model:	7265D2W	T-Log Number:	T95472
Contact:	Steve Hackett	Project Manager:	Christine Krebill
Standard:	FCC Part 15.247, 15.407, RSS-210	Project Coordinator:	-
		Class:	N/A

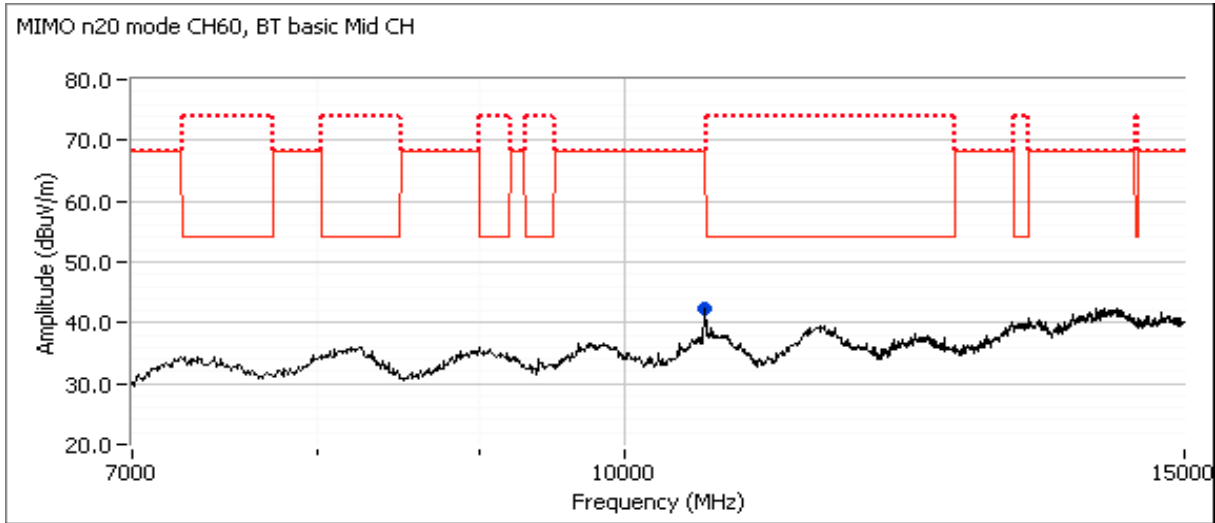

**Preliminary Measurements (Peak versus average limit) at 20-30cm from EUT**

Frequency	Level	Pol	15.209/15.247		Detector	Azimuth	Height	Comments
MHz	dBµV/m	v/h	Limit	Margin	Pk/QP/Avg	degrees	meters	
2460.000	63.3	V	120.0	-56.7	Peak	180	1.0	In band intermittent signal
5140.000	45.8	V	54.0	-8.2	Peak	180	1.0	
4880.000	42.0	V	54.0	-12.0	Peak	180	1.0	

**Spurious Emissions (final measurements at 3m)**

Frequency	Level	Pol	15.209 / 15.247		Detector	Azimuth	Height	Comments
MHz	dBµV/m	v/h	Limit	Margin	Pk/QP/Avg	degrees	meters	
no emissions found above the noise floor								

- Note 1: For emissions in restricted bands, the limit of 15.209 was used. For all other emissions, the limit was set 20dB below the level of the fundamental and measured in 100kHz.
- Note 2: Signal is not in a restricted band but the more stringent restricted band limit was used.
- Note 3: Signal is only present when Bluetooth is enabled, average correction for hopping occupancy could be applied

Client: Intel Corporation	Job Number: J94914
Model: 7265D2W	T-Log Number: T95472
Contact: Steve Hackett	Project Manager: Christine Krebill
Standard: FCC Part 15.247, 15.407, RSS-210	Project Coordinator: -
	Class: N/A

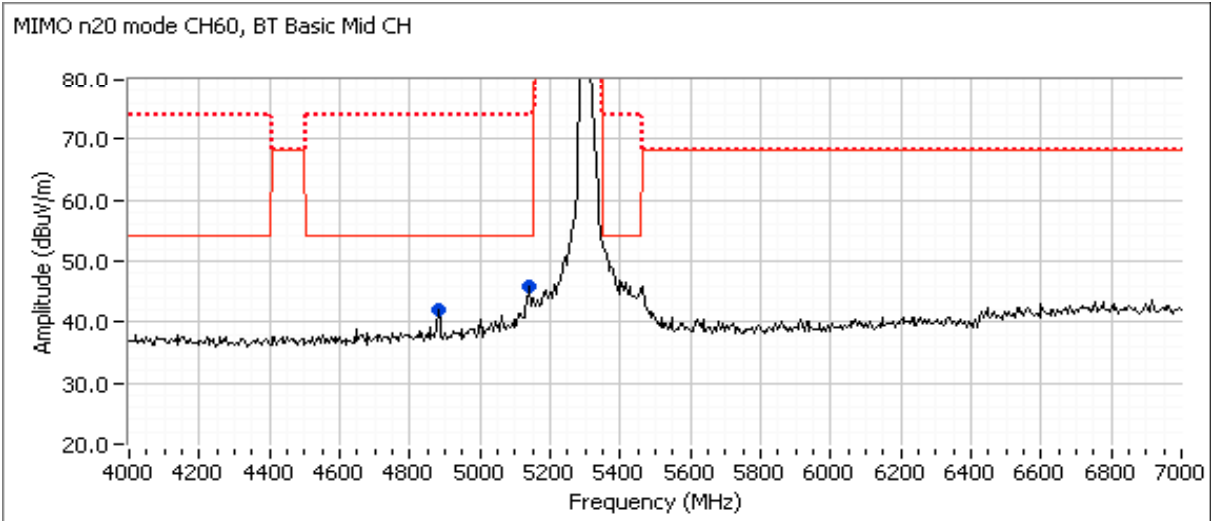
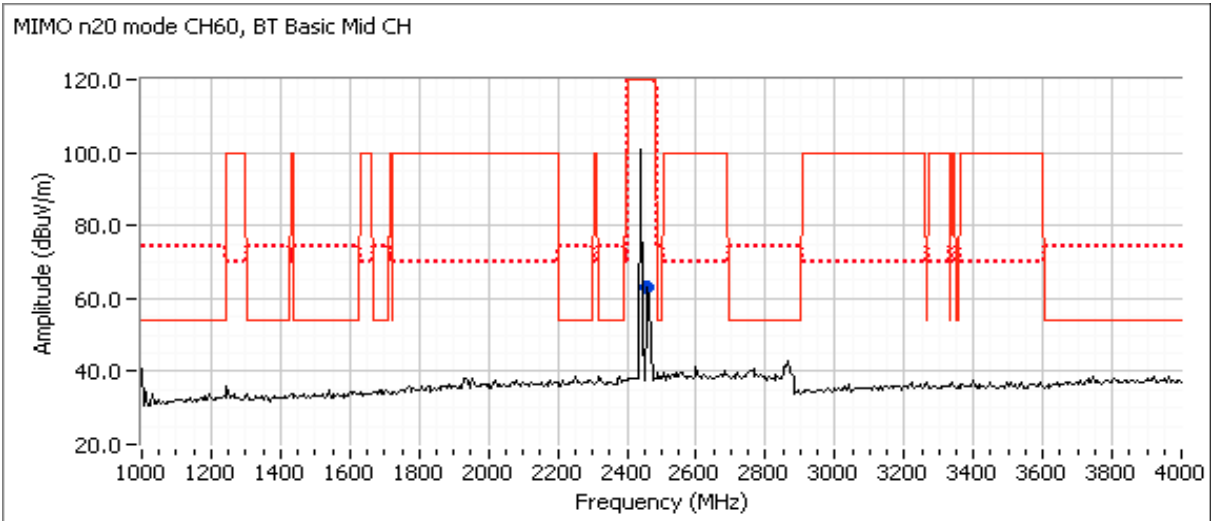



# EMC Test Data

Client: Intel Corporation	Job Number: J94914
Model: 7265D2W	T-Log Number: T95472
Contact: Steve Hackett	Project Manager: Christine Krebill
Standard: FCC Part 15.247, 15.407, RSS-210	Project Coordinator: -
	Class: N/A

Run #13: 1-15GHz, 802.11n20 @ 5580 MHz Chain A+B, BT Basic Rate @ 2440 MHz Chain B  
 Date of Test: 6/18/2014 Test Location: FT Chamber #4  
 Test Engineer: R. Varelas Config Change: None

	Target (dBm)	Power Settings Measured (dBm)	Software Setting
WiFi A	16.0	16.6	28.5
WiFi B	16.0	16.5	29.5
Bluetooth	-	5.1	10.0

Note - measured power in table above is average power, for reference only.

Perform normal 7-15 GHz scan with filter for fundamental and then 1-4 and 4-7 GHz scans 20-30 cm from the product without filter.

**Preliminary Measurements (Peak versus average limit)**

Frequency	Level	Pol	15.209/15.247		Detector	Azimuth	Height	Comments
MHz	dB $\mu$ V/m	v/h	Limit	Margin	Pk/QP/Avg	degrees	meters	
11167.600	40.4	V	54.0	-13.6	Peak	165	1.0	Harmonic of the EUT

**Spurious Emissions (final measurements at 3m)**

Frequency	Level	Pol	15.209 / 15.247		Detector	Azimuth	Height	Comments
MHz	dB $\mu$ V/m	v/h	Limit	Margin	Pk/QP/Avg	degrees	meters	
refer to the spurious RE results								

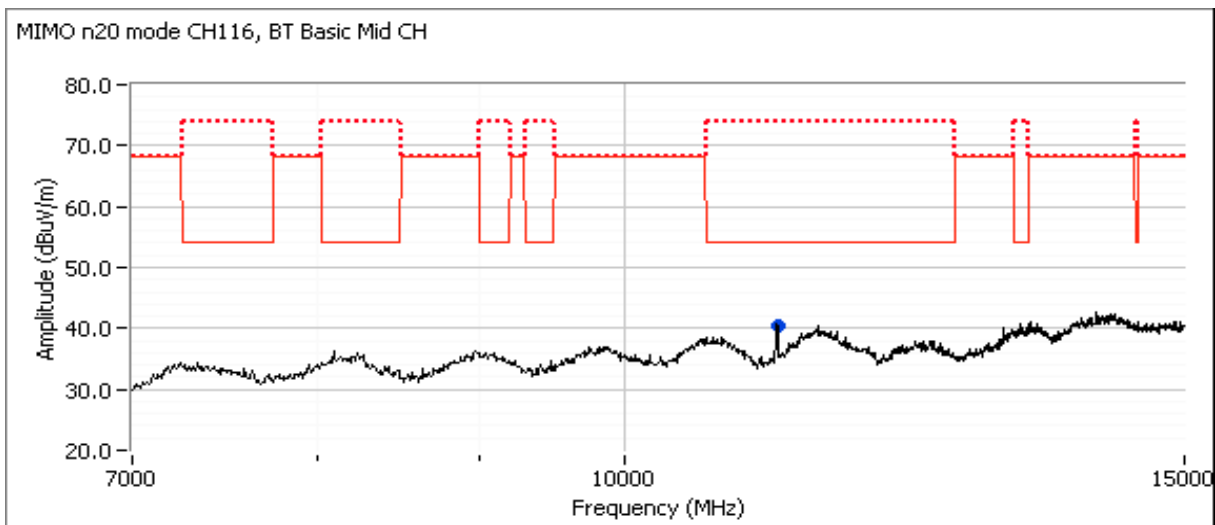

Client: Intel Corporation	Job Number: J94914
Model: 7265D2W	T-Log Number: T95472
Contact: Steve Hackett	Project Manager: Christine Krebill
Standard: FCC Part 15.247, 15.407, RSS-210	Project Coordinator: -
	Class: N/A

### Preliminary Measurements (Peak versus average limit) at 20-30cm from EUT

Frequency	Level	Pol	15.209/15.247		Detector	Azimuth	Height	Comments
MHz	dB $\mu$ V/m	v/h	Limit	Margin	Pk/QP/Avg	degrees	meters	
4880.000	43.5	V	54.0	-10.5	Peak	180	1.0	
5425.000	46.2	V	54.0	-7.8	Peak	180	1.0	
2460.000	59.8	V	120.0	-60.2	Peak	180	1.0	In band intermittent signal

### Spurious Emissions (final measurments at 3m)

Frequency	Level	Pol	15.209 / 15.247		Detector	Azimuth	Height	Comments
MHz	dB $\mu$ V/m	v/h	Limit	Margin	Pk/QP/Avg	degrees	meters	
no emisissions found above the noise floor								

Note 1: For emissions in restricted bands, the limit of 15.209 was used. For all other emissions, the limit was set 20dB below the level of the fundamental and measured in 100kHz.

Note 2: Signal is not in a restricted band but the more stringent restricted band limit was used.

Note 3: Signal is only present when Bluetooth is enabled, average correction for hopping occupancy could be applied

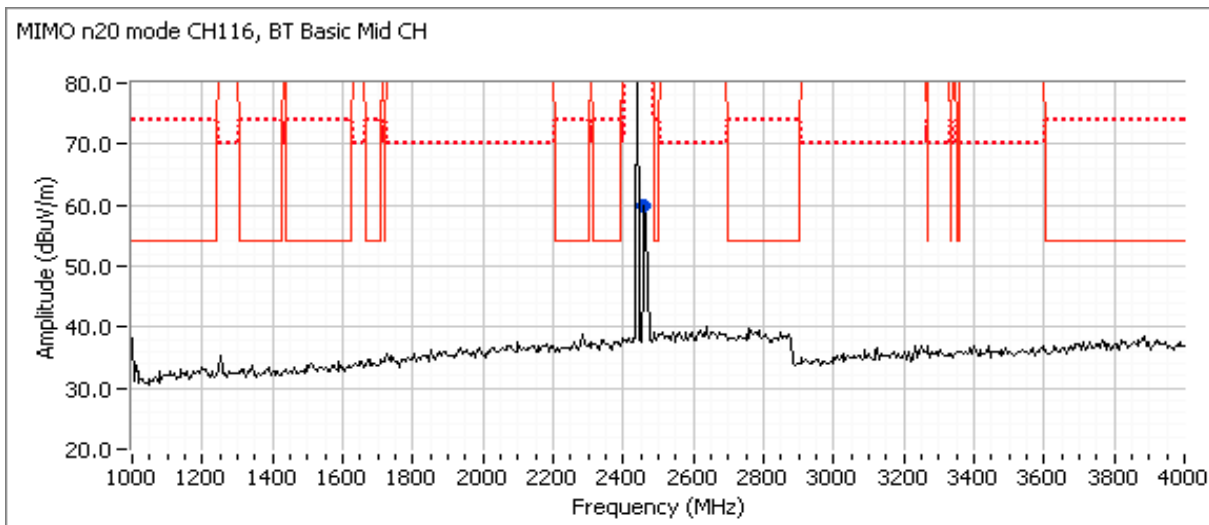

Client: Intel Corporation	Job Number: J94914
Model: 7265D2W	T-Log Number: T95472
Contact: Steve Hackett	Project Manager: Christine Krebill
Standard: FCC Part 15.247, 15.407, RSS-210	Project Coordinator: -
	Class: N/A

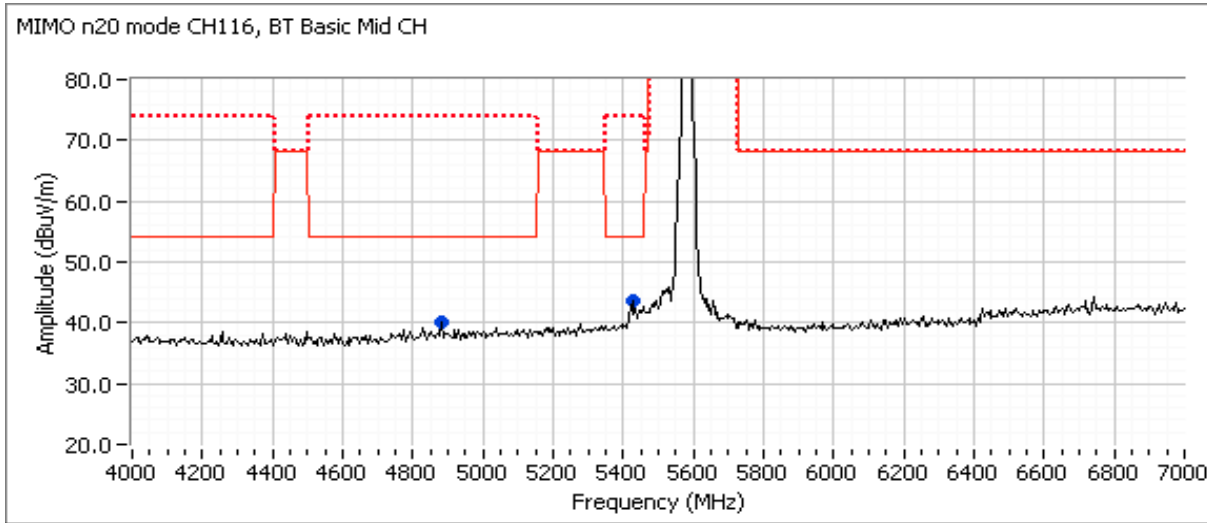

Run #14: 1-15GHz, 802.11n20 @ 5785 MHz Chain A+B, BT Basic Rate @ 2440 MHz Chain B  
 Date of Test: 6/18/2014 Test Location: FT Chamber #4  
 Test Engineer: R. Varelas Config Change: None

	Target (dBm)	Power Settings Measured (dBm)	Software Setting
WiFi A	16.0	16.7	34.5
WiFi B	16.0	16.5	35.5
Bluetooth	-	5.1	10.0

Note - measured power in table above is average power, for reference only.

Perform normal 7-15 GHz scan with filter for fundamental and then 1-4 and 4-7 GHz scans 20-30 cm from the product without filter.

**Preliminary Measurements (Peak versus average limit)**

Frequency	Level	Pol	15.209/15.247		Detector	Azimuth	Height	Comments
MHz	dBµV/m	v/h	Limit	Margin	PK/QP/Avg	degrees	meters	
11570.260	46.3	V	54.0	-7.7	Peak	101	1.0	Harmonic of the EUT

**Spurious Emissions (final measurements at 3m)**

Frequency	Level	Pol	15.209 / 15.247		Detector	Azimuth	Height	Comments
MHz	dBµV/m	v/h	Limit	Margin	PK/QP/Avg	degrees	meters	
refer to the spurious RE results								



Client: Intel Corporation	Job Number: J94914
Model: 7265D2W	T-Log Number: T95472
Contact: Steve Hackett	Project Manager: Christine Krebill
Standard: FCC Part 15.247, 15.407, RSS-210	Project Coordinator: -
	Class: N/A

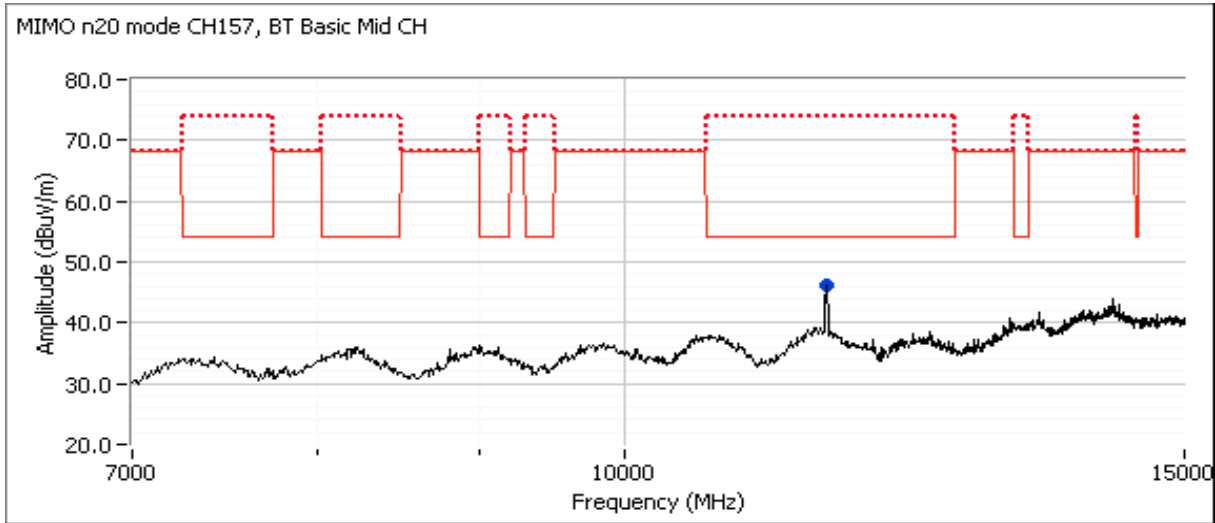

**Preliminary Measurements (Peak versus average limit) at 20-30cm from EUT**

Frequency	Level	Pol	15.209/15.247		Detector	Azimuth	Height	Comments
MHz	dBµV/m	v/h	Limit	Margin	Pk/QP/Avg	degrees	meters	
2460.000	52.8	V	120.0	-67.2	Peak	180	1.0	In band intermittent signal

**Spurious Emissions (final measurements at 3m)**

Frequency	Level	Pol	15.209 / 15.247		Detector	Azimuth	Height	Comments
MHz	dBµV/m	v/h	Limit	Margin	Pk/QP/Avg	degrees	meters	
Emissions is in band								

- Note 1: For emissions in restricted bands, the limit of 15.209 was used. For all other emissions, the limit was set 20dB below the level of the fundamental and measured in 100kHz.
- Note 2: Signal is not in a restricted band but the more stringent restricted band limit was used.
- Note 3: Signal is only present when Bluetooth is enabled, average correction for hopping occupancy could be applied

Client: Intel Corporation	Job Number: J94914
Model: 7265D2W	T-Log Number: T95472
Contact: Steve Hackett	Project Manager: Christine Krebill
Standard: FCC Part 15.247, 15.407, RSS-210	Project Coordinator: -
	Class: N/A

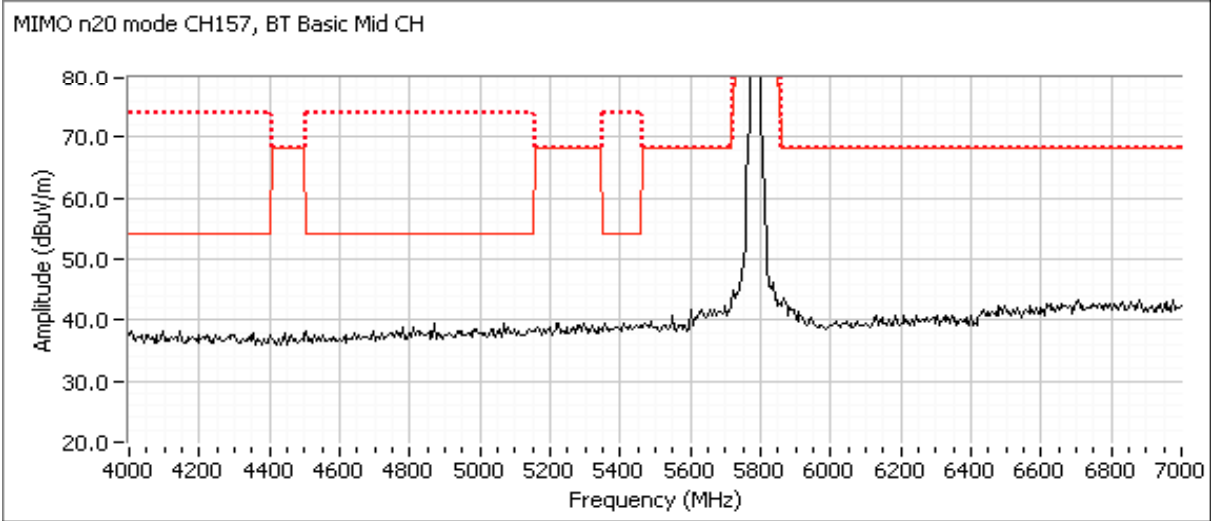
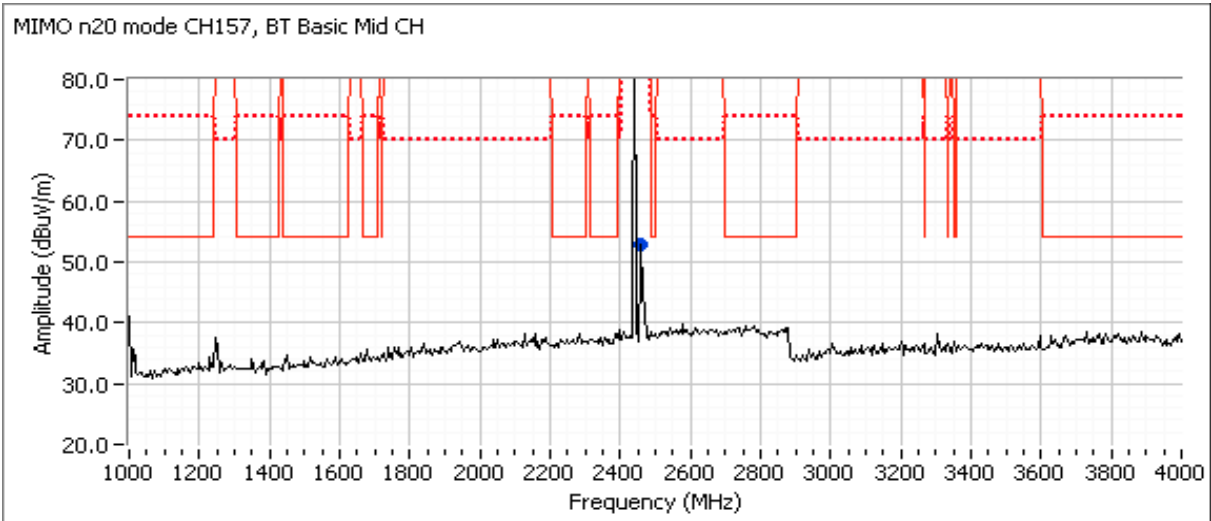



# EMC Test Data

Client:	Intel Corporation	Job Number:	J94914
Model:	7265D2W	T-Log Number:	T95472
Contact:	Steve Hackett	Project Manager:	Christine Krebill
Standard:	FCC Part 15.247, 15.407, RSS-210	Project Coordinator:	-
		Class:	N/A

## Radiated Emissions

*(Elliott Laboratories Fremont Facility, Semi-Anechoic Chamber)*

### Test Specific Details

Objective: The objective of this test session is to perform final qualification testing of the EUT with respect to the specification listed above.

Date of Test: 6/17/2014  
 Test Engineer: John Caizzi  
 Test Location: Chamber 4

Config. Used: 1  
 Config Change: none  
 Host Unit Voltage 120V/60Hz

### General Test Configuration

The EUT and any local support equipment were located on the turntable for radiated emissions testing. The test distance and extrapolation factor (if applicable) are detailed under each run description.

Note, preliminary testing indicates that the emissions were maximized by orientation of the EUT and elevation of the measurement antenna. Maximized testing indicated that the emissions were maximized by orientation of the EUT, elevation of the measurement

### Ambient Conditions:

Temperature: 23 °C  
 Rel. Humidity: 31 %

### Summary of Results

MAC Address: 001500F15B3A, DRTU Tool Version 1.7.3-935, Driver version 17.1.0.11

Run #	Test Performed	Limit	Result	Margin
2	Radiated Emissions 30 - 1000 MHz, Maximized	FCC 15.209 / RSS 210	Pass	30.9 dBµV/m @ 112.94 MHz (-12.6 dB)
4	Radiated Emissions 30 - 1000 MHz, Maximized	FCC 15.209 / RSS 210	Pass	See above

Note - measurements with the WiFi and BT transmitters both operating indicate that the radiated emissions from the combination of test fixture and EUT are not affected by the module's operating frequency or mode. Additional channels and modes were therefore not necessary to show compliance with the limits.

### Modifications Made During Testing

No modifications were made to the EUT during testing

### Deviations From The Standard

No deviations were made from the requirements of the standard.



# EMC Test Data

Client: Intel Corporation	Job Number: J94914
Model: 7265D2W	T-Log Number: T95472
Contact: Steve Hackett	Project Manager: Christine Krebill
Standard: FCC Part 15.247, 15.407, RSS-210	Project Coordinator: -
	Class: N/A

Run #1: Preliminary Radiated Emissions, 30 - 1000 MHz  
 Configured to Tx , 802.11b, 16.5 dBm on chain A (setting = 13.5) on channel 6, Bluetooth 5.1 dBm, 1Mb/s (setting 10 dBm) on channel 0

Test Parameters for Preliminary Scan(s)			
Frequency Range	Prescan Distance	Limit Distance	Extrapolation Factor
30 - 1000 MHz	3	3	0.0

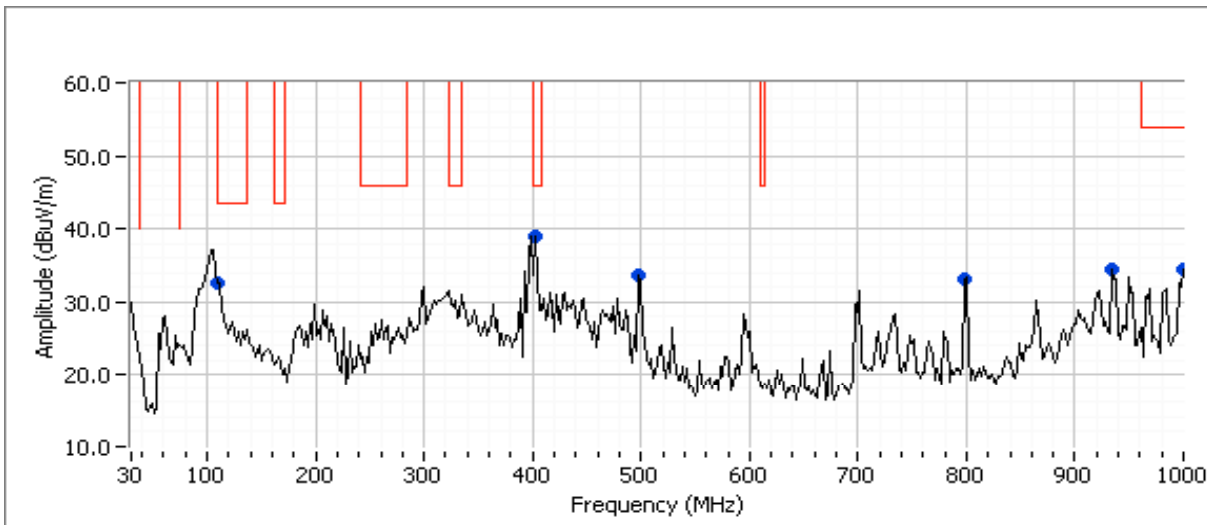

Preliminary peak readings captured during pre-scan

Frequency MHz	Level dBµV/m	Pol v/h	FCC 15.209 / RSS 210		Detector Pk/QP/Avg	Azimuth degrees	Height meters	Comments
			Limit	Margin				
112.935	32.7	V	43.5	-10.8	Peak	330	1.0	
399.925	38.9	H	46.0	-7.1	Peak	178	1.0	
497.952	33.8	H	46.0	-12.2	Peak	193	1.0	Note 1
799.457	33.2	V	46.0	-12.8	Peak	236	1.0	Note 1
933.500	34.6	H	46.0	-11.4	Peak	247	1.0	Note 1
999.347	34.5	V	54.0	-19.5	Peak	176	1.0	



# EMC Test Data

Client:	Intel Corporation	Job Number:	J94914
Model:	7265D2W	T-Log Number:	T95472
Contact:	Steve Hackett	Project Manager:	Christine Krebill
Standard:	FCC Part 15.247, 15.407, RSS-210	Project Coordinator:	-
		Class:	N/A

**Preliminary quasi-peak readings (no manipulation of EUT interface cables)**

Frequency	Level	Pol	FCC 15.209 / RSS 210		Detector	Azimuth	Height	Comments
MHz	dB $\mu$ V/m	v/h	Limit	Margin	Pk/QP/Avg	degrees	meters	
112.935	30.9	V	43.5	-12.6	QP	45	1.00	
933.500	32.4	H	46.0	-13.6	QP	245	1.58	Note 1
799.457	30.6	V	46.0	-15.4	QP	151	1.04	Note 1
497.952	32.2	H	46.0	-13.8	QP	198	1.00	Note 1
399.925	33.3	H	46.0	-12.7	QP	182	1.00	
999.347	32.4	V	54.0	-21.6	QP	179	1.00	

Note 1: Emission in non-restricted band, but limit of 15.209 used.

**Run #2: Maximized Readings From Run #1**

Test Parameters for Maximized Reading(s)			
Frequency Range	Test Distance	Limit Distance	Extrapolation Factor
30 - 1000 MHz	3	3	0.0

**Maximized quasi-peak readings (includes manipulation of EUT interface cables)**

Frequency	Level	Pol	FCC 15.209 / RSS 210		Detector	Azimuth	Height	Comments
MHz	dB $\mu$ V/m	v/h	Limit	Margin	Pk/QP/Avg	degrees	meters	
112.935	30.9	V	43.5	-12.6	QP	45	1.00	
933.500	32.4	H	46.0	-13.6	QP	245	1.58	Note 1
799.457	30.6	V	46.0	-15.4	QP	151	1.04	Note 1
497.952	32.2	H	46.0	-13.8	QP	198	1.00	Note 1
399.925	33.3	H	46.0	-12.7	QP	182	1.00	
999.347	32.4	V	54.0	-21.6	QP	179	1.00	

Note 1: Emission in non-restricted band, but limit of 15.209 used.

Client: Intel Corporation	Job Number: J94914
Model: 7265D2W	T-Log Number: T95472
Contact: Steve Hackett	Project Manager: Christine Krebill
Standard: FCC Part 15.247, 15.407, RSS-210	Project Coordinator: -
	Class: N/A

Run #3: Preliminary Radiated Emissions, 30 - 1000 MHz  
 Configured to Tx , 802.11a, 16.5 dBm on each chain (settings 25.5, 26.0) on channel 116, Bluetooth 4.7 dBm, 1Mb/s (setting 10 dBm) on Channel 78.

Test Parameters for Preliminary Scan(s)			
Frequency Range	Prescan Distance	Limit Distance	Extrapolation Factor
30 - 1000 MHz	3	3	0.0

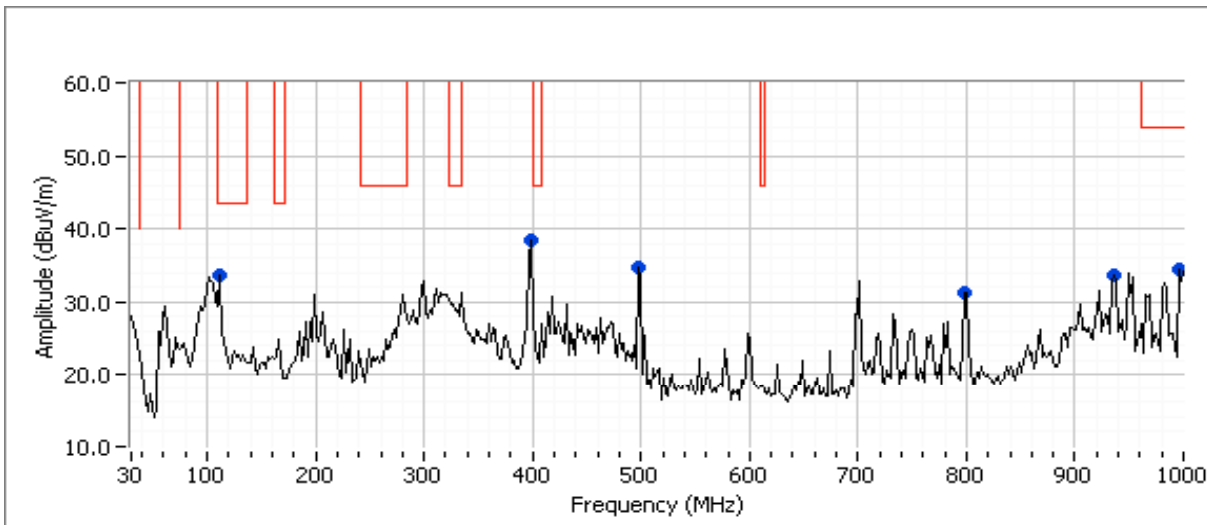

Preliminary peak readings captured during pre-scan

Frequency MHz	Level dB $\mu$ V/m	Pol v/h	FCC 15.209 / RSS 210		Detector Pk/QP/Avg	Azimuth degrees	Height meters	Comments
			Limit	Margin				
111.643	33.8	H	43.5	-9.7	Peak	89	3.0	
399.339	38.5	H	46.0	-7.5	Peak	169	1.0	Note 1
498.477	34.8	H	46.0	-11.2	Peak	199	1.0	Note 1
797.836	31.4	H	46.0	-14.6	Peak	79	1.0	Note 1
935.852	33.7	H	46.0	-12.3	Peak	249	1.0	Note 1
996.112	34.4	H	54.0	-19.6	Peak	319	1.0	

Note 1: Emission in non-restricted band, but limit of 15.209 used.



# EMC Test Data

Client:	Intel Corporation	Job Number:	J94914
Model:	7265D2W	T-Log Number:	T95472
Contact:	Steve Hackett	Project Manager:	Christine Krebill
Standard:	FCC Part 15.247, 15.407, RSS-210	Project Coordinator:	-
		Class:	N/A

**Preliminary quasi-peak readings (no manipulation of EUT interface cables)**

Frequency	Level	Pol	FCC 15.209 / RSS 210		Detector	Azimuth	Height	Comments
MHz	dB $\mu$ V/m	v/h	Limit	Margin	Pk/QP/Avg	degrees	meters	

**Run #4: Maximized Readings From Run #3**

Test Parameters for Maximized Reading(s)			
Frequency Range	Test Distance	Limit Distance	Extrapolation Factor
30 - 1000 MHz	3	3	0.0

**Maximized quasi-peak readings (includes manipulation of EUT interface cables)**

Frequency	Level	Pol	FCC 15.209 / RSS 210		Detector	Azimuth	Height	Comments
MHz	dB $\mu$ V/m	v/h	Limit	Margin	Pk/QP/Avg	degrees	meters	



# EMC Test Data

Client: Intel Corporation	Job Number: J94914
Model: 7265D2W	T-Log Number: T95472
	Project Manager: Christine Krebill
Contact: Steve Hackett	Project Coordinator: -
Standard: FCC Part 15.247, 15.407, RSS-210	Class: N/A

## Conducted Emissions

*(Elliott Laboratories Fremont Facility, Semi-Anechoic Chamber)*

### Test Specific Details

Objective: The objective of this test session is to perform final qualification testing of the EUT with respect to the specification listed above.

Date of Test: 6/20/2014	Config. Used: 1
Test Engineer: Jack Liu	Config Change: None
Test Location: FT Chamber# 4	Host Unit Voltage 120V/60Hz

### General Test Configuration

The EUT on the test fixture and other support equipment was located on a wooden table inside the semi-anechoic chamber, 40 cm from a vertical coupling plane and 80cm from the LISN. A second LISN was used for all local support equipment. Remote support

**Ambient Conditions:**

Temperature:	24 °C
Rel. Humidity:	38 %

### Summary of Results

Run #	Test Performed	Limit	Result	Margin
1	CE, AC Power, 120V/60Hz	RSS 210 / 15.207	Pass	62.0 dBµV @ 0.152 MHz (-3.9 dB)

### Modifications Made During Testing

No modifications were made to the EUT during testing

### Deviations From The Standard

No deviations were made from the requirements of the standard.

### Sample Notes

MAC Address: 001500F15B3A DRTU Tool Version 1.7.3-935 Driver version 17.1.0.11



Client: Intel Corporation	Job Number: J94914
Model: 7265D2W	T-Log Number: T95472
Contact: Steve Hackett	Project Manager: Christine Krebill
Standard: FCC Part 15.247, 15.407, RSS-210	Project Coordinator: -
	Class: N/A

Run #1: AC Power Port Conducted Emissions, 0.15 - 30MHz, 120V/60Hz  
 Configured to Tx , 802.11a, 16.5 dBm on each chain (settings 25.5, 26.0) on channel 116, Bluetooth 5.1dBm, 1Mb/s (setting 10 dBm) on Mid Channel (2440MHz).

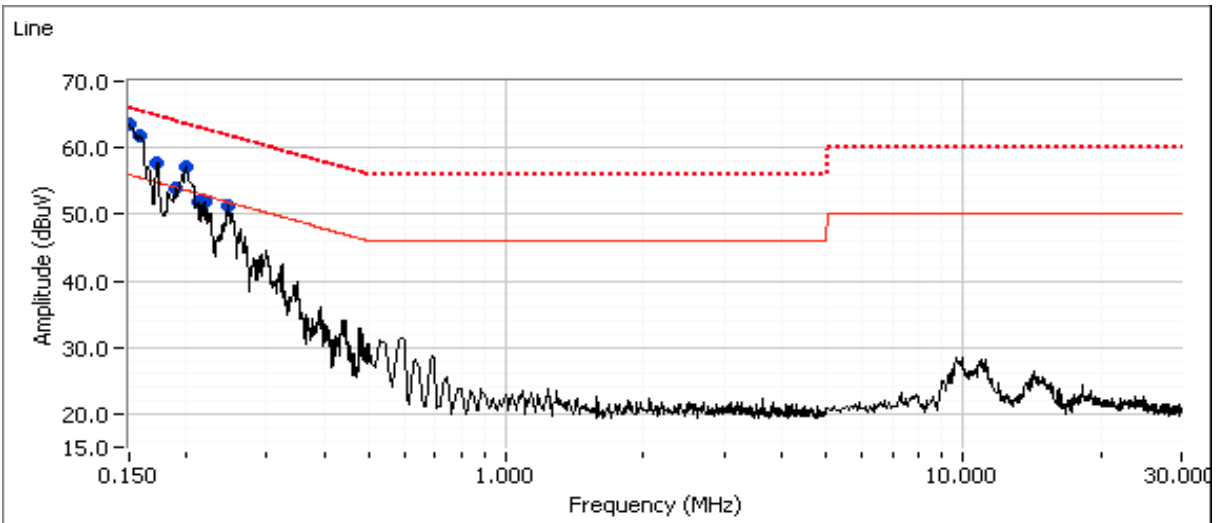
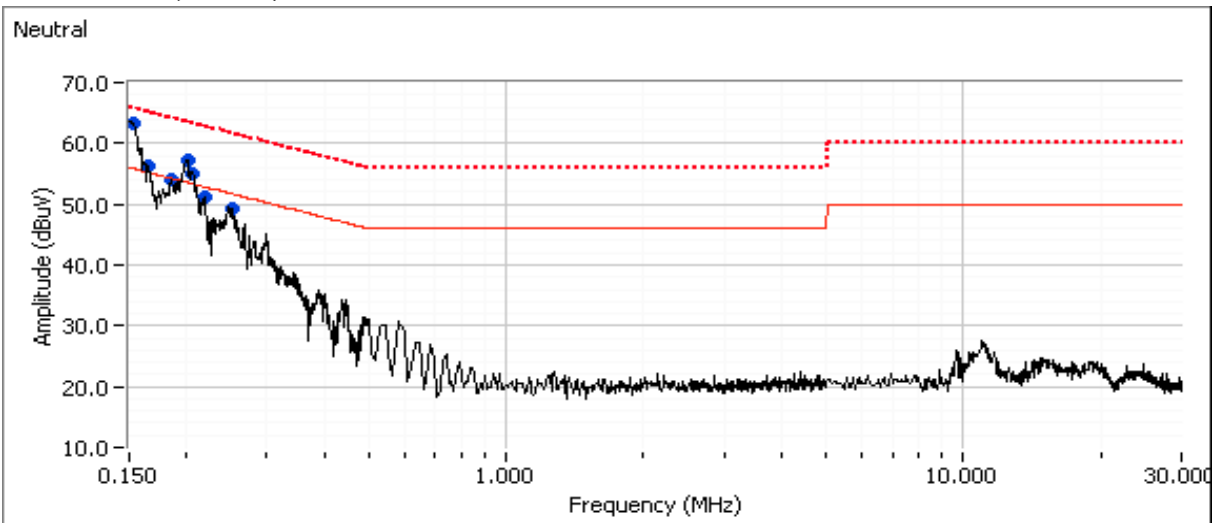



# EMC Test Data

Client:	Intel Corporation	Job Number:	J94914
Model:	7265D2W	T-Log Number:	T95472
		Project Manager:	Christine Krebill
Contact:	Steve Hackett	Project Coordinator:	-
Standard:	FCC Part 15.247, 15.407, RSS-210	Class:	N/A

**Preliminary peak readings captured during pre-scan (peak readings vs. average limit)**

Frequency MHz	Level dB $\mu$ V	AC Line	RSS 210 / 15.207		Detector QP/Ave	Comments
			Limit	Margin		
0.200	57.1	Neutral	53.6	3.5	Peak	
0.150	63.2	Neutral	55.8	7.4	Peak	
0.162	56.2	Neutral	55.2	1.0	Peak	
0.188	53.9	Neutral	54.2	-0.3	Peak	
0.207	55.0	Neutral	53.3	1.7	Peak	
0.219	51.3	Neutral	52.9	-1.6	Peak	
0.251	49.3	Neutral	51.7	-2.4	Peak	
0.152	63.6	Line	56.0	7.6	Peak	
0.160	61.9	Line	55.6	6.3	Peak	
0.174	57.7	Line	54.8	2.9	Peak	
0.198	57.0	Line	53.6	3.4	Peak	
0.190	54.0	Line	54.0	0.0	Peak	
0.210	52.0	Line	53.1	-1.1	Peak	
0.222	51.9	Line	52.8	-0.9	Peak	
0.246	51.2	Line	51.9	-0.7	Peak	



# EMC Test Data

Client:	Intel Corporation	Job Number:	J94914
Model:	7265D2W	T-Log Number:	T95472
Contact:	Steve Hackett	Project Manager:	Christine Krebill
Standard:	FCC Part 15.247, 15.407, RSS-210	Project Coordinator:	-
		Class:	N/A

## Final quasi-peak and average readings

Frequency MHz	Level dB $\mu$ V	AC Line	RSS 210 / 15.207		Detector QP/Ave	Comments
			Limit	Margin		
0.152	62.0	Line	65.9	-3.9	QP	QP (1.00s)
0.152	47.8	Line	55.9	-8.1	AVG	AVG (0.10s)
0.200	54.7	Neutral	63.6	-8.9	QP	QP (1.00s)
0.198	54.4	Line	63.7	-9.3	QP	QP (1.00s)
0.160	46.1	Line	55.5	-9.4	AVG	AVG (0.10s)
0.160	56.0	Line	65.5	-9.5	QP	QP (1.00s)
0.162	55.3	Neutral	65.4	-10.1	QP	QP (1.00s)
0.210	51.6	Line	63.2	-11.6	QP	QP (1.00s)
0.190	52.3	Line	64.0	-11.7	QP	QP (1.00s)
0.162	43.1	Neutral	55.4	-12.3	AVG	AVG (0.10s)
0.174	51.9	Line	64.8	-12.9	QP	QP (1.00s)
0.150	52.9	Neutral	66.0	-13.1	QP	QP (1.00s)
0.207	50.1	Neutral	63.3	-13.2	QP	QP (1.00s)
0.200	39.6	Neutral	53.6	-14.0	AVG	AVG (0.10s)
0.188	50.1	Neutral	64.1	-14.0	QP	QP (1.00s)
0.246	47.7	Line	61.9	-14.2	QP	QP (1.00s)
0.251	47.2	Neutral	61.7	-14.5	QP	QP (1.00s)
0.174	39.2	Line	54.8	-15.6	AVG	AVG (0.10s)
0.198	37.9	Line	53.7	-15.8	AVG	AVG (0.10s)
0.210	36.8	Line	53.2	-16.4	AVG	AVG (0.10s)
0.150	39.0	Neutral	56.0	-17.0	AVG	AVG (0.10s)
0.219	45.2	Neutral	62.9	-17.7	QP	QP (1.00s)
0.222	44.8	Line	62.7	-17.9	QP	QP (1.00s)
0.207	34.7	Neutral	53.3	-18.6	AVG	AVG (0.10s)
0.251	32.0	Neutral	51.7	-19.7	AVG	AVG (0.10s)
0.190	34.2	Line	54.0	-19.8	AVG	AVG (0.10s)
0.188	34.1	Neutral	54.1	-20.0	AVG	AVG (0.10s)
0.219	32.5	Neutral	52.9	-20.4	AVG	AVG (0.10s)
0.246	31.5	Line	51.9	-20.4	AVG	AVG (0.10s)
0.222	30.9	Line	52.7	-21.8	AVG	AVG (0.10s)

*End of Report*

This page is intentionally blank and marks the last page of this test report.