

WWAN Antenna Information

Lenovo 300w Yoga Gen 4

[High-tek antenna]

Platform	Convertible PC	
Platform owner	Lenovo	
Platform name	Lenovo 300W Yoga Gen 4	
Regulatory Model name (Compliance ID)	Lenovo 300W Yoga Gen 4	
ODM	Wistron	
Target Launch Date	2023/02/28	
Tx Antenna		
Brand name	High-tek	
Parts Number	Main Antenna:	025.90270.0001
	Auxiliary Antenna:	025.90271.0001 (RX Only)
Transmitter Module		
WWAN Module	Model: Fibocom FM101-GL	FCC ID: ZMOFM101GL IC: 21374-FM101GL

Revision history

Revision number	Date	Description
1	2022/12/19	Initial release

Section 1. Antenna Assembly Specifications

Main Antenna

Antenna Part Number	Manufacturer	Antenna Type	Cable Assembly Part Number and Information	Frequency (MHz)	Cable Loss (dB)	Peak Gain (including cable loss)		
						Horizontal (dBi)	Vertical (dBi)	
Main P/N:025.90 270.0001	High-tek	PIFA	1. Cable P/N: Shen-Yu 2. Diameter:1.13mm 50 ohm coaxial cable 3.Cable length: 167 mm 4. Connector P/N: CM: 958-C413-W-B- Bu-A0	EU/ANZ/CN/Japan UMTS/HSPA (UMTS 2100, Band 1) (UE-UTRA, Band 1, n1)	1920.00	0.4	0.66	-5.16
					1950.00	0.4	1.05	-4.19
					1980.00	0.44	1.01	-3.31
				FCC Part 24 GSM/GPRS/EDGE (GSM 1900) UMTS/HSPA/EVDO (UMTS1900, Band 2) (UE-UTRA, Band 2, n2)	1850.00	0.46	0.08	-6.82
					1880.00	0.39	0.33	-6.67
					1910.00	0.4	0.61	-5.57
				EU/ANZ/CN/Japan GSM/GPRS/EDGE (GSM 1800, Band 3) (UE-UTRA, Band 3, n3)	1710.00	0.37	1.22	-11.28
					1747.50	0.41	0.63	-9.65
					1785.00	0.45	-0.01	-8.2
				FCC Part 27 UMTS(AWS) / HSPA (UMTS, Band 4) (UE-UTRA, Band 4)	1710.00	0.37	1.22	-11.28
					1732.50	0.36	0.9	-10.26
					1755.00	0.46	0.56	-9.2
				FCC Part 22 GSM/GPRS/EDGE (GSM 850) ANZ (UMTS850, Band 5) (UE-UTRA, Band 5, n5)	824.00	0.26	-3.32	-7.18
					836.50	0.26	-3.24	-6.13
					849.00	0.26	-3.59	-5.27
				Japan (UMTS, Band 6)	830.00	0.26	-3.18	-6.67
					835.00	0.26	-3.21	-6.37
					840.00	0.26	-3.31	-5.78
				FCC Part 27 CA/EU/ANZ (UE-UTRA, Band 7, n7)	2500.00	0.48	0.94	-4.54
					2535.00	0.6	1.77	-3.73
					2570.00	0.49	1.89	-2.74
				EU/ANZ/Japan UMTS/HSPA (UMTS 900, Band 8) (UE-UTRA, Band 8, n8)	880.00	0.26	-3.71	-5.02
					897.50	0.27	-3.38	-6.01
					915.00	0.27	-2.7	-7
				Japan (WCDMA, Band 9)	1844.9	0.46	-0.05	-6.95
					1862.5	0.43	0.15	-6.94
					1879.9	0.39	0.28	-6.68
				FCC Part 27 (UE-UTRA, Band 12, n12)	699.00	0.23	-3.52	-7.69
					707.50	0.23	-3.15	-8.26
					716.00	0.22	-2.78	-8.66
FCC Part 27 (UE-UTRA, Band 13)	777.00	0.25	-3.1	-8.16				
	782.00	0.25	-3.4	-8.36				
	787.00	0.25	-3.66	-8.62				
FCC Part 90 (UE-UTRA, Band 14)	788.00	0.25	-3.71	-8.68				
	793.00	0.25	-3.88	-8.73				
	798.00	0.25	-3.91	-8.6				
FCC Part 27 (UE-UTRA, Band 17)	704.00	0.23	-3.27	-8.13				
	710.00	0.23	-2.97	-8.46				
	716.00	0.22	-2.78	-8.66				
Japan (UE-UTRA, Band 18)	815.00	0.26	-3.75	-7.7				
	822.50	0.26	-3.31	-7.25				
	830.00	0.26	-3.18	-6.67				
Japan	830.00	0.26	-3.18	-6.67				

Antenna Part Number	Manufacturer	Antenna Type	Cable Assembly Part Number and Information	Frequency (MHz)		Cable Loss (dB)	Peak Gain (including cable loss)	
							Horizontal (dBi)	Vertical (dBi)
				(UMTS, Band 19) (UE-UTRA, Band 19)	837.50	0.26	-3.24	-6.08
					845.00	0.26	-3.38	-5.49
				EU (UE-UTRA, Band 20, n20)	832.00	0.26	-3.17	-6.62
					847.00	0.26	-3.48	-5.38
					862.00	0.26	-3.59	-4.85
				FCC Part 24 (UE-UTRA, Band 25)	1850.00	0.46	0.08	-6.82
					1882.50	0.39	0.39	-6.58
					1915.00	0.4	0.59	-5.4
				FCC Part 90, 22H (UE-UTRA, Band 26)	814.00	0.25	-3.79	-7.77
					831.50	0.26	-3.18	-6.58
					849.00	0.26	-3.59	-5.27
				EU/ANZ/Japan (UE-UTRA, Band 28, n28)	703.00	0.23	-3.4	-8
					725.50	0.22	-2.58	-8.27
					748.00	0.23	-3.32	-7.12
				FCC Part 27 CA (UE-UTRA, Band 29) * Down link only	717.00	0.22	-2.77	-8.74
					722.50	0.22	-2.62	-8.51
					728.00	0.22	-2.62	-8
				FCC Part 27 (UE-UTRA, Band 30)	2305.00	0.48	-0.42	-5.08
					2310.00	0.48	-0.42	-5.09
					2315.00	0.52	-0.35	-5.54
				EU (LTE, Band 32) * Down link only	1452.00	0.32	-4.2	-11.46
					1474.00	0.33	-3.69	-11.49
					1496.00	0.36	-2.6	-11.56
				EU (LTE Band 34)	2010.00	0.43	0.47	-2.92
					2017.50	0.44	0.48	-2.99
					2025.00	0.5	0.52	-3.11
				EU/CN (UE-UTRA, Band 38, n38)	2570.00	0.49	1.89	-2.74
					2595.00	0.42	1.85	-2.05
					2620.00	0.48	1.88	-1.46
				CN (TD-SCDMA, Band 39)	1880.00	0.39	0.33	-6.67
					1900.00	0.39	0.4	-6.19
					1920.00	0.4	0.66	-5.16
				EU/ANZ/CN (UE-UTRA, Band 40)	2300.00	0.47	-0.34	-4.9
					2350.00	0.49	0.04	-4.73
					2400.00	0.45	-0.05	-4.88
				FCC Part 27 US/CN/Japan (UE-UTRA, Band 41, n41)	2496.00	0.48	0.93	-4.48
					2593.00	0.4	1.77	-2.24
					2690.00	0.48	1.84	-0.8
				FCC Part 96 CA/EU/Japan (LTE Band 42)	3400.00	0.51	2.33	-4.48
					3500.00	0.57	2.24	-2.73
3600.00	0.42	3.39	-2.57					
EU (LTE Band 43)	3600.00	0.42	3.39	-2.57				
	3700.00	0.56	3.2	-3.69				
	3800.00	0.49	1.94	-3.8				
FCC Part 15, 90, 95 (LTE Band 46) TD Unlicensed, LAA RCV only	5150.00	0.82	-1.74	-3.83				
	5537.00	0.73	-2.78	0.03				
	5925.00	0.8	-4.26	-4.49				
FCC Part 96 (LTE Band 48)	3550.00	0.57	1.99	-1.53				
	3625.00	0.49	2.67	-2.91				
	3700.00	0.56	2.2	-3.69				
FCC Part 27 (LTE, Band 66, n66)	1710.00	0.37	1.22	-11.28				
	1745.00	0.41	0.72	-9.97				

Antenna Part Number	Manufacturer	Antenna Type	Cable Assembly Part Number and Information	Frequency (MHz)		Cable Loss (dB)	Peak Gain (including cable loss)	
							Horizontal (dBi)	Vertical (dBi)
					1780.00	0.48	0.13	-8.4
				FCC Part 24, 27 (LTE Band 71, n71)	663.00	0.22	-2.21	-5.18
					680.50	0.22	-3.28	-6.26
					698.00	0.23	-3.55	-7.55
				FCC/EU/CN/JP (5G NR Band 77)	3300.00	0.46	-1.3	-3.32
					3750.00	0.59	2.52	-4.15
					4200.00	0.62	-1.06	-3.4
				EU/CN/JP (5G NR Band 78)	3300.00	0.46	-1.3	-3.32
					3550.00	0.57	2.49	-1.53
					3800.00	0.49	1.94	-3.8
				CN/JP (5G NR Band 79)	4400.00	0.67	-3.16	-4.28
					4700.00	0.68	-6.09	-5.99
					5000.00	0.68	-2.98	-3.67
				Japan (UE-UTRA, Band 21)	1455.40	0.32	-4.2	-11.46
					1462.90	0.32	-3.69	-11.49
					1477.90	0.35	-2.6	-11.56
				Japan J-CDMA	815.00	0.26	-3.75	-7.7
					824.70	0.26	-3.25	-6.92
					836.50	0.26	-3.24	-6.13
					848.30	0.26	-3.53	-5.32
					870.00	0.26	-3.67	-4.91
					880.20	0.26	-3.74	-5.07
					897.60	0.27	-3.04	-6.5
					914.80	0.27	-2.7	-7
					925.00	0.27	-2.56	-7.64
					940.00	0.27	-2.22	-8.79
				Japan J-CDMA	1922.40	0.4	0.7	-4.94
					1950.00	0.4	1.05	-4.19
					1977.60	0.44	1.1	-3.51

Section 2. Dimensioned Photos or Drawings of Antennas

Main Antenna Dimensioned Drawing:

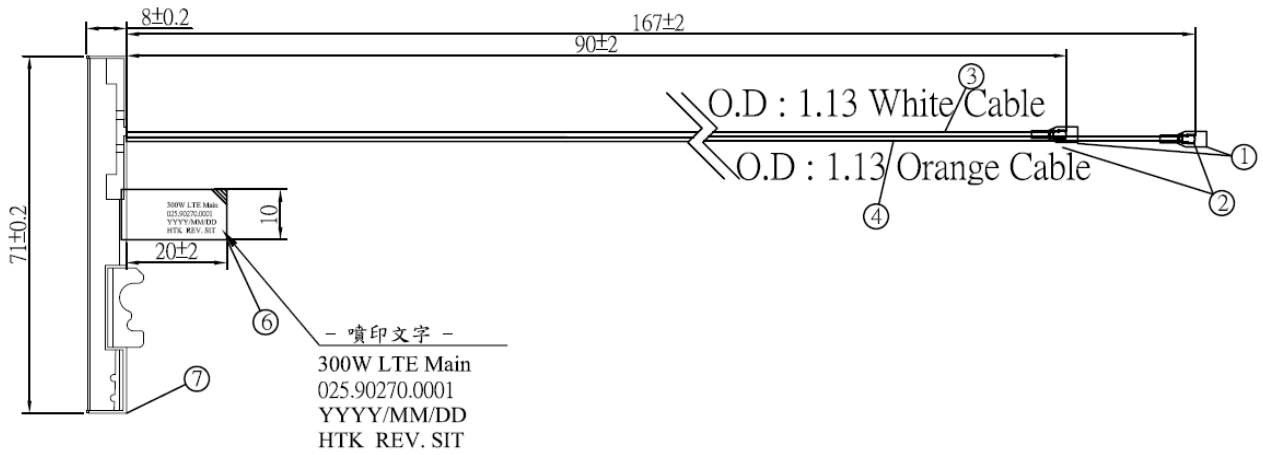

Main Antenna Photo:

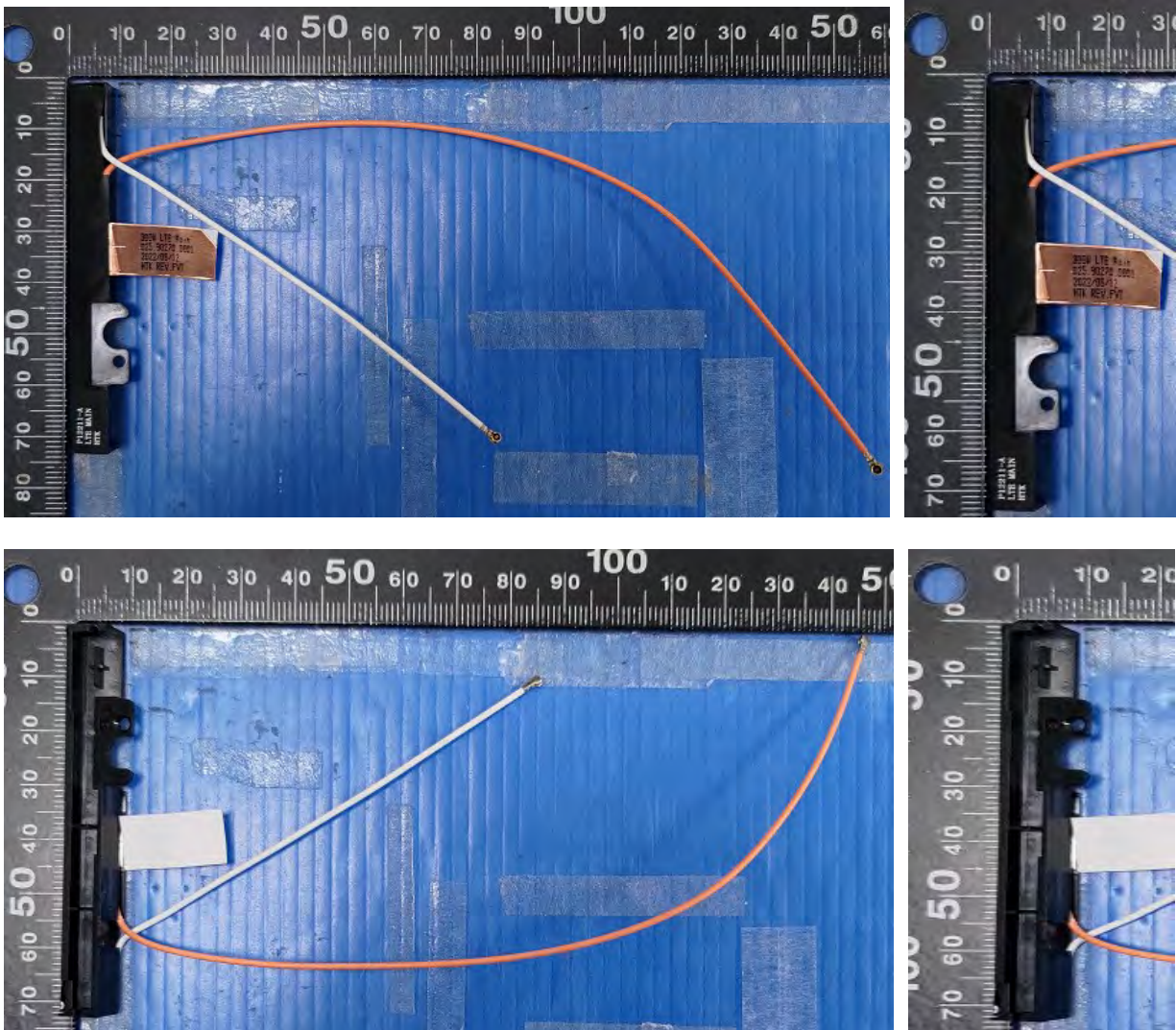

Trade Name: High-tek
Model No.: 025.90270.0001 (Main)
025.90271.0001 (Aux)

Front view

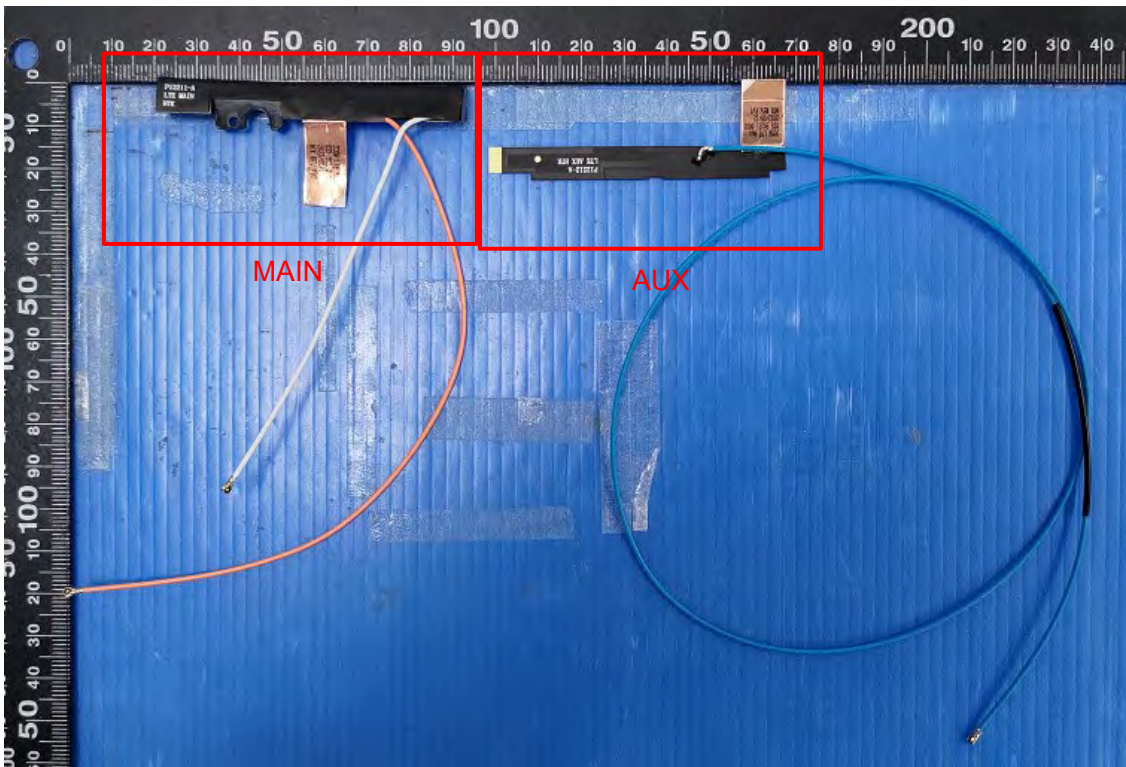

Trade Name: High-tek
Model No.: 025.90270.0001 (Main)
025.90271.0001 (Aux)

Back view

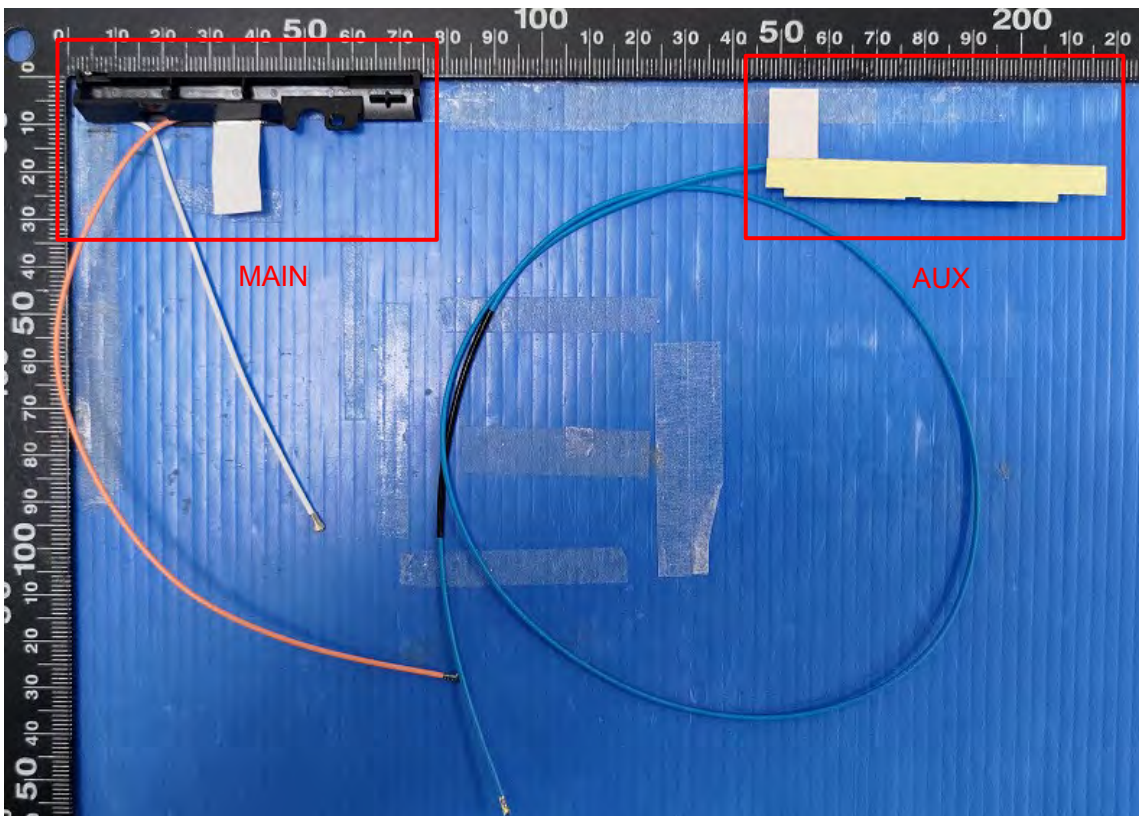

Section 3. Radiation characteristics of antenna

Antenna Gain and Radiation Pattern Measuring Structure Diagram

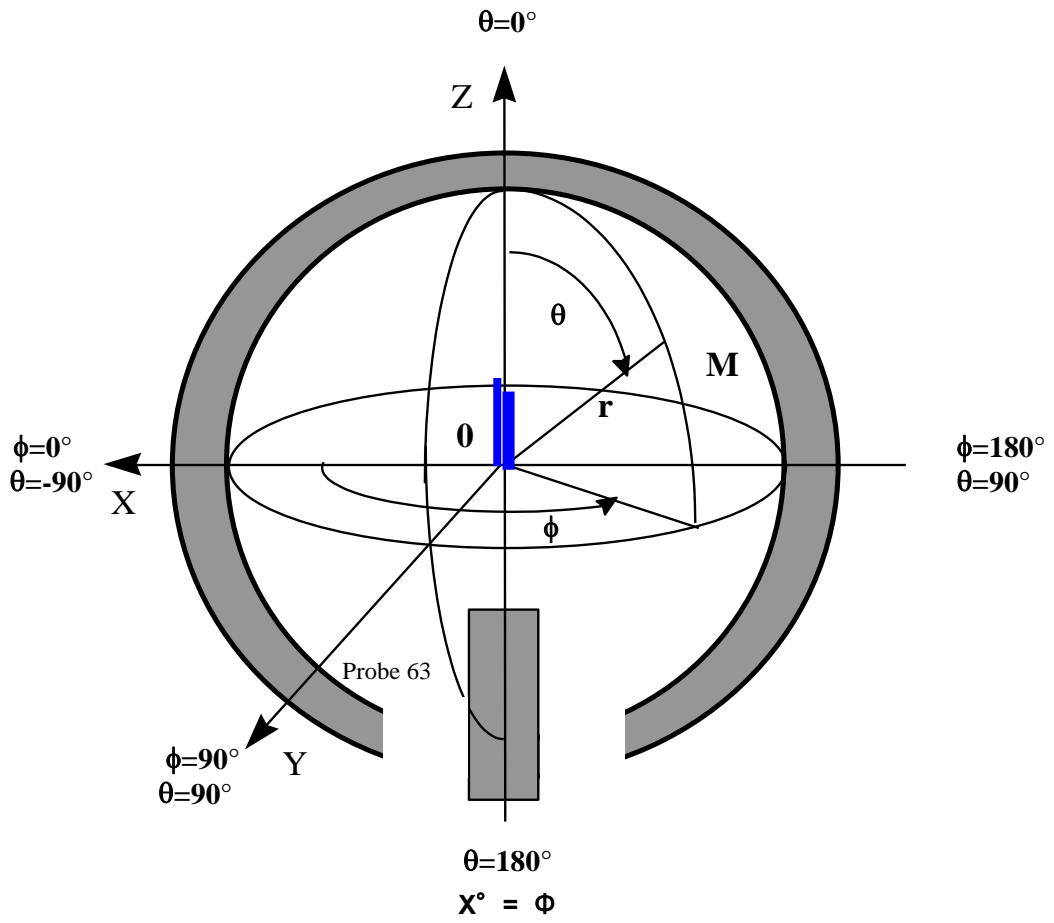

Radiation characteristic in 1920MHz ~ 1980MHz (EU/ANZ/CN/JP: UMTS/HSDPA, Band 1, n1)

Main antenna: 1920.00 MHz

1920.00 MHz	
Horizontal Peak (dBi)	0.66
Vertical Peak(dBi)	-5.16

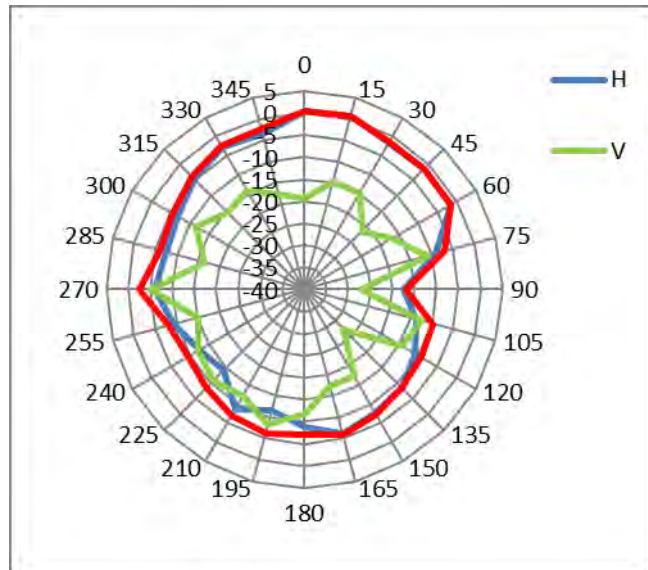

Main antenna: 1950.00 MHz

1950.00 MHz	
Horizontal Peak (dBi)	1.05
Vertical Peak(dBi)	-4.19

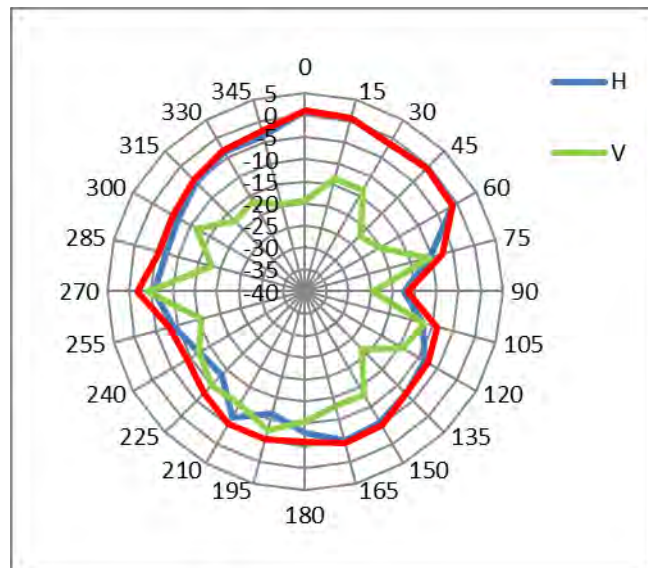

Main antenna: 1980.00 MHz

1980.00 MHz	
Horizontal Peak (dBi)	1.01
Vertical Peak(dBi)	-3.31

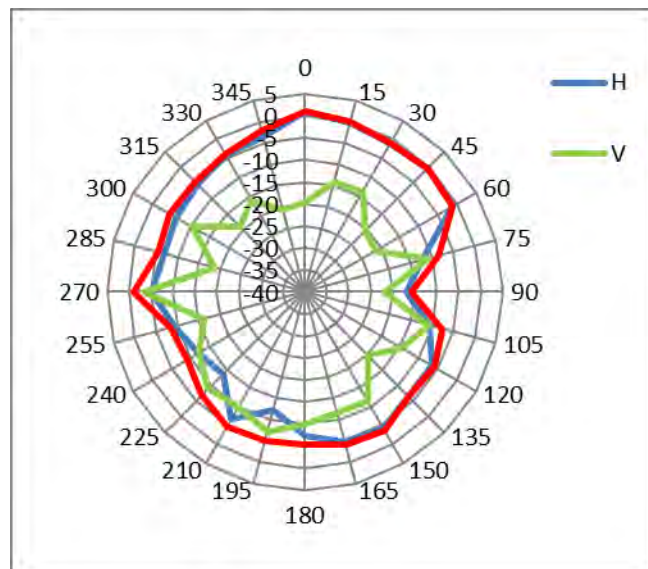

Radiation characteristic in 1850MHz ~ 1910MHz (FCC Part 24 PCS, Band 2, n2)

Main antenna: 1850.00 MHz

1850.00 MHz	
Horizontal Peak (dBi)	0.08
Vertical Peak(dBi)	-6.82

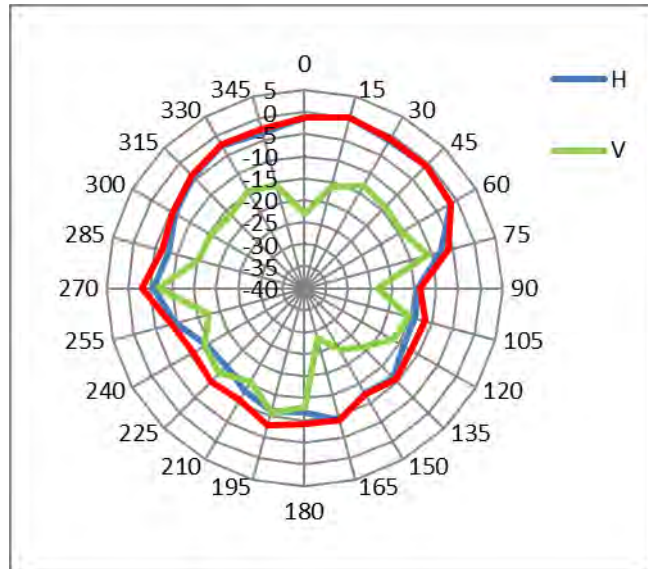

Main antenna: 1880.00 MHz

1880.00 MHz	
Horizontal Peak (dBi)	0.33
Vertical Peak(dBi)	-6.67

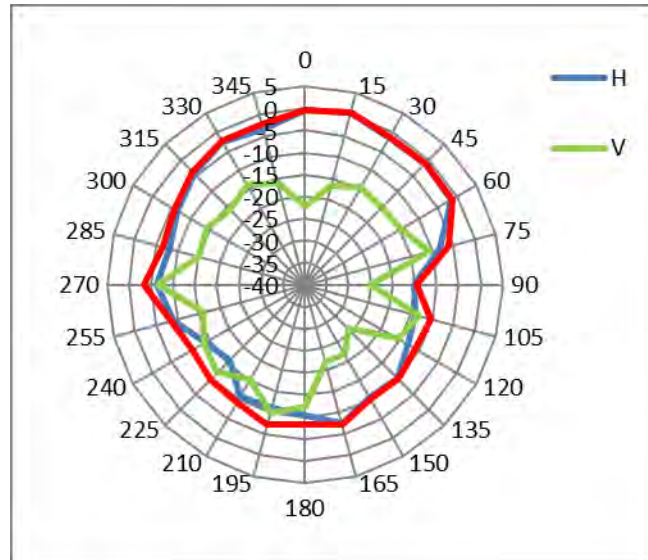

Main antenna: 1910.00 MHz

1910.00 MHz	
Horizontal Peak (dBi)	0.61
Vertical Peak(dBi)	-5.57

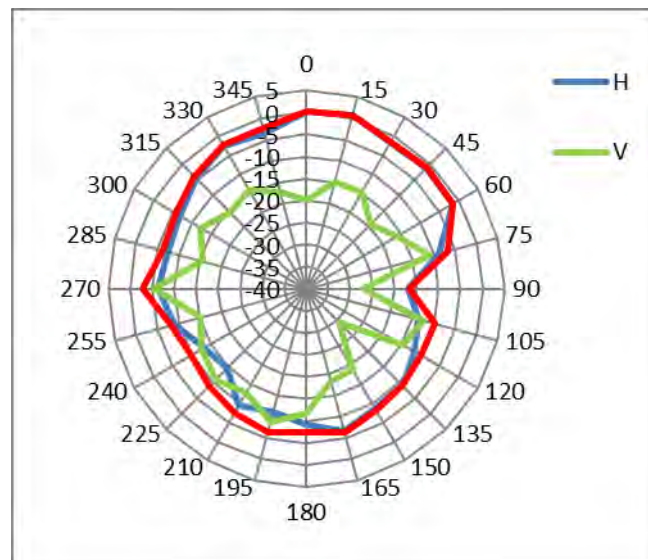

Radiation characteristic in 1710MHz ~ 1785MHz (EU/ANZ/CN/JP: UE-UTRA, Band 3, n3)

Main antenna: 1710.00 MHz

1710.00 MHz	
Horizontal Peak (dBi)	1.22
Vertical Peak(dBi)	-11.28

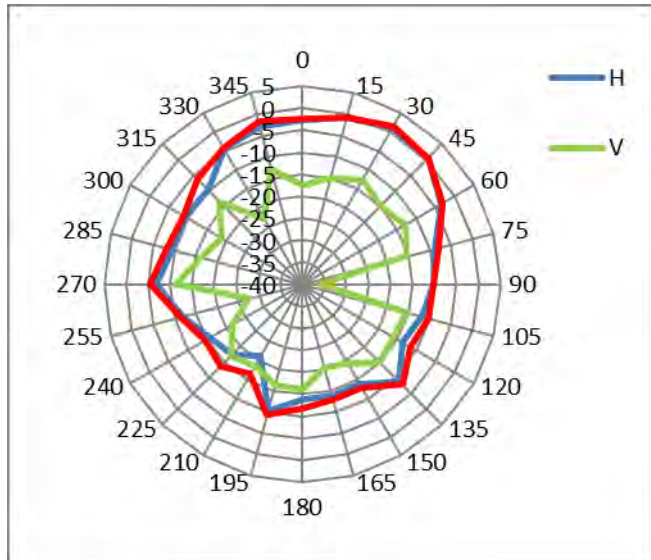

Main antenna: 1747.50 MHz

1747.50 MHz	
Horizontal Peak (dBi)	0.63
Vertical Peak(dBi)	-9.65

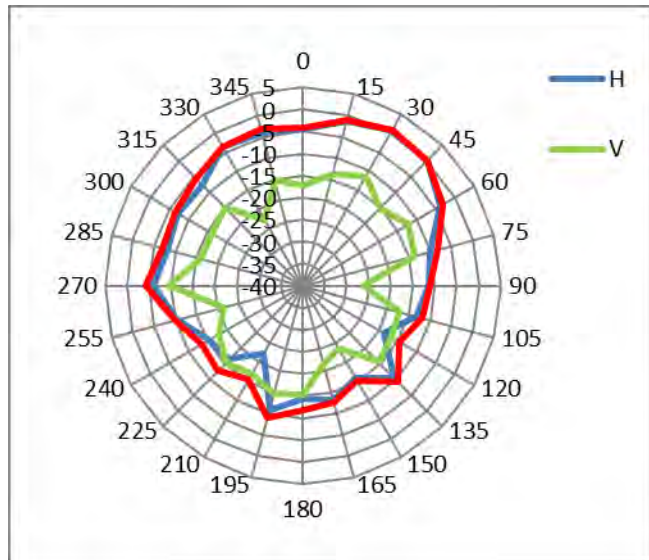

Main antenna: 1785.00 MHz

1785.00 MHz	
Horizontal Peak (dBi)	-0.01
Vertical Peak(dBi)	-8.2

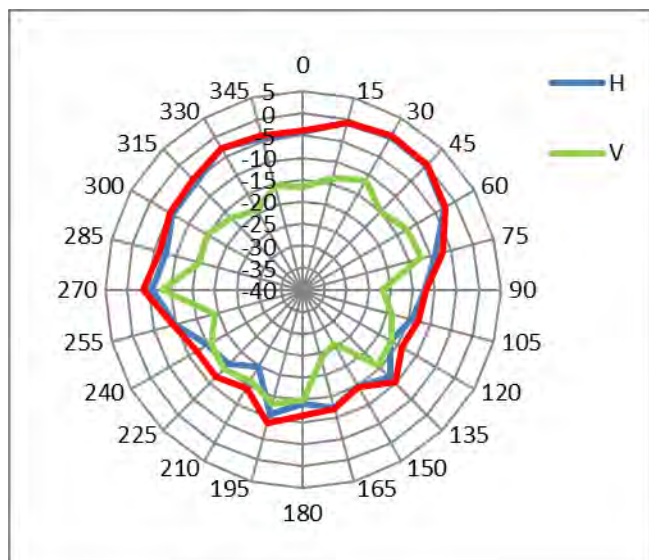

Radiation characteristic in 1710MHz ~ 1755MHz (FCC Part 27 UMTS(AWS), Band 4)

Main antenna: 1710.00 MHz

1710.00 MHz	
Horizontal Peak (dBi)	1.22
Vertical Peak(dBi)	-11.28

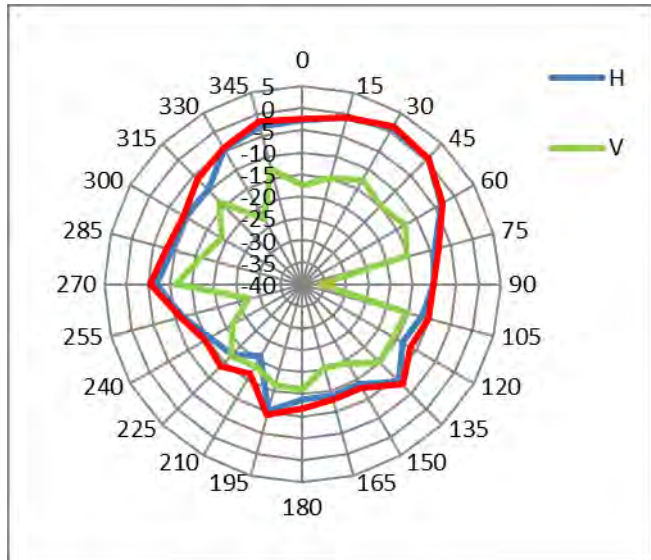

Main antenna: 1732.50 MHz

1732.50 MHz	
Horizontal Peak (dBi)	0.9
Vertical Peak(dBi)	-10.26

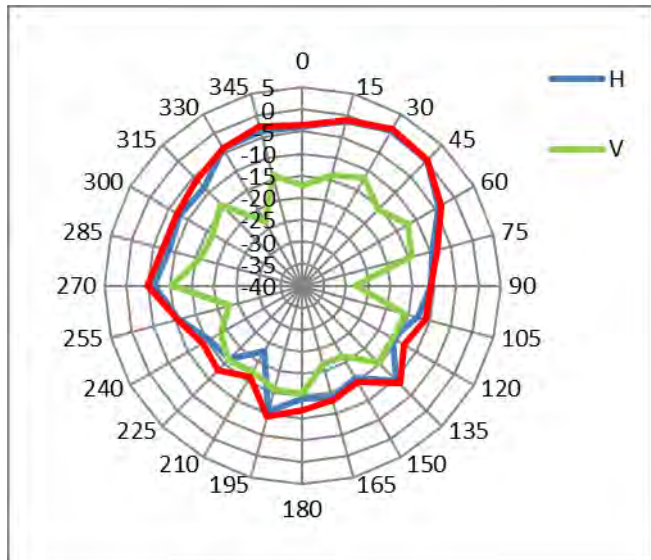

Main antenna: 1755.00 MHz

1755.00 MHz	
Horizontal Peak (dBi)	0.56
Vertical Peak(dBi)	-9.2

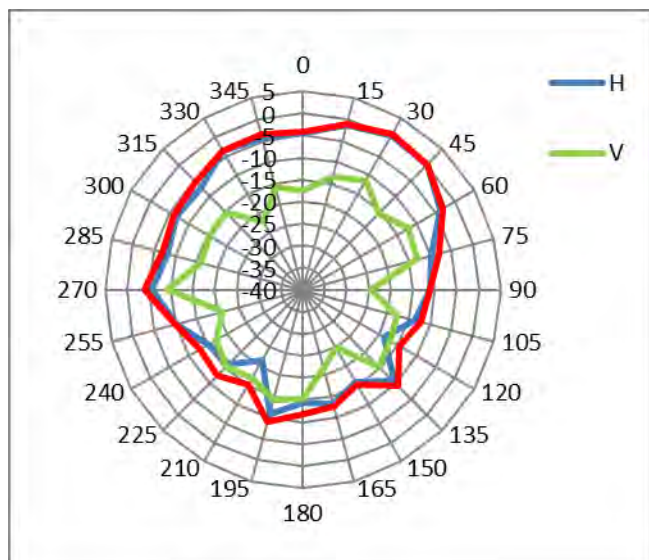

Radiation characteristic in 824MHz ~ 849MHz (FCC Part 22 Cellular, Band 5, n5)

Main antenna: 824.00 MHz

824.00 MHz	
Horizontal Peak (dBi)	-3.32
Vertical Peak(dBi)	-7.18

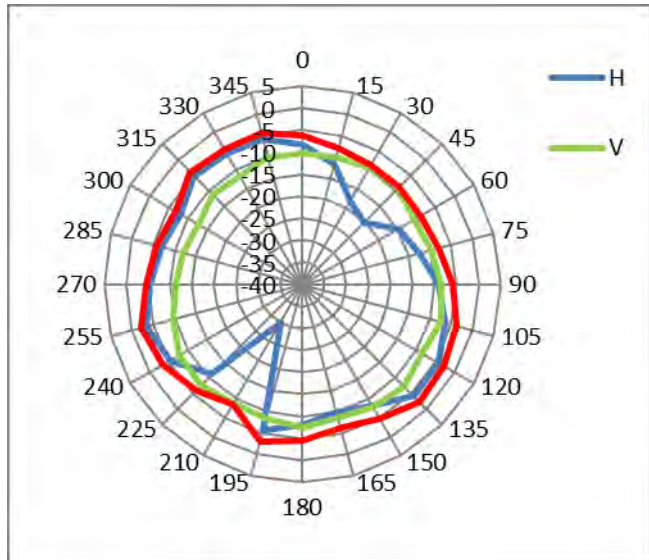

Main antenna: 836.50 MHz

836.50 MHz	
Horizontal Peak (dBi)	-3.24
Vertical Peak(dBi)	-6.13

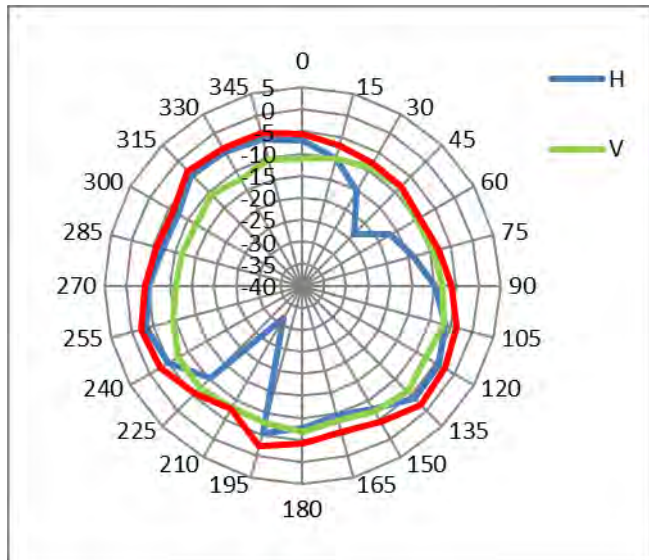

Main antenna: 849.00 MHz

849.0 MHz	
Horizontal Peak (dBi)	-3.59
Vertical Peak(dBi)	-5.27

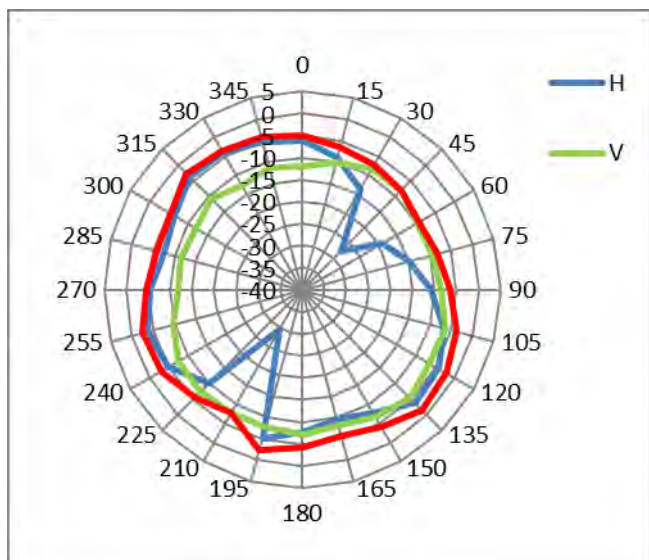

Radiation characteristic in 830MHz ~ 840MHz (Japan, Band 6)

Main antenna: 830.00 MHz

830.00 MHz	
Horizontal Peak (dBi)	-3.18
Vertical Peak(dBi)	-6.67

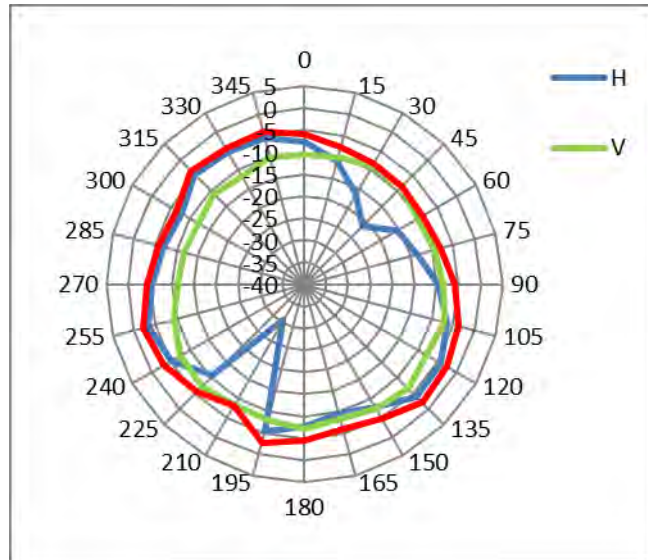

Main antenna: 835.00 MHz

835.00 MHz	
Horizontal Peak (dBi)	-3.21
Vertical Peak(dBi)	-6.37

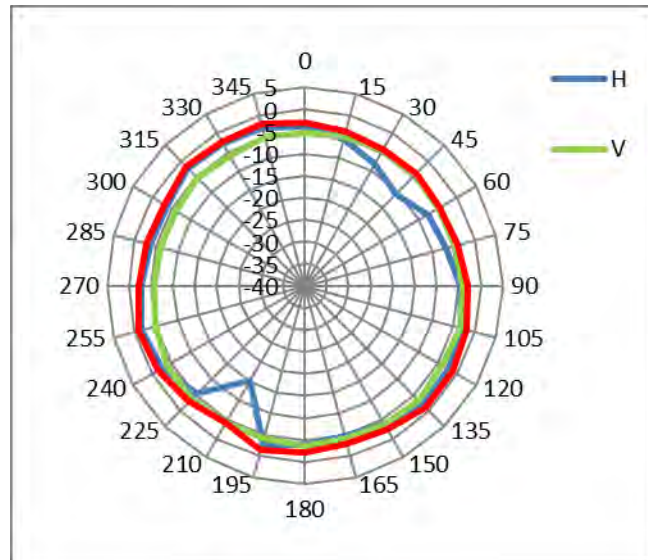

Main antenna: 840.00 MHz

840.00 MHz	
Horizontal Peak (dBi)	-3.31
Vertical Peak(dBi)	-5.78

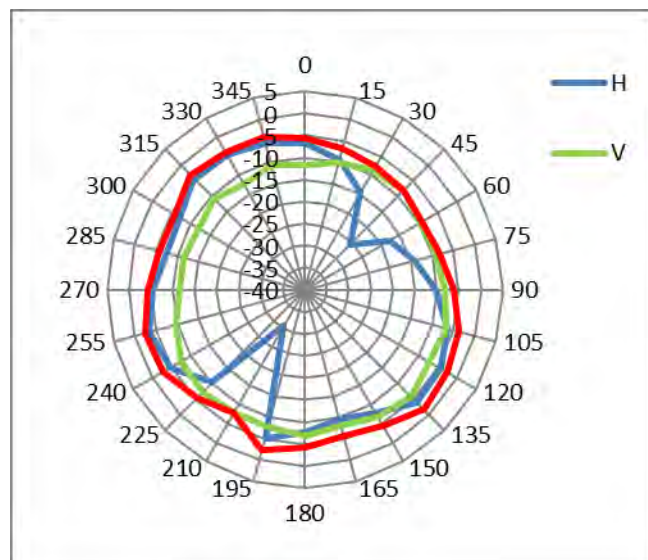

Radiation characteristic in 2500MHz ~ 2570MHz (CA/EU/ANZ UE-UTRA, Band 7, n7)

Main antenna: 2500.00 MHz

2500.00 MHz	
Horizontal Peak (dBi)	0.94
Vertical Peak(dBi)	-4.54

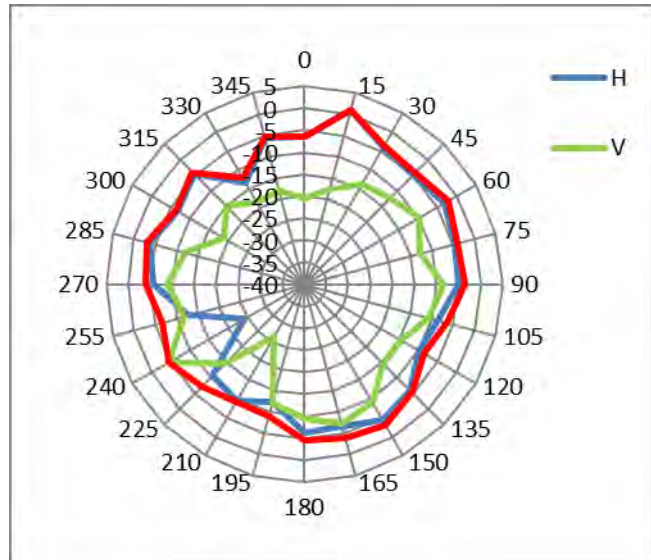

Main antenna: 2535.00 MHz

2535.00 MHz	
Horizontal Peak (dBi)	1.77
Vertical Peak(dBi)	-3.73

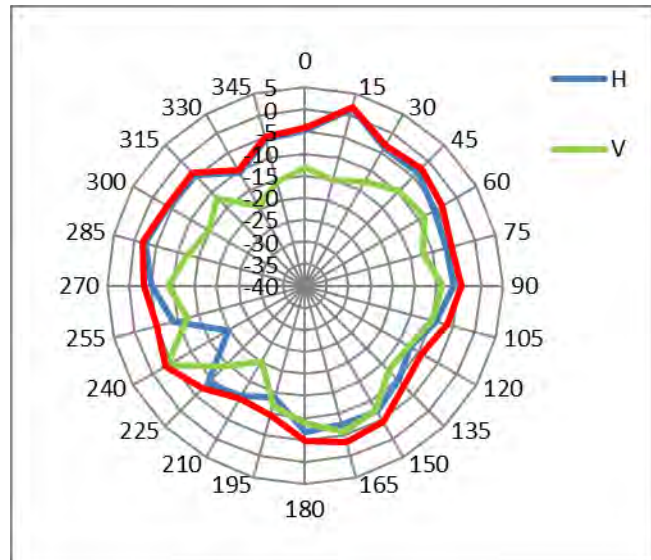

Main antenna: 2570.00 MHz

2570.00 MHz	
Horizontal Peak (dBi)	1.89
Vertical Peak(dBi)	-2.74

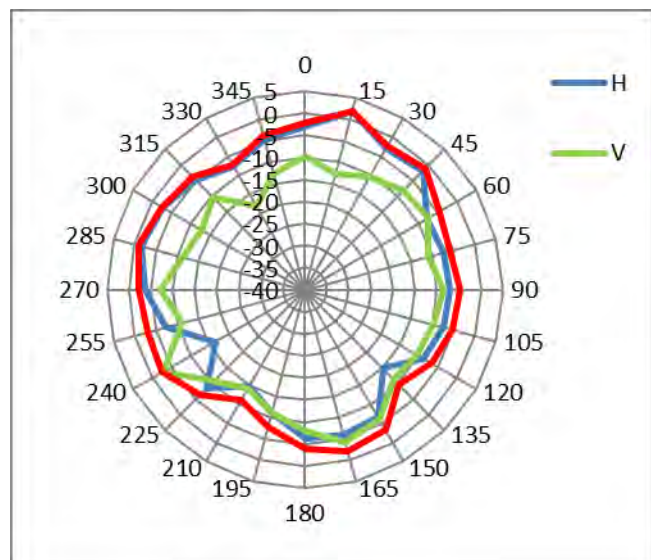

Radiation characteristic in 880MHz ~ 915MHz (EU/ANZ/JP: Band 8, n8)

Main antenna: 880.00 MHz

880.00 MHz	
Horizontal Peak (dBi)	-3.71
Vertical Peak(dBi)	-5.02

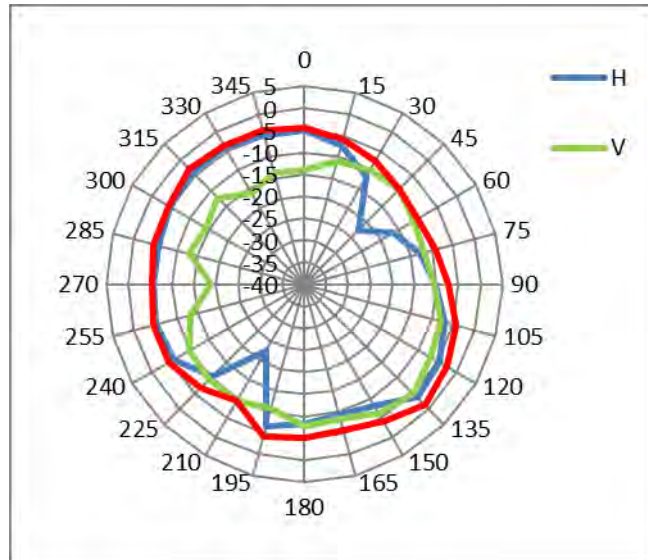

Main antenna: 897.50 MHz

897.50 MHz	
Horizontal Peak (dBi)	-3.38
Vertical Peak(dBi)	-6.01

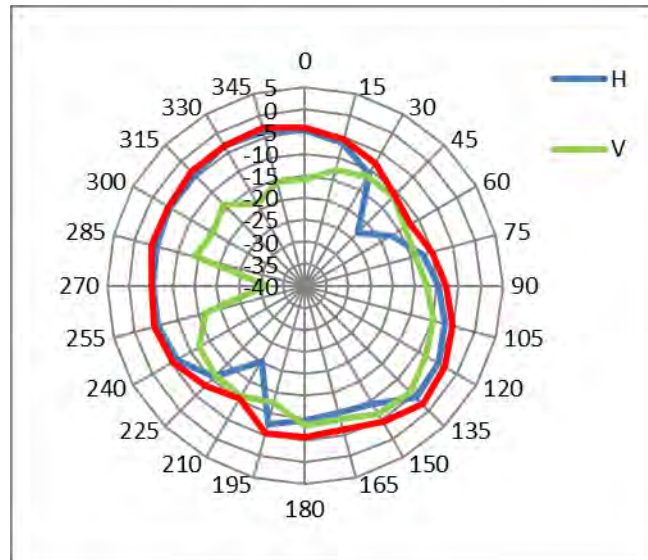

Main antenna: 915.00 MHz

915.00 MHz	
Horizontal Peak (dBi)	-2.7
Vertical Peak(dBi)	-7

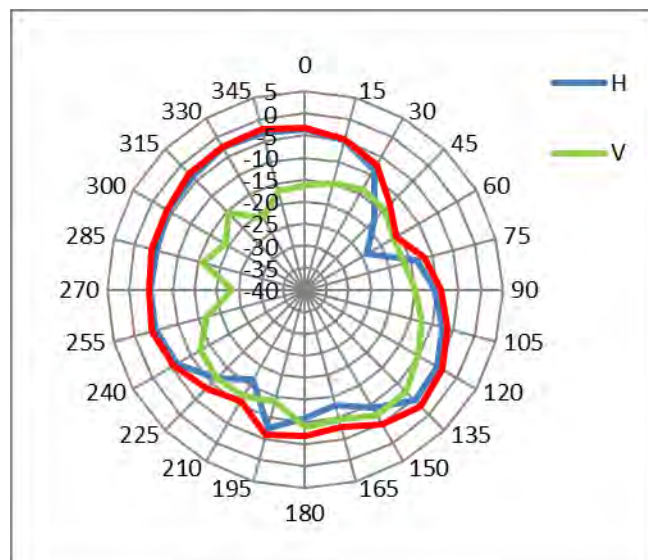

Radiation characteristic in 1844.9MHz ~ 1879.9MHz (WCDMA: Band 9, n9)

Main antenna: 1844.90 MHz

1844.90 MHz	
Horizontal Peak (dBi)	-0.05
Vertical Peak(dBi)	-6.95

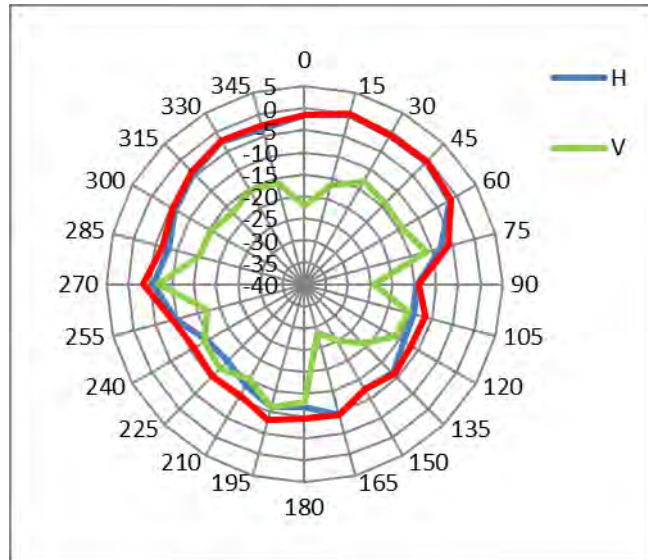

Main antenna: 1862.50 MHz

1862.50 MHz	
Horizontal Peak (dBi)	0.15
Vertical Peak(dBi)	-6.94

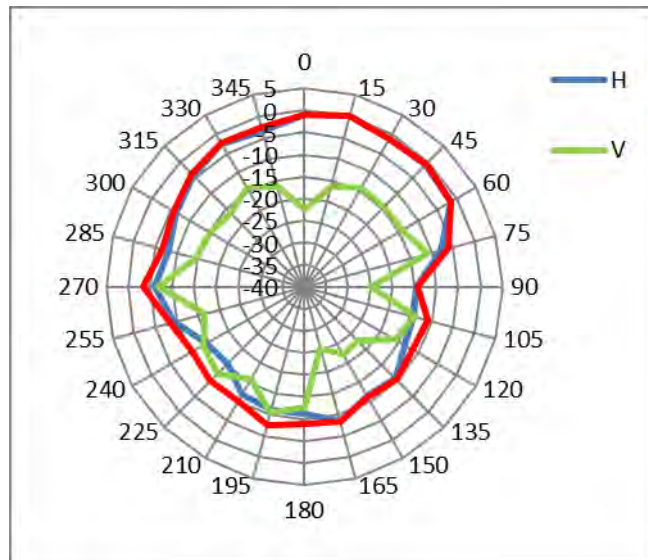

Main antenna: 1879.90 MHz

1879.90 MHz	
Horizontal Peak (dBi)	0.28
Vertical Peak(dBi)	-6.68

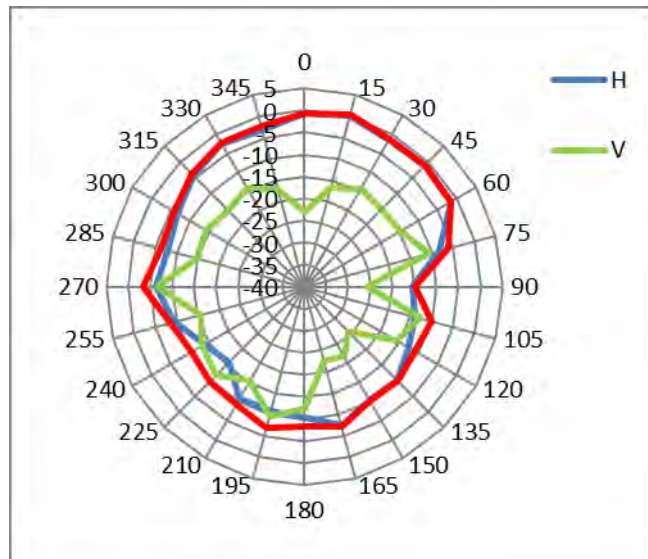

Radiation characteristic in 699MHz ~ 716MHz (FCC Part 27 UE-UTRA, Band 12, n12)

Main antenna: 699.00 MHz

699.00 MHz	
Horizontal Peak (dBi)	-3.52
Vertical Peak(dBi)	-7.69

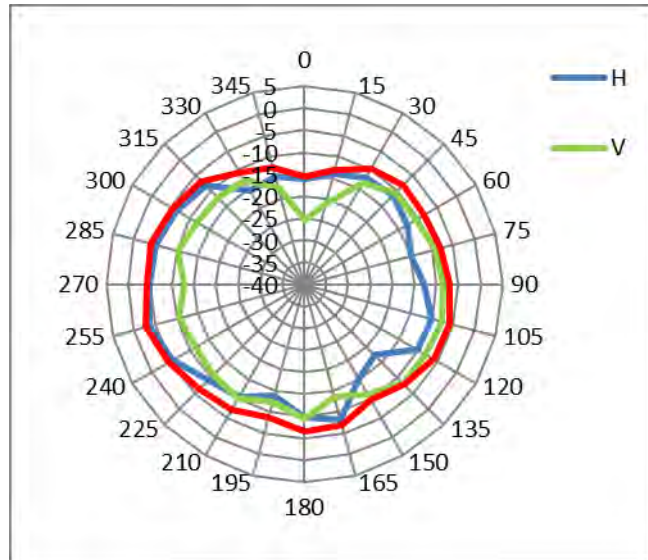

Main antenna: 707.50 MHz

707.50 MHz	
Horizontal Peak (dBi)	-3.15
Vertical Peak(dBi)	-8.26

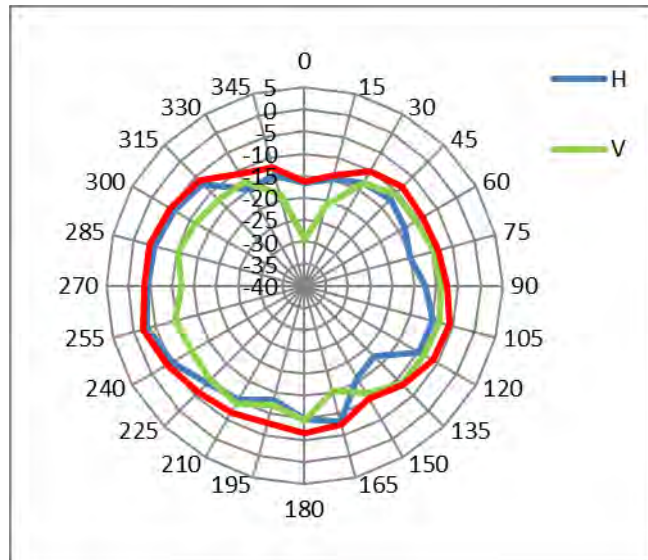

Main antenna: 716.00 MHz

716.00 MHz	
Horizontal Peak (dBi)	-2.78
Vertical Peak(dBi)	-8.66

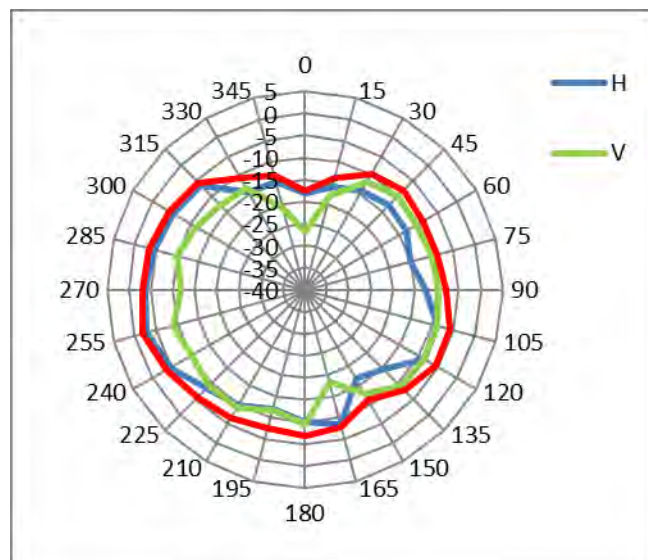

Radiation characteristic in 777MHz ~ 787MHz (FCC Part 27 UE-UTRA, Band 13)

Main antenna: 777.00 MHz

777.00 MHz	
Horizontal Peak (dBi)	-3.1
Vertical Peak(dBi)	-8.16

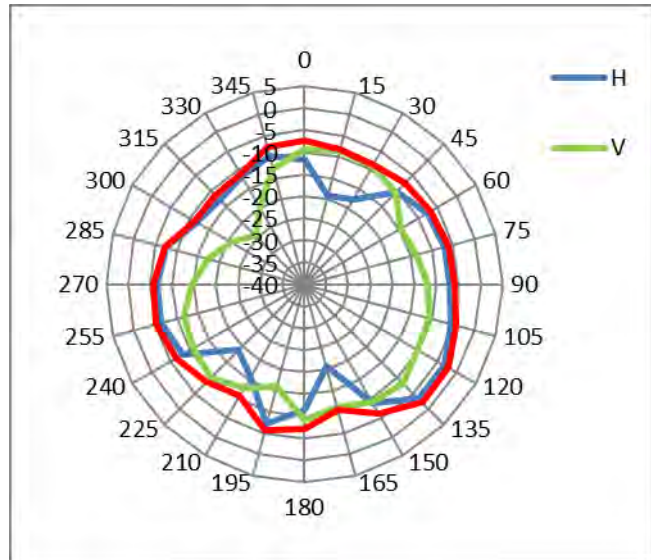

Main antenna: 782.00 MHz

782.00 MHz	
Horizontal Peak (dBi)	-3.4
Vertical Peak(dBi)	-8.36

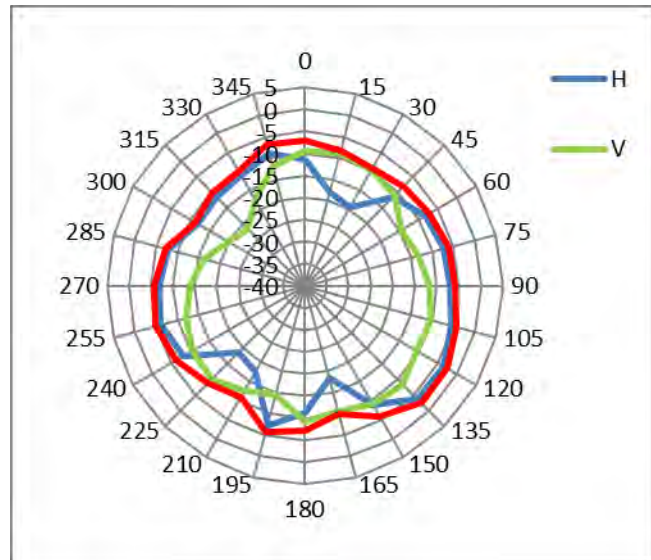

Main antenna: 787.00 MHz

787.00 MHz	
Horizontal Peak (dBi)	-3.66
Vertical Peak(dBi)	-8.62

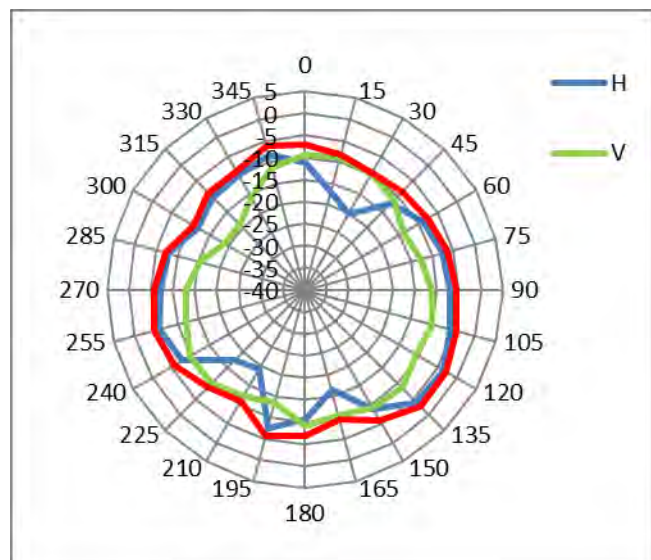

Radiation characteristic in 788MHz ~ 798MHz (FCC Part 90 UE-UTRA, Band 14)

Main antenna: 788.00 MHz

788.00 MHz	
Horizontal Peak (dBi)	-3.71
Vertical Peak(dBi)	-8.68

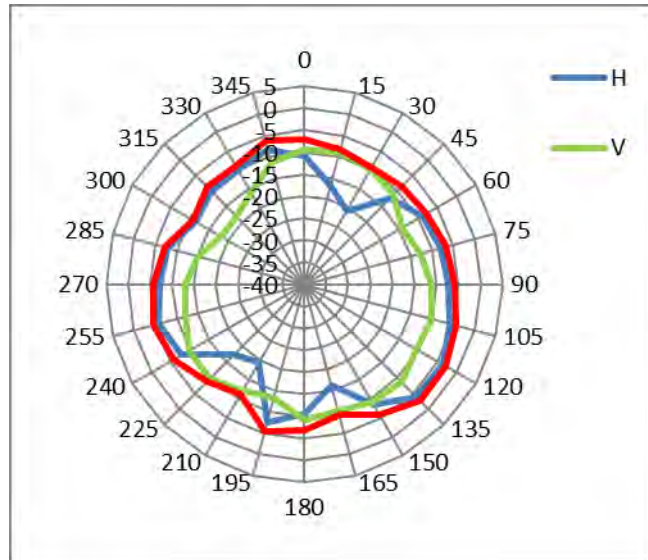

Main antenna: 793.00 MHz

793.00 MHz	
Horizontal Peak (dBi)	-3.88
Vertical Peak(dBi)	-8.73

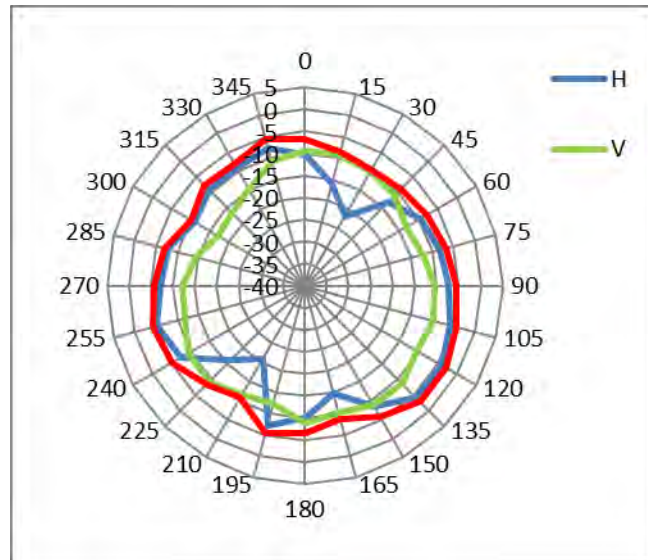

Main antenna: 798.00 MHz

798.00 MHz	
Horizontal Peak (dBi)	-3.91
Vertical Peak(dBi)	-8.6

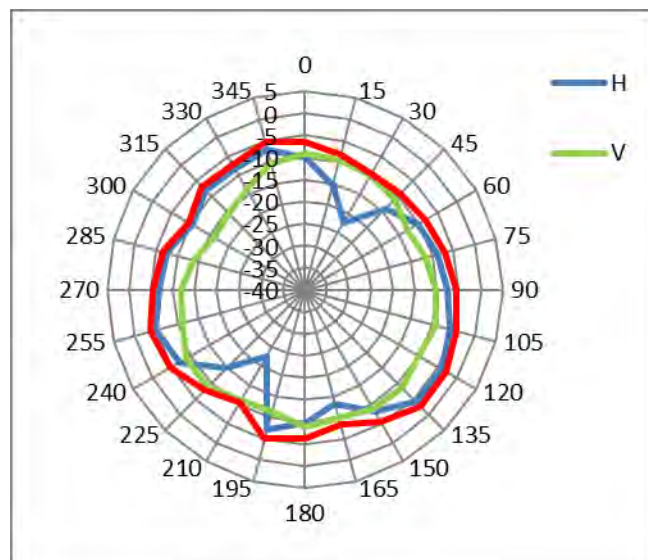

Radiation characteristic in 704MHz ~ 716MHz (FCC Part 27H UE-UTRA, Band 17)

Main antenna: 704.00 MHz

704.00 MHz	
Horizontal Peak (dBi)	-3.27
Vertical Peak(dBi)	-8.13

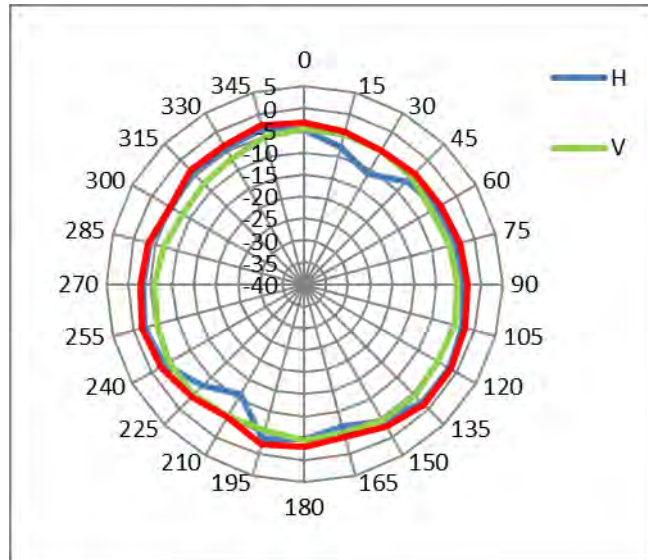

Main antenna: 710.00 MHz

710.00 MHz	
Horizontal Peak (dBi)	-2.97
Vertical Peak(dBi)	-8.46

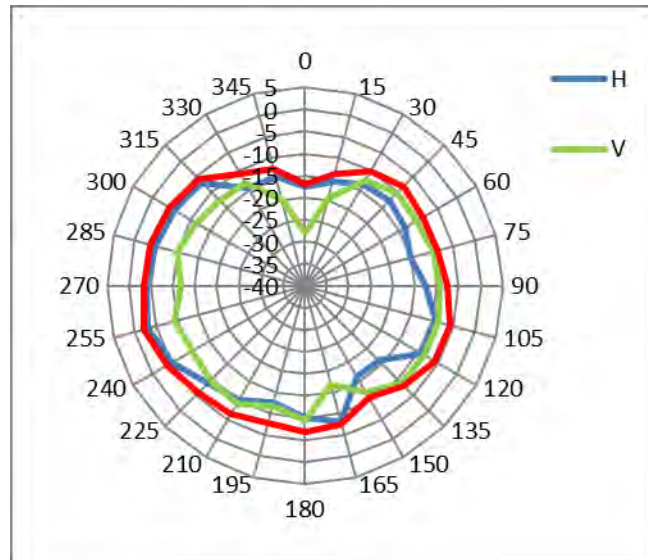

Main antenna: 716.00 MHz

716.00 MHz	
Horizontal Peak (dBi)	-2.78
Vertical Peak(dBi)	-8.66

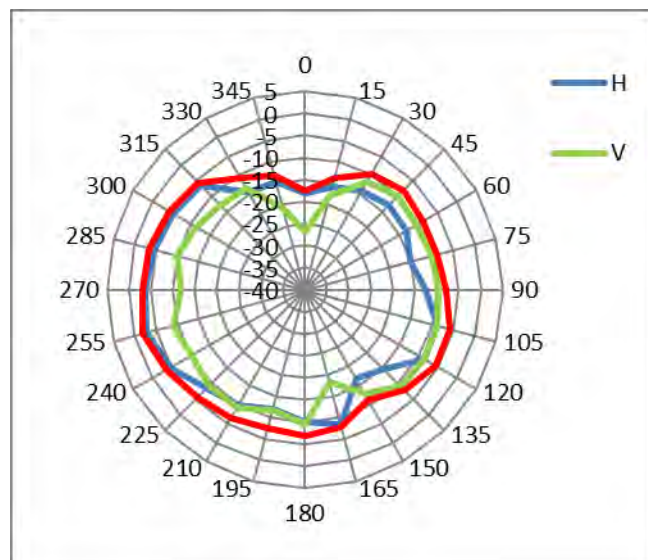

Radiation characteristic in 815MHz ~ 830MHz (Japan, Band 18)

Main antenna: 815.00 MHz

815.00 MHz	
Horizontal Peak (dBi)	-3.75
Vertical Peak(dBi)	-7.7

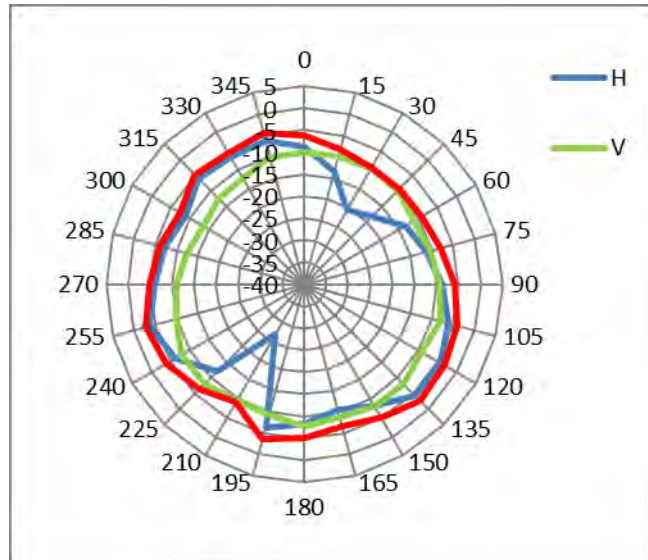

Main antenna: 822.50 MHz

822.50 MHz	
Horizontal Peak (dBi)	-3.31
Vertical Peak(dBi)	-7.25

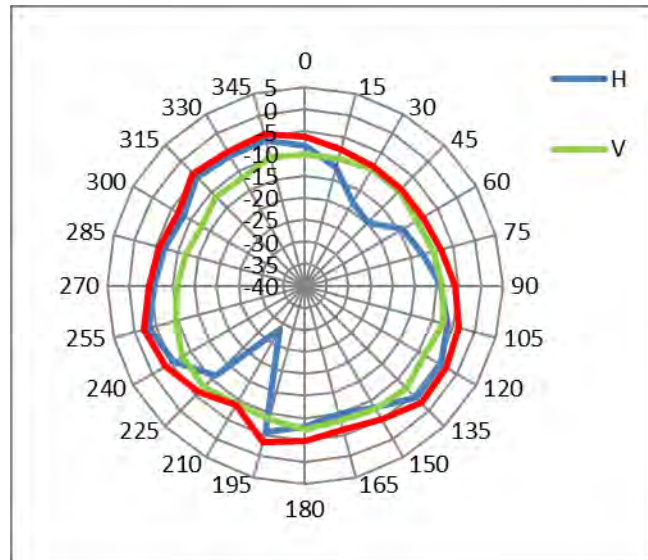

Main antenna: 830.00 MHz

830.00 MHz	
Horizontal Peak (dBi)	-3.18
Vertical Peak(dBi)	-6.67

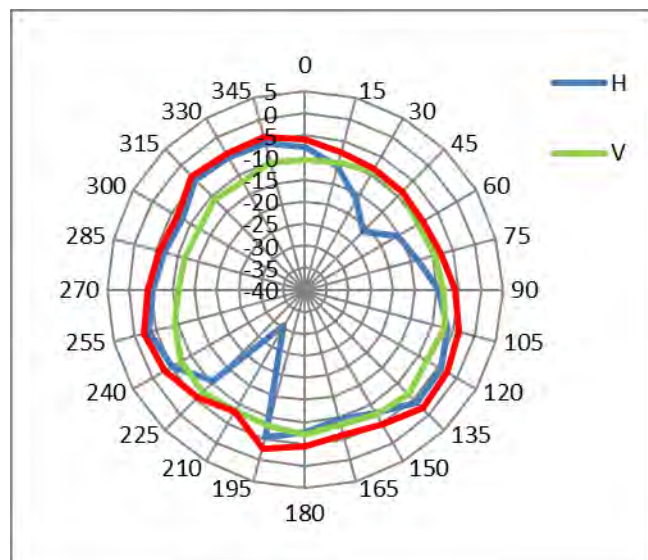

Radiation characteristic in 830MHz ~ 845MHz (Japan, Band 19)

Main antenna: 830.00 MHz

830.00 MHz	
Horizontal Peak (dBi)	-3.18
Vertical Peak(dBi)	-6.67

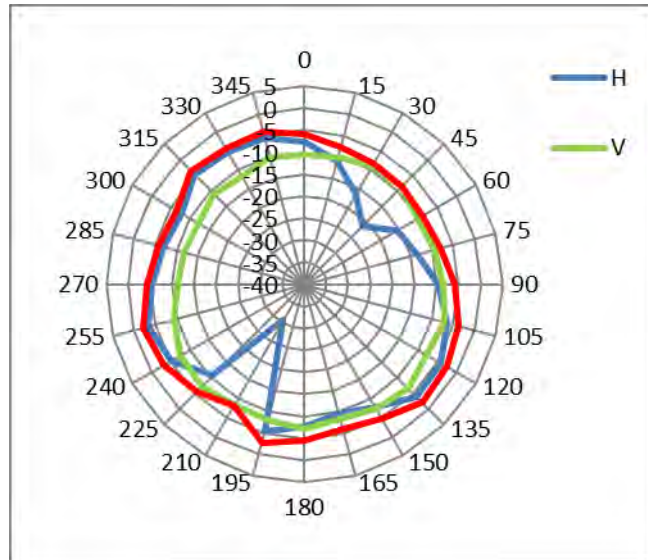

Main antenna: 837.50 MHz

837.50 MHz	
Horizontal Peak (dBi)	-3.24
Vertical Peak(dBi)	-6.08

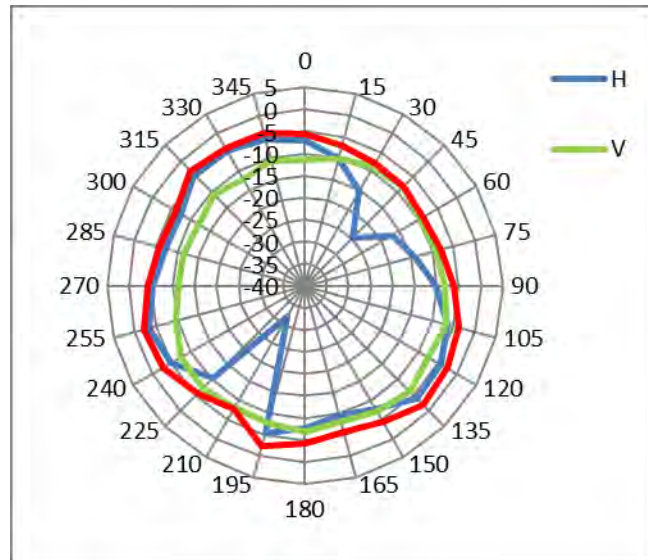

Main antenna: 845.00 MHz

845.00 MHz	
Horizontal Peak (dBi)	-3.38
Vertical Peak(dBi)	-5.49

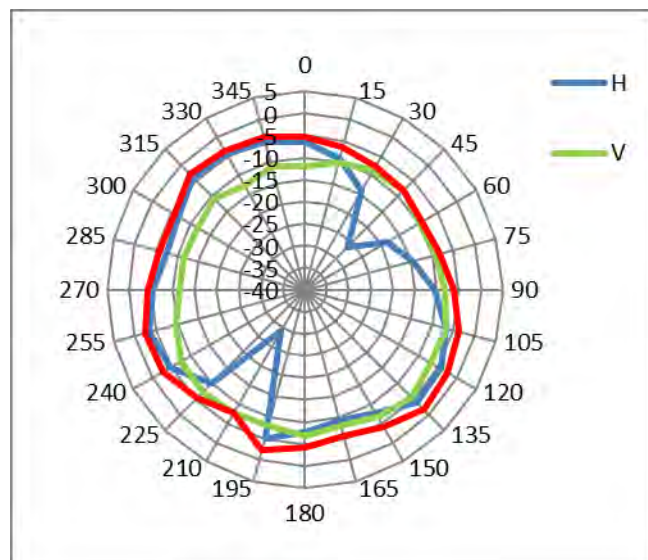

Radiation characteristic in 832MHz ~ 862MHz (EU UE-UTRA, Band 20, n20)

Main antenna: 832.00 MHz

832.00 MHz	
Horizontal Peak (dBi)	-3.17
Vertical Peak(dBi)	-6.62

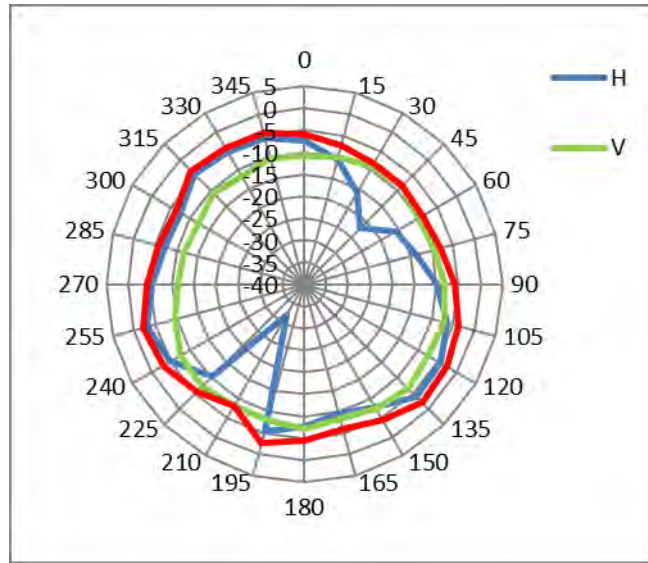

Main antenna: 847.00 MHz

847.00 MHz	
Horizontal Peak (dBi)	-3.48
Vertical Peak(dBi)	-5.38

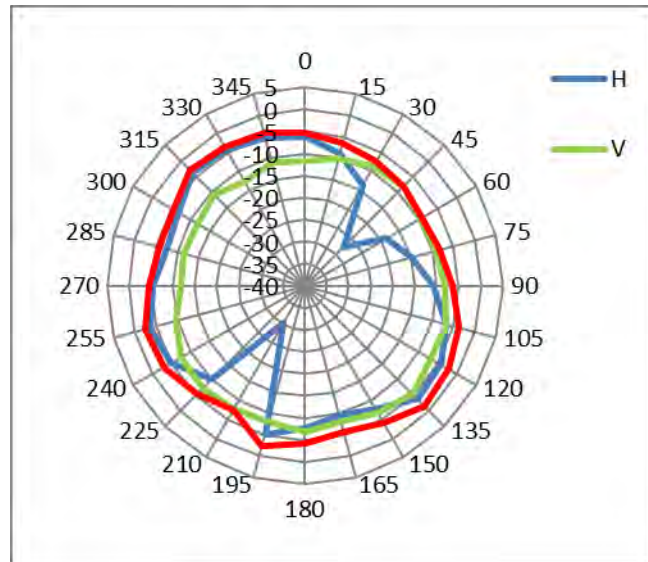

Main antenna: 862.00 MHz

862.00 MHz	
Horizontal Peak (dBi)	-3.59
Vertical Peak(dBi)	-4.85

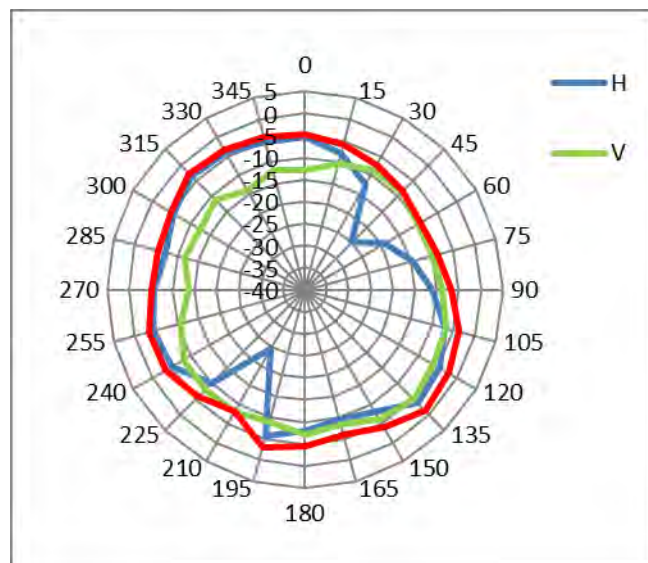

Radiation characteristic in 1850MHz ~ 1915MHz (FCC Part 24 UE-UTRA, Band 25)

Main antenna: 1850.00 MHz

1850.00 MHz	
Horizontal Peak (dBi)	0.08
Vertical Peak(dBi)	-6.82

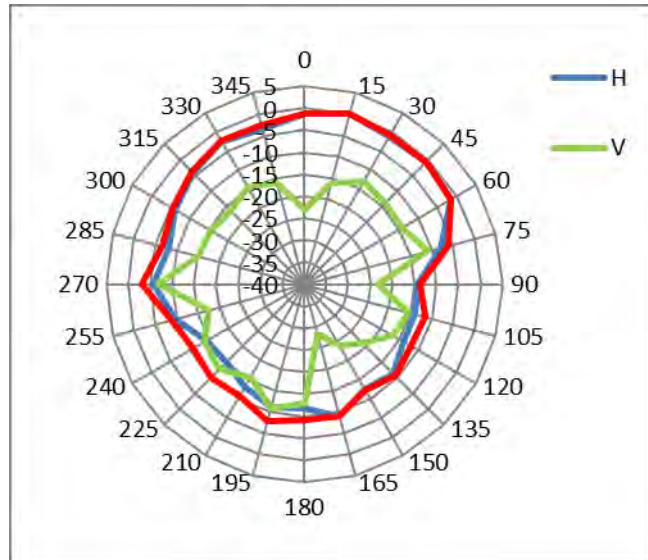

Main antenna: 1882.50 MHz

1882.50 MHz	
Horizontal Peak (dBi)	0.39
Vertical Peak(dBi)	-6.58

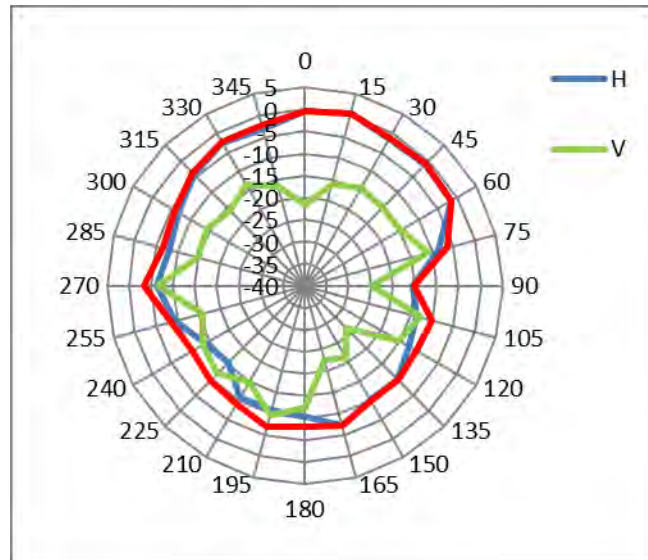

Main antenna: 1915.00 MHz

1915.00 MHz	
Horizontal Peak (dBi)	0.59
Vertical Peak(dBi)	-5.4

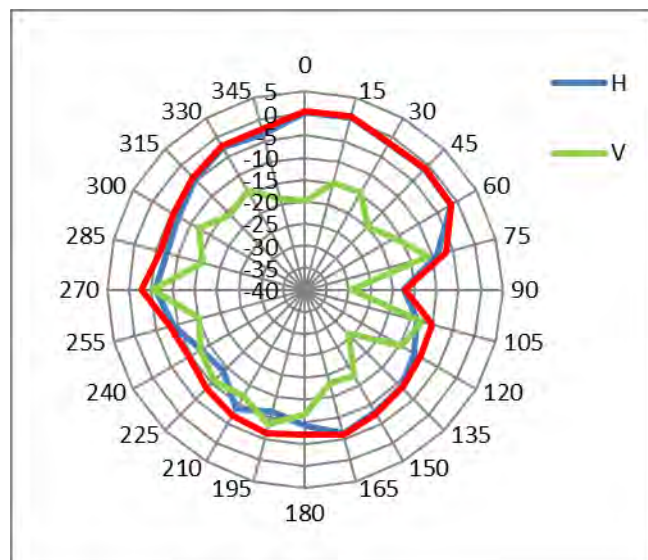

Radiation characteristic in 814MHz ~ 849MHz (FCC Part 90, 22H UE-UTRA, Band 26)

Main antenna: 814.00 MHz

814.00 MHz	
Horizontal Peak (dBi)	-3.79
Vertical Peak(dBi)	-7.77

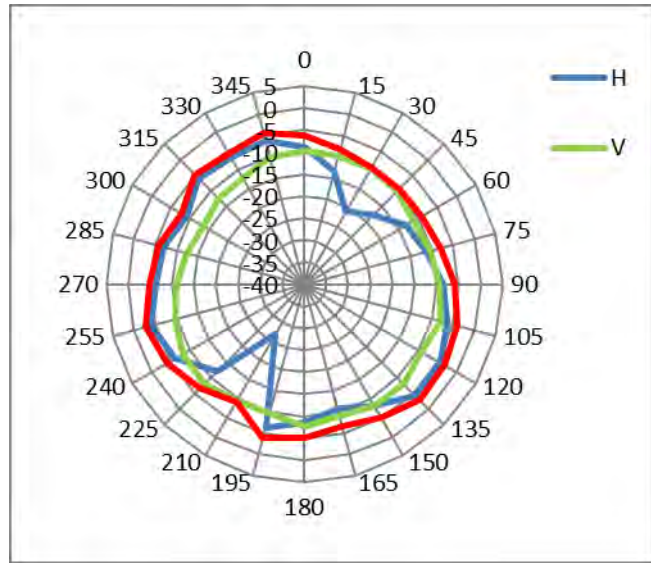

Main antenna: 831.50 MHz

831.50 MHz	
Horizontal Peak (dBi)	-3.18
Vertical Peak(dBi)	-6.58

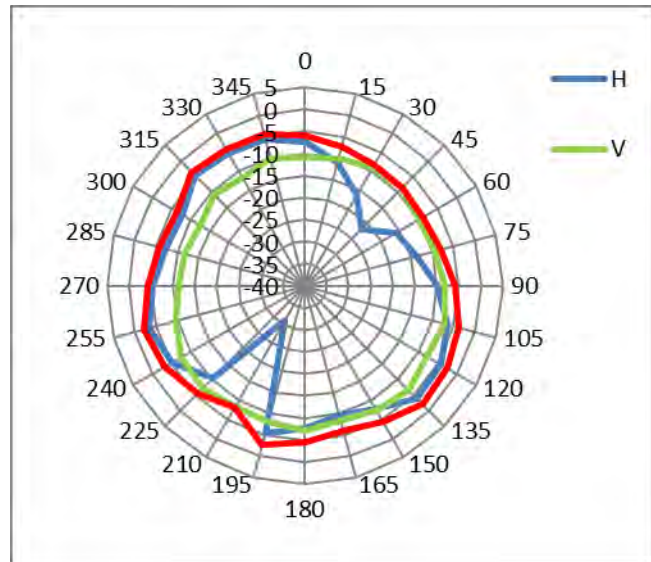

Main antenna: 849.00 MHz

849.00 MHz	
Horizontal Peak (dBi)	-3.59
Vertical Peak(dBi)	-5.27

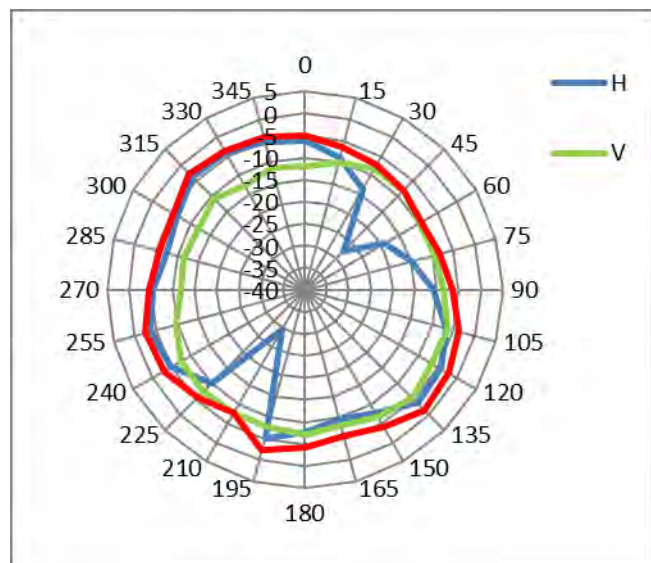

Radiation characteristic in 703MHz ~ 748MHz (EU/ANZ/Japan UE-UTRA, Band 28, 28)

Main antenna: 703.00 MHz

703.00 MHz	
Horizontal Peak (dBi)	-3.4
Vertical Peak(dBi)	-8

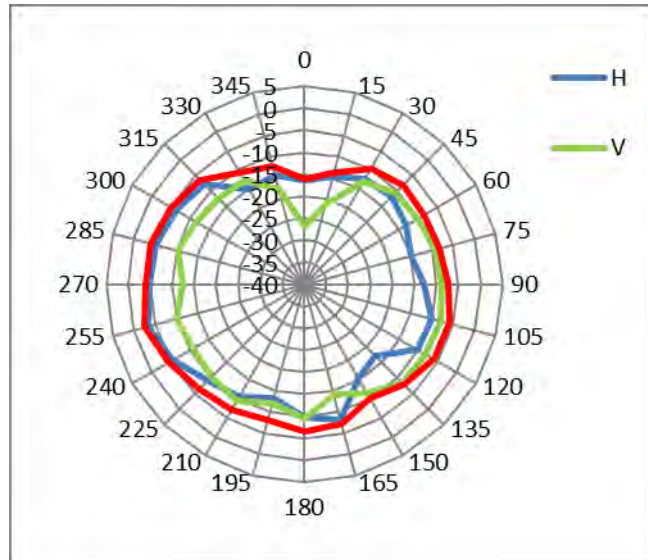

Main antenna: 725.50 MHz

725.50 MHz	
Horizontal Peak (dBi)	-2.58
Vertical Peak(dBi)	-8.27

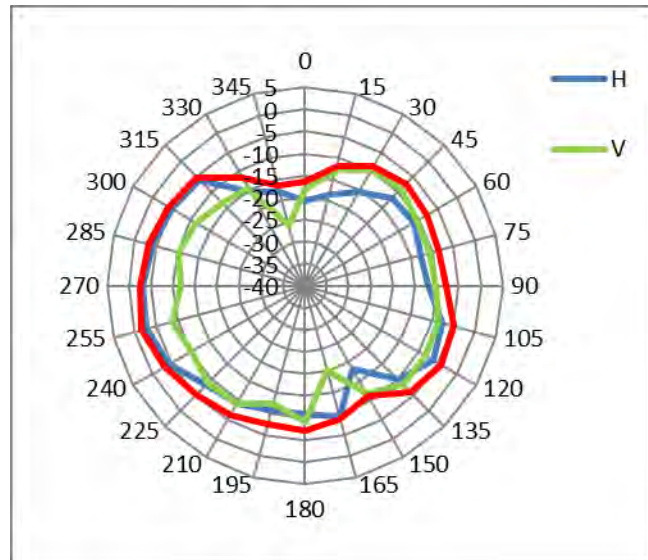

Main antenna: 748.00 MHz

748.00 MHz	
Horizontal Peak (dBi)	-3.32
Vertical Peak(dBi)	-7.12

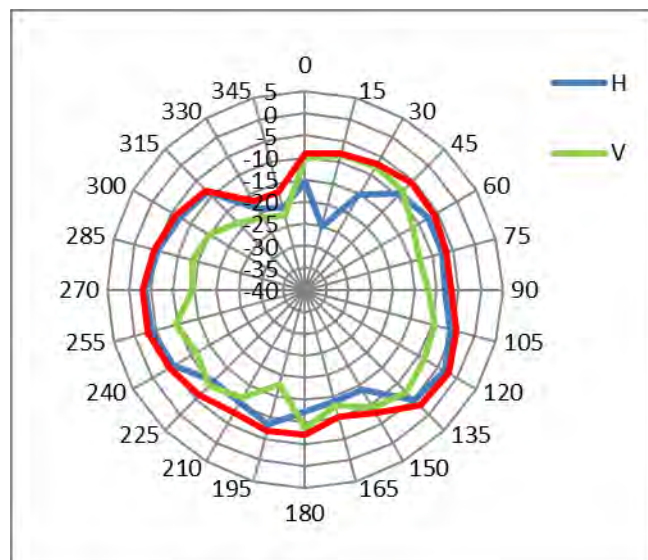

Radiation characteristic in 717MHz ~ 728MHz (FCC Part 27 UE-UTRA, Band 29)

* Down link only

Main antenna: 717.00 MHz

717.00 MHz	
Horizontal Peak (dBi)	-2.77
Vertical Peak(dBi)	-8.74

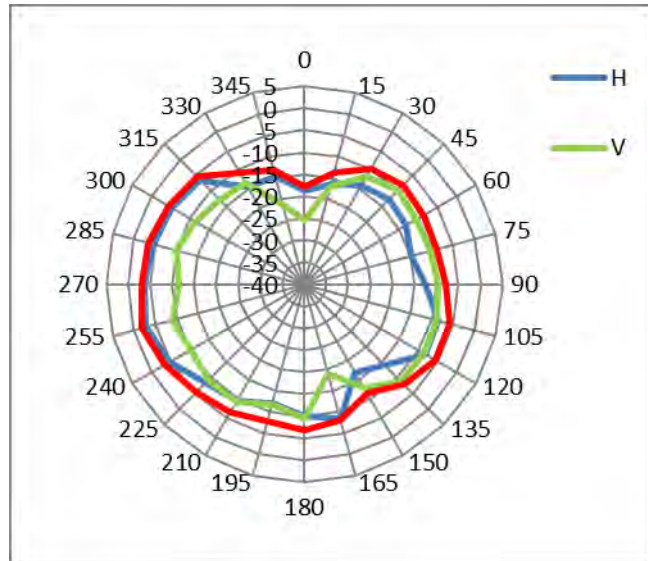

Main antenna: 722.50 MHz

722.50 MHz	
Horizontal Peak (dBi)	-2.62
Vertical Peak(dBi)	-8.51

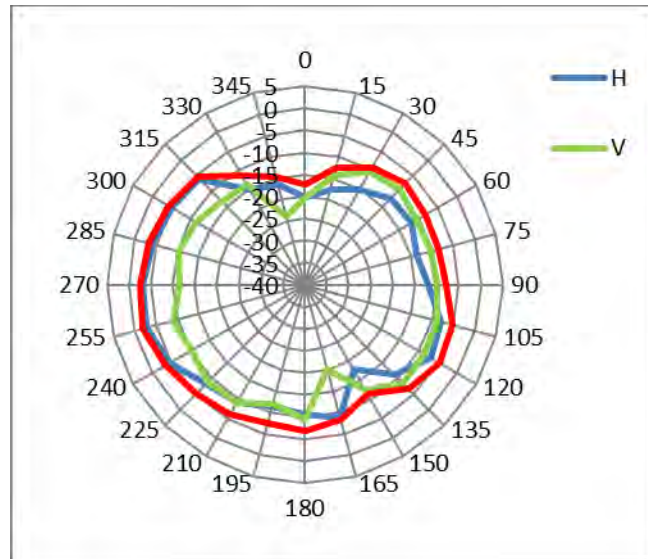

Main antenna: 728.00 MHz

728.00 MHz	
Horizontal Peak (dBi)	-2.62
Vertical Peak(dBi)	-8

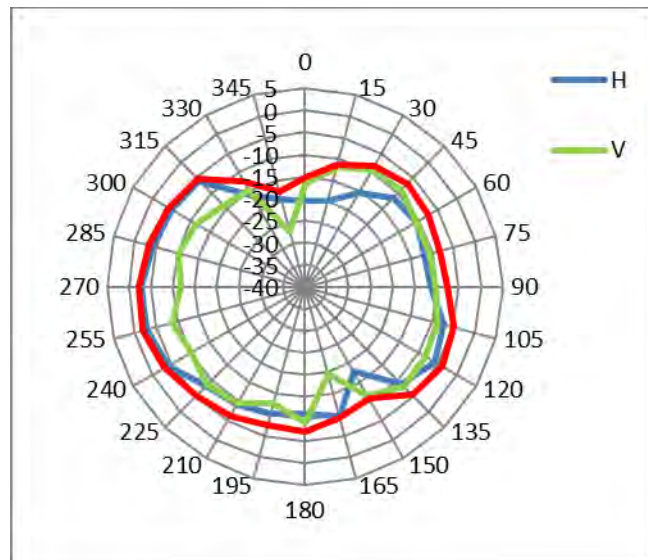

Radiation characteristic in 2305MHz ~ 2315MHz (FCC Part 27 UE-UTRA, Band 30)

Main antenna: 2305.00 MHz

2305.00 MHz	
Horizontal Peak (dBi)	-0.42
Vertical Peak(dBi)	-5.08

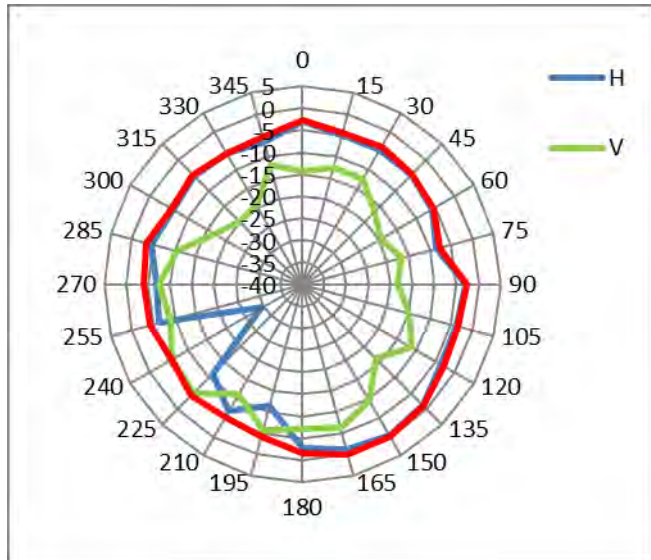

Main antenna: 2310.00 MHz

2310.00 MHz	
Horizontal Peak (dBi)	-0.42
Vertical Peak(dBi)	-5.09

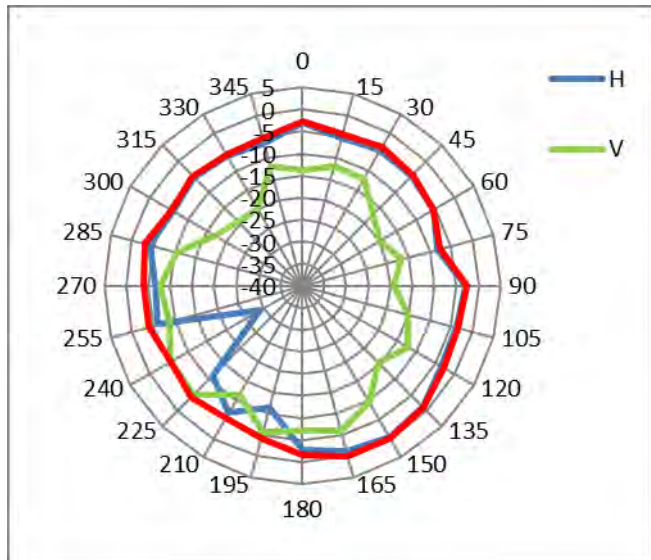

Main antenna: 2315.00 MHz

2315.00 MHz	
Horizontal Peak (dBi)	-0.35
Vertical Peak(dBi)	-5.54

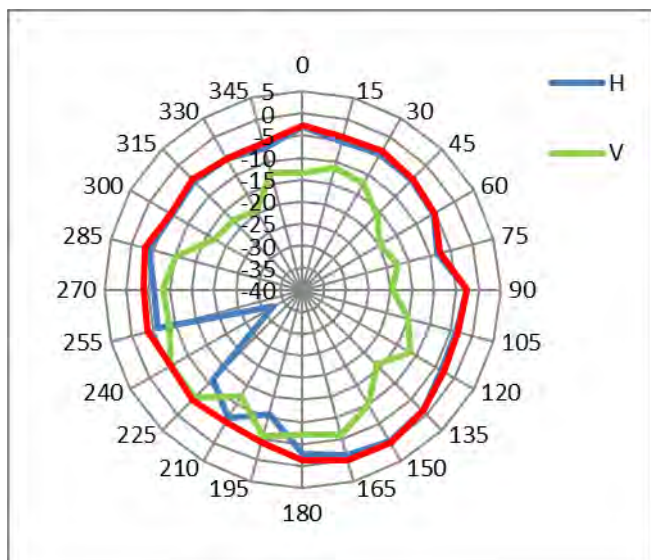

Radiation characteristic in 1452MHz ~ 1496MHz (EU LTE, Band 32)

* Down link only

Main antenna: 1452.00 MHz

1452.00 MHz	
Horizontal Peak (dBi)	-4.2
Vertical Peak(dBi)	-11.46

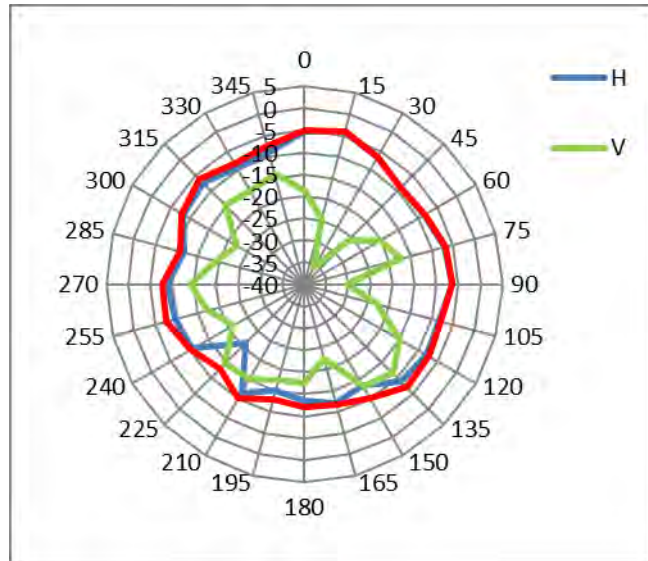

Main antenna: 1474.00 MHz

1474.00 MHz	
Horizontal Peak (dBi)	-3.69
Vertical Peak(dBi)	-11.49

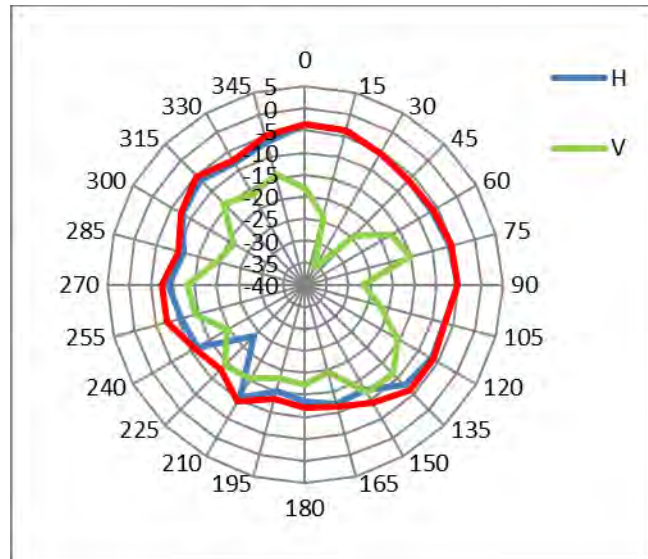

Main antenna: 1496.00 MHz

1496.00 MHz	
Horizontal Peak (dBi)	-2.6
Vertical Peak(dBi)	-11.56

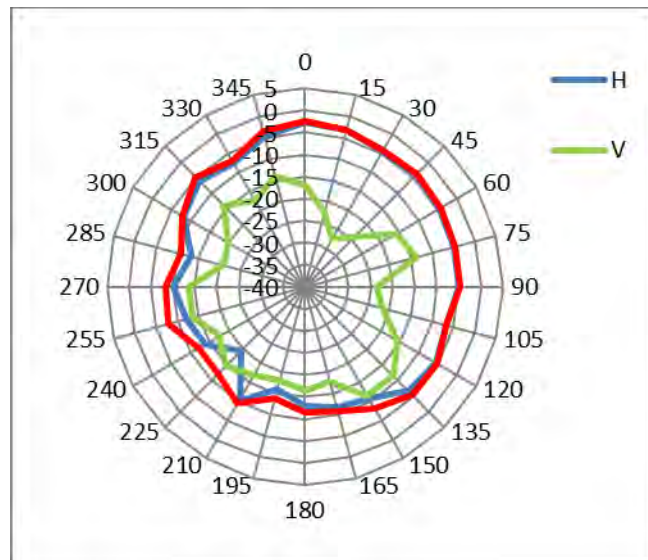

Radiation characteristic in 2010MHz ~ 2025MHz (EU LTE, Band 34)

Main antenna: 2010.00 MHz

2010.00 MHz	
Horizontal Peak (dBi)	0.47
Vertical Peak(dBi)	-2.92

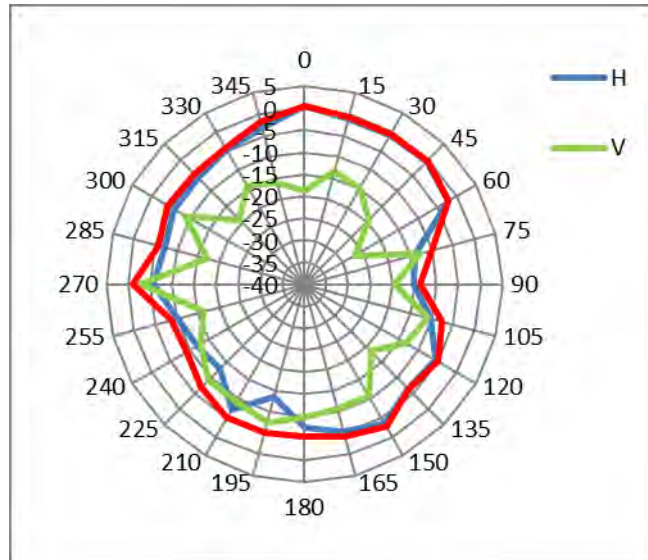

Main antenna: 2017.50 MHz

2017.50 MHz	
Horizontal Peak (dBi)	0.48
Vertical Peak(dBi)	-2.99

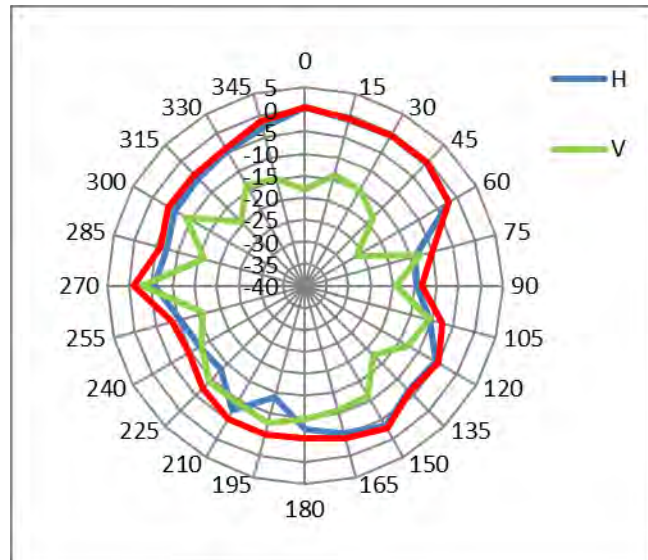

Main antenna: 2025.00 MHz

2025.00 MHz	
Horizontal Peak (dBi)	0.52
Vertical Peak(dBi)	-3.11

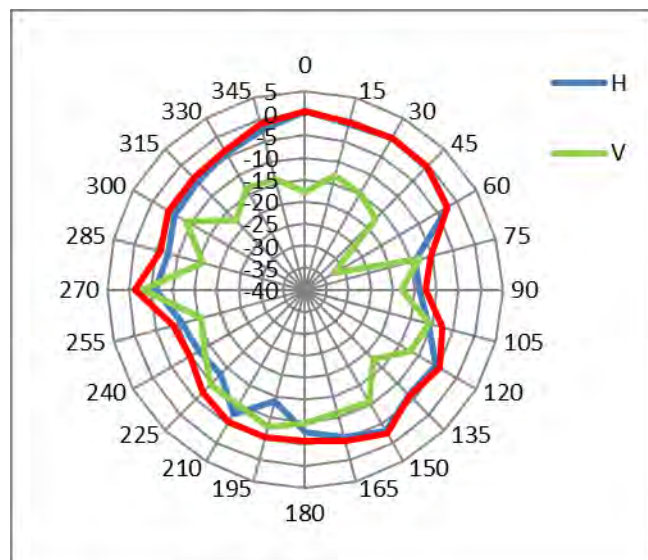

Radiation characteristic in 2570MHz ~ 2620MHz (EU/CN UE-UTRA, Band 38, n38)

Main antenna: 2570.00 MHz

2570.00 MHz	
Horizontal Peak (dBi)	1.89
Vertical Peak(dBi)	-2.74

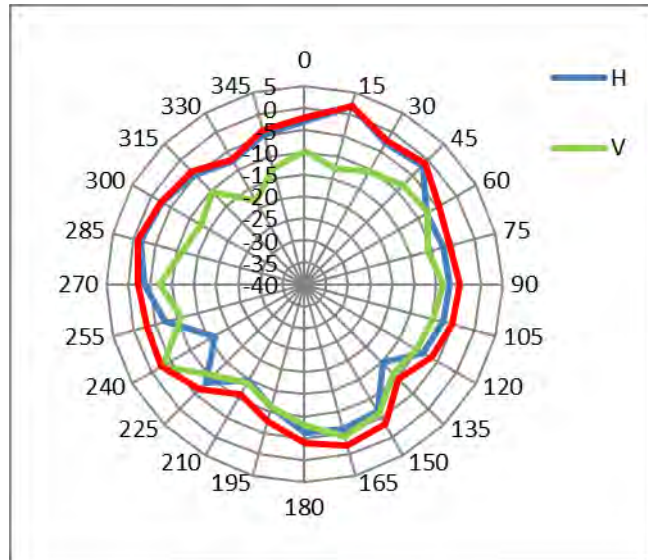

Main antenna: 2595.00 MHz

2595.00 MHz	
Horizontal Peak (dBi)	1.85
Vertical Peak(dBi)	-2.05

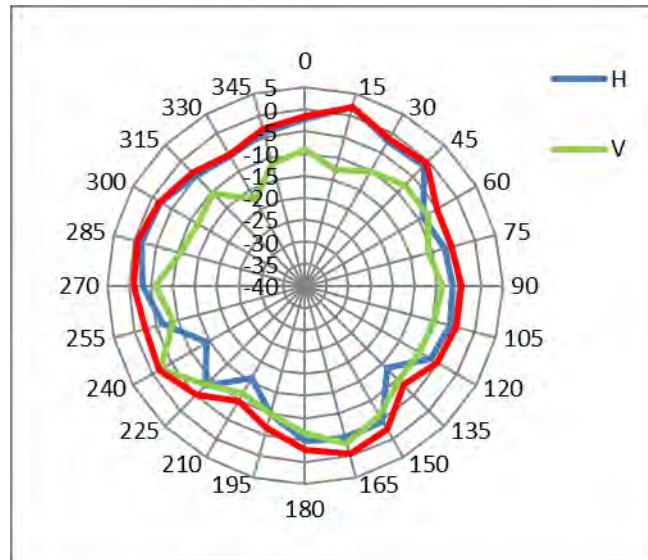

Main antenna: 2620.00 MHz

2620.00 MHz	
Horizontal Peak (dBi)	1.88
Vertical Peak(dBi)	-1.46

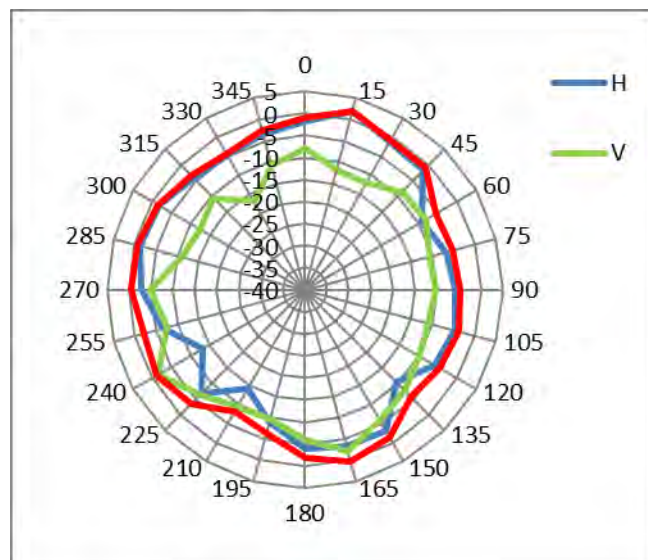

Radiation characteristic in 1880MHz ~ 1920MHz (CN TD-SCDMA, Band 39)

Main antenna: 1880.00 MHz

1880.00 MHz	
Horizontal Peak (dBi)	0.33
Vertical Peak(dBi)	-6.67

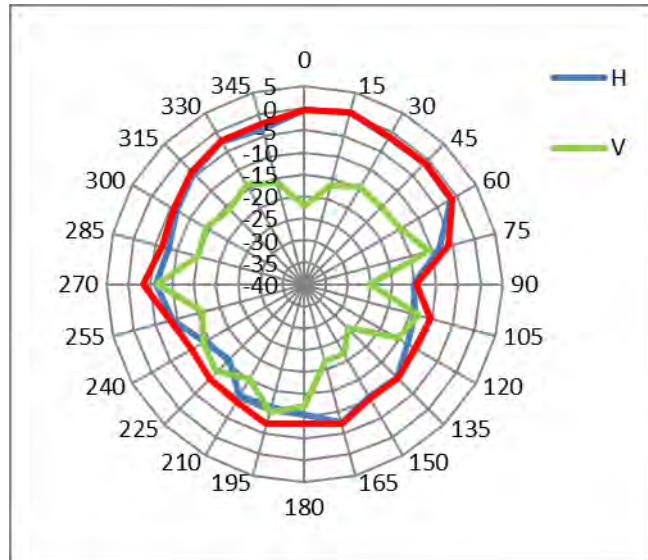

Main antenna: 1900.00 MHz

1900.00 MHz	
Horizontal Peak (dBi)	0.4
Vertical Peak(dBi)	-6.19

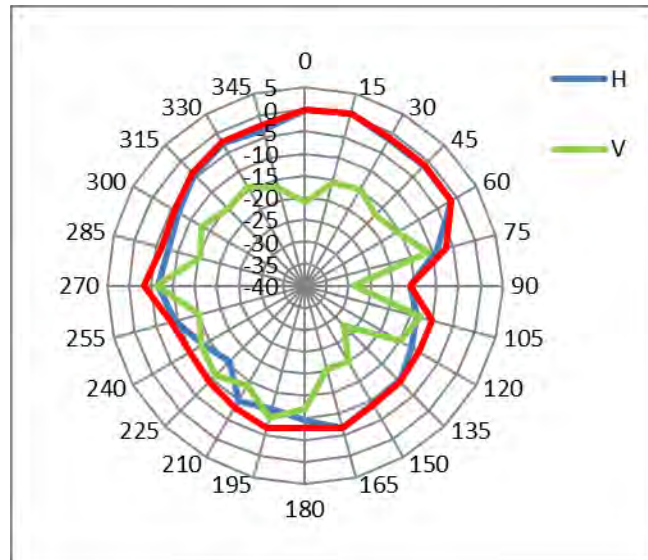

Main antenna: 1920.00 MHz

1920.00 MHz	
Horizontal Peak (dBi)	0.66
Vertical Peak(dBi)	-5.16

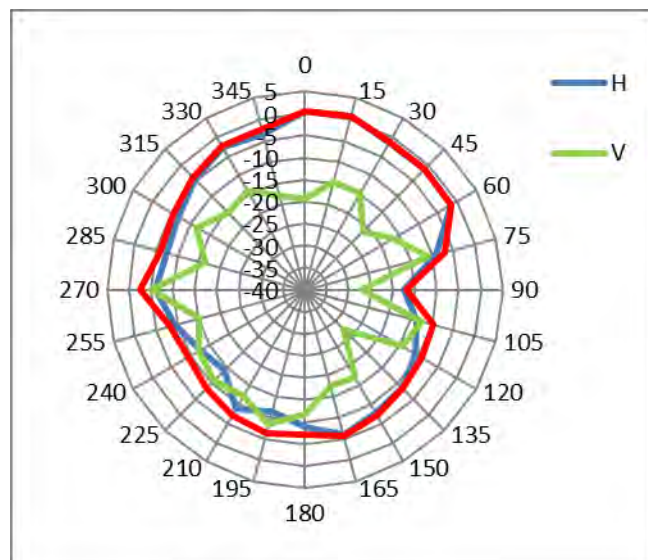

Radiation characteristic in 2300MHz ~ 2400MHz (EU/ANZ/CN UE-UTRA, Band 40)

Main antenna: 2300.00 MHz

2300.00 MHz	
Horizontal Peak (dBi)	-0.34
Vertical Peak(dBi)	-4.9

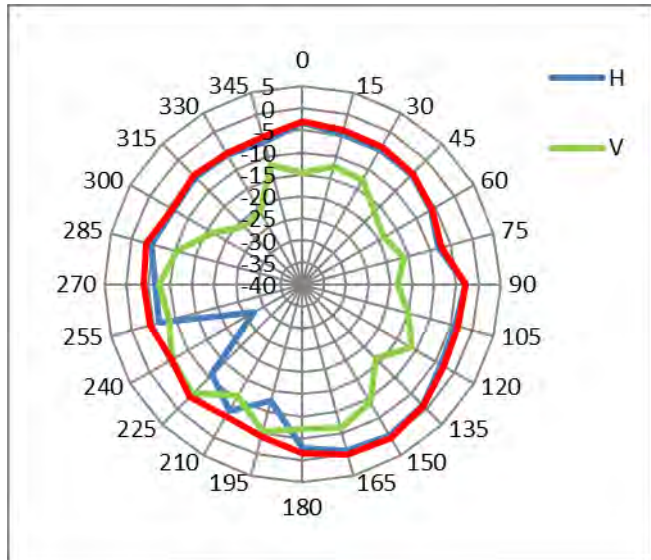

Main antenna: 2350.00 MHz

2350.00 MHz	
Horizontal Peak (dBi)	0.04
Vertical Peak(dBi)	-4.73

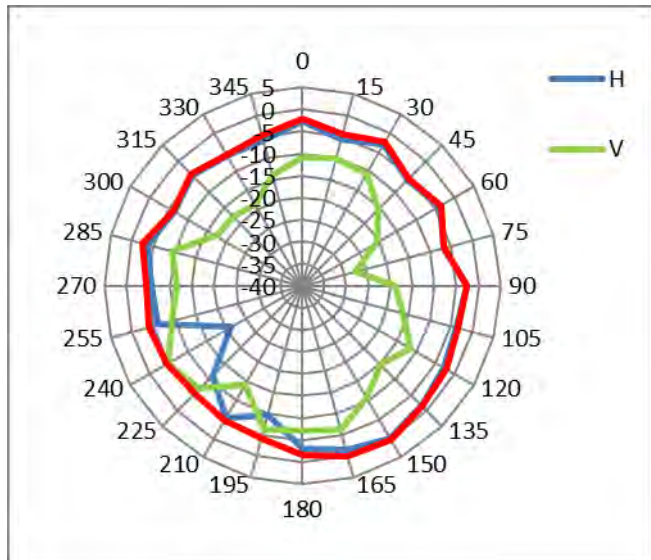

Main antenna: 2400.00 MHz

2400.00 MHz	
Horizontal Peak (dBi)	-0.05
Vertical Peak(dBi)	-4.88

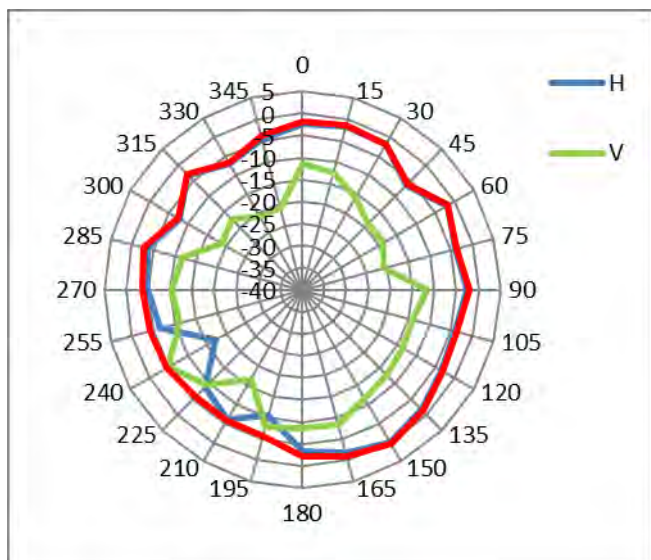

Radiation characteristic in 2496MHz ~ 2690MHz (FCC Part 27 UE-UTRA, Band 41, n41)

Main antenna: 2496.00 MHz

2496.00 MHz	
Horizontal Peak (dBi)	0.93
Vertical Peak(dBi)	-4.48

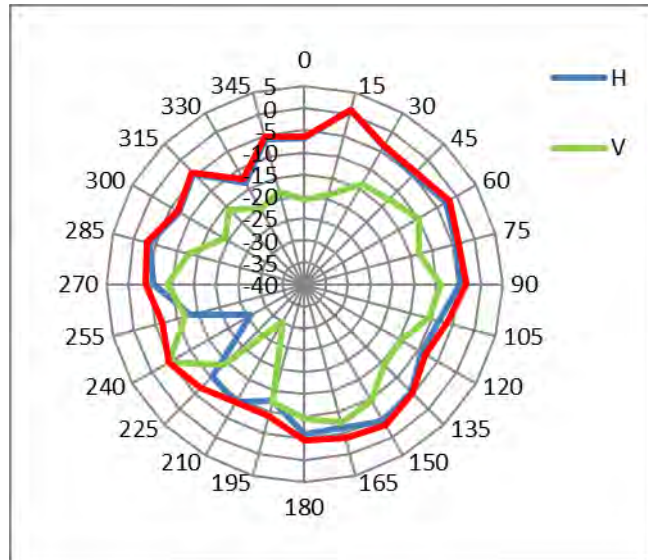

Main antenna: 2593.00 MHz

2593.00 MHz	
Horizontal Peak (dBi)	1.77
Vertical Peak(dBi)	-2.24

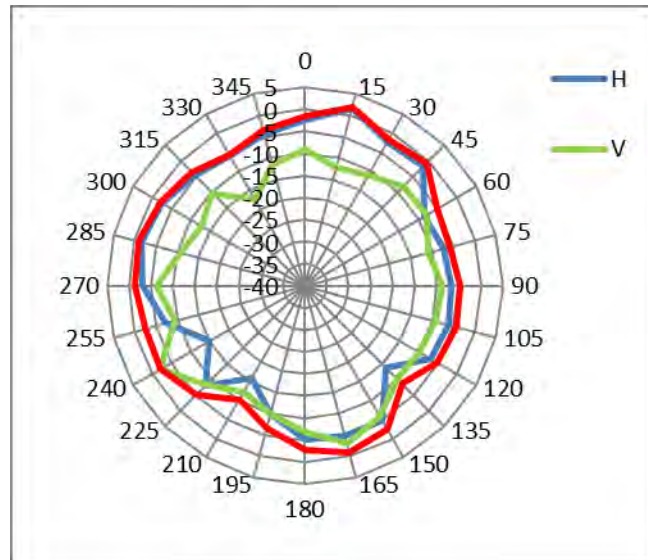

Main antenna: 2690.00 MHz

2690.00 MHz	
Horizontal Peak (dBi)	1.84
Vertical Peak(dBi)	-0.8

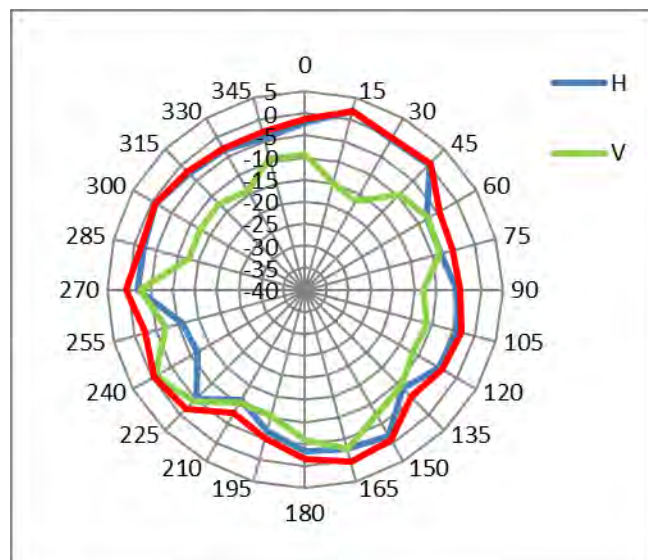

Radiation characteristic in 3400MHz ~ 3600MHz (FCC Part 96 LTE Band 42)

Main antenna: 3400.00 MHz

3400.00 MHz	
Horizontal Peak (dBi)	2.33
Vertical Peak(dBi)	-4.48

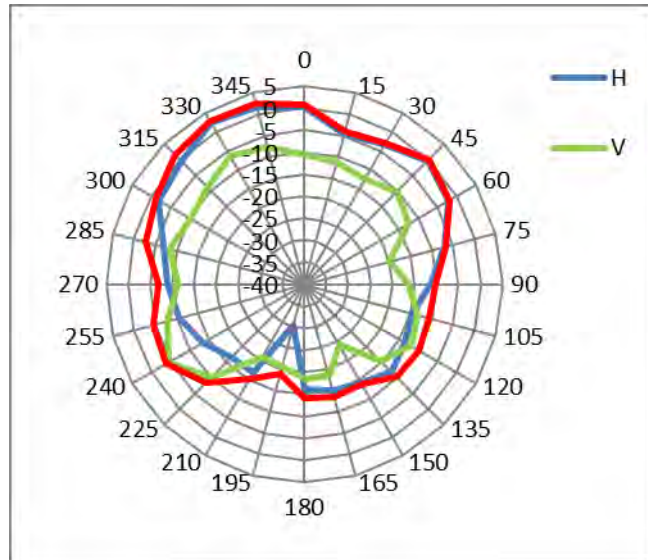

Main antenna: 3500.00 MHz

3500.00 MHz	
Horizontal Peak (dBi)	2.24
Vertical Peak(dBi)	-2.73

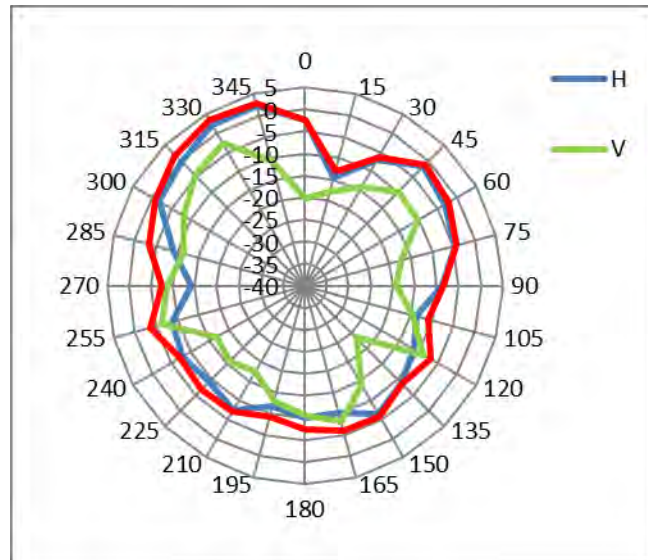

Main antenna: 3600.00 MHz

3600.00 MHz	
Horizontal Peak (dBi)	3.39
Vertical Peak(dBi)	-2.57

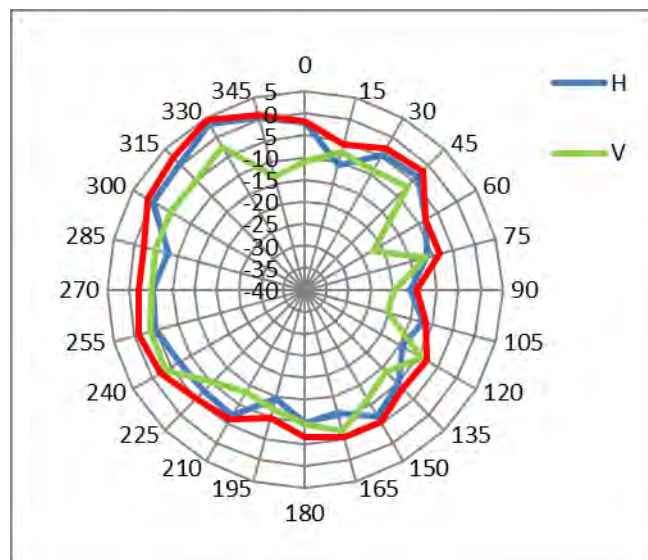

Radiation characteristic in 3600MHz ~ 3800MHz (EU LTE, Band 43)

Main antenna: 3600.00 MHz

3600.00 MHz	
Horizontal Peak (dBi)	3.39
Vertical Peak(dBi)	-2.57

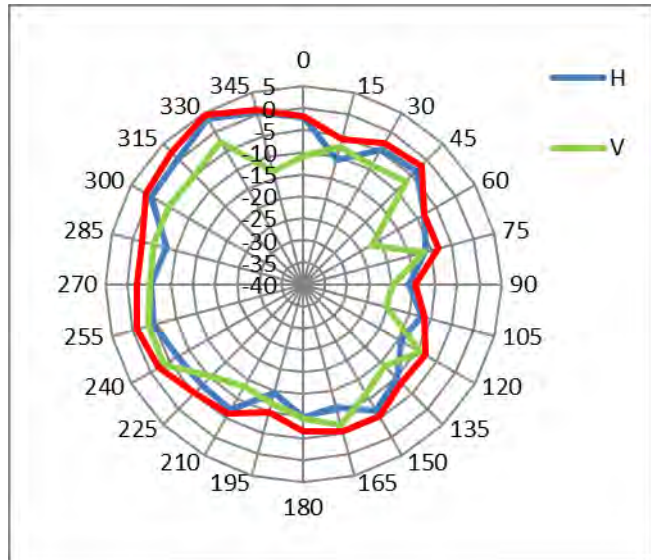

Main antenna: 3700.00 MHz

3700.00 MHz	
Horizontal Peak (dBi)	3.2
Vertical Peak(dBi)	-3.69

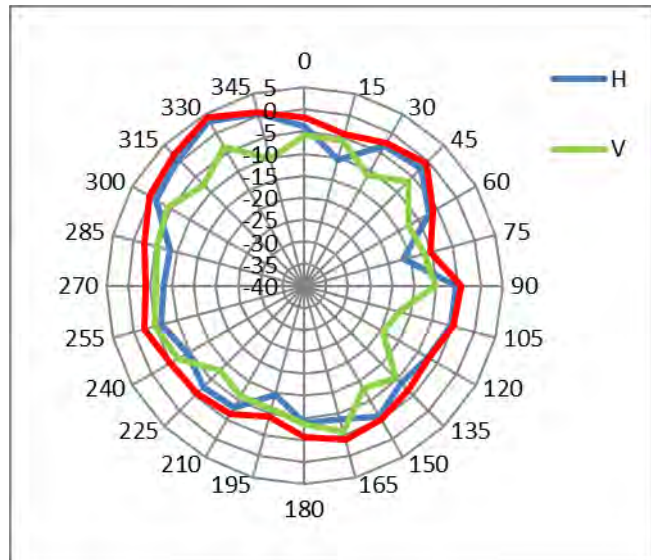

Main antenna: 3800.00 MHz

3800.00 MHz	
Horizontal Peak (dBi)	1.94
Vertical Peak(dBi)	-3.8

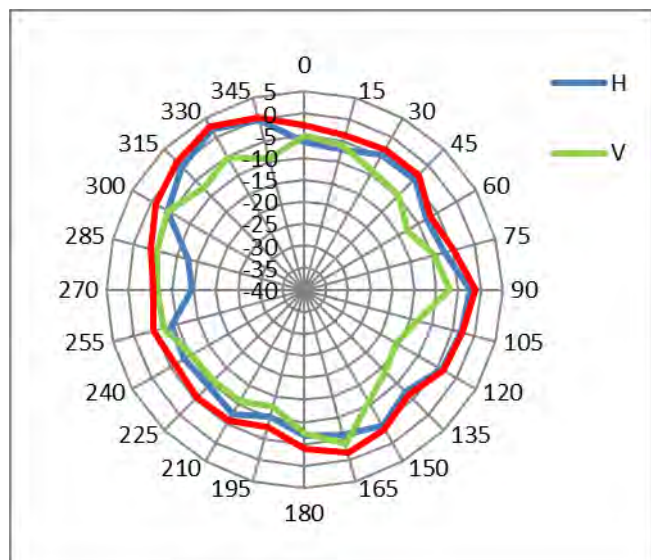

Radiation characteristic in 5150MHz ~ 5925MHz (FCC Part 15, 90, 95 LTE Band 46)

* TD Unlicensed, LAA RCV only

Main antenna: 5150.00 MHz

5150.00 MHz	
Horizontal Peak (dBi)	-1.74
Vertical Peak(dBi)	-3.83

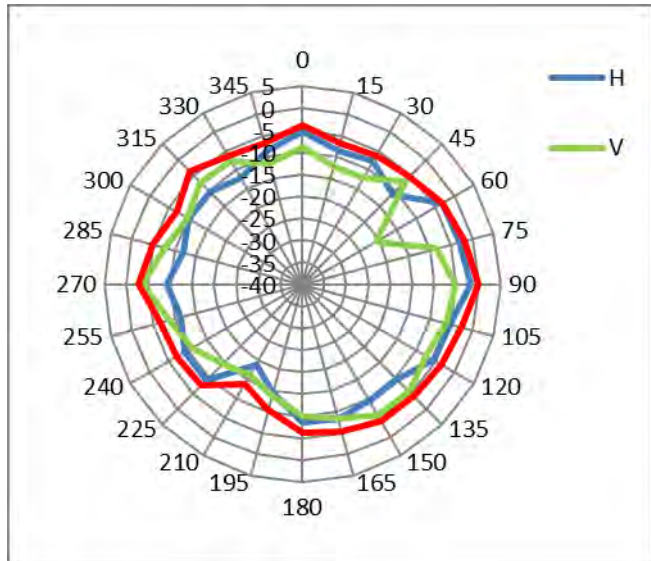

Main antenna: 5537.00 MHz

5537.00 MHz	
Horizontal Peak (dBi)	-2.78
Vertical Peak(dBi)	0.03

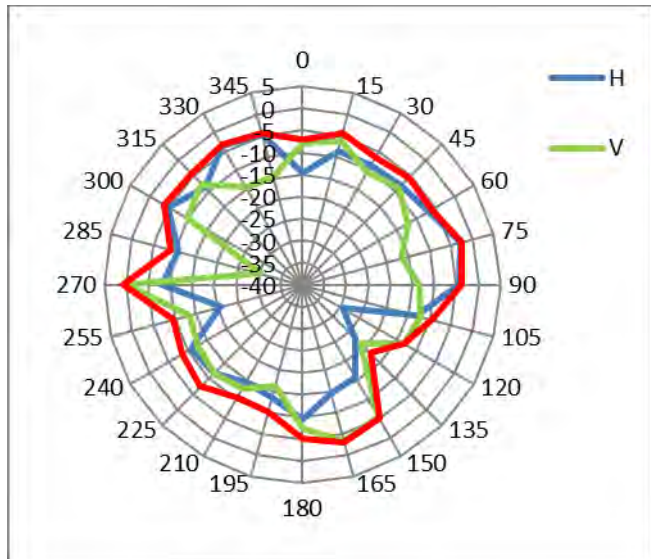

Main antenna: 5925.00 MHz

5925.00 MHz	
Horizontal Peak (dBi)	-4.26
Vertical Peak(dBi)	-4.49

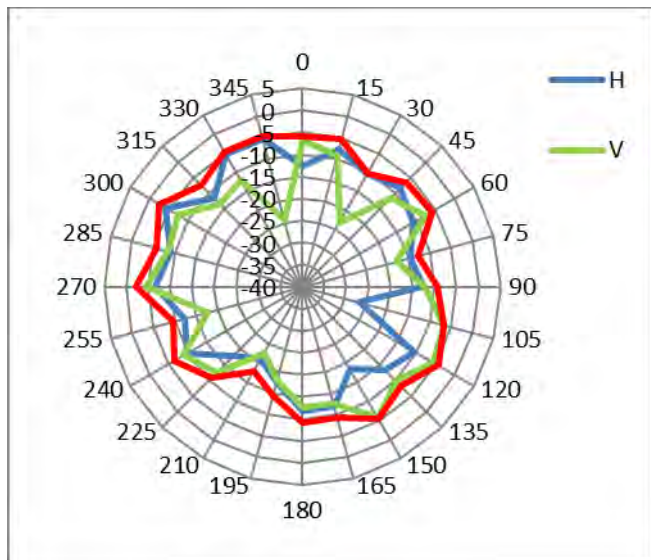

Radiation characteristic in 3550MHz ~ 3700MHz (FCC Part 96, LTE Band 48)

Main antenna: 3550.00 MHz

3550.00 MHz	
Horizontal Peak (dBi)	1.99
Vertical Peak(dBi)	-1.53

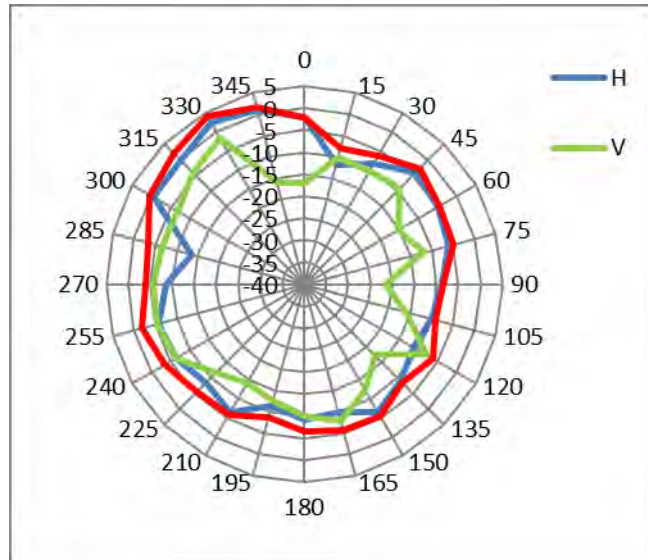

Main antenna: 3625.00 MHz

3625.00 MHz	
Horizontal Peak (dBi)	2.67
Vertical Peak(dBi)	-2.91

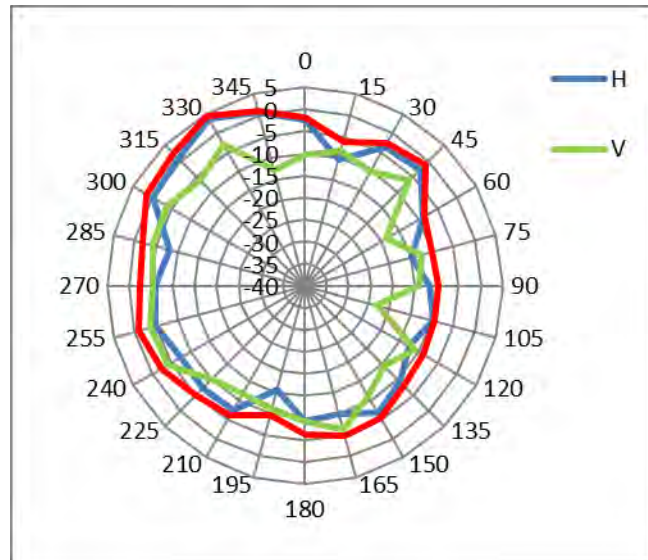

Main antenna: 3700.00 MHz

3700.00 MHz	
Horizontal Peak (dBi)	2.2
Vertical Peak(dBi)	-3.69

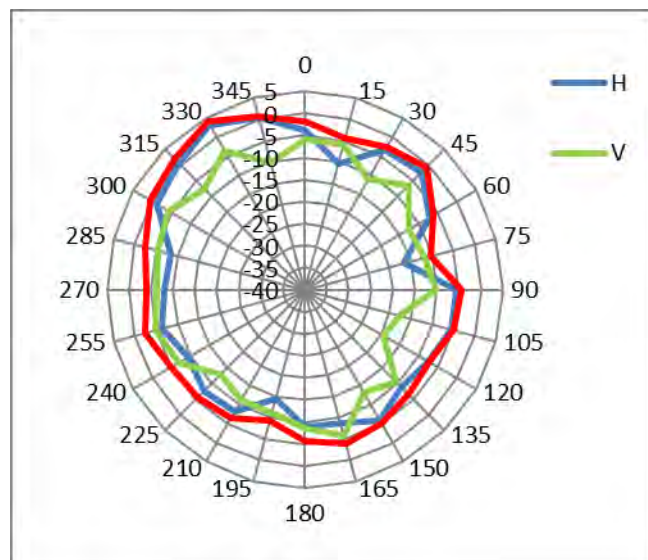

Radiation characteristic in 1710MHz ~ 1780MHz (FCC Part 27 LTE, Band 66, n66)

Main antenna: 1710.00 MHz

1710.00 MHz	
Horizontal Peak (dBi)	1.22
Vertical Peak(dBi)	-11.28

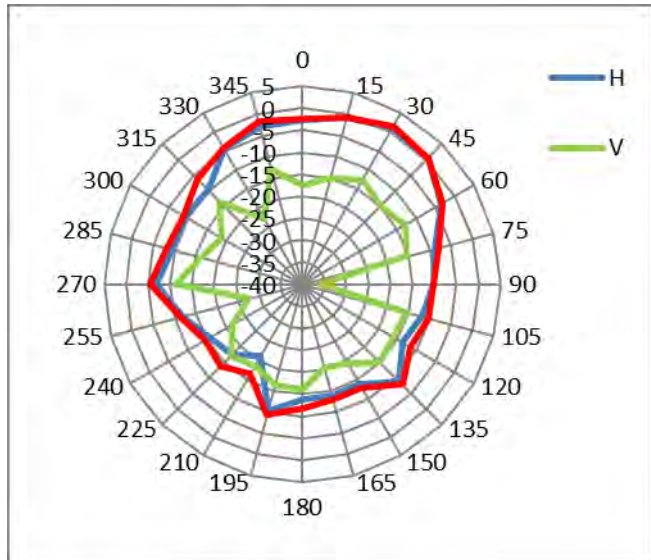

Main antenna: 1745.00 MHz

1745.00 MHz	
Horizontal Peak (dBi)	0.72
Vertical Peak(dBi)	-9.97

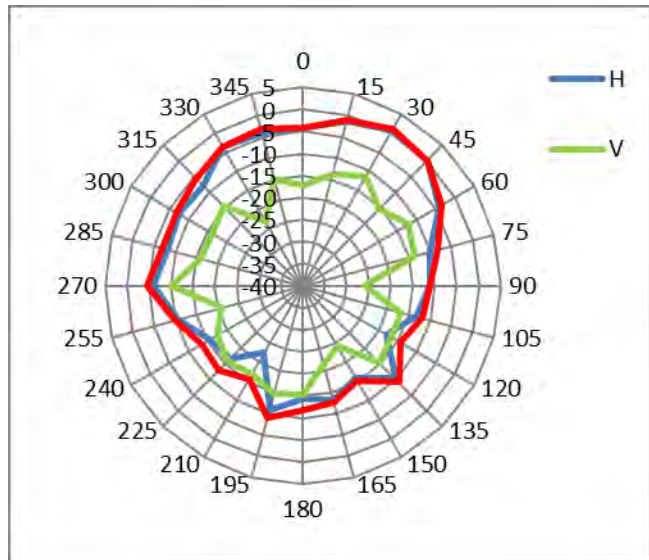

Main antenna: 1780.00 MHz

1780.00 MHz	
Horizontal Peak (dBi)	0.13
Vertical Peak(dBi)	-8.4

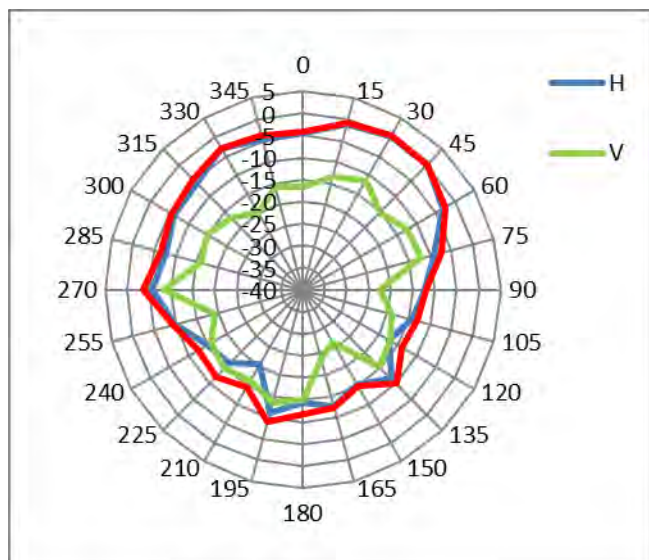

Radiation characteristic in 663MHz ~ 698MHz (FCC Part 24, 27 LTE, Band 71, n71)

Main antenna: 663.00 MHz

663.00 MHz	
Horizontal Peak (dBi)	-2.21
Vertical Peak(dBi)	-5.18

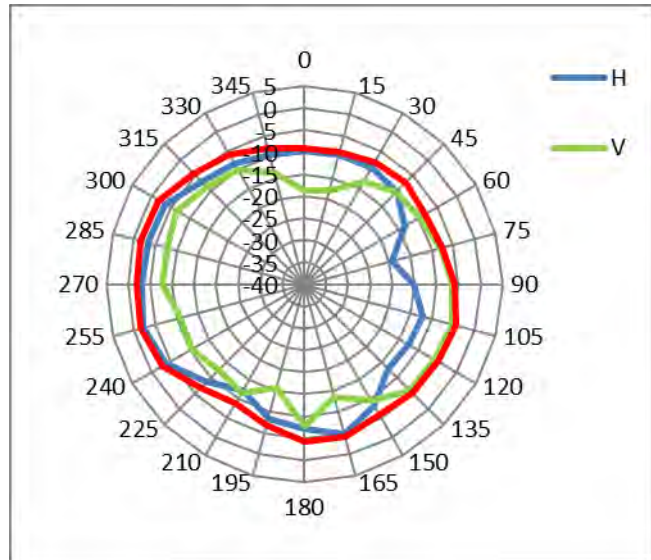

Main antenna: 680.50 MHz

680.50 MHz	
Horizontal Peak (dBi)	-3.28
Vertical Peak(dBi)	-6.26

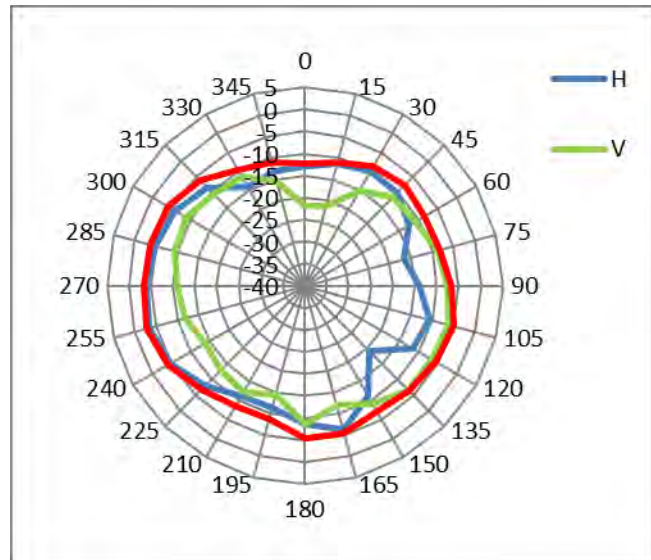

Main antenna: 698.00 MHz

698.00 MHz	
Horizontal Peak (dBi)	-3.55
Vertical Peak(dBi)	-7.55

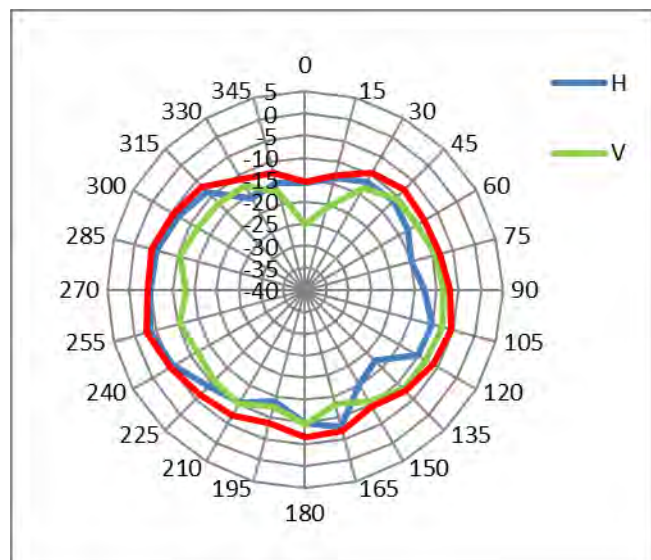

Radiation characteristic in 3300MHz ~ 4200MHz (FCC/EU/CN/JP 5G NR Band 77)

Main antenna: 3300.00 MHz

3300.00 MHz	
Horizontal Peak (dBi)	-1.3
Vertical Peak(dBi)	-3.32

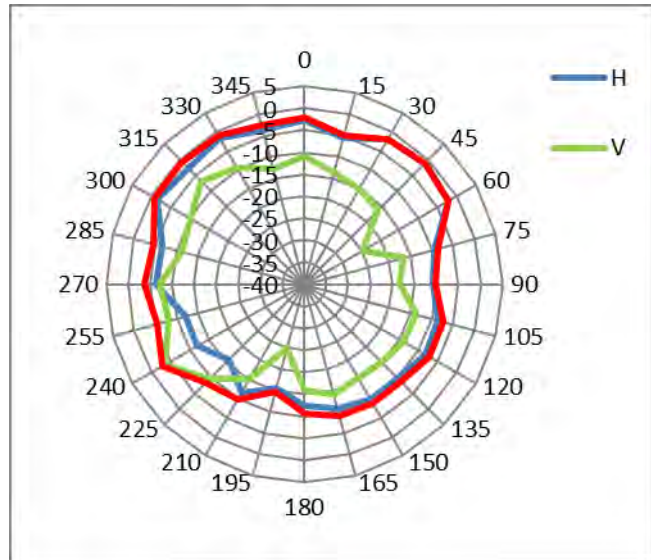

Main antenna: 3750.00 MHz

3750.00 MHz	
Horizontal Peak (dBi)	2.52
Vertical Peak(dBi)	-4.15

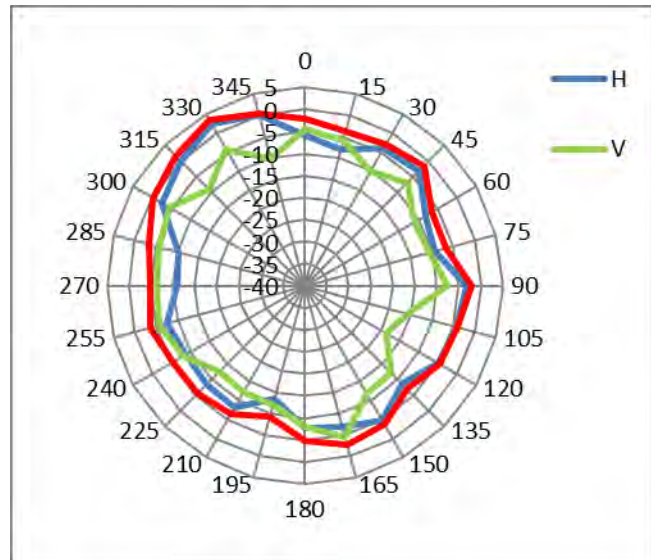

Main antenna: 4200.00 MHz

4200.00 MHz	
Horizontal Peak (dBi)	-1.06
Vertical Peak(dBi)	-3.4

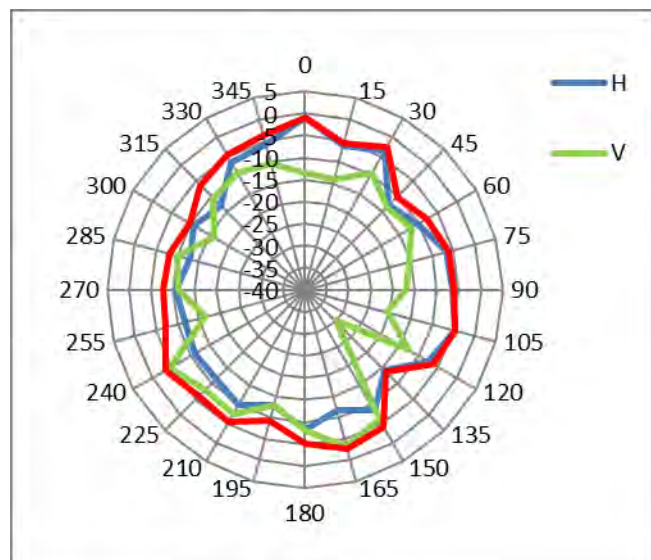

Radiation characteristic in 3300MHz ~ 3800MHz (EU/CN/JP 5G NR Band 78)

Main antenna: 3300.00 MHz

3300.00 MHz	
Horizontal Peak (dBi)	-1.3
Vertical Peak(dBi)	-3.32

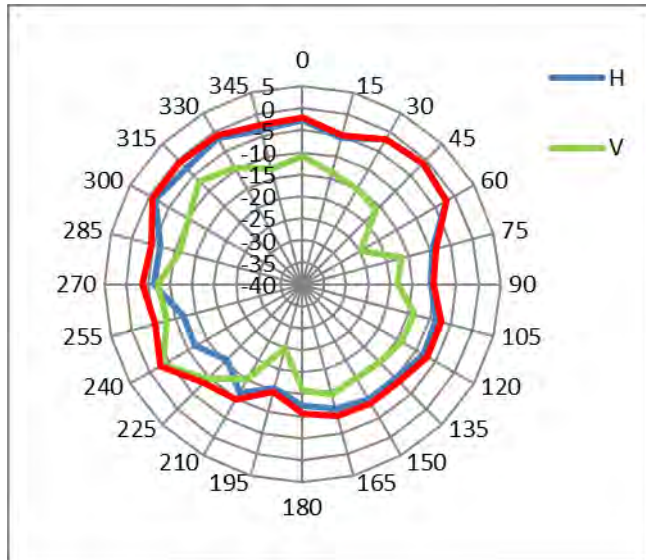

Main antenna: 3550.00 MHz

3550.00 MHz	
Horizontal Peak (dBi)	2.49
Vertical Peak(dBi)	-1.53

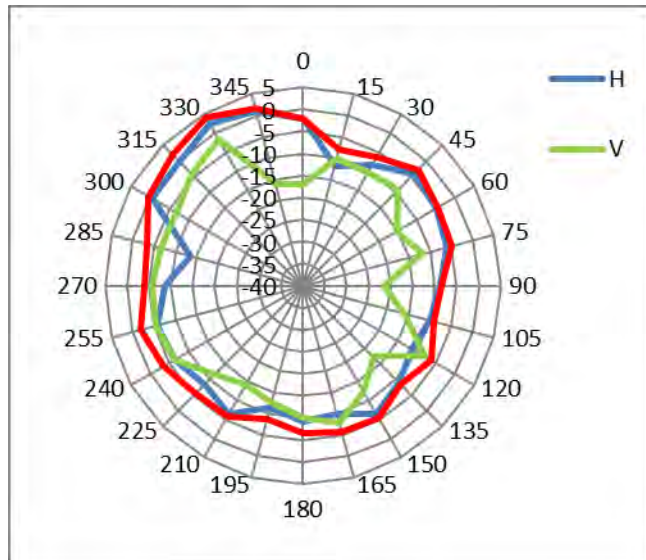

Main antenna: 3800.00 MHz

3800.00 MHz	
Horizontal Peak (dBi)	1.94
Vertical Peak(dBi)	-3.8

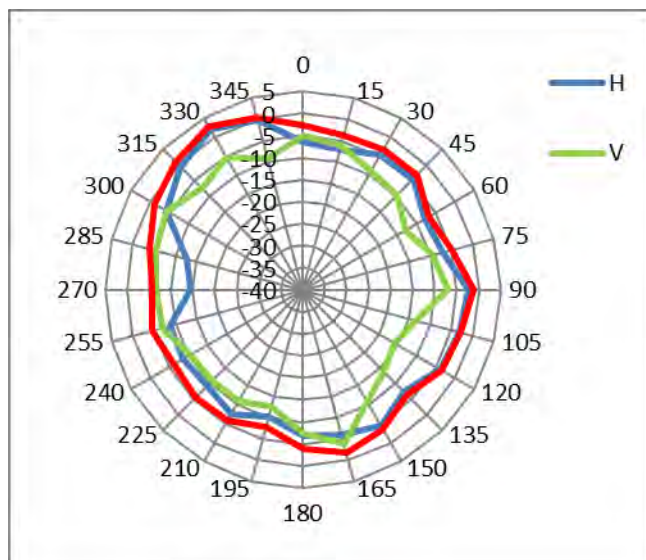

Radiation characteristic in 4400MHz ~ 5000MHz (CN/JP 5G NR Band 79)

Main antenna: 4400.00 MHz

4400.00 MHz	
Horizontal Peak (dBi)	-3.16
Vertical Peak(dBi)	-4.28

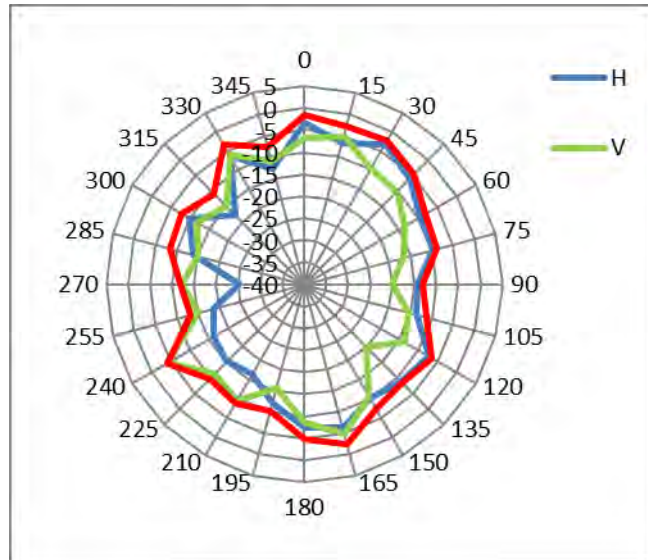

Main antenna: 4700.00 MHz

4700.00 MHz	
Horizontal Peak (dBi)	-6.09
Vertical Peak(dBi)	-5.99

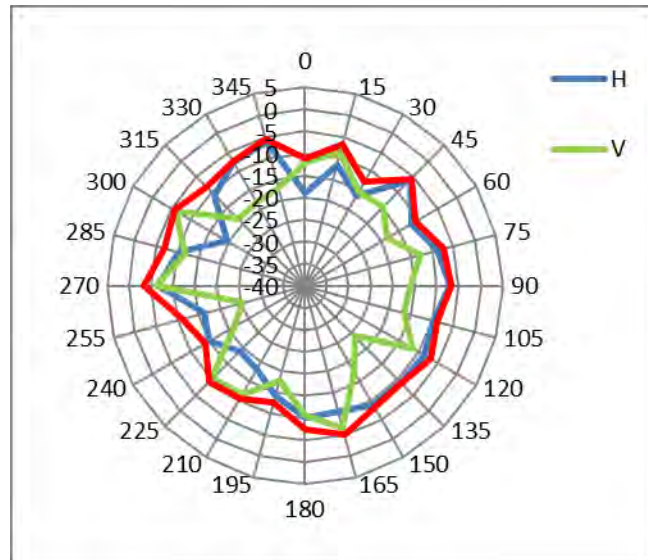

Main antenna: 5000.00 MHz

5000.00 MHz	
Horizontal Peak (dBi)	-2.98
Vertical Peak(dBi)	-3.67

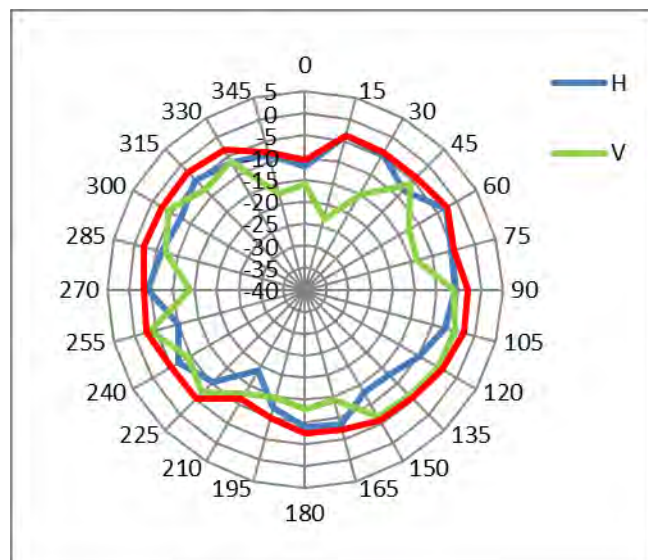

Radiation characteristic in 1455.4MHz ~ 1477.9MHz (Japan UE-UTRA, Band 21)

Main antenna: 1455.40 MHz

1455.40 MHz	
Horizontal Peak (dBi)	-4.2
Vertical Peak(dBi)	-11.46

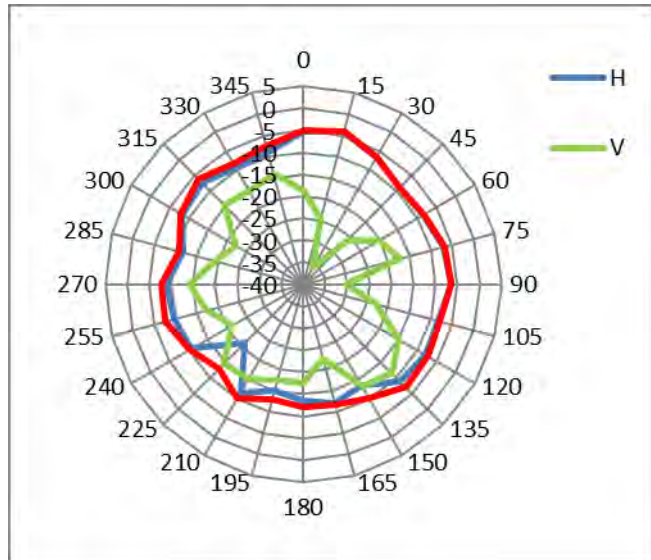

Main antenna: 1462.90 MHz

1462.90 MHz	
Horizontal Peak (dBi)	-3.69
Vertical Peak(dBi)	-11.49

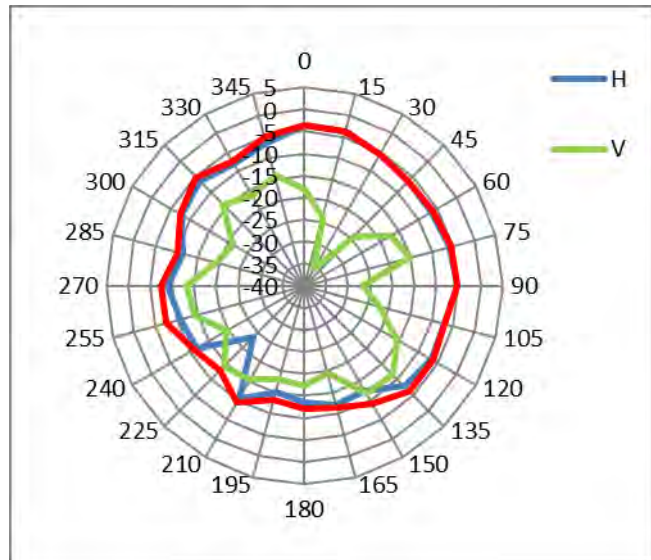

Main antenna: 1477.90 MHz

1477.90 MHz	
Horizontal Peak (dBi)	-2.6
Vertical Peak(dBi)	-11.56

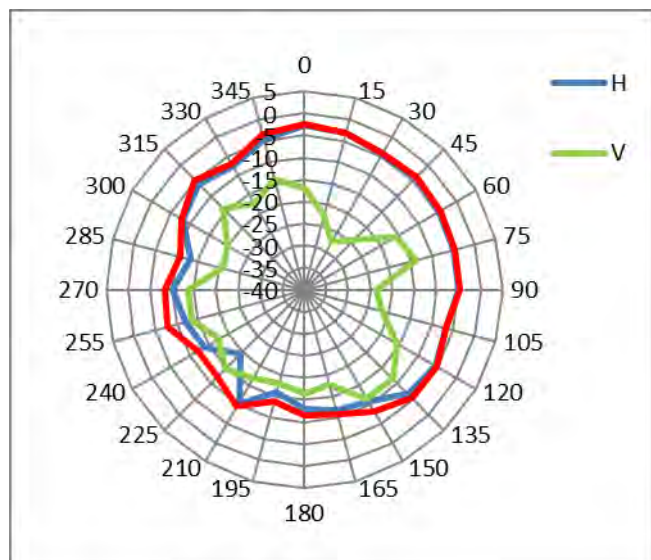

Radiation characteristic in 815MHz ~ 836.5MHz (Japan J-CDMA)

Main antenna: 815.00 MHz

815.00 MHz	
Horizontal Peak (dBi)	-3.75
Vertical Peak(dBi)	-7.7

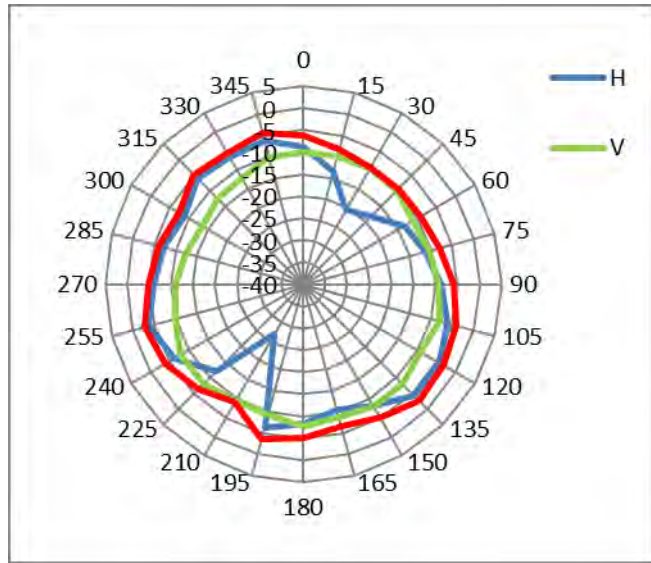

Main antenna: 824.70 MHz

824.70 MHz	
Horizontal Peak (dBi)	-3.25
Vertical Peak(dBi)	-6.92

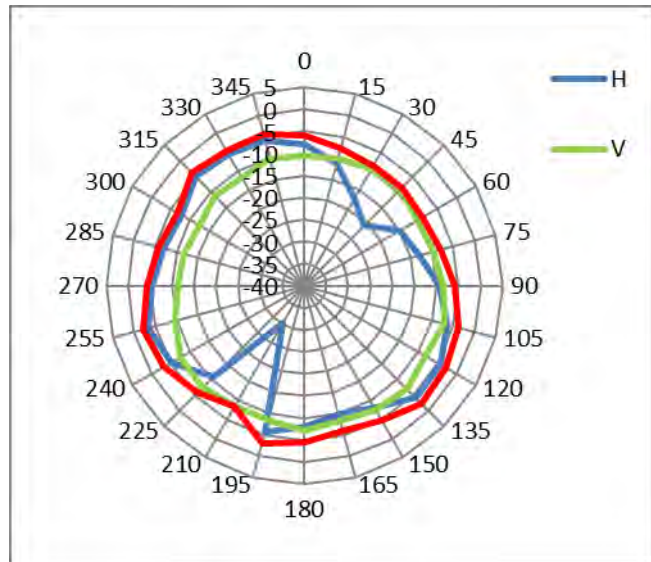

Main antenna: 836.50 MHz

836.50 MHz	
Horizontal Peak (dBi)	-3.24
Vertical Peak(dBi)	-6.13

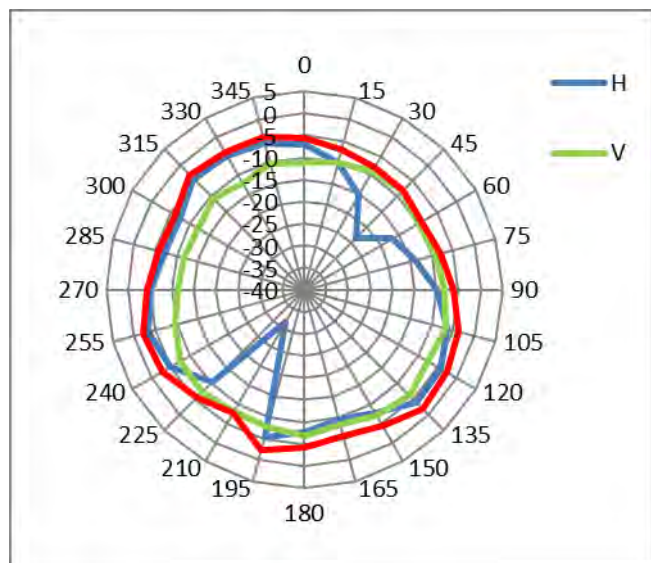

Radiation characteristic in 848.3MHz ~ 880.2MHz (Japan J-CDMA)

Main antenna: 848.30 MHz

848.30 MHz	
Horizontal Peak (dBi)	-3.53
Vertical Peak(dBi)	-5.32

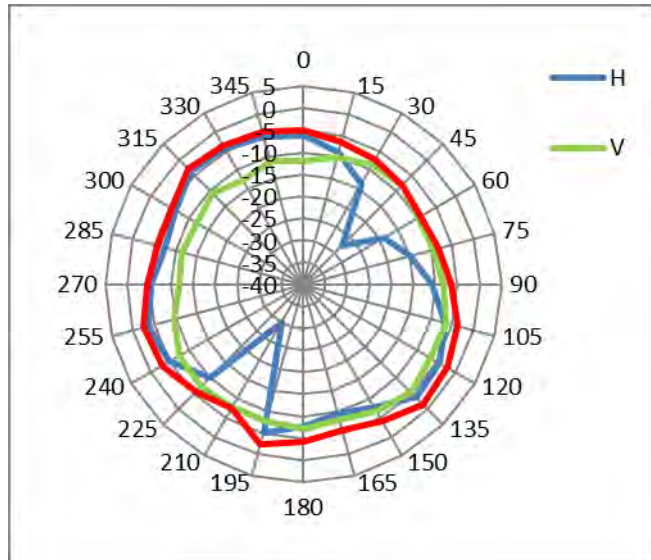

Main antenna: 870.00 MHz

870.00 MHz	
Horizontal Peak (dBi)	-3.67
Vertical Peak(dBi)	-4.91

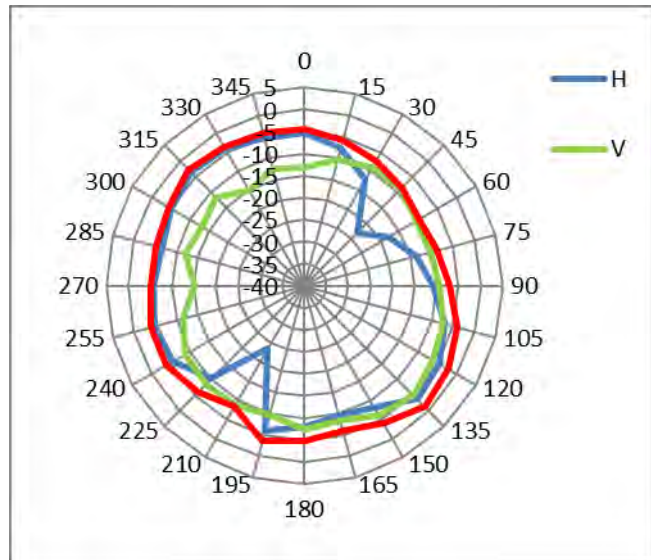

Main antenna: 880.20 MHz

880.20 MHz	
Horizontal Peak (dBi)	-3.74
Vertical Peak(dBi)	-5.07

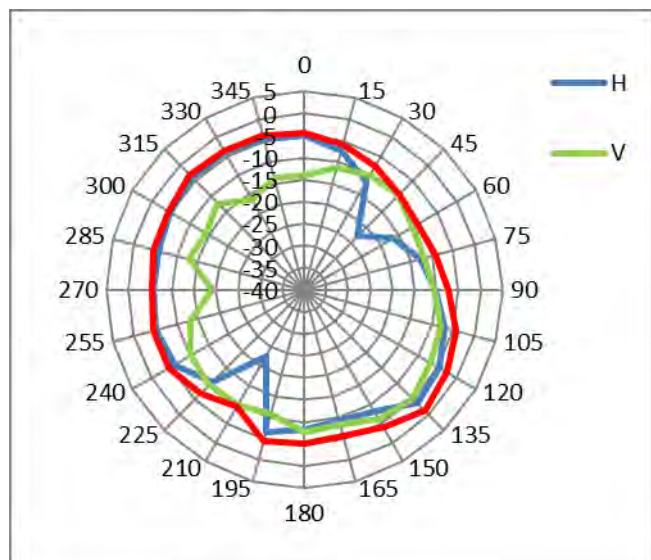

Radiation characteristic in 897.6MHz ~ 925MHz (Japan J-CDMA)

Main antenna: 897.60 MHz

897.60 MHz	
Horizontal Peak (dBi)	-3.04
Vertical Peak(dBi)	-6.5

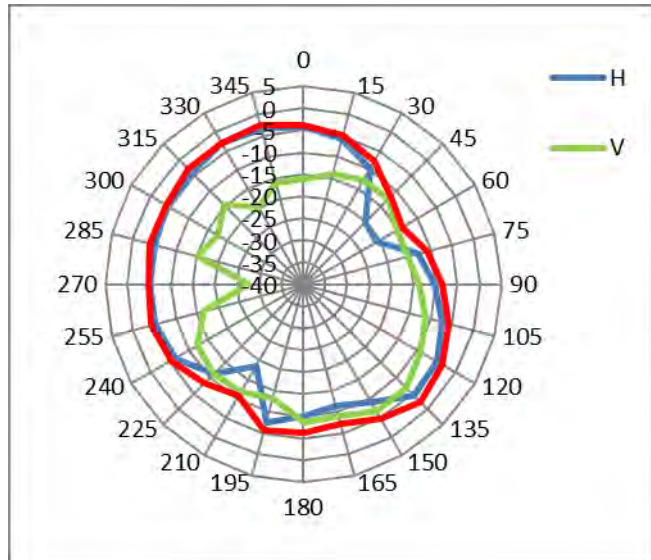

Main antenna: 914.80 MHz

914.80 MHz	
Horizontal Peak (dBi)	-2.7
Vertical Peak(dBi)	-7

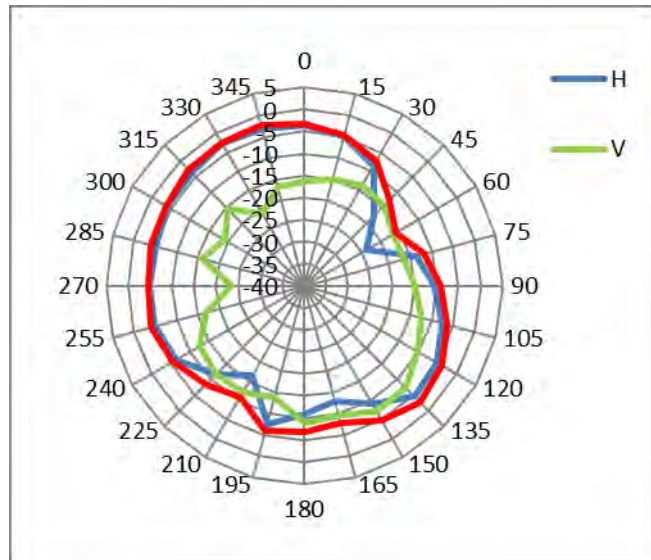

Main antenna: 925.00 MHz

925.00 MHz	
Horizontal Peak (dBi)	-2.56
Vertical Peak(dBi)	-7.64

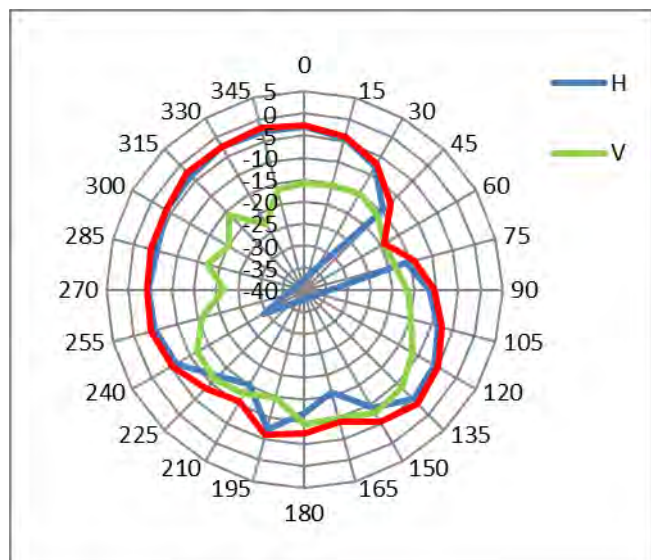

Radiation characteristic in 940MHz (Japan J-CDMA)

Main antenna: 940.00 MHz

940.00 MHz	
Horizontal Peak (dBi)	-2.22
Vertical Peak(dBi)	-8.79

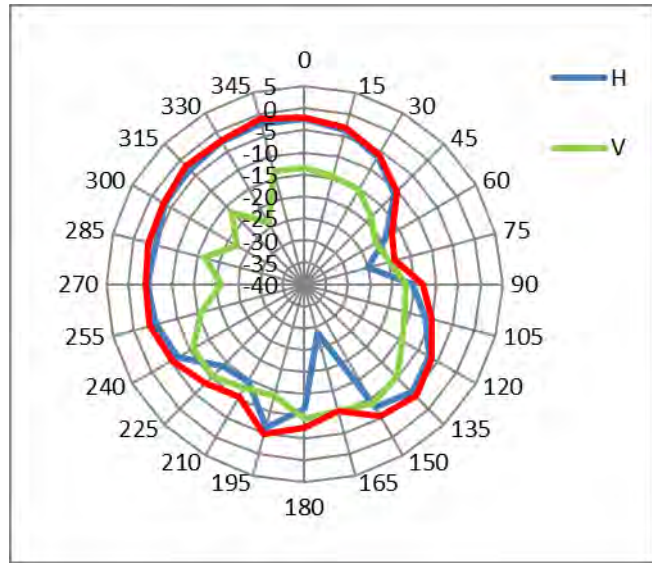

Radiation characteristic in 1922.4MHz ~ 1977.6MHz (Japan J-CDMA)

Main antenna: 1922.40 MHz

1922.40 MHz	
Horizontal Peak (dBi)	0.7
Vertical Peak(dBi)	-4.94

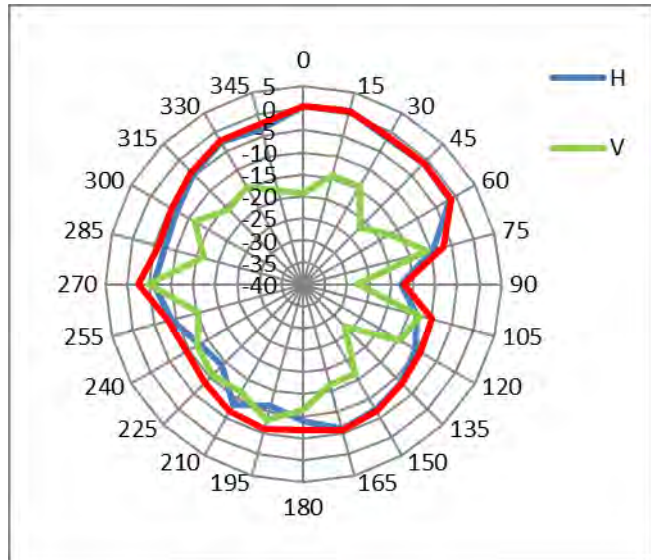

Main antenna: 1950.00 MHz

1950.00 MHz	
Horizontal Peak (dBi)	1.05
Vertical Peak(dBi)	-4.19

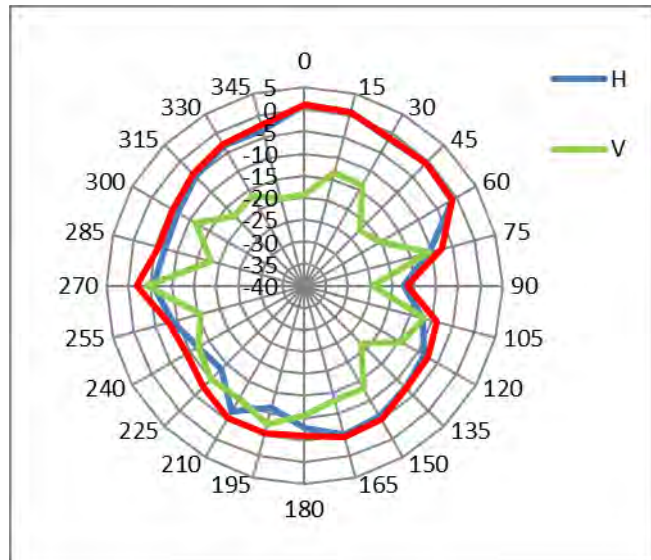

Main antenna: 1977.60 MHz

1977.60 MHz	
Horizontal Peak (dBi)	1.1
Vertical Peak(dBi)	-3.51

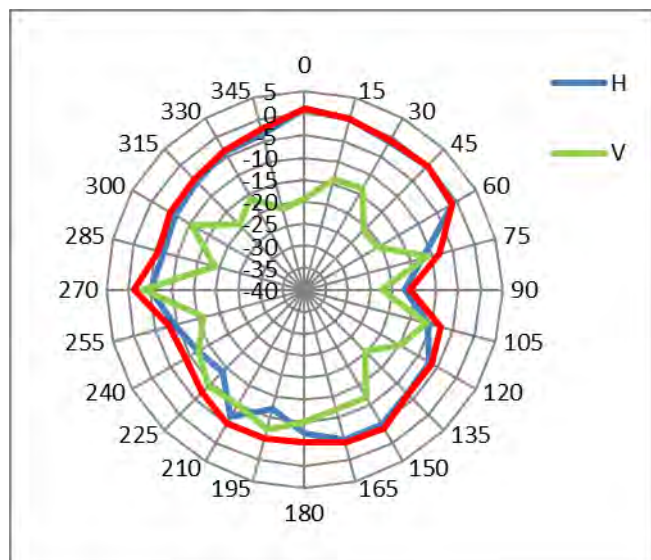

Section 4. Antenna Host Platform Location Information

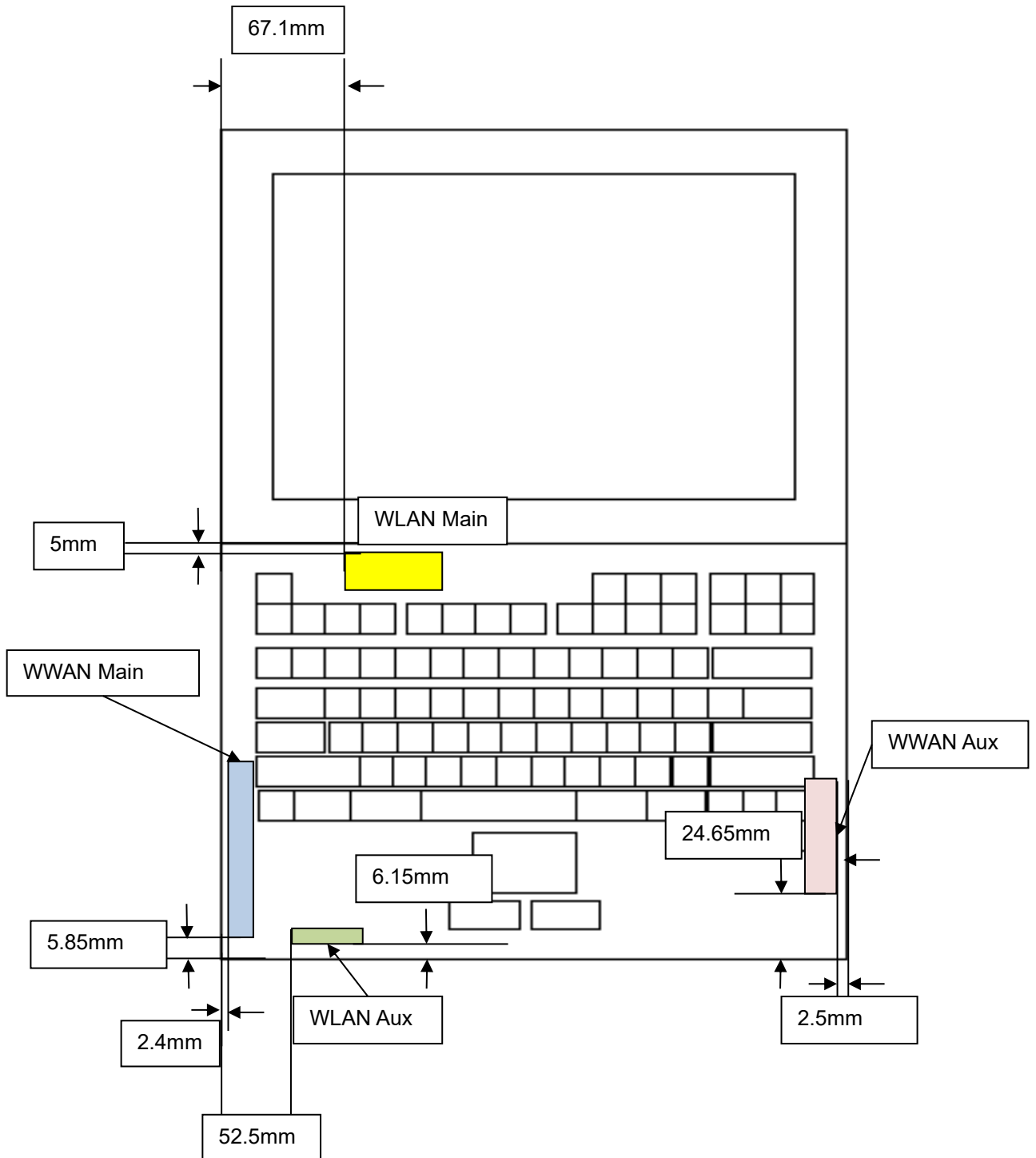

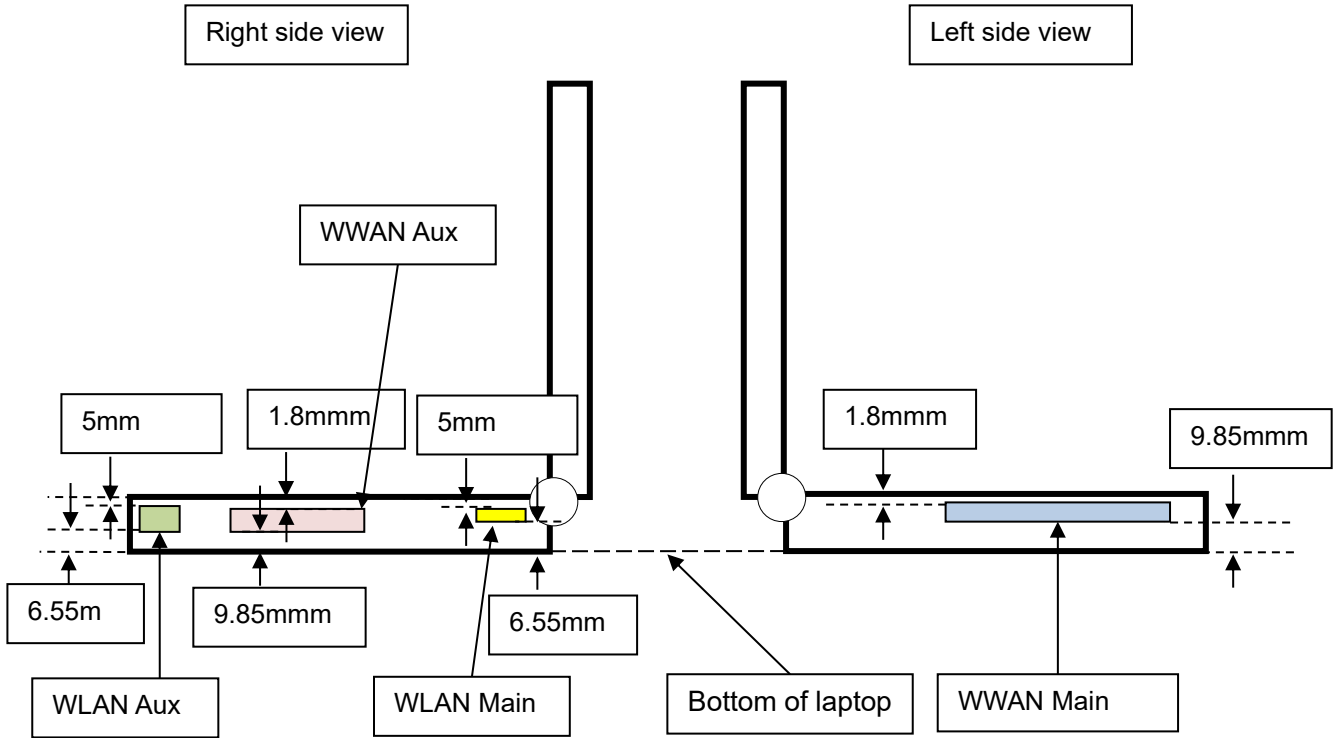

Section 5. Antenna dimensional information for SAR evaluation

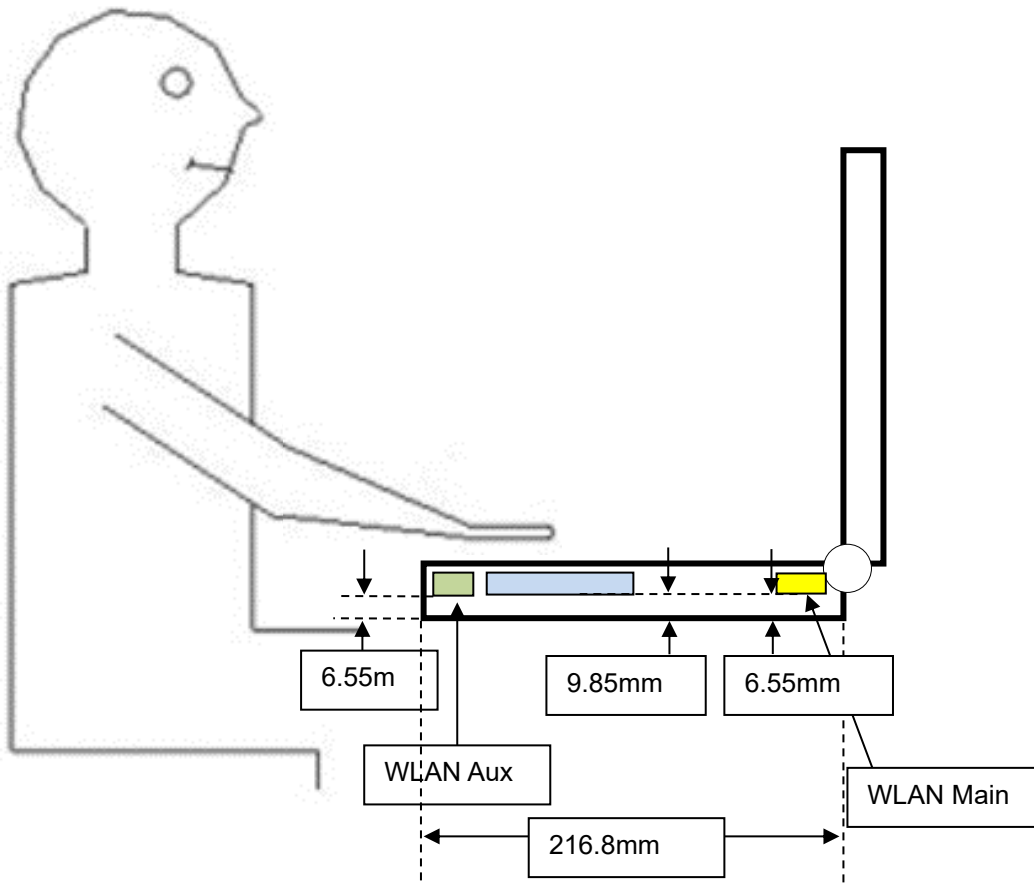

Tablet Mode Right Side View:

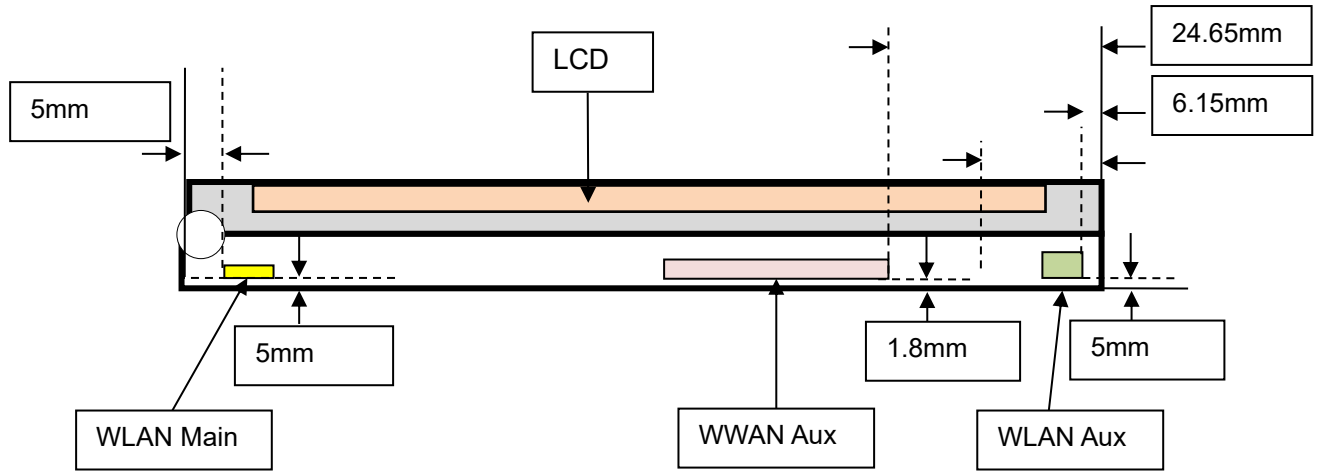

Tablet Mode Left Side View

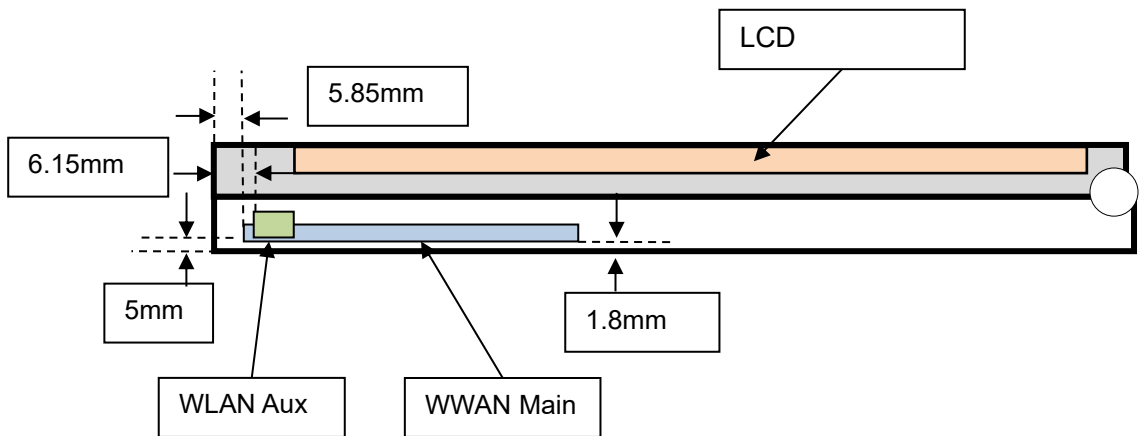

Tablet Mode Top Side View

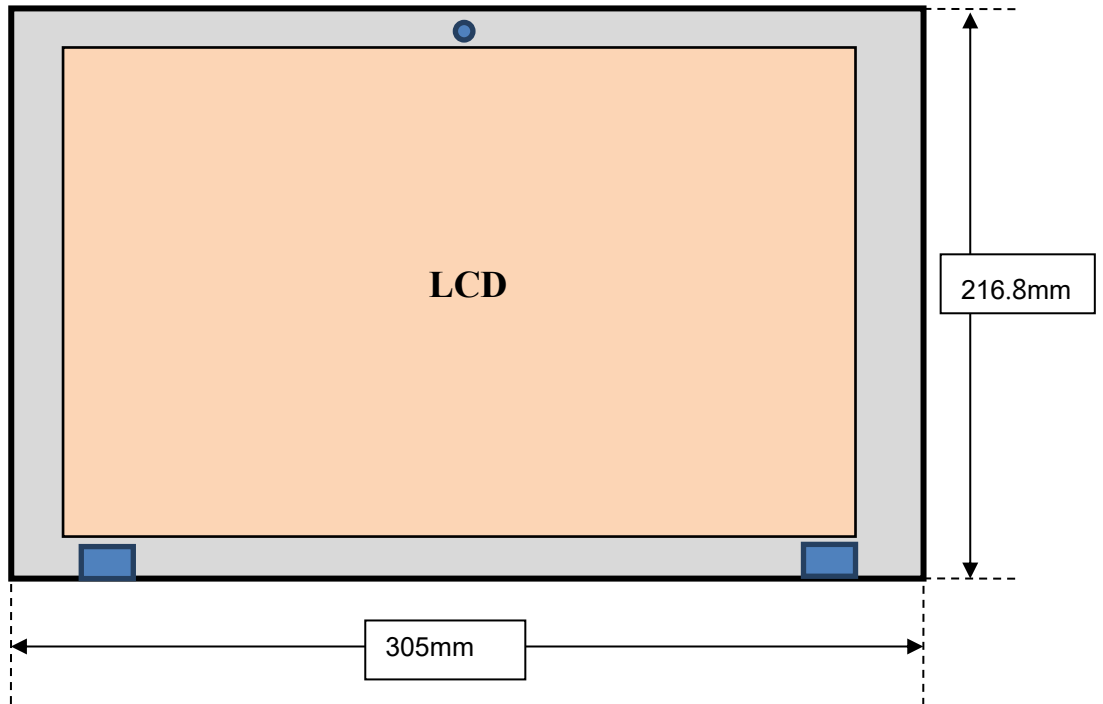

Tablet Mode Bottom Side View

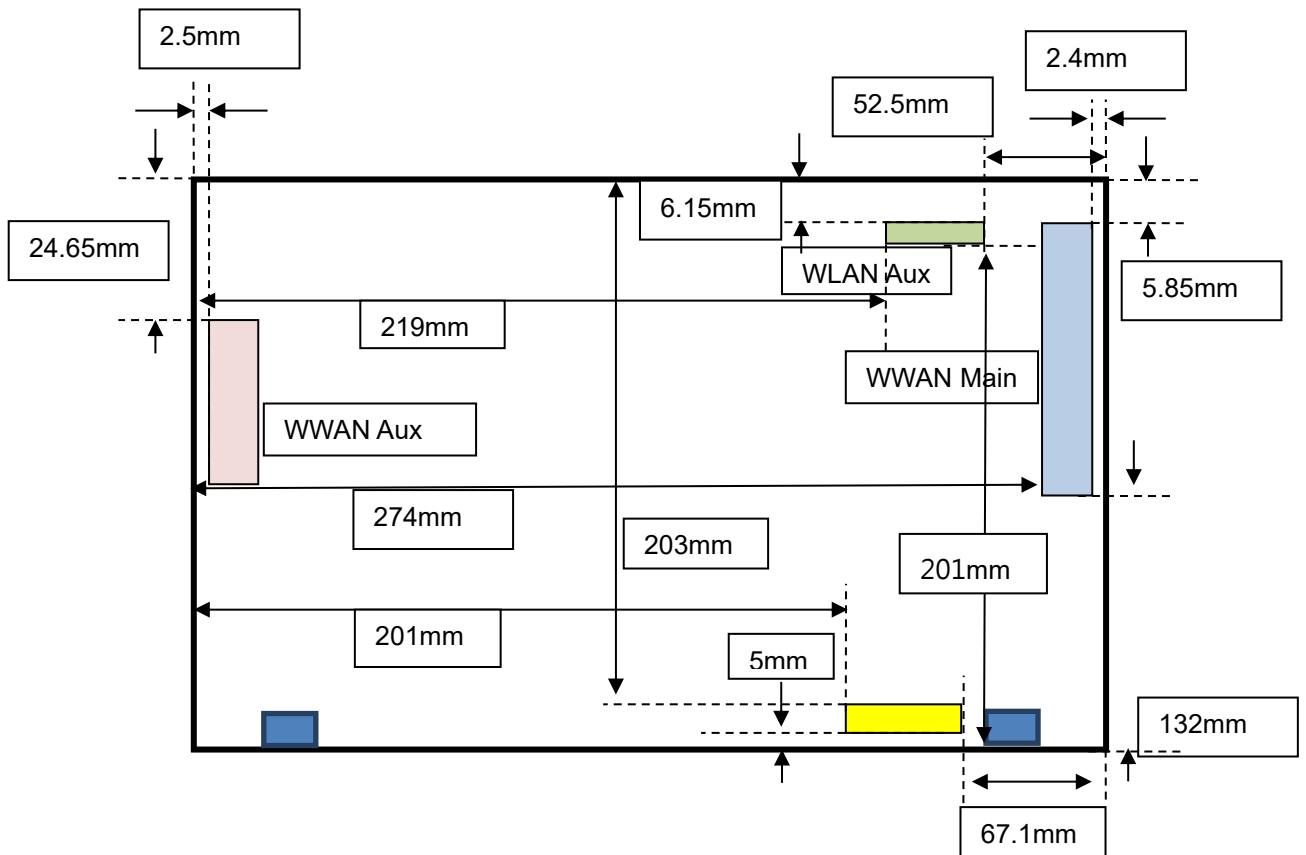

Tablet Mode Top View Figure 2:

