

FCC Radio Test Report

FCC ID: PU5-LN300WG3L

Report No. : BTL-FCCP-15-2102T172A
Equipment : Notebook Computer
Model Name : Lenovo 300w Gen 3xxxxxxx (The "x" in model name can be 0 to 9, A to Z, a to z, "-" or blank, for marketing purpose only)
Brand Name : Lenovo
Applicant : Wistron Corporation
Address : 21F, No. 88, Sec. 1, Hsin Tai Wu Rd., Hsichih Dist, New Taipei City 221, Taiwan

Radio Function : WCDMA Band IV, LTE Band 4, 7, 12, 13, 17, 30, 41, 66

FCC Rule Part(s) : 47 CFR FCC Part 27 Subpart D
47 CFR FCC Part 27 Subpart F
47 CFR FCC Part 27 Subpart H
47 CFR FCC Part 27 Subpart L
47 CFR FCC Part 27 Subpart M

Measurement Procedure(s) : ANSI C63.26-2015
ANSI/TIA-603-E-2016
FCC KDB 971168 D01 Power Meas License Digital Systems v03r01

Date of Receipt : 2021/3/12
Date of Test : 2021/3/12 ~ 2021/3/31
Issued Date : 2021/4/27

The above equipment has been tested and found in compliance with the requirement of the above standards by BTL Inc.

Prepared by 
Peter Chen, Engineer

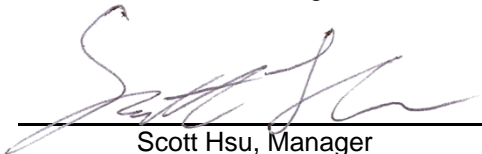
Approved by : 
Scott Hsu, Manager

**BTL Inc.**

No.18, Ln. 171, Sec. 2, Jiuzong Rd., Neihu Dist., Taipei City 114, Taiwan

Tel: +886-2-2657-3299

Fax: +886-2-2657-3331

Web: www.newbtl.com

Declaration

BTL represents to the client that testing is done in accordance with standard procedures as applicable and that test instruments used has been calibrated with standards traceable to international standard(s) and/or national standard(s).

BTL's reports apply only to the specific samples tested under conditions. It is manufacture's responsibility to ensure that additional production units of this model are manufactured with the identical electrical and mechanical components. **BTL** shall have no liability for any declarations, inferences or generalizations drawn by the client or others from **BTL** issued reports.

This report is the confidential property of the client. As a mutual protection to the clients, the public and ourselves, the test report shall not be reproduced, except in full, without our written approval.

BTL's laboratory quality assurance procedures are in compliance with the **ISO/IEC 17025** requirements, and accredited by the conformity assessment authorities listed in this test report.

BTL is not responsible for the sampling stage, so the results only apply to the sample as received.

The information, data and test plan are provided by manufacturer which may affect the validity of results, so it is manufacturer's responsibility to ensure that the apparatus meets the essential requirements of applied standards and in all the possible configurations as representative of its intended use.

Limitation

For the use of the authority's logo is limited unless the Test Standard(s)/Scope(s)/Item(s) mentioned in this test report is (are) included in the conformity assessment authorities acceptance respective.

Please note that the measurement uncertainty is provided for informational purpose only and are not use in determining the Pass/Fail results.

CONTENTS

1	SUMMARY OF TEST RESULTS	5
1.1	TEST FACILITY	6
1.2	MEASUREMENT UNCERTAINTY	6
1.3	TEST ENVIRONMENT CONDITIONS	6
2	GENERAL INFORMATION	7
2.1	DESCRIPTION OF EUT	7
2.2	TEST MODES	8
2.3	BLOCK DIAGRAM SHOWING THE CONFIGURATION OF SYSTEM TESTED	9
2.4	SUPPORT UNITS	10
3	AC POWER LINE CONDUCTED EMISSIONS TEST	11
3.1	LIMIT	11
3.2	TEST PROCEDURE	11
3.3	DEVIATION FROM TEST STANDARD	11
3.4	TEST SETUP	12
3.5	TEST RESULT	12
4	RADIATED SPURIOUS EMISSIONS MEASUREMENT	13
4.1	LIMIT	13
4.2	TEST PROCEDURE	13
4.3	DEVIATION FROM TEST STANDARD	13
4.4	TEST SETUP	14
4.5	EUT OPERATING CONDITIONS	14
4.6	TEST RESULT	14
5	LIST OF MEASURING EQUIPMENTS	15
6	EUT TEST PHOTO	16
7	EUT PHOTOS	16
APPENDIX A	AC POWER LINE CONDUCTED EMISSIONS	17
APPENDIX B	RADIATED SPURIOUS EMISSIONS	22
APPENDIX C	REFERENCE INFORMATION	105

REVISION HISTORY

Report No.	Version	Description	Issued Date
BTL-FCCP-15-2102T172A	R00	Original Report.	2021/4/27

1 SUMMARY OF TEST RESULTS

Test procedures according to the technical standards.

FCC Clause No	Description	Test Result	Judgement	Remark
15.207	AC Power Line Conducted Emissions	APPENDIX A	Pass	-----
2.1053 27.53(a)(4) 27.53(c)(2) 27.53(f) 27.53(g) 27.53(h) 27.53(m)(4)	Radiated Spurious Emissions	APPENDIX B	Pass	-----

NOTE:

- (1) "N/A" denotes test is not applicable in this Test Report.
- (2) The report format version is TP.1.1.1.
- (3) The WWAN test result refer FCC ID: PU5-LN300WG3D that the system of 2 FCC IDs (WWAN system IDs) are identical HW design of system, the same WWAN module and WWAN + WLAN antennas. The only difference is different FCC ID contains different certified WLAN module.
- (4) After spot check, this revision does not change original radio parameters.

1.1 TEST FACILITY

The test facilities used to collect the test data in this report:

No. 68-1, Ln. 169, Sec. 2, Datong Rd., Xizhi Dist., New Taipei City 221, Taiwan
 The test sites and facilities are covered under FCC RN: 355421 and DN: TW1099.

C05 CB08 CB11 CB15 CB16

1.2 MEASUREMENT UNCERTAINTY

The reported uncertainty of measurement $y \pm U$, where expanded uncertainty U is based on a standard uncertainty multiplied by a coverage factor of $k = 2$, providing a level of confidence of approximately **95 %**. The measurement instrumentation uncertainty considerations contained in CISPR 16-4-2. The BTL measurement uncertainty is less than the CISPR 16-4-2 U_{cispr} requirement.

A. AC power line conducted emissions test:

Test Site	Method	Measurement Frequency Range	U (dB)
C05	CISPR	150 kHz ~ 30MHz	3.44

B. Radiated emissions test :

Test Site	Measurement Frequency Range	U,(dB)
CB15	0.03 GHz ~ 0.2 GHz	4.17
	0.2 GHz ~ 1 GHz	4.72
	1 GHz ~ 6 GHz	5.21
	6 GHz ~ 18 GHz	5.51
	18 GHz ~ 26 GHz	3.69
	26 GHz ~ 40 GHz	4.23

NOTE:

Unless specifically mentioned, the uncertainty of measurement has not been taken into account to declare the compliance or non-compliance to the specification.

1.3 TEST ENVIRONMENT CONDITIONS

Test Item	Environment Condition	Test Voltage	Tested by
AC Power Line Conducted Emissions	20 °C, 72 %	AC 120V	Vincent Lee
Radiated Spurious Emissions	Refer to data	AC 120V	Jay Kao

2 GENERAL INFORMATION

2.1 DESCRIPTION OF EUT

Equipment	Notebook Computer		
Model Name	Lenovo 300w Gen 3xxxxxxx (The "x" in model name can be 0 to 9, A to Z, a to z, "-" or blank, for marketing purpose only)		
Brand Name	Lenovo		
Model Difference	Different model distribute to different area.		
Power Source	DC voltage supplied from External Power Supply. (Lenovo/ADLX45YLC3D)		
Power Rating	I/P: 100-240V~1.3A 50-60Hz O/P: 20.0V---2.25A 45.0W / 15.0V---3.0A / 9.0V---2.0A / 5.0V---2.0A 10.0W		
Products Covered	1 * Adapter: Lenovo/ADLX45YLC3D		
WIFI+BT Module	Realtek / RTL8822CE		
WWAN Module	Fibocom / L850-GL		
Operation Frequency	Band	UL Frequency (MHz)	DL Frequency (MHz)
	WCDMA IV	1710 ~ 1755	2110 ~ 2155
	LTE 4	1710 ~ 1755	2110 ~ 2155
	LTE 7	2500 ~ 2570	2620 ~ 2690
	LTE 12	699 ~ 716	729 ~ 746
	LTE 13	777 ~ 787	746 ~ 756
	LTE 17	704 ~ 716	734 ~ 746
	LTE 30	2305 ~ 2315	2350 ~ 2360
	LTE 41	2496 ~ 2690	-
LTE 66	1710 ~ 1780	2110 ~ 2200	
Test Model	Lenovo 300w Gen 3		
Sample Status	Engineering Sample		
EUT Modification(s)	N/A		

NOTE:

(1) For a more detailed features description, please refer to the manufacturer's specifications or the user's manual.

(2) Table for Filed Antenna:

Antenna	Manufacture	Parts Number	Type	Connector	Gain (dBi)	Note
Main	INPAQ Corporation	025.901TX.0001	PIFA	I-PEX	-0.22	WCDMA Band IV
						LTE Band 4
					1.88	LTE Band 7
					-6.73	LTE Band 12
					-5.59	LTE Band 13
					-7.84	LTE Band 17
					2.14	LTE Band 30
					1.95	LTE Band 41
					-0.22	LTE Band 66
Aux	INPAQ Corporation	025.901TY.0001	PIFA	I-PEX	-	RX only

2.2 TEST MODES

Test Items	Band	Test Mode	Note
AC Power Line Conducted Emissions	-	Normal/Idle	-
Radiated Spurious Emissions	WCDMA Band IV	TX Mode (CH 1537/1652/1738)	-
	LTE Band 4	TX Mode (CH 20050/20175/20300)	-
	LTE Band 7	TX Mode (CH 20850/21100/21350)	-
	LTE Band 12	TX Mode (CH 23060/23095/23130)	-
	LTE Band 13	TX Mode (CH 23230)	-
	LTE Band 17	TX Mode (CH 23780/23790/23800)	-
	LTE Band 30	TX Mode (CH 27710)	-
	LTE Band 41	TX Mode (CH 39750/40620/41490)	-
	LTE Band 66	TX Mode (CH 132072/132322/132572)	-

NOTE:

- (1) The Radiated emissions test was verified based on the worst conducted power and Bandwidth test results reported in the original report.
- (2) All X, Y and Z axes are evaluated, but only the worst case (WCDMA: Z axis, LTE Band 4/7/30/41/66: Y axis, LTE Band 12/13/17: X axis) is recorded.

2.3 BLOCK DIAGRAM SHOWING THE CONFIGURATION OF SYSTEM TESTED

Equipment letters and Cable numbers refer to item numbers described in the tables of clause 2.4.

AC Power Line Conducted Emissions Test

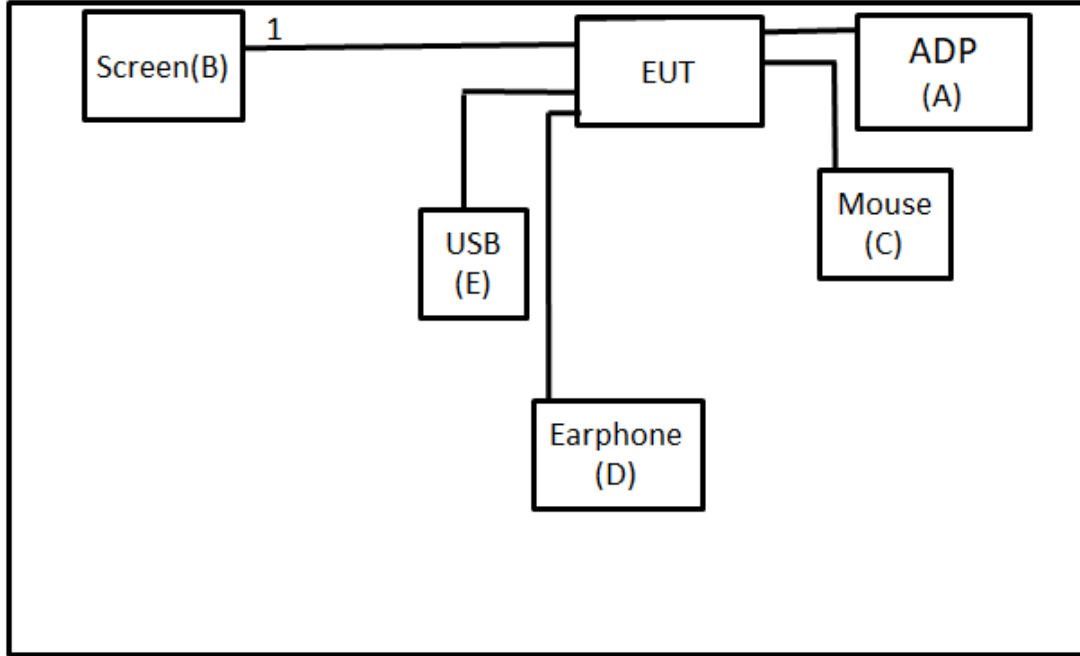

Radiated Emissions Test

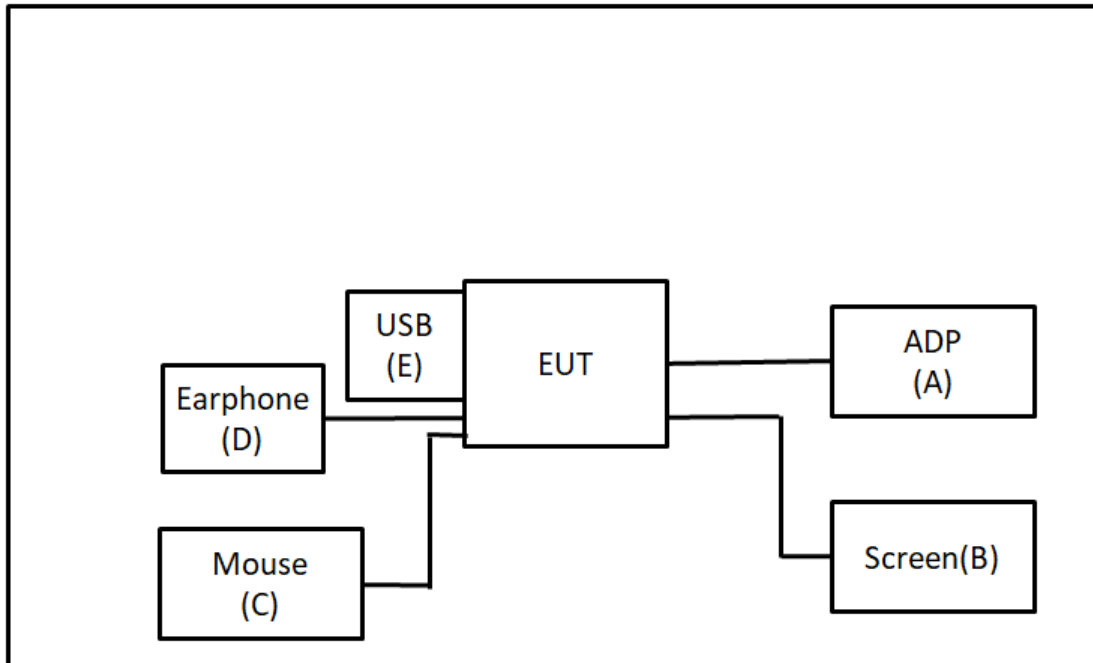

2.4 SUPPORT UNITS

Item	Equipment	Brand	Model No.	Series No.	Remarks
A	ADP	Lenovo	ADLX45YLC3D	N/A	Supplied by test requester.
B	Screen	ASUS	MX27U	N/A	Furnished by test lab.
C	Mouse	ACER	MP-368	N/A	Furnished by test lab.
D	Earphone	Sony	MDR-E9LP	N/A	Furnished by test lab.
E	USB	Kingston	C7052-322.AOOL F	N/A	Furnished by test lab.

Item	Shielded	Ferrite Core	Length	Cable Type	Remarks
1	N/A	N/A	1.8m	HDMI Cable	Furnished by test lab.

3 AC POWER LINE CONDUCTED EMISSIONS TEST

3.1 LIMIT

Frequency (MHz)	Limit (dB μ V)	
	Quasi-peak	Average
0.15 - 0.5	66 - 56 *	56 - 46 *
0.50 - 5.0	56	46
5.0 - 30.0	60	50

NOTE:

- (1) The tighter limit applies at the band edges.
- (2) The limit of " * " marked band means the limitation decreases linearly with the logarithm of the frequency in the range.
- (3) The test result calculated as following:
 Measurement Value = Reading Level + Correct Factor
 Correct Factor = Insertion Loss + Cable Loss + Attenuator Factor (if use)
 Margin Level = Measurement Value – Limit Value
 Calculation example:

Reading Level		Correct Factor		Measurement Value
38.22	+	3.45	=	41.67

Measurement Value		Limit Value		Margin Level
41.67	-	60	=	-18.33

The following table is the setting of the receiver.

Receiver Parameter	Setting
Attenuation	10 dB
Start Frequency	0.15 MHz
Stop Frequency	30 MHz
IF Bandwidth	9 KHz

3.2 TEST PROCEDURE

- a. The EUT was placed 0.8 m above the horizontal ground plane with the EUT being connected to the power mains through a line impedance stabilization network (LISN).
 All other support equipment were powered from an additional LISN(s).
 The LISN provides 50 Ohm/50uH of impedance for the measuring instrument.
- b. Interconnecting cables that hang closer than 40 cm to the ground plane shall be folded back and forth in the center forming a bundle to keep the cable above 40 cm.
- c. Excess I/O cables that are not connected to a peripheral shall be bundled in the center.
 The end of the cable will be terminated, using the correct terminating impedance.
 The overall length shall not exceed 1 m.
- d. The LISN is spaced at least 80 cm from the nearest part of the EUT chassis.
- e. For the actual test configuration, please refer to the related Item - EUT TEST PHOTO.

NOTE:

- (1) In the results, each reading is marked as Peak, QP or AVG per the detector used.
 BW=9 kHz (6 dB Bandwidth)
- (2) All readings are Peak unless otherwise stated QP or AVG in column of Note. Both the QP and the AVG readings must be less than the limit for compliance.

3.3 DEVIATION FROM TEST STANDARD

No deviation.

3.4 TEST SETUP

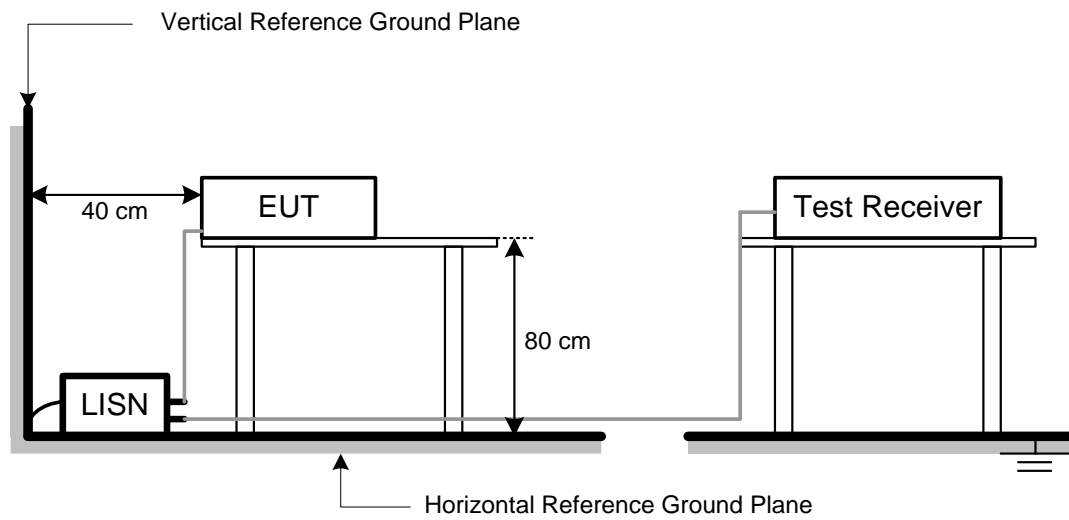

3.5 TEST RESULT

Please refer to the APPENDIX A.

4 RADIATED SPURIOUS EMISSIONS MEASUREMENT

4.1 LIMIT

The power of any emission outside of the authorized operating frequency ranges must be attenuated below the transmitting power (P) by a factor of at least $43 + 10 \log(P)$ dB. The emission limit equal to -13dBm.

NOTE:

(1) The test result calculated as following:

Measurement Value = Reading Level + Correct Factor

Correct Factor = Antenna Factor + Cable Loss - Amplifier Gain(if use)

Margin Level = Measurement Value - Limit Value

Calculation example:

Reading Level		Correct Factor		Measurement Value
-50.43	+	-2.11	=	-52.54

Measurement Value		Limit Value		Margin Level
-52.54	-	-13	=	-39.54

4.2 TEST PROCEDURE

The testing follows FCC KDB 971168 v03r01 Section 6.2.

- a. In the semi-anechoic chamber, EUT placed on the 0.8m height of Turn Table, rotated the table around 360 degrees to search the maximum radiation power and receiver antenna shall be rotated vertical and horizontal polarization and moved height from 1m to 4m to find the maximum polar radiated power. The "Read Value" is the spectrum reading the maximum power value.
- b. The substitution horn antenna is substituted for EUT at the same position and signals generator export the CW signal to the substitution antenna via a TX cable. Rotated the Turn Table and moved receiving antenna to find the maximum radiation power. Adjust output power level of S.G to get a Value of spectrum reading equal to "Read Value " of step a. Record the power level of S.G
- c. EIRP = Output power level of S.G - TX cable loss + Antenna gain of substitution horn.
- d. ERP power can be calculated form EIRP power by subtracting the gain of dipole,
ERP power = EIRP power - 2.15 dBi.
- e. The resolution bandwidth and video bandwidth of test receiver/spectrum analyzer is 1 MHz / 3 MHz.

4.3 DEVIATION FROM TEST STANDARD

No deviation.

4.4 TEST SETUP

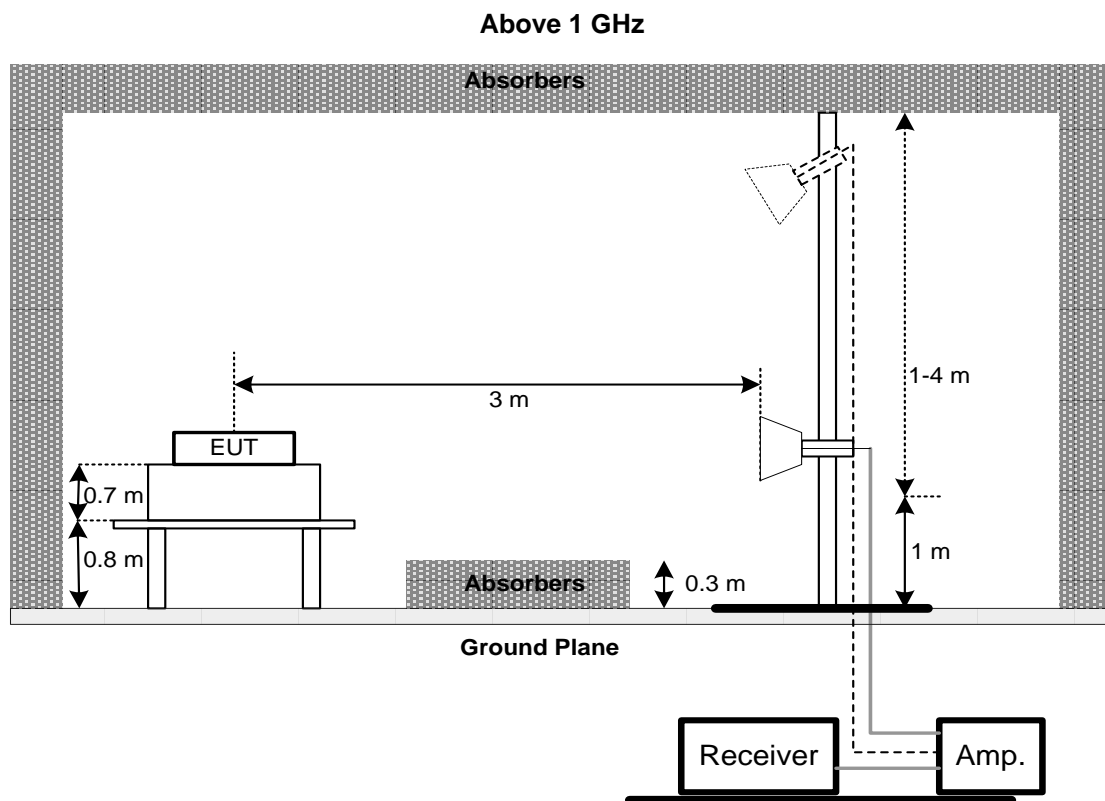
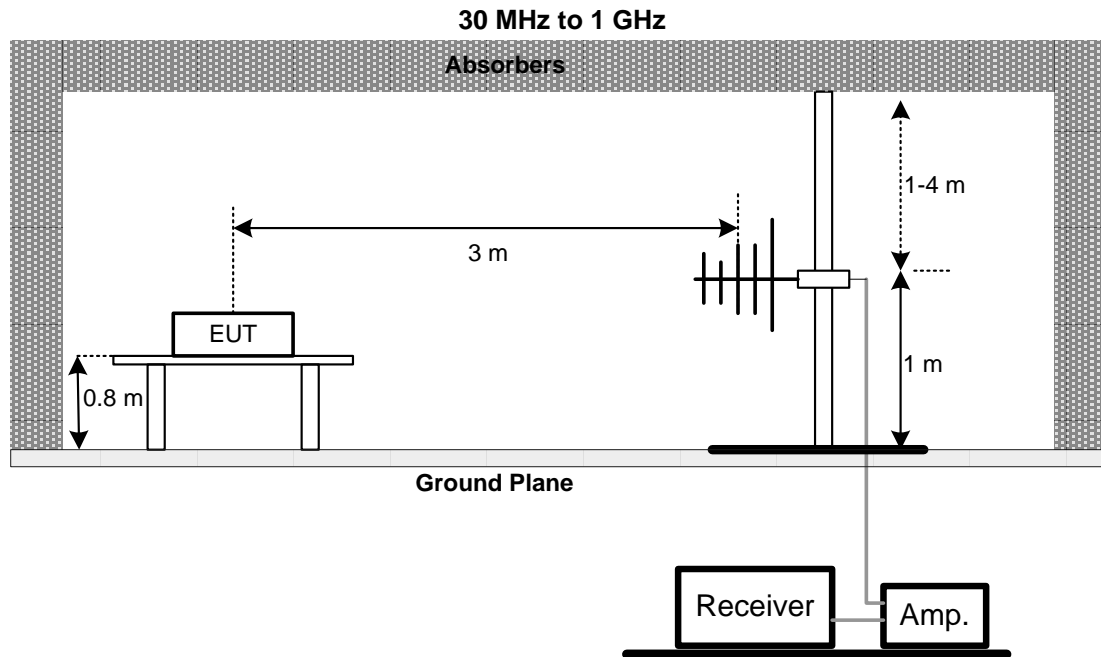

4.5 EUT OPERATING CONDITIONS

The EUT was programmed to be in continuously transmitting mode.

4.6 TEST RESULT

Please refer to the APPENDIX B

5 LIST OF MEASURING EQUIPMENTS

AC Power Line Conducted Emissions						
Item	Kind of Equipment	Manufacturer	Type No.	Serial No.	Calibrated Date	Calibrated Until
1	TWO-LINE V-NETWORK	R&S	ENV216	101050	2020/6/11	2021/6/10
2	Test Cable	EMCI	EMC400-BM-BM-5000	170501	2020/6/8	2021/6/7
3	EMI Test Receiver	R&S	ESCI	100080	2020/6/15	2021/6/14
4	Measurement Software	EZ	EZ EMC (Version NB-03A1-01)	N/A	N/A	N/A

Radiated Emissions						
Item	Kind of Equipment	Manufacturer	Type No.	Serial No.	Calibrated Date	Calibrated Until
1	Preamplifier	EMCI	EMC02325B	980217	2020/4/10	2021/4/9
2	Preamplifier	EMCI	EMC012645B	980267	2020/4/10	2021/4/9
3	Test Cable	EMCI	EMC-SM-SM-1000	180809	2020/4/10	2021/4/9
4	Test Cable	EMCI	EMC104-SM-SM-3000	151205	2020/4/10	2021/4/9
5	Test Cable	EMCI	EMC-SM-SM-7000	180408	2020/4/10	2021/4/9
6	MXE EMI Receiver	Agilent	N9038A	MY554200087	2020/6/10	2021/6/9
7	Signal Analyzer	Agilent	N9010A	MY56480554	2020/8/25	2021/8/24
8	Horn Ant	SCHWARZBECK	BBHA 9120D	9120D-1342	2020/6/12	2021/6/11
9	Horn Ant	Schwarzbeck	BBHA 9170	BBHA 9170340	2020/7/9	2021/7/8
10	Trilog-Broadband Antenna	Schwarzbeck	VULB 9168	VULB 9168-352	2020/7/24	2021/7/23
11	5dB Attenuator	EMCI	EMCI-N-6-05	AT-N0625	2020/7/24	2021/7/23
12	Measurement Software	EZ	EZ EMC (Version NB-03A1-01)	N/A	N/A	N/A
13	8960 Series 10 Wireless Com Test Set	Agilent	E5515C	GB47390193	2020/6/4	2021/6/3
14	Radio Communication Analyzer (LTE)	Anritsu	MT8820C	6201525878	2020/6/3	2021/6/2
15	Radio Communication Analyzer	Anritsu	MT8821C	6262044728	2020/12/15	2021/12/14

Remark: "N/A" denotes no model name, no serial no. or no calibration specified.
All calibration period of equipment list is one year.

6 EUT TEST PHOTO

Please refer to document Appendix No.: TP-2102T172A-2 (APPENDIX-TEST PHOTOS).

7 EUT PHOTOS

Please refer to document Appendix No.: EP-2102T172A-1 (APPENDIX-EUT PHOTOS).

APPENDIX A AC POWER LINE CONDUCTED EMISSIONS

Test Mode	Normal	Tested Date	2021/3/23
Test Frequency	-	Phase	Line

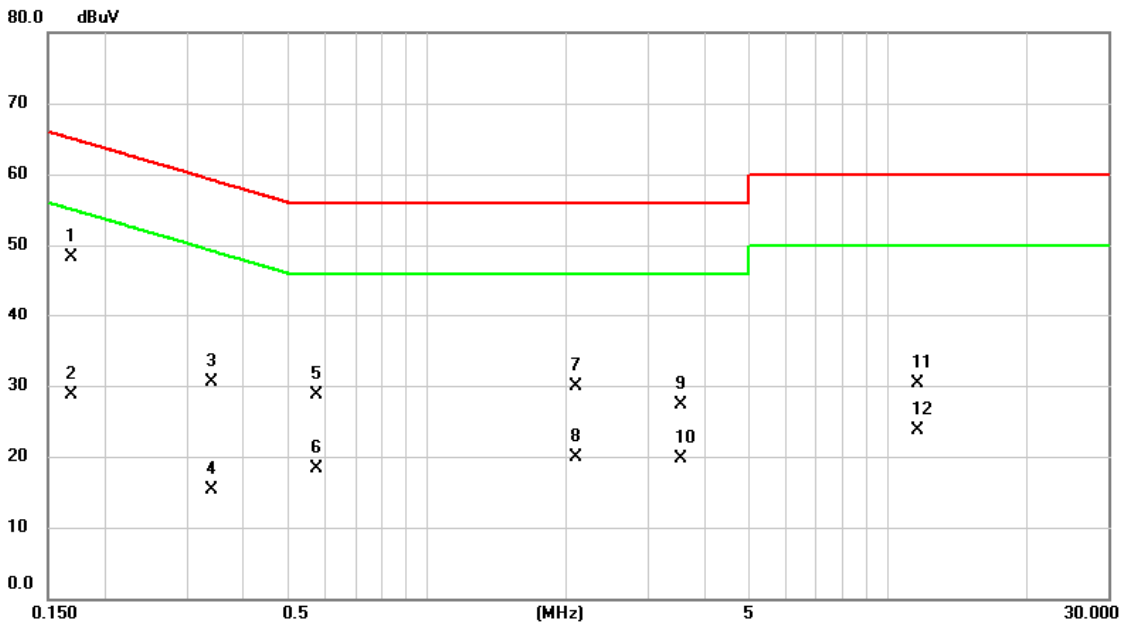

No.	Mk.	Freq.	Reading Level	Correct Factor	Measurement	Limit	Over		
		MHz	dBuV	dB	dBuV	dBuV	dB	Detector	Comment
1	*	0.1685	38.71	9.68	48.39	65.03	-16.64	QP	
2		0.1685	19.08	9.68	28.76	55.03	-26.27	AVG	
3		0.3412	20.75	9.68	30.43	59.17	-28.74	QP	
4		0.3412	5.54	9.68	15.22	49.17	-33.95	AVG	
5		0.5752	19.02	9.68	28.70	56.00	-27.30	QP	
6		0.5752	8.59	9.68	18.27	46.00	-27.73	AVG	
7		2.0963	20.07	9.74	29.81	56.00	-26.19	QP	
8		2.0963	10.25	9.74	19.99	46.00	-26.01	AVG	
9		3.5498	17.43	9.78	27.21	56.00	-28.79	QP	
10		3.5498	9.88	9.78	19.66	46.00	-26.34	AVG	
11		11.5935	20.34	9.93	30.27	60.00	-29.73	QP	
12		11.5935	13.79	9.93	23.72	50.00	-26.28	AVG	

REMARKS:
 (1) Measurement Value = Reading Level + Correct Factor.
 (2) Margin Level = Measurement Value - Limit Value.

Test Mode	Normal	Tested Date	2021/3/23
Test Frequency	-	Phase	Neutral

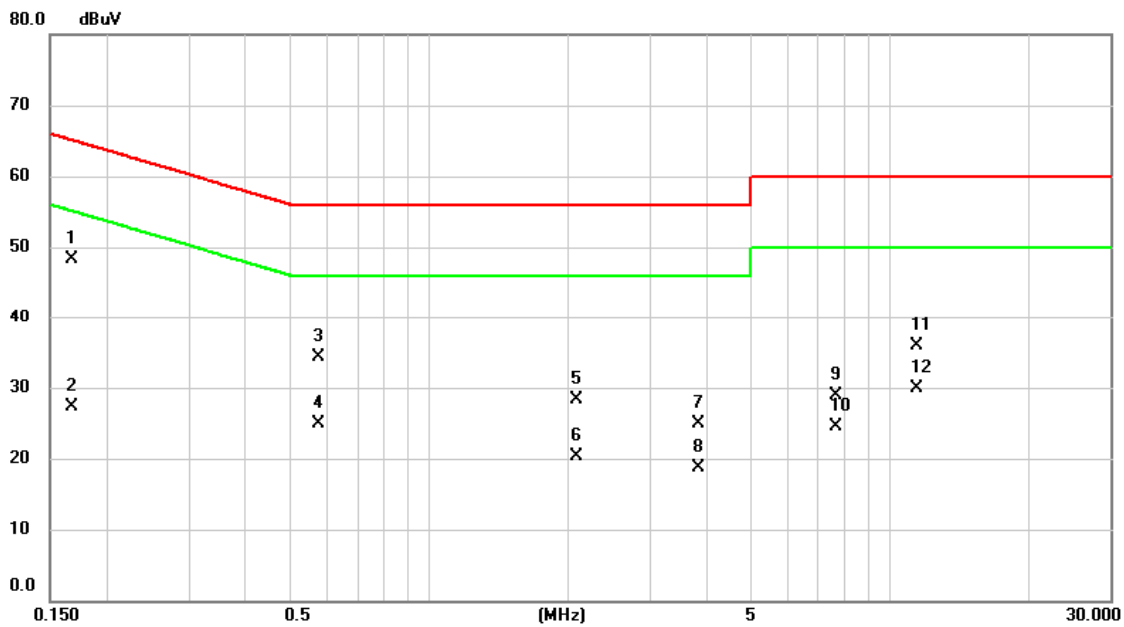

No.	Mk.	Freq.	Reading Level	Correct Factor	Measurement	Limit	Over	Detector	Comment
		MHz	dBuV	dB	dBuV	dBuV	dB		
1	*	0.1668	38.72	9.68	48.40	65.12	-16.72	QP	
2		0.1668	17.60	9.68	27.28	55.12	-27.84	AVG	
3		0.5752	24.68	9.68	34.36	56.00	-21.64	QP	
4		0.5752	15.30	9.68	24.98	46.00	-21.02	AVG	
5		2.0805	18.64	9.74	28.38	56.00	-27.62	QP	
6		2.0805	10.53	9.74	20.27	46.00	-25.73	AVG	
7		3.8288	15.11	9.79	24.90	56.00	-31.10	QP	
8		3.8288	8.95	9.79	18.74	46.00	-27.26	AVG	
9		7.6718	18.96	9.88	28.84	60.00	-31.16	QP	
10		7.6718	14.57	9.88	24.45	50.00	-25.55	AVG	
11		11.4720	25.95	9.93	35.88	60.00	-24.12	QP	
12		11.4720	19.96	9.93	29.89	50.00	-20.11	AVG	

REMARKS:

- (1) Measurement Value = Reading Level + Correct Factor.
- (2) Margin Level = Measurement Value - Limit Value.

Test Mode	Idle	Tested Date	2021/3/23
Test Frequency	-	Phase	Line

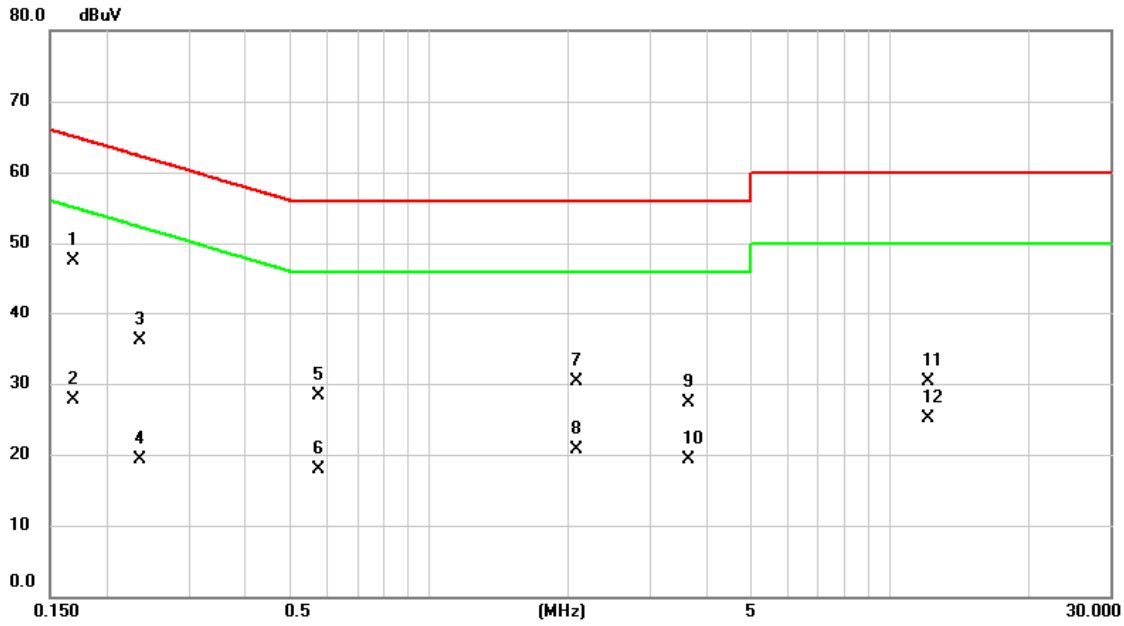

No.	Mk.	Freq.	Reading Level	Correct Factor	Measurement	Limit	Over		
		MHz	dBuV	dB	dBuV	dBuV	dB	Detector	Comment
1	*	0.1680	37.78	9.68	47.46	65.06	-17.60	QP	
2		0.1680	18.12	9.68	27.80	55.06	-27.26	AVG	
3		0.2355	26.49	9.68	36.17	62.25	-26.08	QP	
4		0.2355	9.67	9.68	19.35	52.25	-32.90	AVG	
5		0.5775	18.65	9.68	28.33	56.00	-27.67	QP	
6		0.5775	8.16	9.68	17.84	46.00	-28.16	AVG	
7		2.0873	20.57	9.74	30.31	56.00	-25.69	QP	
8		2.0873	10.94	9.74	20.68	46.00	-25.32	AVG	
9		3.6420	17.45	9.79	27.24	56.00	-28.76	QP	
10		3.6420	9.50	9.79	19.29	46.00	-26.71	AVG	
11		12.1403	20.32	9.93	30.25	60.00	-29.75	QP	
12		12.1403	15.14	9.93	25.07	50.00	-24.93	AVG	

REMARKS:
 (1) Measurement Value = Reading Level + Correct Factor.
 (2) Margin Level = Measurement Value - Limit Value.

Test Mode	Idle	Tested Date	2021/3/23
Test Frequency	-	Phase	Neutral

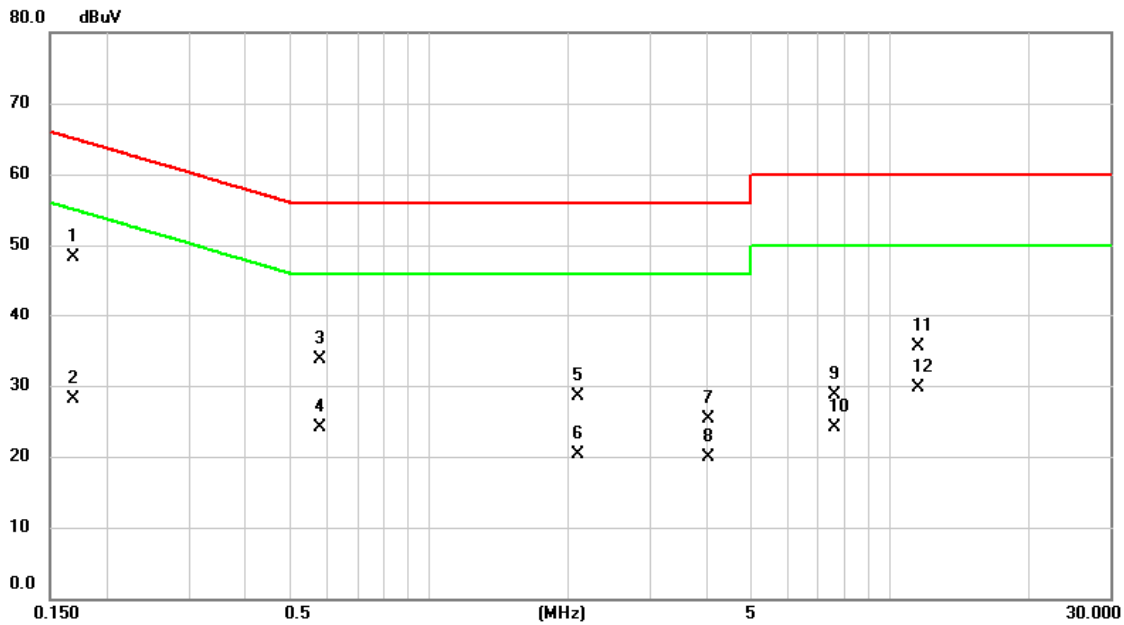

No.	Mk.	Freq.	Reading Level	Correct Factor	Measurement	Limit	Over		
		MHz	dBuV	dB	dBuV	dBuV	dB	Detector	Comment
1	*	0.1685	38.68	9.68	48.36	65.03	-16.67	QP	
2		0.1685	18.51	9.68	28.19	55.03	-26.84	AVG	
3		0.5797	24.08	9.68	33.76	56.00	-22.24	QP	
4		0.5797	14.48	9.68	24.16	46.00	-21.84	AVG	
5		2.1008	18.72	9.74	28.46	56.00	-27.54	QP	
6		2.1008	10.50	9.74	20.24	46.00	-25.76	AVG	
7		4.0313	15.45	9.80	25.25	56.00	-30.75	QP	
8		4.0313	10.04	9.80	19.84	46.00	-26.16	AVG	
9		7.6155	18.77	9.88	28.65	60.00	-31.35	QP	
10		7.6155	14.26	9.88	24.14	50.00	-25.86	AVG	
11		11.5260	25.62	9.93	35.55	60.00	-24.45	QP	
12		11.5260	19.82	9.93	29.75	50.00	-20.25	AVG	

REMARKS:

- (1) Measurement Value = Reading Level + Correct Factor.
- (2) Margin Level = Measurement Value - Limit Value.

APPENDIX B RADIATED SPURIOUS EMISSIONS

Test Mode	WCDMA Band IV	Test Date	2021/3/25
Test Channel	CH1652	Polarization	Vertical
Temp	21°C	Hum.	68%

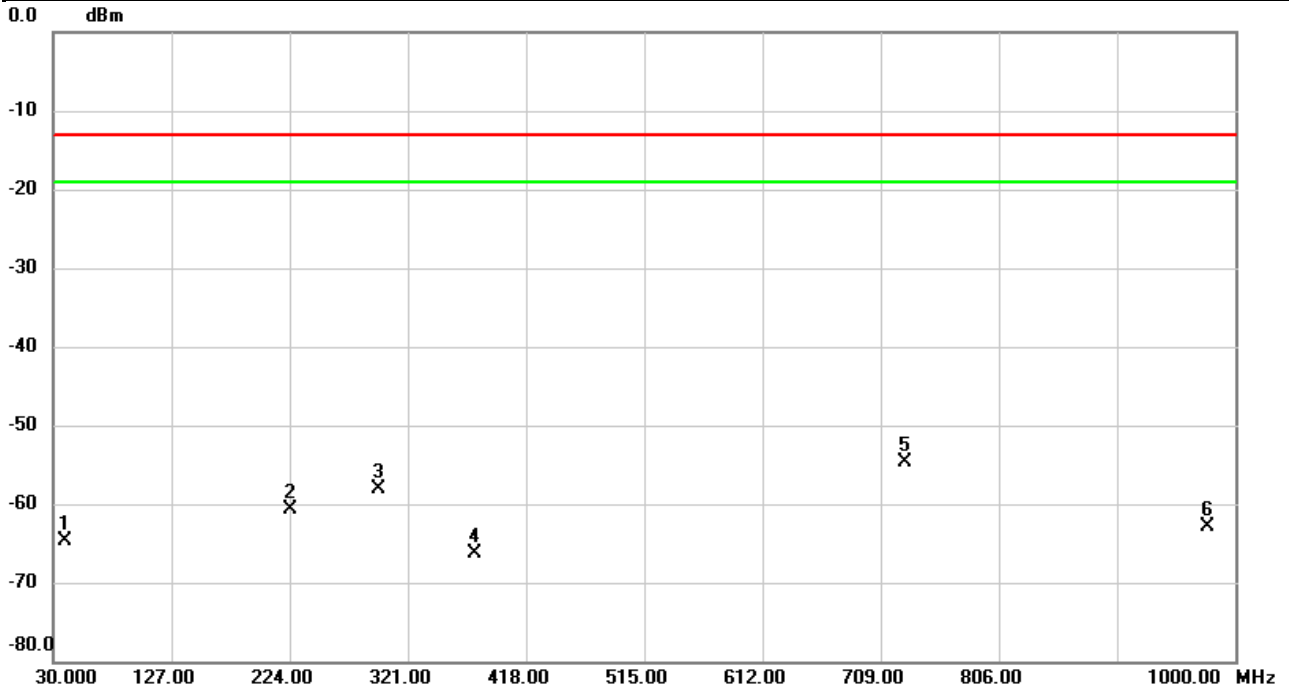

No.	Mk.	Freq. MHz	Reading Level dBm	Correct Factor dB	Measure- ment dBm	Limit dBm	Over dB	Detector	Comment
1		39.7000	-63.35	-1.35	-64.70	-13.00	-51.70	peak	
2		224.0000	-64.24	3.57	-60.67	-13.00	-47.67	peak	
3		296.7500	-65.79	7.62	-58.17	-13.00	-45.17	peak	
4		375.3200	-70.70	4.50	-66.20	-13.00	-53.20	peak	
5	*	729.3700	-66.67	12.01	-54.66	-13.00	-41.66	peak	
6		976.7200	-76.65	13.84	-62.81	-13.00	-49.81	peak	

REMARKS:

- (1) Measurement Value = Reading Level + Correct Factor.
- (2) Margin Level = Measurement Value - Limit Value.

Test Mode	WCDMA Band IV	Test Date	2021/3/25
Test Channel	CH1652	Polarization	Horizontal
Temp	21°C	Hum.	68%

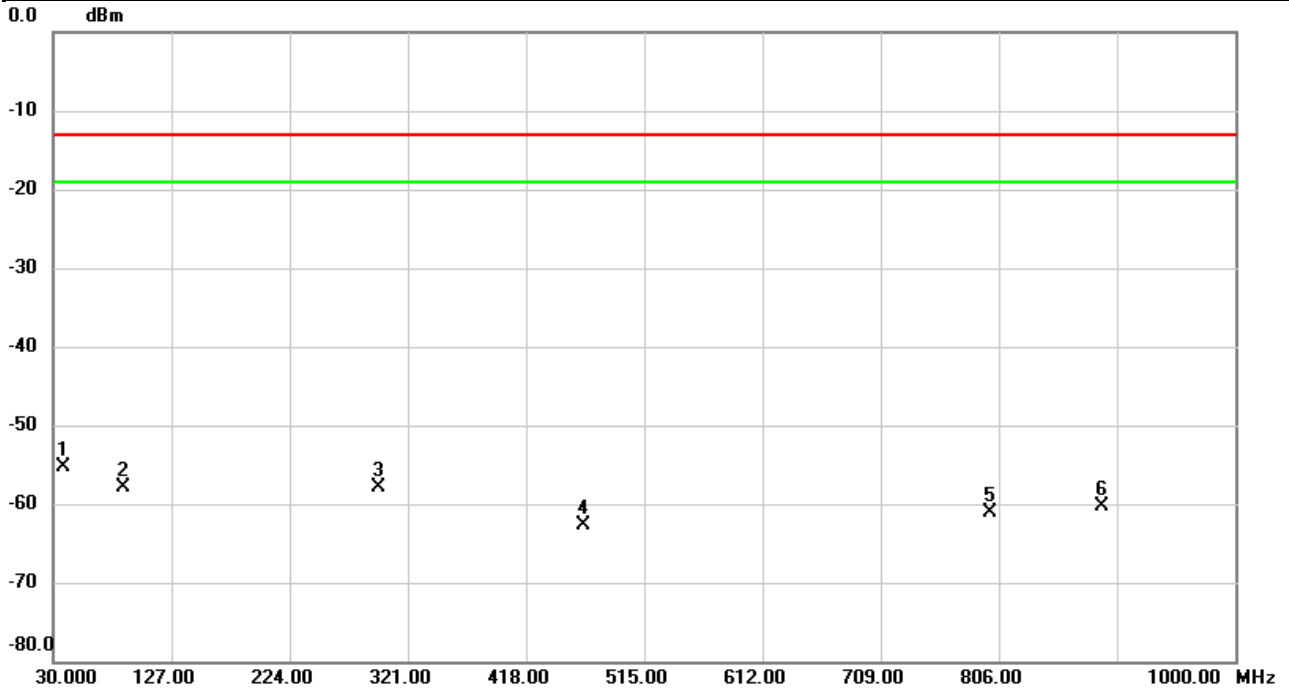

No.	Mk.	Freq. MHz	Reading Level dBm	Correct Factor dB	Measure- ment dBm	Limit dBm	Over dB	Detector	Comment
1	*	37.7600	-71.40	16.09	-55.31	-13.00	-42.31	peak	
2		87.2300	-62.10	4.24	-57.86	-13.00	-44.86	peak	
3		296.7500	-58.59	0.76	-57.83	-13.00	-44.83	peak	
4		465.5300	-75.01	12.32	-62.69	-13.00	-49.69	peak	
5		798.2400	-76.23	15.10	-61.13	-13.00	-48.13	peak	
6		890.3900	-76.24	15.85	-60.39	-13.00	-47.39	peak	

REMARKS:

- (1) Measurement Value = Reading Level + Correct Factor.
- (2) Margin Level = Measurement Value - Limit Value.

Test Mode	WCDMA Band IV	Test Date	2021/3/23
Test Channel	CH1537	Polarization	Vertical
Temp	21°C	Hum.	68%

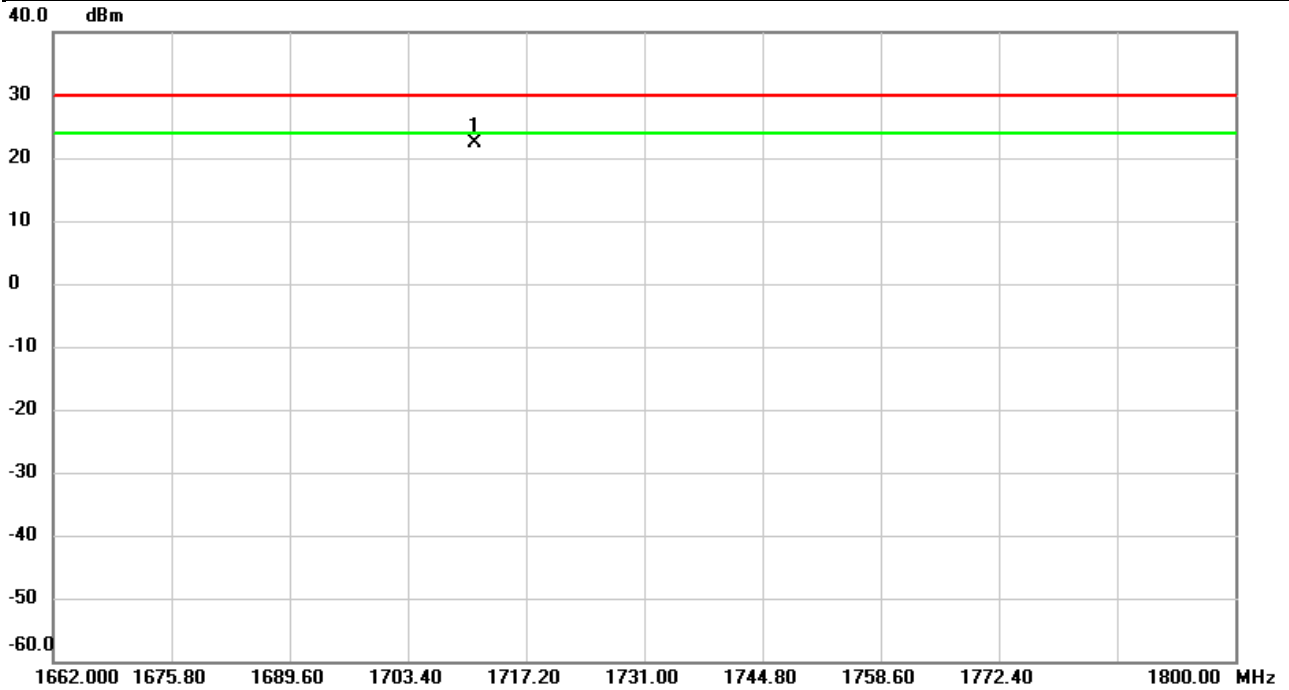

No.	Mk.	Freq.	Reading Level	Correct Factor	Measurement	Limit	Over	Detector	Comment
		MHz	dBm	dB	dBm	dBm	dB		
1	*	1711.197	-17.13	39.47	22.34	30.00	-7.66	peak	

REMARKS:

- (1) Measurement Value = Reading Level + Correct Factor.
- (2) Margin Level = Measurement Value - Limit Value.

Test Mode	WCDMA Band IV	Test Date	2021/3/23
Test Channel	CH1537	Polarization	Horizontal
Temp	21°C	Hum.	68%

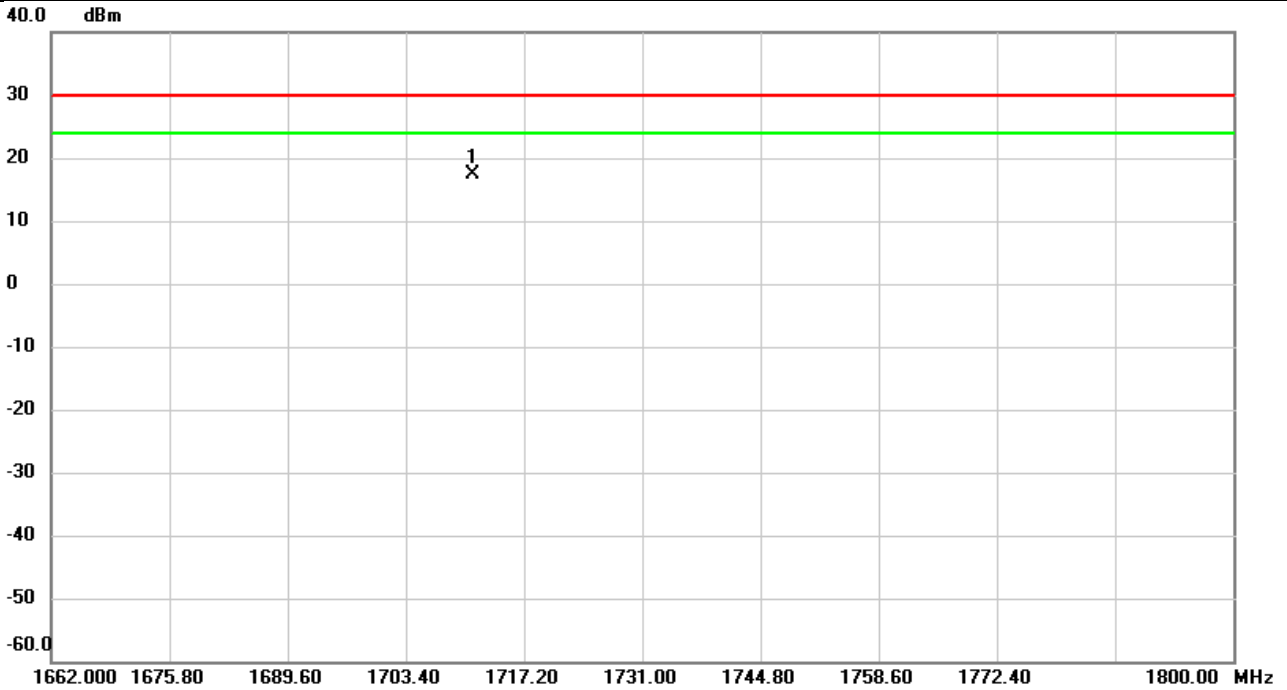

No.	Mk.	Freq.	Reading Level	Correct Factor	Measurement	Limit	Over	Detector	Comment
		MHz	dBm	dB	dBm	dBm	dB		
1	*	1711.211	-22.85	40.11	17.26	30.00	-12.74	peak	

REMARKS:

- (1) Measurement Value = Reading Level + Correct Factor.
- (2) Margin Level = Measurement Value - Limit Value.

Test Mode	WCDMA Band IV	Test Date	2021/3/23
Test Channel	CH1652	Polarization	Vertical
Temp	21°C	Hum.	68%

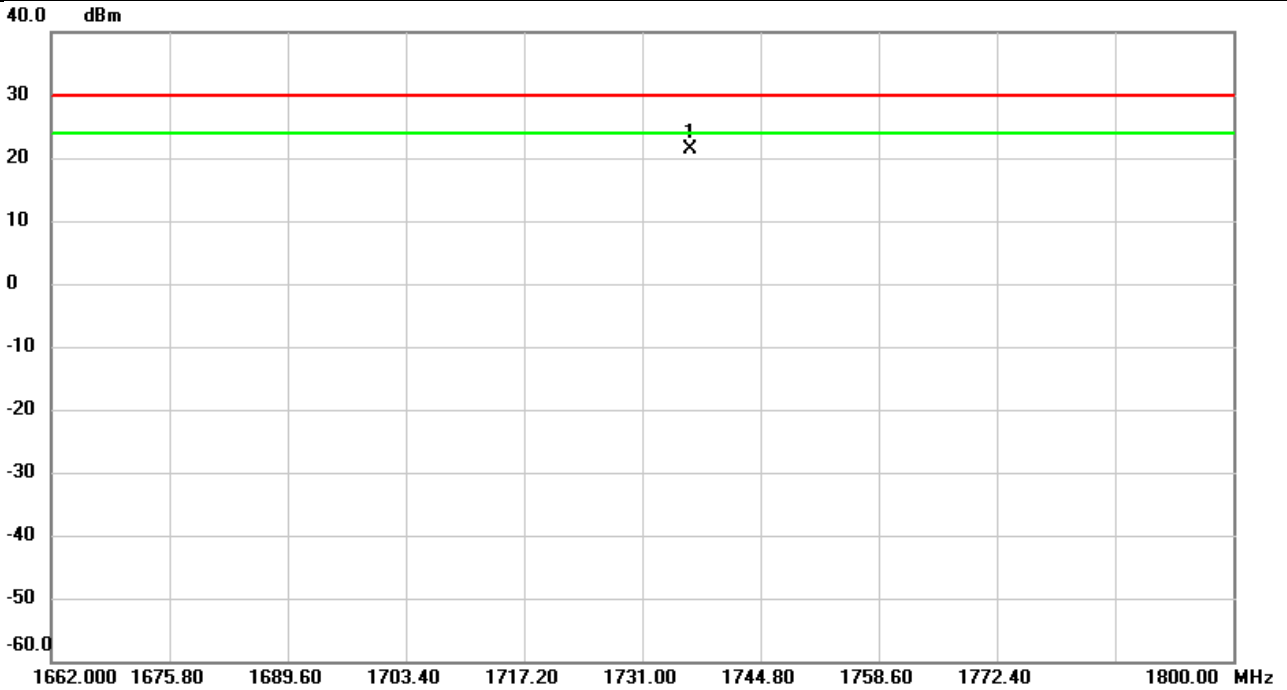

No.	Mk.	Freq.	Reading Level	Correct Factor	Measurement	Limit	Over	Detector	Comment
		MHz	dBm	dB	dBm	dBm	dB		
1	*	1736.672	-18.25	39.58	21.33	30.00	-8.67	peak	

REMARKS:

- (1) Measurement Value = Reading Level + Correct Factor.
- (2) Margin Level = Measurement Value - Limit Value.

Test Mode	WCDMA Band IV	Test Date	2021/3/23
Test Channel	CH1652	Polarization	Horizontal
Temp	21°C	Hum.	68%

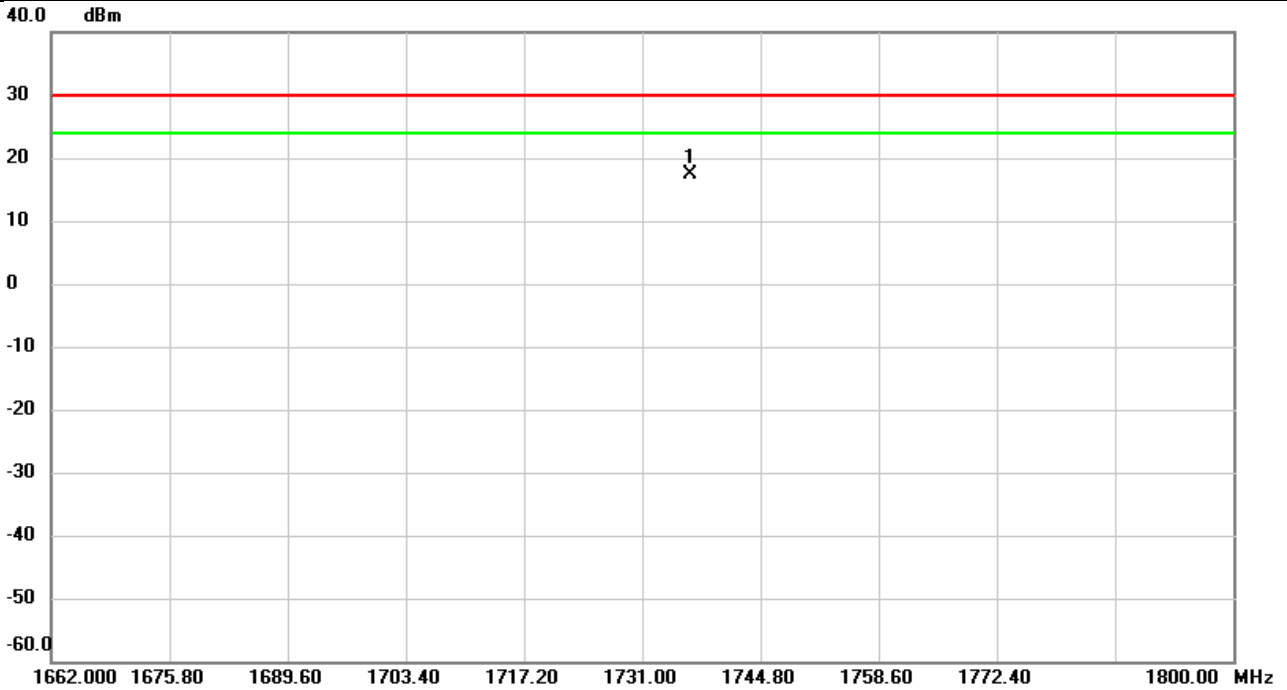

No.	Mk.	Freq.	Reading Level	Correct Factor	Measurement	Limit	Over	Detector	Comment
		MHz	dBm	dB	dBm	dBm	dB		
1	*	1736.543	-22.75	40.20	17.45	30.00	-12.55	peak	

REMARKS:

- (1) Measurement Value = Reading Level + Correct Factor.
- (2) Margin Level = Measurement Value - Limit Value.

Test Mode	WCDMA Band IV	Test Date	2021/3/23
Test Channel	CH1738	Polarization	Vertical
Temp	21°C	Hum.	68%

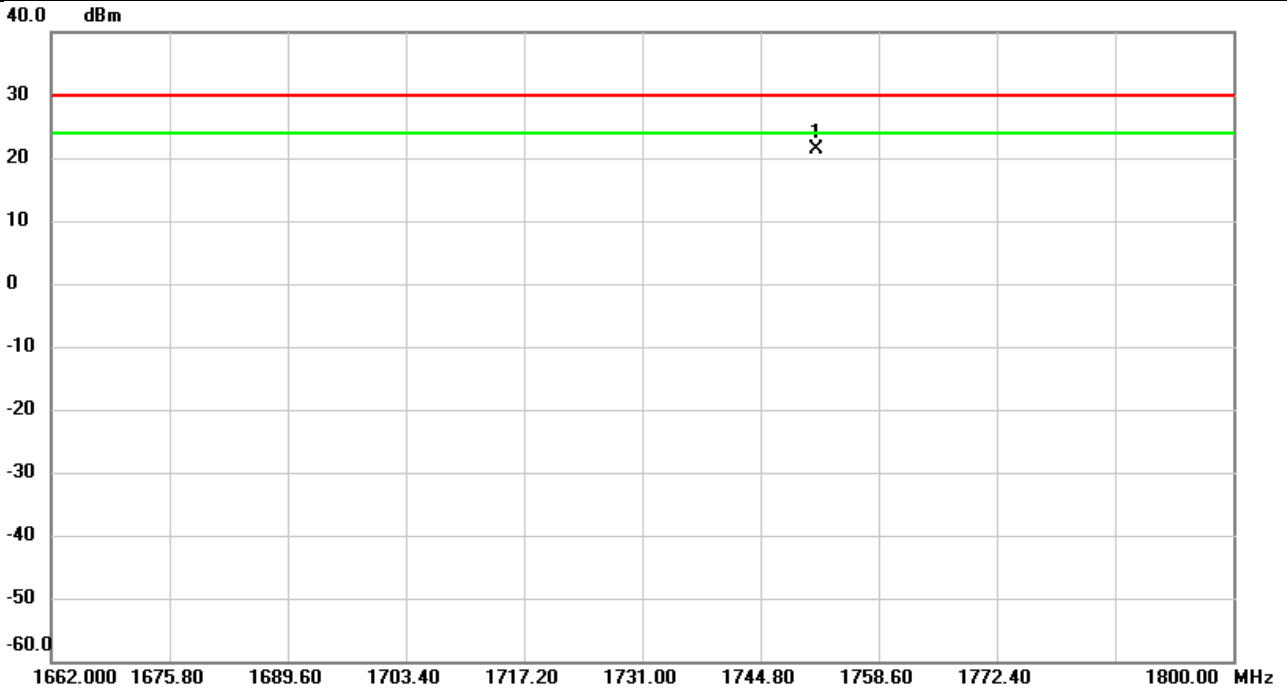

No.	Mk.	Freq.	Reading Level	Correct Factor	Measurement	Limit	Over	Detector	Comment
		MHz	dBm	dB	dBm	dBm	dB		
1	*	1751.396	-18.16	39.65	21.49	30.00	-8.51	peak	

REMARKS:

- (1) Measurement Value = Reading Level + Correct Factor.
- (2) Margin Level = Measurement Value - Limit Value.

Test Mode	WCDMA Band IV	Test Date	2021/3/23
Test Channel	CH1738	Polarization	Horizontal
Temp	21°C	Hum.	68%

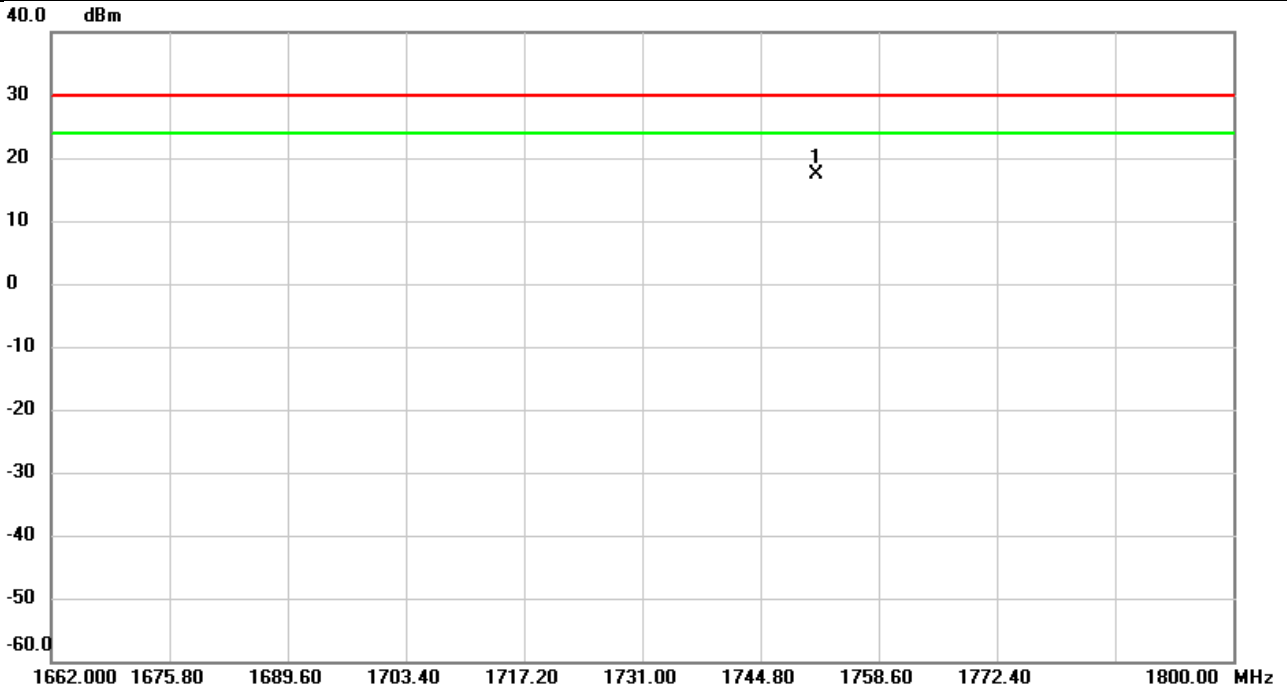

No.	Mk.	Freq.	Reading Level	Correct Factor	Measurement	Limit	Over	Detector	Comment
		MHz	dBm	dB	dBm	dBm	dB		
1	*	1751.341	-22.86	40.25	17.39	30.00	-12.61	peak	

REMARKS:

- (1) Measurement Value = Reading Level + Correct Factor.
- (2) Margin Level = Measurement Value - Limit Value.

Test Mode	WCDMA Band IV	Test Date	2021/3/23
Test Channel	CH1652	Polarization	Vertical
Temp	21°C	Hum.	68%

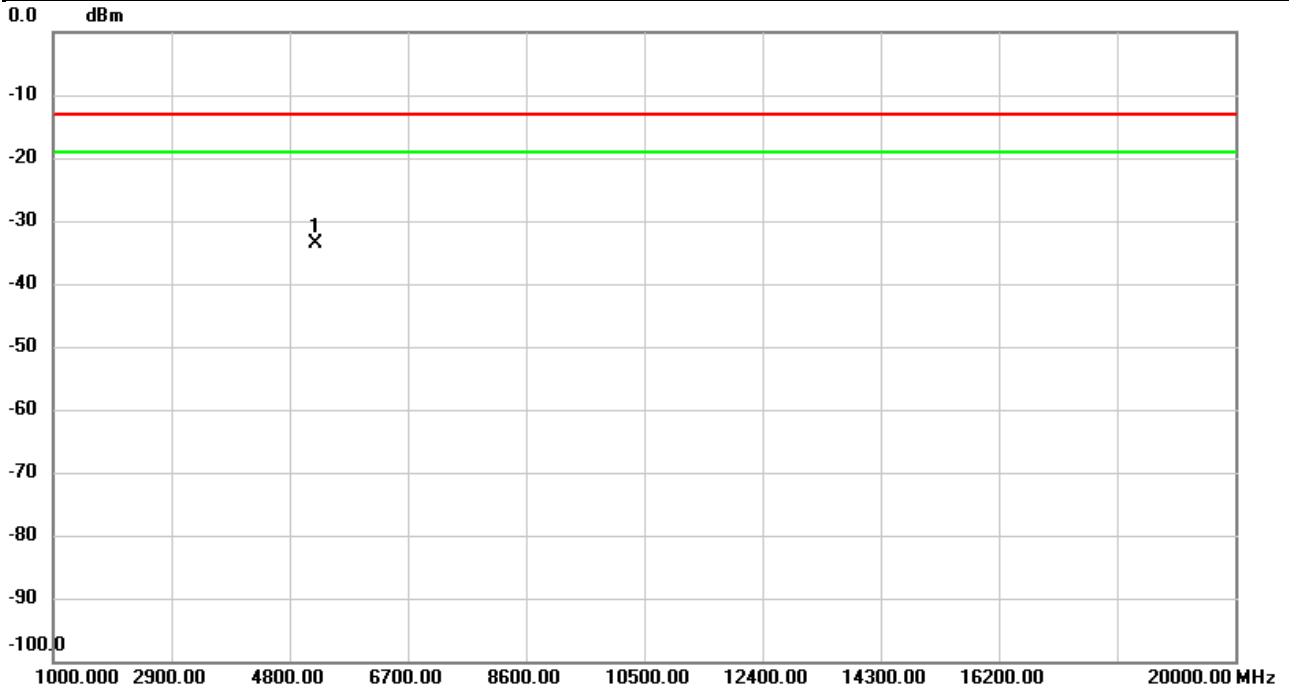

No.	Mk.	Freq.	Reading Level	Correct Factor	Measurement	Limit	Over	Detector	Comment
		MHz	dBm	dB	dBm	dBm	dB		
1	*	5209.767	-35.01	1.45	-33.56	-13.00	-20.56	peak	

REMARKS:

- (1) Measurement Value = Reading Level + Correct Factor.
- (2) Margin Level = Measurement Value - Limit Value.

Test Mode	WCDMA Band IV	Test Date	2021/3/23
Test Channel	CH1652	Polarization	Horizontal
Temp	21°C	Hum.	68%

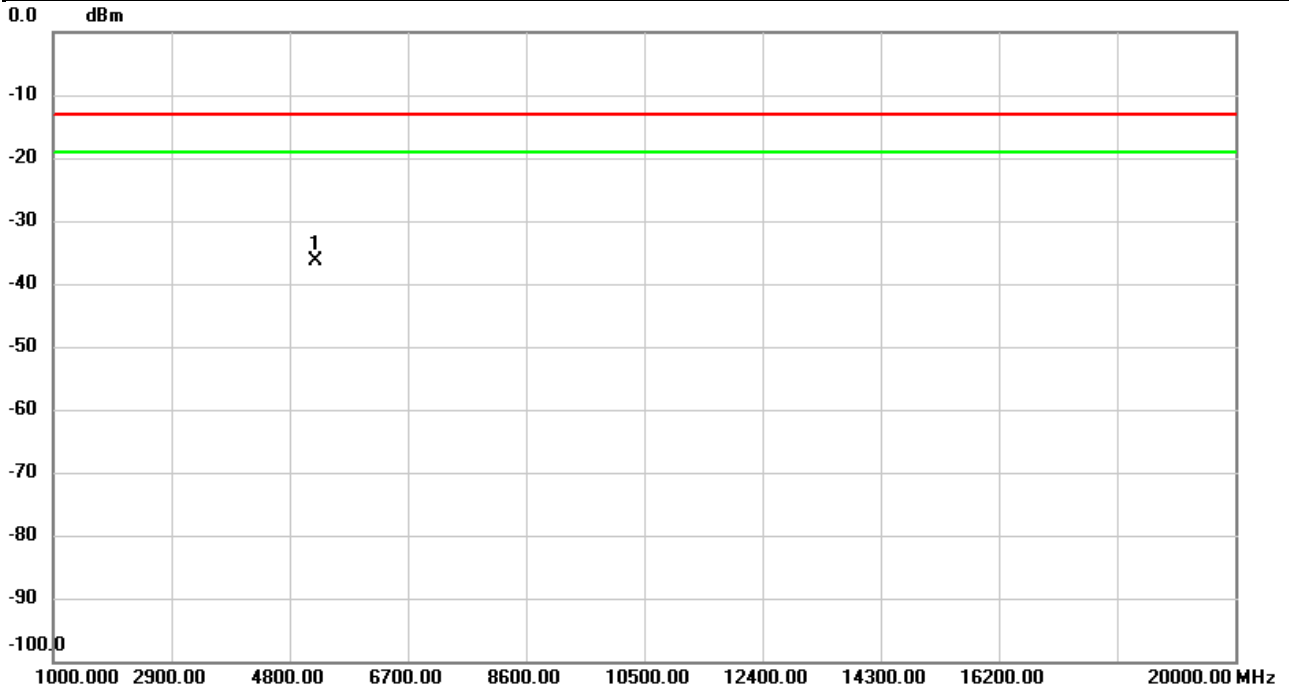

No.	Mk.	Freq.	Reading Level	Correct Factor	Measurement	Limit	Over	Detector	Comment
		MHz	dBm	dB	dBm	dBm	dB		
1	*	5210.400	-38.80	2.38	-36.42	-13.00	-23.42	peak	

REMARKS:

- (1) Measurement Value = Reading Level + Correct Factor.
- (2) Margin Level = Measurement Value - Limit Value.

Test Mode	LTE Band 4	Test Date	2021/3/25
Test Channel	CH20175	Polarization	Vertical
Temp	21°C	Hum.	68%

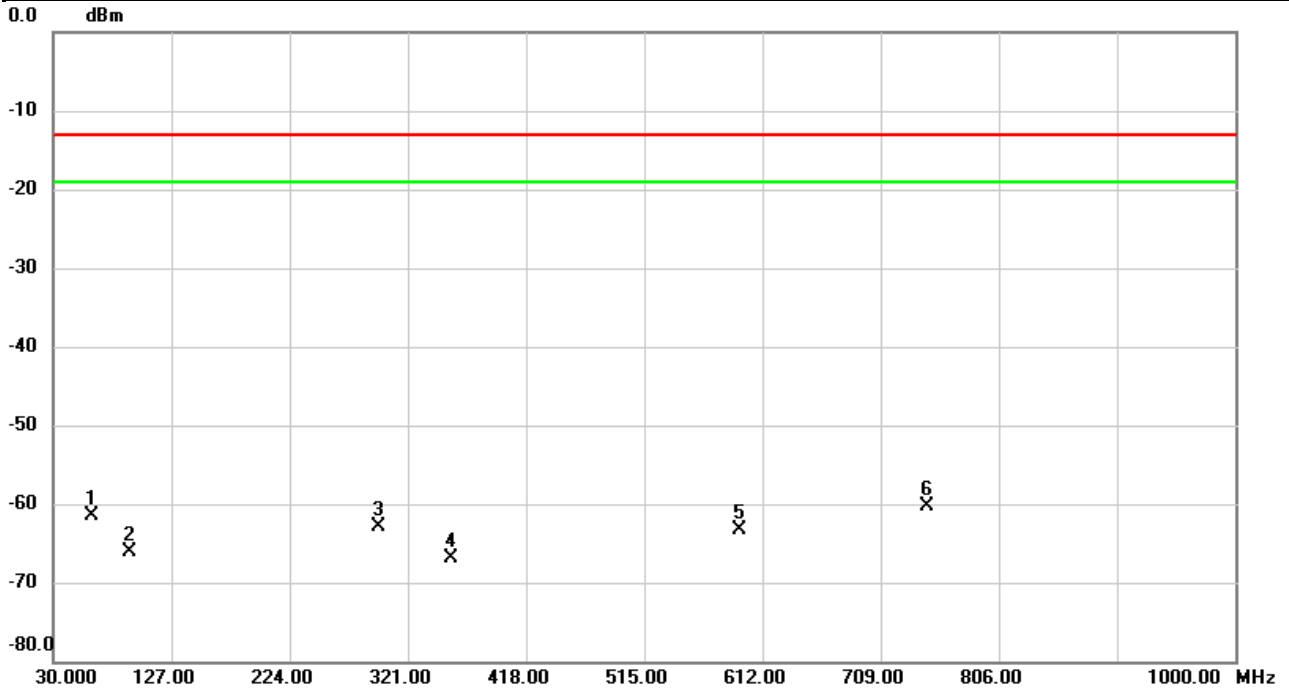

No.	Mk.	Freq. MHz	Reading Level dBm	Correct Factor dB	Measure- ment dBm	Limit dBm	Over dB	Detector	Comment
1		61.0400	-59.98	-1.44	-61.42	-13.00	-48.42	peak	
2		93.0500	-65.17	-0.85	-66.02	-13.00	-53.02	peak	
3		296.7500	-70.52	7.62	-62.90	-13.00	-49.90	peak	
4		355.9200	-72.95	6.14	-66.81	-13.00	-53.81	peak	
5		593.5700	-75.12	11.75	-63.37	-13.00	-50.37	peak	
6	*	746.8300	-71.97	11.63	-60.34	-13.00	-47.34	peak	

REMARKS:

- (1) Measurement Value = Reading Level + Correct Factor.
- (2) Margin Level = Measurement Value - Limit Value.

Test Mode	LTE Band 4	Test Date	2021/3/25
Test Channel	CH20175	Polarization	Horizontal
Temp	21°C	Hum.	68%

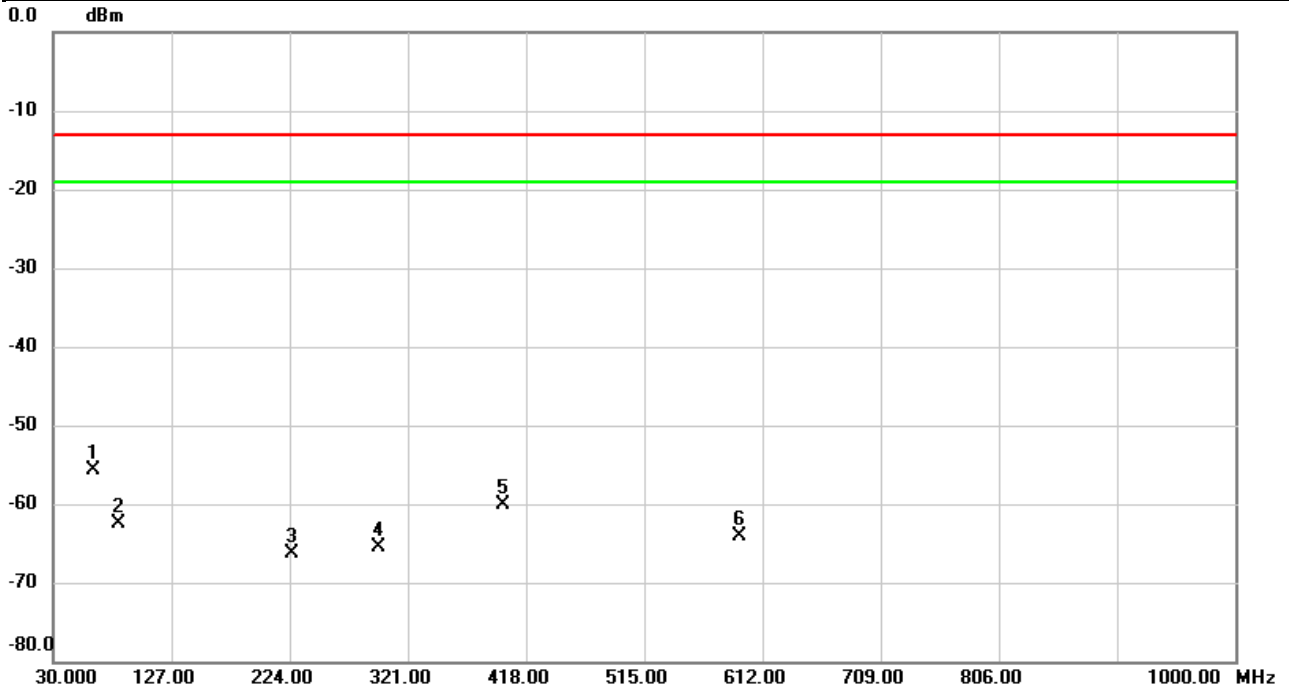

No.	Mk.	Freq. MHz	Reading Level dBm	Correct Factor dB	Measure- ment dBm	Limit dBm	Over dB	Detector	Comment
1	*	62.9800	-61.83	6.15	-55.68	-13.00	-42.68	peak	
2		83.3500	-67.46	5.05	-62.41	-13.00	-49.41	peak	
3		225.9400	-65.62	-0.76	-66.38	-13.00	-53.38	peak	
4		296.7500	-66.31	0.76	-65.55	-13.00	-52.55	peak	
5		399.5700	-66.27	6.16	-60.11	-13.00	-47.11	peak	
6		593.5700	-71.58	7.44	-64.14	-13.00	-51.14	peak	

REMARKS:

- (1) Measurement Value = Reading Level + Correct Factor.
- (2) Margin Level = Measurement Value - Limit Value.

Test Mode	LTE Band 4	Test Date	2021/3/24
Test Channel	CH20050	Polarization	Vertical
Temp	21°C	Hum.	68%

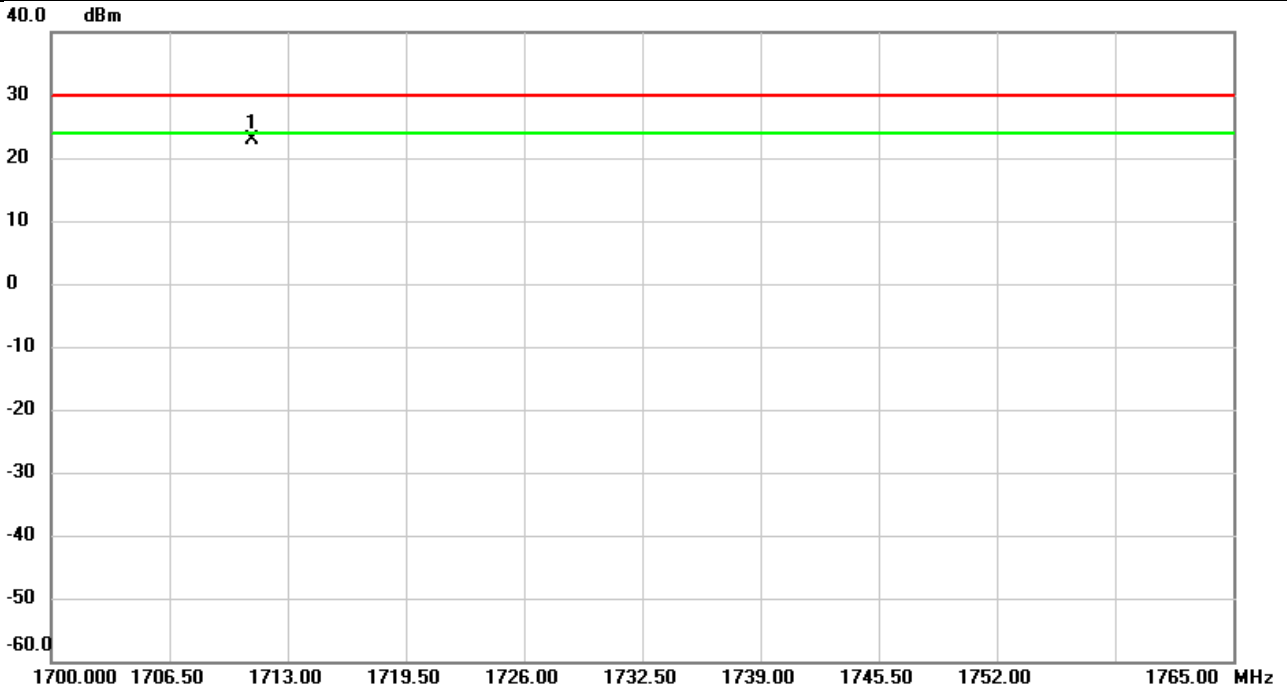

No.	Mk.	Freq.	Reading Level	Correct Factor	Measurement	Limit	Over	Detector	Comment
		MHz	dBm	dB	dBm	dBm	dB		
1	*	1711.085	-16.61	39.47	22.86	30.00	-7.14	peak	

REMARKS:

- (1) Measurement Value = Reading Level + Correct Factor.
- (2) Margin Level = Measurement Value - Limit Value.

Test Mode	LTE Band 4	Test Date	2021/3/24
Test Channel	CH20050	Polarization	Horizontal
Temp	21°C	Hum.	68%

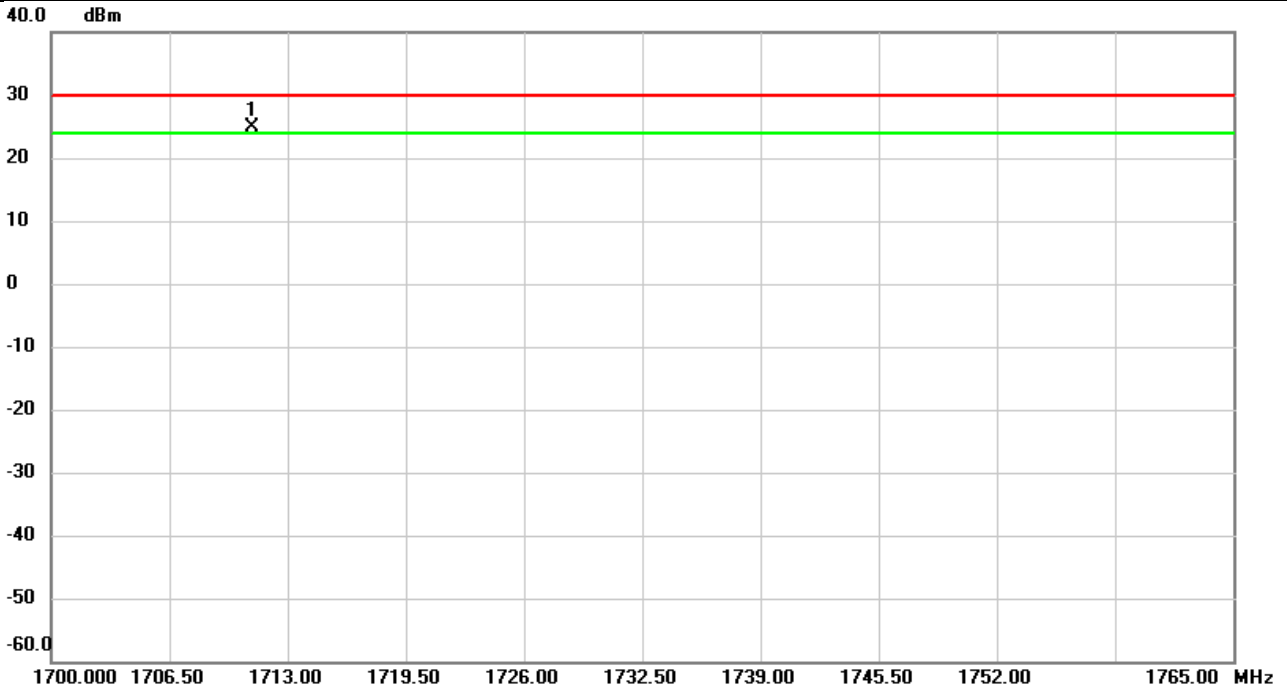

No.	Mk.	Freq.	Reading Level	Correct Factor	Measurement	Limit	Over	Detector	Comment
		MHz	dBm	dB	dBm	dBm	dB		
1	*	1711.063	-15.27	40.11	24.84	30.00	-5.16	peak	

REMARKS:

- (1) Measurement Value = Reading Level + Correct Factor.
- (2) Margin Level = Measurement Value - Limit Value.

Test Mode	LTE Band 4	Test Date	2021/3/24
Test Channel	CH20175	Polarization	Vertical
Temp	21°C	Hum.	68%

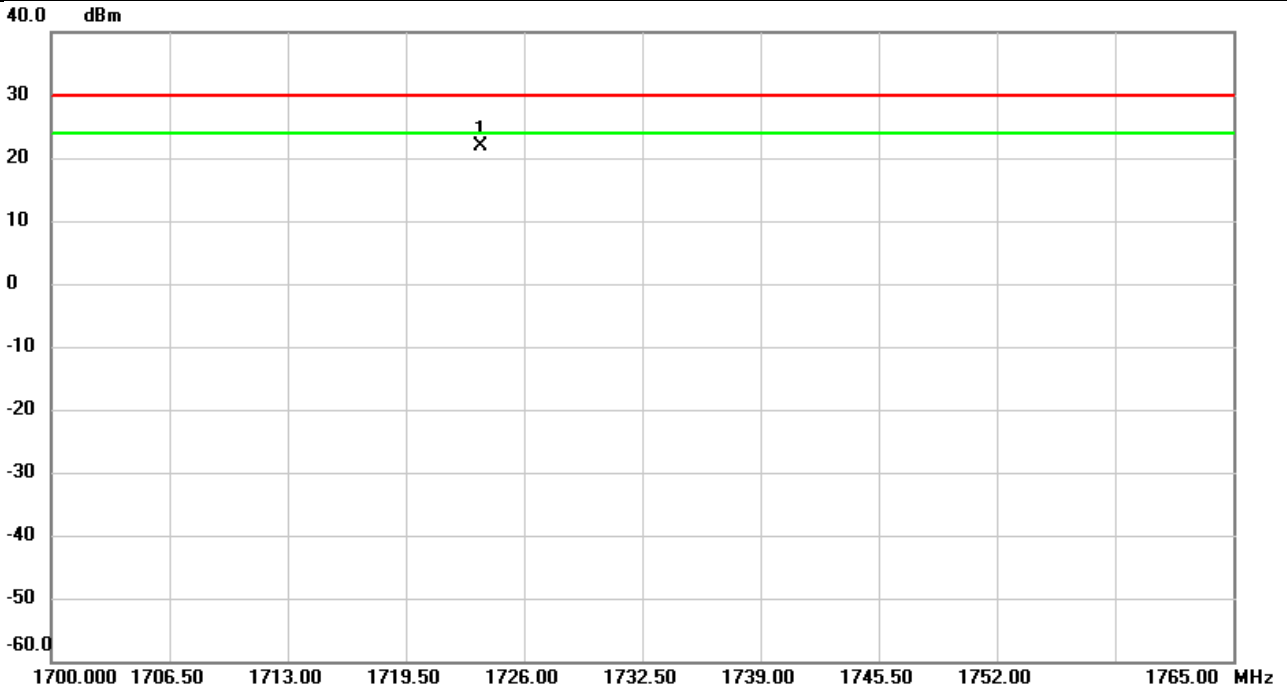

No.	Mk.	Freq.	Reading Level	Correct Factor	Measurement	Limit	Over	Detector	Comment
		MHz	dBm	dB	dBm	dBm	dB		
1	*	1723.584	-17.58	39.53	21.95	30.00	-8.05	peak	

REMARKS:

- (1) Measurement Value = Reading Level + Correct Factor.
- (2) Margin Level = Measurement Value - Limit Value.

Test Mode	LTE Band 4	Test Date	2021/3/24
Test Channel	CH20175	Polarization	Horizontal
Temp	21°C	Hum.	68%

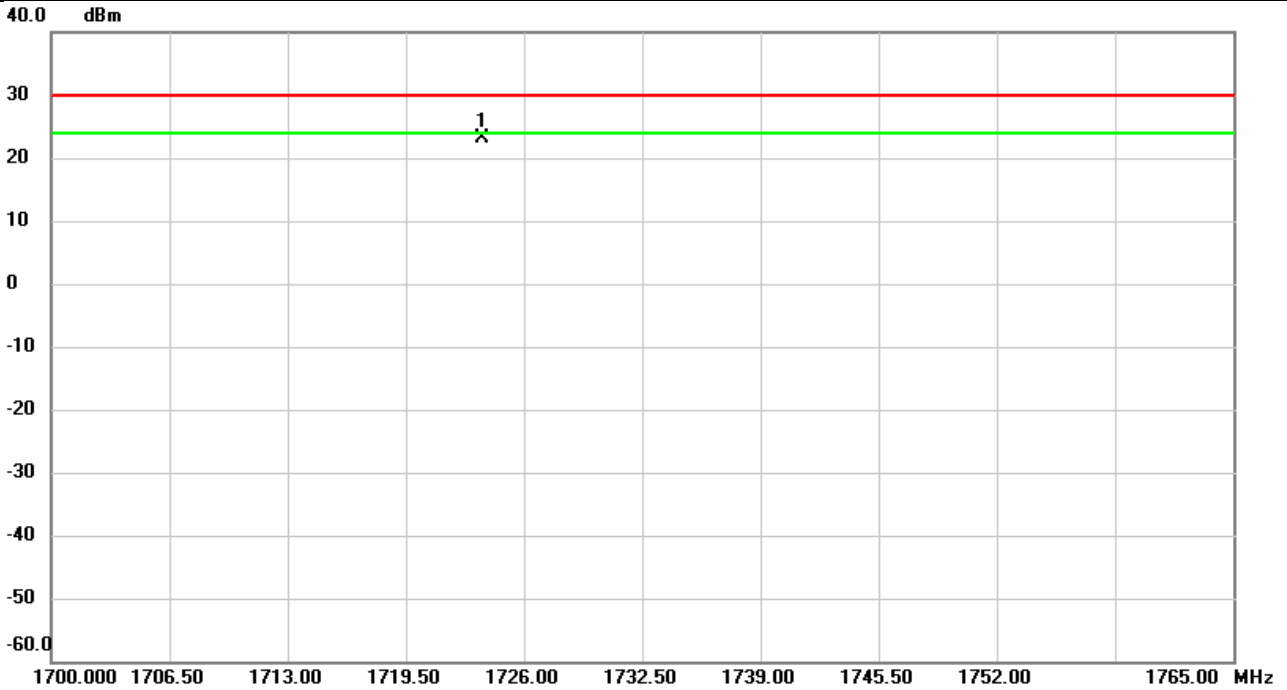

No.	Mk.	Freq.	Reading Level	Correct Factor	Measurement	Limit	Over	Detector	Comment
		MHz	dBm	dB	dBm	dBm	dB		
1	*	1723.669	-16.91	40.15	23.24	30.00	-6.76	peak	

REMARKS:

- (1) Measurement Value = Reading Level + Correct Factor.
- (2) Margin Level = Measurement Value - Limit Value.

Test Mode	LTE Band 4	Test Date	2021/3/24
Test Channel	CH20300	Polarization	Vertical
Temp	21°C	Hum.	68%

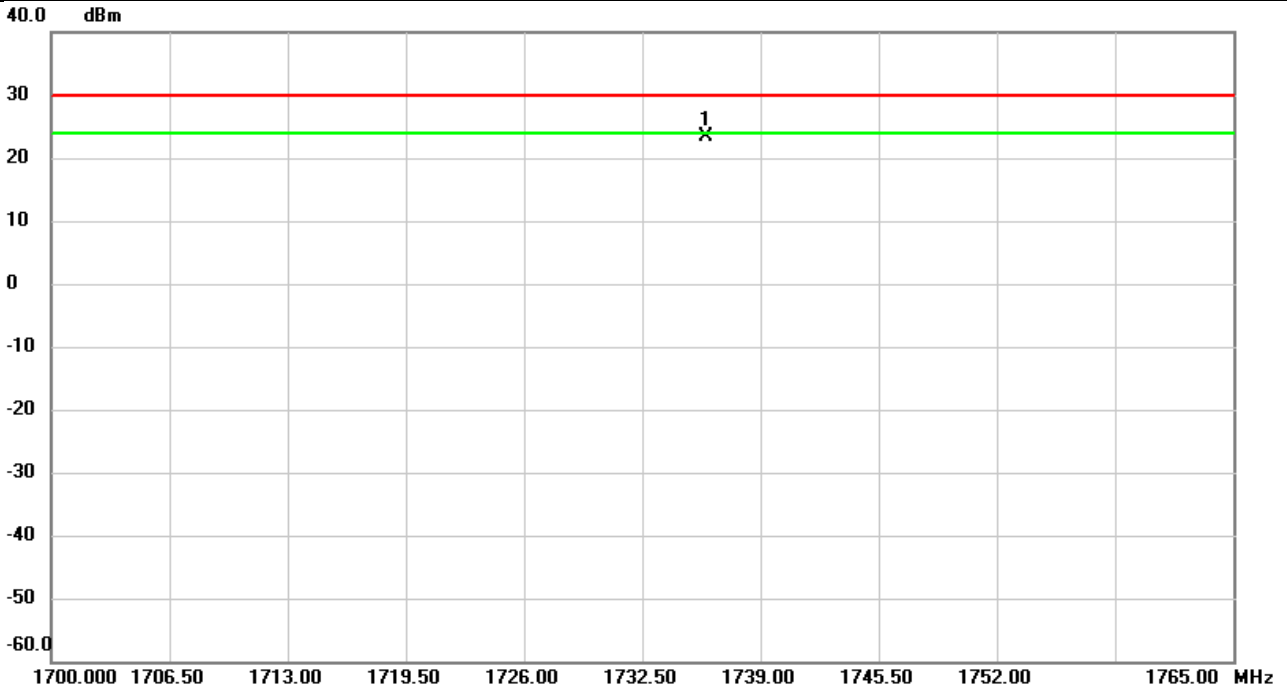

No.	Mk.	Freq.	Reading Level	Correct Factor	Measurement	Limit	Over	Detector	Comment
		MHz	dBm	dB	dBm	dBm	dB		
1	*	1736.019	-16.31	39.58	23.27	30.00	-6.73	peak	

REMARKS:

- (1) Measurement Value = Reading Level + Correct Factor.
- (2) Margin Level = Measurement Value - Limit Value.

Test Mode	LTE Band 4	Test Date	2021/3/24
Test Channel	CH20300	Polarization	Horizontal
Temp	21°C	Hum.	68%

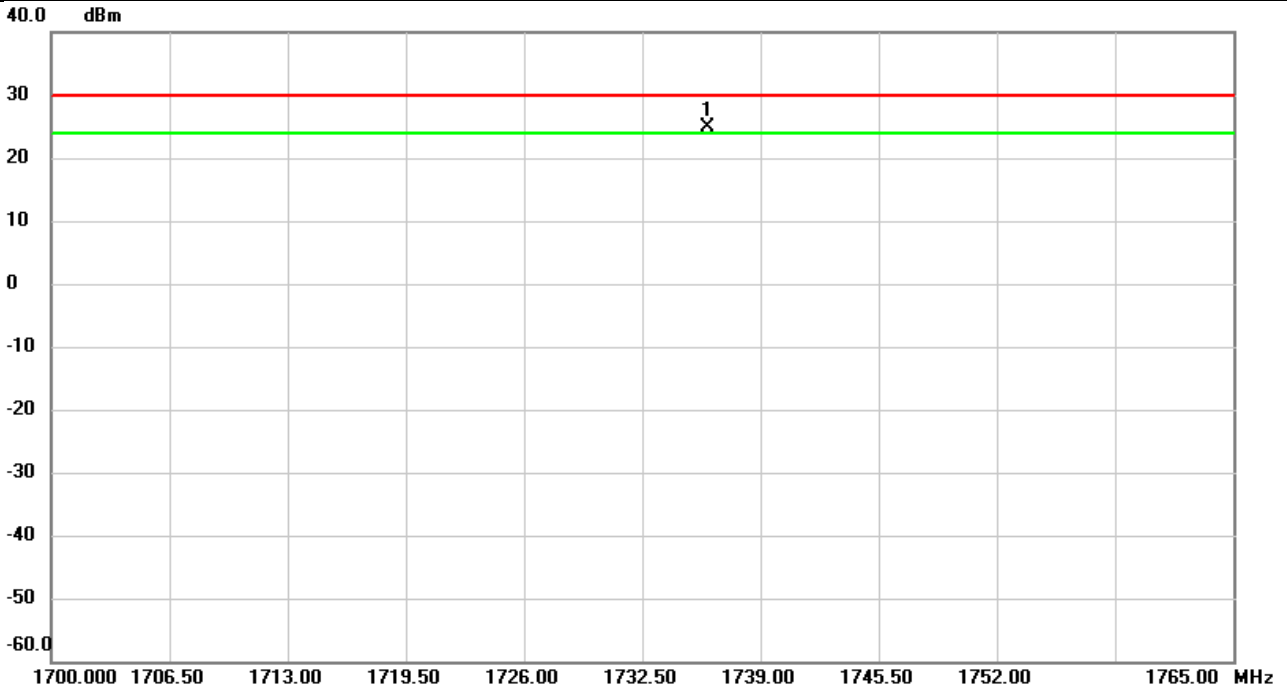

No.	Mk.	Freq.	Reading Level	Correct Factor	Measurement	Limit	Over	Detector	Comment
		MHz	dBm	dB	dBm	dBm	dB		
1	*	1736.131	-15.31	40.20	24.89	30.00	-5.11	peak	

REMARKS:

- (1) Measurement Value = Reading Level + Correct Factor.
- (2) Margin Level = Measurement Value - Limit Value.

Test Mode	LTE Band 4	Test Date	2021/3/24
Test Channel	CH20175	Polarization	Vertical
Temp	21°C	Hum.	68%

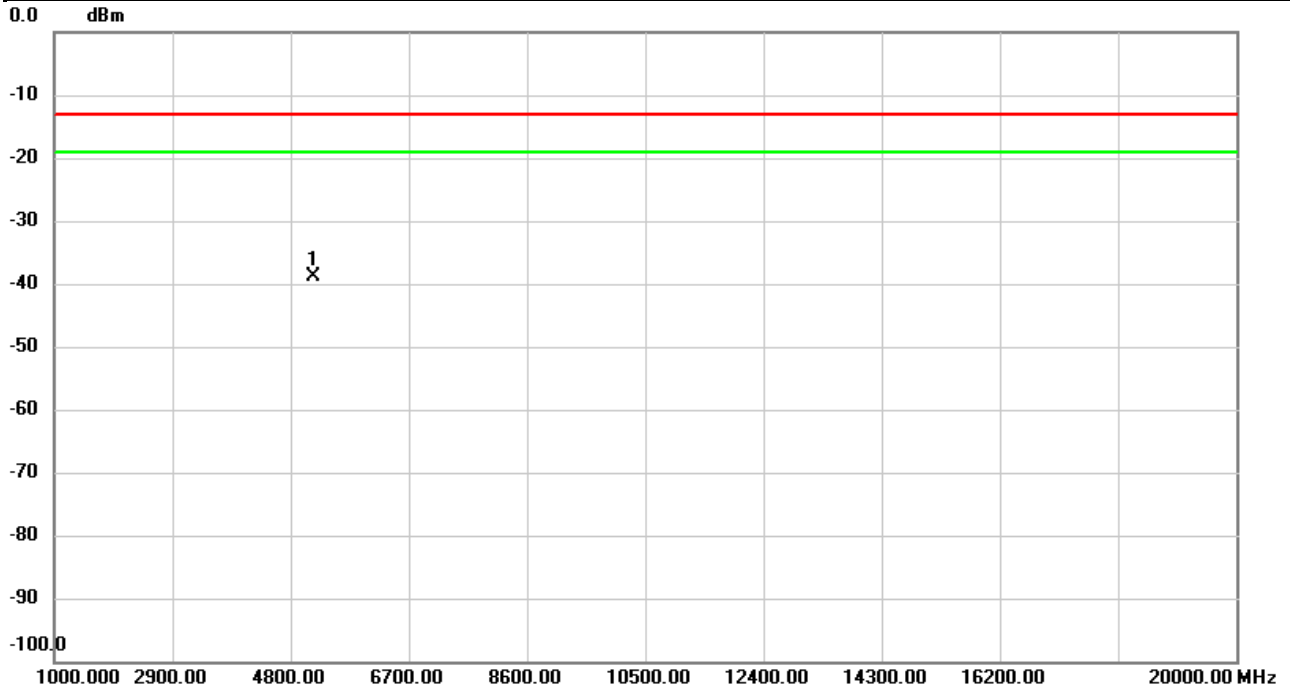

No.	Mk.	Freq.	Reading Level	Correct Factor	Measurement	Limit	Over	Detector	Comment
		MHz	dBm	dB	dBm	dBm	dB		
1	*	5171.133	-40.61	1.79	-38.82	-13.00	-25.82	peak	

REMARKS:

- (1) Measurement Value = Reading Level + Correct Factor.
- (2) Margin Level = Measurement Value - Limit Value.

Test Mode	LTE Band 4	Test Date	2021/3/24
Test Channel	CH20175	Polarization	Horizontal
Temp	21°C	Hum.	68%

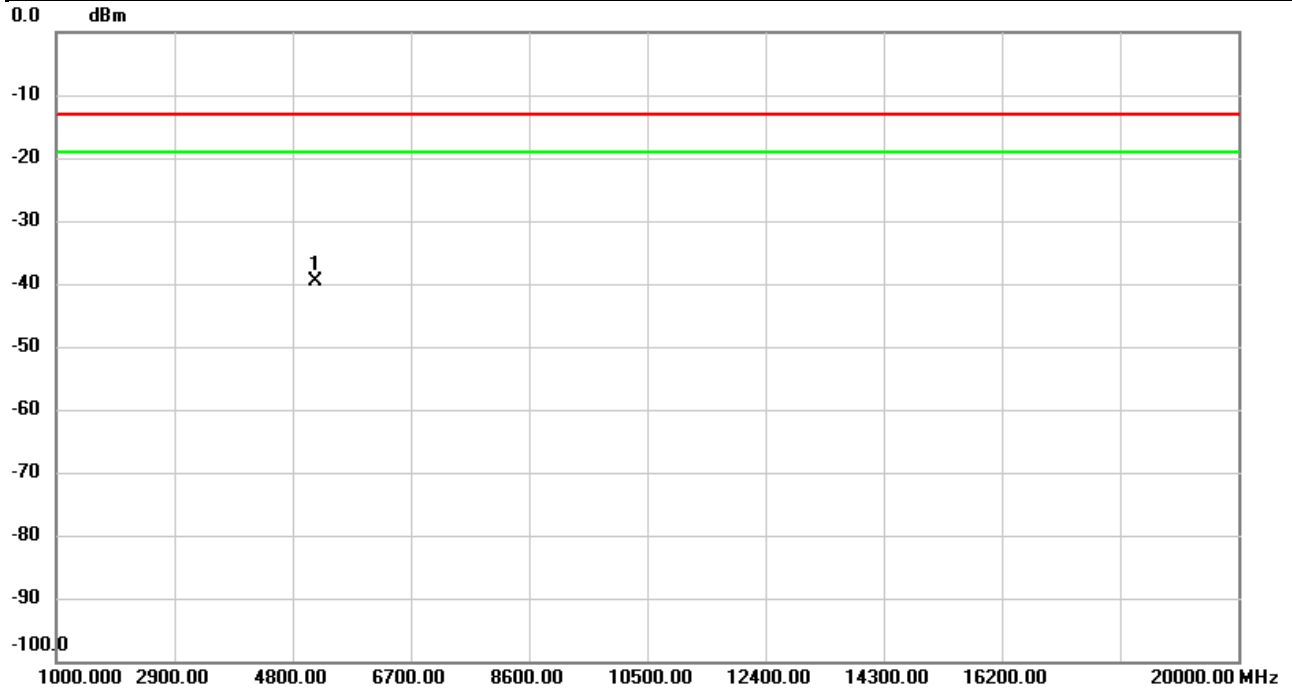

No.	Mk.	Freq.	Reading Level	Correct Factor	Measurement	Limit	Over	Detector	Comment
		MHz	dBm	dB	dBm	dBm	dB		
1	*	5171.133	-41.95	2.38	-39.57	-13.00	-26.57	peak	

REMARKS:

- (1) Measurement Value = Reading Level + Correct Factor.
- (2) Margin Level = Measurement Value - Limit Value.

Test Mode	LTE Band 7	Test Date	2021/3/25
Test Channel	CH21100	Polarization	Horizontal
Temp	21°C	Hum.	68%

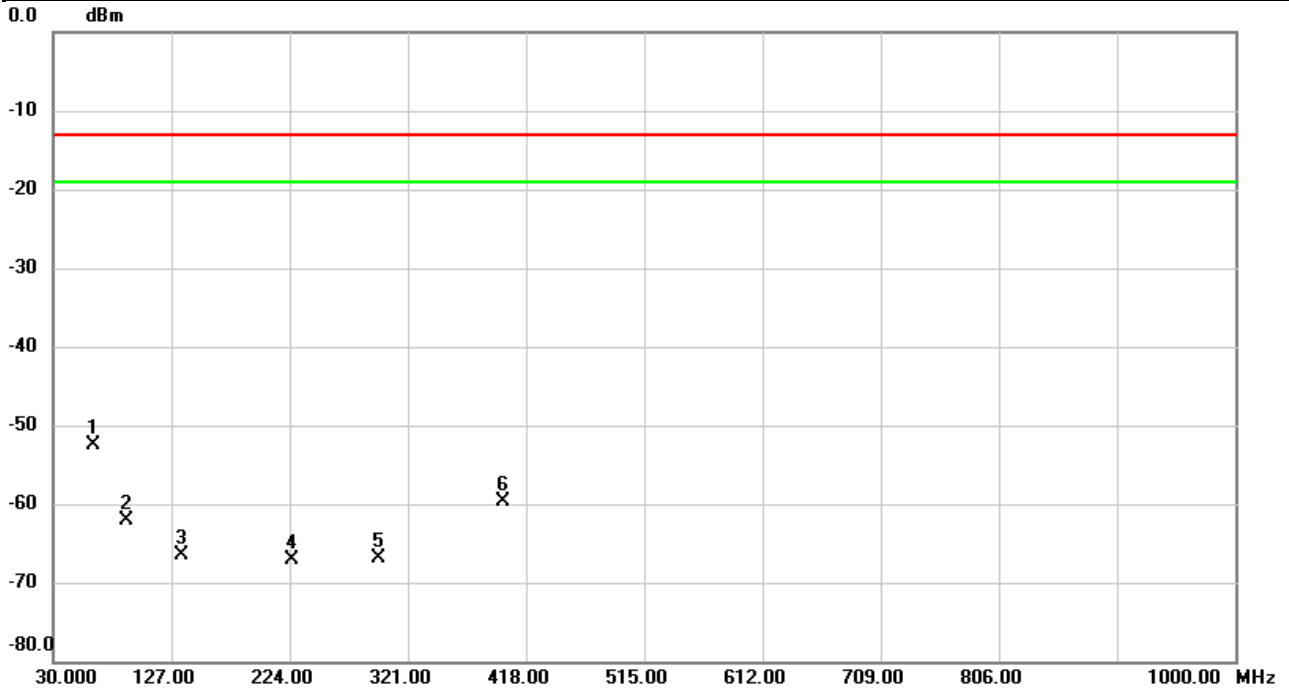

No.	Mk.	Freq. MHz	Reading Level dBm	Correct Factor dB	Measure- ment dBm	Limit dBm	Over dB	Detector	Comment
1	*	62.9800	-58.74	6.15	-52.59	-13.00	-39.59	peak	
2		90.1400	-65.80	3.66	-62.14	-13.00	-49.14	peak	
3		134.7600	-69.32	2.79	-66.53	-13.00	-53.53	peak	
4		225.9400	-66.39	-0.76	-67.15	-13.00	-54.15	peak	
5		296.7500	-67.71	0.76	-66.95	-13.00	-53.95	peak	
6		398.6000	-65.82	6.12	-59.70	-13.00	-46.70	peak	

REMARKS:

- (1) Measurement Value = Reading Level + Correct Factor.
- (2) Margin Level = Measurement Value - Limit Value.

Test Mode	LTE Band 7	Test Date	2021/3/25
Test Channel	CH21100	Polarization	Vertical
Temp	21°C	Hum.	68%

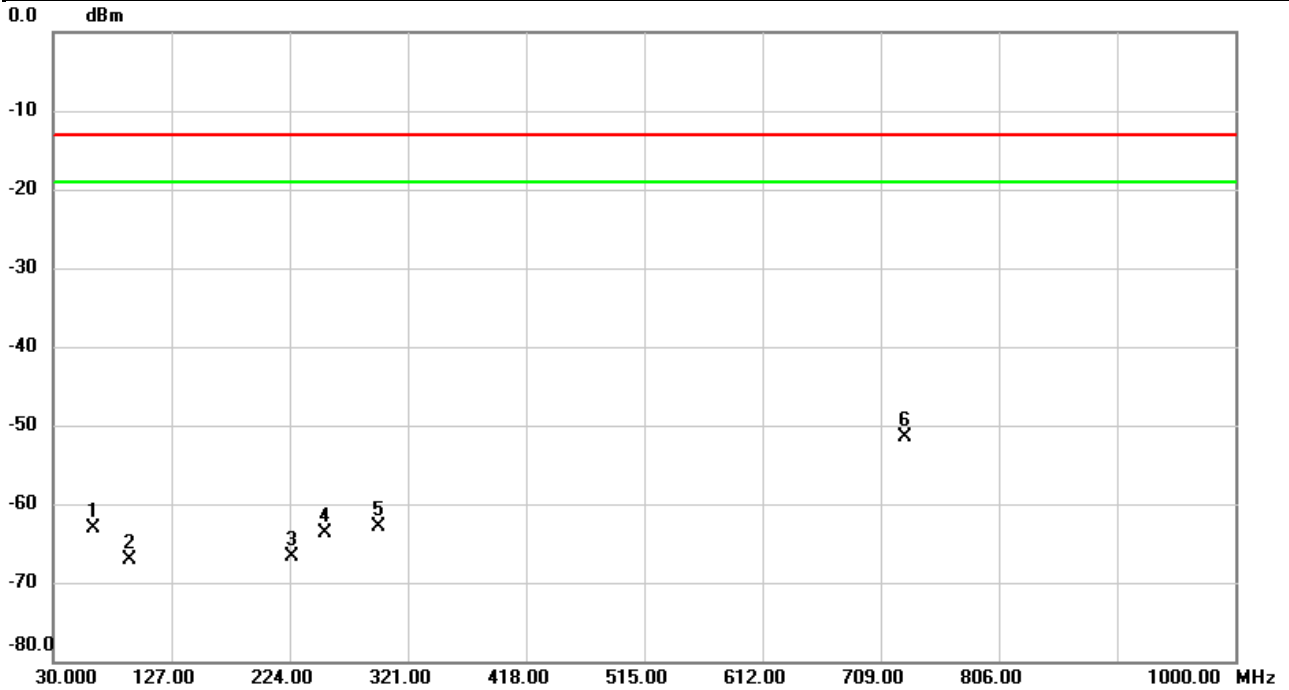

No.	Mk.	Freq.	Reading Level	Correct Factor	Measurement	Limit	Over	Detector	Comment
		MHz	dBm	dB	dBm	dBm	dB		
1		62.9800	-61.36	-1.65	-63.01	-13.00	-50.01	peak	
2		92.0800	-66.04	-1.08	-67.12	-13.00	-54.12	peak	
3		225.9400	-70.40	3.63	-66.77	-13.00	-53.77	peak	
4		253.1000	-71.45	7.72	-63.73	-13.00	-50.73	peak	
5		296.7500	-70.50	7.62	-62.88	-13.00	-49.88	peak	
6	*	729.3700	-63.55	12.01	-51.54	-13.00	-38.54	peak	

REMARKS:

- (1) Measurement Value = Reading Level + Correct Factor.
- (2) Margin Level = Measurement Value - Limit Value.

Test Mode	LTE Band 7	Test Date	2021/3/24
Test Channel	CH20850	Polarization	Vertical
Temp	21°C	Hum.	68%

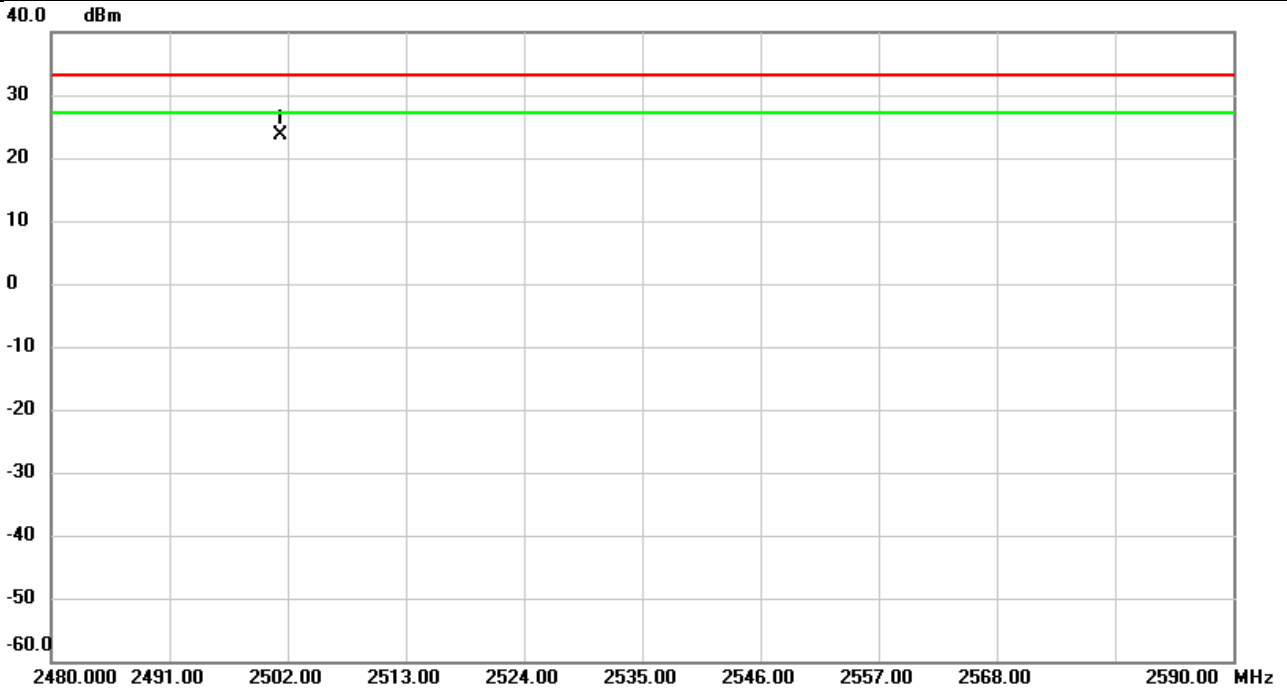

No.	Mk.	Freq.	Reading Level	Correct Factor	Measurement	Limit	Over	Detector	Comment
		MHz	dBm	dB	dBm	dBm	dB		
1	*	2501.267	-18.47	42.09	23.62	33.01	-9.39	peak	

REMARKS:

- (1) Measurement Value = Reading Level + Correct Factor.
- (2) Margin Level = Measurement Value - Limit Value.

Test Mode	LTE Band 7	Test Date	2021/3/24
Test Channel	CH20850	Polarization	Horizontal
Temp	21°C	Hum.	68%

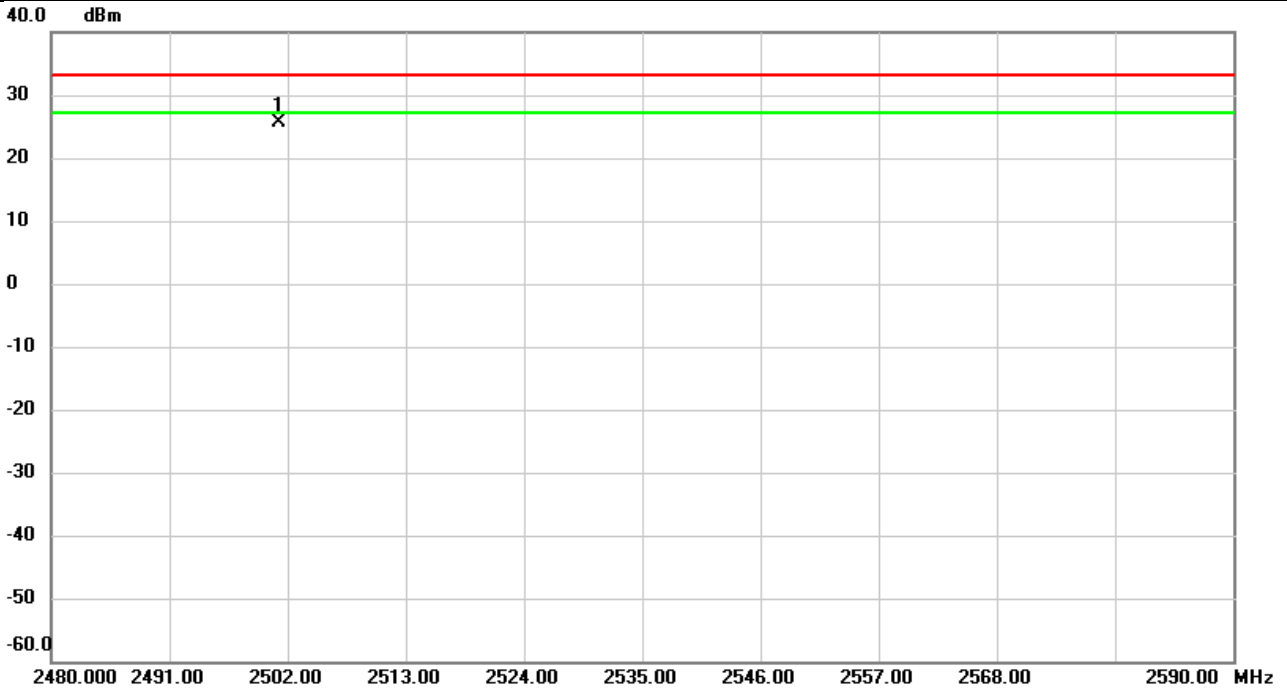

No.	Mk.	Freq.	Reading Level	Correct Factor	Measurement	Limit	Over	Detector	Comment
		MHz	dBm	dB	dBm	dBm	dB		
1	*	2501.245	-16.20	41.83	25.63	33.01	-7.38	peak	

REMARKS:

- (1) Measurement Value = Reading Level + Correct Factor.
- (2) Margin Level = Measurement Value - Limit Value.

Test Mode	LTE Band 7	Test Date	2021/3/24
Test Channel	CH21100	Polarization	Vertical
Temp	21°C	Hum.	68%

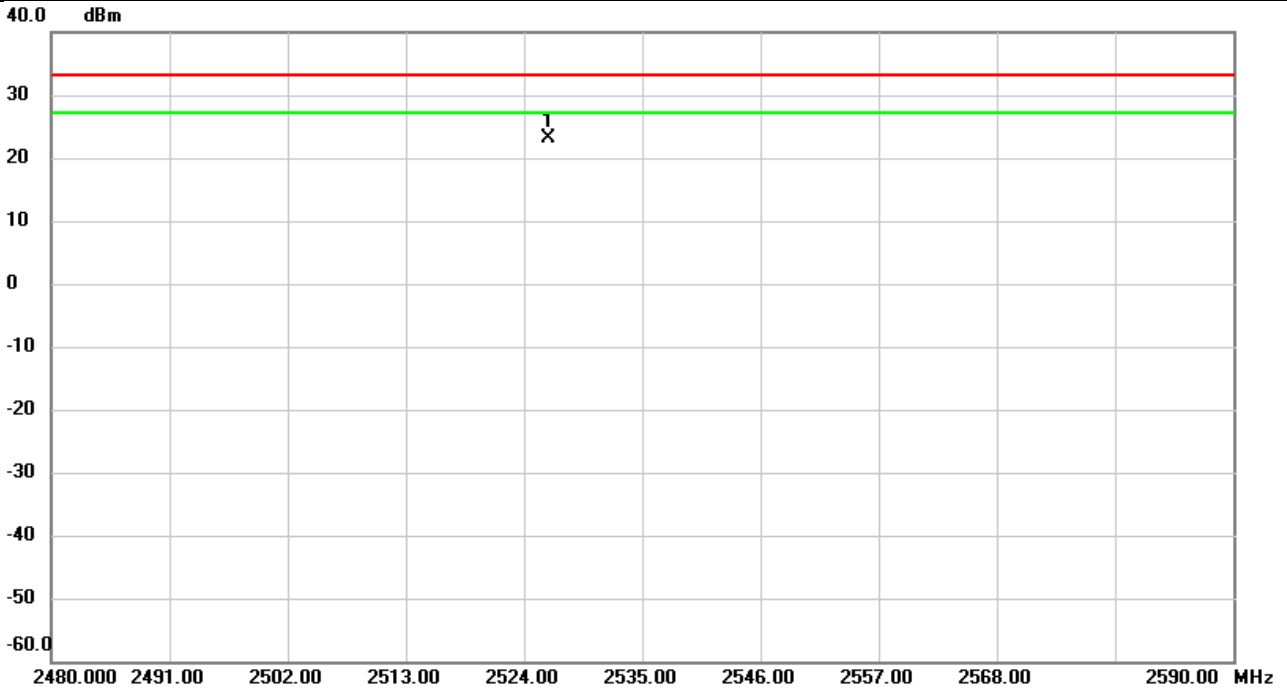

No.	Mk.	Freq.	Reading Level	Correct Factor	Measurement	Limit	Over	Detector	Comment
		MHz	dBm	dB	dBm	dBm	dB		
1	*	2526.237	-18.89	42.10	23.21	33.01	-9.80	peak	

REMARKS:

- (1) Measurement Value = Reading Level + Correct Factor.
- (2) Margin Level = Measurement Value - Limit Value.

Test Mode	LTE Band 7	Test Date	2021/3/24
Test Channel	CH21100	Polarization	Horizontal
Temp	21°C	Hum.	68%

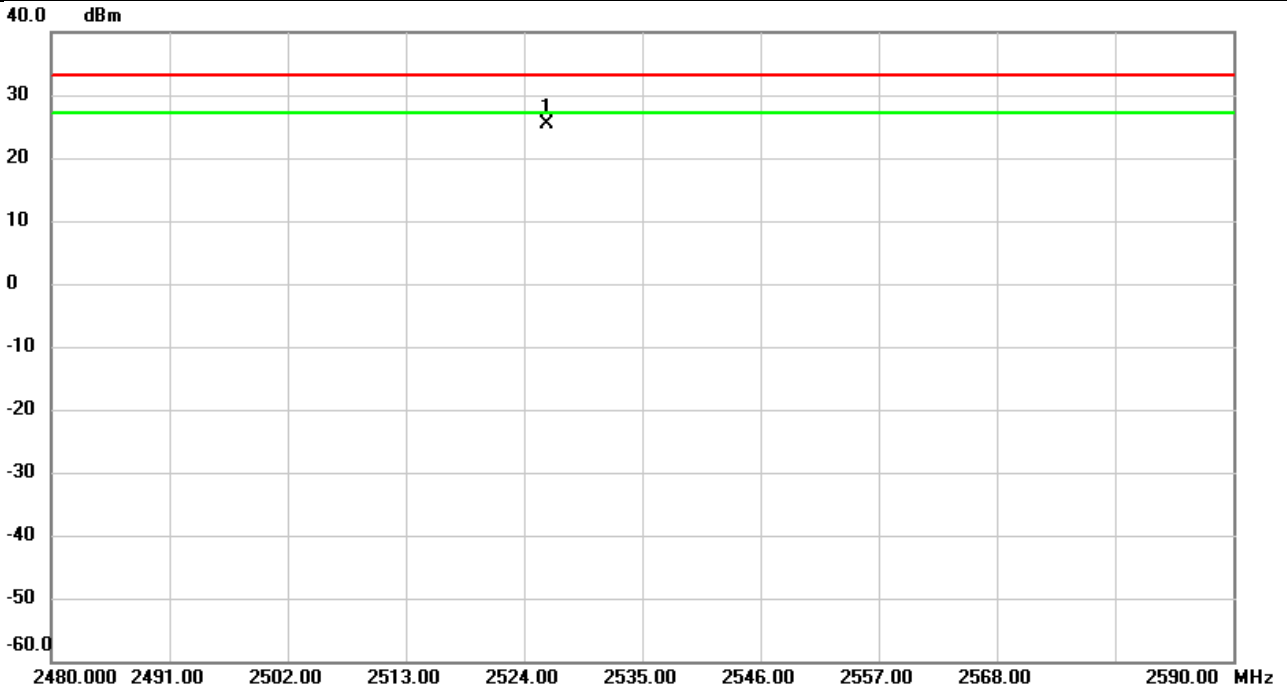

No.	Mk.	Freq.	Reading Level	Correct Factor	Measurement	Limit	Over	Detector	Comment
		MHz	dBm	dB	dBm	dBm	dB		
1	*	2526.200	-16.58	41.94	25.36	33.01	-7.65	peak	

REMARKS:

- (1) Measurement Value = Reading Level + Correct Factor.
- (2) Margin Level = Measurement Value - Limit Value.

Test Mode	LTE Band 7	Test Date	2021/3/24
Test Channel	CH21350	Polarization	Vertical
Temp	21°C	Hum.	68%

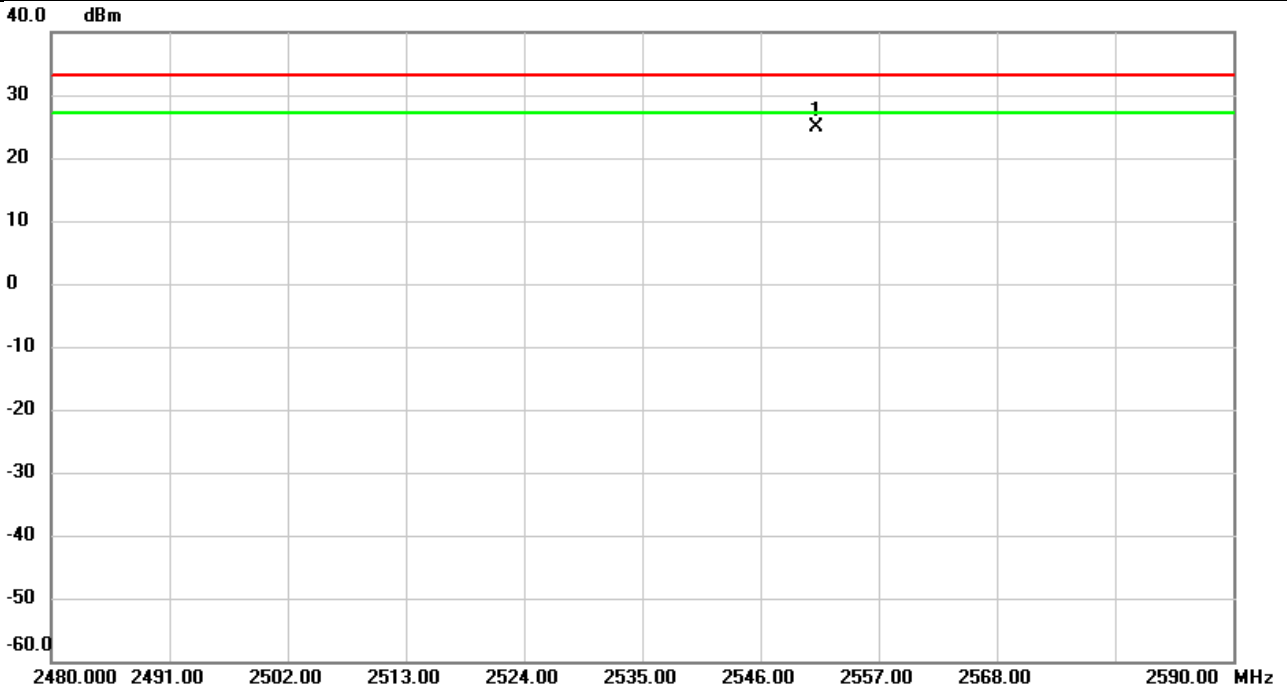

No.	Mk.	Freq.	Reading Level	Correct Factor	Measurement	Limit	Over	Detector	Comment
		MHz	dBm	dB	dBm	dBm	dB		
1	*	2551.192	-17.31	42.12	24.81	33.01	-8.20	peak	

REMARKS:

- (1) Measurement Value = Reading Level + Correct Factor.
- (2) Margin Level = Measurement Value - Limit Value.

Test Mode	LTE Band 7	Test Date	2021/3/24
Test Channel	CH21350	Polarization	Horizontal
Temp	21°C	Hum.	68%

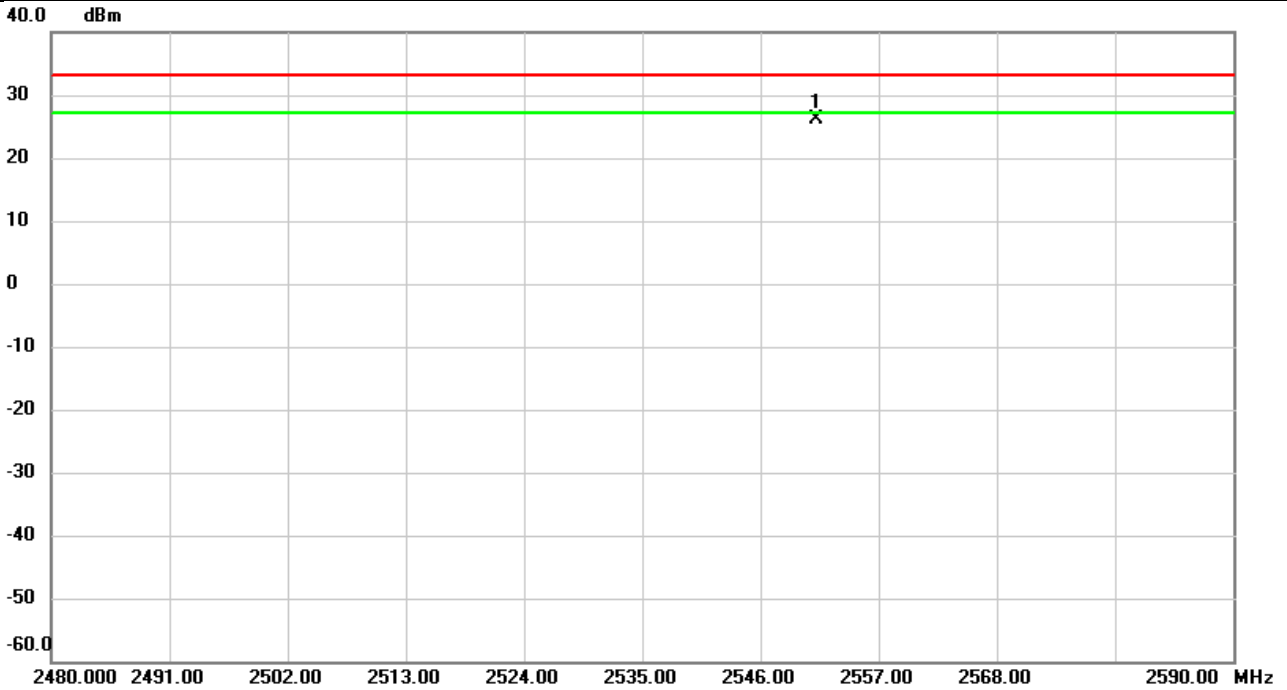

No.	Mk.	Freq.	Reading Level	Correct Factor	Measurement	Limit	Over	Detector	Comment
		MHz	dBm	dB	dBm	dBm	dB		
1	*	2551.265	-15.94	42.06	26.12	33.01	-6.89	peak	

REMARKS:

- (1) Measurement Value = Reading Level + Correct Factor.
- (2) Margin Level = Measurement Value - Limit Value.

Test Mode	LTE Band 7	Test Date	2021/3/24
Test Channel	CH21100	Polarization	Vertical
Temp	21°C	Hum.	68%

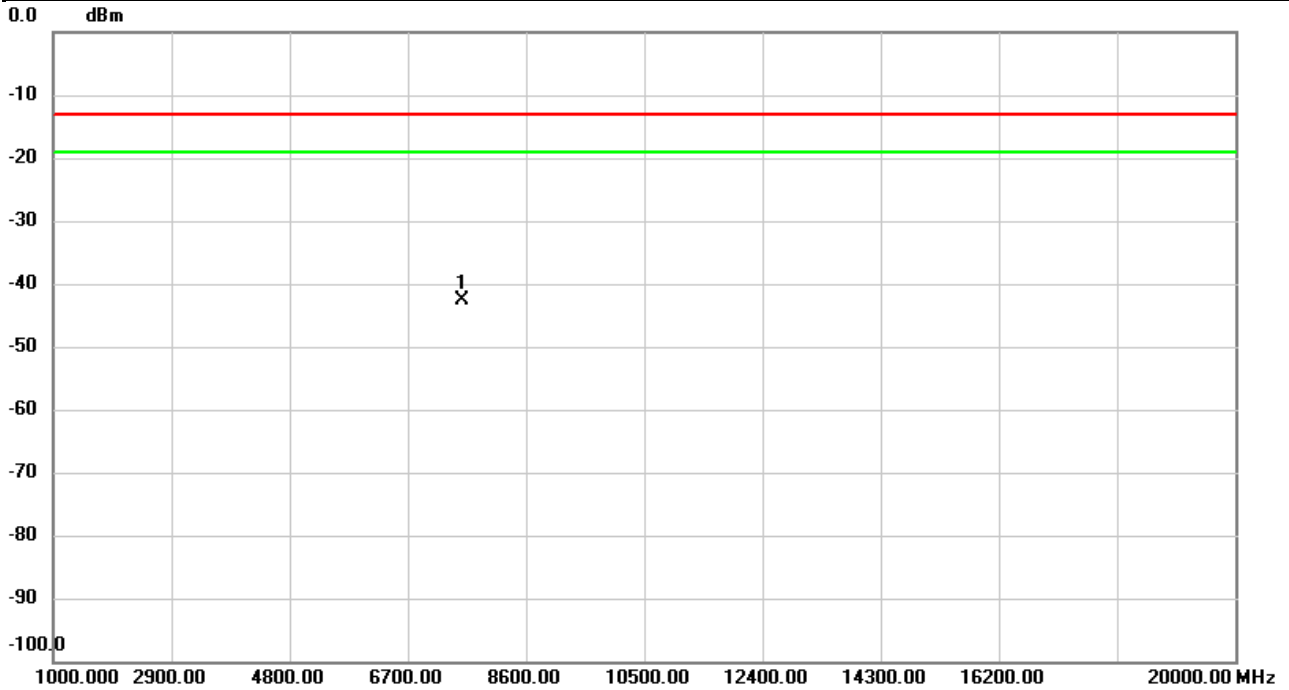

No.	Mk.	Freq.	Reading Level	Correct Factor	Measurement	Limit	Over	Detector	Comment
		MHz	dBm	dB	dBm	dBm	dB		
1	*	7578.433	-50.18	7.55	-42.63	-13.00	-29.63	peak	

REMARKS:

- (1) Measurement Value = Reading Level + Correct Factor.
- (2) Margin Level = Measurement Value - Limit Value.

Test Mode	LTE Band 7	Test Date	2021/3/24
Test Channel	CH21100	Polarization	Horizontal
Temp	21°C	Hum.	68%

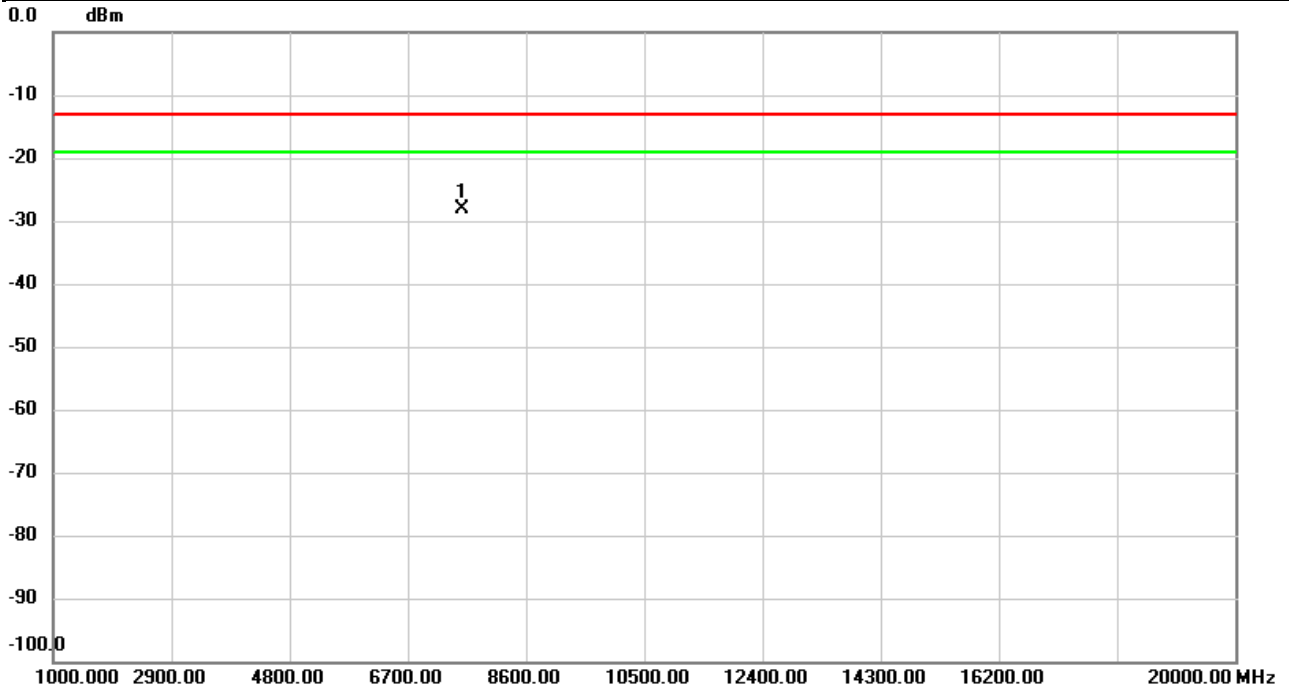

No.	Mk.	Freq.	Reading Level	Correct Factor	Measurement	Limit	Over	Detector	Comment
		MHz	dBm	dB	dBm	dBm	dB		
1	*	7578.433	-35.99	7.93	-28.06	-13.00	-15.06	peak	

REMARKS:

- (1) Measurement Value = Reading Level + Correct Factor.
- (2) Margin Level = Measurement Value - Limit Value.

Test Mode	LTE Band 12	Test Date	2021/3/25
Test Channel	CH23095	Polarization	Vertical
Temp	21°C	Hum.	68%

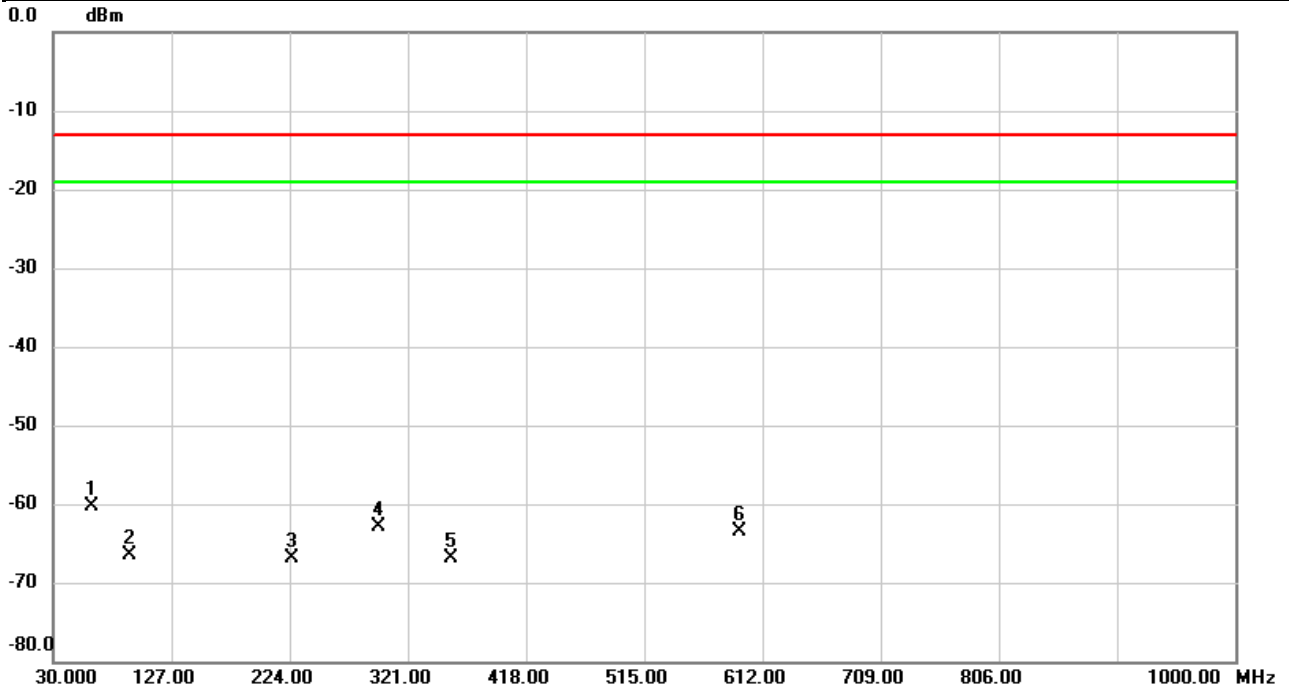

No.	Mk.	Freq.	Reading Level	Correct Factor	Measurement	Limit	Over	Detector	Comment
		MHz	dBm	dB	dBm	dBm	dB		
1	*	61.0400	-58.95	-1.44	-60.39	-13.00	-47.39	peak	
2		92.0800	-65.44	-1.08	-66.52	-13.00	-53.52	peak	
3		225.9400	-70.49	3.63	-66.86	-13.00	-53.86	peak	
4		296.7500	-70.61	7.62	-62.99	-13.00	-49.99	peak	
5		355.9200	-73.01	6.14	-66.87	-13.00	-53.87	peak	
6		593.5700	-75.32	11.75	-63.57	-13.00	-50.57	peak	

REMARKS:

- (1) Measurement Value = Reading Level + Correct Factor.
- (2) Margin Level = Measurement Value - Limit Value.

Test Mode	LTE Band 12	Test Date	2021/3/25
Test Channel	CH23095	Polarization	Horizontal
Temp	21°C	Hum.	68%

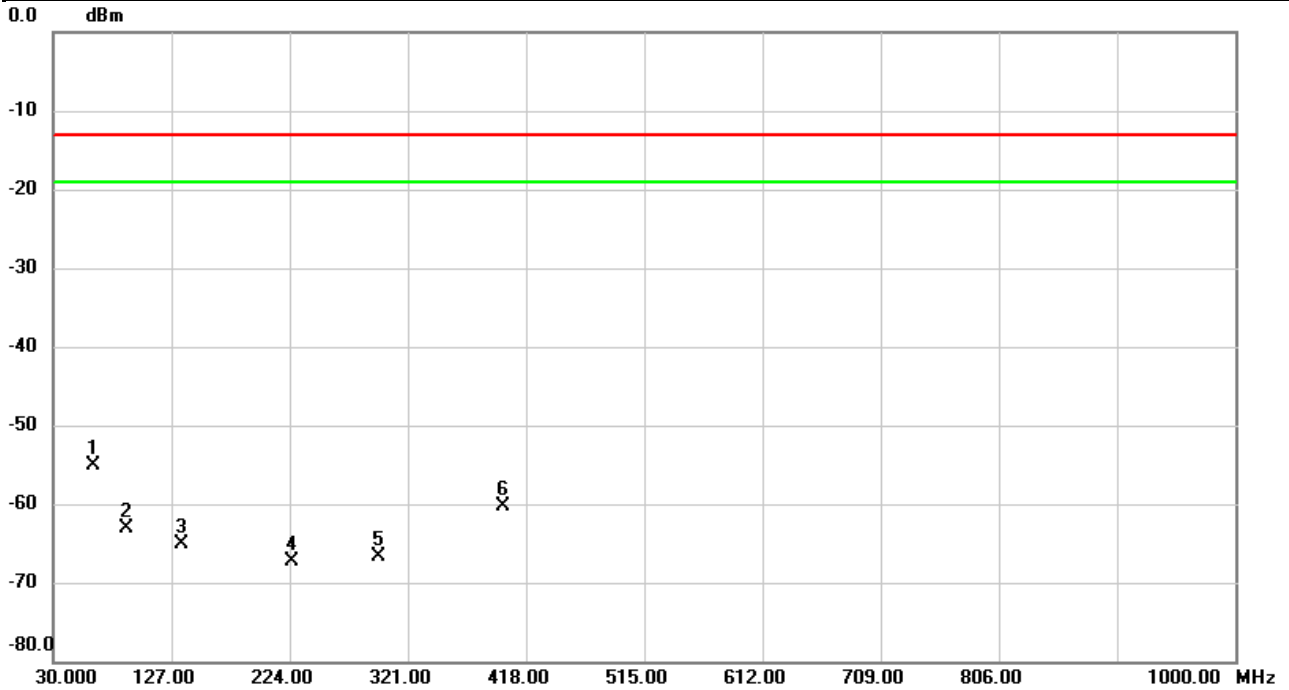

No.	Mk.	Freq.	Reading Level	Correct Factor	Measurement	Limit	Over	Detector	Comment
		MHz	dBm	dB	dBm	dBm	dB		
1	*	62.9800	-61.31	6.15	-55.16	-13.00	-42.16	peak	
2		90.1400	-66.78	3.66	-63.12	-13.00	-50.12	peak	
3		134.7600	-67.82	2.79	-65.03	-13.00	-52.03	peak	
4		225.9400	-66.52	-0.76	-67.28	-13.00	-54.28	peak	
5		296.7500	-67.52	0.76	-66.76	-13.00	-53.76	peak	
6		398.6000	-66.49	6.12	-60.37	-13.00	-47.37	peak	

REMARKS:

- (1) Measurement Value = Reading Level + Correct Factor.
- (2) Margin Level = Measurement Value - Limit Value.

Test Mode	LTE Band 12	Test Date	2021/3/25
Test Channel	CH23060	Polarization	Vertical
Temp	21°C	Hum.	68%

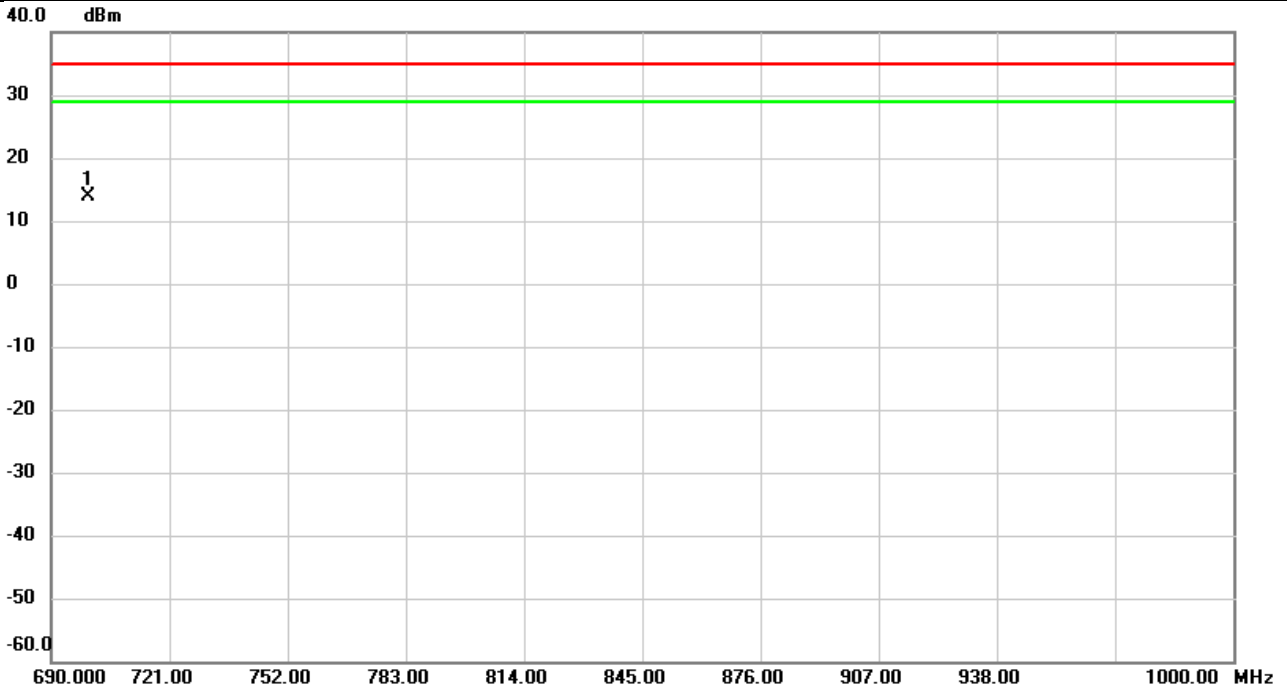

No.	Mk.	Freq. MHz	Reading Level dBm	Correct Factor dB	Measure- ment dBm	Limit dBm	Over dB	Detector	Comment
1	*	699.6720	-19.15	32.96	13.81	34.77	-20.96	peak	

REMARKS:

- (1) Measurement Value = Reading Level + Correct Factor.
- (2) Margin Level = Measurement Value - Limit Value.

Test Mode	LTE Band 12	Test Date	2021/3/25
Test Channel	CH23060	Polarization	Horizontal
Temp	21°C	Hum.	68%

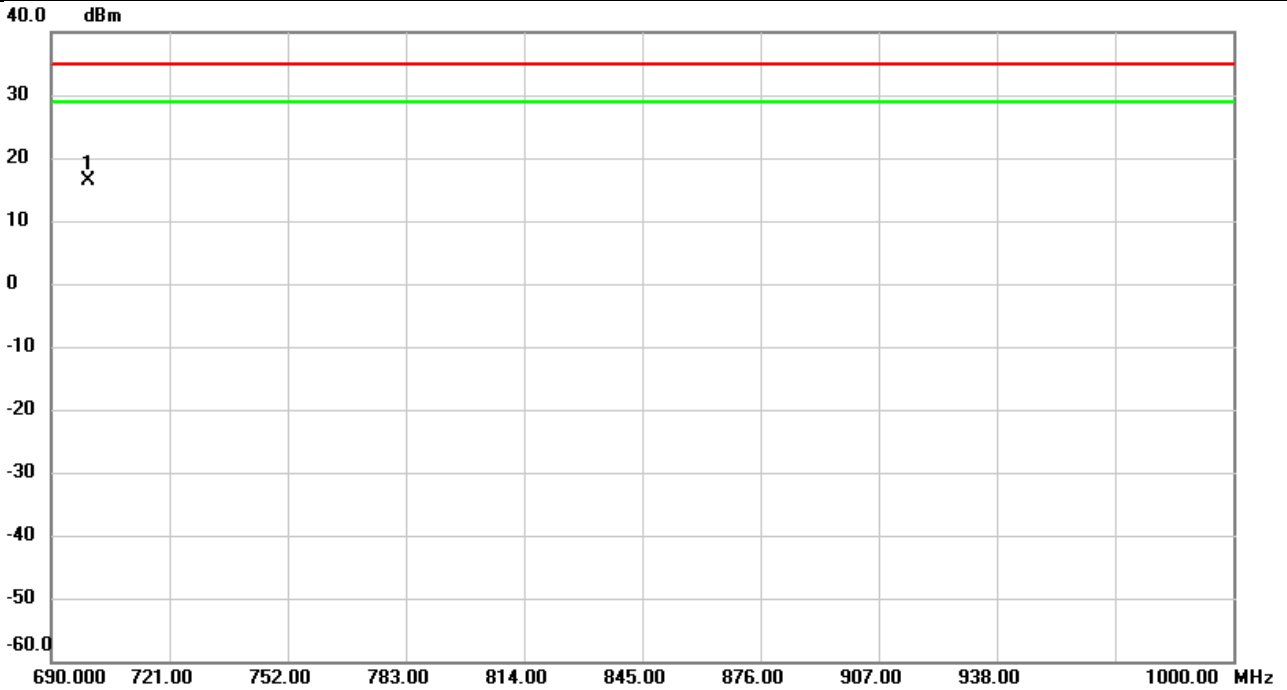

No.	Mk.	Freq.	Reading Level	Correct Factor	Measurement	Limit	Over	Detector	Comment
		MHz	dBm	dB	dBm	dBm	dB		
1	*	699.5480	-14.16	30.44	16.28	34.77	-18.49	peak	

REMARKS:

- (1) Measurement Value = Reading Level + Correct Factor.
- (2) Margin Level = Measurement Value - Limit Value.

Test Mode	LTE Band 12	Test Date	2021/3/25
Test Channel	CH23095	Polarization	Vertical
Temp	21°C	Hum.	68%

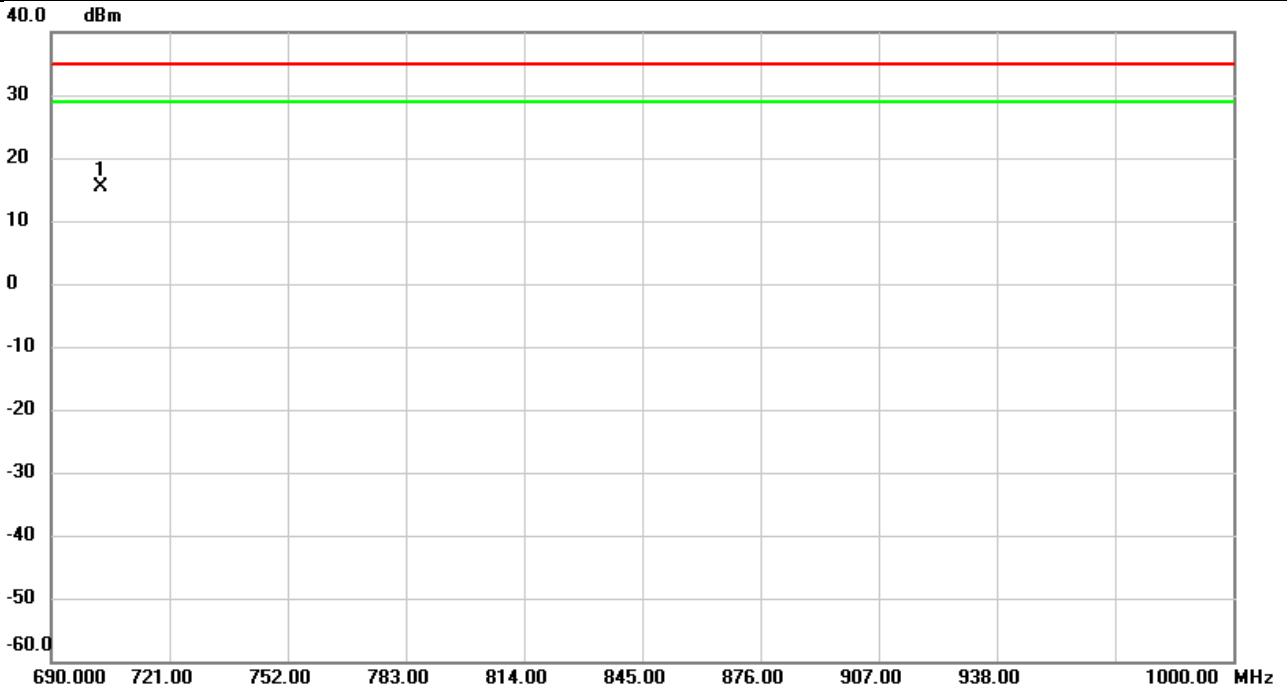

No.	Mk.	Freq.	Reading Level	Correct Factor	Measurement	Limit	Over	Detector	Comment
		MHz	dBm	dB	dBm	dBm	dB		
1	*	703.1750	-17.51	32.99	15.48	34.77	-19.29	peak	

REMARKS:

- (1) Measurement Value = Reading Level + Correct Factor.
- (2) Margin Level = Measurement Value - Limit Value.

Test Mode	LTE Band 12	Test Date	2021/3/25
Test Channel	CH23095	Polarization	Horizontal
Temp	21°C	Hum.	68%

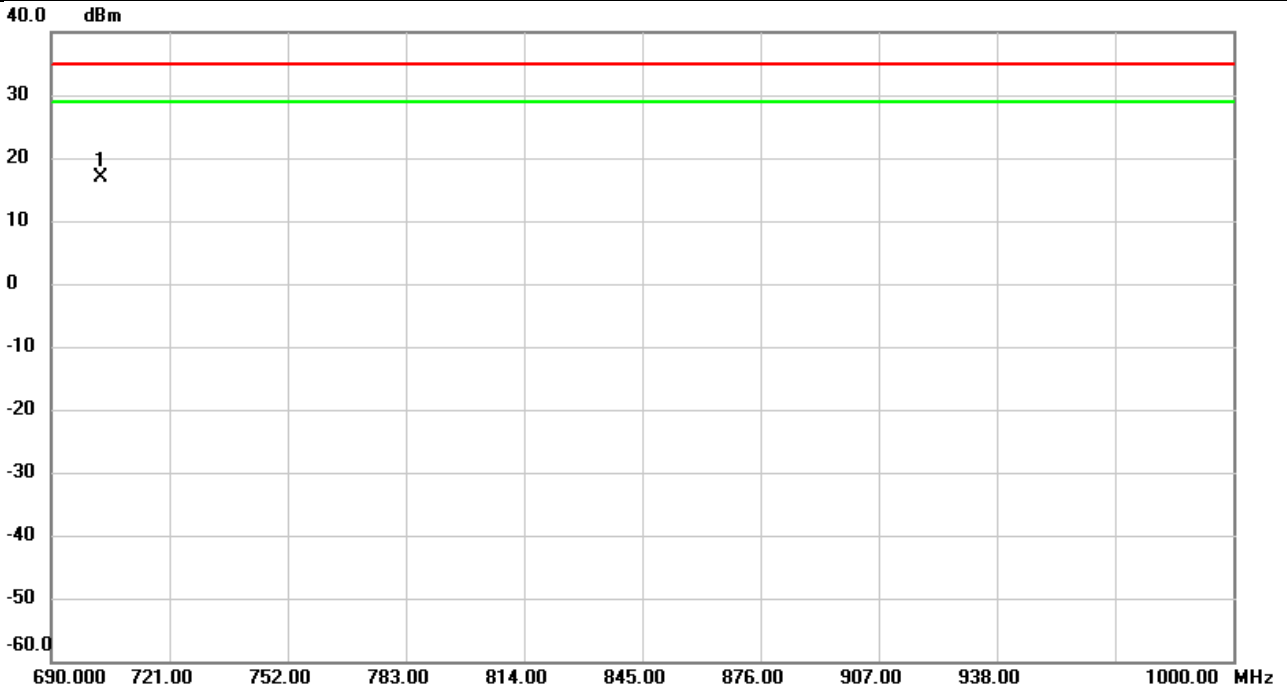

No.	Mk.	Freq.	Reading Level	Correct Factor	Measurement	Limit	Over	Detector	Comment
		MHz	dBm	dB	dBm	dBm	dB		
1	*	703.1543	-13.76	30.55	16.79	34.77	-17.98	peak	

REMARKS:

- (1) Measurement Value = Reading Level + Correct Factor.
- (2) Margin Level = Measurement Value - Limit Value.

Test Mode	LTE Band 12	Test Date	2021/3/25
Test Channel	CH23130	Polarization	Vertical
Temp	21°C	Hum.	68%

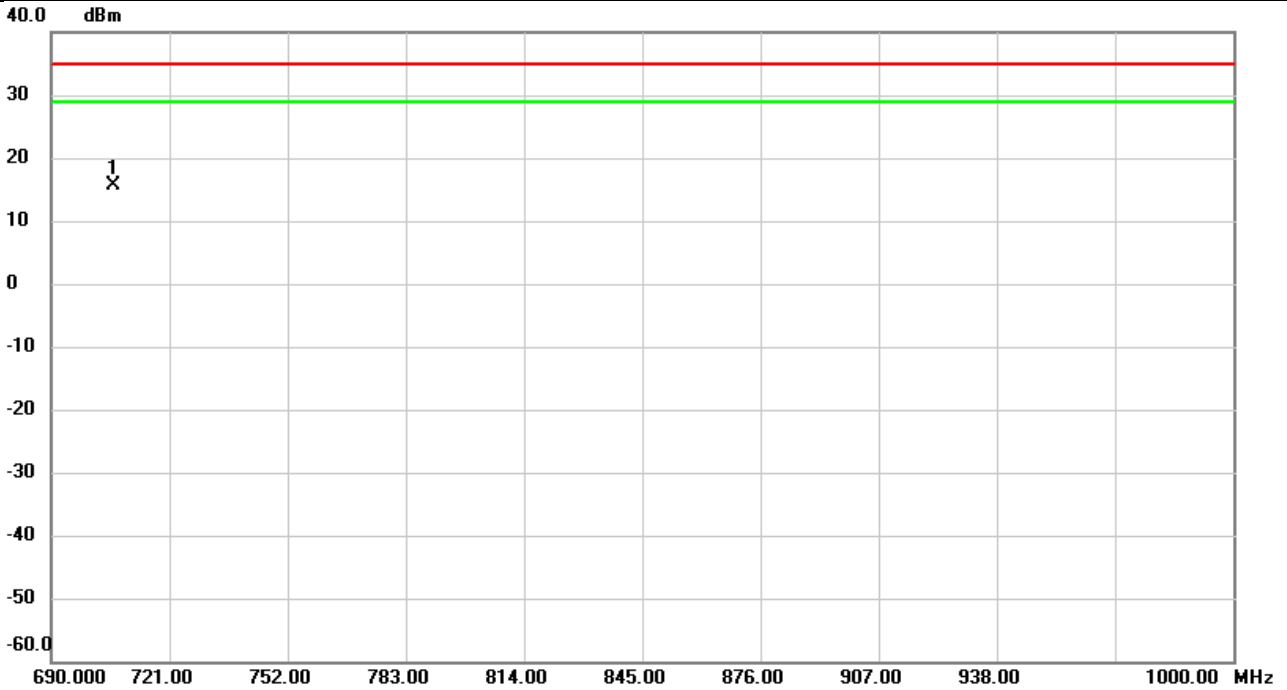

No.	Mk.	Freq.	Reading Level	Correct Factor	Measurement	Limit	Over	Detector	Comment
		MHz	dBm	dB	dBm	dBm	dB		
1	*	706.5230	-17.35	33.02	15.67	34.77	-19.10	peak	

REMARKS:

- (1) Measurement Value = Reading Level + Correct Factor.
- (2) Margin Level = Measurement Value - Limit Value.

Test Mode	LTE Band 12	Test Date	2021/3/25
Test Channel	CH23130	Polarization	Horizontal
Temp	21°C	Hum.	68%

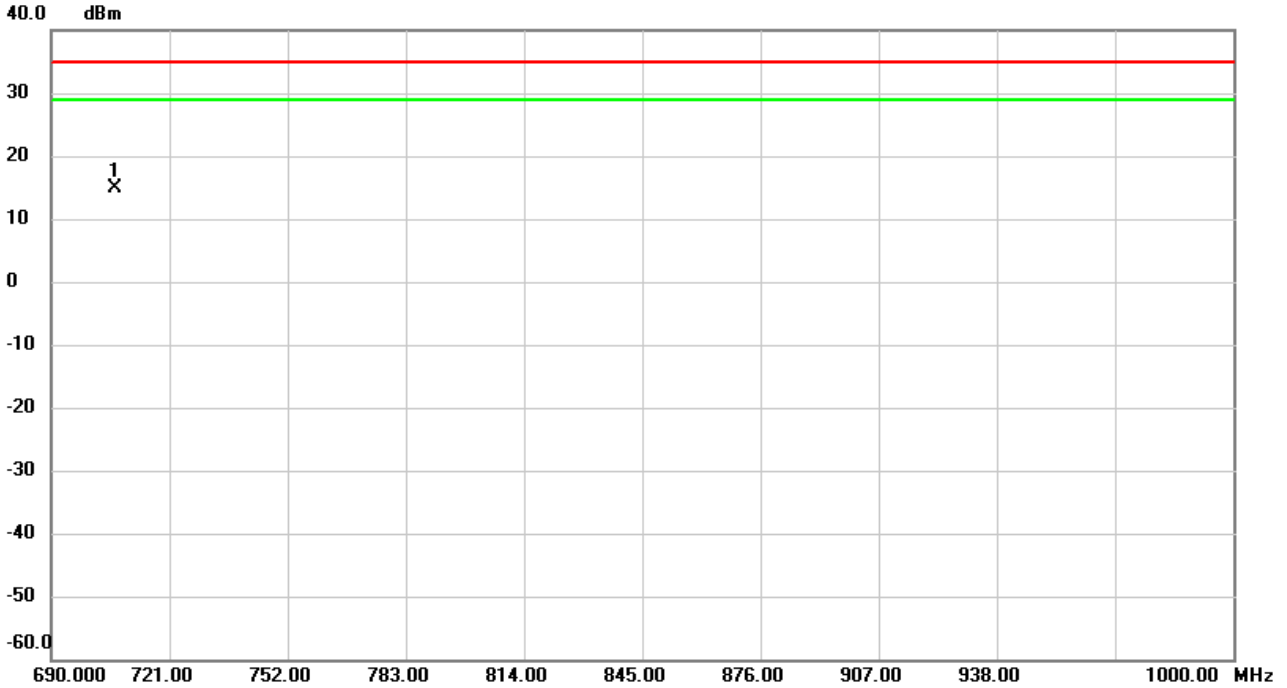

No.	Mk.	Freq.	Reading Level	Correct Factor	Measurement	Limit	Over	Detector	Comment
		MHz	dBm	dB	dBm	dBm	dB		
1	*	706.7400	-15.82	30.67	14.85	34.77	-19.92	peak	

REMARKS:

- (1) Measurement Value = Reading Level + Correct Factor.
- (2) Margin Level = Measurement Value - Limit Value.

Test Mode	LTE Band 12	Test Date	2021/3/25
Test Channel	CH23095	Polarization	Vertical
Temp	21°C	Hum.	68%

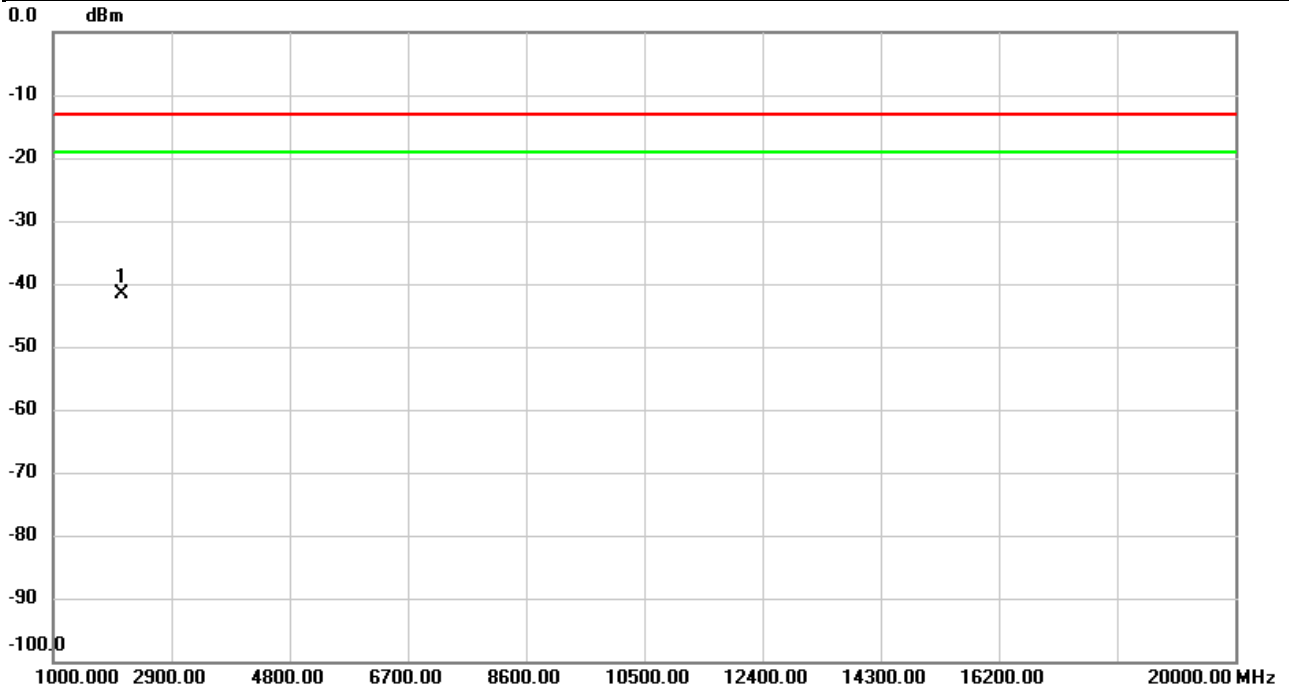

No.	Mk.	Freq.	Reading Level	Correct Factor	Measurement	Limit	Over	Detector	Comment
		MHz	dBm	dB	dBm	dBm	dB		
1	*	2109.600	-36.53	-5.18	-41.71	-13.00	-28.71	peak	

REMARKS:

- (1) Measurement Value = Reading Level + Correct Factor.
- (2) Margin Level = Measurement Value - Limit Value.

Test Mode	LTE Band 12	Test Date	2021/3/25
Test Channel	CH23095	Polarization	Horizontal
Temp	21°C	Hum.	68%

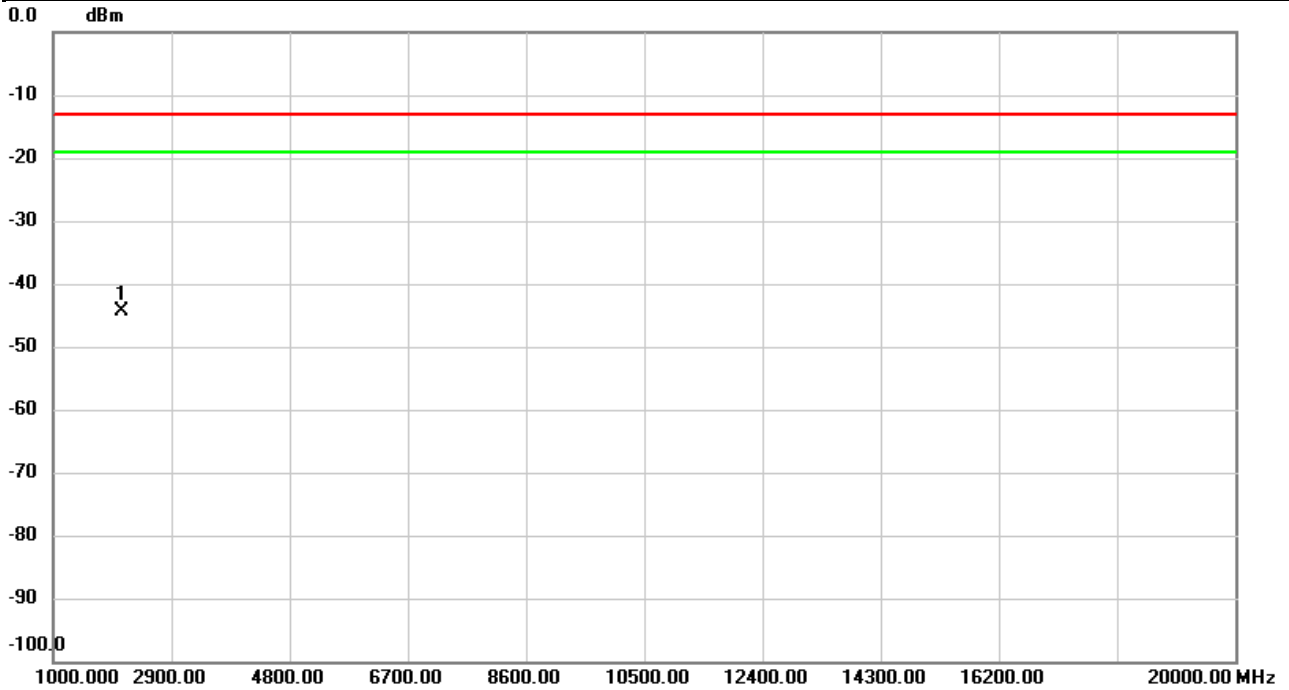

No.	Mk.	Freq.	Reading Level	Correct Factor	Measurement	Limit	Over	Detector	Comment
		MHz	dBm	dB	dBm	dBm	dB		
1	*	2109.600	-38.82	-5.57	-44.39	-13.00	-31.39	peak	

REMARKS:

- (1) Measurement Value = Reading Level + Correct Factor.
- (2) Margin Level = Measurement Value - Limit Value.

Test Mode	LTE Band 13	Test Date	2021/3/25
Test Channel	CH23230	Polarization	Vertical
Temp	21°C	Hum.	68%

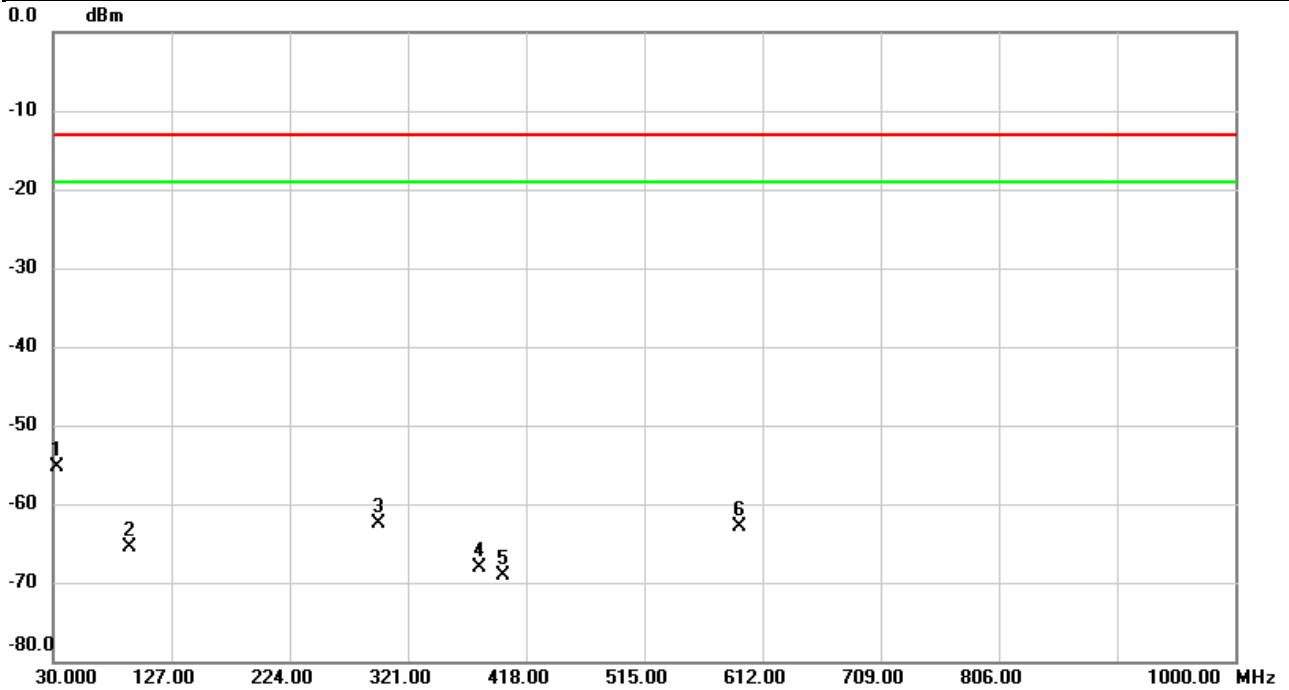

No.	Mk.	Freq.	Reading Level	Correct Factor	Measurement	Limit	Over	Detector	Comment
		MHz	dBm	dB	dBm	dBm	dB		
1	*	32.9100	-51.45	-3.84	-55.29	-13.00	-42.29	peak	
2		93.0500	-64.67	-0.85	-65.52	-13.00	-52.52	peak	
3		296.7500	-70.07	7.62	-62.45	-13.00	-49.45	peak	
4		380.1700	-72.10	4.09	-68.01	-13.00	-55.01	peak	
5		398.6000	-71.59	2.53	-69.06	-13.00	-56.06	peak	
6		593.5700	-74.62	11.75	-62.87	-13.00	-49.87	peak	

REMARKS:

- (1) Measurement Value = Reading Level + Correct Factor.
- (2) Margin Level = Measurement Value - Limit Value.

Test Mode	LTE Band 17	Test Date	2021/3/25
Test Channel	CH23230	Polarization	Horizontal
Temp	21°C	Hum.	68%

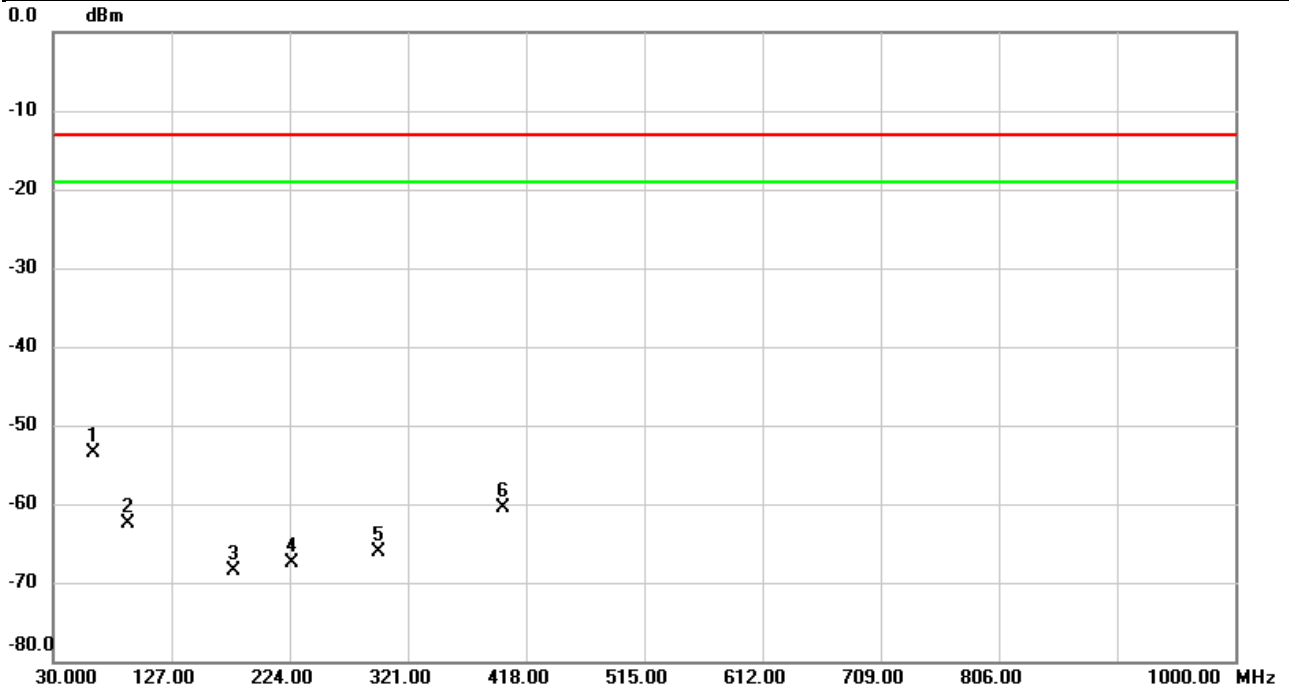

No.	Mk.	Freq.	Reading Level	Correct Factor	Measurement	Limit	Over	Detector	Comment
		MHz	dBm	dB	dBm	dBm	dB		
1	*	62.9800	-59.64	6.15	-53.49	-13.00	-40.49	peak	
2		91.1100	-66.14	3.63	-62.51	-13.00	-49.51	peak	
3		178.4100	-70.14	1.58	-68.56	-13.00	-55.56	peak	
4		225.9400	-66.74	-0.76	-67.50	-13.00	-54.50	peak	
5		296.7500	-66.79	0.76	-66.03	-13.00	-53.03	peak	
6		398.6000	-66.70	6.12	-60.58	-13.00	-47.58	peak	

REMARKS:

- (1) Measurement Value = Reading Level + Correct Factor.
- (2) Margin Level = Measurement Value - Limit Value.

Test Mode	LTE Band 13	Test Date	2021/3/25
Test Channel	CH23230	Polarization	Vertical
Temp	21°C	Hum.	68%

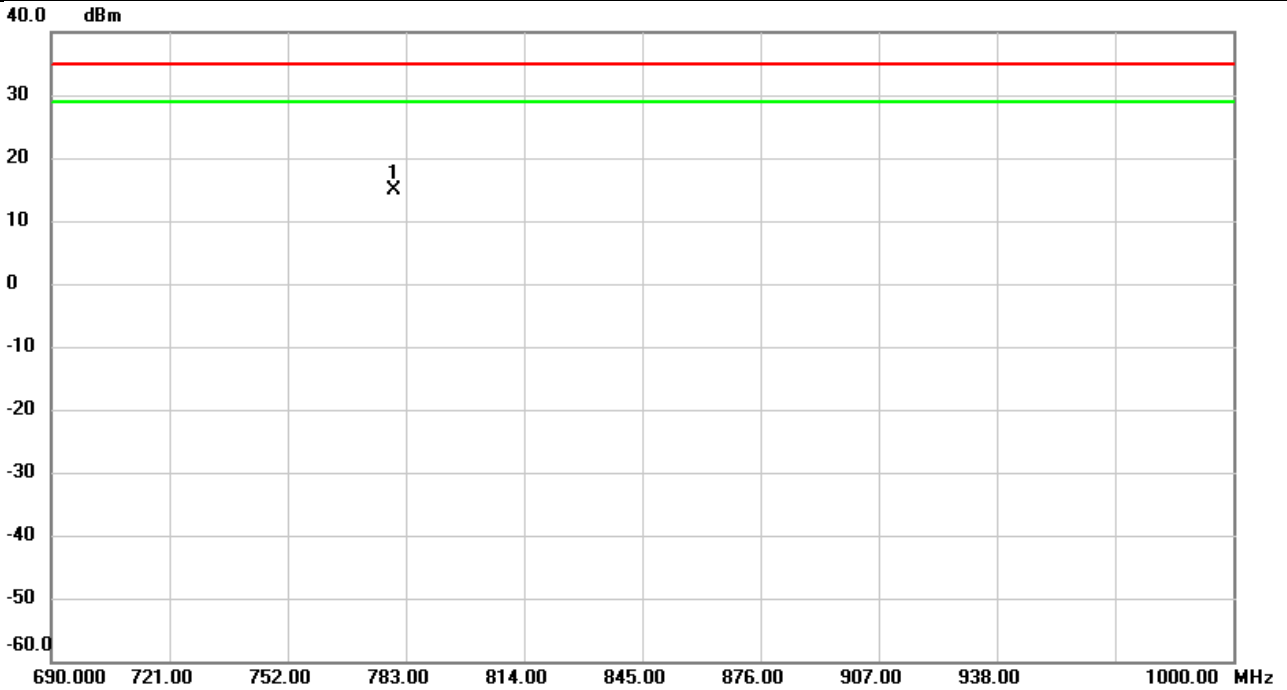

No.	Mk.	Freq.	Reading Level	Correct Factor	Measurement	Limit	Over	Detector	Comment
		MHz	dBm	dB	dBm	dBm	dB		
1	*	779.9207	-19.19	33.98	14.79	34.77	-19.98	peak	

REMARKS:

- (1) Measurement Value = Reading Level + Correct Factor.
- (2) Margin Level = Measurement Value - Limit Value.

Test Mode	LTE Band 13	Test Date	2021/3/25
Test Channel	CH23230	Polarization	Horizontal
Temp	21°C	Hum.	68%

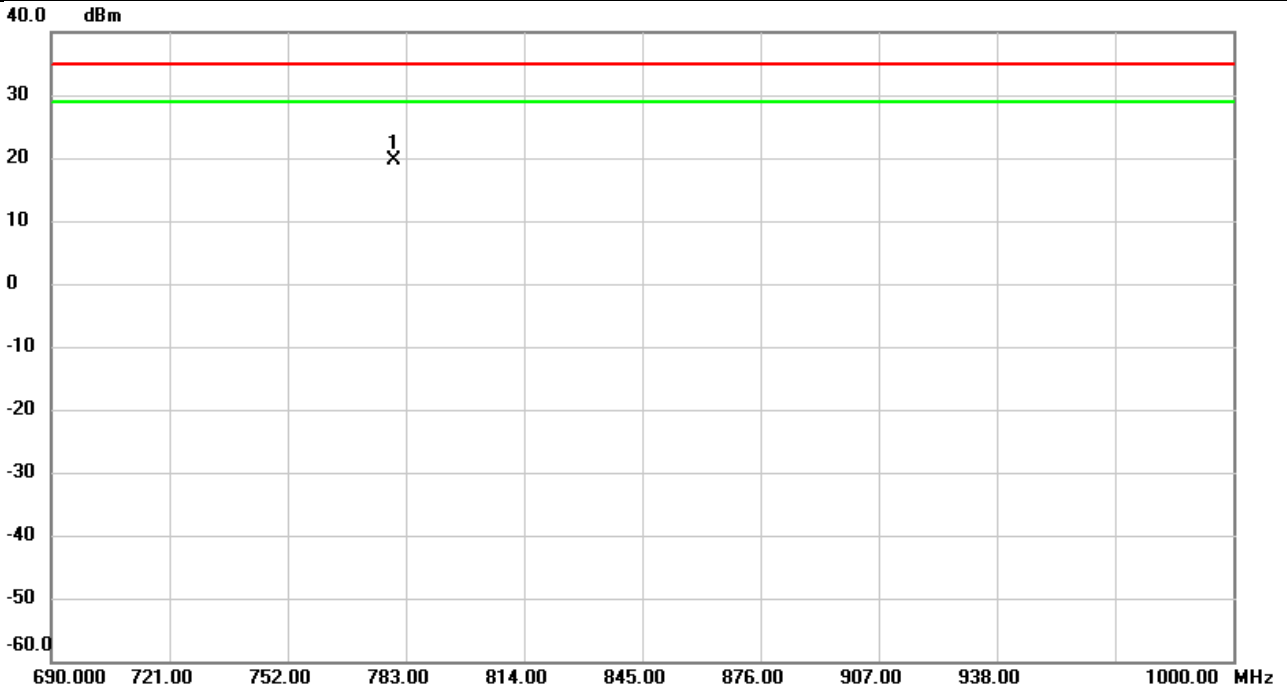

No.	Mk.	Freq.	Reading Level	Correct Factor	Measurement	Limit	Over	Detector	Comment
		MHz	dBm	dB	dBm	dBm	dB		
1	*	779.9000	-13.42	33.02	19.60	34.77	-15.17	peak	

REMARKS:

- (1) Measurement Value = Reading Level + Correct Factor.
- (2) Margin Level = Measurement Value - Limit Value.

Test Mode	LTE Band 13	Test Date	2021/3/25
Test Channel	CH23230	Polarization	Vertical
Temp	21°C	Hum.	68%

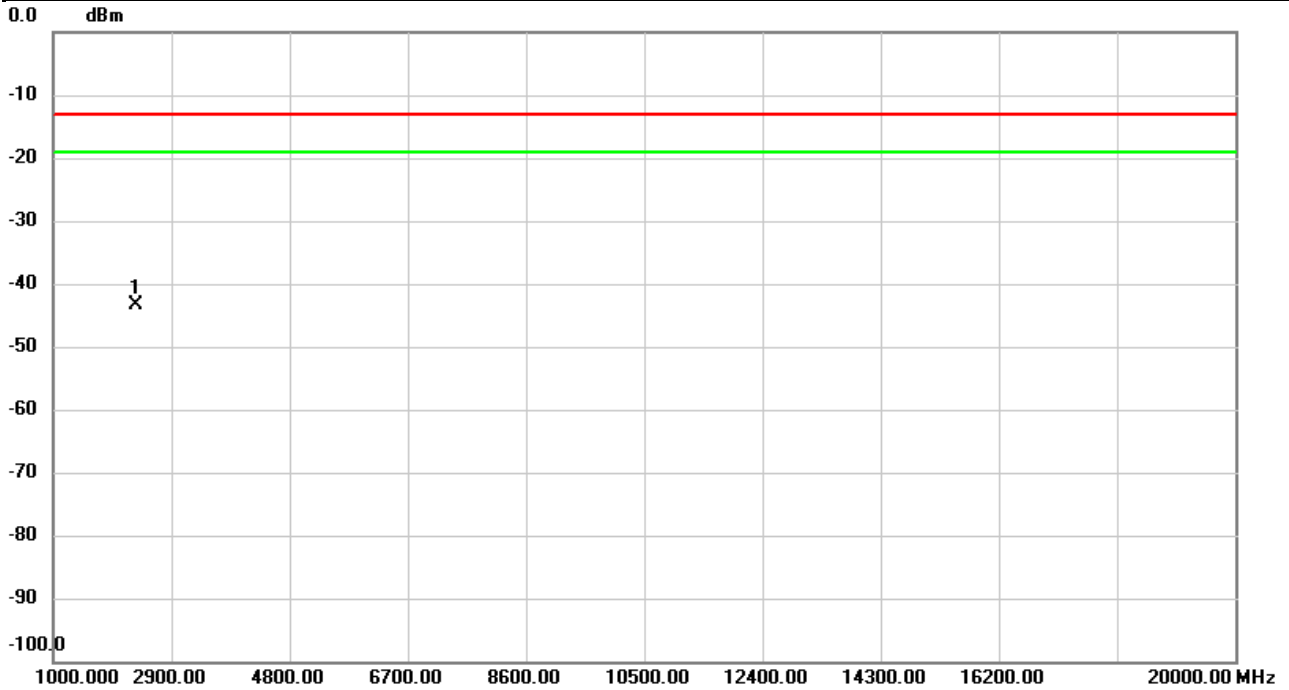

No.	Mk.	Freq.	Reading Level	Correct Factor	Measurement	Limit	Over	Detector	Comment
		MHz	dBm	dB	dBm	dBm	dB		
1	*	2333.167	-39.30	-3.99	-43.29	-13.00	-30.29	peak	

REMARKS:

- (1) Measurement Value = Reading Level + Correct Factor.
- (2) Margin Level = Measurement Value - Limit Value.

Test Mode	LTE Band 13	Test Date	2021/3/25
Test Channel	CH23230	Polarization	Horizontal
Temp	21°C	Hum.	68%

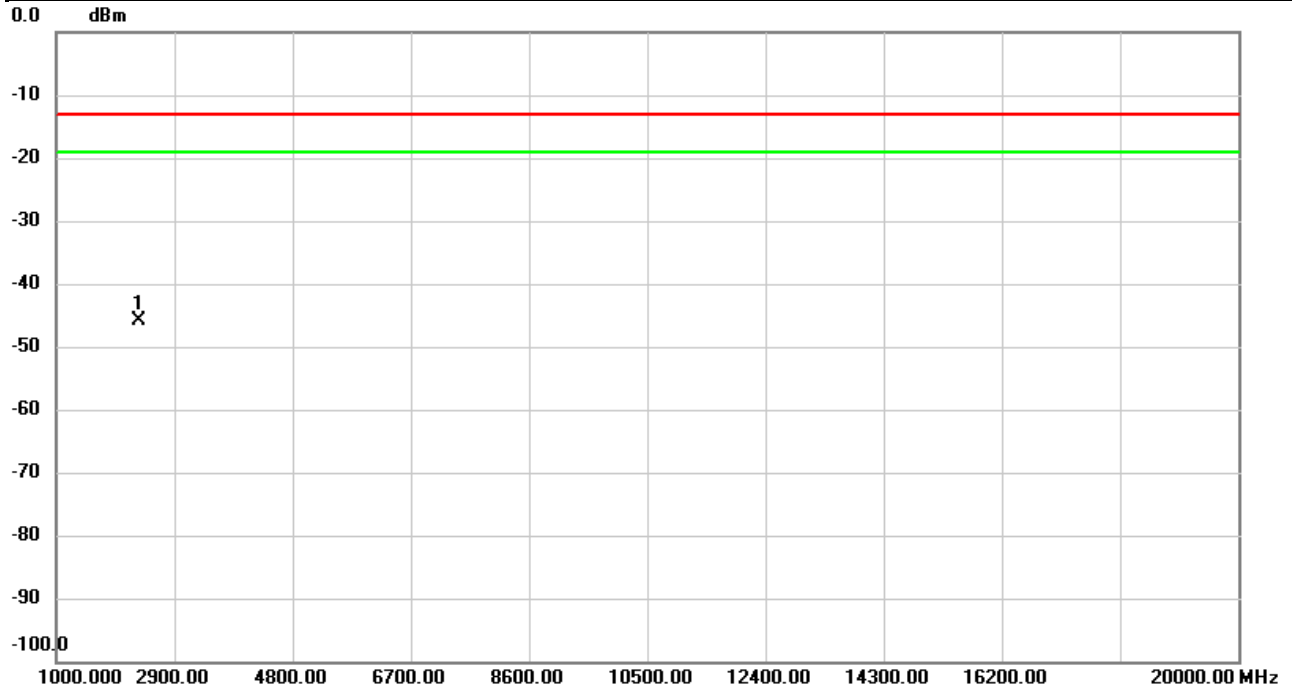

No.	Mk.	Freq.	Reading Level	Correct Factor	Measurement	Limit	Over	Detector	Comment
		MHz	dBm	dB	dBm	dBm	dB		
1	*	2333.167	-41.28	-4.65	-45.93	-13.00	-32.93	peak	

REMARKS:

- (1) Measurement Value = Reading Level + Correct Factor.
- (2) Margin Level = Measurement Value - Limit Value.

Test Mode	LTE Band 17	Test Date	2021/3/25
Test Channel	CH23790	Polarization	Vertical
Temp	21°C	Hum.	68%

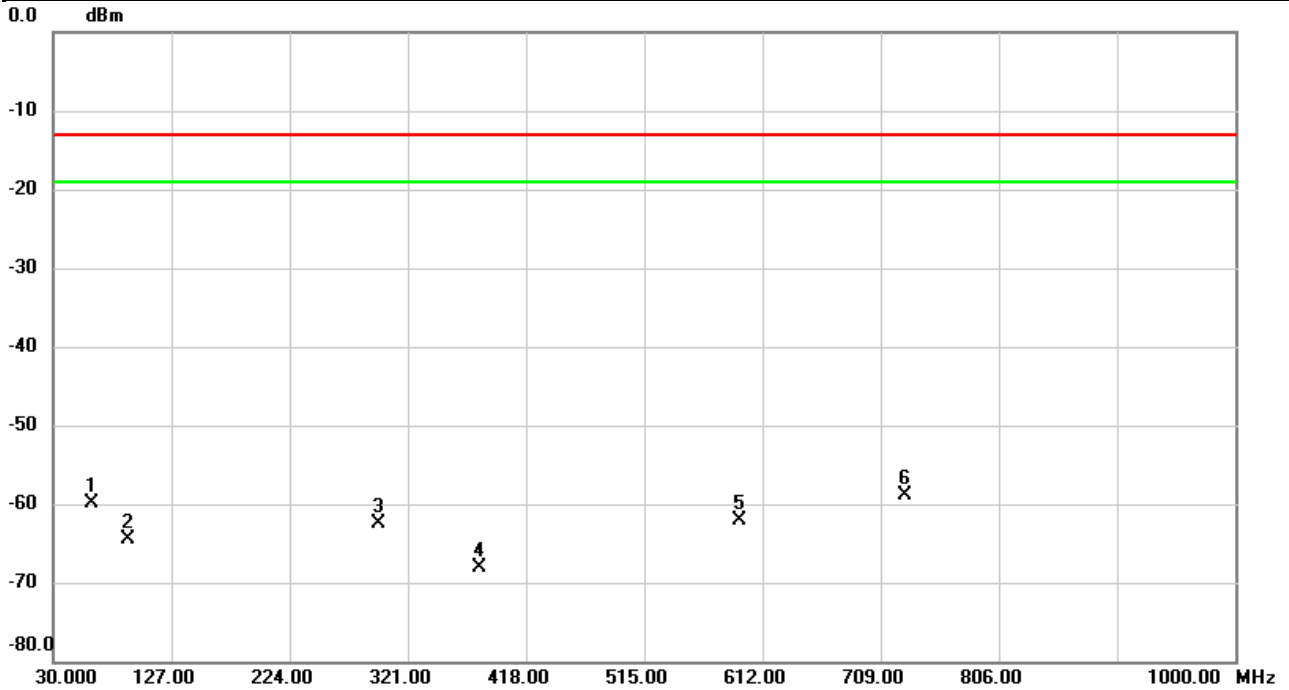

No.	Mk.	Freq.	Reading Level	Correct Factor	Measurement	Limit	Over	Detector	Comment
		MHz	dBm	dB	dBm	dBm	dB		
1		61.5250	-58.34	-1.50	-59.84	-13.00	-46.84	peak	
2		91.7567	-63.34	-1.16	-64.50	-13.00	-51.50	peak	
3		296.7177	-70.15	7.62	-62.53	-13.00	-49.53	peak	
4		379.6527	-72.15	4.13	-68.02	-13.00	-55.02	peak	
5		593.4083	-73.82	11.74	-62.08	-13.00	-49.08	peak	
6	*	729.3377	-70.87	12.01	-58.86	-13.00	-45.86	peak	

REMARKS:

- (1) Measurement Value = Reading Level + Correct Factor.
- (2) Margin Level = Measurement Value - Limit Value.

Test Mode	LTE Band 17	Test Date	2021/3/25
Test Channel	CH23790	Polarization	Horizontal
Temp	21°C	Hum.	68%

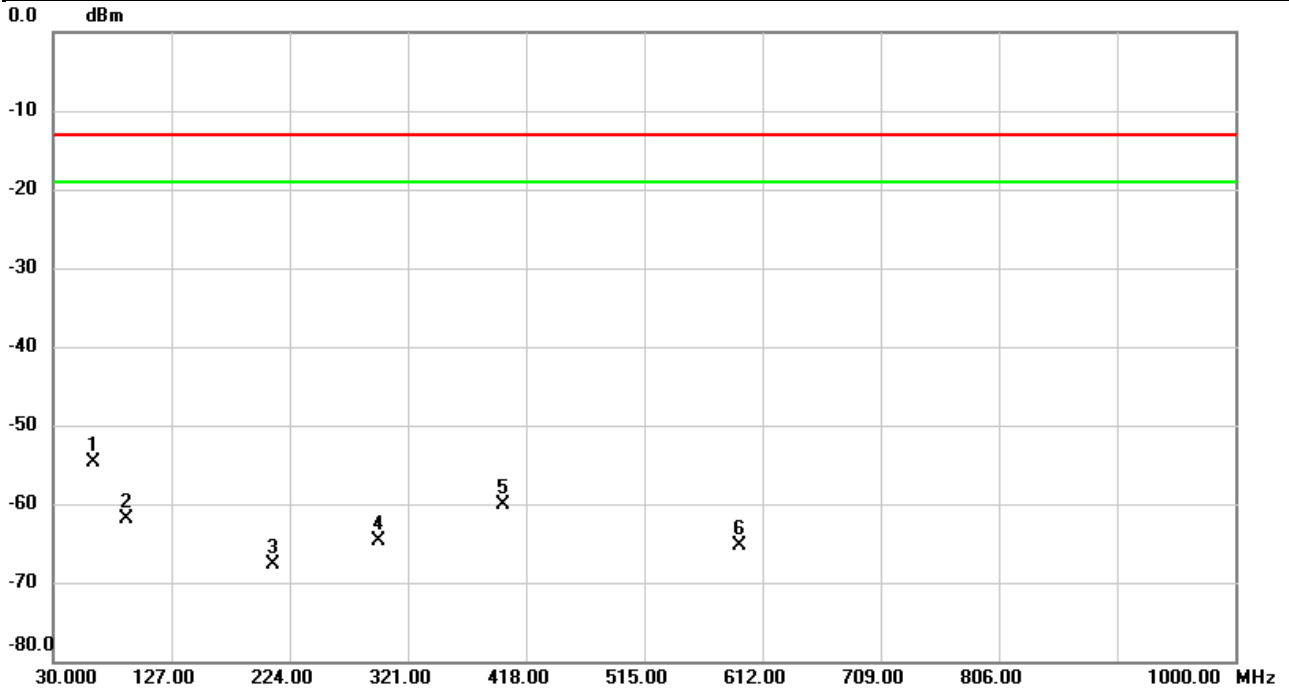

No.	Mk.	Freq.	Reading Level	Correct Factor	Measure-ment	Limit	Over	Detector	Comment
		MHz	dBm	dB	dBm	dBm	dB		
1	*	63.0123	-60.79	6.14	-54.65	-13.00	-41.65	peak	
2		89.8813	-65.61	3.68	-61.93	-13.00	-48.93	peak	
3		209.9673	-65.59	-2.05	-67.64	-13.00	-54.64	peak	
4		296.7175	-65.55	0.76	-64.79	-13.00	-51.79	peak	
5		399.8933	-66.19	6.18	-60.01	-13.00	-47.01	peak	
6		593.4083	-72.82	7.45	-65.37	-13.00	-52.37	peak	

REMARKS:

- (1) Measurement Value = Reading Level + Correct Factor.
- (2) Margin Level = Measurement Value - Limit Value.

Test Mode	LTE Band 17	Test Date	2021/3/25
Test Channel	CH23780	Polarization	Vertical
Temp	21°C	Hum.	68%

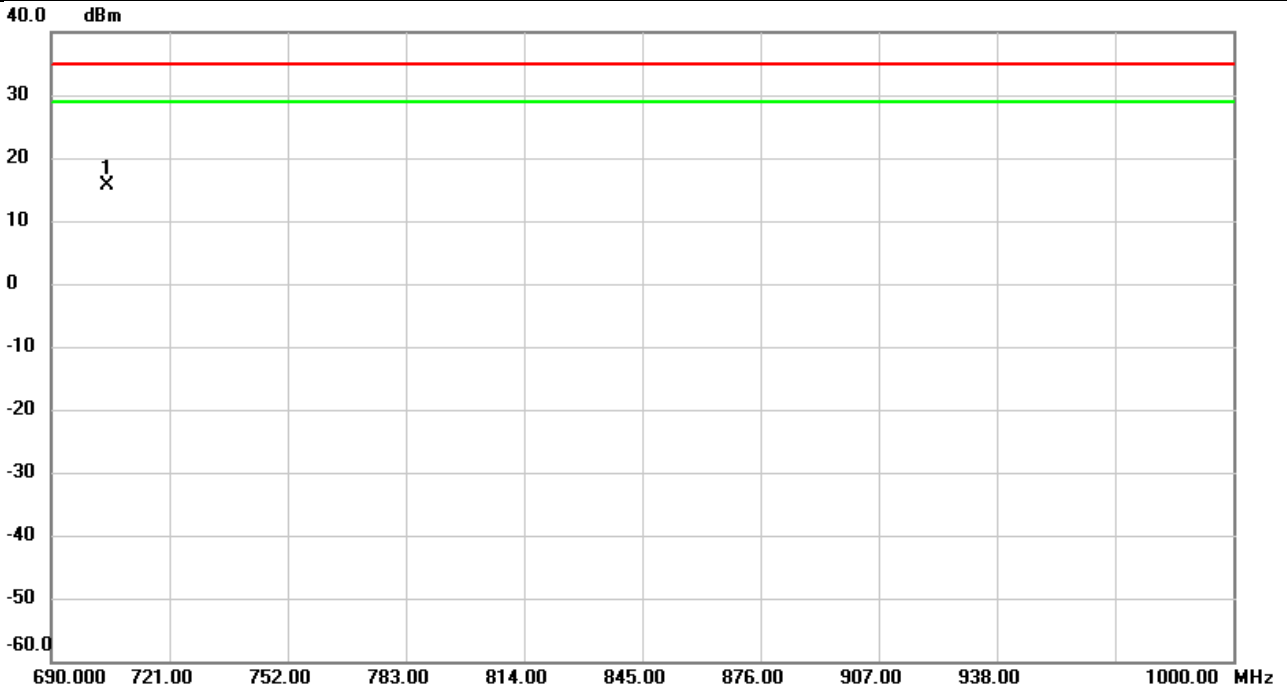

No.	Mk.	Freq.	Reading Level	Correct Factor	Measurement	Limit	Over	Detector	Comment
		MHz	dBm	dB	dBm	dBm	dB		
1	*	704.6423	-17.43	33.01	15.58	34.77	-19.19	peak	

REMARKS:

- (1) Measurement Value = Reading Level + Correct Factor.
- (2) Margin Level = Measurement Value - Limit Value.

Test Mode	LTE Band 17	Test Date	2021/3/25
Test Channel	CH23780	Polarization	Horizontal
Temp	21°C	Hum.	68%

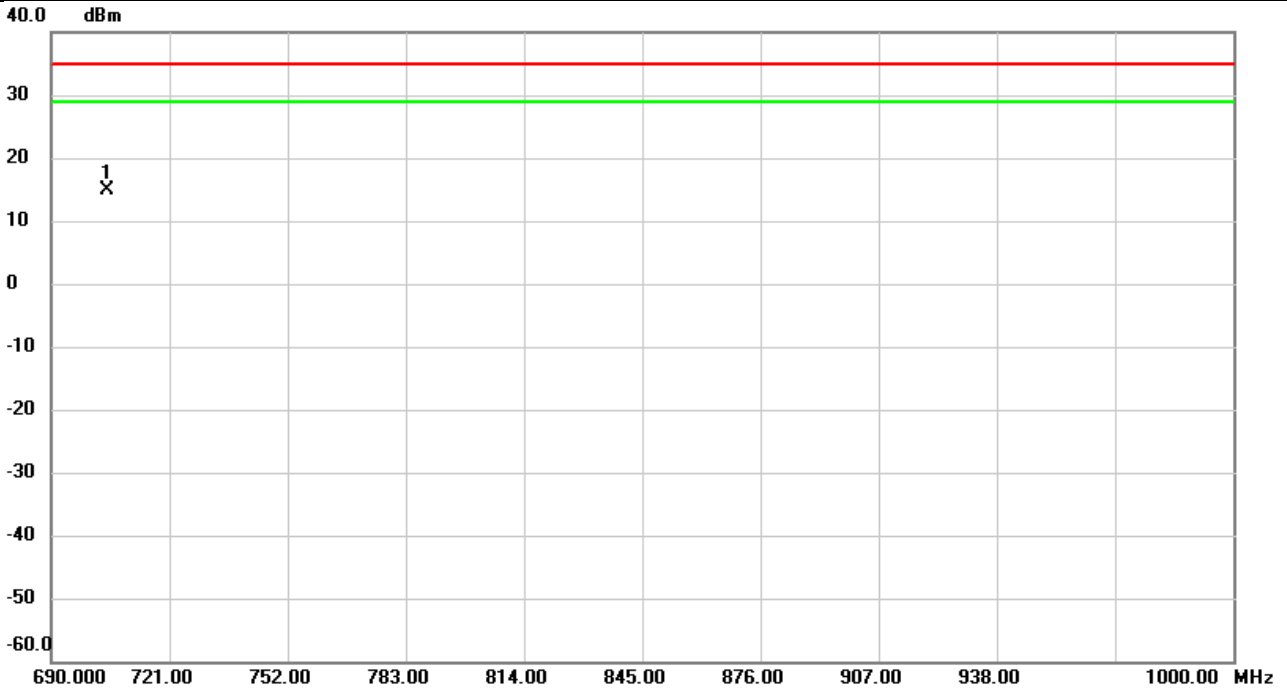

No.	Mk.	Freq.	Reading Level	Correct Factor	Measurement	Limit	Over	Detector	Comment
		MHz	dBm	dB	dBm	dBm	dB		
1	*	704.6216	-15.77	30.60	14.83	34.77	-19.94	peak	

REMARKS:

- (1) Measurement Value = Reading Level + Correct Factor.
- (2) Margin Level = Measurement Value - Limit Value.

Test Mode	LTE Band 17	Test Date	2021/3/25
Test Channel	CH23790	Polarization	Vertical
Temp	21°C	Hum.	68%

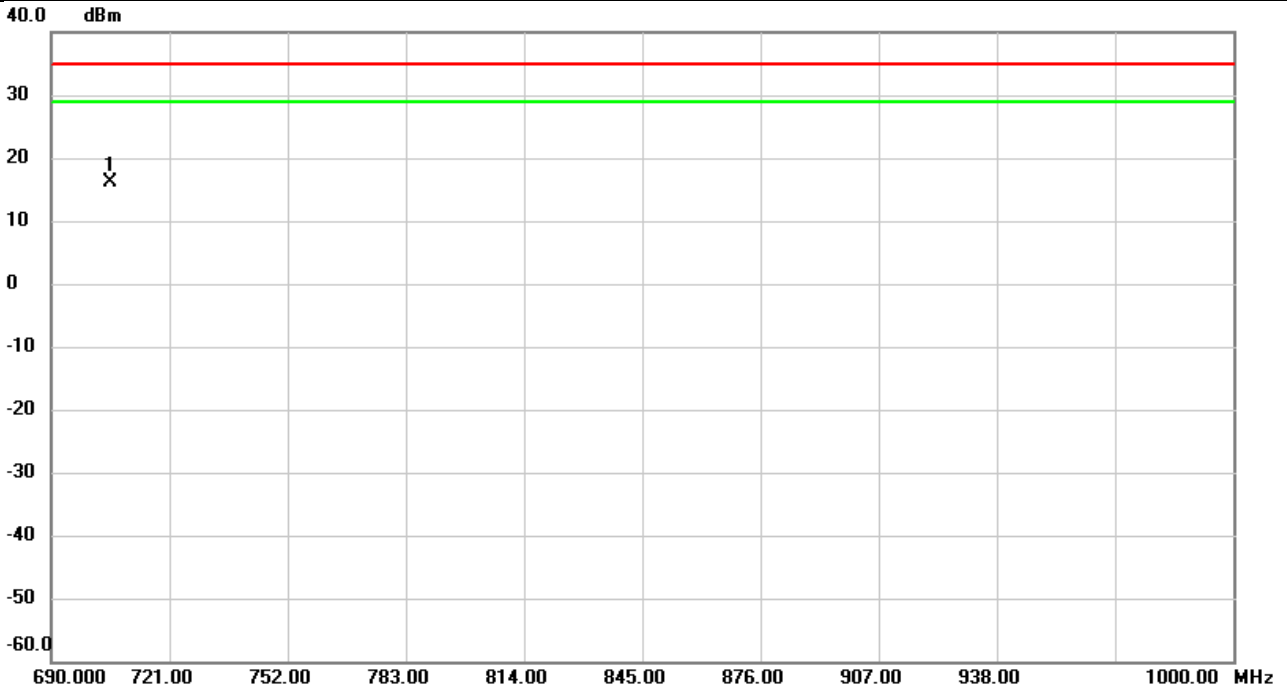

No.	Mk.	Freq.	Reading Level	Correct Factor	Measurement	Limit	Over	Detector	Comment
		MHz	dBm	dB	dBm	dBm	dB		
1	*	705.6137	-16.78	33.02	16.24	34.77	-18.53	peak	

REMARKS:

- (1) Measurement Value = Reading Level + Correct Factor.
- (2) Margin Level = Measurement Value - Limit Value.

Test Mode	LTE Band 17	Test Date	2021/3/25
Test Channel	CH23790	Polarization	Horizontal
Temp	21°C	Hum.	68%

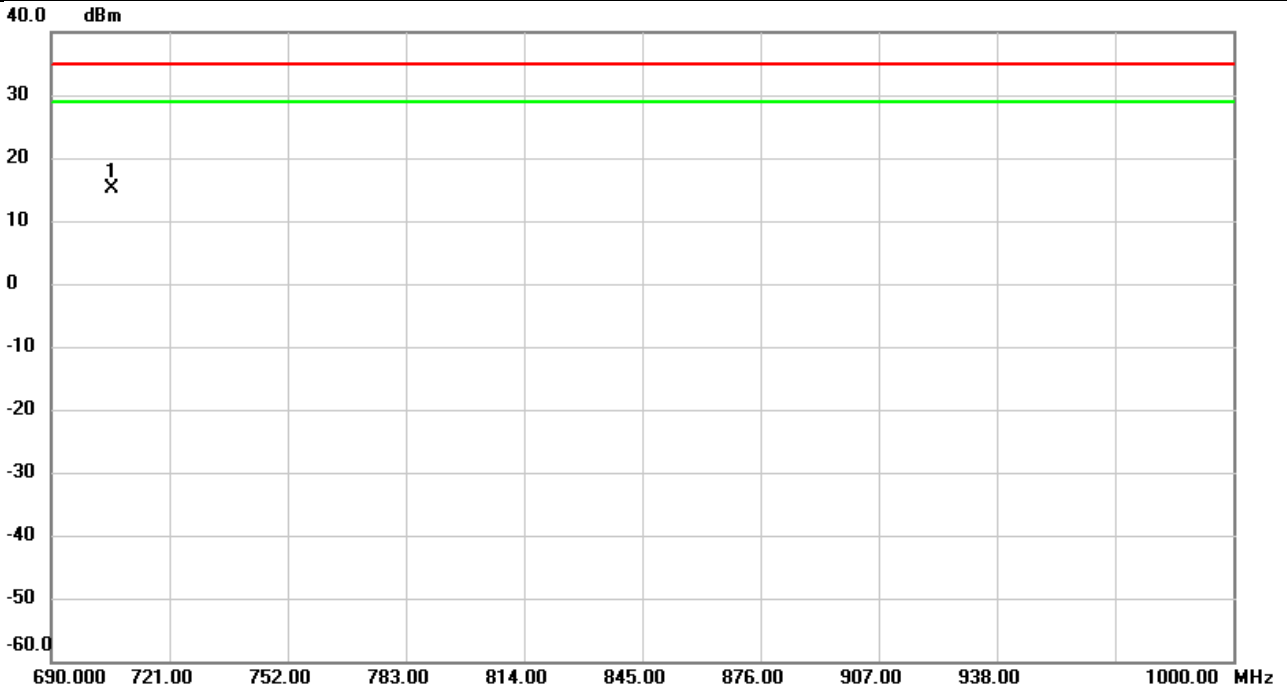

No.	Mk.	Freq.	Reading Level	Correct Factor	Measurement	Limit	Over	Detector	Comment
		MHz	dBm	dB	dBm	dBm	dB		
1	*	705.7273	-15.40	30.63	15.23	34.77	-19.54	peak	

REMARKS:

- (1) Measurement Value = Reading Level + Correct Factor.
- (2) Margin Level = Measurement Value - Limit Value.

Test Mode	LTE Band 17	Test Date	2021/3/25
Test Channel	CH23800	Polarization	Vertical
Temp	21°C	Hum.	68%

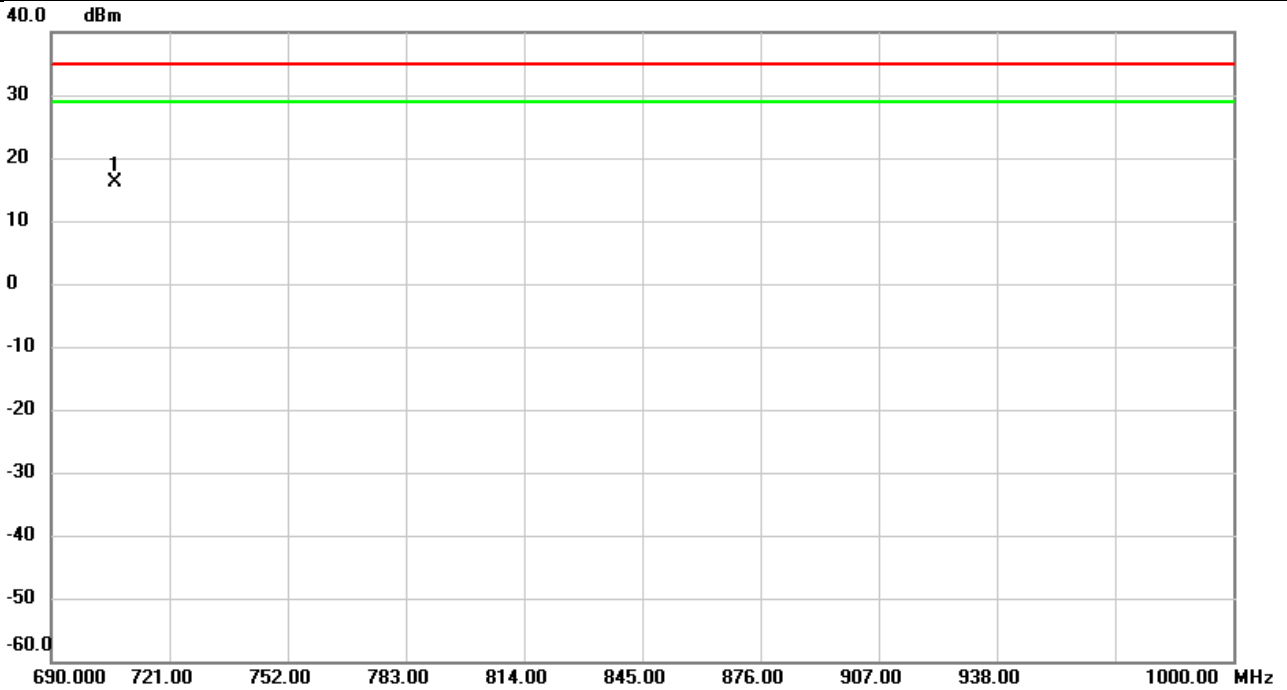

No.	Mk.	Freq.	Reading Level	Correct Factor	Measurement	Limit	Over	Detector	Comment
		MHz	dBm	dB	dBm	dBm	dB		
1	*	706.5540	-17.00	33.02	16.02	34.77	-18.75	peak	

REMARKS:

- (1) Measurement Value = Reading Level + Correct Factor.
- (2) Margin Level = Measurement Value - Limit Value.

Test Mode	LTE Band 17	Test Date	2021/3/25
Test Channel	CH23800	Polarization	Horizontal
Temp	21°C	Hum.	68%

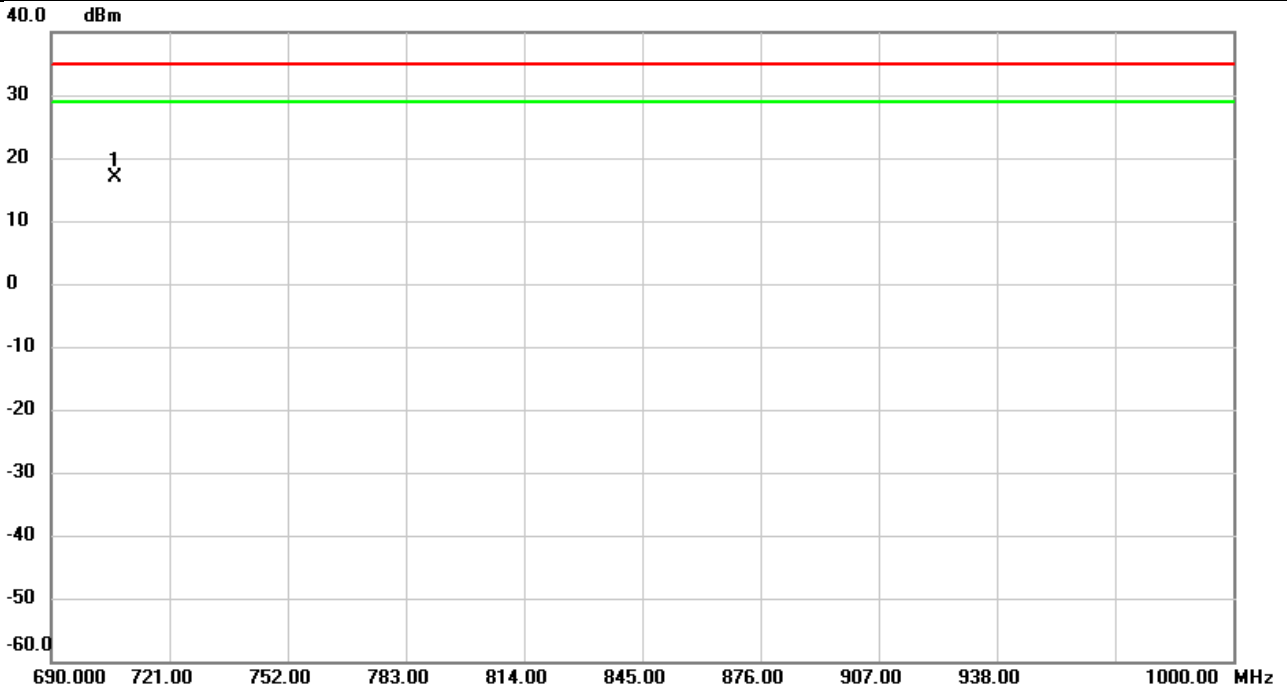

No.	Mk.	Freq.	Reading Level	Correct Factor	Measurement	Limit	Over	Detector	Comment
		MHz	dBm	dB	dBm	dBm	dB		
1	*	706.6367	-13.83	30.67	16.84	34.77	-17.93	peak	

REMARKS:

- (1) Measurement Value = Reading Level + Correct Factor.
- (2) Margin Level = Measurement Value - Limit Value.

Test Mode	LTE Band 17	Test Date	2021/3/25
Test Channel	CH23790	Polarization	Vertical
Temp	21°C	Hum.	68%

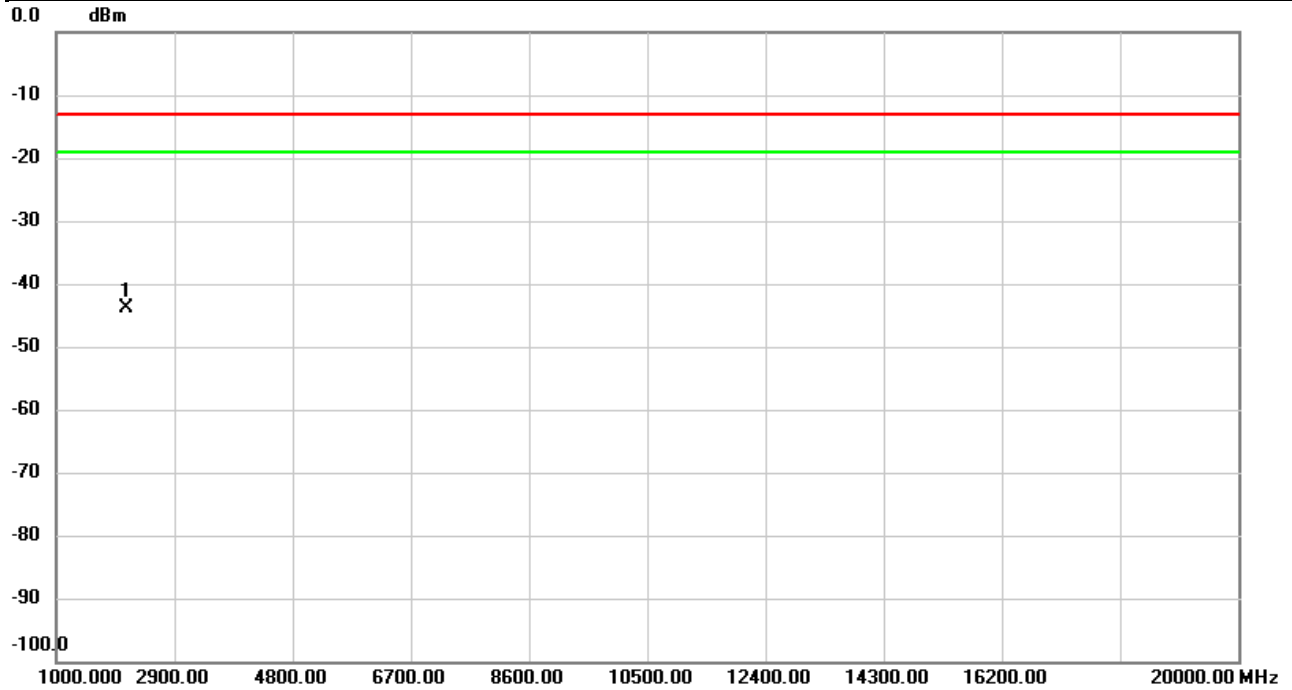

No.	Mk.	Freq.	Reading Level	Correct Factor	Measurement	Limit	Over	Detector	Comment
		MHz	dBm	dB	dBm	dBm	dB		
1	*	2117.200	-38.80	-5.04	-43.84	-13.00	-30.84	peak	

REMARKS:
 (1) Measurement Value = Reading Level + Correct Factor.
 (2) Margin Level = Measurement Value - Limit Value.

Test Mode	LTE Band 17	Test Date	2021/3/25
Test Channel	CH23790	Polarization	Horizontal
Temp	21°C	Hum.	68%

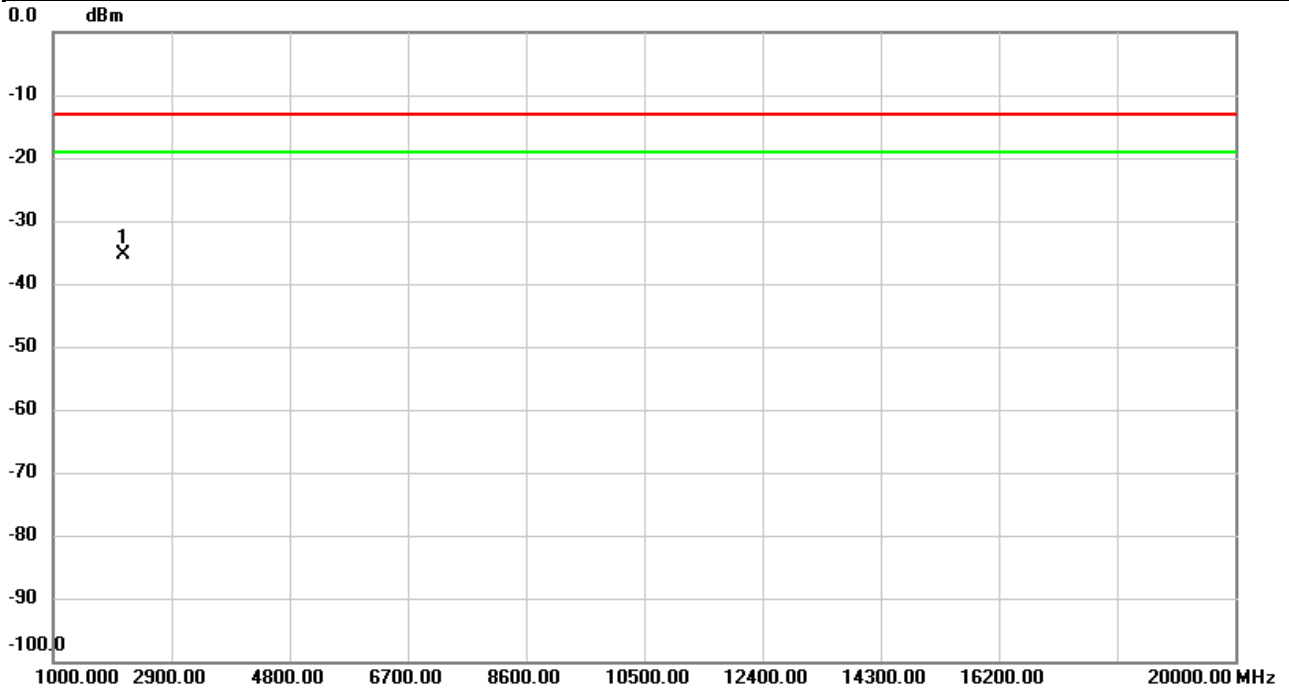

No.	Mk.	Freq.	Reading Level	Correct Factor	Measurement	Limit	Over	Detector	Comment
		MHz	dBm	dB	dBm	dBm	dB		
1	*	2117.200	-29.77	-5.51	-35.28	-13.00	-22.28	peak	

REMARKS:

- (1) Measurement Value = Reading Level + Correct Factor.
- (2) Margin Level = Measurement Value - Limit Value.

Test Mode	LTE Band 30	Test Date	2021/3/25
Test Channel	CH27710	Polarization	Vertical
Temp	21°C	Hum.	68%

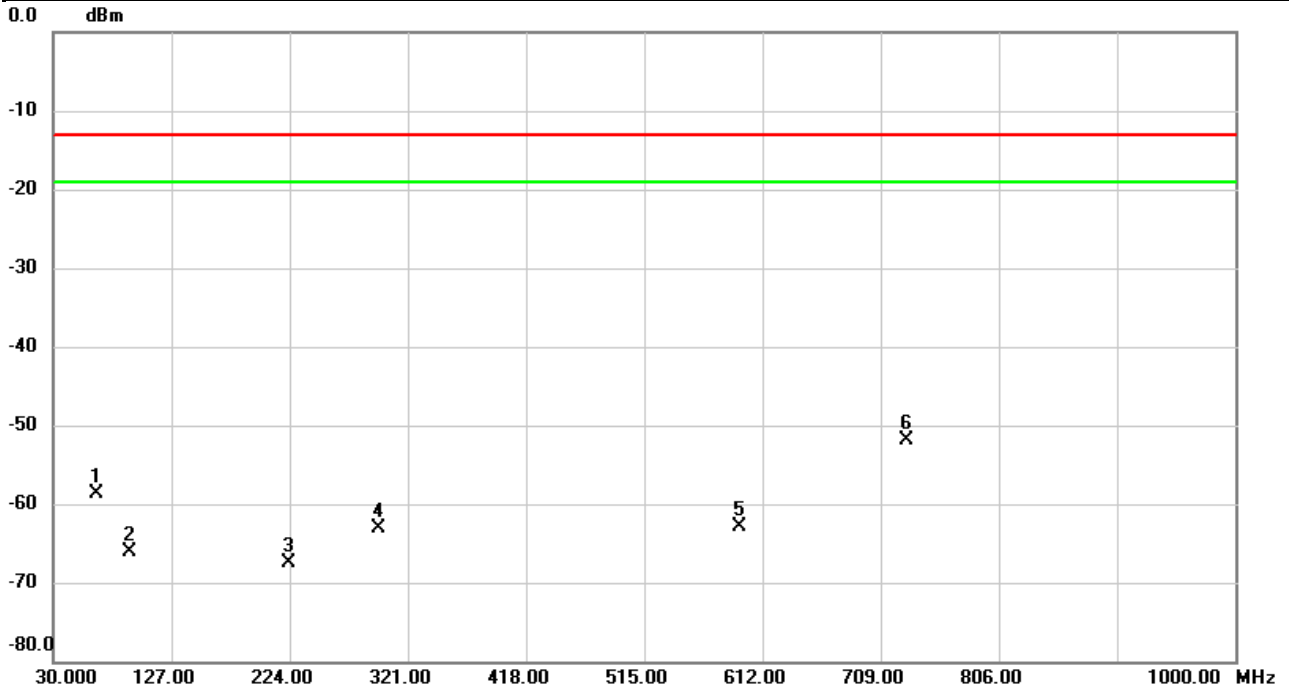

No.	Mk.	Freq. MHz	Reading Level dBm	Correct Factor dB	Measure- ment dBm	Limit dBm	Over dB	Detector	Comment
1		64.9200	-56.89	-1.87	-58.76	-13.00	-45.76	peak	
2		93.0500	-65.25	-0.85	-66.10	-13.00	-53.10	peak	
3		223.0300	-71.11	3.54	-67.57	-13.00	-54.57	peak	
4		296.7500	-70.77	7.62	-63.15	-13.00	-50.15	peak	
5		593.5700	-74.69	11.75	-62.94	-13.00	-49.94	peak	
6	*	730.3400	-63.94	11.99	-51.95	-13.00	-38.95	peak	

REMARKS:

- (1) Measurement Value = Reading Level + Correct Factor.
- (2) Margin Level = Measurement Value - Limit Value.

Test Mode	LTE Band 30	Test Date	2021/3/25
Test Channel	CH27710	Polarization	Horizontal
Temp	21°C	Hum.	68%

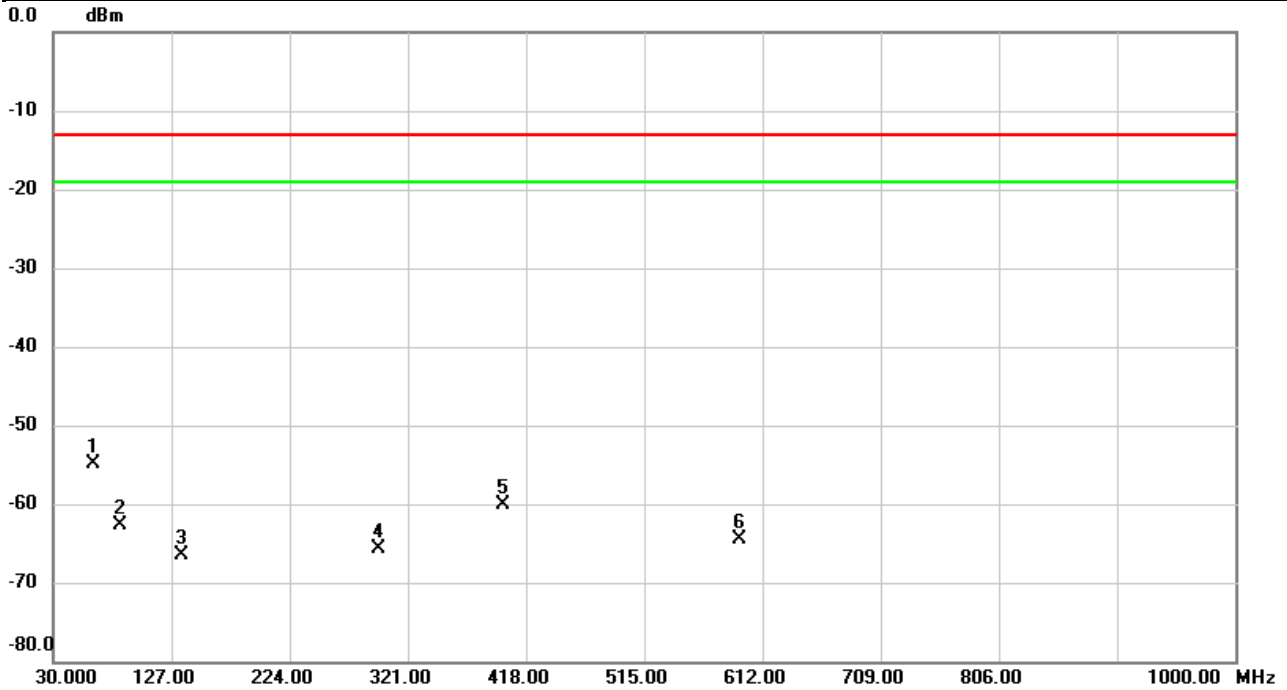

No.	Mk.	Freq.	Reading Level	Correct Factor	Measurement	Limit	Over	Detector	Comment
		MHz	dBm	dB	dBm	dBm	dB		
1	*	62.9800	-60.99	6.15	-54.84	-13.00	-41.84	peak	
2		84.3200	-67.61	4.85	-62.76	-13.00	-49.76	peak	
3		135.7300	-69.28	2.78	-66.50	-13.00	-53.50	peak	
4		296.7500	-66.48	0.76	-65.72	-13.00	-52.72	peak	
5		398.6000	-66.28	6.12	-60.16	-13.00	-47.16	peak	
6		593.5700	-71.97	7.44	-64.53	-13.00	-51.53	peak	

REMARKS:

- (1) Measurement Value = Reading Level + Correct Factor.
- (2) Margin Level = Measurement Value - Limit Value.

Test Mode	LTE Band 30	Test Date	2021/3/29
Test Channel	CH27710	Polarization	Vertical
Temp	22°C	Hum.	67%

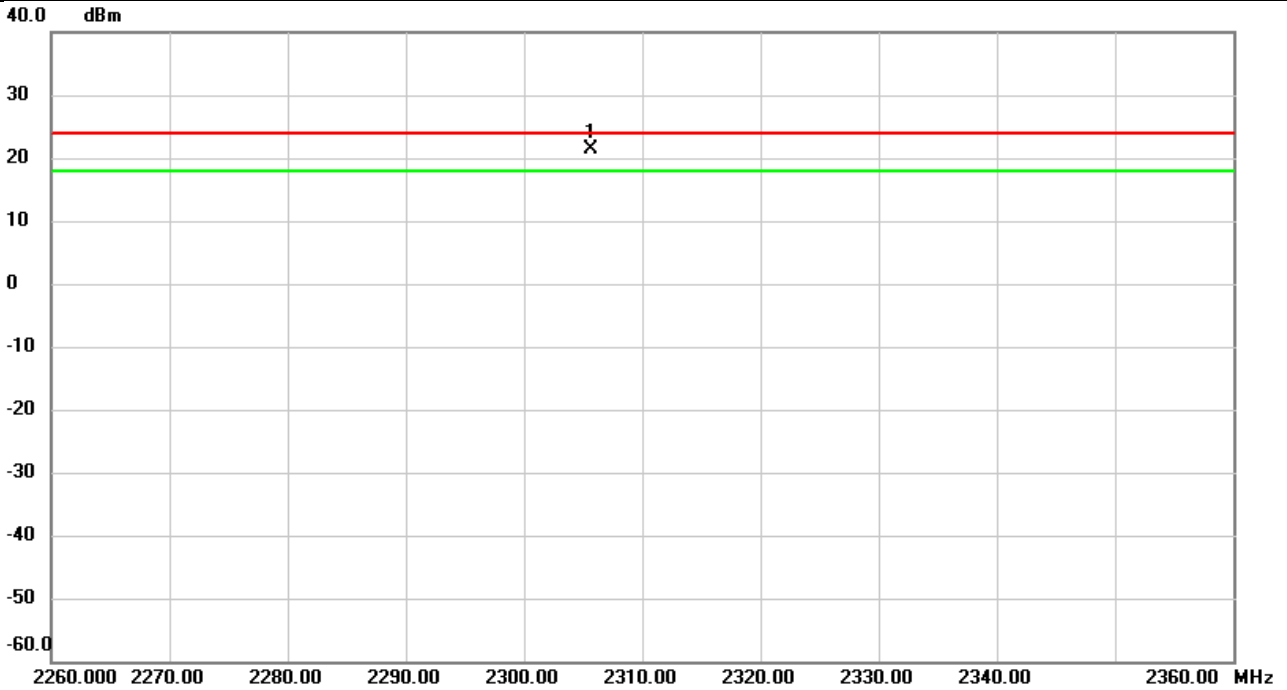

No.	Mk.	Freq.	Reading Level	Correct Factor	Measurement	Limit	Over	Detector	Comment
		MHz	dBm	dB	dBm	dBm	dB		
1	*	2305.623	-20.15	41.55	21.40	23.98	-2.58	peak	

REMARKS:

- (1) Measurement Value = Reading Level + Correct Factor.
- (2) Margin Level = Measurement Value - Limit Value.

Test Mode	LTE Band 30	Test Date	2021/3/29
Test Channel	CH27710	Polarization	Horizontal
Temp	22°C	Hum.	67%

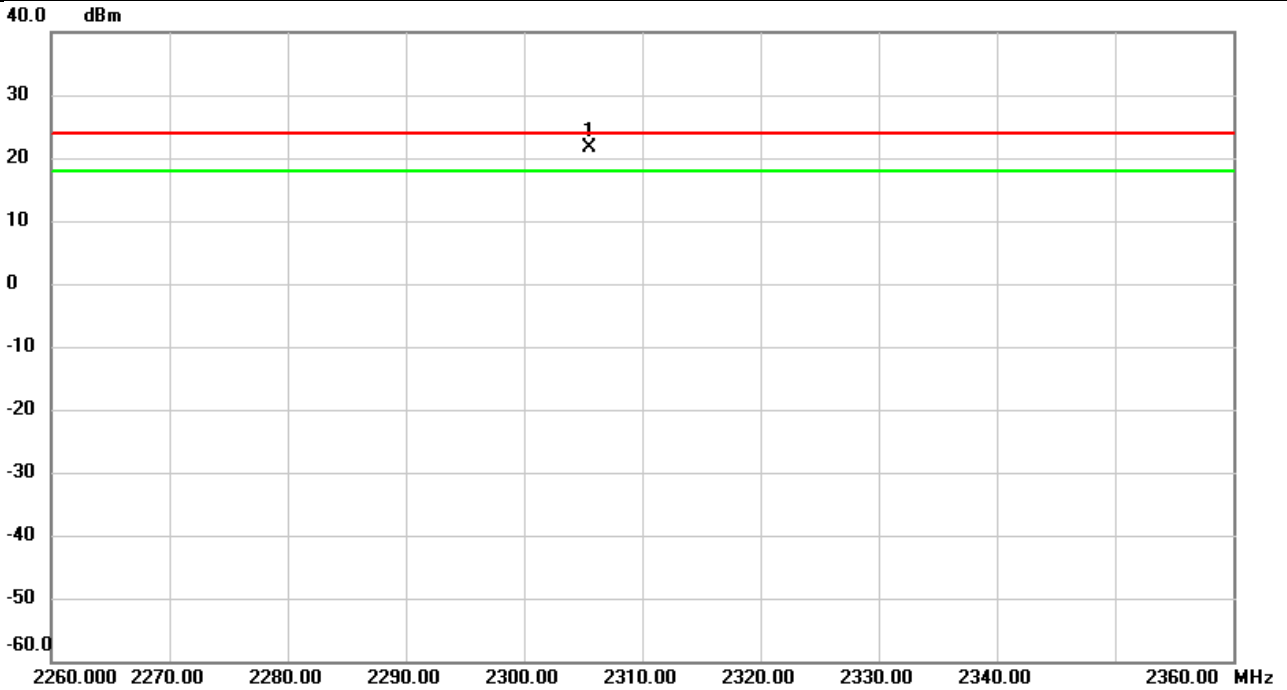

No.	Mk.	Freq.	Reading Level	Correct Factor	Measurement	Limit	Over	Detector	Comment
		MHz	dBm	dB	dBm	dBm	dB		
1	*	2305.493	-19.81	41.56	21.75	23.98	-2.23	peak	

REMARKS:

- (1) Measurement Value = Reading Level + Correct Factor.
- (2) Margin Level = Measurement Value - Limit Value.

Test Mode	LTE Band 30	Test Date	2021/3/24
Test Channel	CH27710	Polarization	Vertical
Temp	21°C	Hum.	68%

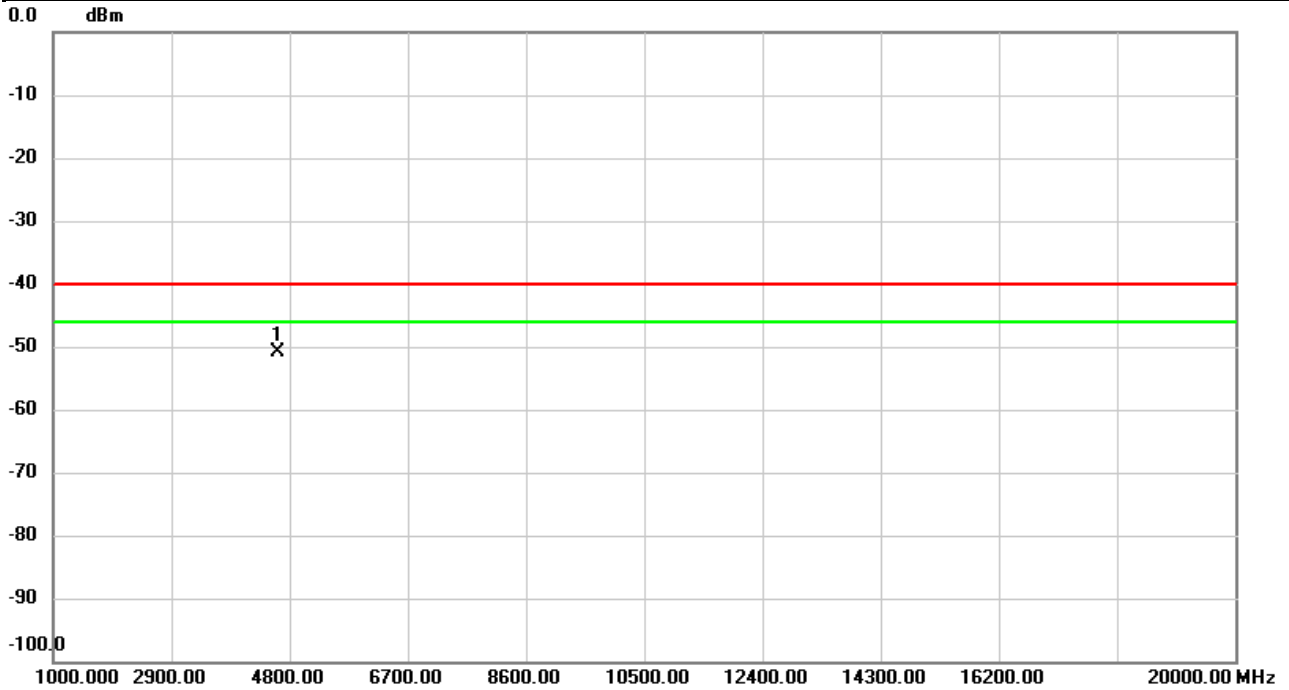

No.	Mk.	Freq.	Reading Level	Correct Factor	Measurement	Limit	Over	Detector	Comment
		MHz	dBm	dB	dBm	dBm	dB		
1	*	4610.000	-51.41	0.43	-50.98	-40.00	-10.98	peak	

REMARKS:

- (1) Measurement Value = Reading Level + Correct Factor.
- (2) Margin Level = Measurement Value - Limit Value.

Test Mode	LTE Band 30	Test Date	2021/3/24
Test Channel	CH27710	Polarization	Horizontal
Temp	21°C	Hum.	68%

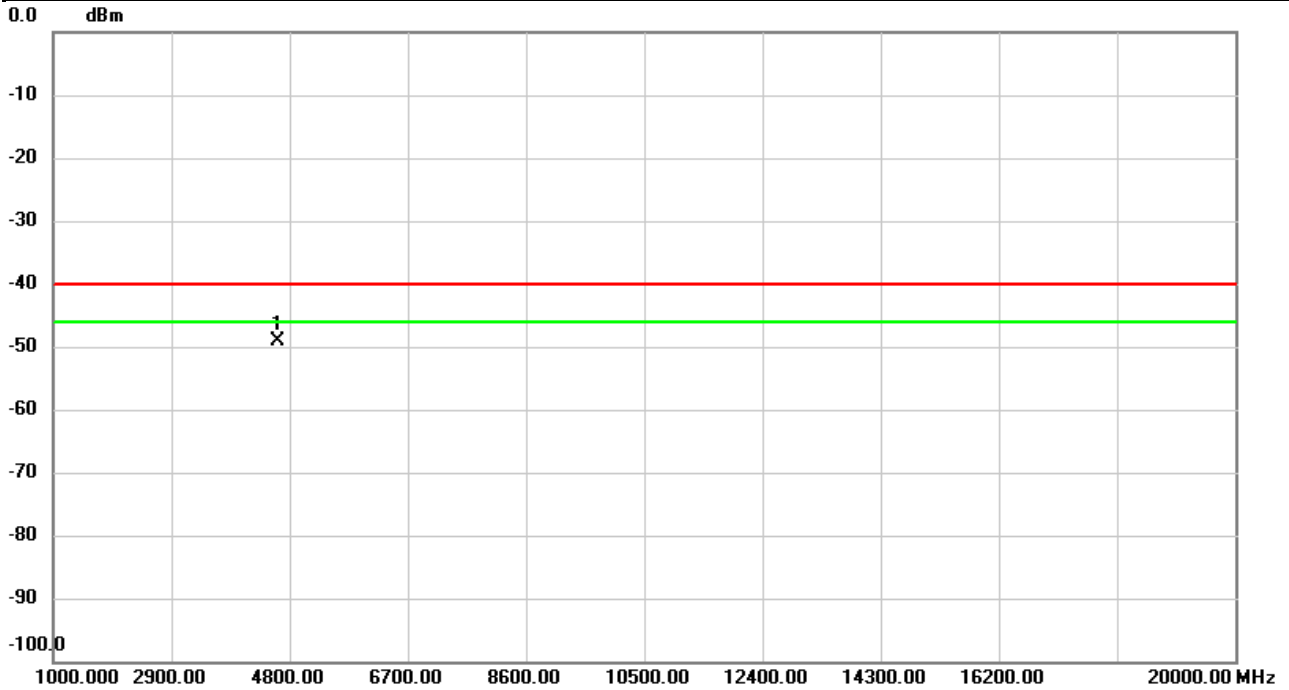

No.	Mk.	Freq.	Reading Level	Correct Factor	Measurement	Limit	Over	Detector	Comment
		MHz	dBm	dB	dBm	dBm	dB		
1	*	4610.000	-50.65	1.49	-49.16	-40.00	-9.16	peak	

REMARKS:

- (1) Measurement Value = Reading Level + Correct Factor.
- (2) Margin Level = Measurement Value - Limit Value.

Test Mode	LTE Band 41	Test Date	2021/3/25
Test Channel	CH40620	Polarization	Vertical
Temp	21°C	Hum.	68%

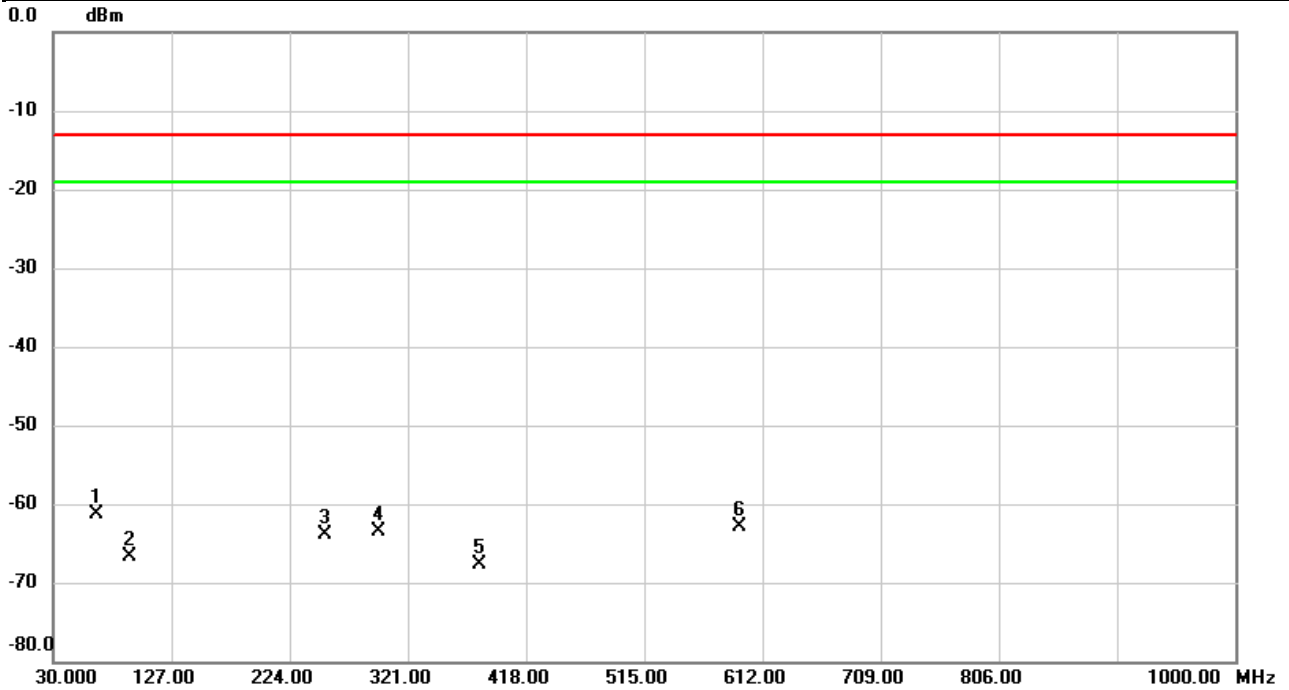

No.	Mk.	Freq.	Reading Level	Correct Factor	Measurement	Limit	Over	Detector	Comment
		MHz	dBm	dB	dBm	dBm	dB		
1	*	64.9200	-59.34	-1.87	-61.21	-13.00	-48.21	peak	
2		93.0500	-65.91	-0.85	-66.76	-13.00	-53.76	peak	
3		253.1000	-71.70	7.72	-63.98	-13.00	-50.98	peak	
4		296.7500	-71.09	7.62	-63.47	-13.00	-50.47	peak	
5		379.2000	-71.96	4.17	-67.79	-13.00	-54.79	peak	
6		593.5700	-74.69	11.75	-62.94	-13.00	-49.94	peak	

REMARKS:

- (1) Measurement Value = Reading Level + Correct Factor.
- (2) Margin Level = Measurement Value - Limit Value.

Test Mode	LTE Band 41	Test Date	2021/3/25
Test Channel	CH40620	Polarization	Horizontal
Temp	21°C	Hum.	68%

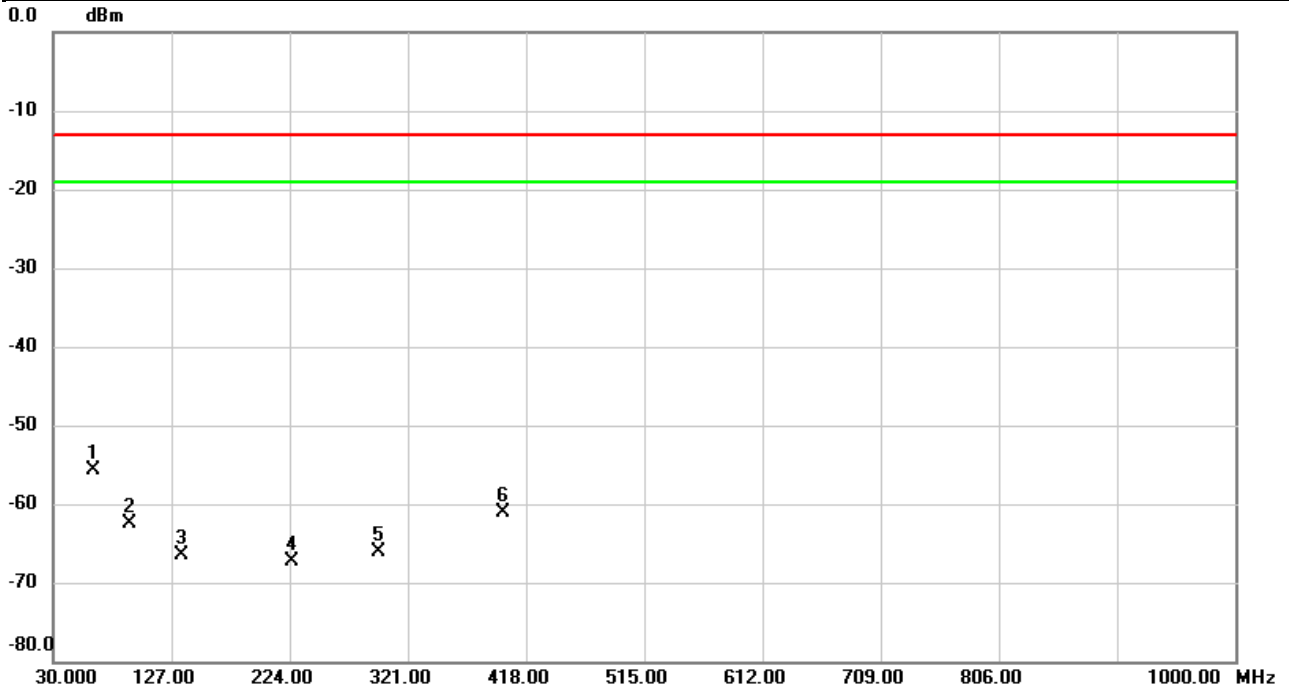

No.	Mk.	Freq.	Reading Level	Correct Factor	Measurement	Limit	Over	Detector	Comment
		MHz	dBm	dB	dBm	dBm	dB		
1	*	62.9800	-61.85	6.15	-55.70	-13.00	-42.70	peak	
2		92.0800	-66.19	3.60	-62.59	-13.00	-49.59	peak	
3		134.7600	-69.26	2.79	-66.47	-13.00	-53.47	peak	
4		225.9400	-66.55	-0.76	-67.31	-13.00	-54.31	peak	
5		296.7500	-66.77	0.76	-66.01	-13.00	-53.01	peak	
6		398.6000	-67.14	6.12	-61.02	-13.00	-48.02	peak	

REMARKS:

- (1) Measurement Value = Reading Level + Correct Factor.
- (2) Margin Level = Measurement Value - Limit Value.

Test Mode	LTE Band 41	Test Date	2021/3/24
Test Channel	CH39750	Polarization	Vertical
Temp	21°C	Hum.	68%

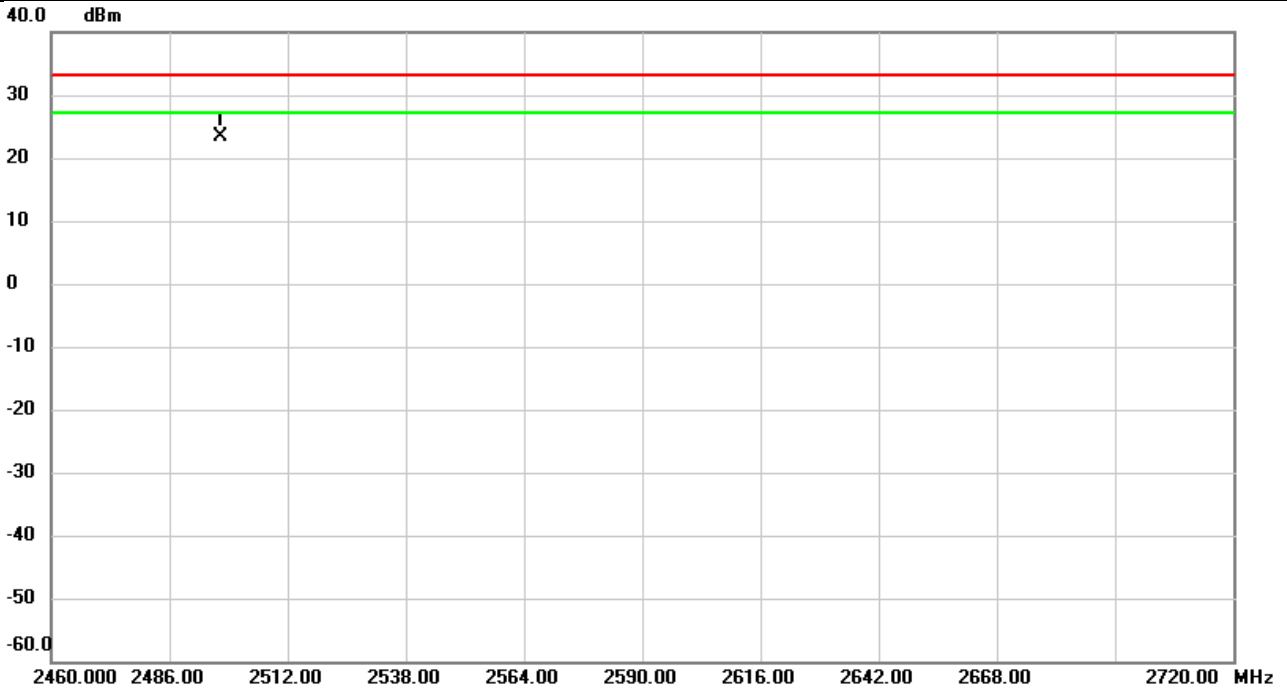

No.	Mk.	Freq.	Reading Level	Correct Factor	Measurement	Limit	Over	Detector	Comment
		MHz	dBm	dB	dBm	dBm	dB		
1	*	2497.111	-18.64	42.08	23.44	33.01	-9.57	peak	

REMARKS:

- (1) Measurement Value = Reading Level + Correct Factor.
- (2) Margin Level = Measurement Value - Limit Value.

Test Mode	LTE Band 41	Test Date	2021/3/24
Test Channel	CH39750	Polarization	Horizontal
Temp	21°C	Hum.	68%

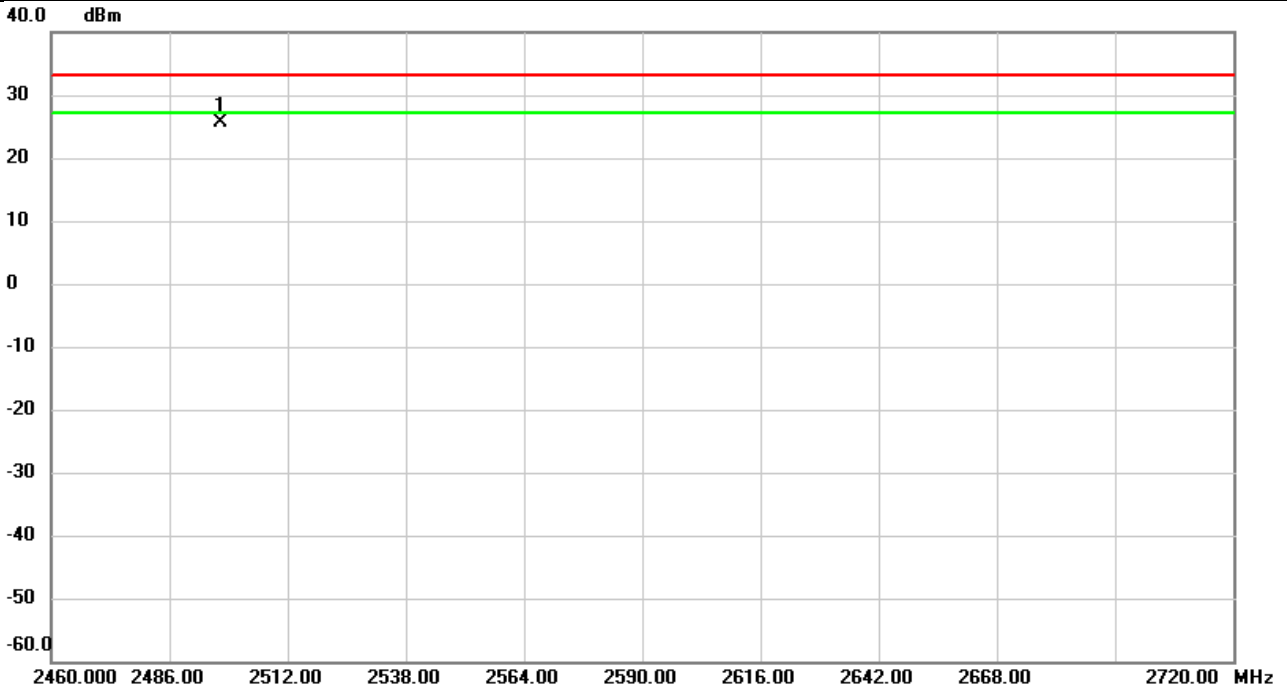

No.	Mk.	Freq.	Reading Level	Correct Factor	Measurement	Limit	Over	Detector	Comment
		MHz	dBm	dB	dBm	dBm	dB		
1	*	2497.223	-16.14	41.82	25.68	33.01	-7.33	peak	

REMARKS:

- (1) Measurement Value = Reading Level + Correct Factor.
- (2) Margin Level = Measurement Value - Limit Value.

Test Mode	LTE Band 41	Test Date	2021/3/24
Test Channel	CH40620	Polarization	Vertical
Temp	21°C	Hum.	68%

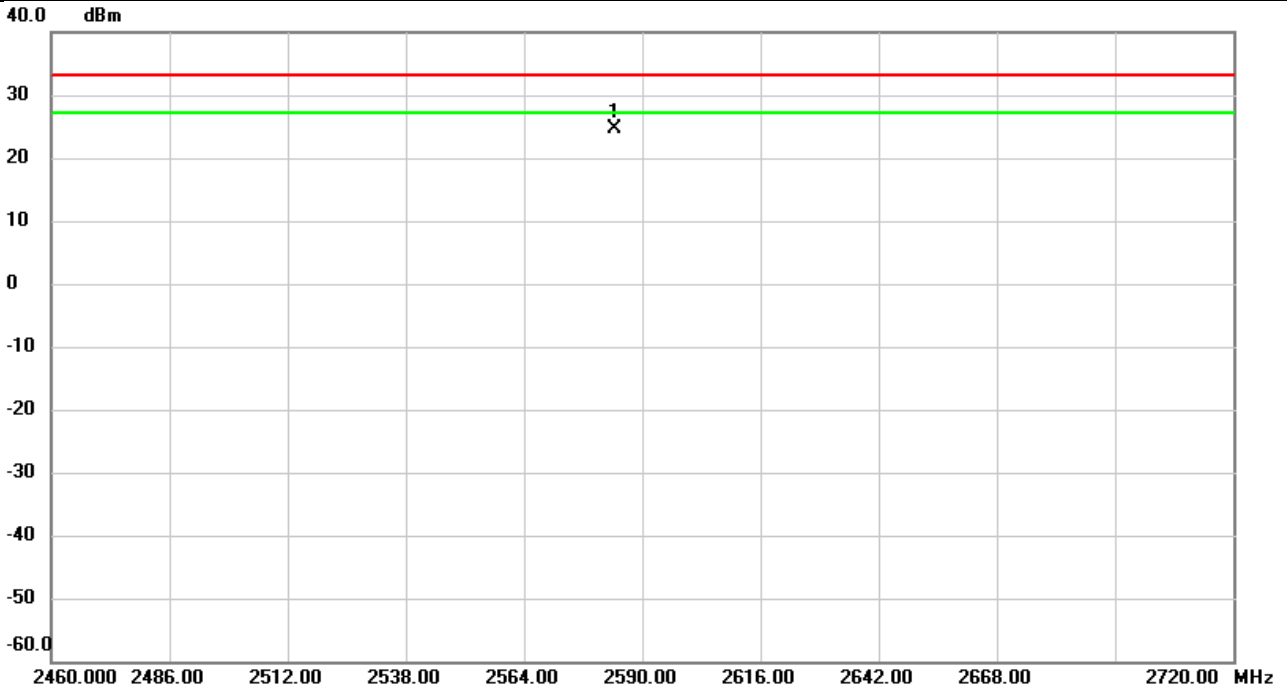

No.	Mk.	Freq.	Reading Level	Correct Factor	Measurement	Limit	Over	Detector	Comment
		MHz	dBm	dB	dBm	dBm	dB		
1	*	2584.072	-17.58	42.14	24.56	33.01	-8.45	peak	

REMARKS:

- (1) Measurement Value = Reading Level + Correct Factor.
- (2) Margin Level = Measurement Value - Limit Value.

Test Mode	LTE Band 41	Test Date	2021/3/24
Test Channel	CH40620	Polarization	Horizontal
Temp	21°C	Hum.	68%

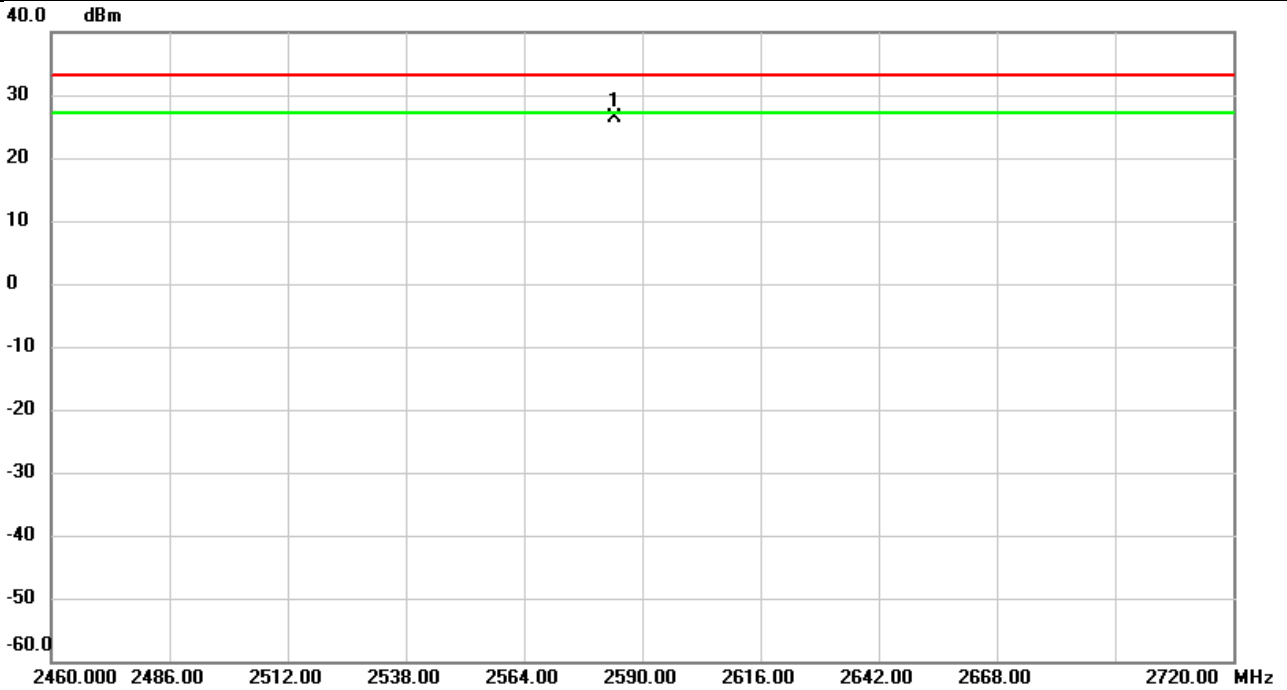

No.	Mk.	Freq.	Reading Level	Correct Factor	Measurement	Limit	Over	Detector	Comment
		MHz	dBm	dB	dBm	dBm	dB		
1	*	2584.046	-15.82	42.22	26.40	33.01	-6.61	peak	

REMARKS:

- (1) Measurement Value = Reading Level + Correct Factor.
- (2) Margin Level = Measurement Value - Limit Value.

Test Mode	LTE Band 41	Test Date	2021/3/24
Test Channel	CH41490	Polarization	Vertical
Temp	21°C	Hum.	68%

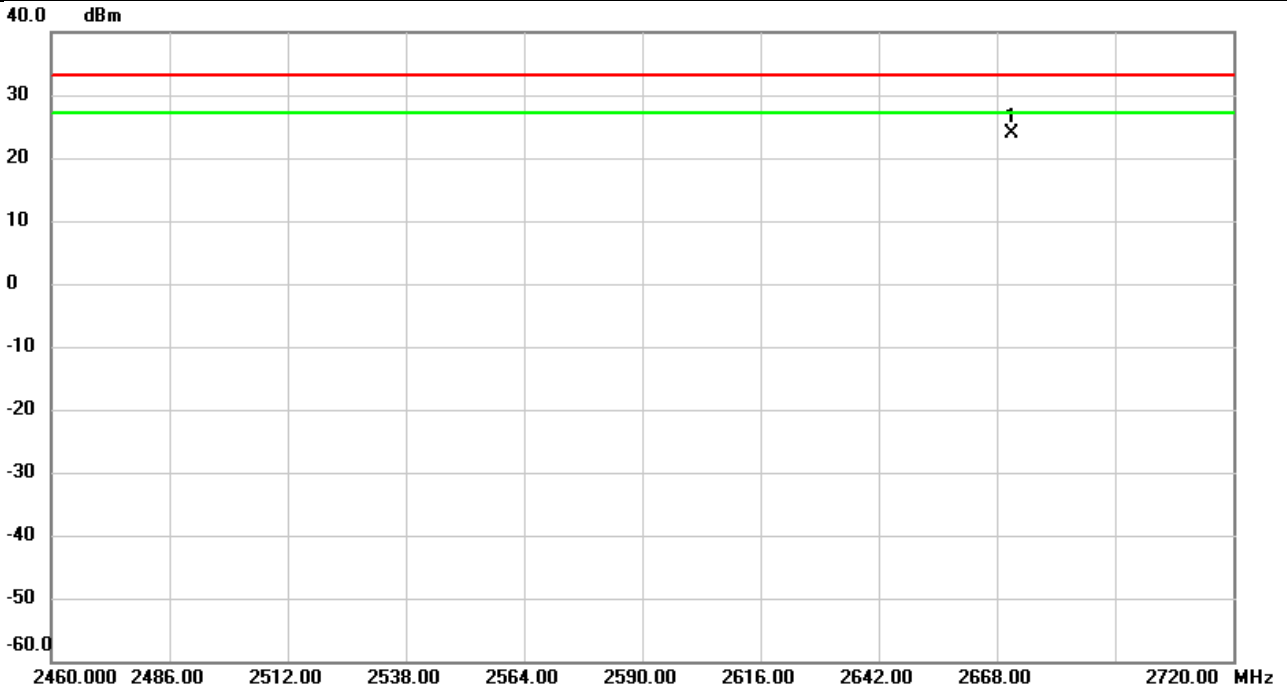

No.	Mk.	Freq.	Reading Level	Correct Factor	Measurement	Limit	Over	Detector	Comment
		MHz	dBm	dB	dBm	dBm	dB		
1	*	2671.259	-18.40	42.18	23.78	33.01	-9.23	peak	

REMARKS:

- (1) Measurement Value = Reading Level + Correct Factor.
- (2) Margin Level = Measurement Value - Limit Value.

Test Mode	LTE Band 41	Test Date	2021/3/24
Test Channel	CH41490	Polarization	Horizontal
Temp	21°C	Hum.	68%

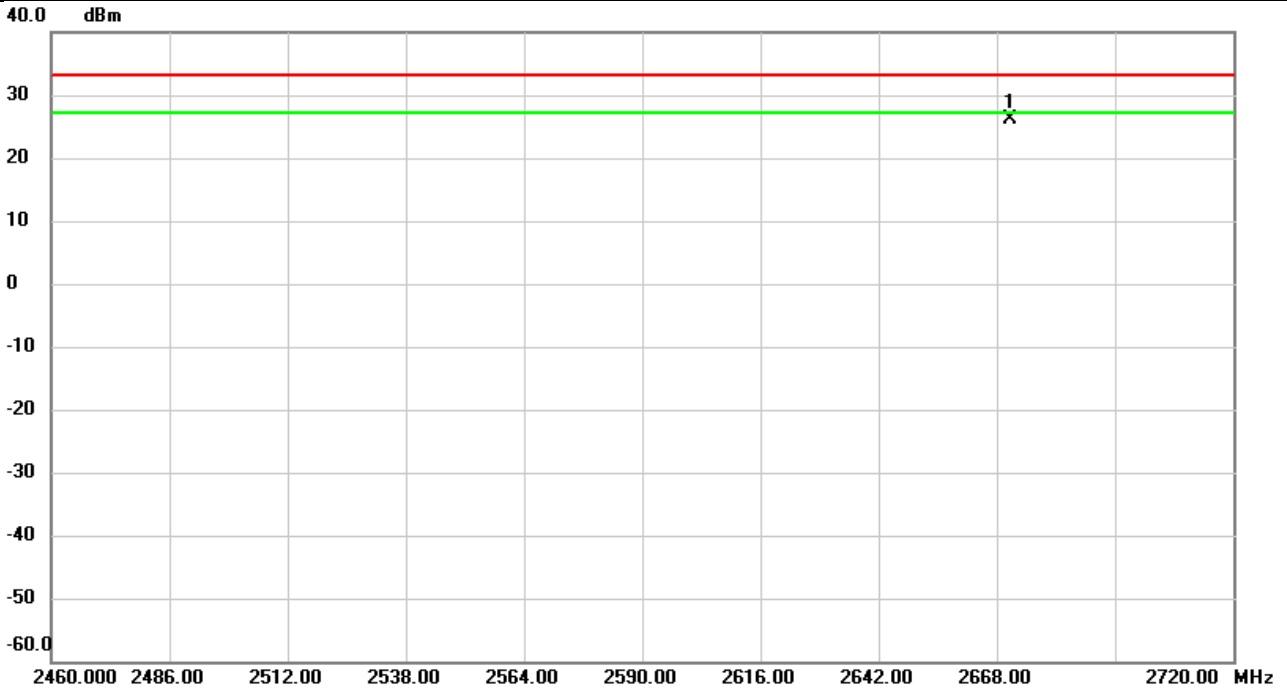

No.	Mk.	Freq.	Reading Level	Correct Factor	Measurement	Limit	Over	Detector	Comment
		MHz	dBm	dB	dBm	dBm	dB		
1	*	2671.120	-16.55	42.63	26.08	33.01	-6.93	peak	

REMARKS:

- (1) Measurement Value = Reading Level + Correct Factor.
- (2) Margin Level = Measurement Value - Limit Value.

Test Mode	LTE Band 41	Test Date	2021/3/24
Test Channel	CH40620	Polarization	Vertical
Temp	21°C	Hum.	68%

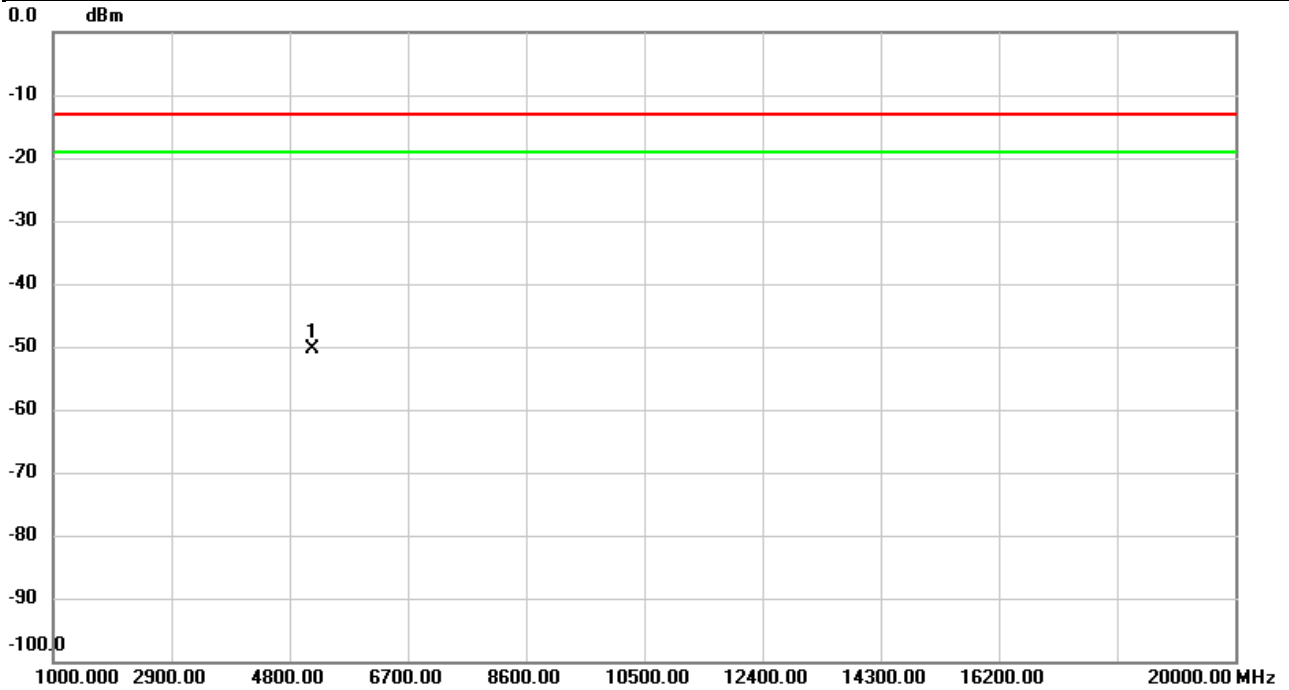

No.	Mk.	Freq.	Reading Level	Correct Factor	Measurement	Limit	Over	Detector	Comment
		MHz	dBm	dB	dBm	dBm	dB		
1	*	5168.000	-52.16	1.82	-50.34	-13.00	-37.34	peak	

REMARKS:

- (1) Measurement Value = Reading Level + Correct Factor.
- (2) Margin Level = Measurement Value - Limit Value.

Test Mode	LTE Band 41	Test Date	2021/3/24
Test Channel	CH40620	Polarization	Horizontal
Temp	21°C	Hum.	68%

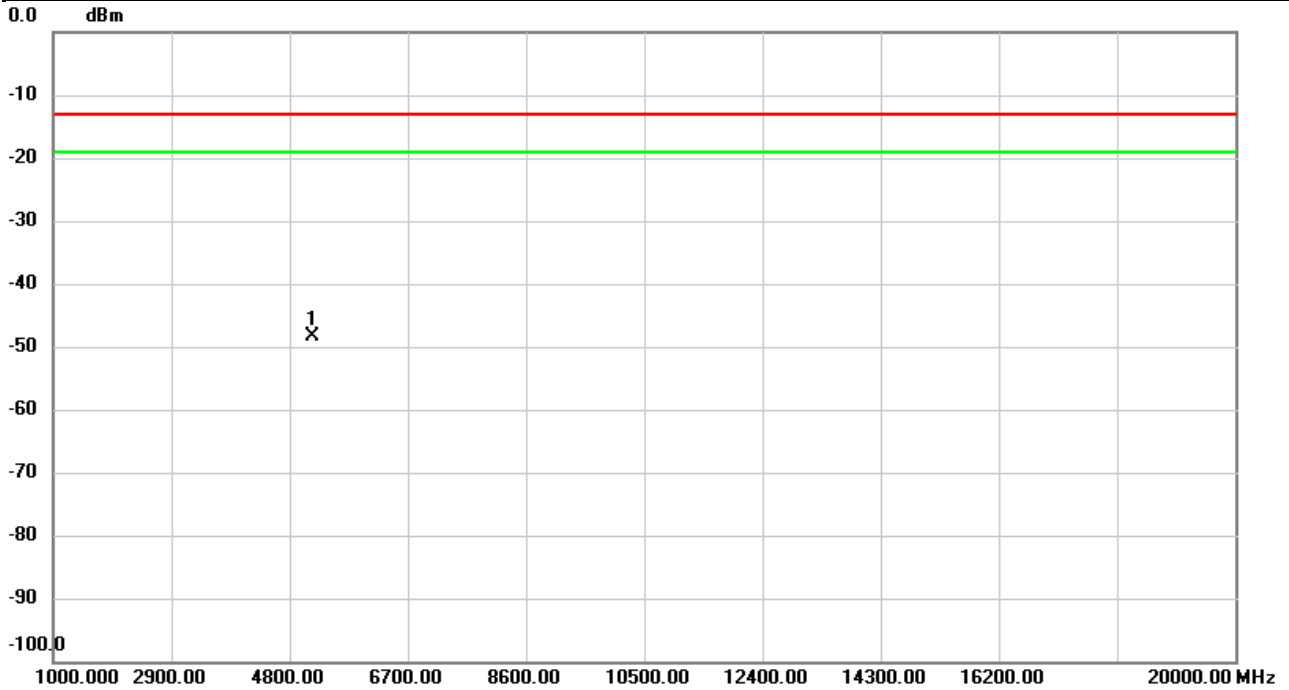

No.	Mk.	Freq.	Reading Level	Correct Factor	Measurement	Limit	Over	Detector	Comment
		MHz	dBm	dB	dBm	dBm	dB		
1	*	5168.000	-50.75	2.37	-48.38	-13.00	-35.38	peak	

REMARKS:

- (1) Measurement Value = Reading Level + Correct Factor.
- (2) Margin Level = Measurement Value - Limit Value.

Test Mode	LTE Band 66	Test Date	2021/3/25
Test Channel	CH132322	Polarization	Vertical
Temp	21°C	Hum.	68%

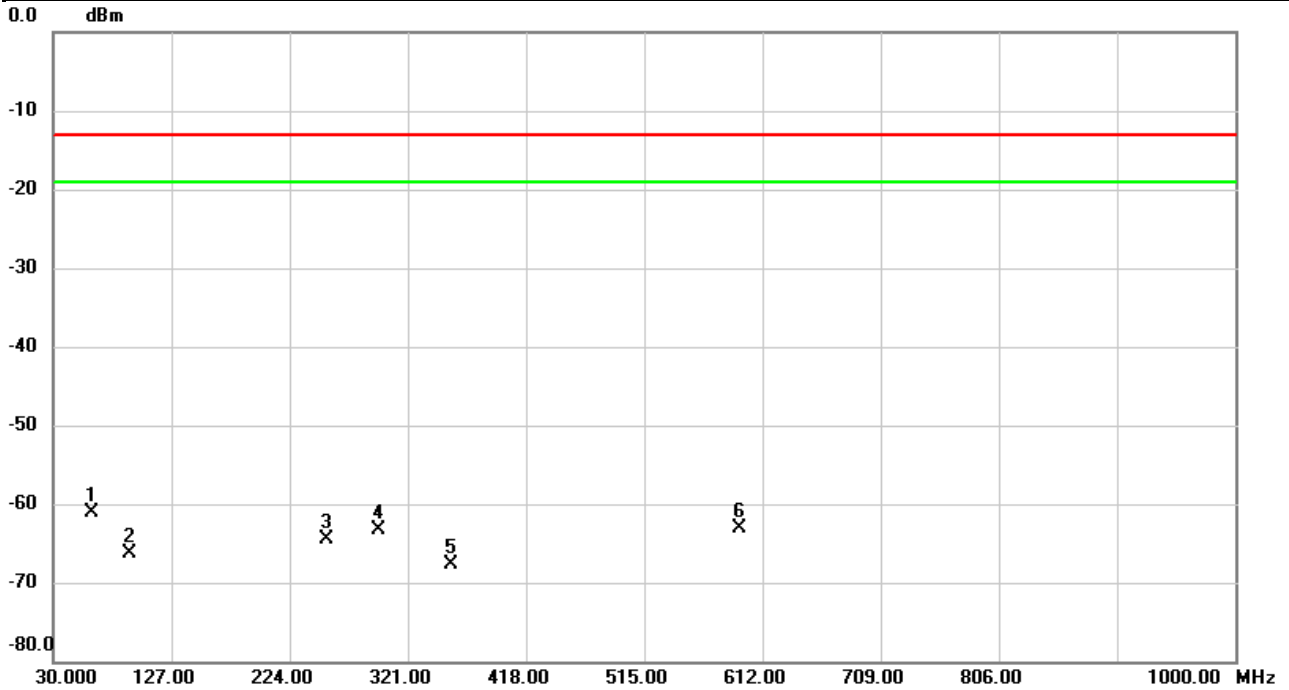

No.	Mk.	Freq.	Reading Level	Correct Factor	Measurement	Limit	Over	Detector	Comment
		MHz	dBm	dB	dBm	dBm	dB		
1	*	61.0400	-59.69	-1.44	-61.13	-13.00	-48.13	peak	
2		93.0500	-65.50	-0.85	-66.35	-13.00	-53.35	peak	
3		254.0700	-72.30	7.72	-64.58	-13.00	-51.58	peak	
4		296.7500	-70.96	7.62	-63.34	-13.00	-50.34	peak	
5		355.9200	-73.85	6.14	-67.71	-13.00	-54.71	peak	
6		593.5700	-74.82	11.75	-63.07	-13.00	-50.07	peak	

REMARKS:

- (1) Measurement Value = Reading Level + Correct Factor.
- (2) Margin Level = Measurement Value - Limit Value.

Test Mode	LTE Band 66	Test Date	2021/3/25
Test Channel	CH132322	Polarization	Horizontal
Temp	21°C	Hum.	68%

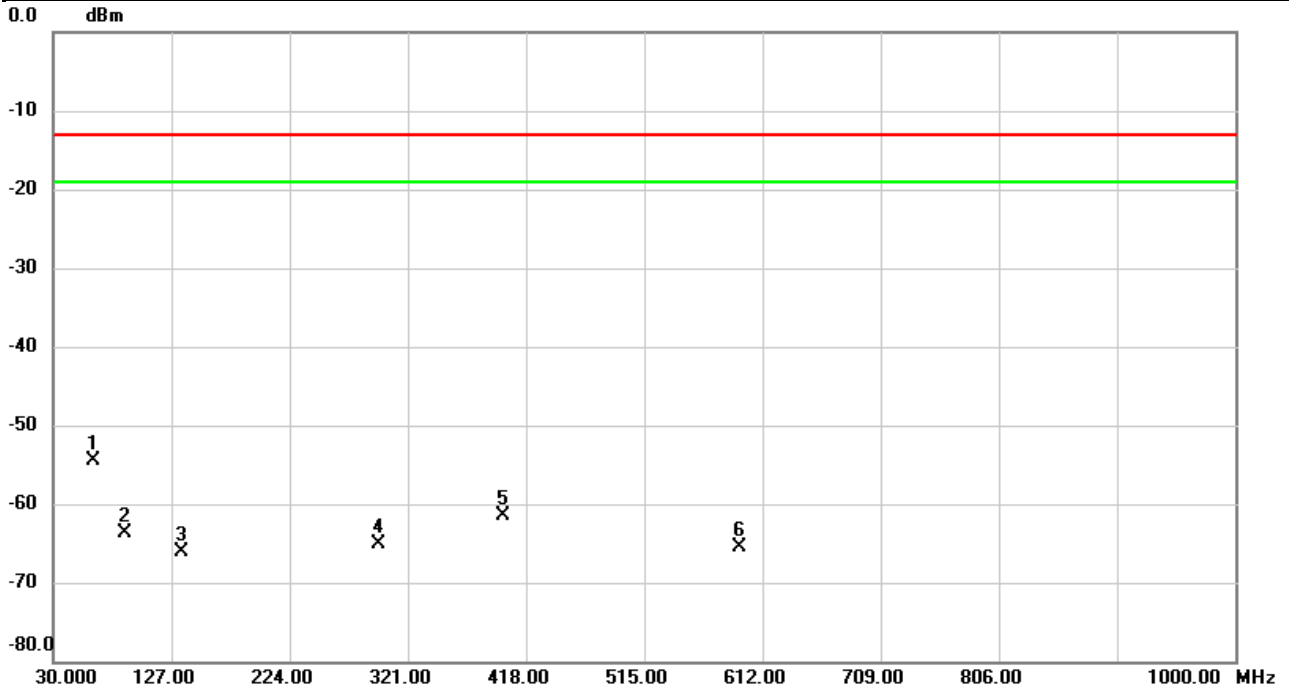

No.	Mk.	Freq. MHz	Reading Level dBm	Correct Factor dB	Measure- ment dBm	Limit dBm	Over dB	Detector	Comment
1	*	62.9800	-60.69	6.15	-54.54	-13.00	-41.54	peak	
2		88.2000	-67.64	4.04	-63.60	-13.00	-50.60	peak	
3		134.7600	-68.85	2.79	-66.06	-13.00	-53.06	peak	
4		296.7500	-65.91	0.76	-65.15	-13.00	-52.15	peak	
5		398.6000	-67.52	6.12	-61.40	-13.00	-48.40	peak	
6		593.5700	-72.97	7.44	-65.53	-13.00	-52.53	peak	

REMARKS:

- (1) Measurement Value = Reading Level + Correct Factor.
- (2) Margin Level = Measurement Value - Limit Value.

Test Mode	LTE Band 66	Test Date	2021/3/24
Test Channel	CH132072	Polarization	Vertical
Temp	21°C	Hum.	68%

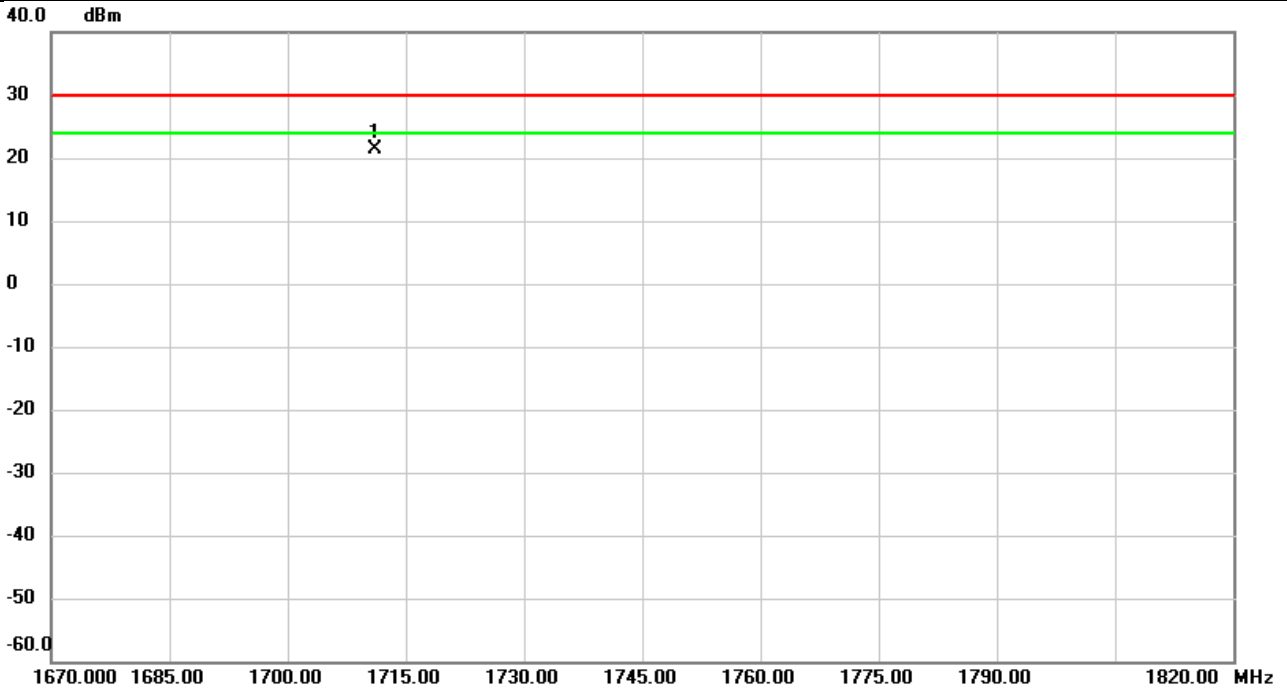

No.	Mk.	Freq.	Reading Level	Correct Factor	Measurement	Limit	Over	Detector	Comment
		MHz	dBm	dB	dBm	dBm	dB		
1	*	1711.040	-17.99	39.47	21.48	30.00	-8.52	peak	

REMARKS:

- (1) Measurement Value = Reading Level + Correct Factor.
- (2) Margin Level = Measurement Value - Limit Value.

Test Mode	LTE Band 66	Test Date	2021/3/24
Test Channel	CH132072	Polarization	Horizontal
Temp	21°C	Hum.	68%

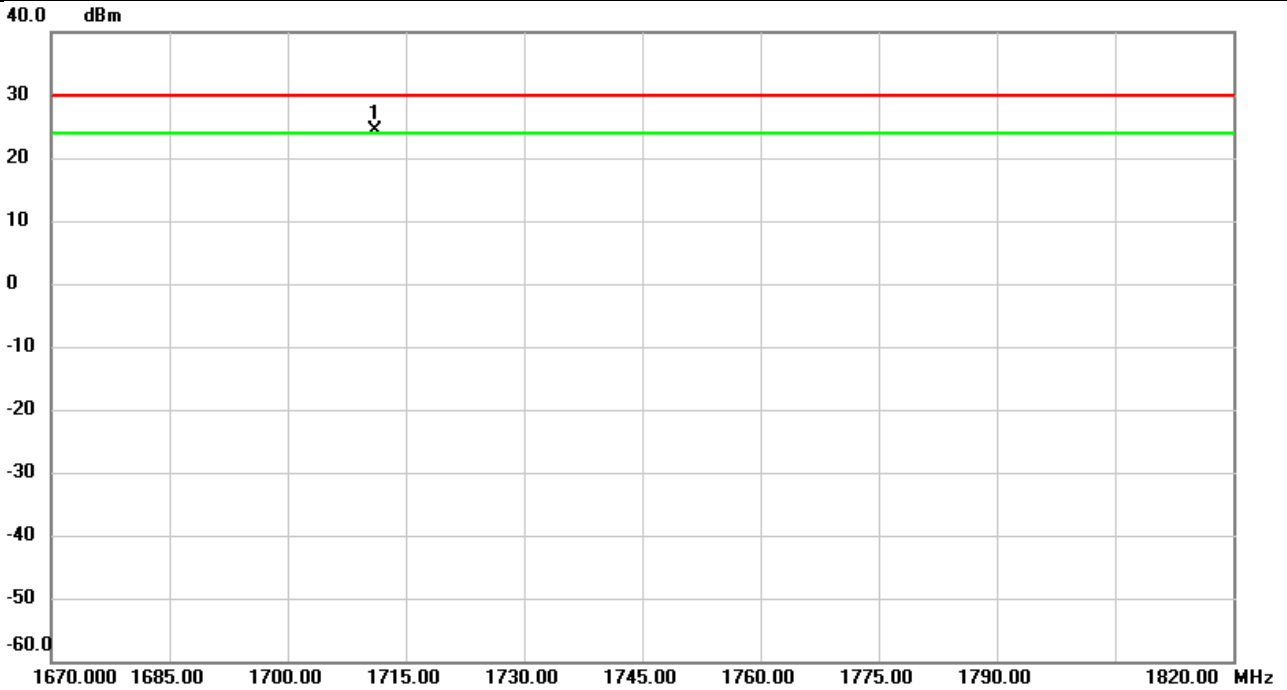

No.	Mk.	Freq.	Reading Level	Correct Factor	Measurement	Limit	Over	Detector	Comment
		MHz	dBm	dB	dBm	dBm	dB		
1	*	1711.165	-15.71	40.11	24.40	30.00	-5.60	peak	

REMARKS:

- (1) Measurement Value = Reading Level + Correct Factor.
- (2) Margin Level = Measurement Value - Limit Value.

Test Mode	LTE Band 66	Test Date	2021/3/24
Test Channel	CH132322	Polarization	Vertical
Temp	21°C	Hum.	68%

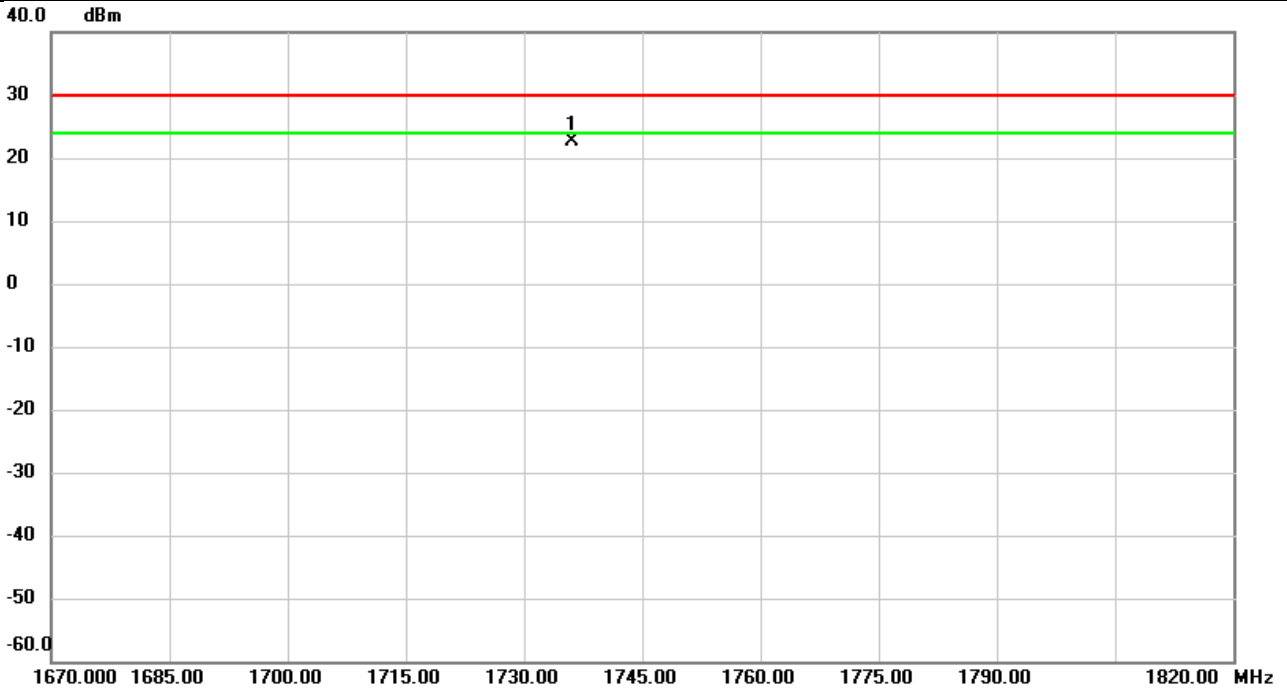

No.	Mk.	Freq.	Reading Level	Correct Factor	Measurement	Limit	Over	Detector	Comment
		MHz	dBm	dB	dBm	dBm	dB		
1	*	1736.075	-16.84	39.58	22.74	30.00	-7.26	peak	

REMARKS:

- (1) Measurement Value = Reading Level + Correct Factor.
- (2) Margin Level = Measurement Value - Limit Value.

Test Mode	LTE Band 66	Test Date	2021/3/24
Test Channel	CH132322	Polarization	Horizontal
Temp	21°C	Hum.	68%

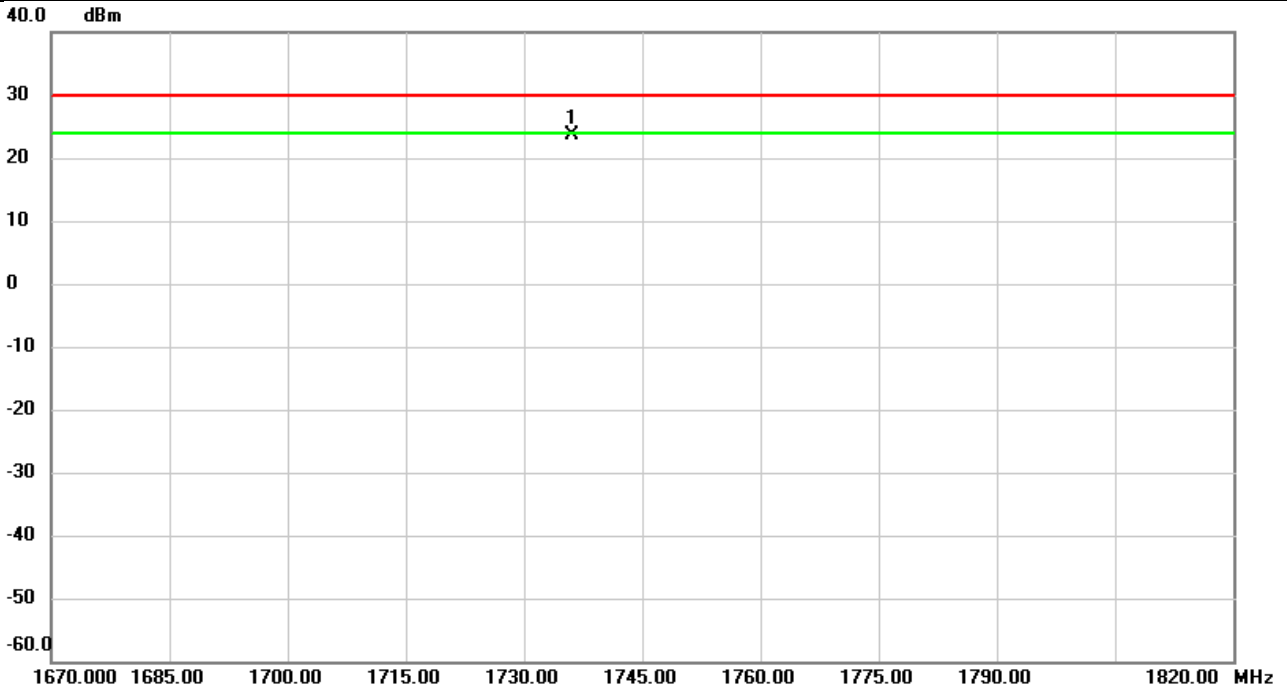

No.	Mk.	Freq.	Reading Level	Correct Factor	Measurement	Limit	Over	Detector	Comment
		MHz	dBm	dB	dBm	dBm	dB		
1	*	1736.060	-16.62	40.20	23.58	30.00	-6.42	peak	

REMARKS:

- (1) Measurement Value = Reading Level + Correct Factor.
- (2) Margin Level = Measurement Value - Limit Value.

Test Mode	LTE Band 66	Test Date	2021/3/24
Test Channel	CH132572	Polarization	Vertical
Temp	21°C	Hum.	68%

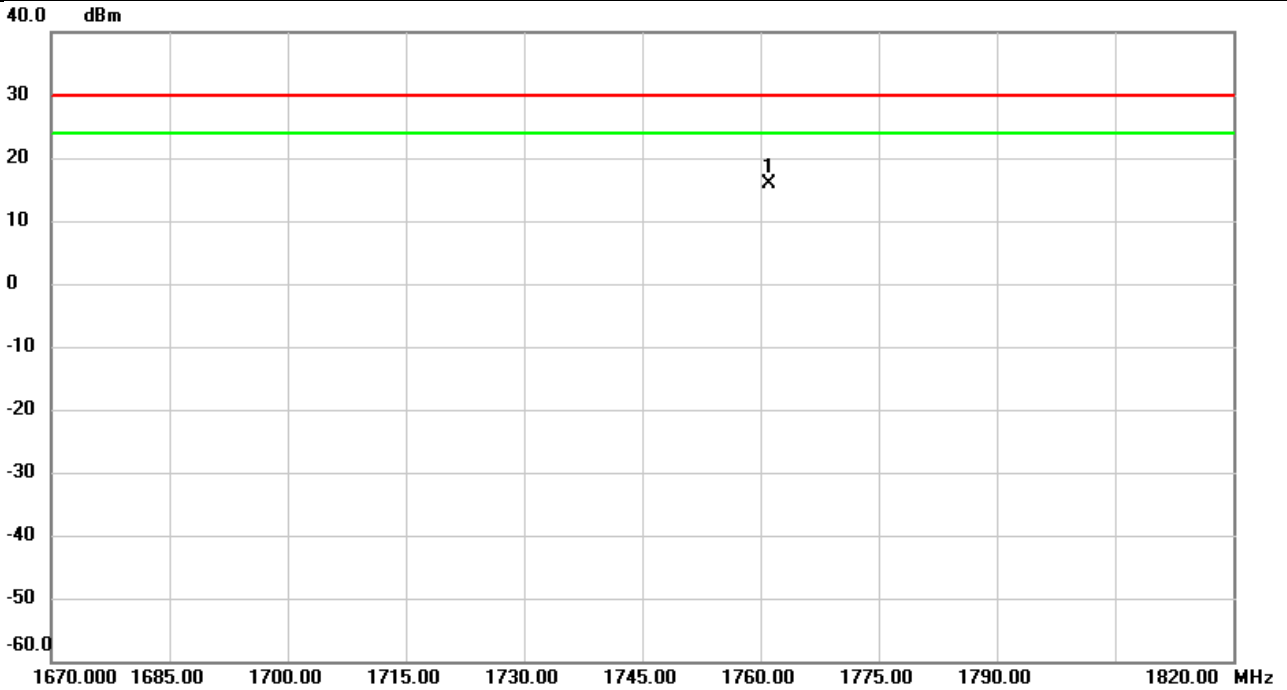

No.	Mk.	Freq.	Reading Level	Correct Factor	Measurement	Limit	Over	Detector	Comment
		MHz	dBm	dB	dBm	dBm	dB		
1	*	1761.050	-23.69	39.69	16.00	30.00	-14.00	peak	

REMARKS:

- (1) Measurement Value = Reading Level + Correct Factor.
- (2) Margin Level = Measurement Value - Limit Value.

Test Mode	LTE Band 66	Test Date	2021/3/24
Test Channel	CH132572	Polarization	Horizontal
Temp	21°C	Hum.	68%

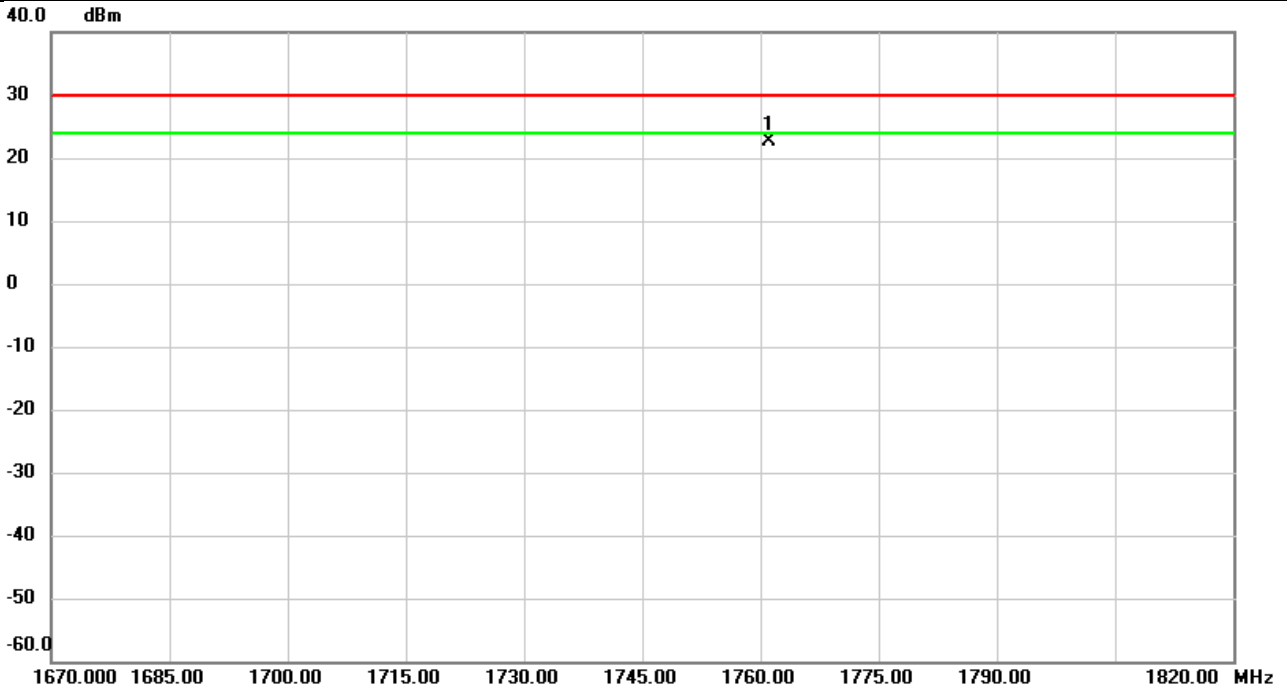

No.	Mk.	Freq.	Reading Level	Correct Factor	Measurement	Limit	Over	Detector	Comment
		MHz	dBm	dB	dBm	dBm	dB		
1	*	1761.135	-17.60	40.29	22.69	30.00	-7.31	peak	

REMARKS:

- (1) Measurement Value = Reading Level + Correct Factor.
- (2) Margin Level = Measurement Value - Limit Value.

Test Mode	LTE Band 66	Test Date	2021/3/24
Test Channel	CH132322	Polarization	Vertical
Temp	21°C	Hum.	68%

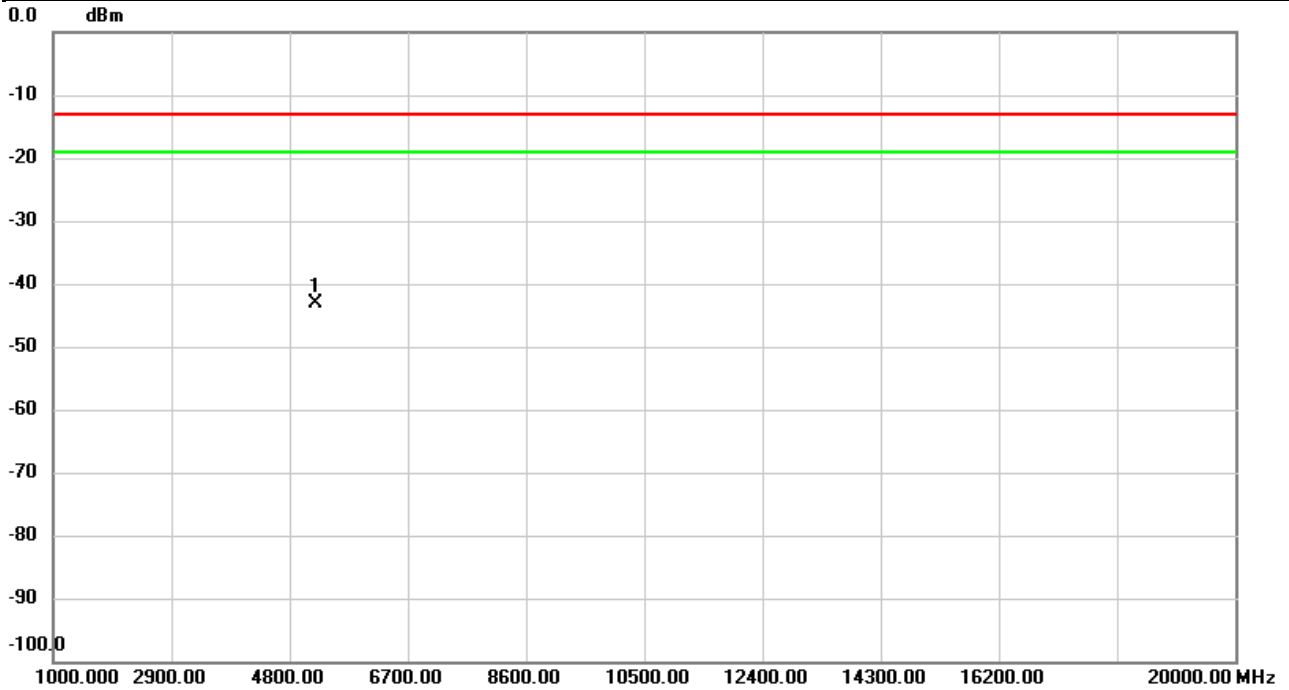

No.	Mk.	Freq.	Reading Level	Correct Factor	Measurement	Limit	Over	Detector	Comment
		MHz	dBm	dB	dBm	dBm	dB		
1	*	5208.500	-44.67	1.46	-43.21	-13.00	-30.21	peak	

REMARKS:

- (1) Measurement Value = Reading Level + Correct Factor.
- (2) Margin Level = Measurement Value - Limit Value.

Test Mode	LTE Band 66	Test Date	2021/3/24
Test Channel	CH132322	Polarization	Horizontal
Temp	21°C	Hum.	68%

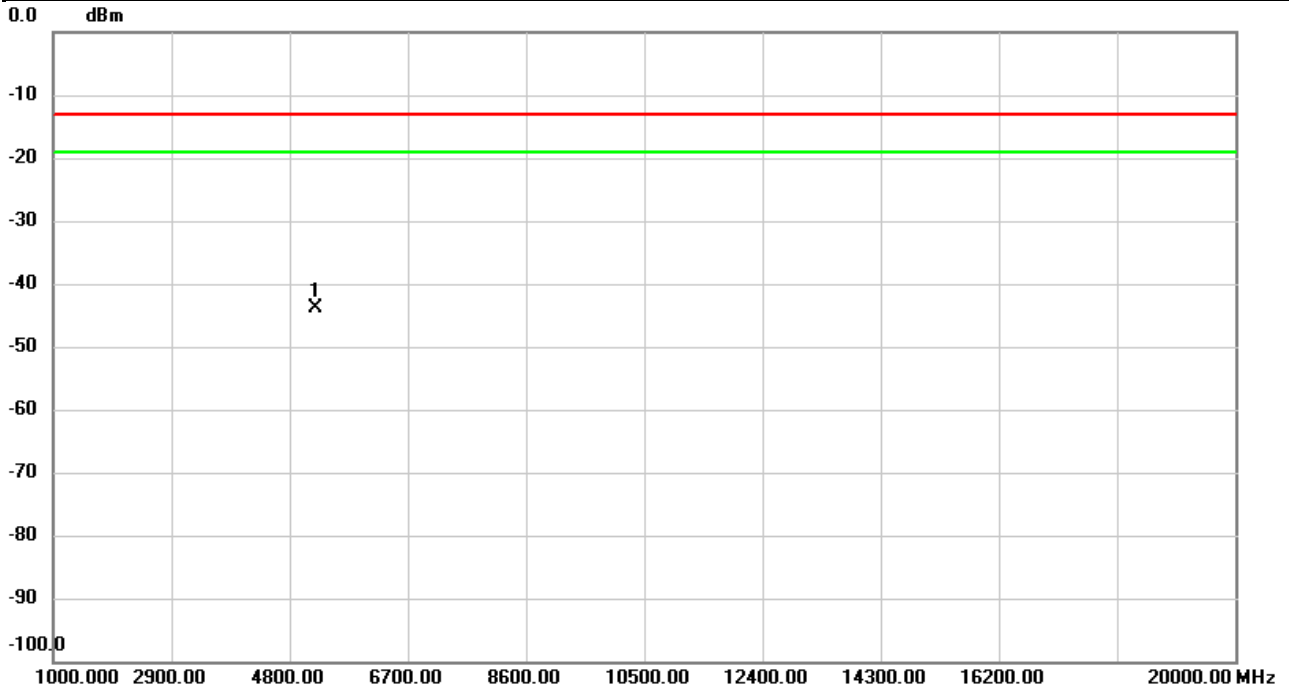

No.	Mk.	Freq.	Reading Level	Correct Factor	Measurement	Limit	Over	Detector	Comment
		MHz	dBm	dB	dBm	dBm	dB		
1	*	5208.500	-46.36	2.39	-43.97	-13.00	-30.97	peak	

REMARKS:

- (1) Measurement Value = Reading Level + Correct Factor.
- (2) Margin Level = Measurement Value - Limit Value.

APPENDIX C REFERENCE INFORMATION

WCDMA Band IV Power:

Band	Mode	UL/DL Channel No.	Frequency(MHz)	Average power(dBm)
WCDMA Band IV	Rel 99	1312/1537	1712.4	23.35
		1413/1638	1732.6	23.10
		1513/1738	1752.6	23.28

Band	Sub-test	UL/DL Channel No.	Average power(dBm)
HSDPA IV	1	1312/1537	21.85
		1413/1638	21.94
		1513/1738	21.79
	2	1312/1537	21.40
		1413/1638	21.49
		1513/1738	21.34
	3	1312/1537	20.95
		1413/1638	21.04
		1513/1738	20.89
	4	1312/1537	20.87
		1413/1638	20.97
		1513/1738	20.82

Band	Sub-test	UL/DL Channel No.	Average power(dBm)
HSUPA IV	1	1312/1537	21.24
		1413/1638	20.28
		1513/1738	19.98
	2	1312/1537	19.30
		1413/1638	18.34
		1513/1738	18.04
	3	1312/1537	20.36
		1413/1638	19.40
		1513/1738	19.10
	4	1312/1537	19.24
		1413/1638	18.28
		1513/1738	17.98
	5	1312/1537	20.22
		1413/1638	20.19
		1513/1738	19.89

LTE Band 4 Power:

Band	BW (MHz)	Channel	Frequency (MHz)	Mode	UL RB Allocation	UL RB Offset	MPR	Average power (dBm)	
4	1.4	19957	1710.7	QPSK	1	0	0	22.47	
					1	2	0	22.27	
					1	5	0	22.25	
					3	0	0	22.47	
					3	1	0	22.27	
					3	2	0	22.25	
				16QAM	6	0	1	21.53	
					1	0	1	21.65	
					1	2	1	21.61	
					1	5	1	21.32	
					3	0	1	21.65	
					3	1	1	21.61	
		20175	1732.5	QPSK	1732.5	3	2	1	21.32
						6	0	2	20.62
						1	0	0	22.58
						1	2	0	22.51
						1	5	0	22.55
						3	0	0	22.58
				16QAM	3	1	0	22.51	
					3	2	0	22.55	
					6	0	1	21.64	
					1	0	1	21.76	
					1	2	1	21.72	
					1	5	1	21.62	
		20392	1754.2	QPSK	1754.2	3	0	1	21.76
						3	1	1	21.72
						3	2	1	21.62
						6	0	2	20.50
						1	0	0	22.78
						1	2	0	22.69
				16QAM	1	5	0	23.57	
					3	0	0	22.78	
					3	1	0	22.69	
					3	2	0	23.57	
					6	0	1	21.84	
					1	0	1	21.96	
16QAM	1	2	1	21.92					
	1	5	1	22.64					
	3	0	1	21.96					
	3	1	1	21.92					
	3	2	1	22.64					
	6	0	2	20.60					

Band	BW (MHz)	Channel	Frequency (MHz)	Mode	UL RB Allocation	UL RB Offset	MPR	Average power (dBm)	
4	3	19965	1711.5	QPSK	1	0	0	22.52	
					1	7	0	22.32	
					1	14	0	22.30	
					8	0	1	21.63	
					8	4	1	21.36	
					8	7	1	21.48	
				16QAM	15	0	1	21.58	
					1	0	1	21.70	
					1	7	1	21.66	
					1	14	1	21.37	
					8	0	2	20.53	
					8	4	2	20.46	
		20175	1732.5	QPSK	1732.5	8	7	2	20.33
						8	0	2	20.67
						1	0	0	22.63
						1	7	0	22.56
						1	14	0	22.60
						8	0	1	21.74
				16QAM	8	4	1	21.60	
					8	7	1	21.78	
					15	0	1	21.69	
					1	0	1	21.81	
					1	7	1	21.77	
					1	14	1	21.67	
		20384	1753.4	QPSK	1753.4	8	0	2	20.64
						8	4	2	20.70
						8	7	2	20.63
						15	0	2	20.78
						1	0	0	22.83
						1	7	0	22.74
				16QAM	1	14	0	23.62	
					8	0	1	21.94	
					8	4	1	21.78	
					8	7	1	22.80	
					15	0	1	21.89	
					1	0	1	22.01	
16QAM	1	7	1	21.97					
	1	14	1	22.69					
	8	0	2	20.84					
	8	4	2	20.88					
	8	7	2	21.65					
	15	0	2	20.98					

Band	BW (MHz)	Channel	Frequency (MHz)	Mode	UL RB Allocation	UL RB Offset	MPR	Average power (dBm)
4	5	19975	1712.5	QPSK	1	0	0	22.57
					1	12	0	22.37
					1	24	0	22.35
					12	0	1	21.68
					12	6	1	21.41
					12	11	1	21.53
					25	0	1	21.63
				16QAM	1	0	1	21.75
					1	12	1	21.71
					1	24	1	21.42
					12	0	2	20.58
					12	6	2	20.51
					12	11	2	20.38
					25	0	2	20.72
		20175	1732.5	QPSK	1	0	0	22.68
					1	12	0	22.61
					1	24	0	22.65
					12	0	1	21.79
					12	6	1	21.65
					12	11	1	21.83
					25	0	1	21.74
				16QAM	1	0	1	21.86
					1	12	1	21.82
					1	24	1	21.72
					12	0	2	20.69
					12	6	2	20.75
					12	11	2	20.68
					25	0	2	20.83
		20375	1752.5	QPSK	1	0	0	22.88
					1	12	0	22.79
1	24				0	23.67		
12	0				1	21.99		
12	6				1	21.83		
12	11				1	22.85		
25	0				1	21.94		
16QAM	1			0	1	22.06		
	1			12	1	22.02		
	1			24	1	22.74		
	12			0	2	20.89		
	12			6	2	20.93		
	12			11	2	21.70		
	25			0	2	21.03		

Band	BW (MHz)	Channel	Frequency (MHz)	Mode	UL RB Allocation	UL RB Offset	MPR	Average power (dBm)	
4	10	20000	1715.0	QPSK	1	0	0	22.62	
					1	24	0	22.42	
					1	49	0	22.40	
					25	0	1	21.73	
					25	12	1	21.46	
					25	24	1	21.58	
				16QAM	50	0	1	21.68	
					1	0	1	21.80	
					1	24	1	21.76	
					1	49	1	21.47	
					25	0	2	20.63	
					25	12	2	20.56	
		20175	1732.5	QPSK	1732.5	25	24	2	20.43
						50	0	2	20.77
						1	0	0	22.73
						1	24	0	22.66
						1	49	0	22.70
						25	0	1	21.84
				16QAM	25	12	1	21.70	
					25	24	1	21.88	
					50	0	1	21.79	
					1	0	1	21.91	
					1	24	1	21.87	
					1	49	1	21.77	
		20350	1750.0	QPSK	1750.0	25	0	2	20.74
						25	12	2	20.80
						25	24	2	20.73
						50	0	2	20.88
						1	0	0	22.93
						1	24	0	22.84
16QAM	1			49	0	23.72			
	25			0	1	22.04			
	25			12	1	21.88			
	25			24	1	22.90			
	50			0	1	21.99			
	1			0	1	22.11			
16QAM	1	24	1	22.07					
	1	49	1	22.79					
	25	0	2	20.94					
	25	12	2	20.98					
	25	24	2	21.75					
	50	0	2	21.08					

Band	BW (MHz)	Channel	Frequency (MHz)	Mode	UL RB Allocation	UL RB Offset	MPR	Average power (dBm)	
4	15	20025	1717.5	QPSK	1	0	0	22.67	
					1	37	0	22.47	
					1	74	0	22.45	
					36	0	1	21.78	
					36	18	1	21.51	
					36	35	1	21.63	
				16QAM	75	0	1	21.73	
					1	0	1	21.85	
					1	37	1	21.81	
					1	74	1	21.52	
					36	0	2	20.68	
					36	18	2	20.61	
		20175	1732.5	QPSK	1732.5	36	35	2	20.48
						75	0	2	20.82
						1	0	0	22.78
						1	37	0	22.71
						1	74	0	22.75
						36	0	1	21.89
				16QAM	36	18	1	21.75	
					36	35	1	21.93	
					75	0	1	21.84	
					1	0	1	21.96	
					1	37	1	21.92	
					1	74	1	21.82	
		20325	1747.5	QPSK	1747.5	36	0	2	20.79
						36	18	2	20.85
						36	35	2	20.78
						75	0	2	20.93
						1	0	0	22.98
						1	37	0	22.89
				16QAM	1	74	0	23.77	
					36	0	1	22.09	
					36	18	1	21.93	
					36	35	1	22.95	
					75	0	1	22.04	
					1	0	1	22.16	
16QAM	1	37	1	22.12					
	1	74	1	22.84					
	36	0	2	20.99					
	36	18	2	21.03					
	36	35	2	21.80					
	75	0	2	21.13					

Band	BW (MHz)	Channel	Frequency (MHz)	Mode	UL RB Allocation	UL RB Offset	MPR	Average power (dBm)		
4	20	20050	1720.0	QPSK	1	0	0	22.72		
					1	49	0	22.52		
					1	99	0	22.50		
					50	0	1	21.83		
					50	24	1	21.56		
					50	49	1	21.68		
				16QAM	100	0	1	21.78		
					1	0	1	21.90		
					1	49	1	21.86		
					1	99	1	21.57		
					50	0	2	20.73		
					50	24	2	20.66		
		20175	1732.5	QPSK	1732.5	QPSK	50	49	2	20.53
							100	0	2	20.87
							1	0	0	22.83
							1	49	0	22.76
							1	99	0	22.80
							50	0	1	21.94
				16QAM	50	24	1	21.80		
					50	49	1	21.98		
					100	0	1	21.89		
					1	0	1	22.01		
					1	49	1	21.97		
					1	99	1	21.87		
		20300	1745.0	QPSK	1745.0	QPSK	50	0	2	20.84
							50	24	2	20.90
							50	49	2	20.83
							100	0	2	20.98
							1	0	0	23.03
							1	49	0	22.94
16QAM	1			99	0	23.82				
	50			0	1	22.14				
	50			24	1	21.98				
	50			49	1	23.00				
	100			0	1	22.09				
	1			0	1	22.21				
16QAM	1	49	1	22.17						
	1	99	1	22.89						
	50	0	2	21.04						
	50	24	2	21.08						
	50	49	2	21.85						
	100	0	2	21.18						

LTE Band 7 Power:

Band	BW (MHz)	Channel	Frequency (MHz)	Mode	UL RB Allocation	UL RB Offset	MPR	Average power (dBm)
7	5	20775	2502.5	QPSK	1	0	0	22.69
					1	12	0	22.79
					1	24	0	22.64
					12	0	1	21.77
					12	6	1	21.97
					12	11	1	21.73
					25	0	1	21.75
				16QAM	1	0	1	21.89
					1	12	1	21.87
					1	24	1	21.84
					12	0	2	20.79
					12	6	2	20.88
					12	11	2	20.71
					25	0	2	20.76
		21100	2535.0	QPSK	1	0	0	22.79
					1	12	0	22.89
					1	24	0	22.92
					12	0	1	21.91
					12	6	1	21.99
					12	11	1	22.02
					25	0	1	22.09
				16QAM	1	0	1	21.91
					1	12	1	22.04
					1	24	1	22.13
					12	0	2	20.91
					12	6	2	21.10
					12	11	2	20.99
					25	0	2	21.10
		21425	2567.5	QPSK	1	0	0	23.05
					1	12	0	23.34
					1	24	0	23.44
					12	0	1	22.16
					12	6	1	22.48
					12	11	1	22.57
					25	0	1	22.61
				16QAM	1	0	1	22.16
1	12				1	22.45		
1	24				1	22.61		
12	0				2	21.16		
12	6				2	21.43		
12	11				2	21.56		
25	0				2	21.52		

Band	BW (MHz)	Channel	Frequency (MHz)	Mode	UL RB Allocation	UL RB Offset	MPR	Average power (dBm)	
7	10	20800	2505.0	QPSK	1	0	0	22.74	
					1	24	0	22.84	
					1	49	0	22.69	
					25	0	1	21.82	
					25	12	1	22.02	
					25	24	1	21.78	
				16QAM	50	0	1	21.80	
					1	0	1	21.94	
					1	24	1	21.92	
					1	49	1	21.89	
					25	0	2	20.84	
					25	12	2	20.93	
		21100	2535.0	QPSK	2565.0	25	24	2	20.76
						50	0	2	20.81
						1	0	0	22.84
						1	24	0	22.94
						1	49	0	22.97
						25	0	1	21.96
				16QAM	25	12	1	22.04	
					25	24	1	22.07	
					50	0	1	22.14	
					1	0	1	21.96	
					1	24	1	22.09	
					1	49	1	22.18	
		21400	2565.0	QPSK	2565.0	25	0	2	20.96
						25	12	2	21.15
						25	24	2	21.04
						50	0	2	21.15
						1	0	0	23.10
						1	24	0	23.39
16QAM	1			49	0	23.49			
	25			0	1	22.21			
	25			12	1	22.53			
	25			24	1	22.62			
	50			0	1	22.66			
	1			0	1	22.21			
16QAM	1	24	1	22.50					
	1	49	1	22.66					
	25	0	2	21.21					
	25	12	2	21.48					
	25	24	2	21.61					
	50	0	2	21.57					

Band	BW (MHz)	Channel	Frequency (MHz)	Mode	UL RB Allocation	UL RB Offset	MPR	Average power (dBm)
7	15	20825	2507.5	QPSK	1	0	0	22.79
					1	37	0	22.89
					1	74	0	22.74
					36	0	1	21.87
					36	18	1	22.07
					36	35	1	21.83
					75	0	1	21.85
				16QAM	1	0	1	21.99
					1	37	1	21.97
					1	74	1	21.94
					36	0	2	20.89
					36	18	2	20.98
					36	35	2	20.81
					75	0	2	20.86
		21100	2535.0	QPSK	1	0	0	22.89
					1	37	0	22.99
					1	74	0	23.02
					36	0	1	22.01
					36	18	1	22.09
					36	35	1	22.12
					75	0	1	22.19
				16QAM	1	0	1	22.01
					1	37	1	22.14
					1	74	1	22.23
					36	0	2	21.01
					36	18	2	21.20
					36	35	2	21.09
					75	0	2	21.20
		21375	2563.5	QPSK	1	0	0	23.15
					1	37	0	23.44
1	74				0	23.54		
36	0				1	22.26		
36	18				1	22.58		
36	35				1	22.67		
75	0				1	22.71		
16QAM	1			0	1	22.26		
	1			37	1	22.55		
	1			74	1	22.71		
	36			0	2	21.26		
	36			18	2	21.53		
	36			35	2	21.66		
	75			0	2	21.62		

Band	BW (MHz)	Channel	Frequency (MHz)	Mode	UL RB Allocation	UL RB Offset	MPR	Average power (dBm)	
7	20	20850	2510.0	QPSK	1	0	0	22.49	
					1	49	0	22.31	
					1	99	0	22.07	
					50	0	1	21.60	
					50	24	1	21.35	
					50	49	1	21.25	
				16QAM	100	0	1	21.55	
					1	0	1	21.67	
					1	49	1	21.63	
					1	99	1	21.14	
					50	0	2	20.50	
					50	24	2	20.45	
		21100	2535.0	QPSK	2535.0	50	49	2	20.10
						100	0	2	20.64
						1	0	0	22.42
						1	49	0	22.26
						1	99	0	22.10
						50	0	1	21.53
				16QAM	50	24	1	21.30	
					50	49	1	21.28	
					100	0	1	21.48	
					1	0	1	21.60	
					1	49	1	21.56	
					1	99	1	21.17	
		21350	2560.0	QPSK	2560.0	50	0	2	20.43
						50	24	2	20.40
						50	49	2	20.13
						100	0	2	20.57
						1	0	0	22.72
						1	49	0	22.61
16QAM	1			99	0	22.43			
	50			0	1	21.83			
	50			24	1	21.65			
	50			49	1	21.61			
	100			0	1	21.78			
	1			0	1	21.90			
16QAM	1	49	1	21.86					
	1	99	1	21.50					
	50	0	2	20.73					
	50	24	2	20.75					
	50	49	2	20.46					
	100	0	2	20.87					

LTE Band 12 Power:

Band	BW (MHz)	Channel	Frequency (MHz)	Mode	UL RB Allocation	UL RB Offset	MPR	Average power (dBm)
12	1.4	23017	699.7	QPSK	1	0	0	22.14
					1	2	0	22.01
					1	5	0	21.79
					3	0	0	22.14
					3	1	0	22.01
					3	2	0	21.79
					6	0	1	21.20
				16QAM	1	0	1	21.32
					1	2	1	21.28
					1	5	1	20.86
					3	0	1	21.32
					3	1	1	21.28
					3	2	1	20.86
					6	0	2	20.29
		23095	707.5	QPSK	1	0	0	22.28
					1	2	0	22.12
					1	5	0	22.16
					3	0	0	22.28
					3	1	0	22.12
					3	2	0	22.16
					6	0	1	21.34
				16QAM	1	0	1	21.46
					1	2	1	21.42
					1	5	1	21.23
					3	0	1	21.46
					3	1	1	21.42
					3	2	1	21.23
					6	0	2	20.50
		23173	715.3	QPSK	1	0	0	22.36
					1	2	0	22.24
					1	5	0	22.12
					3	0	0	22.36
					3	1	0	22.24
					3	2	0	22.12
					6	0	1	21.42
				16QAM	1	0	1	21.54
1	2				1	21.50		
1	5				1	21.19		
3	0				1	21.54		
3	1				1	21.50		
3	2				1	21.19		
6	0				2	20.60		

Band	BW (MHz)	Channel	Frequency (MHz)	Mode	UL RB Allocation	UL RB Offset	MPR	Average power (dBm)
12	3	23025	700.5	QPSK	1	0	0	22.19
					1	7	0	22.06
					1	14	0	21.84
					8	0	1	21.30
					8	4	1	21.10
					8	7	1	21.02
					15	0	1	21.25
				16QAM	1	0	1	21.37
					1	7	1	21.33
					1	14	1	20.91
					8	0	2	20.20
					8	4	2	20.20
					8	7	2	19.87
					15	0	2	20.34
		23095	707.5	QPSK	1	0	0	22.33
					1	7	0	22.17
					1	14	0	22.21
					8	0	1	21.44
					8	4	1	21.21
					8	7	1	21.39
					15	0	1	21.39
				16QAM	1	0	1	21.51
					1	7	1	21.47
					1	14	1	21.28
					8	0	2	20.34
					8	4	2	20.31
					8	7	2	20.24
					15	0	2	20.48
		23165	714.5	QPSK	1	0	0	22.41
					1	7	0	22.29
					1	14	0	22.17
					8	0	1	21.52
					8	4	1	21.33
					8	7	1	21.35
					15	0	1	21.47
				16QAM	1	0	1	21.59
1	7				1	21.55		
1	14				1	21.24		
8	0				2	20.42		
8	4				2	20.43		
8	7				2	20.20		
15	0				2	20.56		

Band	BW (MHz)	Channel	Frequency (MHz)	Mode	UL RB Allocation	UL RB Offset	MPR	Average power (dBm)		
12	5	23035	701.5	QPSK	1	0	0	22.24		
					1	12	0	22.11		
					1	24	0	21.89		
					12	0	1	21.35		
					12	6	1	21.15		
					12	11	1	21.07		
				16QAM	25	0	1	21.30		
					1	0	1	21.42		
					1	12	1	21.38		
					1	24	1	20.96		
					12	0	2	20.25		
					12	6	2	20.25		
		23095	707.5	QPSK	707.5	QPSK	12	11	2	19.92
							25	0	2	20.39
							1	0	0	22.38
							1	12	0	22.22
							1	24	0	22.26
							12	0	1	21.49
				16QAM	12	6	1	21.26		
					12	11	1	21.44		
					25	0	1	21.44		
					1	0	1	21.56		
					1	12	1	21.52		
					1	24	1	21.33		
		23155	713.5	QPSK	713.5	QPSK	12	0	2	20.39
							12	6	2	20.36
							12	11	2	20.29
							25	0	2	20.53
							1	0	0	22.46
							1	12	0	22.34
16QAM	1			24	0	22.22				
	12			0	1	21.57				
	12			6	1	21.38				
	12			11	1	21.40				
	25			0	1	21.52				
	1			0	1	21.64				
16QAM	1	12	1	21.60						
	1	24	1	21.29						
	12	0	2	20.47						
	12	6	2	20.48						
	12	11	2	20.25						
	25	0	2	20.61						

Band	BW (MHz)	Channel	Frequency (MHz)	Mode	UL RB Allocation	UL RB Offset	MPR	Average power (dBm)		
12	10	23060	704.0	QPSK	1	0	0	22.29		
					1	24	0	22.16		
					1	49	0	21.94		
					25	0	1	21.40		
					25	12	1	21.20		
					25	24	1	21.12		
				16QAM	50	0	1	21.35		
					1	0	1	21.47		
					1	24	1	21.43		
					1	49	1	21.01		
					25	0	2	20.30		
					25	12	2	20.30		
		23095	707.5	QPSK	707.5	QPSK	25	24	2	19.97
							25	24	2	20.44
							50	0	2	20.44
							1	0	0	22.43
							1	24	0	22.27
							1	49	0	22.31
				16QAM	25	0	1	21.54		
					25	12	1	21.31		
					25	24	1	21.49		
					50	0	1	21.49		
					1	0	1	21.61		
					1	24	1	21.57		
		23130	711.0	QPSK	711.0	QPSK	1	49	1	21.38
							25	0	2	20.44
							25	12	2	20.41
							25	24	2	20.34
							50	0	2	20.58
							1	0	0	22.51
16QAM	1			24	0	22.39				
	1			49	0	22.27				
	25			0	1	21.62				
	25			12	1	21.43				
	25			24	1	21.45				
	50			0	1	21.57				
1	0	1	21.69							
1	24	1	21.65							
1	49	1	21.34							
25	0	2	20.52							
25	12	2	20.53							
25	24	2	20.30							
50	0	2	20.66							

LTE Band 13 Power:

Band	BW (MHz)	Channel	Frequency (MHz)	Mode	UL RB Allocation	UL RB Offset	MPR	Average power (dBm)
13	5	23205	779.5	QPSK	1	0	0	22.78
					1	12	0	22.50
					1	24	0	22.43
					12	0	1	21.89
					12	6	1	21.54
					12	11	1	21.61
					25	0	1	21.84
				16QAM	1	0	1	21.96
					1	12	1	21.92
					1	24	1	21.50
					12	0	2	20.79
					12	6	2	20.64
					12	11	2	20.46
					25	0	2	20.93
		23230	752.0	QPSK	1	0	0	22.78
					1	12	0	22.50
					1	24	0	22.43
					12	0	1	21.89
					12	6	1	21.54
					12	11	1	21.61
					25	0	1	21.84
				16QAM	1	0	1	21.96
					1	12	1	21.92
					1	24	1	21.50
					12	0	2	20.79
					12	6	2	20.64
					12	11	2	20.46
					25	0	2	20.93
		23255	784.5	QPSK	1	0	0	22.78
					1	12	0	22.50
1	24				0	22.43		
12	0				1	21.89		
12	6				1	21.54		
12	11				1	21.61		
25	0				1	21.84		
16QAM	1			0	1	21.96		
	1			12	1	21.92		
	1			24	1	21.50		
	12			0	2	20.79		
	12			6	2	20.64		
	12			11	2	20.46		
	25			0	2	20.93		

Band	BW (MHz)	Channel	Frequency (MHz)	Mode	UL RB Allocation	UL RB Offset	MPR	Average power (dBm)
13	10	23230	782.0	QPSK	1	0	0	22.81
					1	24	0	22.53
					1	49	0	22.46
					25	0	1	21.92
					25	12	1	21.57
					25	24	1	21.64
					50	0	1	21.87
				16QAM	1	0	1	21.99
					1	24	1	21.95
					1	49	1	21.53
					25	0	2	20.82
					25	12	2	20.67
					25	24	2	20.49
					50	0	2	20.96

LTE Band 17 Power:

Band	BW (MHz)	Channel	Frequency (MHz)	Mode	UL RB Allocation	UL RB Offset	MPR	Average power (dBm)
17	5	23780	706.5	QPSK	1	0	0	22.48
					1	12	0	22.22
					1	24	0	22.24
					12	0	1	21.59
					12	6	1	21.26
					12	11	1	21.42
					25	0	1	21.54
				16QAM	1	0	1	21.66
					1	12	1	21.62
					1	24	1	21.31
					12	0	2	20.49
					12	6	2	20.36
					12	11	2	20.27
					25	0	2	20.63
		23790	710.0	QPSK	1	0	0	22.68
					1	12	0	22.62
					1	24	0	22.41
					12	0	1	21.79
					12	6	1	21.66
					12	11	1	21.59
					25	0	1	21.74
				16QAM	1	0	1	21.86
					1	12	1	21.82
					1	24	1	21.48
					12	0	2	20.69
					12	6	2	20.76
					12	11	2	20.44
					25	0	2	20.83
		23800	713.5	QPSK	1	0	0	22.44
					1	12	0	22.36
1	24				0	22.26		
12	0				1	21.55		
12	6				1	21.40		
12	11				1	21.44		
25	0				1	21.50		
16QAM	1			0	1	21.62		
	1			12	1	21.58		
	1			24	1	21.33		
	12			0	2	20.45		
	12			6	2	20.50		
	12			11	2	20.29		
	25			0	2	20.59		

Band	BW (MHz)	Channel	Frequency (MHz)	Mode	UL RB Allocation	UL RB Offset	MPR	Average power (dBm)	
17	10	23780	709.0	QPSK	1	0	0	22.53	
					1	24	0	22.27	
					1	49	0	22.29	
					25	0	1	21.64	
					25	12	1	21.31	
					25	24	1	21.47	
				16QAM	50	0	1	21.59	
					1	0	1	21.71	
					1	24	1	21.67	
					1	49	1	21.36	
					25	0	2	20.54	
					25	12	2	20.41	
		23790	710.0	QPSK	710.0	25	24	2	20.32
						50	0	2	20.68
						1	0	0	22.73
						1	24	0	22.67
						1	49	0	22.46
						25	0	1	21.84
				16QAM	25	12	1	21.71	
					25	24	1	21.64	
					50	0	1	21.79	
					1	0	1	21.91	
					1	24	1	21.87	
					1	49	1	21.53	
		23800	711.0	QPSK	711.0	25	0	2	20.74
						25	12	2	20.81
						25	24	2	20.49
						50	0	2	20.88
						1	0	0	22.49
						1	24	0	22.41
16QAM	1			49	0	22.31			
	25			0	1	21.60			
	25			12	1	21.45			
	25			24	1	21.49			
	50			0	1	21.55			
	1			0	1	21.67			
16QAM	1	24	1	21.63					
	1	49	1	21.38					
	25	0	2	20.50					
	25	12	2	20.55					
	25	24	2	20.34					
	50	0	2	20.64					

LTE Band 30 Power:

Band	BW (MHz)	Channel	Frequency (MHz)	Mode	UL RB Allocation	UL RB Offset	MPR	Average power (dBm)
30	5	27685	2307.5	QPSK	1	0	0	20.21
					1	24	0	20.29
					1	49	0	20.13
					25	0	1	19.32
					25	12	1	19.33
					25	24	1	19.31
				16QAM	50	0	1	19.27
					1	0	1	19.39
					1	24	1	19.35
					1	49	1	19.20
					25	0	2	18.22
					25	12	2	18.43
		27710	2310.0	QPSK	25	24	2	18.16
					50	0	2	18.36
					1	0	0	20.21
					1	24	0	20.29
					1	49	0	20.13
					25	0	1	19.32
				16QAM	25	12	1	19.33
					25	24	1	19.31
					50	0	1	19.27
					1	0	1	19.39
					1	24	1	19.35
					1	49	1	19.20
		27734	2312.4	QPSK	25	0	2	18.22
					25	12	2	18.43
					25	24	2	18.16
					50	0	2	18.36
					1	0	0	20.21
					1	24	0	20.29
16QAM	1			49	0	20.13		
	25			0	1	19.32		
	25			12	1	19.33		
	25			24	1	19.31		
	50			0	1	19.27		
	1			0	1	19.39		
16QAM	1	24	1	19.35				
	1	49	1	19.20				
	25	0	2	18.22				
	25	12	2	18.43				
	25	24	2	18.16				
	50	0	2	18.36				

Band	BW (MHz)	Channel	Frequency (MHz)	Mode	UL RB Allocation	UL RB Offset	MPR	Average power (dBm)
30	10	27710	2310.0	QPSK	1	0	0	20.24
					1	37	0	20.32
					1	74	0	20.16
					36	0	1	19.35
					36	18	1	19.36
					36	37	1	19.34
					75	0	1	19.30
				16QAM	1	0	1	19.42
					1	37	1	19.38
					1	74	1	19.23
					36	0	2	18.25
					36	18	2	18.46
					36	37	2	18.19
					75	0	2	18.39

LTE Band 41 Power:

Band	BW (MHz)	Channel	Frequency (MHz)	Mode	UL RB Allocation	UL RB Offset	MPR	Average power (dBm)	
41	5	39675	2498.5	QPSK	1	0	0	22.44	
					1	12	0	22.62	
					1	24	0	22.58	
					12	0	1	21.57	
					12	6	1	21.72	
					12	11	1	21.67	
				16QAM	25	0	1	21.67	
					1	0	1	21.54	
					1	12	1	21.67	
					1	24	1	21.63	
					12	0	2	20.57	
					12	6	2	20.69	
		40620	2593.0	QPSK	2593.0	12	11	2	20.64
						25	0	2	20.68
						1	0	0	22.83
						1	12	0	22.93
						1	24	0	22.54
						12	0	1	21.98
				16QAM	12	6	1	22.06	
					12	11	1	21.69	
					25	0	1	21.73	
					1	0	1	21.92	
					1	12	1	22.03	
					1	24	1	21.67	
		41565	2687.5	QPSK	2687.5	12	0	2	20.99
						12	6	2	21.01
						12	11	2	20.67
						25	0	2	20.70
						1	0	0	22.91
						1	12	0	23.06
				16QAM	1	24	0	22.84	
					12	0	1	22.03	
					12	6	1	22.21	
					12	11	1	21.95	
					25	0	1	21.98	
					1	0	1	22.00	
16QAM	1	12	1	22.19					
	1	24	1	21.93					
	12	0	2	21.03					
	12	6	2	21.14					
	12	11	2	20.93					
	25	0	2	20.97					

Band	BW (MHz)	Channel	Frequency (MHz)	Mode	UL RB Allocation	UL RB Offset	MPR	Average power (dBm)	
41	10	39700	2501.0	QPSK	1	0	0	22.49	
					1	24	0	22.67	
					1	49	0	22.63	
					25	0	1	21.62	
					25	12	1	21.77	
					25	24	1	21.72	
				16QAM	50	0	1	21.72	
					1	0	1	21.59	
					1	24	1	21.72	
					1	49	1	21.68	
					25	0	2	20.62	
					25	12	2	20.74	
		40620	2593.0	QPSK	2593.0	25	24	2	20.69
						50	0	2	20.73
						1	0	0	22.88
						1	24	0	22.98
						1	49	0	22.59
						25	0	1	22.03
				16QAM	25	12	1	22.11	
					25	24	1	21.74	
					50	0	1	21.78	
					1	0	1	21.97	
					1	24	1	22.08	
					1	49	1	21.72	
		41540	2685.0	QPSK	2685.0	25	0	2	21.04
						25	12	2	21.06
						25	24	2	20.72
						50	0	2	20.75
						1	0	0	22.96
						1	24	0	23.11
16QAM	1			49	0	22.89			
	25			0	1	22.08			
	25			12	1	22.26			
	25			24	1	22.00			
	50			0	1	22.03			
	1			0	1	22.05			
16QAM	1	24	1	22.24					
	1	49	1	21.98					
	25	0	2	21.08					
	25	12	2	21.19					
	25	24	2	20.98					
	50	0	2	21.02					

Band	BW (MHz)	Channel	Frequency (MHz)	Mode	UL RB Allocation	UL RB Offset	MPR	Average power (dBm)	
41	15	39725	2503.5	QPSK	1	0	0	22.54	
					1	37	0	22.72	
					1	74	0	22.68	
					36	0	1	21.67	
					36	18	1	21.82	
					36	37	1	21.77	
				16QAM	75	0	1	21.77	
					1	0	1	21.64	
					1	37	1	21.77	
					1	74	1	21.73	
					36	0	2	20.67	
					36	18	2	20.79	
		40620	2593.0	QPSK	2593.0	36	37	2	20.74
						75	0	2	20.78
						1	0	0	22.93
						1	37	0	23.03
						1	74	0	22.64
						36	0	1	22.08
				16QAM	36	18	1	22.16	
					36	37	1	21.79	
					75	0	1	21.83	
					1	0	1	22.02	
					1	37	1	22.13	
					1	74	1	21.77	
		41515	2682.5	QPSK	2682.5	36	0	2	21.09
						36	18	2	21.11
						36	37	2	20.77
						75	0	2	20.80
						1	0	0	23.01
						1	37	0	23.16
16QAM	1			74	0	22.94			
	36			0	1	22.13			
	36			18	1	22.31			
	36			37	1	22.05			
	75			0	1	22.08			
	1			0	1	22.10			
16QAM	1	37	1	22.29					
	1	74	1	22.03					
	36	0	2	21.13					
	36	18	2	21.24					
	36	37	2	21.03					
	75	0	2	21.07					

Band	BW (MHz)	Channel	Frequency (MHz)	Mode	UL RB Allocation	UL RB Offset	MPR	Average power (dBm)	
41	20	39750	2506.0	QPSK	1	0	0	22.31	
					1	49	0	22.29	
					1	99	0	22.14	
					50	0	1	21.42	
					50	24	1	21.33	
					50	49	1	21.32	
				16QAM	100	0	1	21.37	
					1	0	1	21.49	
					1	49	1	21.45	
					1	99	1	21.21	
					50	0	2	20.32	
					50	24	2	20.43	
		40620	2593.0	QPSK	2593.0	50	49	2	20.17
						100	0	2	20.46
						1	0	0	22.49
						1	49	0	22.23
						1	99	0	22.17
						50	0	1	21.60
				16QAM	50	24	1	21.27	
					50	49	1	21.35	
					100	0	1	21.55	
					1	0	1	21.67	
					1	49	1	21.63	
					1	99	1	21.24	
		41490	2680.0	QPSK	2680.0	50	0	2	20.50
						50	24	2	20.37
						50	49	2	20.20
						100	0	2	20.64
						1	0	0	22.35
						1	49	0	22.40
16QAM	1			99	0	22.13			
	50			0	1	21.46			
	50			24	1	21.44			
	50			49	1	21.31			
	100			0	1	21.41			
	1			0	1	21.53			
16QAM	1	49	1	21.49					
	1	99	1	21.20					
	50	0	2	20.36					
	50	24	2	20.54					
	50	49	2	20.16					
	100	0	2	20.50					

LTE Band 66 Power:

Band	BW (MHz)	Channel	Frequency (MHz)	Mode	UL RB Allocation	UL RB Offset	MPR	Average power (dBm)		
66	1.4	131979	1710.7	QPSK	1	0	0	22.51		
					1	2	0	22.38		
					1	5	0	22.29		
					3	0	0	22.51		
					3	1	0	22.38		
					3	2	0	22.29		
				16QAM	6	0	1	21.57		
					1	0	1	21.69		
					1	2	1	21.65		
					1	5	1	21.36		
					3	0	1	21.69		
					3	1	1	21.65		
		132322	1745.0	QPSK	1745.0	QPSK	3	2	1	21.36
							6	0	2	20.66
							1	0	0	22.69
							1	2	0	22.57
							1	5	0	22.48
							3	0	0	22.69
				16QAM	3	1	0	22.57		
					3	2	0	22.48		
					6	0	1	21.75		
					1	0	1	21.87		
					1	2	1	21.83		
					1	5	1	21.55		
		132664	1779.2	QPSK	1779.2	QPSK	3	0	1	21.87
							3	1	1	21.83
							3	2	1	21.55
							6	0	2	20.50
							1	0	0	22.56
							1	2	0	22.47
16QAM	1			5	0	22.34				
	3			0	0	22.56				
	3			1	0	22.47				
	3			2	0	22.34				
	6			0	1	21.62				
	1			0	1	21.74				
16QAM	1	2	1	21.70						
	1	5	1	21.41						
	3	0	1	21.74						
	3	1	1	21.70						
	3	2	1	21.41						
	6	0	2	20.60						

Band	BW (MHz)	Channel	Frequency (MHz)	Mode	UL RB Allocation	UL RB Offset	MPR	Average power (dBm)		
66	3	131987	1711.5	QPSK	1	0	0	22.56		
					1	7	0	22.43		
					1	14	0	22.34		
					8	0	1	21.67		
					8	4	1	21.47		
					8	7	1	21.52		
				15	0	1	21.62			
				16QAM	1	0	1	21.74		
					1	7	1	21.70		
					1	14	1	21.41		
					8	0	2	20.57		
					8	4	2	20.57		
					8	7	2	20.37		
				132322	1745.0	QPSK	1	0	0	22.74
							1	7	0	22.62
		1	14				0	22.53		
		8	0				1	21.85		
		8	4				1	21.66		
		8	7				1	21.71		
		15	0			1	21.80			
		16QAM	1			0	1	21.92		
			1			7	1	21.88		
			1			14	1	21.60		
			8			0	2	20.75		
			8			4	2	20.76		
			8			7	2	20.56		
		132656	1778.4			QPSK	1	0	0	22.61
							1	7	0	22.52
				1	14		0	22.39		
				8	0		1	21.72		
8	4			1	21.56					
8	7			1	21.57					
15	0			1	21.67					
16QAM	1			0	1	21.79				
	1			7	1	21.75				
	1			14	1	21.46				
	8			0	2	20.62				
	8			4	2	20.66				
	8			7	2	20.42				
15	0			2	21.10					

Band	BW (MHz)	Channel	Frequency (MHz)	Mode	UL RB Allocation	UL RB Offset	MPR	Average power (dBm)
66	5	131997	1712.5	QPSK	1	0	0	22.61
					1	12	0	22.48
					1	24	0	22.39
					12	0	1	21.72
					12	6	1	21.52
					12	11	1	21.57
				16QAM	25	0	1	21.67
					1	0	1	21.79
					1	12	1	21.75
					1	24	1	21.46
					12	0	2	20.62
					12	6	2	20.62
		132322	1745.0	QPSK	12	11	2	20.42
					25	0	2	20.76
					1	0	0	22.79
					1	12	0	22.67
					1	24	0	22.58
					12	0	1	21.90
				16QAM	12	6	1	21.71
					12	11	1	21.76
					25	0	1	21.85
					1	0	1	21.97
					1	12	1	21.93
					1	24	1	21.65
		132647	1777.5	QPSK	12	0	2	20.80
					12	6	2	20.81
					12	11	2	20.61
					25	0	2	20.94
					1	0	0	22.66
					1	12	0	22.57
16QAM	1			24	0	22.44		
	12			0	1	21.77		
	12			6	1	21.61		
	12			11	1	21.62		
	25			0	1	21.72		
	1			0	1	21.84		
16QAM	1	12	1	21.80				
	1	24	1	21.51				
	12	0	2	20.67				
	12	6	2	20.71				
	12	11	2	20.47				
	25	0	2	20.81				

Band	BW (MHz)	Channel	Frequency (MHz)	Mode	UL RB Allocation	UL RB Offset	MPR	Average power (dBm)
66	10	132022	1715.0	QPSK	1	0	0	22.66
					1	24	0	22.53
					1	49	0	22.44
					25	0	1	21.77
					25	12	1	21.57
					25	24	1	21.62
				16QAM	50	0	1	21.72
					1	0	1	21.84
					1	24	1	21.80
					1	49	1	21.51
					25	0	2	20.67
					25	12	2	20.67
		132322	1745.0	QPSK	25	24	2	20.47
					50	0	2	20.81
					1	0	0	22.84
					1	24	0	22.72
					1	49	0	22.63
					25	0	1	21.95
				16QAM	25	12	1	21.76
					25	24	1	21.81
					50	0	1	21.90
					1	0	1	22.02
					1	24	1	21.98
					1	49	1	21.70
		132621	1775.0	QPSK	25	0	2	20.85
					25	12	2	20.86
					25	24	2	20.66
					50	0	2	20.99
					1	0	0	22.71
					1	24	0	22.62
16QAM	1			49	0	22.49		
	25			0	1	21.82		
	25			12	1	21.66		
	25			24	1	21.67		
	50			0	1	21.77		
	1			0	1	21.89		
16QAM	1	24	1	21.85				
	1	49	1	21.56				
	25	0	2	20.72				
	25	12	2	20.76				
	25	24	2	20.52				
	50	0	2	20.86				

Band	BW (MHz)	Channel	Frequency (MHz)	Mode	UL RB Allocation	UL RB Offset	MPR	Average power (dBm)	
66	15	132047	1717.5	QPSK	1	0	0	22.71	
					1	37	0	22.58	
					1	74	0	22.49	
					36	0	1	21.82	
					36	18	1	21.62	
					36	35	1	21.67	
				16QAM	75	0	1	21.77	
					1	0	1	21.89	
					1	37	1	21.85	
					1	74	1	21.56	
					36	0	2	20.72	
					36	18	2	20.72	
		132322	1745.0	QPSK	1745.0	36	35	2	20.52
						75	0	2	20.86
						1	0	0	22.89
						1	37	0	22.77
						1	74	0	22.68
						36	0	1	22.00
				16QAM	36	18	1	21.81	
					36	35	1	21.86	
					75	0	1	21.95	
					1	0	1	22.07	
					1	37	1	22.03	
					1	74	1	21.75	
		132597	1772.5	QPSK	1772.5	36	0	2	20.90
						36	18	2	20.91
						36	35	2	20.71
						75	0	2	21.04
						1	0	0	22.76
						1	37	0	22.67
16QAM	1			74	0	22.54			
	36			0	1	21.87			
	36			18	1	21.71			
	36			35	1	21.72			
	75			0	1	21.82			
	1			0	1	21.94			
16QAM	1	37	1	21.90					
	1	74	1	21.61					
	36	0	2	20.77					
	36	18	2	20.81					
	36	35	2	20.57					
	75	0	2	20.91					

Band	BW (MHz)	Channel	Frequency (MHz)	Mode	UL RB Allocation	UL RB Offset	MPR	Average power (dBm)	
66	20	132072	1720.0	QPSK	1	0	0	22.76	
					1	49	0	22.63	
					1	99	0	22.54	
					50	0	1	21.87	
					50	24	1	21.67	
					50	49	1	21.72	
				16QAM	100	0	1	21.82	
					1	0	1	21.94	
					1	49	1	21.90	
					1	99	1	21.61	
					50	0	2	20.77	
					50	24	2	20.77	
		132322	1745.0	QPSK	1745.0	50	49	2	20.57
						100	0	2	20.91
						1	0	0	22.94
						1	49	0	22.82
						1	99	0	22.73
						50	0	1	22.05
				16QAM	50	24	1	21.86	
					50	49	1	21.91	
					100	0	1	22.00	
					1	0	1	22.12	
					1	49	1	22.08	
					1	99	1	21.80	
		132572	1770.0	QPSK	1770.0	50	0	2	20.95
						50	24	2	20.96
						50	49	2	20.76
						100	0	2	21.09
						1	0	0	22.81
						1	49	0	22.72
16QAM	1			99	0	22.59			
	50			0	1	21.92			
	50			24	1	21.76			
	50			49	1	21.77			
	100			0	1	21.87			
	1			0	1	21.99			
16QAM	1	49	1	21.95					
	1	99	1	21.66					
	50	0	2	20.82					
	50	24	2	20.86					
	50	49	2	20.62					
	100	0	2	20.96					

End of Test Report