

# FCC Radio Test Report

## FCC ID: PU5-LN300WG3D

**Report No.** : BTL-FCCP-1-2102T172A  
**Equipment** : Notebook Computer  
**Model Name** : Lenovo 300w Gen 3xxxxxxx (The "x" in model name can be 0 to 9, A to Z, a to z, "-" or blank, for marketing purpose only)  
**Brand Name** : Lenovo  
**Applicant** : Wistron Corporation  
**Address** : 21F, No. 88, Sec. 1, Hsin Tai Wu Rd., Hsichih Dist, New Taipei City 221, Taiwan

**Radio Function** : Bluetooth EDR

**FCC Rule Part(s)** : FCC Part15, Subpart C (15.247)  
**Measurement Procedure(s)** : ANSI C63.10-2013

**Date of Receipt** : 2021/3/12  
**Date of Test** : 2021/3/12 ~ 2021/5/6  
**Issued Date** : 2021/5/31

The above equipment has been tested and found in compliance with the requirement of the above standards by BTL Inc.

Prepared by

  
Peter Chen, Engineer

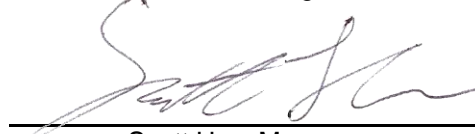

Approved by

  
Scott Hsu, Manager

**BTL Inc.**

No.18, Ln. 171, Sec. 2, Jiuzong Rd., Neihu Dist., Taipei City 114, Taiwan

Tel: +886-2-2657-3299

Fax: +886-2-2657-3331

Web: www.newbtl.com

**Declaration**

**BTL** represents to the client that testing is done in accordance with standard procedures as applicable and that test instruments used has been calibrated with standards traceable to international standard(s) and/or national standard(s).

**BTL's** reports apply only to the specific samples tested under conditions. It is manufacture's responsibility to ensure that additional production units of this model are manufactured with the identical electrical and mechanical components. **BTL** shall have no liability for any declarations, inferences or generalizations drawn by the client or others from **BTL** issued reports.

This report is the confidential property of the client. As a mutual protection to the clients, the public and ourselves, the test report shall not be reproduced, except in full, without our written approval.

**BTL's** laboratory quality assurance procedures are in compliance with the **ISO/IEC 17025** requirements, and accredited by the conformity assessment authorities listed in this test report.

**BTL** is not responsible for the sampling stage, so the results only apply to the sample as received.

The information, data and test plan are provided by manufacturer which may affect the validity of results, so it is manufacturer's responsibility to ensure that the apparatus meets the essential requirements of applied standards and in all the possible configurations as representative of its intended use.

**Limitation**

For the use of the authority's logo is limited unless the Test Standard(s)/Scope(s)/Item(s) mentioned in this test report is (are) included in the conformity assessment authorities acceptance respective.

Please note that the measurement uncertainty is provided for informational purpose only and are not use in determining the Pass/Fail results.

**CONTENTS**

1	SUMMARY OF TEST RESULTS	5
1.1	TEST FACILITY	6
1.2	MEASUREMENT UNCERTAINTY	6
1.3	TEST ENVIRONMENT CONDITIONS	6
1.4	TABLE OF PARAMETERS OF TEST SOFTWARE SETTING	6
1.5	DUTY CYCLE	7
2	GENERAL INFORMATION	8
2.1	DESCRIPTION OF EUT	8
2.2	TEST MODES	10
2.3	BLOCK DIAGRAM SHOWING THE CONFIGURATION OF SYSTEM TESTED	11
2.4	SUPPORT UNITS	12
3	AC POWER LINE CONDUCTED EMISSIONS TEST	13
3.1	LIMIT	13
3.2	TEST PROCEDURE	13
3.3	DEVIATION FROM TEST STANDARD	13
3.4	TEST SETUP	14
3.5	TEST RESULT	14
4	RADIATED EMISSIONS TEST	15
4.1	LIMIT	15
4.2	TEST PROCEDURE	16
4.3	DEVIATION FROM TEST STANDARD	16
4.4	TEST SETUP	17
4.5	EUT OPERATING CONDITIONS	18
4.6	TEST RESULT – BELOW 30 MHZ	18
4.7	TEST RESULT – 30 MHZ TO 1 GHZ	18
4.8	TEST RESULT – ABOVE 1 GHZ	18
5	OUTPUT POWER TEST	19
5.1	LIMIT	19
5.2	TEST PROCEDURE	19
5.3	DEVIATION FROM STANDARD	19
5.4	TEST SETUP	19
5.5	EUT OPERATION CONDITIONS	19
5.6	TEST RESULTS	19
6	LIST OF MEASURING EQUIPMENTS	20
7	EUT TEST PHOTO	21
8	EUT PHOTOS	21
APPENDIX A	AC POWER LINE CONDUCTED EMISSIONS	22
APPENDIX B	RADIATED EMISSIONS - 30 MHZ TO 1 GHZ	27
APPENDIX C	RADIATED EMISSIONS - ABOVE 1 GHZ	30
APPENDIX D	OUTPUT POWER	47

**REVISION HISTORY**

Report No.	Version	Description	Issued Date
BTL-FCCP-1-2102T172A	R00	Original Report.	2021/4/27
BTL-FCCP-1-2102T172A	R01	Revised report to address TCB's comments.	2021/5/21
BTL-FCCP-1-2102T172A	R02	Revised report to address TCB's comments.	2021/5/31

## 1 SUMMARY OF TEST RESULTS

Test procedures according to the technical standards.

Standard(s) Section	Description	Test Result	Judgement	Remark
15.207	AC Power Line Conducted Emissions	APPENDIX A	Pass	-----
15.205 15.209 15.247(d)	Radiated Emissions	APPENDIX B APPENDIX C	Pass	-----
15.247 (a)(1)(iii)	Number of Hopping Frequency	NOTE (3)	Pass	-----
15.247 (a)(1)(iii)	Average Time of Occupancy	NOTE (3)	Pass	-----
15.247 (a)(1)	Hopping Channel Separation	NOTE (3)	Pass	-----
15.247 (a)(1)	Bandwidth	NOTE (3)	Pass	-----
15.247 (b)(1)	Output Power	APPENDIX D	Pass	-----
15.247(d)	Antenna conducted Spurious Emission	NOTE (3)	Pass	-----
15.203	Antenna Requirement	-----	Pass	-----

**NOTE:**

- (1) "N/A" denotes test is not applicable in this Test Report.
- (2) The report format version is TP.1.1.1.
- (3) This item is demonstrated to full compliance referring to the test report number 181210-03.TR05 of the integrated module (model name: AX200NGW, FCC ID: PD9AX200NG), according to KDB 996369 D02 Q1 a) 2).
- (4) The ac power lines conducted emissions and radiated emissions are tested to demonstrate full compliance of both module integrated into the host and host itself.
- (5) The output power of integrated module have been reduced, therefore, the full output power tests are performed and recorded.

### 1.1 TEST FACILITY

The test facilities used to collect the test data in this report:

No. 68-1, Ln. 169, Sec. 2, Datong Rd., Xizhi Dist., New Taipei City 221, Taiwan

The test sites and facilities are covered under FCC RN: 674415 and DN: TW0659.

- C05       CB08       CB11       CB15       CB16  
 SR05

### 1.2 MEASUREMENT UNCERTAINTY

The reported uncertainty of measurement  $y \pm U$ , where expanded uncertainty  $U$  is based on a standard uncertainty multiplied by a coverage factor of  $k = 2$ , providing a level of confidence of approximately **95 %**. The measurement instrumentation uncertainty considerations contained in CISPR 16-4-2. The BTL measurement uncertainty is less than the CISPR 16-4-2  $U_{cispr}$  requirement.

#### A. AC power line conducted emissions test:

Test Site	Method	Measurement Frequency Range	U (dB)
C05	CISPR	150 kHz ~ 30MHz	3.44

#### B. Radiated emissions test :

Test Site	Measurement Frequency Range	U,(dB)
CB15	0.03 GHz ~ 0.2 GHz	4.17
	0.2 GHz ~ 1 GHz	4.72
	1 GHz ~ 6 GHz	5.21
	6 GHz ~ 18 GHz	5.51
	18 GHz ~ 26 GHz	3.69
	26 GHz ~ 40 GHz	4.23

#### C. Conducted test :

Test Item	U,(dB)
Output Power	1.06

#### NOTE:

Unless specifically mentioned, the uncertainty of measurement has not been taken into account to declare the compliance or non-compliance to the specification.

### 1.3 TEST ENVIRONMENT CONDITIONS

Test Item	Environment Condition	Test Voltage	Tested by
AC Power Line Conducted Emissions	20 °C, 72 %	AC 120V	Vincent Lee
Radiated emissions below 1 GHz	Refer to data	AC 120V	Jay Kao
Radiated emissions above 1 GHz	Refer to data	AC 120V	Jay Kao
Output Power	25.8 °C, 54 %	AC 120V	Tim Lee

### 1.4 TABLE OF PARAMETERS OF TEST SOFTWARE SETTING

Test Software	DRTU V.12.1947.0-10428			
Modulation Mode	2402 MHz	2441 MHz	2480 MHz	Data Rate
GFSK	16	16	16	1 Mbps
$\pi/4$ -DQPSK	16	16	16	2 Mbps
8DPSK	16	16	16	3 Mbps

## 1.5 DUTY CYCLE

If duty cycle is  $\geq 98\%$ , duty factor is not required.  
 If duty cycle is  $< 98\%$ , duty factor shall be considered.

Remark	Delta 1			Delta 2	On Time/Period	10 log(1/Duty Cycle)
Mode	ON (ms)	Numbers (ON)	On Time (B) (ms)	Period (ON+OFF) (ms)	Duty Cycle (%)	Duty Factor (dB)
BT(1 Mbps)	2.884	1	2.884	3.750	76.91%	1.14
BT(3 Mbps)	2.891	1	2.891	3.750	77.09%	1.13

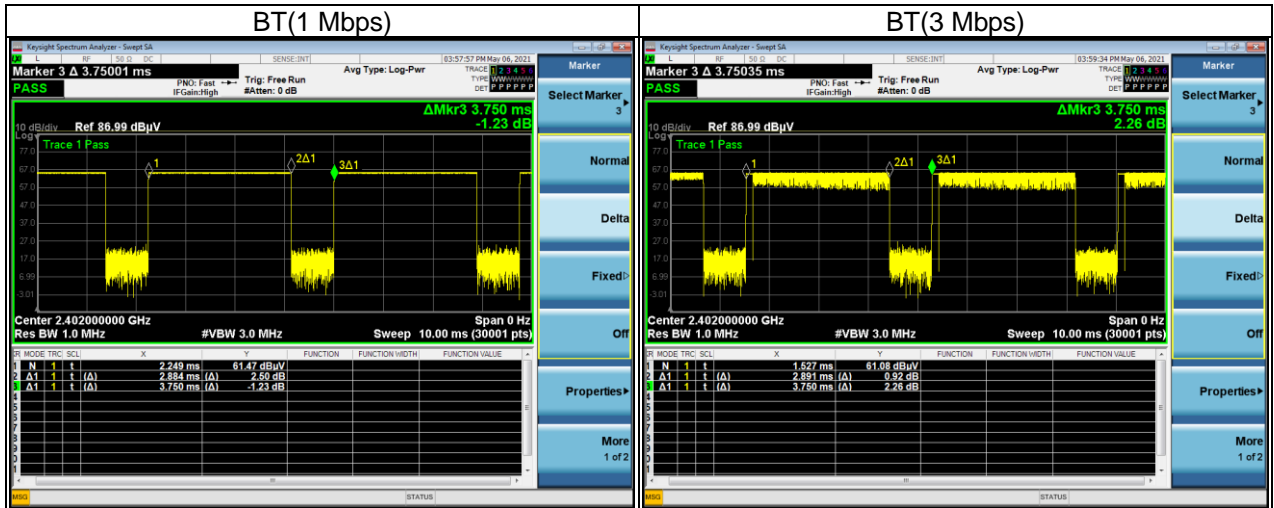

## 2 GENERAL INFORMATION

### 2.1 DESCRIPTION OF EUT

Equipment	Notebook Computer
Model Name	Lenovo 300w Gen 3xxxxxxx (The "x" in model name can be 0 to 9, A to Z, a to z, "-" or blank, for marketing purpose only)
Brand Name	Lenovo
Model Difference	Different model distribute to different area.
Power Source	DC voltage supplied from External Power Supply. (Lenovo/ADLX45YLC3D)
Power Rating	I/P: 100-240V~1.3A 50-60Hz O/P: 20.0V---2.25A 45.0W / 15.0V---3.0A / 9.0V---2.0A / 5.0V---2.0A 10.0W
Products Covered	1 * Adapter: Lenovo/ADLX45YLC3D
WIFI+BT Module	Intel® Wi-Fi 6 AX200 / AX200NGW
WWAN Module	Fibocom / L850-GL
Operation Band	2400 MHz ~ 2483.5 MHz
Operation Frequency	2402 MHz ~ 2480 MHz
Modulation Technology	FHSS
Modulation Type	GFSK, $\pi/4$ -DQPSK, 8DPSK
Transfer Rate	1 Mbps, 2 Mbps, 3 Mbps
Maximum Output Power	1 Mbps: 11.05 dBm (0.0127 W) 2 Mbps: 10.48 dBm (0.0112 W) 3 Mbps: 10.47 dBm (0.0111 W)
Test Model	Lenovo 300w Gen 3
Sample Status	Engineering Sample
EUT Modification(s)	N/A

**NOTE:**

- (1) For a more detailed features description, please refer to the manufacturer's specifications or the user's manual.



## (2) Channel List:

Channel	Frequency (MHz)	Channel	Frequency (MHz)	Channel	Frequency (MHz)
00	2402	27	2429	54	2456
01	2403	28	2430	55	2457
02	2404	29	2431	56	2458
03	2405	30	2432	57	2459
04	2406	31	2433	58	2460
05	2407	32	2434	59	2461
06	2408	33	2435	60	2462
07	2409	34	2436	61	2463
08	2410	35	2437	62	2464
09	2411	36	2438	63	2465
10	2412	37	2439	64	2466
11	2413	38	2440	65	2467
12	2414	39	2441	66	2468
13	2415	40	2442	67	2469
14	2416	41	2443	68	2470
15	2417	42	2444	69	2471
16	2418	43	2445	70	2472
17	2419	44	2446	71	2473
18	2420	45	2447	72	2474
19	2421	46	2448	73	2475
20	2422	47	2449	74	2476
21	2423	48	2450	75	2477
22	2424	49	2451	76	2478
23	2425	50	2452	77	2479
24	2426	51	2453	78	2480
25	2427	52	2454		
26	2428	53	2455		

## (3) Table for Filed Antenna:

Antenna	Manufacture	Part Number	Type	Connector	Frequency Range (MHz)	Gain (dBi)
Main	INPAQ Corporation	025.901U1.0001	PIFA	I-PEX	2400-2500	-1.26
					5150-5350	0.41
					5470-5725	0.28
					5725-5850	1.06
Aux	INPAQ Corporation	025.901U2.0001	PIFA	I-PEX	2400-2500	-1.46
					5150-5350	0.65
					5470-5725	-0.25
					5725-5850	0.15

Antenna	Manufacture	Part Number	Type	Connector	Frequency Range (MHz)	Gain (dBi)
Main	AWAN	025.901U3.0001	PIFA	I-PEX	2400-2500	0.93
					5150-5350	0.58
					5470-5725	1.68
					5725-5850	0.86
Aux	AWAN	025.901U4.0001	PIFA	I-PEX	2400-2500	1.52
					5150-5350	0.62
					5470-5725	0.93
					5725-5850	0.93

NOTE: Since the antenna gain of Antenna \_ AWAN is the highest one among all, Antenna \_ AWAN had used for testing.

**2.2 TEST MODES**

Test Items	Test mode	Channel	Note
AC power line conducted emissions	Normal/Idle	-	-
Transmitter Radiated Emissions (below 1GHz)	3 Mbps	78	-
Transmitter Radiated Emissions (above 1GHz)	1/3 Mbps	00/78	Bandedge
	1/3 Mbps	00/39/78	Harmonic
Output Power	1/2/3 Mbps	00/39/78	-

**NOTE:**

- (1) The Radiated emissions test was verified based on the worst conducted power and Bandwidth test results reported in the original report.
- (2) For radiated emission band edge test, both Vertical and Horizontal are evaluated, but only the worst case (Horizontal) is recorded.
- (3) All X, Y and Z axes are evaluated, but only the worst case (Y axis) is recorded.

**2.3 BLOCK DIAGRAM SHOWING THE CONFIGURATION OF SYSTEM TESTED**

Equipment letters and Cable numbers refer to item numbers described in the tables of clause 2.4.

AC Power Line Conducted Emissions Test

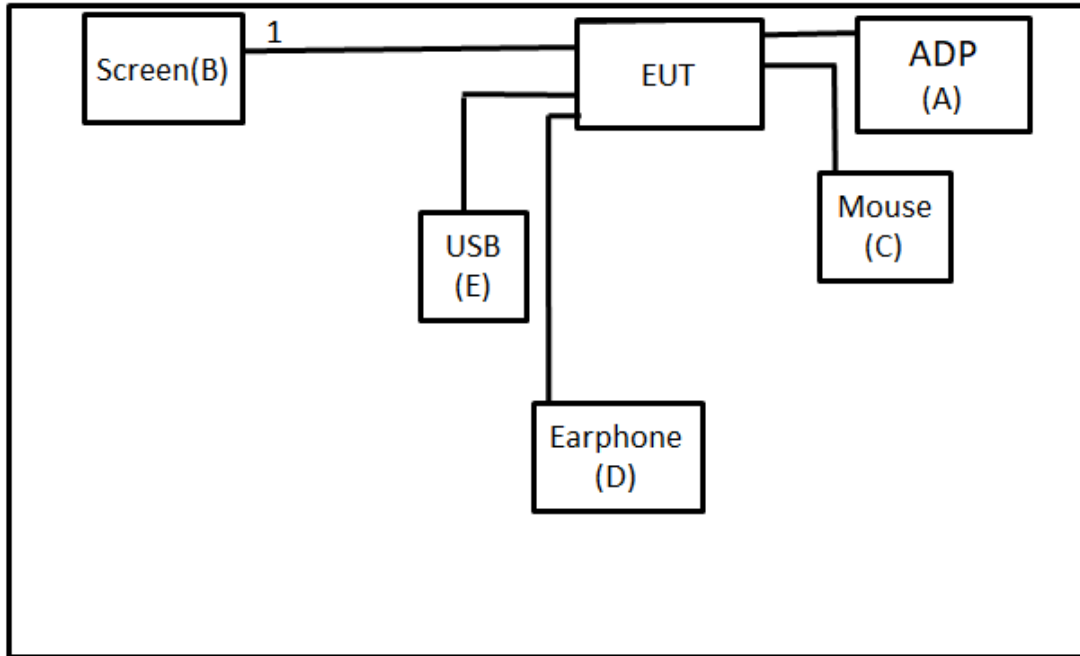

Radiated Emissions Test

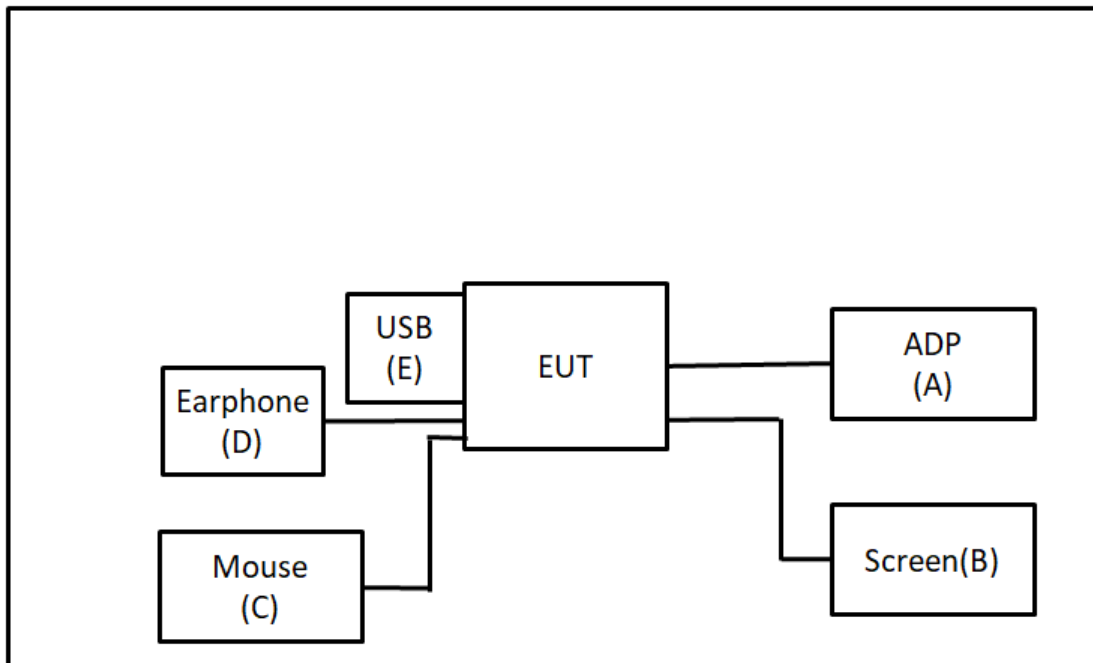

**2.4 SUPPORT UNITS**

Item	Equipment	Brand	Model No.	Series No.	Remarks
A	ADP	Lenovo	ADLX45YLC3D	N/A	Supplied by test requester.
B	Screen	ASUS	MX27U	N/A	Furnished by test lab.
C	Mouse	ACER	MP-368	N/A	Furnished by test lab.
D	Earphone	Sony	MDR-E9LP	N/A	Furnished by test lab.
E	USB	Kingston	C7052-322.AOOL F	N/A	Furnished by test lab.

Item	Shielded	Ferrite Core	Length	Cable Type	Remarks
1	N/A	N/A	1.8m	HDMI Cable	Furnished by test lab.

### 3 AC POWER LINE CONDUCTED EMISSIONS TEST

#### 3.1 LIMIT

Frequency (MHz)	Limit (dB $\mu$ V)	
	Quasi-peak	Average
0.15 - 0.5	66 - 56 *	56 - 46 *
0.50 - 5.0	56	46
5.0 - 30.0	60	50

**NOTE:**

- (1) The tighter limit applies at the band edges.
- (2) The limit of " \* " marked band means the limitation decreases linearly with the logarithm of the frequency in the range.
- (3) The test result calculated as following:  
 Measurement Value = Reading Level + Correct Factor  
 Correct Factor = Insertion Loss + Cable Loss + Attenuator Factor (if use)  
 Margin Level = Measurement Value – Limit Value  
 Calculation example:

Reading Level		Correct Factor		Measurement Value
38.22	+	3.45	=	41.67

Measurement Value		Limit Value		Margin Level
41.67	-	60	=	-18.33

The following table is the setting of the receiver.

Receiver Parameter	Setting
Attenuation	10 dB
Start Frequency	0.15 MHz
Stop Frequency	30 MHz
IF Bandwidth	9 KHz

#### 3.2 TEST PROCEDURE

- a. The EUT was placed 0.8 m above the horizontal ground plane with the EUT being connected to the power mains through a line impedance stabilization network (LISN).  
 All other support equipment were powered from an additional LISN(s).  
 The LISN provides 50 Ohm/50uH of impedance for the measuring instrument.
- b. Interconnecting cables that hang closer than 40 cm to the ground plane shall be folded back and forth in the center forming a bundle to keep the cable above 40 cm.
- c. Excess I/O cables that are not connected to a peripheral shall be bundled in the center.  
 The end of the cable will be terminated, using the correct terminating impedance.  
 The overall length shall not exceed 1 m.
- d. The LISN is spaced at least 80 cm from the nearest part of the EUT chassis.
- e. For the actual test configuration, please refer to the related Item - EUT TEST PHOTO.

**NOTE:**

- (1) In the results, each reading is marked as Peak, QP or AVG per the detector used.  
 BW=9 kHz (6 dB Bandwidth)
- (2) All readings are Peak unless otherwise stated QP or AVG in column of Note. Both the QP and the AVG readings must be less than the limit for compliance.

#### 3.3 DEVIATION FROM TEST STANDARD

No deviation.

### 3.4 TEST SETUP

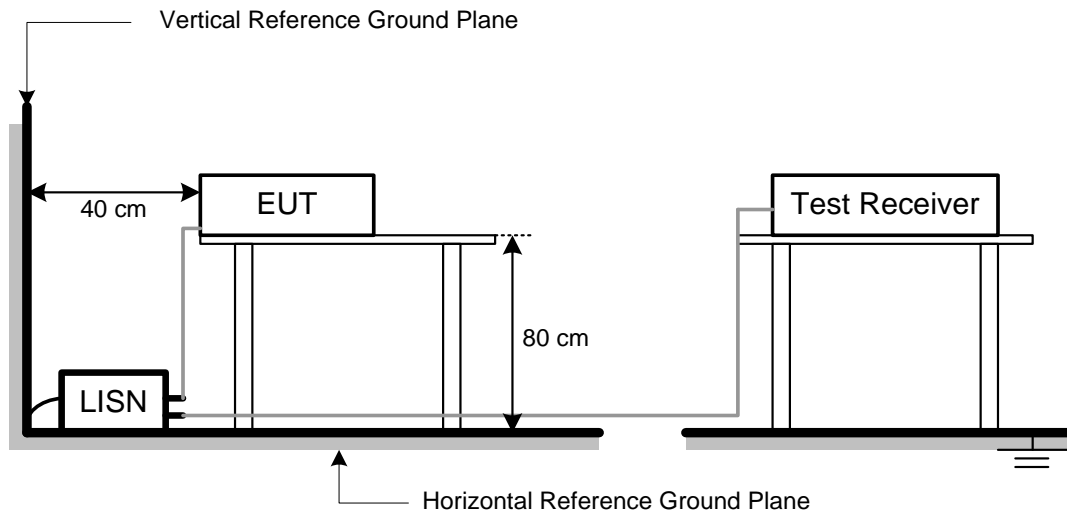

### 3.5 TEST RESULT

Please refer to the APPENDIX A.

## 4 RADIATED EMISSIONS TEST

### 4.1 LIMIT

In case the emission fall within the restricted band specified on 15.205, then the 15.209 limit in the table below has to be followed.

#### LIMITS OF RADIATED EMISSIONS MEASUREMENT (9 kHz to 1000 MHz)

Frequency (MHz)	Field Strength (microvolts/meter)	Measurement Distance (meters)
0.009~0.490	2400/F(KHz)	300
0.490~1.705	24000/F(KHz)	30
1.705~30.0	30	30
30~88	100	3
88~216	150	3
216~960	200	3
960~1000	500	3

#### LIMITS OF RADIATED EMISSIONS MEASUREMENT (Above 1000 MHz)

Frequency (MHz)	Radiated Emissions (dBuV/m)		Measurement Distance (meters)
	Peak	Average	
Above 1000	74	54	3

#### NOTE:

- (1) The limit for radiated test was performed according to FCC Part 15, Subpart C.
- (2) The tighter limit applies at the band edges.
- (3) Emission level (dBuV/m)=20log Emission level (uV/m).
- (4) The test result calculated as following:

Measurement Value = Reading Level + Correct Factor

Correct Factor = Antenna Factor + Cable Loss - Amplifier Gain(if use)

Margin Level = Measurement Value - Limit Value

Calculation example:

Reading Level		Correct Factor		Measurement Value
19.11	+	2.11	=	21.22

Measurement Value		Limit Value		Margin Level
21.22	-	54	=	-32.78

Spectrum Parameter	Setting
Attenuation	Auto
Start Frequency	1000 MHz
Stop Frequency	10th carrier harmonic
RBW / VBW (Emission in restricted band)	1MHz / 3MHz for Peak, 1MHz / 1/T for Average

Spectrum Parameter	Setting
Attenuation	Auto
Start ~ Stop Frequency	9KHz~90KHz for PK/AVG detector
Start ~ Stop Frequency	90KHz~110KHz for QP detector
Start ~ Stop Frequency	110KHz~490KHz for PK/AVG detector
Start ~ Stop Frequency	490KHz~30MHz for QP detector
Start ~ Stop Frequency	30MHz~1000MHz for QP detector

#### 4.2 TEST PROCEDURE

- a. The measuring distance of 3 m shall be used for measurements. The EUT was placed on the top of a rotating table 0.8 meter above the ground at a 3 meter semi-anechoic chamber. The table was rotated 360 degrees to determine the position of the highest radiation.(below 1GHz)
- b. The measuring distance of 3 m shall be used for measurements. The EUT was placed on the top of a rotating table 1.5 meter above the ground at a 3 meter semi-anechoic chamber. The table was rotated 360 degrees to determine the position of the highest radiation.(above 1GHz)
- c. The height of the equipment or of the substitution antenna shall be 0.8 m or 1.5 m, the height of the test antenna shall vary between 1 m to 4 m. Both horizontal and vertical polarizations of the antenna are set to make the measurement.
- d. For each suspected emission, the EUT was arranged to its worst case and then the antenna was tuned to heights find the maximum reading (used Bore sight function).
- e. The receiver system was set to peak and average detect function and specified bandwidth with maximum hold mode when the test frequency is above 1GHz.
- f. The initial step in collecting radiated emission data is a receiver peak detector mode pre-scanning the measurement frequency range. Significant peaks are then marked and then Quasi Peak detector mode re-measured.
- g. All readings are Peak unless otherwise stated QP in column of Note. Peak denotes that the Peak reading compliance with the QP Limits and then QP Mode measurement didn't perform. (below 1GHz)
- h. All readings are Peak Mode value unless otherwise stated AVG in column of Note. If the Peak Mode Measured value compliance with the Peak Limits and lower than AVG Limits, the EUT shall be deemed to meet both Peak & AVG Limits and then only Peak Mode was measured, but AVG Mode didn't perform. (above 1GHz)
- i. For the actual test configuration, please refer to the related Item – EUT TEST PHOTO.

#### 4.3 DEVIATION FROM TEST STANDARD

No deviation.



## 4.4 TEST SETUP

9 kHz to 30 MHz

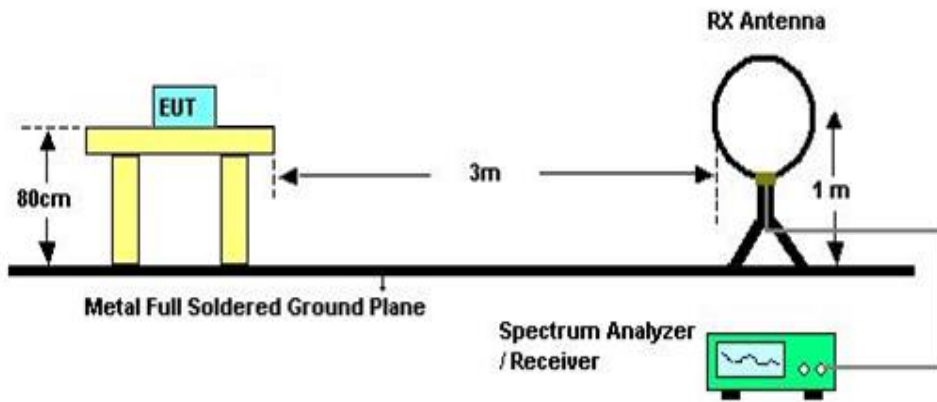

30 MHz to 1 GHz

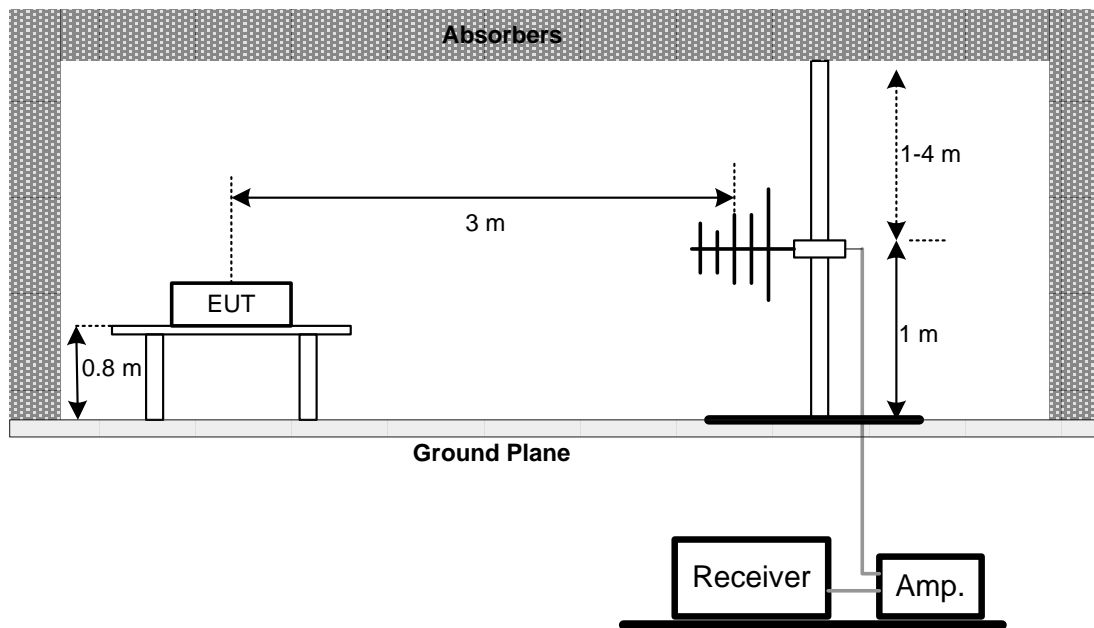

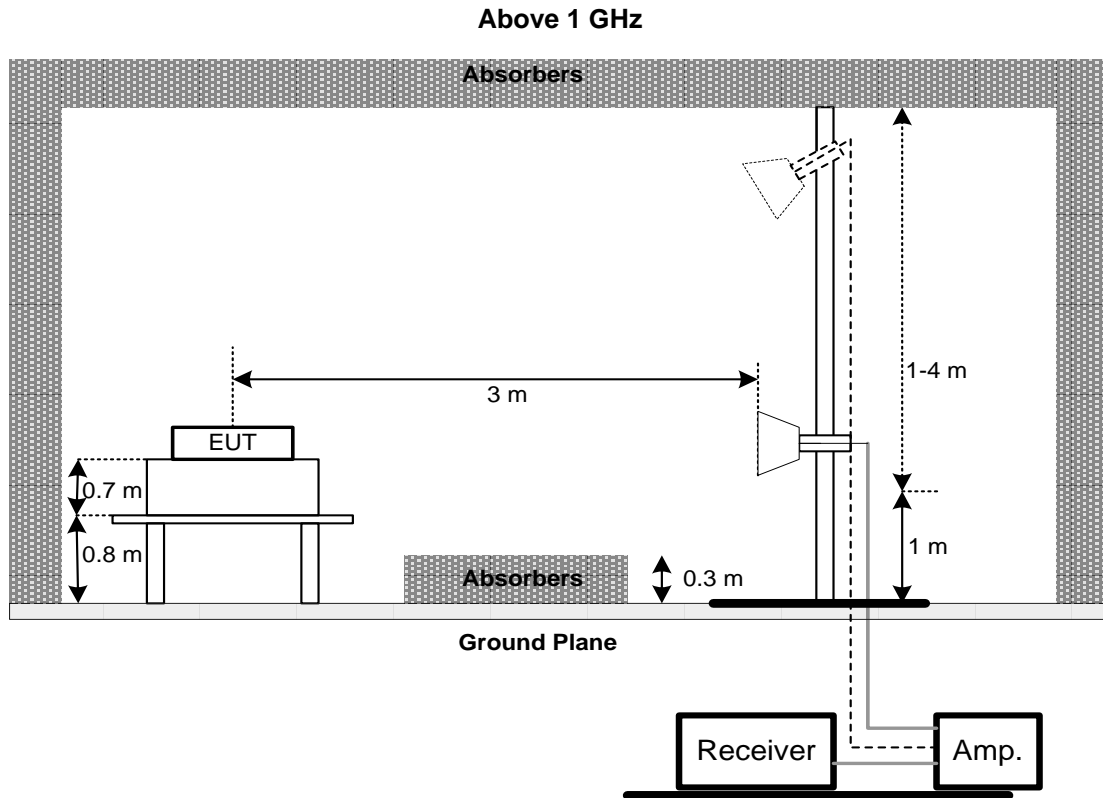

#### 4.5 EUT OPERATING CONDITIONS

The EUT was programmed to be in continuously transmitting mode.

#### 4.6 TEST RESULT – BELOW 30 MHZ

There were no emissions found below 30 MHz within 20 dB of the limit.

#### 4.7 TEST RESULT – 30 MHZ TO 1 GHZ

Please refer to the APPENDIX B.

#### 4.8 TEST RESULT – ABOVE 1 GHZ

Please refer to the APPENDIX C.

#### NOTE:

- (1) No limit: This is fundamental signal, the judgment is not applicable. For fundamental signal judgment was referred to Peak output test.

## 5 OUTPUT POWER TEST

### 5.1 LIMIT

FCC Part15 (15.247) , Subpart C				
Section	Test Item	Limit	Frequency Range (MHz)	Result
15.247(b)(1)	Maximum peak conducted output power	0.125 Watts (20.97 dBm)	2400-2483.5	PASS

### 5.2 TEST PROCEDURE

- The EUT was directly connected to the power meter and antenna output port as show in the block diagram below.
- The maximum peak conducted output power was performed in accordance with method 9 b) of FCC KDB 558074 D01 DTS Meas Guidance.

### 5.3 DEVIATION FROM STANDARD

No deviation.

### 5.4 TEST SETUP



### 5.5 EUT OPERATION CONDITIONS

The EUT was programmed to be in continuously transmitting mode.

### 5.6 TEST RESULTS

Please refer to the APPENDIX D.

## 6 LIST OF MEASURING EQUIPMENTS

AC Power Line Conducted Emissions						
Item	Kind of Equipment	Manufacturer	Type No.	Serial No.	Calibrated Date	Calibrated Until
1	TWO-LINE V-NETWORK	R&S	ENV216	101050	2020/6/11	2021/6/10
2	Test Cable	EMCI	EMC400-BM-BM-5000	170501	2020/6/8	2021/6/7
3	EMI Test Receiver	R&S	ESCI	100080	2020/6/15	2021/6/14
4	Measurement Software	EZ	EZ EMC (Version NB-03A1-01)	N/A	N/A	N/A

Radiated Emissions						
Item	Kind of Equipment	Manufacturer	Type No.	Serial No.	Calibrated Date	Calibrated Until
1	Preamplifier	EMCI	EMC02325B	980217	2020/4/10	2021/4/9
2	Preamplifier	EMCI	EMC012645B	980267	2020/4/10	2021/4/9
3	Test Cable	EMCI	EMC-SM-SM-1000	180809	2020/4/10	2021/4/9
4	Test Cable	EMCI	EMC104-SM-SM-3000	151205	2020/4/10	2021/4/9
5	Test Cable	EMCI	EMC-SM-SM-7000	180408	2020/4/10	2021/4/9
6	MXE EMI Receiver	Agilent	N9038A	MY554200087	2020/6/10	2021/6/9
7	Signal Analyzer	Agilent	N9010A	MY56480554	2020/8/25	2021/8/24
8	Horn Ant	SCHWARZBECK	BBHA 9120D	9120D-1342	2020/6/12	2021/6/11
9	Horn Ant	Schwarzbeck	BBHA 9170	BBHA 9170340	2020/7/9	2021/7/8
10	Loop Ant	Electro-Metrics	EMCI-LPA600	274	2020/6/16	2021/6/15
11	Trilog-Broadband Antenna	Schwarzbeck	VULB 9168	VULB 9168-352	2020/7/24	2021/7/23
12	5dB Attenuator	EMCI	EMCI-N-6-05	AT-N0625	2020/7/24	2021/7/23
13	Measurement Software	EZ	EZ EMC (Version NB-03A1-01)	N/A	N/A	N/A

Output Power						
Item	Kind of Equipment	Manufacturer	Type No.	Serial No.	Calibrated Date	Calibrated Until
1	Power Meter	Anritsu	ML2487A	6K00004714	2020/9/3	2021/9/2
2	Power Sensor	Anritsu	MA2491A	034138	2020/9/3	2021/9/2

Remark: "N/A" denotes no model name, no serial no. or no calibration specified.  
All calibration period of equipment list is one year.

**7 EUT TEST PHOTO**

Please refer to document Appendix No.: TP-2102T172A-FCCP-1 (APPENDIX-TEST PHOTOS).

**8 EUT PHOTOS**

Please refer to document Appendix No.: EP-2102T172A-2 (APPENDIX-EUT PHOTOS).

## **APPENDIX A AC POWER LINE CONDUCTED EMISSIONS**

Test Mode	Normal	Tested Date	2021/3/23
Test Frequency	-	Phase	Line

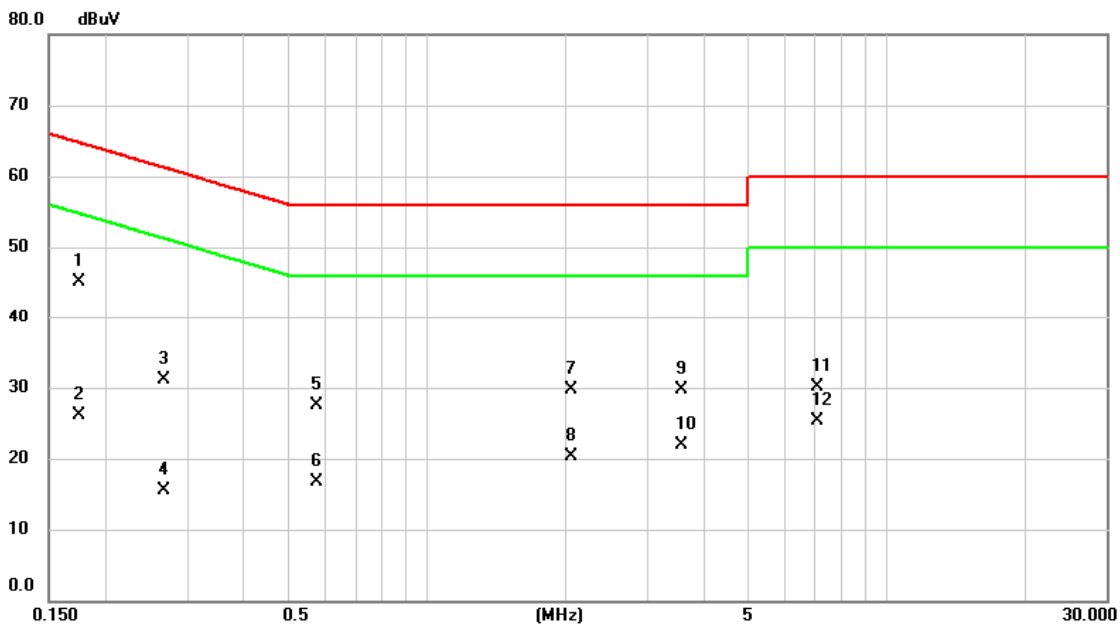

No.	Mk.	Freq.	Reading Level	Correct Factor	Measurement	Limit	Over	Detector	Comment
		MHz	dBuV	dB	dBuV	dBuV	dB		
1	*	0.1747	35.36	9.68	45.04	64.73	-19.69	QP	
2		0.1747	16.48	9.68	26.16	54.73	-28.57	AVG	
3		0.2672	21.47	9.68	31.15	61.20	-30.05	QP	
4		0.2672	5.76	9.68	15.44	51.20	-35.76	AVG	
5		0.5752	17.84	9.68	27.52	56.00	-28.48	QP	
6		0.5752	7.00	9.68	16.68	46.00	-29.32	AVG	
7		2.0535	19.96	9.74	29.70	56.00	-26.30	QP	
8		2.0535	10.58	9.74	20.32	46.00	-25.68	AVG	
9		3.5587	20.01	9.78	29.79	56.00	-26.21	QP	
10		3.5587	12.22	9.78	22.00	46.00	-24.00	AVG	
11		7.0912	20.15	9.87	30.02	60.00	-29.98	QP	
12		7.0912	15.36	9.87	25.23	50.00	-24.77	AVG	

**REMARKS:**

(1) Measurement Value = Reading Level + Correct Factor.

(2) Margin Level = Measurement Value - Limit Value.

Test Mode	Normal	Tested Date	2021/3/23
Test Frequency	-	Phase	Neutral

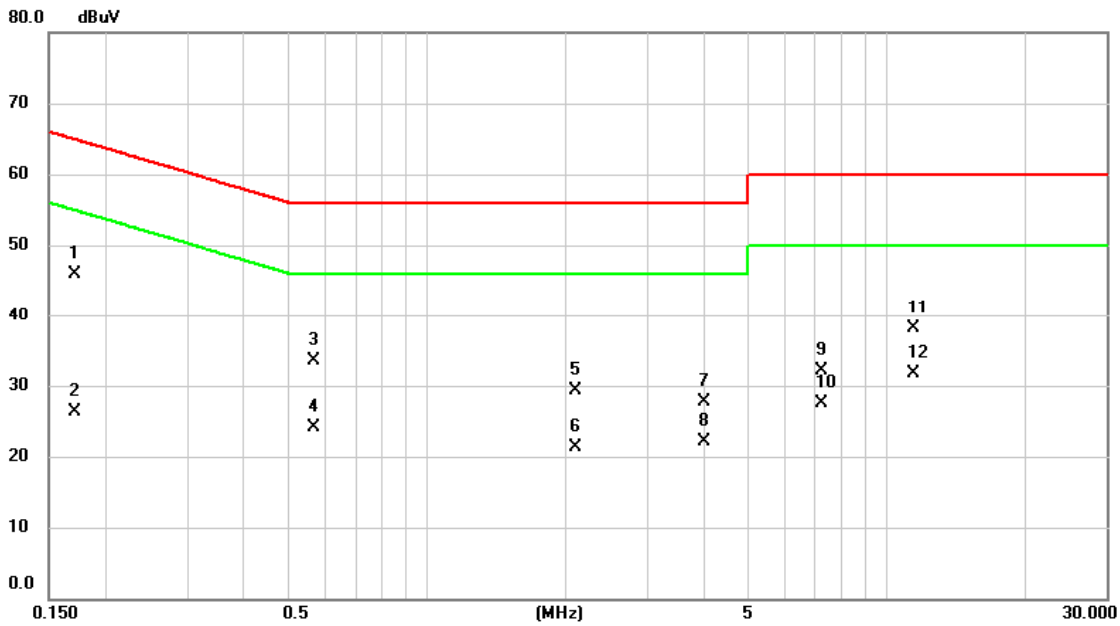

No.	Mk.	Freq.	Reading Level	Correct Factor	Measurement	Limit	Over	Detector	Comment
		MHz	dBuV	dB	dBuV	dBuV	dB		
1		0.1712	36.19	9.68	45.87	64.90	-19.03	QP	
2		0.1712	16.58	9.68	26.26	54.90	-28.64	AVG	
3		0.5685	23.78	9.68	33.46	56.00	-22.54	QP	
4		0.5685	14.34	9.68	24.02	46.00	-21.98	AVG	
5		2.1053	19.56	9.74	29.30	56.00	-26.70	QP	
6		2.1053	11.62	9.74	21.36	46.00	-24.64	AVG	
7		3.9818	17.99	9.79	27.78	56.00	-28.22	QP	
8		3.9818	12.31	9.79	22.10	46.00	-23.90	AVG	
9		7.2173	22.18	9.87	32.05	60.00	-27.95	QP	
10		7.2173	17.72	9.87	27.59	50.00	-22.41	AVG	
11		11.4428	28.24	9.93	38.17	60.00	-21.83	QP	
12	*	11.4428	21.73	9.93	31.66	50.00	-18.34	AVG	

**REMARKS:**

(1) Measurement Value = Reading Level + Correct Factor.

(2) Margin Level = Measurement Value - Limit Value.



Test Mode	Idle	Tested Date	2021/3/23
Test Frequency	-	Phase	Line

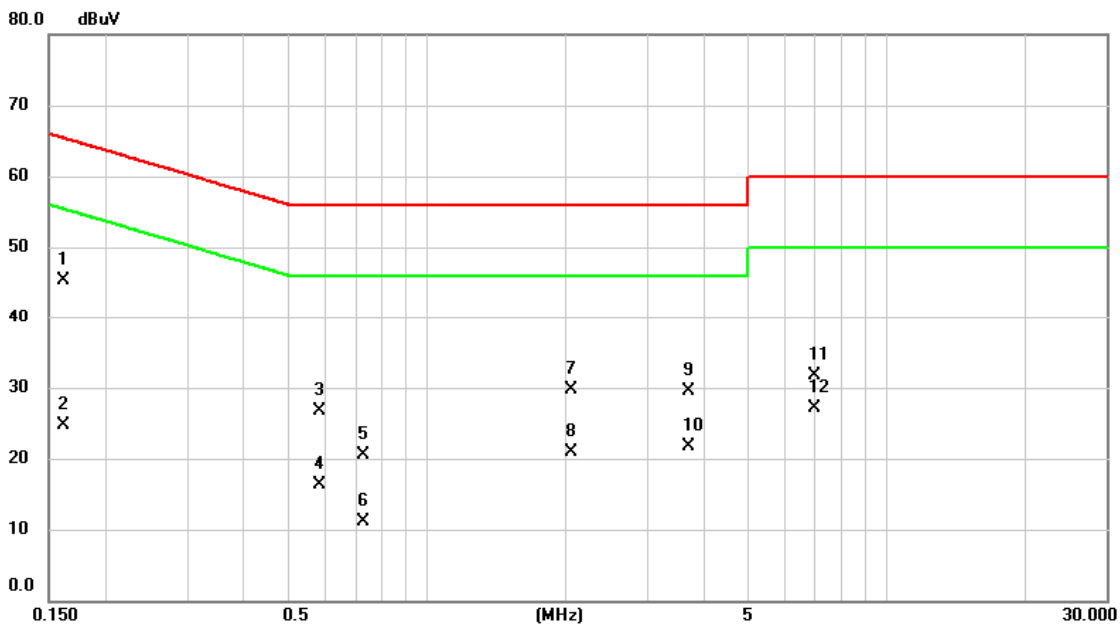

No.	Mk.	Freq. MHz	Reading Level dBuV	Correct Factor dB	Measure- ment dBuV	Limit dBuV	Over dB	Detector	Comment
1	*	0.1615	35.54	9.68	45.22	65.39	-20.17	QP	
2		0.1615	15.09	9.68	24.77	55.39	-30.62	AVG	
3		0.5842	16.94	9.68	26.62	56.00	-29.38	QP	
4		0.5842	6.65	9.68	16.33	46.00	-29.67	AVG	
5		0.7260	10.73	9.68	20.41	56.00	-35.59	QP	
6		0.7260	1.35	9.68	11.03	46.00	-34.97	AVG	
7		2.0603	20.06	9.74	29.80	56.00	-26.20	QP	
8		2.0603	11.10	9.74	20.84	46.00	-25.16	AVG	
9		3.6870	19.73	9.79	29.52	56.00	-26.48	QP	
10		3.6870	11.97	9.79	21.76	46.00	-24.24	AVG	
11		6.9720	21.83	9.87	31.70	60.00	-28.30	QP	
12		6.9720	17.15	9.87	27.02	50.00	-22.98	AVG	

**REMARKS:**

(1) Measurement Value = Reading Level + Correct Factor.

(2) Margin Level = Measurement Value - Limit Value.

Test Mode	Idle	Tested Date	2021/3/23
Test Frequency	-	Phase	Neutral

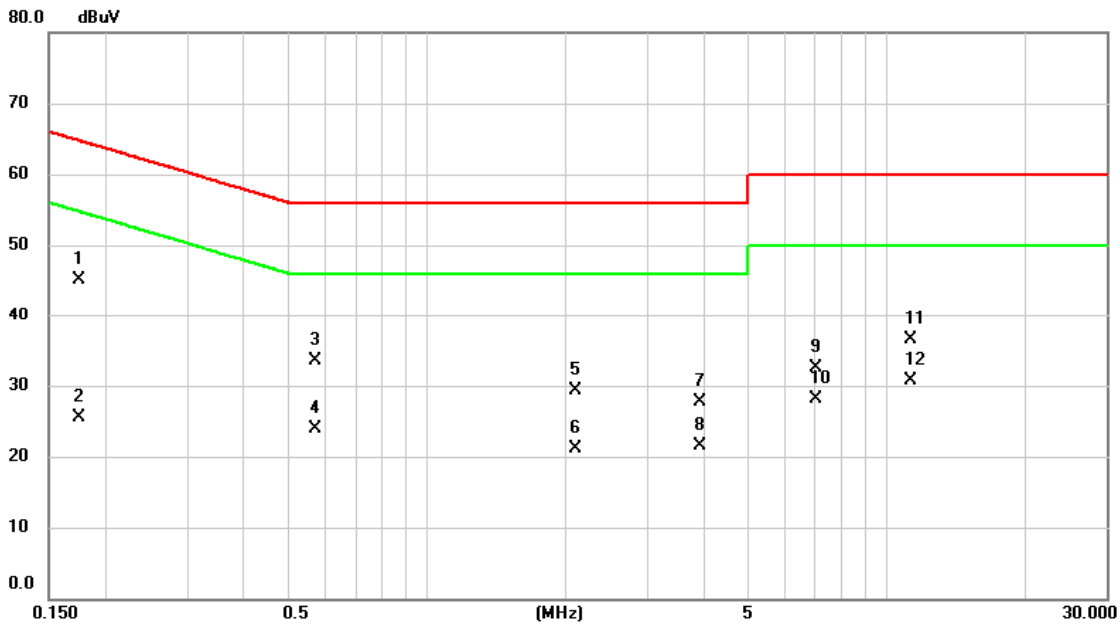

No.	Mk.	Freq.	Reading Level	Correct Factor	Measurement	Limit	Over	Detector	Comment
		MHz	dBuV	dB	dBuV	dBuV	dB		
1		0.1748	35.33	9.68	45.01	64.73	-19.72	QP	
2		0.1748	15.81	9.68	25.49	54.73	-29.24	AVG	
3		0.5707	23.77	9.68	33.45	56.00	-22.55	QP	
4		0.5707	14.14	9.68	23.82	46.00	-22.18	AVG	
5		2.0963	19.54	9.74	29.28	56.00	-26.72	QP	
6		2.0963	11.44	9.74	21.18	46.00	-24.82	AVG	
7		3.9120	17.88	9.79	27.67	56.00	-28.33	QP	
8		3.9120	11.79	9.79	21.58	46.00	-24.42	AVG	
9		7.0328	22.62	9.87	32.49	60.00	-27.51	QP	
10		7.0328	18.15	9.87	28.02	50.00	-21.98	AVG	
11		11.3100	26.60	9.93	36.53	60.00	-23.47	QP	
12	*	11.3100	20.79	9.93	30.72	50.00	-19.28	AVG	

**REMARKS:**

(1) Measurement Value = Reading Level + Correct Factor.

(2) Margin Level = Measurement Value - Limit Value.

## **APPENDIX B    RADIATED EMISSIONS - 30 MHZ TO 1 GHZ**

Test Mode	BT(3 Mbps)	Test Date	2021/3/24
Test Frequency	2480MHz	Polarization	Vertical
Temp	21°C	Hum.	68%

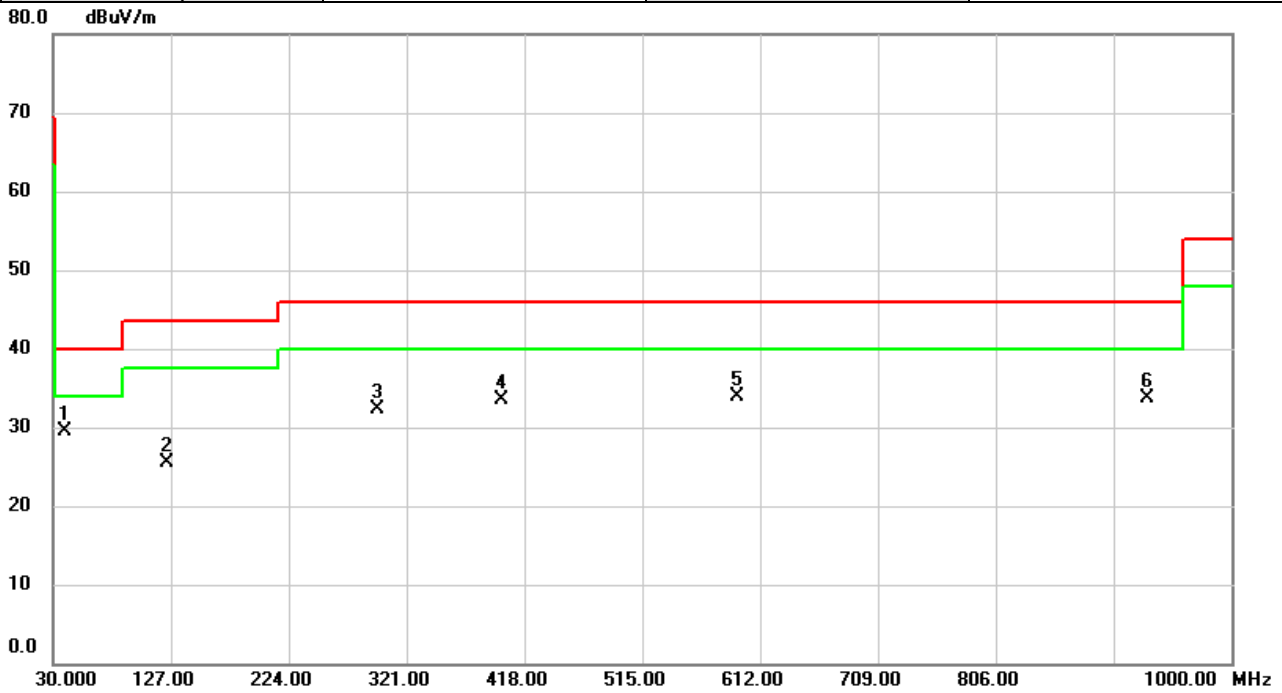

No.	Mk.	Freq.	Reading Level	Correct Factor	Measurement	Limit	Over	Detector	Comment
		MHz	dBuV	dB	dBuV/m	dBuV/m	dB		
1	*	39.0856	38.10	-8.62	29.48	40.00	-10.52	peak	
2		124.4133	35.59	-10.02	25.57	43.50	-17.93	peak	
3		296.7177	39.80	-7.46	32.34	46.00	-13.66	peak	
4		398.6323	38.34	-4.86	33.48	46.00	-12.52	peak	
5		593.4083	34.72	-0.79	33.93	46.00	-12.07	peak	
6		930.1600	29.01	4.71	33.72	46.00	-12.28	peak	

**REMARKS:**

- (1) Measurement Value = Reading Level + Correct Factor.
- (2) Margin Level = Measurement Value - Limit Value.

Test Mode	BT(3 Mbps)	Test Date	2021/3/24
Test Frequency	2480MHz	Polarization	Horizontal
Temp	21°C	Hum.	68%

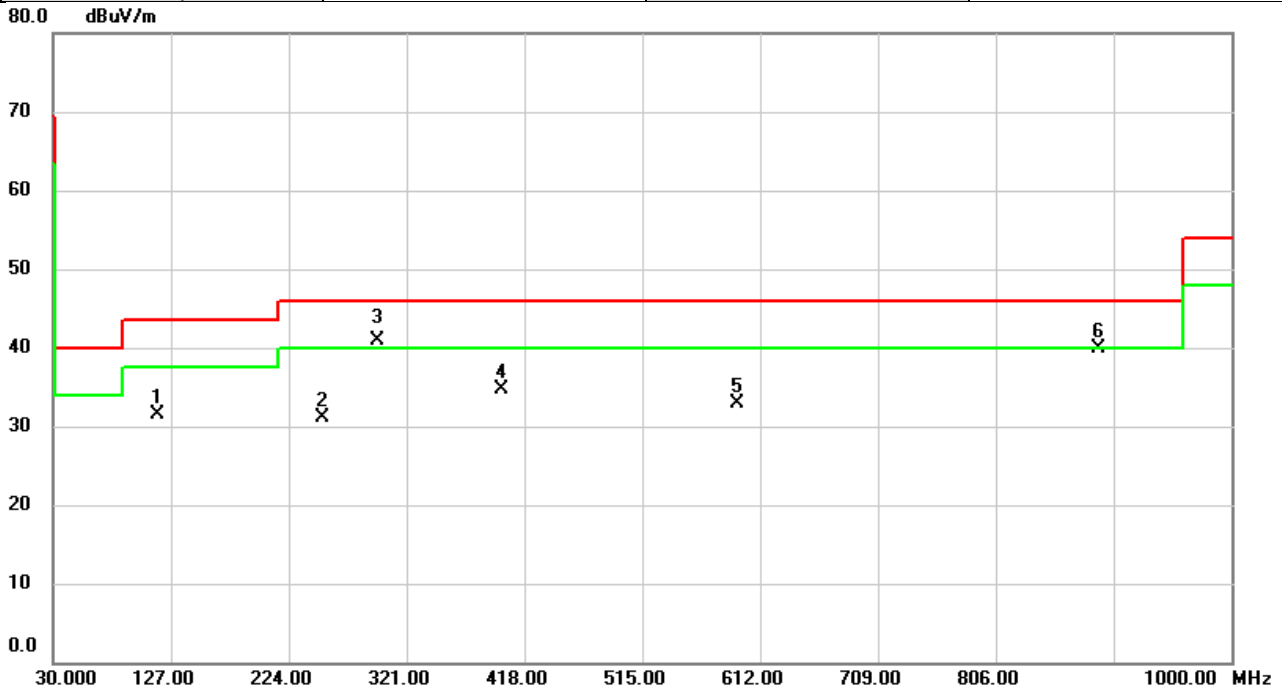

No.	Mk.	Freq.	Reading Level	Correct Factor	Measurement	Limit	Over	Detector	Comment
		MHz	dBuV	dB	dBuV/m	dBuV/m	dB		
1		115.4893	42.46	-10.89	31.57	43.50	-11.93	peak	
2		251.5157	40.25	-9.23	31.02	46.00	-14.98	peak	
3	*	296.7177	48.31	-7.46	40.85	46.00	-5.15	QP	
4		398.6323	39.66	-4.86	34.80	46.00	-11.20	peak	
5		593.4083	33.63	-0.79	32.84	46.00	-13.16	peak	
6		890.0990	35.89	4.00	39.89	46.00	-6.11	peak	

**REMARKS:**

- (1) Measurement Value = Reading Level + Correct Factor.
- (2) Margin Level = Measurement Value - Limit Value.

## **APPENDIX C RADIATED EMISSIONS - ABOVE 1 GHZ**

Test Mode	BT(1 Mbps)	Test Date	2021/3/22
Test Frequency	2402MHz	Polarization	Horizontal
Temp	23°C	Hum.	66%

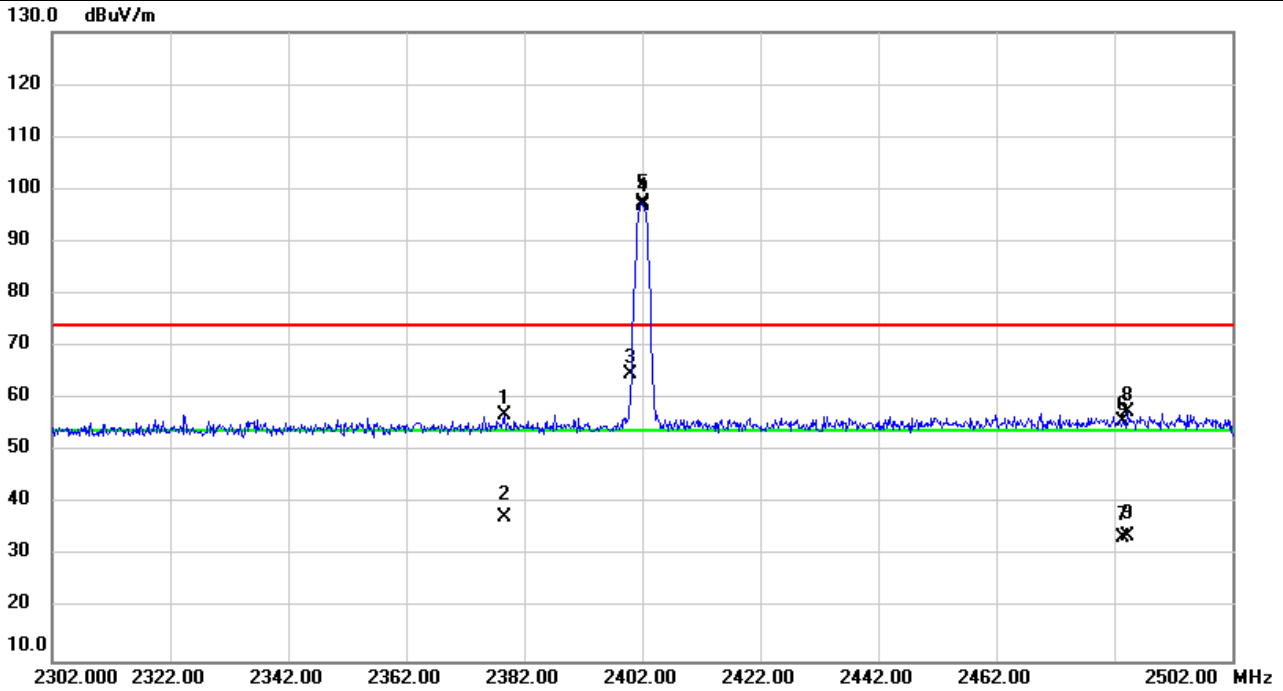

No.	Mk.	Freq.	Reading Level	Correct Factor	Measurement	Limit	Over	Detector	Comment
		MHz	dBuV	dB	dBuV/m	dBuV/m	dB		
1		2378.587	26.34	30.75	57.09	74.00	-16.91	peak	
2		2378.587	6.67	30.75	37.42	54.00	-16.58	AVG	
3		2400.000	33.89	30.83	64.72	74.00	-9.28	peak	
4	X	2402.000	66.48	30.84	97.32	74.00	23.32	peak	NoLimit
5	*	2402.000	65.99	30.84	96.83	54.00	42.83	AVG	NoLimit
6		2483.500	24.49	31.16	55.65	74.00	-18.35	peak	
7		2483.500	2.38	31.16	33.54	54.00	-20.46	AVG	
8		2484.287	26.31	31.17	57.48	74.00	-16.52	peak	
9		2484.287	2.82	31.17	33.99	54.00	-20.01	AVG	

**REMARKS:**

(1) Measurement Value = Reading Level + Correct Factor.

(2) Margin Level = Measurement Value - Limit Value.

Test Mode	BT(1 Mbps)	Test Date	2021/3/22
Test Frequency	2480MHz	Polarization	Horizontal
Temp	23°C	Hum.	66%

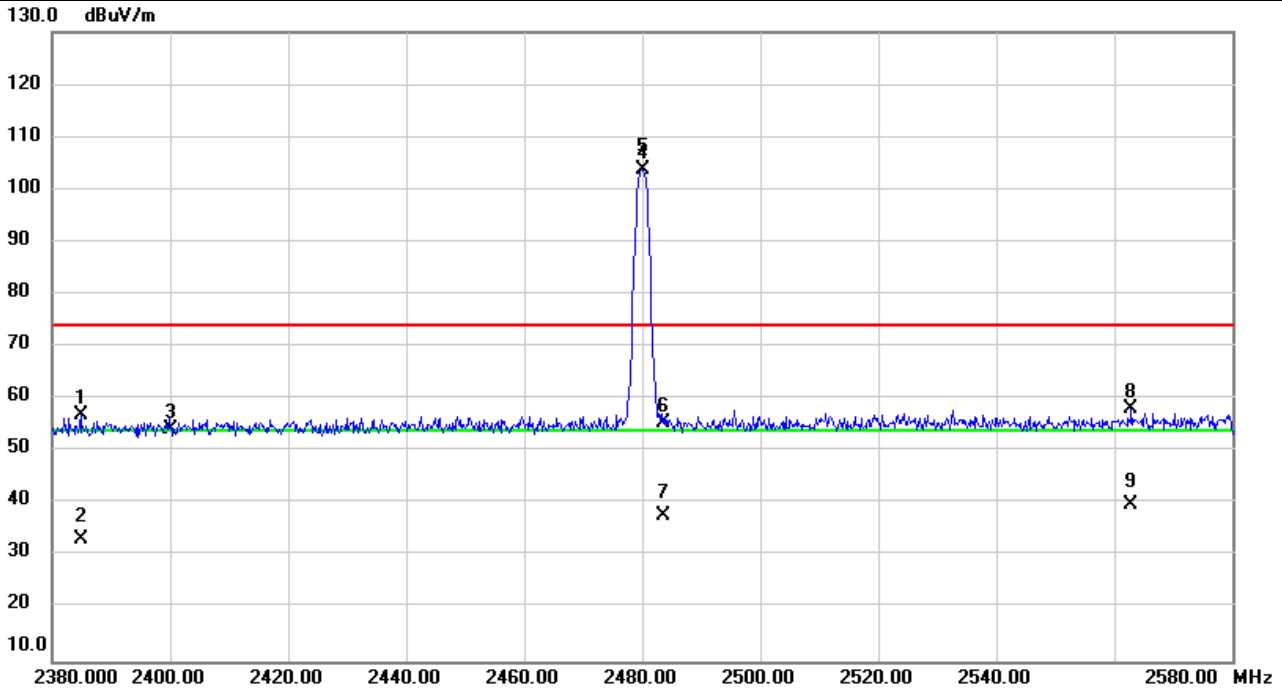

No.	Mk.	Freq.	Reading Level	Correct Factor	Measurement	Limit	Over	Detector	Comment
		MHz	dBuV	dB	dBuV/m	dBuV/m	dB		
1		2384.813	26.06	30.77	56.83	74.00	-17.17	peak	
2		2384.813	2.59	30.77	33.36	54.00	-20.64	AVG	
3		2400.000	23.48	30.83	54.31	74.00	-19.69	peak	
4	X	2480.000	72.70	31.15	103.85	74.00	29.85	peak	NoLimit
5	*	2480.000	72.46	31.15	103.61	54.00	49.61	AVG	NoLimit
6		2483.500	24.24	31.16	55.40	74.00	-18.60	peak	
7		2483.500	6.61	31.16	37.77	54.00	-16.23	AVG	
8		2562.900	26.54	31.49	58.03	74.00	-15.97	peak	
9		2562.900	8.35	31.49	39.84	54.00	-14.16	AVG	

REMARKS:

(1) Measurement Value = Reading Level + Correct Factor.

(2) Margin Level = Measurement Value - Limit Value.



Test Mode	BT(3 Mbps)	Test Date	2021/3/22
Test Frequency	2402MHz	Polarization	Horizontal
Temp	23°C	Hum.	66%

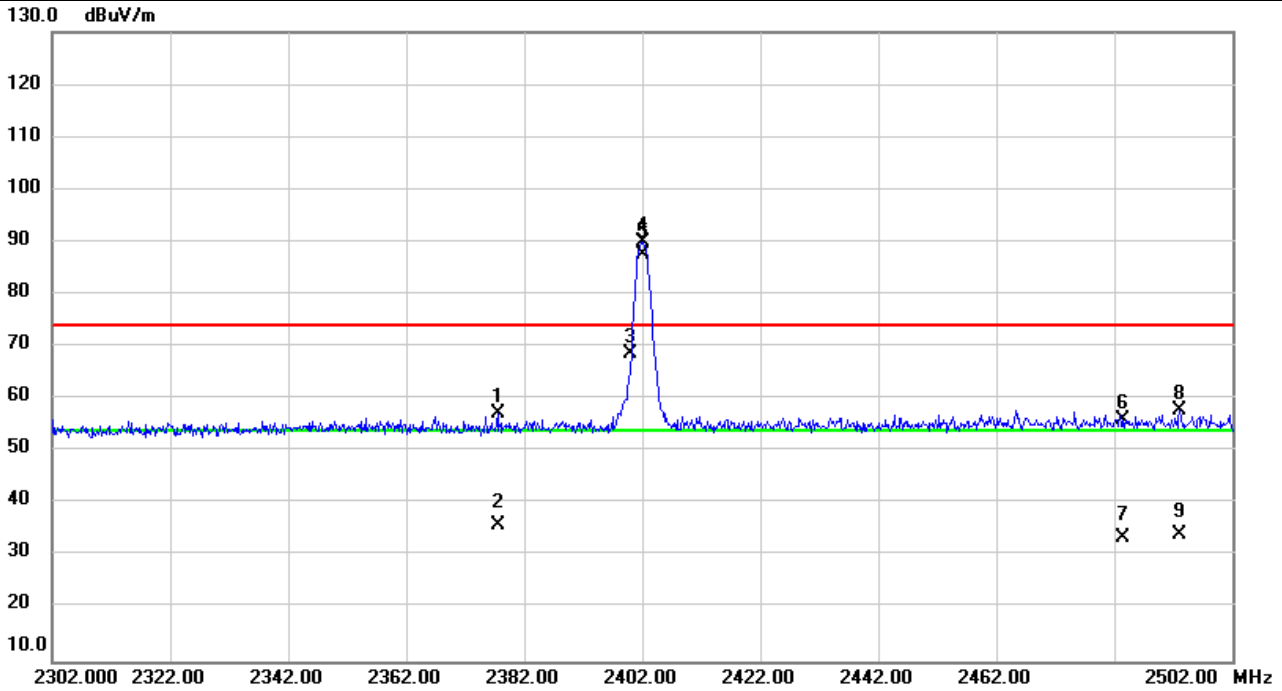

No.	Mk.	Freq.	Reading Level	Correct Factor	Measurement	Limit	Over	Detector	Comment
		MHz	dBuV	dB	dBuV/m	dBuV/m	dB		
1		2377.527	26.49	30.74	57.23	74.00	-16.77	peak	
2		2377.527	5.20	30.74	35.94	54.00	-18.06	AVG	
3		2400.000	37.84	30.83	68.67	74.00	-5.33	peak	
4	X	2402.000	59.00	30.84	89.84	74.00	15.84	peak	NoLimit
5	*	2402.000	56.63	30.84	87.47	54.00	33.47	AVG	NoLimit
6		2483.500	24.89	31.16	56.05	74.00	-17.95	peak	
7		2483.500	2.39	31.16	33.55	54.00	-20.45	AVG	
8		2493.080	26.68	31.21	57.89	74.00	-16.11	peak	
9		2493.080	2.83	31.21	34.04	54.00	-19.96	AVG	

REMARKS:

(1) Measurement Value = Reading Level + Correct Factor.

(2) Margin Level = Measurement Value - Limit Value.

Test Mode	BT(3 Mbps)	Test Date	2021/3/22
Test Frequency	2480MHz	Polarization	Horizontal
Temp	23°C	Hum.	66%

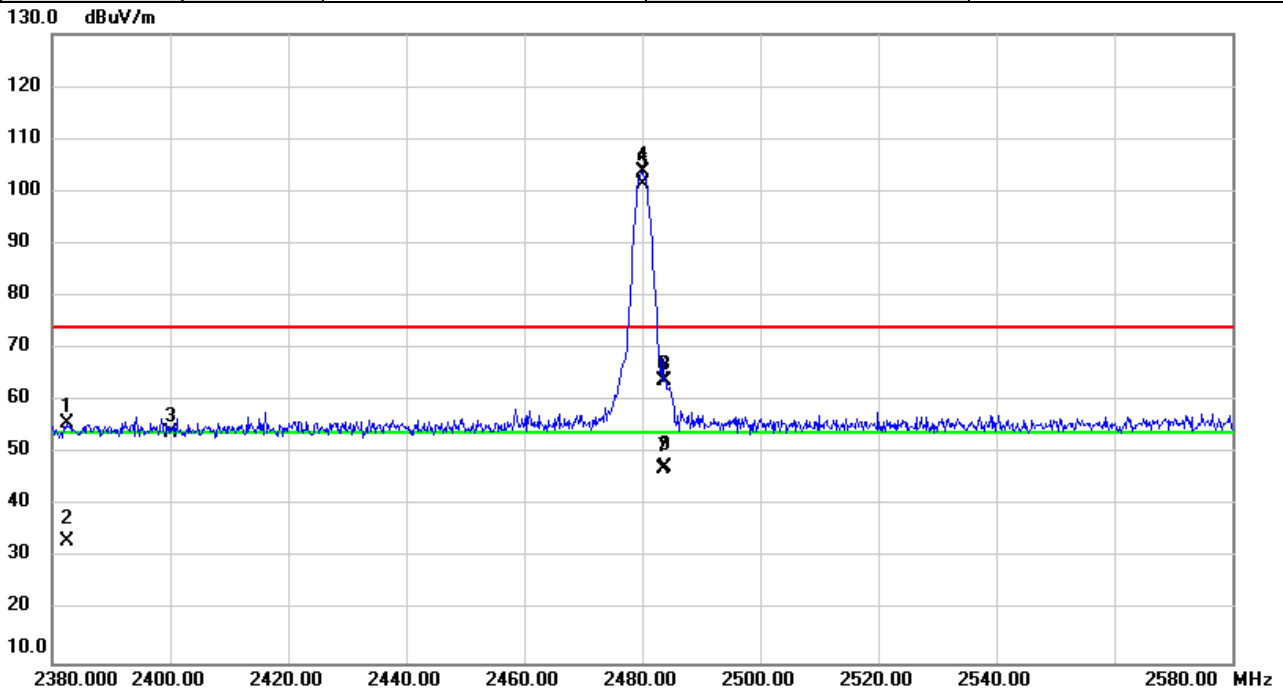

No.	Mk.	Freq.	Reading Level	Correct Factor	Measurement	Limit	Over	Detector	Comment
		MHz	dBuV	dB	dBuV/m	dBuV/m	dB		
1		2382.453	25.09	30.76	55.85	74.00	-18.15	peak	
2		2382.453	2.64	30.76	33.40	54.00	-20.60	AVG	
3		2400.000	23.27	30.83	54.10	74.00	-19.90	peak	
4	X	2480.000	72.60	31.15	103.75	74.00	29.75	peak	NoLimit
5	*	2480.000	70.25	31.15	101.40	54.00	47.40	AVG	NoLimit
6		2483.500	32.67	31.16	63.83	74.00	-10.17	peak	
7		2483.500	15.98	31.16	47.14	54.00	-6.86	AVG	
8		2483.867	32.80	31.17	63.97	74.00	-10.03	peak	
9		2483.867	16.20	31.17	47.37	54.00	-6.63	AVG	

**REMARKS:**

(1) Measurement Value = Reading Level + Correct Factor.

(2) Margin Level = Measurement Value - Limit Value.

Test Mode	BT(1 Mbps)	Test Date	2021/3/22
Test Frequency	2402MHz	Polarization	Vertical
Temp	23°C	Hum.	66%

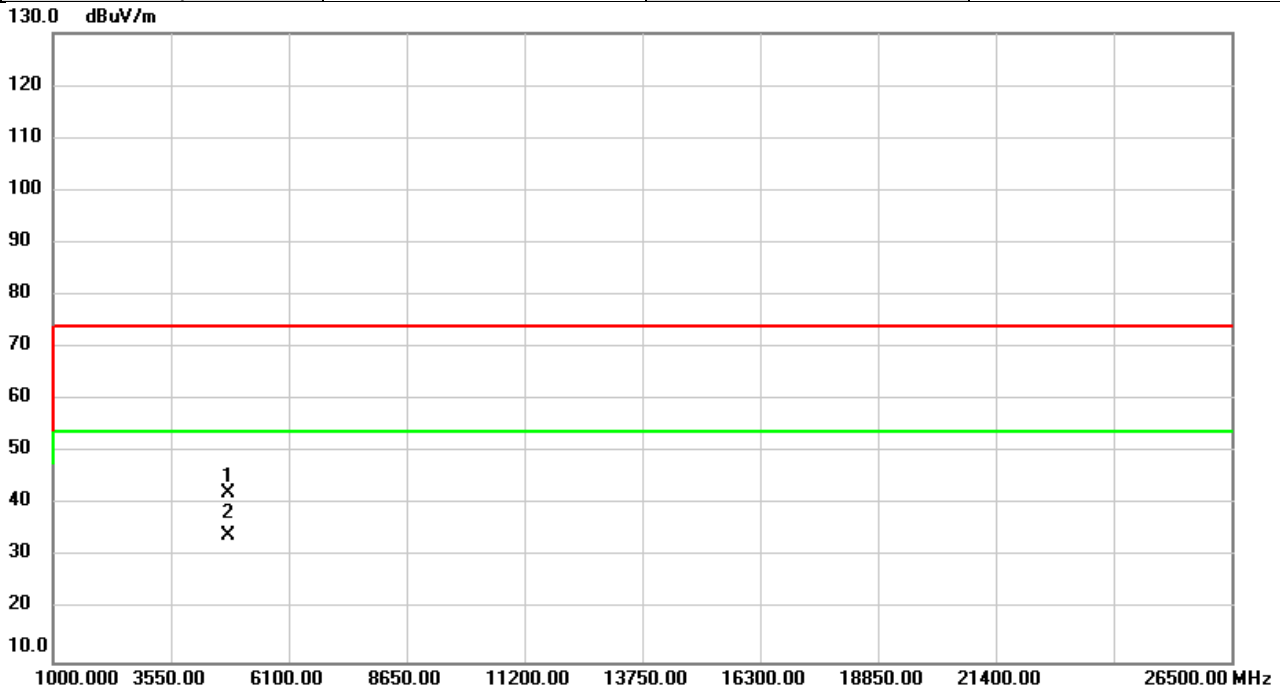

No.	Mk.	Freq. MHz	Reading Level dBuV	Correct Factor dB	Measure- ment dBuV/m	Limit dBuV/m	Over dB	Detector	Comment
1		4804.000	52.23	-10.03	42.20	74.00	-31.80	peak	
2	*	4804.000	44.09	-10.03	34.06	54.00	-19.94	AVG	

**REMARKS:**

- (1) Measurement Value = Reading Level + Correct Factor.
- (2) Margin Level = Measurement Value - Limit Value.

Test Mode	BT(1 Mbps)	Test Date	2021/3/22
Test Frequency	2402MHz	Polarization	Horizontal
Temp	23°C	Hum.	66%

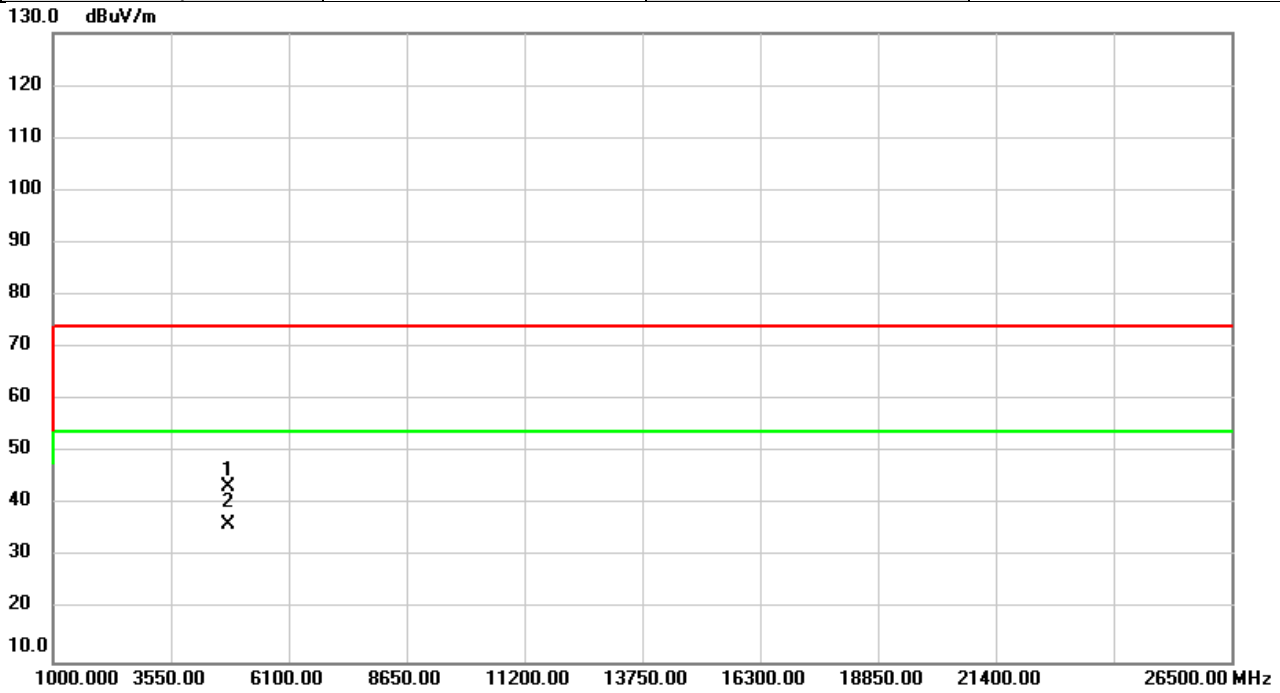

No.	Mk.	Freq.	Reading Level	Correct Factor	Measurement	Limit	Over	Detector	Comment
		MHz	dBuV	dB	dBuV/m	dBuV/m	dB		
1		4804.000	53.34	-10.03	43.31	74.00	-30.69	peak	
2	*	4804.000	46.13	-10.03	36.10	54.00	-17.90	AVG	

**REMARKS:**

- (1) Measurement Value = Reading Level + Correct Factor.
- (2) Margin Level = Measurement Value - Limit Value.

Test Mode	BT(1 Mbps)	Test Date	2021/3/22
Test Frequency	2441MHz	Polarization	Vertical
Temp	23°C	Hum.	66%

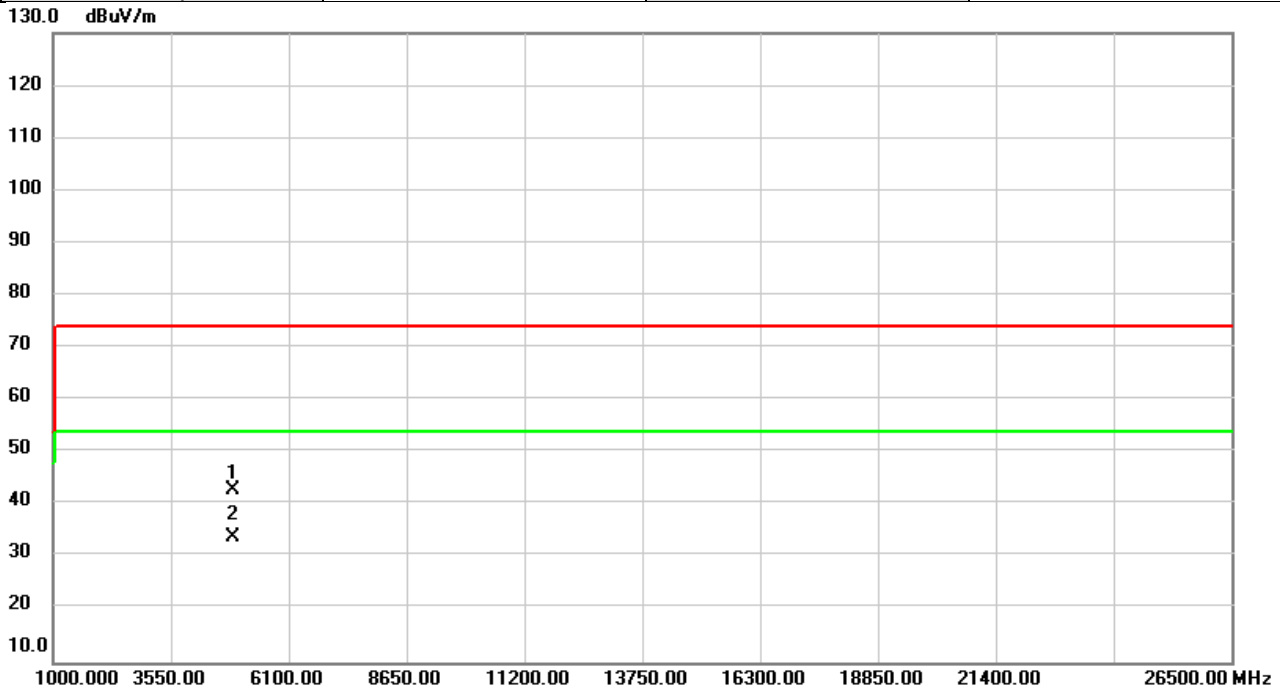

No.	Mk.	Freq. MHz	Reading Level dBuV	Correct Factor dB	Measure- ment dBuV/m	Limit dBuV/m	Over dB	Detector	Comment
1		4882.000	52.49	-9.76	42.73	74.00	-31.27	peak	
2	*	4882.000	43.66	-9.76	33.90	54.00	-20.10	AVG	

**REMARKS:**

- (1) Measurement Value = Reading Level + Correct Factor.
- (2) Margin Level = Measurement Value - Limit Value.

Test Mode	BT(1 Mbps)	Test Date	2021/3/22
Test Frequency	2441MHz	Polarization	Horizontal
Temp	23°C	Hum.	66%

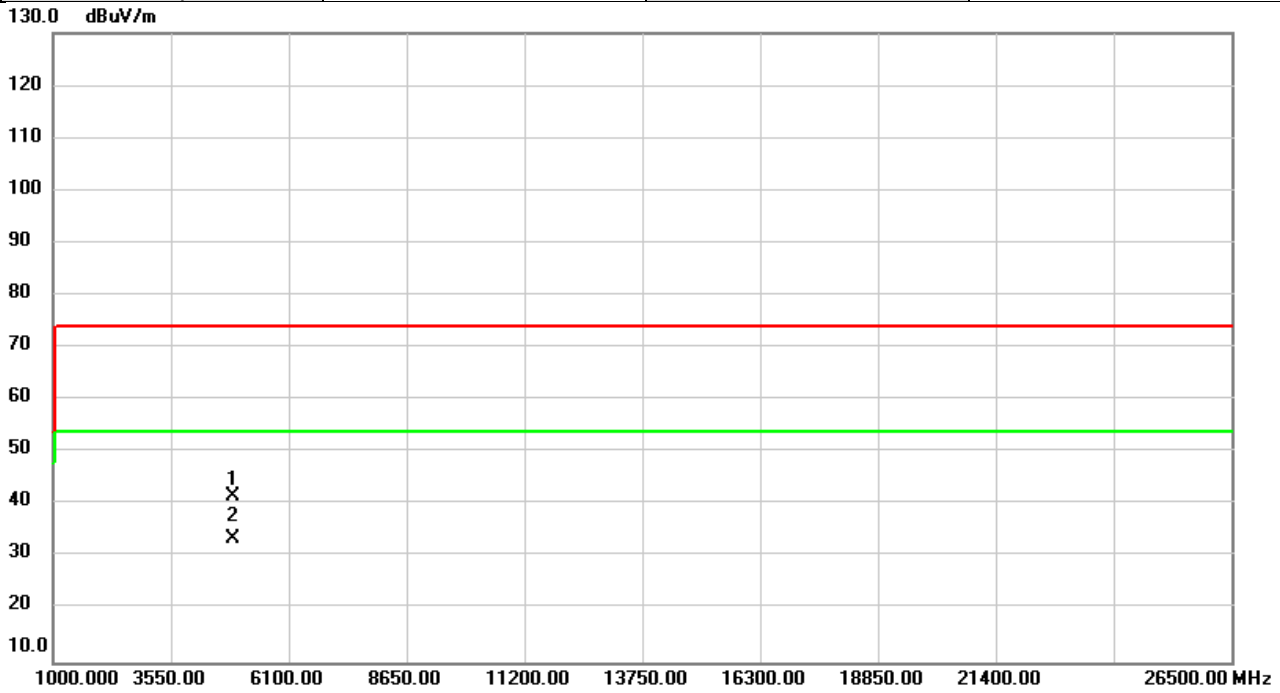

No.	Mk.	Freq. MHz	Reading Level dBuV	Correct Factor dB	Measure- ment dBuV/m	Limit dBuV/m	Over dB	Detector	Comment
1		4882.000	51.45	-9.76	41.69	74.00	-32.31	peak	
2	*	4882.000	43.23	-9.76	33.47	54.00	-20.53	AVG	

**REMARKS:**

- (1) Measurement Value = Reading Level + Correct Factor.
- (2) Margin Level = Measurement Value - Limit Value.

Test Mode	BT(1 Mbps)	Test Date	2021/3/22
Test Frequency	2480MHz	Polarization	Vertical
Temp	23°C	Hum.	66%

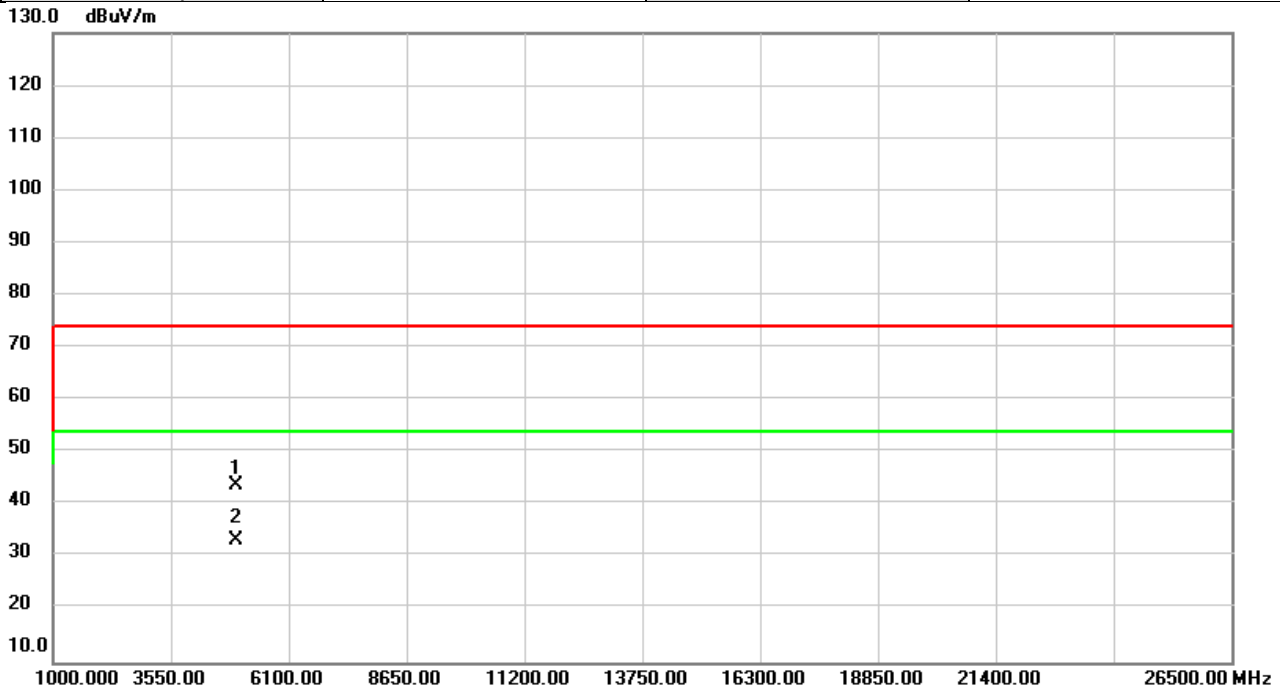

No.	Mk.	Freq.	Reading Level	Correct Factor	Measurement	Limit	Over	Detector	Comment
		MHz	dBuV	dB	dBuV/m	dBuV/m	dB		
1		4960.000	53.10	-9.49	43.61	74.00	-30.39	peak	
2	*	4960.000	42.77	-9.49	33.28	54.00	-20.72	AVG	

**REMARKS:**

- (1) Measurement Value = Reading Level + Correct Factor.
- (2) Margin Level = Measurement Value - Limit Value.

Test Mode	BT(1 Mbps)	Test Date	2021/3/22
Test Frequency	2480MHz	Polarization	Horizontal
Temp	23°C	Hum.	66%

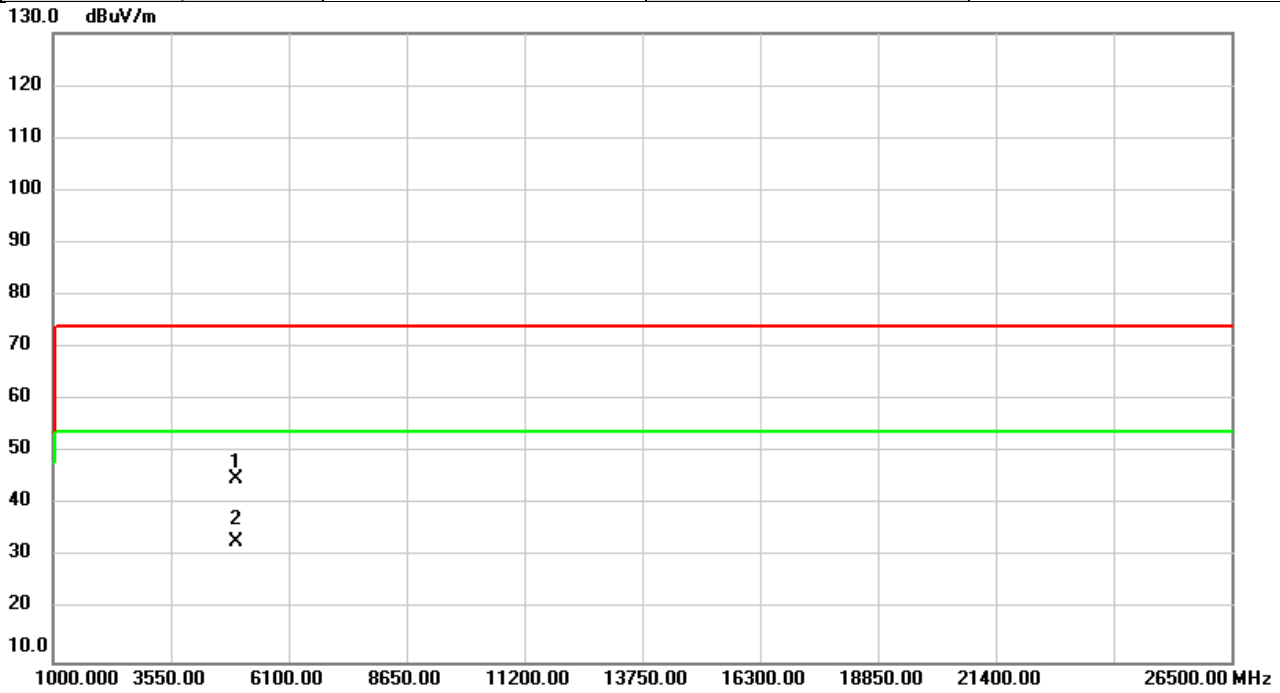

No.	Mk.	Freq. MHz	Reading Level dBuV	Correct Factor dB	Measure- ment dBuV/m	Limit dBuV/m	Over dB	Detector	Comment
1		4960.000	54.37	-9.49	44.88	74.00	-29.12	peak	
2	*	4960.000	42.37	-9.49	32.88	54.00	-21.12	AVG	

**REMARKS:**

- (1) Measurement Value = Reading Level + Correct Factor.
- (2) Margin Level = Measurement Value - Limit Value.



Test Mode	BT(3 Mbps)	Test Date	2021/3/22
Test Frequency	2402MHz	Polarization	Vertical
Temp	23°C	Hum.	66%

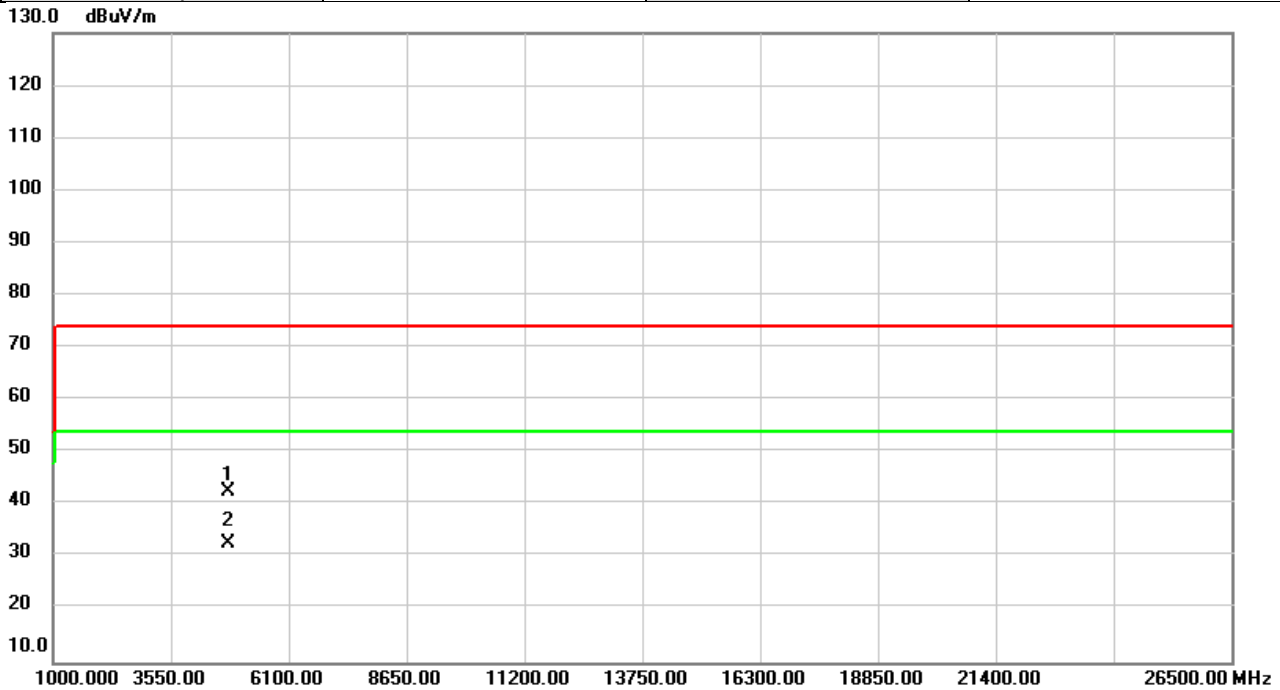

No.	Mk.	Freq. MHz	Reading Level dBuV	Correct Factor dB	Measure- ment dBuV/m	Limit dBuV/m	Over dB	Detector	Comment
1		4804.000	52.68	-10.03	42.65	74.00	-31.35	peak	
2	*	4804.000	42.82	-10.03	32.79	54.00	-21.21	AVG	

**REMARKS:**

- (1) Measurement Value = Reading Level + Correct Factor.
- (2) Margin Level = Measurement Value - Limit Value.

Test Mode	BT(3 Mbps)	Test Date	2021/3/22
Test Frequency	2402MHz	Polarization	Horizontal
Temp	23°C	Hum.	66%

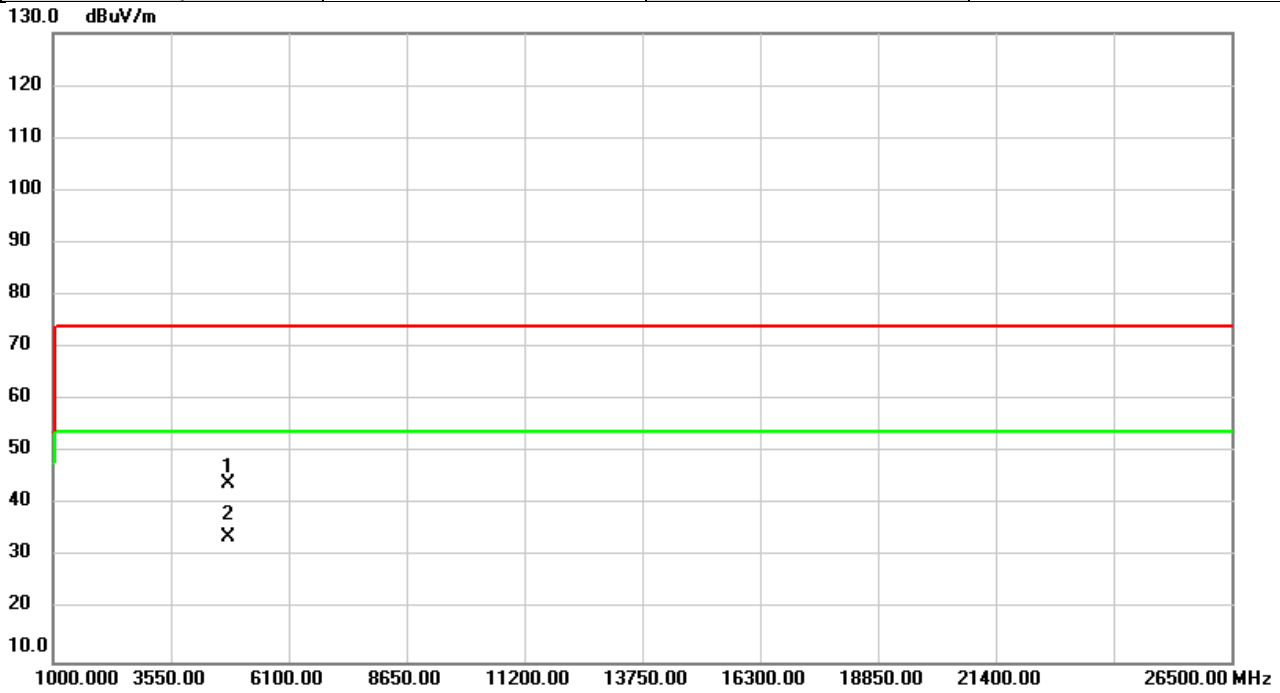

No.	Mk.	Freq. MHz	Reading Level dBuV	Correct Factor dB	Measure- ment dBuV/m	Limit dBuV/m	Over dB	Detector	Comment
1		4804.000	54.18	-10.03	44.15	74.00	-29.85	peak	
2	*	4804.000	43.96	-10.03	33.93	54.00	-20.07	AVG	

**REMARKS:**

- (1) Measurement Value = Reading Level + Correct Factor.
- (2) Margin Level = Measurement Value - Limit Value.

Test Mode	BT(3 Mbps)	Test Date	2021/3/22
Test Frequency	2441MHz	Polarization	Vertical
Temp	23°C	Hum.	66%

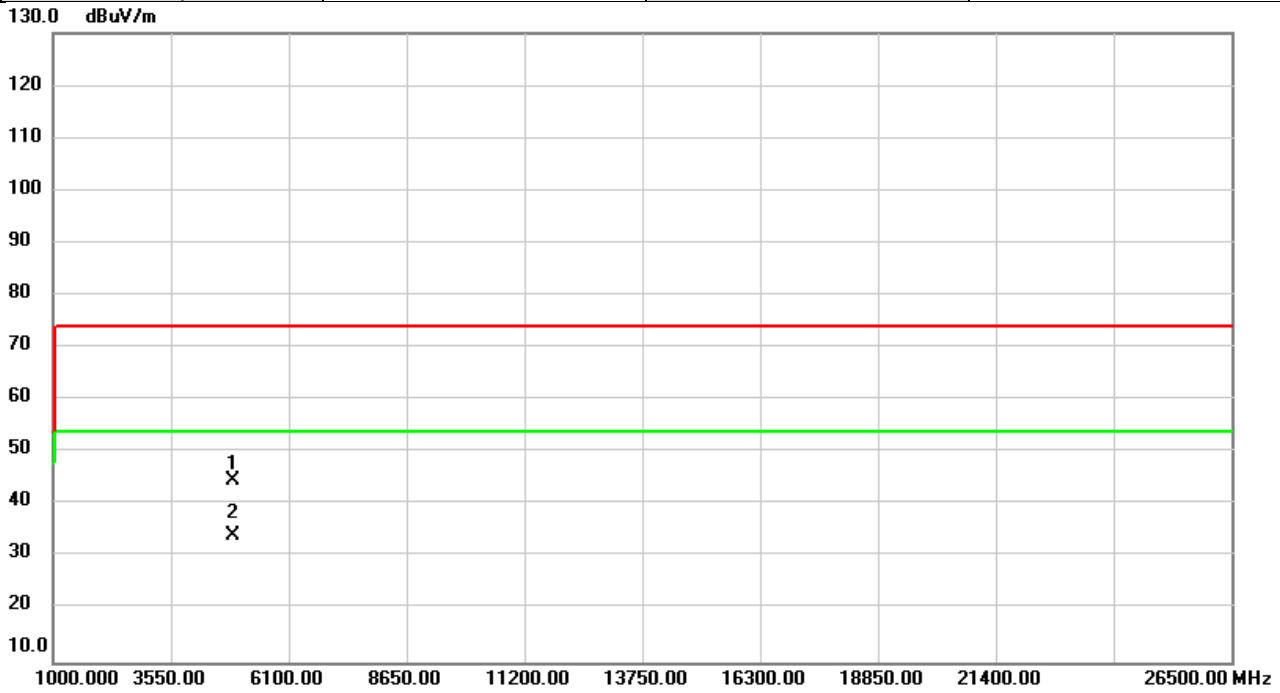

No.	Mk.	Freq. MHz	Reading Level dBuV	Correct Factor dB	Measure- ment dBuV/m	Limit dBuV/m	Over dB	Detector	Comment
1		4882.000	54.40	-9.76	44.64	74.00	-29.36	peak	
2	*	4882.000	43.77	-9.76	34.01	54.00	-19.99	AVG	

**REMARKS:**

- (1) Measurement Value = Reading Level + Correct Factor.
- (2) Margin Level = Measurement Value - Limit Value.

Test Mode	BT(3 Mbps)	Test Date	2021/3/22
Test Frequency	2441MHz	Polarization	Horizontal
Temp	23°C	Hum.	66%

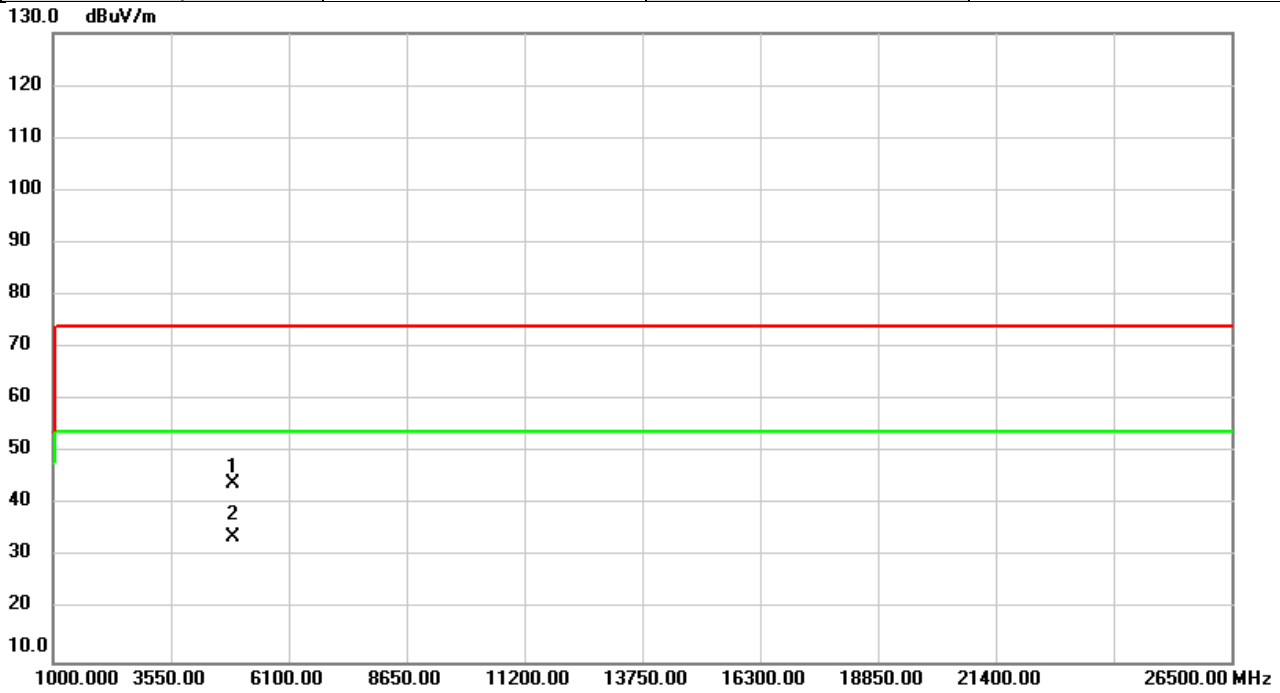

No.	Mk.	Freq.	Reading Level	Correct Factor	Measurement	Limit	Over	Detector	Comment
		MHz	dBuV	dB	dBuV/m	dBuV/m	dB		
1		4882.000	53.81	-9.76	44.05	74.00	-29.95	peak	
2	*	4882.000	43.53	-9.76	33.77	54.00	-20.23	AVG	

**REMARKS:**

- (1) Measurement Value = Reading Level + Correct Factor.
- (2) Margin Level = Measurement Value - Limit Value.

Test Mode	BT(3 Mbps)	Test Date	2021/3/22
Test Frequency	2480MHz	Polarization	Vertical
Temp	23°C	Hum.	66%

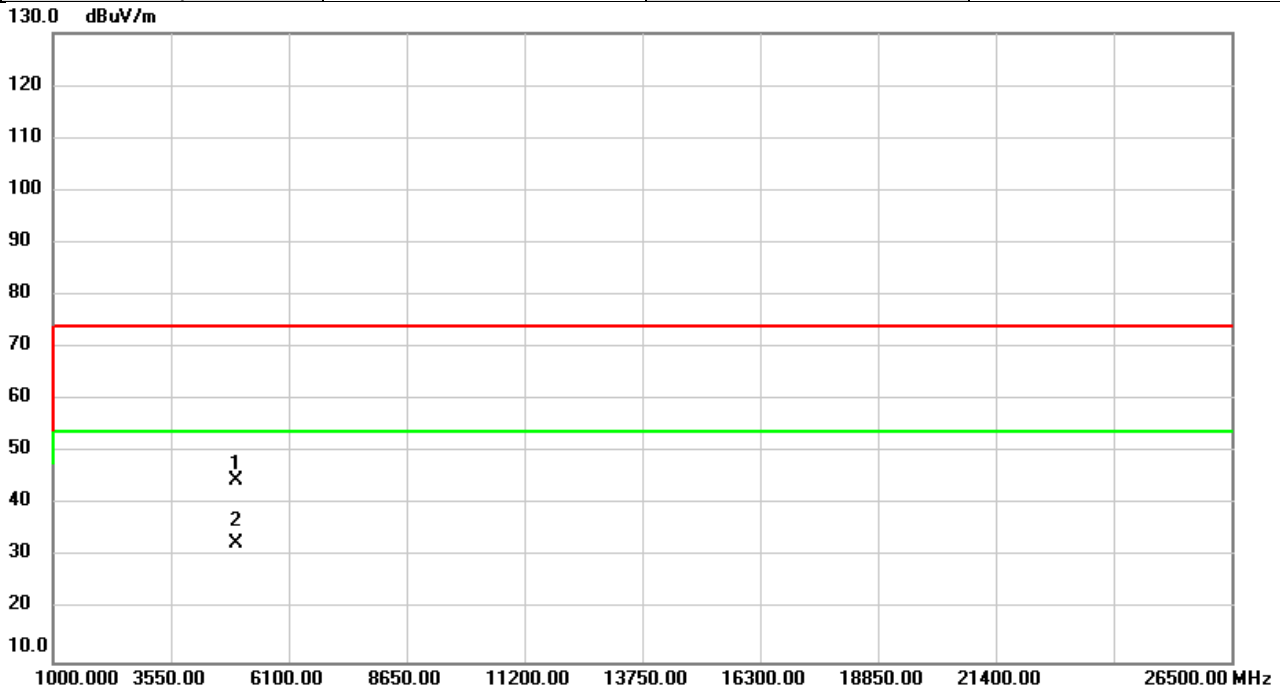

No.	Mk.	Freq. MHz	Reading Level dBuV	Correct Factor dB	Measure- ment dBuV/m	Limit dBuV/m	Over dB	Detector	Comment
1		4960.000	54.29	-9.49	44.80	74.00	-29.20	peak	
2	*	4960.000	42.13	-9.49	32.64	54.00	-21.36	AVG	

**REMARKS:**

- (1) Measurement Value = Reading Level + Correct Factor.
- (2) Margin Level = Measurement Value - Limit Value.

Test Mode	BT(3 Mbps)	Test Date	2021/3/22
Test Frequency	2480MHz	Polarization	Horizontal
Temp	23°C	Hum.	66%

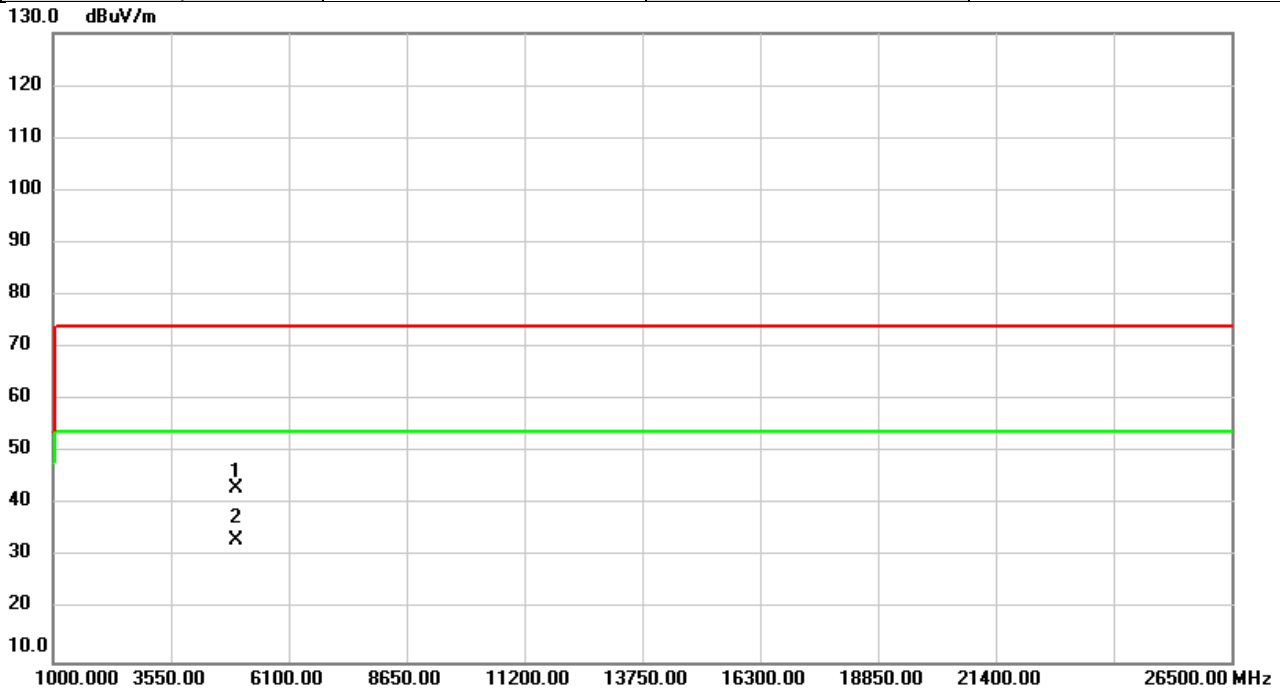

No.	Mk.	Freq.	Reading Level	Correct Factor	Measurement	Limit	Over	Detector	Comment
		MHz	dBuV	dB	dBuV/m	dBuV/m	dB		
1		4960.000	52.64	-9.49	43.15	74.00	-30.85	peak	
2	*	4960.000	42.75	-9.49	33.26	54.00	-20.74	AVG	

**REMARKS:**

- (1) Measurement Value = Reading Level + Correct Factor.
- (2) Margin Level = Measurement Value - Limit Value.

## APPENDIX D OUTPUT POWER

Test Mode :	BT(1 Mbps)	Tested Date	2021/3/19
-------------	------------	-------------	-----------

Frequency (MHz)	Conducted Power (dBm)	Conducted Power (W)	Max. Limit (dBm)	Max. Limit (W)	Test Result
2402	11.05	0.0127	20.97	0.1250	Pass
2441	10.79	0.0120	20.97	0.1250	Pass
2480	10.88	0.0122	20.97	0.1250	Pass

Test Mode :	BT(2 Mbps)	Tested Date	2021/3/19
-------------	------------	-------------	-----------

Frequency (MHz)	Conducted Power (dBm)	Conducted Power (W)	Max. Limit (dBm)	Max. Limit (W)	Test Result
2402	10.48	0.0112	20.97	0.1250	Pass
2441	10.42	0.0110	20.97	0.1250	Pass
2480	10.43	0.0110	20.97	0.1250	Pass

Test Mode :	BT(3 Mbps)	Tested Date	2021/3/19
-------------	------------	-------------	-----------

Frequency (MHz)	Conducted Power (dBm)	Conducted Power (W)	Max. Limit (dBm)	Max. Limit (W)	Test Result
2402	10.46	0.0111	20.97	0.1250	Pass
2441	10.43	0.0110	20.97	0.1250	Pass
2480	10.47	0.0111	20.97	0.1250	Pass

**End of Test Report**