

FCC Radio Test Report

FCC ID: PU5-LN300WG3D

Report No. : BTL-FCCP-10-2102T172A
Equipment : Notebook Computer
Model Name : Lenovo 300w Gen 3xxxxxxx (The "x" in model name can be 0 to 9, A to Z, a to z, "-" or blank, for marketing purpose only)
Brand Name : Lenovo
Applicant : Wistron Corporation
Address : 21F, No. 88, Sec. 1, Hsin Tai Wu Rd., Hsichih Dist, New Taipei City 221, Taiwan

Radio Function : WCDMA Band II, LTE Band 2

FCC Rule Part(s) : 47 CFR FCC Part 24 Subpart E
Measurement Procedure(s) : ANSI C63.26-2015
ANSI/TIA-603-E-2016
FCC KDB 971168 D01 Power Meas License Digital Systems v03r01

Date of Receipt : 2021/3/12
Date of Test : 2021/3/12 ~ 2021/3/31
Issued Date : 2021/6/10

The above equipment has been tested and found in compliance with the requirement of the above standards by BTL Inc.

Prepared by

Peter Chen, Engineer

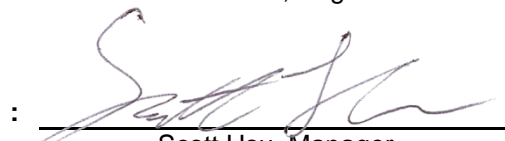

Approved by

: 
Scott Hsu, Manager

BTL Inc.

No.18, Ln. 171, Sec. 2, Jiuzong Rd., Neihu Dist., Taipei City 114, Taiwan

Tel: +886-2-2657-3299

Fax: +886-2-2657-3331

Web: www.newbtl.com

Declaration

BTL represents to the client that testing is done in accordance with standard procedures as applicable and that test instruments used has been calibrated with standards traceable to international standard(s) and/or national standard(s).

BTL's reports apply only to the specific samples tested under conditions. It is manufacture's responsibility to ensure that additional production units of this model are manufactured with the identical electrical and mechanical components. **BTL** shall have no liability for any declarations, inferences or generalizations drawn by the client or others from **BTL** issued reports.

This report is the confidential property of the client. As a mutual protection to the clients, the public and ourselves, the test report shall not be reproduced, except in full, without our written approval.

BTL's laboratory quality assurance procedures are in compliance with the **ISO/IEC 17025** requirements, and accredited by the conformity assessment authorities listed in this test report.

BTL is not responsible for the sampling stage, so the results only apply to the sample as received.

The information, data and test plan are provided by manufacturer which may affect the validity of results, so it is manufacturer's responsibility to ensure that the apparatus meets the essential requirements of applied standards and in all the possible configurations as representative of its intended use.

Limitation

For the use of the authority's logo is limited unless the Test Standard(s)/Scope(s)/Item(s) mentioned in this test report is (are) included in the conformity assessment authorities acceptance respective.

Please note that the measurement uncertainty is provided for informational purpose only and are not use in determining the Pass/Fail results.

CONTENTS

1	SUMMARY OF TEST RESULTS	5
1.1	TEST FACILITY	6
1.2	MEASUREMENT UNCERTAINTY	6
1.3	TEST ENVIRONMENT CONDITIONS	6
2	GENERAL INFORMATION	7
2.1	DESCRIPTION OF EUT	7
2.2	TEST MODES	8
2.3	BLOCK DIAGRAM SHOWING THE CONFIGURATION OF SYSTEM TESTED	9
2.4	SUPPORT UNITS	10
3	AC POWER LINE CONDUCTED EMISSIONS TEST	11
3.1	LIMIT	11
3.2	TEST PROCEDURE	11
3.3	DEVIATION FROM TEST STANDARD	11
3.4	TEST SETUP	12
3.5	TEST RESULT	12
4	EFFECTIVE ISOTROPICAL RADIATED POWER MEASUREMENT	13
4.1	LIMIT	13
4.2	TEST PROCEDURE	13
4.3	DEVIATION FROM TEST STANDARD	13
4.4	TEST SETUP	14
4.5	EUT OPERATING CONDITIONS	14
4.6	TEST RESULT	14
5	RADIATED SPURIOUS EMISSIONS MEASUREMENT	15
5.1	LIMIT	15
5.2	TEST PROCEDURE	15
5.3	DEVIATION FROM TEST STANDARD	15
5.4	TEST SETUP	16
5.5	EUT OPERATING CONDITIONS	16
5.6	TEST RESULT	16
6	LIST OF MEASURING EQUIPMENTS	17
7	EUT TEST PHOTO	18
8	EUT PHOTOS	18
APPENDIX A	AC POWER LINE CONDUCTED EMISSIONS	19
APPENDIX B	EFFECTIVE ISOTROPIC RADIATED POWER	24
APPENDIX C	RADIATED SPURIOUS EMISSIONS	44

REVISION HISTORY

Report No.	Version	Description	Issued Date
BTL-FCCP-10-2102T172A	R00	Original Report.	2021/4/27
BTL-FCCP-10-2102T172A	R01	Revised report to address TCB's comments.	2021/5/21
BTL-FCCP-10-2102T172A	R02	Revised report to address TCB's comments.	2021/5/31
BTL-FCCP-10-2102T172A	R03	Revised report to address TCB's comments.	2021/6/10

1 SUMMARY OF TEST RESULTS

Test procedures according to the technical standards.

Standard(s) Section	Description	Test Result	Judgement	Remark
15.207	AC Power Line Conducted Emissions	APPENDIX A	Pass	-----
2.1049	Effective Isotropical Radiated Power	APPENDIX B	Pass	-----
2.1051 24.238(a)	Occupied Bandwidth	NOTE (3)	Pass	-----
2.1053 24.238(a)	Conducted Spurious Emissions	NOTE (3)	Pass	-----
24.238(a)	Radiated Spurious Emissions	APPENDIX C	Pass	-----
24.232(d)	Band Edge Measurements	NOTE (3)	Pass	-----
2.1055 24.235	Peak To Average Ratio	NOTE (3)	Pass	-----
2.1049	Frequency Stability	NOTE (3)	Pass	-----

NOTE:

- (1) "N/A" denotes test is not applicable in this Test Report.
- (2) The report format version is TP.1.1.1.
- (3) This item is demonstrated to full compliance referring to the test report number RF170106C02-1 of the integrated module (model name: L850-GL, FCC ID: ZMOL850GL), according to KDB 996369 D02 Q1 a) 2).
- (4) The ac power lines conducted emissions and radiated emissions are tested to demonstrate full compliance of both module integrated into the host and host itself.

1.1 TEST FACILITY

The test facilities used to collect the test data in this report:

No. 68-1, Ln. 169, Sec. 2, Datong Rd., Xizhi Dist., New Taipei City 221, Taiwan

The test sites and facilities are covered under FCC RN: 355421 and DN: TW1099.

C05
 CB08
 CB11
 CB15
 CB16

1.2 MEASUREMENT UNCERTAINTY

The reported uncertainty of measurement $y \pm U$, where expanded uncertainty U is based on a standard uncertainty multiplied by a coverage factor of $k = 2$, providing a level of confidence of approximately **95 %**. The measurement instrumentation uncertainty considerations contained in CISPR 16-4-2. The BTL measurement uncertainty is less than the CISPR 16-4-2 U_{cispr} requirement.

A. AC power line conducted emissions test:

Test Site	Method	Measurement Frequency Range	U (dB)
C05	CISPR	150 kHz ~ 30MHz	3.44

B. Effective Radiated Power and Radiated emissions test :

Test Site	Measurement Frequency Range	U,(dB)
CB15	0.03 GHz ~ 0.2 GHz	4.17
	0.2 GHz ~ 1 GHz	4.72
	1 GHz ~ 6 GHz	5.21
	6 GHz ~ 18 GHz	5.51
	18 GHz ~ 26 GHz	3.69
	26 GHz ~ 40 GHz	4.23

NOTE:

Unless specifically mentioned, the uncertainty of measurement has not been taken into account to declare the compliance or non-compliance to the specification.

1.3 TEST ENVIRONMENT CONDITIONS

Test Item	Environment Condition	Test Voltage	Tested by
AC Power Line Conducted Emissions	20 °C, 72 %	AC 120V	Vincent Lee
Effective Radiated Power	Refer to data	AC 120V	Jay Kao
Radiated Spurious Emissions	Refer to data	AC 120V	Jay Kao

2 GENERAL INFORMATION

2.1 DESCRIPTION OF EUT

Equipment	Notebook Computer		
Model Name	Lenovo 300w Gen 3xxxxxxx (The "x" in model name can be 0 to 9, A to Z, a to z, "-" or blank, for marketing purpose only)		
Brand Name	Lenovo		
Model Difference	Different model distribute to different area.		
Power Source	DC voltage supplied from External Power Supply. (Lenovo/ADLX45YLC3D)		
Power Rating	I/P: 100-240V~1.3A 50-60Hz O/P: 20.0V---2.25A 45.0W / 15.0V---3.0A / 9.0V---2.0A / 5.0V---2.0A 10.0W		
Products Covered	1 * Adapter: Lenovo/ADLX45YLC3D		
WIFI+BT Module	Intel® Wi-Fi 6 AX200 / AX200NGW		
WWAN Module	Fibocom / L850-GL		
Operation Frequency	Band	UL Frequency (MHz)	DL Frequency (MHz)
	WCDMA II	1850 ~ 1910	1930 ~ 1990
	LTE 2	1850 ~ 1910	1930 ~ 1990
Maximum EIRP	WCDMA II: 0.266 W		
	LTE 2 (1.4 MHz, QPSK): 0.205 W		
	LTE 2 (1.4 MHz, 16QAM): 0.168 W		
	LTE 2 (3 MHz, QPSK): 0.207 W		
	LTE 2 (3 MHz, 16QAM): 0.170 W		
	LTE 2 (5 MHz, QPSK): 0.210 W		
	LTE 2 (5 MHz, 16QAM): 0.172 W		
	LTE 2 (10 MHz, QPSK): 0.212 W		
	LTE 2 (10 MHz, 16QAM): 0.174 W		
	LTE 2 (15 MHz, QPSK): 0.215 W		
	LTE 2 (15 MHz, 16QAM): 0.176 W		
	LTE 2 (20 MHz, QPSK): 0.215 W		
LTE 2 (20 MHz, 16QAM): 0.176 W			
Test Model	Lenovo 300w Gen 3		
Sample Status	Engineering Sample		
EUT Modification(s)	N/A		

NOTE:

(1) For a more detailed features description, please refer to the manufacturer's specifications or the user's manual.

(2) Table for Filed Antenna:

Antenna	Manufacture	Parts Number	Type	Connector	Gain (dBi)	Note
Main	INPAQ Corporation	025.901TX.0001	PIFA	I-PEX	0.74	WCDMA Band II
						LTE Band 2
Aux	INPAQ Corporation	025.901TY.0001	PIFA	I-PEX	-	RX only

2.2 TEST MODES

Test Items	Band	Test Mode	Note
AC Power Line Conducted Emissions	-	Normal/Idle	-
Effective Isotropical Radiated Power	WCDMA Band II	TX Mode (CH 9662/9800/9938)	
	LTE Band 2	TX Mode (CH 18700/18900/19100)	
Radiated Spurious Emissions	WCDMA Band II	TX Mode (CH 9800)	-
	LTE Band 2	TX Mode (CH 18900)	-

NOTE:

- (1) All X, Y and Z axes are evaluated, but only the worst case (WCDMA: Z axis, LTE: Y axis) is recorded.
- (2) For Radiated Spurious Emissions both QPSK and 16QAM are evaluated, but only the worst case (QPSK) is recorded.

2.3 BLOCK DIAGRAM SHOWING THE CONFIGURATION OF SYSTEM TESTED

Equipment letters and Cable numbers refer to item numbers described in the tables of clause 2.4.

AC Power Line Conducted Emissions Test

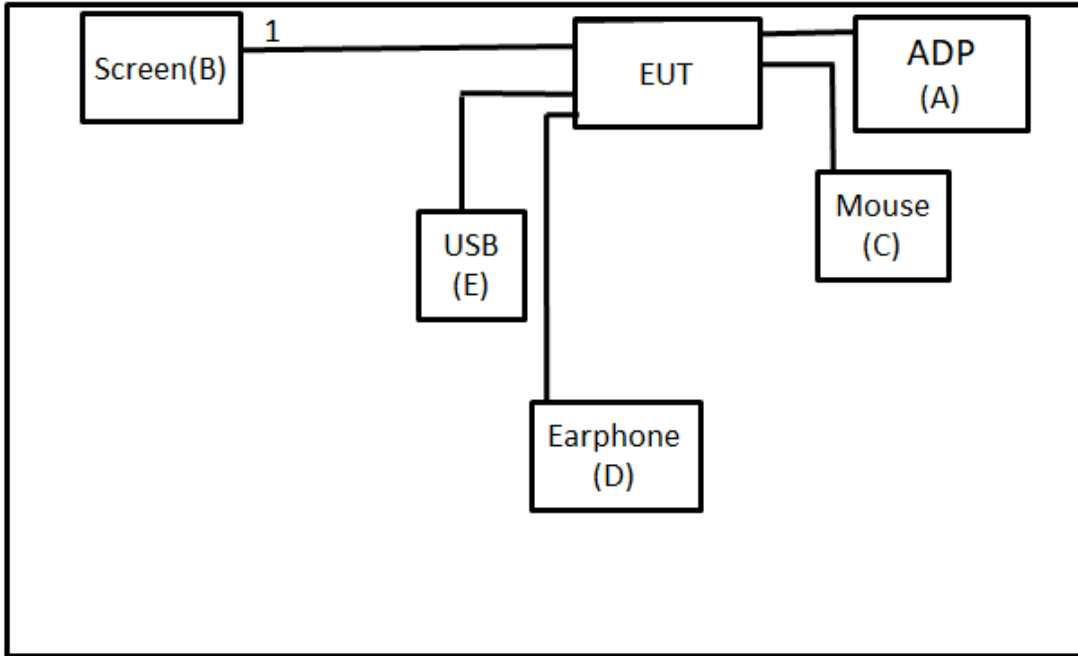

Radiated Emissions Test

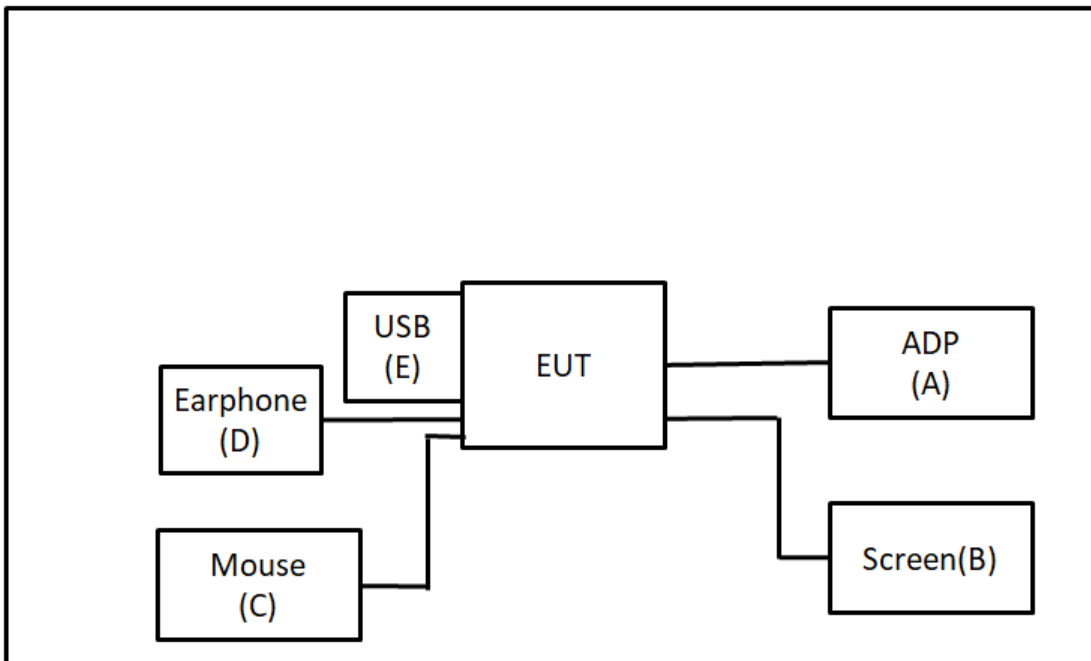

2.4 SUPPORT UNITS

Item	Equipment	Brand	Model No.	Series No.	Remarks
A	ADP	Lenovo	ADLX45YLC3D	N/A	Supplied by test requester.
B	Screen	ASUS	MX27U	N/A	Furnished by test lab.
C	Mouse	ACER	MP-368	N/A	Furnished by test lab.
D	Earphone	Sony	MDR-E9LP	N/A	Furnished by test lab.
E	USB	Kingston	C7052-322.AOOL F	N/A	Furnished by test lab.

Item	Shielded	Ferrite Core	Length	Cable Type	Remarks
1	N/A	N/A	1.8m	HDMI Cable	Furnished by test lab.

3 AC POWER LINE CONDUCTED EMISSIONS TEST

3.1 LIMIT

Frequency (MHz)	Limit (dB μ V)	
	Quasi-peak	Average
0.15 - 0.5	66 - 56 *	56 - 46 *
0.50 - 5.0	56	46
5.0 - 30.0	60	50

NOTE:

- (1) The tighter limit applies at the band edges.
- (2) The limit of " * " marked band means the limitation decreases linearly with the logarithm of the frequency in the range.
- (3) The test result calculated as following:
 Measurement Value = Reading Level + Correct Factor
 Correct Factor = Insertion Loss + Cable Loss + Attenuator Factor (if use)
 Margin Level = Measurement Value – Limit Value
 Calculation example:

Reading Level		Correct Factor		Measurement Value
38.22	+	3.45	=	41.67

Measurement Value		Limit Value		Margin Level
41.67	-	60	=	-18.33

The following table is the setting of the receiver.

Receiver Parameter	Setting
Attenuation	10 dB
Start Frequency	0.15 MHz
Stop Frequency	30 MHz
IF Bandwidth	9 KHz

3.2 TEST PROCEDURE

- a. The EUT was placed 0.8 m above the horizontal ground plane with the EUT being connected to the power mains through a line impedance stabilization network (LISN).
 All other support equipment were powered from an additional LISN(s).
 The LISN provides 50 Ohm/50uH of impedance for the measuring instrument.
- b. Interconnecting cables that hang closer than 40 cm to the ground plane shall be folded back and forth in the center forming a bundle to keep the cable above 40 cm.
- c. Excess I/O cables that are not connected to a peripheral shall be bundled in the center.
 The end of the cable will be terminated, using the correct terminating impedance.
 The overall length shall not exceed 1 m.
- d. The LISN is spaced at least 80 cm from the nearest part of the EUT chassis.
- e. For the actual test configuration, please refer to the related Item - EUT TEST PHOTO.

NOTE:

- (1) In the results, each reading is marked as Peak, QP or AVG per the detector used.
 BW=9 kHz (6 dB Bandwidth)
- (2) All readings are Peak unless otherwise stated QP or AVG in column of Note. Both the QP and the AVG readings must be less than the limit for compliance.

3.3 DEVIATION FROM TEST STANDARD

No deviation.

3.4 TEST SETUP

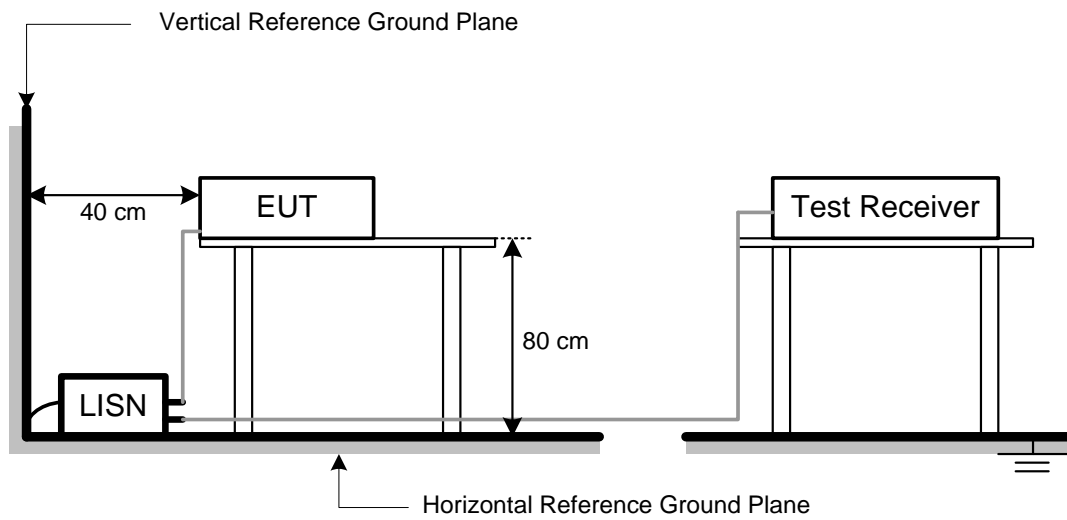

3.5 TEST RESULT

Please refer to the APPENDIX A.

4 EFFECTIVE ISOTROPICAL RADIATED POWER MEASUREMENT

4.1 LIMIT

Mobile / Portable station are limited to 2 watts e.i.r.p.

NOTE:

(1) The test result calculated as following:

Measurement Value = Reading Level + Correct Factor

Correct Factor = Antenna Factor + Cable Loss - Amplifier Gain(if use)

Margin Level = Measurement Value - Limit Value

Calculation example:

Reading Level		Correct Factor		Measurement Value
-29.66	+	34.26	=	4.60

Measurement Value		Limit Value		Margin Level
4.60	-	38.45	=	-33.85

4.2 TEST PROCEDURE

The testing follows FCC KDB 971168 v03r01 Section 5.8.

- a. Substitution method is used for E.I.R.P measurement. In the semi-anechoic chamber, EUT placed on the 0.8m height of Turn Table, rotated the table around 360 degrees to search the maximum radiation power and receiver antenna shall be rotated vertical and horizontal polarization and moved height from 1m to 4m to find the maximum polar radiated power. The "Read Value" is the spectrum reading the maximum power value.
- b. The substitution horn antenna is substituted for EUT at the same position and signals generator export the CW signal to the substitution antenna via a TX cable. Rotated the Turn Table and moved receiving antenna to find the maximum radiation power. Adjust output power level of S.G to get a Value of spectrum reading equal to "Read Value " of step a. Record the power level of S.G
- c. EIRP = Output power level of S.G – TX cable loss + Antenna gain of substitution horn.
- d. ERP can be calculated form EIRP by subtracting the gain of dipole, $ERP = EIPR - 2.15dBi.$
- e. The resolution bandwidth and video bandwidth of test receiver/spectrum analyzer is 1MHz/3MHz.

4.3 DEVIATION FROM TEST STANDARD

No deviation.

4.4 TEST SETUP

Conducted Measurement:

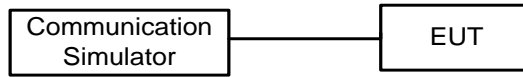

Radiated Measurement:

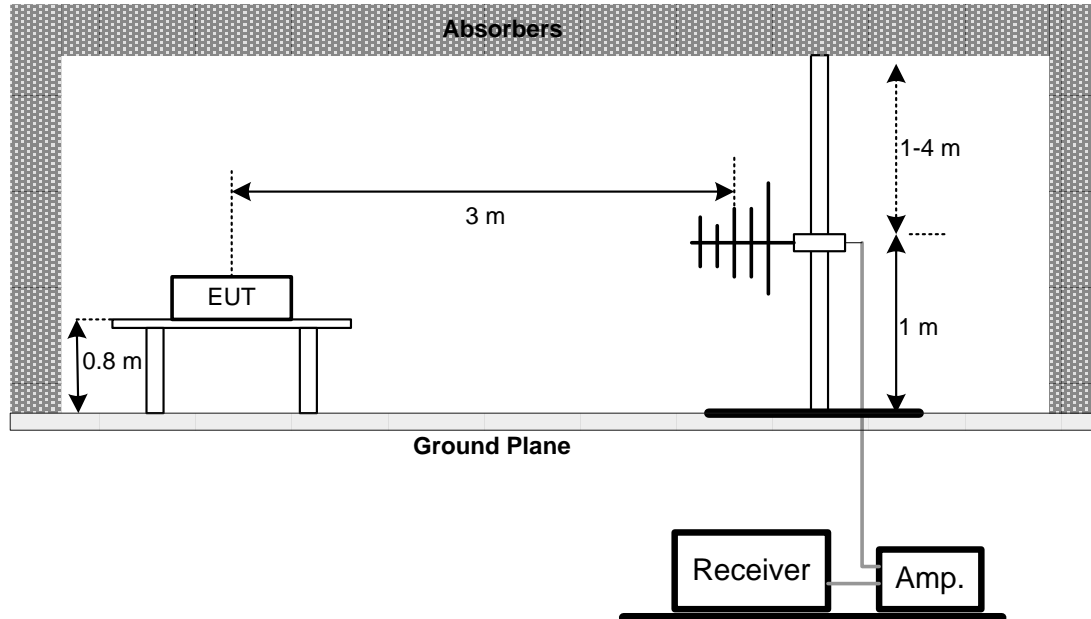

4.5 EUT OPERATING CONDITIONS

The EUT was programmed to be in continuously transmitting mode.

4.6 TEST RESULT

Please refer to the APPENDIX B.

5 RADIATED SPURIOUS EMISSIONS MEASUREMENT

5.1 LIMIT

The power of any emission outside of the authorized operating frequency ranges must be attenuated below the transmitting power (P) by a factor of at least $43 + 10 \log(P)$ dB. The emission limit equal to -13dBm.

NOTE:

(1) The test result calculated as following:

Measurement Value = Reading Level + Correct Factor

Correct Factor = Antenna Factor + Cable Loss - Amplifier Gain(if use)

Margin Level = Measurement Value - Limit Value

Calculation example:

Reading Level		Correct Factor		Measurement Value
-50.43	+	-2.11	=	-52.54

Measurement Value		Limit Value		Margin Level
-52.54	-	-13	=	-39.54

5.2 TEST PROCEDURE

The testing follows FCC KDB 971168 v03r01 Section 6.2.

- f. In the semi-anechoic chamber, EUT placed on the 0.8m height of Turn Table, rotated the table around 360 degrees to search the maximum radiation power and receiver antenna shall be rotated vertical and horizontal polarization and moved height from 1m to 4m to find the maximum polar radiated power. The "Read Value" is the spectrum reading the maximum power value.
- g. The substitution horn antenna is substituted for EUT at the same position and signals generator export the CW signal to the substitution antenna via a TX cable. Rotated the Turn Table and moved receiving antenna to find the maximum radiation power. Adjust output power level of S.G to get a Value of spectrum reading equal to "Read Value " of step a. Record the power level of S.G
- h. EIRP = Output power level of S.G - TX cable loss + Antenna gain of substitution horn.
- i. ERP power can be calculated form EIRP power by subtracting the gain of dipole,
ERP power = EIRP power - 2.15 dBi.
- j. The resolution bandwidth and video bandwidth of test receiver/spectrum analyzer is 1 MHz / 3 MHz.

5.3 DEVIATION FROM TEST STANDARD

No deviation.

5.4 TEST SETUP

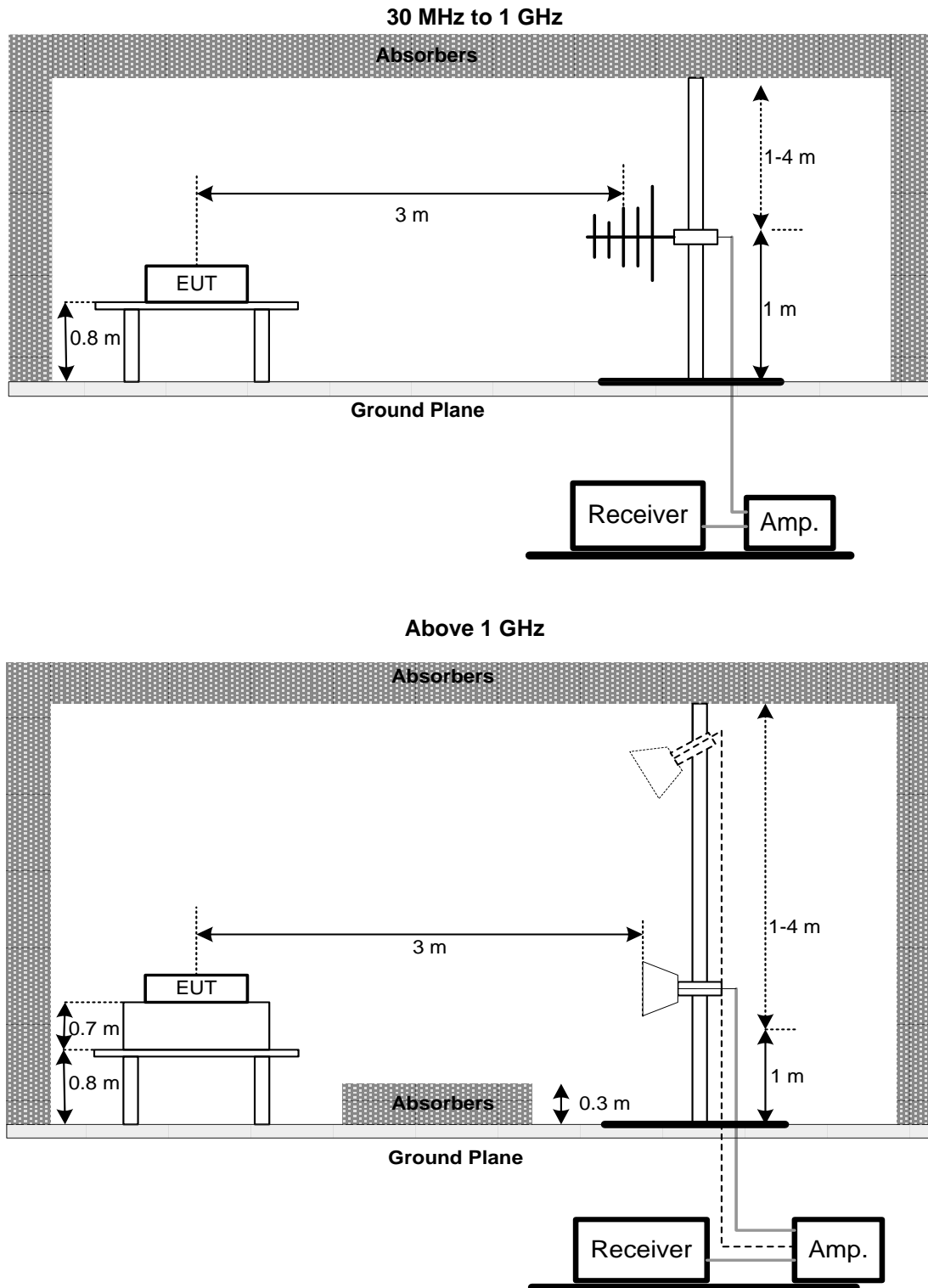

5.5 EUT OPERATING CONDITIONS

The EUT was programmed to be in continuously transmitting mode.

5.6 TEST RESULT

Please refer to the APPENDIX C.

6 LIST OF MEASURING EQUIPMENTS

AC Power Line Conducted Emissions						
Item	Kind of Equipment	Manufacturer	Type No.	Serial No.	Calibrated Date	Calibrated Until
1	TWO-LINE V-NETWORK	R&S	ENV216	101050	2020/6/11	2021/6/10
2	Test Cable	EMCI	EMC400-BM-BM-5000	170501	2020/6/8	2021/6/7
3	EMI Test Receiver	R&S	ESCI	100080	2020/6/15	2021/6/14
4	Measurement Software	EZ	EZ EMC (Version NB-03A1-01)	N/A	N/A	N/A

Effective Radiated Power and Radiated Emissions						
Item	Kind of Equipment	Manufacturer	Type No.	Serial No.	Calibrated Date	Calibrated Until
1	Preamplifier	EMCI	EMC02325B	980217	2020/4/10	2021/4/9
2	Preamplifier	EMCI	EMC012645B	980267	2020/4/10	2021/4/9
3	Test Cable	EMCI	EMC-SM-SM-1000	180809	2020/4/10	2021/4/9
4	Test Cable	EMCI	EMC104-SM-SM-3000	151205	2020/4/10	2021/4/9
5	Test Cable	EMCI	EMC-SM-SM-7000	180408	2020/4/10	2021/4/9
6	MXE EMI Receiver	Agilent	N9038A	MY554200087	2020/6/10	2021/6/9
7	Signal Analyzer	Agilent	N9010A	MY56480554	2020/8/25	2021/8/24
8	Horn Ant	SCHWARZBECK	BBHA 9120D	9120D-1342	2020/6/12	2021/6/11
9	Horn Ant	Schwarzbeck	BBHA 9170	BBHA 9170340	2020/7/9	2021/7/8
10	Trilog-Broadband Antenna	Schwarzbeck	VULB 9168	VULB 9168-352	2020/7/24	2021/7/23
11	5dB Attenuator	EMCI	EMCI-N-6-05	AT-N0625	2020/7/24	2021/7/23
12	Measurement Software	EZ	EZ EMC (Version NB-03A1-01)	N/A	N/A	N/A
13	8960 Series 10 Wireless Com Test Set	Agilent	E5515C	GB47390193	2020/6/4	2021/6/3
14	Radio Communication Analyzer (LTE)	Anritsu	MT8820C	6201525878	2020/6/3	2021/6/2
15	Radio Communication Analyzer	Anritsu	MT8821C	6262044728	2020/12/15	2021/12/14

Remark: "N/A" denotes no model name, no serial no. or no calibration specified.
All calibration period of equipment list is one year.

7 EUT TEST PHOTO

Please refer to document Appendix No.: TP-2102T172A-2 (APPENDIX-TEST PHOTOS).

8 EUT PHOTOS

Please refer to document Appendix No.: EP-2102T172A-2 (APPENDIX-EUT PHOTOS).

APPENDIX A AC POWER LINE CONDUCTED EMISSIONS

Test Mode	Normal	Tested Date	2021/3/23
Test Frequency	-	Phase	Line

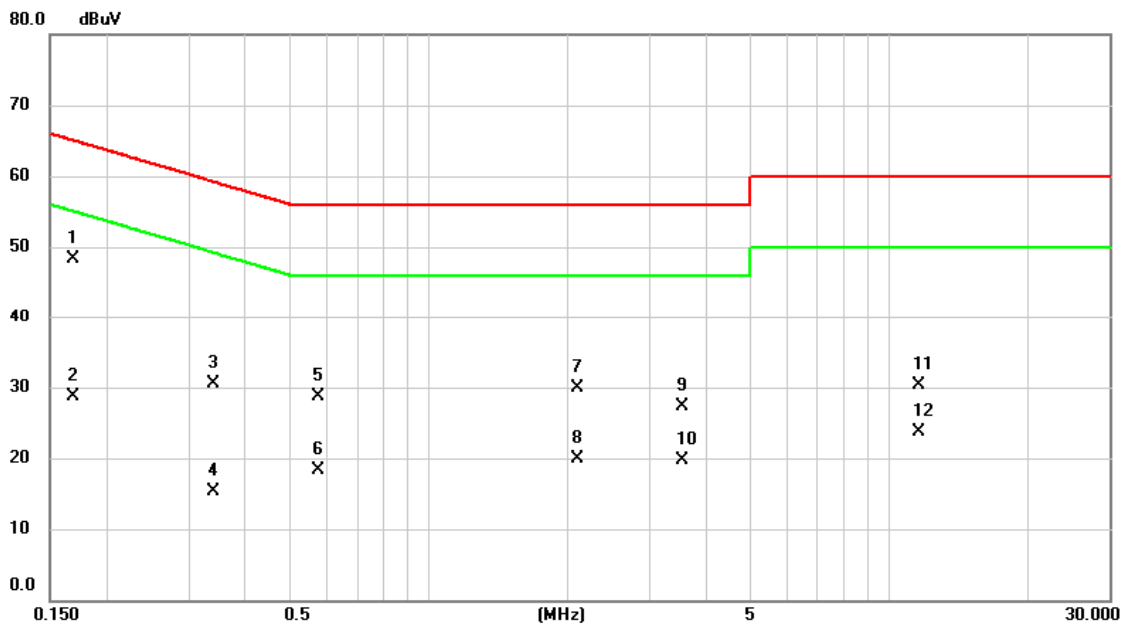

No.	Mk.	Freq.	Reading Level	Correct Factor	Measurement	Limit	Over	Detector	Comment
		MHz	dBuV	dB	dBuV	dBuV	dB		
1	*	0.1685	38.71	9.68	48.39	65.03	-16.64	QP	
2		0.1685	19.08	9.68	28.76	55.03	-26.27	AVG	
3		0.3412	20.75	9.68	30.43	59.17	-28.74	QP	
4		0.3412	5.54	9.68	15.22	49.17	-33.95	AVG	
5		0.5752	19.02	9.68	28.70	56.00	-27.30	QP	
6		0.5752	8.59	9.68	18.27	46.00	-27.73	AVG	
7		2.0963	20.07	9.74	29.81	56.00	-26.19	QP	
8		2.0963	10.25	9.74	19.99	46.00	-26.01	AVG	
9		3.5498	17.43	9.78	27.21	56.00	-28.79	QP	
10		3.5498	9.88	9.78	19.66	46.00	-26.34	AVG	
11		11.5935	20.34	9.93	30.27	60.00	-29.73	QP	
12		11.5935	13.79	9.93	23.72	50.00	-26.28	AVG	

REMARKS:

- (1) Measurement Value = Reading Level + Correct Factor.
- (2) Margin Level = Measurement Value - Limit Value.

Test Mode	Normal	Tested Date	2021/3/23
Test Frequency	-	Phase	Neutral

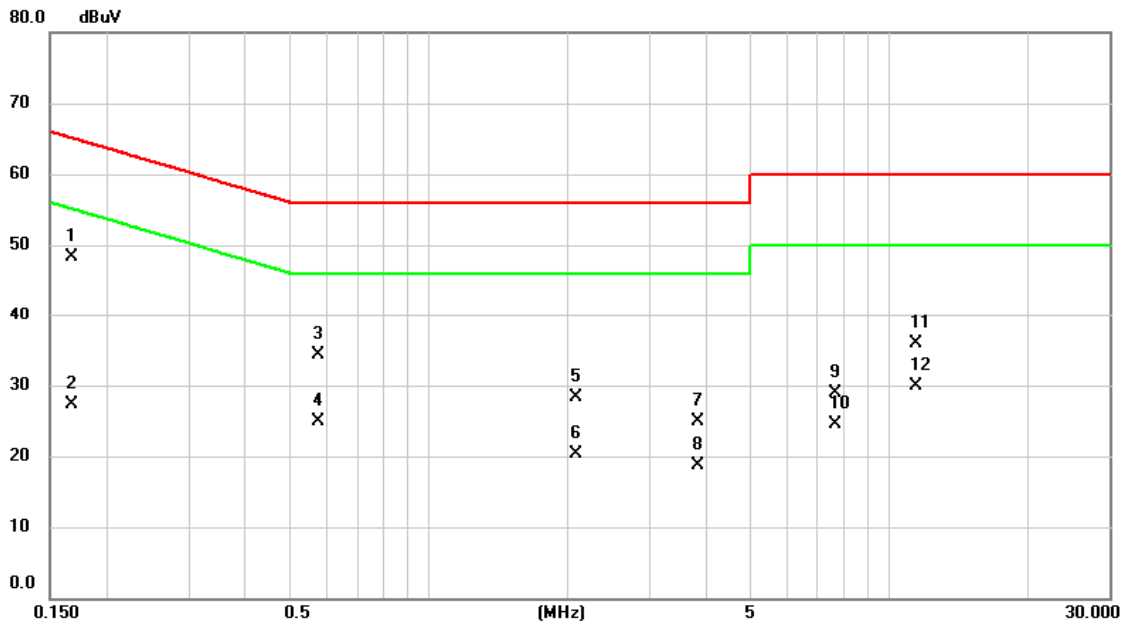

No.	Mk.	Freq. MHz	Reading Level dBuV	Correct Factor dB	Measure- ment dBuV	Limit dBuV	Over dB	Detector	Comment
1	*	0.1668	38.72	9.68	48.40	65.12	-16.72	QP	
2		0.1668	17.60	9.68	27.28	55.12	-27.84	AVG	
3		0.5752	24.68	9.68	34.36	56.00	-21.64	QP	
4		0.5752	15.30	9.68	24.98	46.00	-21.02	AVG	
5		2.0805	18.64	9.74	28.38	56.00	-27.62	QP	
6		2.0805	10.53	9.74	20.27	46.00	-25.73	AVG	
7		3.8288	15.11	9.79	24.90	56.00	-31.10	QP	
8		3.8288	8.95	9.79	18.74	46.00	-27.26	AVG	
9		7.6718	18.96	9.88	28.84	60.00	-31.16	QP	
10		7.6718	14.57	9.88	24.45	50.00	-25.55	AVG	
11		11.4720	25.95	9.93	35.88	60.00	-24.12	QP	
12		11.4720	19.96	9.93	29.89	50.00	-20.11	AVG	

REMARKS:

- (1) Measurement Value = Reading Level + Correct Factor.
- (2) Margin Level = Measurement Value - Limit Value.

Test Mode	Idle	Tested Date	2021/3/23
Test Frequency	-	Phase	Line

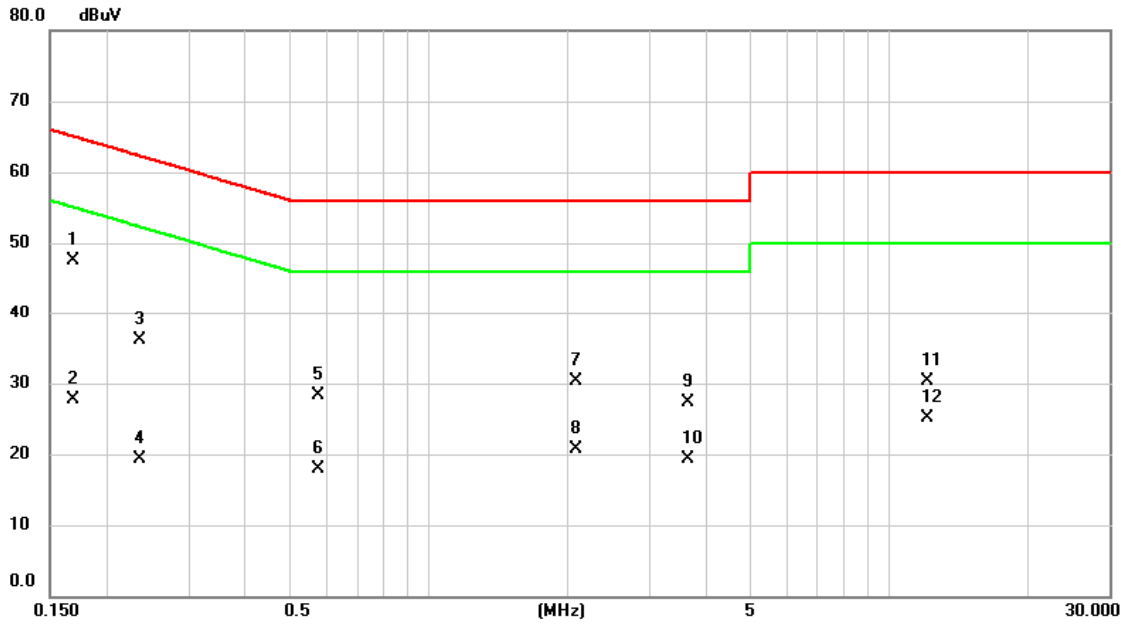

No.	Mk.	Freq.	Reading Level	Correct Factor	Measurement	Limit	Over		
		MHz	dBuV	dB	dBuV	dBuV	dB	Detector	Comment
1	*	0.1680	37.78	9.68	47.46	65.06	-17.60	QP	
2		0.1680	18.12	9.68	27.80	55.06	-27.26	AVG	
3		0.2355	26.49	9.68	36.17	62.25	-26.08	QP	
4		0.2355	9.67	9.68	19.35	52.25	-32.90	AVG	
5		0.5775	18.65	9.68	28.33	56.00	-27.67	QP	
6		0.5775	8.16	9.68	17.84	46.00	-28.16	AVG	
7		2.0873	20.57	9.74	30.31	56.00	-25.69	QP	
8		2.0873	10.94	9.74	20.68	46.00	-25.32	AVG	
9		3.6420	17.45	9.79	27.24	56.00	-28.76	QP	
10		3.6420	9.50	9.79	19.29	46.00	-26.71	AVG	
11		12.1403	20.32	9.93	30.25	60.00	-29.75	QP	
12		12.1403	15.14	9.93	25.07	50.00	-24.93	AVG	

REMARKS:

- (1) Measurement Value = Reading Level + Correct Factor.
- (2) Margin Level = Measurement Value - Limit Value.

Test Mode	Idle	Tested Date	2021/3/23
Test Frequency	-	Phase	Neutral

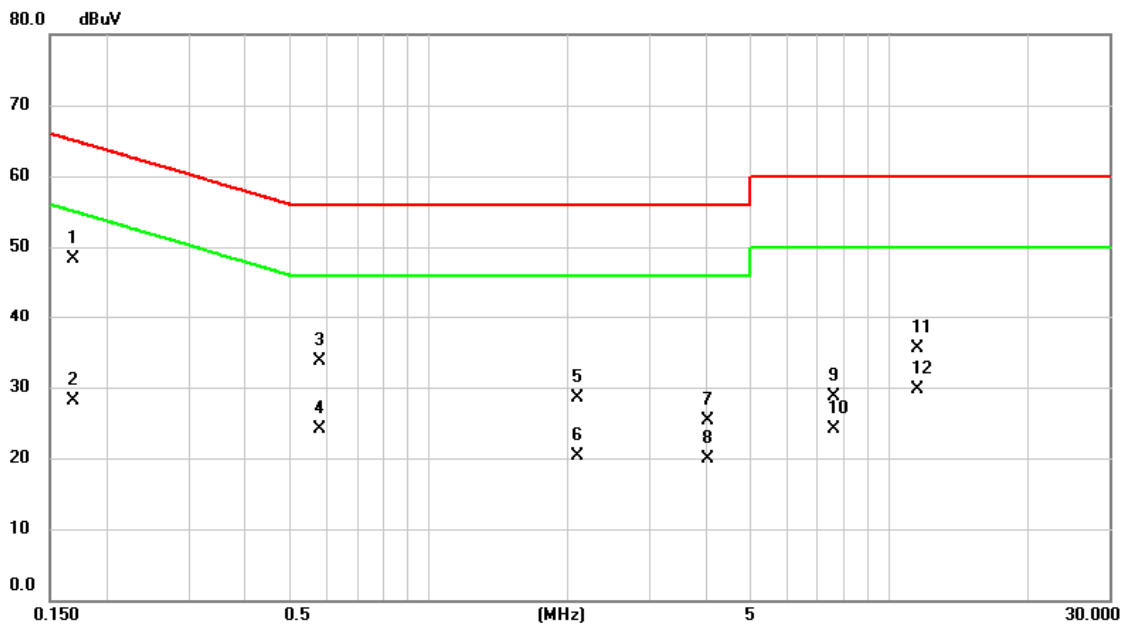

No.	Mk.	Freq.	Reading Level	Correct Factor	Measurement	Limit	Over	Detector	Comment
		MHz	dBuV	dB	dBuV	dBuV	dB		
1	*	0.1685	38.68	9.68	48.36	65.03	-16.67	QP	
2		0.1685	18.51	9.68	28.19	55.03	-26.84	AVG	
3		0.5797	24.08	9.68	33.76	56.00	-22.24	QP	
4		0.5797	14.48	9.68	24.16	46.00	-21.84	AVG	
5		2.1008	18.72	9.74	28.46	56.00	-27.54	QP	
6		2.1008	10.50	9.74	20.24	46.00	-25.76	AVG	
7		4.0313	15.45	9.80	25.25	56.00	-30.75	QP	
8		4.0313	10.04	9.80	19.84	46.00	-26.16	AVG	
9		7.6155	18.77	9.88	28.65	60.00	-31.35	QP	
10		7.6155	14.26	9.88	24.14	50.00	-25.86	AVG	
11		11.5260	25.62	9.93	35.55	60.00	-24.45	QP	
12		11.5260	19.82	9.93	29.75	50.00	-20.25	AVG	

REMARKS:

- (1) Measurement Value = Reading Level + Correct Factor.
- (2) Margin Level = Measurement Value - Limit Value.

APPENDIX B EFFECTIVE ISOTROPIC RADIATED POWER

Conducted Output Power and Calculated EIRP:
WCDMA Band II Power:

Band	UL/DL Channel No.	Frequency(MHz)	Average power(dBm)	EIRP (dBm)	EIRP (W)
WCDMA Band II	9262/9662	1852.4	23.26	24.00	0.251
	9400/9800	1880.0	23.43	24.17	0.261
	9538/9938	1907.6	23.51	24.25	0.266

Band	Sub-test	UL/DL Channel No.	Average power(dBm)	EIRP (dBm)	EIRP (W)
HSDPA II	1	9262/9662	21.18	21.92	0.156
		9400/9800	21.94	22.68	0.185
		9538/9983	21.99	22.73	0.187
	2	9262/9662	20.70	21.44	0.139
		9400/9800	21.46	22.20	0.166
		9538/9983	21.51	22.25	0.168
	3	9262/9662	20.28	21.02	0.126
		9400/9800	21.04	21.78	0.151
		9538/9983	21.09	21.83	0.152
	4	9262/9662	21.09	21.83	0.152
		9400/9800	21.85	22.59	0.182
		9538/9983	21.90	22.64	0.184

Band	Sub-test	UL/DL Channel No.	Average power(dBm)	EIRP (dBm)	EIRP (W)
HSUPA II	1	9262/9662	20.36	21.10	0.129
		9400/9800	20.43	21.17	0.131
		9538/9983	20.06	20.80	0.120
	2	9262/9662	18.41	19.15	0.082
		9400/9800	18.48	19.22	0.084
		9538/9983	18.11	18.85	0.077
	3	9262/9662	19.50	20.24	0.106
		9400/9800	19.57	20.31	0.107
		9538/9983	19.20	19.94	0.099
	4	9262/9662	18.64	19.38	0.087
		9400/9800	18.71	19.45	0.088
		9538/9983	18.34	19.08	0.081
	5	9262/9662	20.29	21.03	0.127
		9400/9800	20.36	21.10	0.129
		9538/9983	19.99	20.73	0.118

NOTE:

- (1) EIRP = Average power + Antenna gain.
- (2) ERP = EIRP - 2.15.
- (3) $P(W) = 1 W \cdot 10^{(P(dBm) / 10)} / 1000$
- (4) The antenna gain is 0.74 dBi.

LTE Band 2 Power:

Band	BW (MHz)	Channel	Frequency (MHz)	Mode	UL RB Allocation	UL RB Offset	MPR	Average power (dBm)	EIRP (dBm)	EIRP (W)		
2	1.4	18607	1850.7	QPSK	1	0	0	22.11	22.85	0.193		
					1	2	0	21.96	22.70	0.186		
					1	5	0	21.77	22.51	0.178		
					3	0	0	22.11	22.85	0.193		
					3	1	0	21.96	22.70	0.186		
					3	2	0	21.77	22.51	0.178		
				16QAM	6	0	1	20.87	21.61	0.145		
					1	0	1	21.33	22.07	0.161		
					1	2	1	21.14	21.88	0.154		
					1	5	1	20.88	21.62	0.145		
					3	0	1	21.33	22.07	0.161		
					3	1	1	21.14	21.88	0.154		
		18900	1880.0	QPSK	1880.0	QPSK	3	2	1	20.88	21.62	0.145
							6	0	2	19.96	20.70	0.117
							1	0	0	22.21	22.95	0.197
							1	2	0	22.28	23.02	0.200
							1	5	0	22.10	22.84	0.192
							3	0	0	22.21	22.95	0.197
				16QAM	3	1	0	22.28	23.02	0.200		
					3	2	0	22.10	22.84	0.192		
					6	0	1	21.27	22.01	0.159		
					1	0	1	21.39	22.13	0.163		
					1	2	1	21.35	22.09	0.162		
					1	5	1	21.17	21.91	0.155		
		19192	1909.2	QPSK	1909.2	QPSK	3	0	1	21.39	22.13	0.163
							3	1	1	21.35	22.09	0.162
							3	2	1	21.17	21.91	0.155
							6	0	2	20.50	21.24	0.133
							1	0	0	22.33	23.07	0.203
							1	2	0	22.38	23.12	0.205
				16QAM	1	5	0	22.21	22.95	0.197		
					3	0	0	22.33	23.07	0.203		
					3	1	0	22.38	23.12	0.205		
					3	2	0	22.21	22.95	0.197		
					6	0	1	21.39	22.13	0.163		
					1	0	1	21.51	22.25	0.168		
16QAM	1	2	1	21.47	22.21	0.166						
	1	5	1	21.28	22.02	0.159						
	3	0	1	21.51	22.25	0.168						
	3	1	1	21.47	22.21	0.166						
	3	2	1	21.28	22.02	0.159						
	6	0	2	20.60	21.34	0.136						

NOTE:

- (1) EIRP = Average power + Antenna gain.
- (2) ERP = EIRP - 2.15.
- (3) $P(W) = 1 W \cdot 10^{(P(dBm) / 10)} / 1000$
- (4) The antenna gain is 0.74 dBi.

Band	BW (MHz)	Channel	Frequency (MHz)	Mode	UL RB Allocation	UL RB Offset	MPR	Average power (dBm)	EIRP (dBm)	EIRP (W)
2	3	18615	1851.5	QPSK	1	0	0	22.16	22.90	0.195
					1	7	0	22.01	22.75	0.188
					1	14	0	21.82	22.56	0.180
					8	0	1	21.31	22.05	0.160
					8	4	1	21.09	21.83	0.152
					8	7	1	21.04	21.78	0.151
				15	0	1	20.92	21.66	0.147	
				16QAM	1	0	1	21.38	22.12	0.163
					1	7	1	21.19	21.93	0.156
					1	14	1	20.93	21.67	0.147
					8	0	2	20.21	20.95	0.124
					8	4	2	20.19	20.93	0.124
		8	7		2	19.89	20.63	0.116		
		18900	1880.0	QPSK	1	0	0	22.26	23.00	0.200
					1	7	0	22.33	23.07	0.203
					1	14	0	22.15	22.89	0.195
					8	0	1	21.37	22.11	0.163
					8	4	1	21.37	22.11	0.163
					8	7	1	21.33	22.07	0.161
				15	0	1	21.32	22.06	0.161	
				16QAM	1	0	1	21.44	22.18	0.165
					1	7	1	21.40	22.14	0.164
					1	14	1	21.22	21.96	0.157
					8	0	2	20.27	21.01	0.126
					8	4	2	20.47	21.21	0.132
		8	7		2	20.18	20.92	0.124		
		19184	1908.4	QPSK	1	0	0	22.38	23.12	0.205
					1	7	0	22.43	23.17	0.207
					1	14	0	22.26	23.00	0.200
					8	0	1	21.49	22.23	0.167
					8	4	1	21.47	22.21	0.166
					8	7	1	21.44	22.18	0.165
				15	0	1	21.44	22.18	0.165	
16QAM	1			0	1	21.56	22.30	0.170		
	1			7	1	21.52	22.26	0.168		
	1			14	1	21.33	22.07	0.161		
	8			0	2	20.39	21.13	0.130		
	8			4	2	20.57	21.31	0.135		
	8	7	2	20.29	21.03	0.127				
15	0	2	21.10	21.84	0.153					

NOTE:

- (1) EIRP = Average power + Antenna gain.
- (2) ERP = EIRP - 2.15.
- (3) $P(W) = 1 W \cdot 10^{(P(dBm) / 10)} / 1000$
- (4) The antenna gain is 0.74 dBi.

Band	BW (MHz)	Channel	Frequency (MHz)	Mode	UL RB Allocation	UL RB Offset	MPR	Average power (dBm)	EIRP (dBm)	EIRP (W)			
2	5	18625	1852.5	QPSK	1	0	0	22.21	22.95	0.197			
					1	12	0	22.06	22.80	0.191			
					1	24	0	21.87	22.61	0.182			
					12	0	1	21.36	22.10	0.162			
					12	6	1	21.14	21.88	0.154			
					12	11	1	21.09	21.83	0.152			
				16QAM	25	0	1	20.97	21.71	0.148			
					1	0	1	21.43	22.17	0.165			
					1	12	1	21.24	21.98	0.158			
					1	24	1	20.98	21.72	0.149			
					12	0	2	20.26	21.00	0.126			
					12	6	2	20.24	20.98	0.125			
		18900	1880.0	QPSK	1880.0	QPSK	12	11	2	19.94	20.68	0.117	
							25	0	2	20.06	20.80	0.120	
							1	0	0	22.31	23.05	0.202	
							1	12	0	22.38	23.12	0.205	
							1	24	0	22.20	22.94	0.197	
							12	0	1	21.42	22.16	0.164	
				16QAM	16QAM	16QAM	16QAM	12	6	1	21.42	22.16	0.164
								12	11	1	21.38	22.12	0.163
								25	0	1	21.37	22.11	0.163
								1	0	1	21.49	22.23	0.167
								1	12	1	21.45	22.19	0.166
								1	24	1	21.27	22.01	0.159
		19175	1907.5	QPSK	1907.5	QPSK	12	0	2	20.32	21.06	0.128	
							12	6	2	20.52	21.26	0.134	
							12	11	2	20.23	20.97	0.125	
							25	0	2	20.46	21.20	0.132	
							1	0	0	22.43	23.17	0.207	
							1	12	0	22.48	23.22	0.210	
				16QAM	16QAM	16QAM	16QAM	1	24	0	22.31	23.05	0.202
								12	0	1	21.54	22.28	0.169
								12	6	1	21.52	22.26	0.168
								12	11	1	21.49	22.23	0.167
								25	0	1	21.49	22.23	0.167
								1	0	1	21.61	22.35	0.172
16QAM	16QAM	16QAM	16QAM	1	12	1	21.57	22.31	0.170				
				1	24	1	21.38	22.12	0.163				
				12	0	2	20.44	21.18	0.131				
				12	6	2	20.62	21.36	0.137				
				12	11	2	20.34	21.08	0.128				
				25	0	2	20.58	21.32	0.136				

NOTE:

- (1) EIRP = Average power + Antenna gain.
- (2) ERP = EIRP - 2.15.
- (3) $P(W) = 1 W \cdot 10^{(P(dBm) / 10)} / 1000$
- (4) The antenna gain is 0.74 dBi.

Band	BW (MHz)	Channel	Frequency (MHz)	Mode	UL RB Allocation	UL RB Offset	MPR	Average power (dBm)	EIRP (dBm)	EIRP (W)				
2	10	18650	1855.0	QPSK	1	0	0	22.26	23.00	0.200				
					1	24	0	22.11	22.85	0.193				
					1	49	0	21.92	22.66	0.185				
					25	0	1	21.41	22.15	0.164				
					25	12	1	21.19	21.93	0.156				
					25	24	1	21.14	21.88	0.154				
				16QAM	50	0	1	21.02	21.76	0.150				
					1	0	1	21.48	22.22	0.167				
					1	24	1	21.29	22.03	0.160				
					1	49	1	21.03	21.77	0.150				
					25	0	2	20.31	21.05	0.127				
					25	12	2	20.29	21.03	0.127				
		18900	1880.0	QPSK	1880.0	QPSK	25	24	2	19.99	20.73	0.118		
							50	0	2	20.11	20.85	0.122		
							1	0	0	22.36	23.10	0.204		
							1	24	0	22.43	23.17	0.207		
							1	49	0	22.25	22.99	0.199		
							25	0	1	21.47	22.21	0.166		
				16QAM	1880.0	16QAM	1880.0	16QAM	25	12	1	21.47	22.21	0.166
									25	24	1	21.43	22.17	0.165
									50	0	1	21.42	22.16	0.164
									1	0	1	21.54	22.28	0.169
									1	24	1	21.50	22.24	0.167
									1	49	1	21.32	22.06	0.161
		19150	1905.0	QPSK	1905.0	QPSK	25	0	2	20.37	21.11	0.129		
							25	12	2	20.57	21.31	0.135		
							25	24	2	20.28	21.02	0.126		
							50	0	2	20.51	21.25	0.133		
							1	0	0	22.48	23.22	0.210		
							1	24	0	22.53	23.27	0.212		
16QAM	1905.0			16QAM	1905.0	16QAM	1	49	0	22.36	23.10	0.204		
							25	0	1	21.59	22.33	0.171		
							25	12	1	21.57	22.31	0.170		
							25	24	1	21.54	22.28	0.169		
							50	0	1	21.54	22.28	0.169		
							1	0	1	21.66	22.40	0.174		
16QAM	1905.0	16QAM	1905.0	16QAM	1	24	1	21.62	22.36	0.172				
					1	49	1	21.43	22.17	0.165				
					25	0	2	20.49	21.23	0.133				
					25	12	2	20.67	21.41	0.138				
					25	24	2	20.39	21.13	0.130				
					50	0	2	20.63	21.37	0.137				

NOTE:

- (1) EIRP = Average power + Antenna gain.
- (2) ERP = EIRP - 2.15.
- (3) $P(W) = 1 W \cdot 10^{(P(dBm) / 10)} / 1000$
- (4) The antenna gain is 0.74 dBi.

Band	BW (MHz)	Channel	Frequency (MHz)	Mode	UL RB Allocation	UL RB Offset	MPR	Average power (dBm)	EIRP (dBm)	EIRP (W)				
2	15	18675	1857.5	QPSK	1	0	0	22.31	23.05	0.202				
					1	37	0	22.16	22.90	0.195				
					1	74	0	21.97	22.71	0.187				
					36	0	1	21.46	22.20	0.166				
					36	18	1	21.24	21.98	0.158				
					36	35	1	21.19	21.93	0.156				
				16QAM	75	0	1	21.07	21.81	0.152				
					1	0	1	21.53	22.27	0.169				
					1	37	1	21.34	22.08	0.161				
					1	74	1	21.08	21.82	0.152				
					36	0	2	20.36	21.10	0.129				
					36	18	2	20.34	21.08	0.128				
		18900	1880.0	QPSK	1880.0	QPSK	36	35	2	20.04	20.78	0.120		
							75	0	2	20.16	20.90	0.123		
							1	0	0	22.41	23.15	0.207		
							1	37	0	22.48	23.22	0.210		
							1	74	0	22.30	23.04	0.201		
							36	0	1	21.52	22.26	0.168		
				16QAM	16QAM	16QAM	16QAM	16QAM	36	18	1	21.52	22.26	0.168
									36	35	1	21.48	22.22	0.167
									75	0	1	21.47	22.21	0.166
									1	0	1	21.59	22.33	0.171
									1	37	1	21.55	22.29	0.169
									1	74	1	21.37	22.11	0.163
		19125	1902.5	QPSK	1902.5	QPSK	36	0	2	20.42	21.16	0.131		
							36	18	2	20.62	21.36	0.137		
							36	35	2	20.33	21.07	0.128		
							75	0	2	20.56	21.30	0.135		
							1	0	0	22.53	23.27	0.212		
							1	37	0	22.58	23.32	0.215		
				16QAM	16QAM	16QAM	16QAM	16QAM	1	74	0	22.41	23.15	0.207
									36	0	1	21.64	22.38	0.173
									36	18	1	21.62	22.36	0.172
									36	35	1	21.59	22.33	0.171
									75	0	1	21.59	22.33	0.171
									1	0	1	21.71	22.45	0.176
16QAM	16QAM	16QAM	16QAM	16QAM	1	37	1	21.67	22.41	0.174				
					1	74	1	21.48	22.22	0.167				
					36	0	2	20.54	21.28	0.134				
					36	18	2	20.72	21.46	0.140				
					36	35	2	20.44	21.18	0.131				
					75	0	2	20.68	21.42	0.139				

NOTE:

- (1) EIRP = Average power + Antenna gain.
- (2) ERP = EIRP - 2.15.
- (3) $P(W) = 1 W \cdot 10^{(P(dBm) / 10)} / 1000$
- (4) The antenna gain is 0.74 dBi.

Band	BW (MHz)	Channel	Frequency (MHz)	Mode	UL RB Allocation	UL RB Offset	MPR	Average power (dBm)	EIRP (dBm)	EIRP (W)
2	20	18700	1860.0	QPSK	1	0	0	22.36	23.10	0.204
					1	49	0	22.21	22.95	0.197
					1	99	0	22.02	22.76	0.189
					50	0	1	21.47	22.21	0.166
					50	24	1	21.25	21.99	0.158
					50	49	1	21.20	21.94	0.156
				16QAM	100	0	1	21.08	21.82	0.152
					1	0	1	21.54	22.28	0.169
					1	49	1	21.35	22.09	0.162
					1	99	1	21.09	21.83	0.152
					50	0	2	20.37	21.11	0.129
					50	24	2	20.35	21.09	0.129
		18900	1880.0	QPSK	50	49	2	20.05	20.79	0.120
					100	0	2	20.17	20.91	0.123
					1	0	0	22.42	23.16	0.207
					1	49	0	22.49	23.23	0.210
					1	99	0	22.31	23.05	0.202
					50	0	1	21.53	22.27	0.169
				16QAM	50	24	1	21.53	22.27	0.169
					50	49	1	21.49	22.23	0.167
					100	0	1	21.48	22.22	0.167
					1	0	1	21.60	22.34	0.171
					1	49	1	21.56	22.30	0.170
					1	99	1	21.38	22.12	0.163
		19100	1900.0	QPSK	50	0	2	20.43	21.17	0.131
					50	24	2	20.63	21.37	0.137
					50	49	2	20.34	21.08	0.128
					100	0	2	20.57	21.31	0.135
					1	0	0	22.54	23.28	0.213
					1	49	0	22.59	23.33	0.215
16QAM	1			99	0	22.42	23.16	0.207		
	50			0	1	21.65	22.39	0.173		
	50			24	1	21.63	22.37	0.173		
	50			49	1	21.60	22.34	0.171		
	100			0	1	21.60	22.34	0.171		
	1			0	1	21.72	22.46	0.176		
16QAM	1	49	1	21.68	22.42	0.175				
	1	99	1	21.49	22.23	0.167				
	50	0	2	20.55	21.29	0.135				
	50	24	2	20.73	21.47	0.140				
	50	49	2	20.45	21.19	0.132				
	100	0	2	20.69	21.43	0.139				

NOTE:

- (1) EIRP = Average power + Antenna gain.
- (2) ERP = EIRP - 2.15.
- (3) $P(W) = 1 W \cdot 10^{(P(dBm) / 10) / 1000}$
- (4) The antenna gain is 0.74 dBi.

Radiated ERIP Power:

Test Mode	WCDMA Band II	Test Date	2021/3/23
Test Channel	CH9662	Polarization	Vertical
Temp	21°C	Hum.	68%

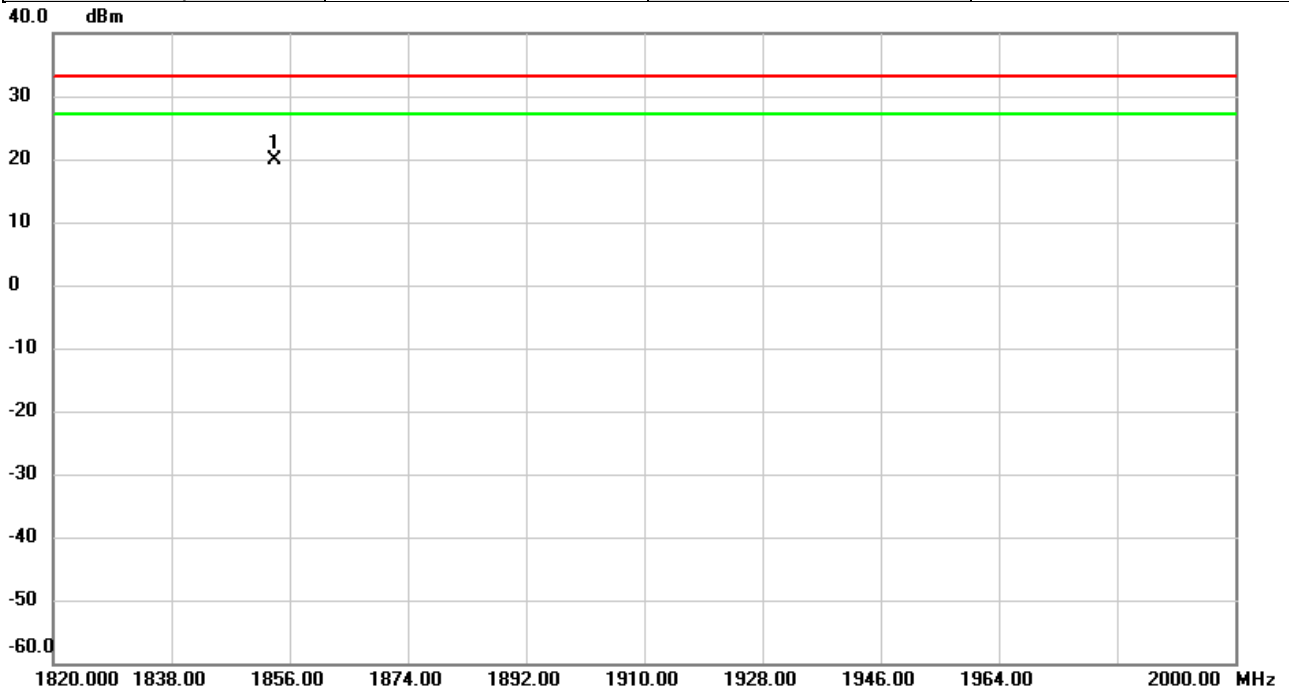

No.	Mk.	Freq. MHz	Reading Level dBm	Correct Factor dB	Measure- ment dBm	Limit dBm	Over dB	Detector	Comment
1	*	1853.804	-20.29	40.08	19.79	33.01	-13.22	peak	

REMARKS:

- (1) Measurement Value = Reading Level + Correct Factor.
- (2) Margin Level = Measurement Value - Limit Value.

Test Mode	WCDMA Band II	Test Date	2021/3/23
Test Channel	CH9662	Polarization	Horizontal
Temp	21°C	Hum.	68%

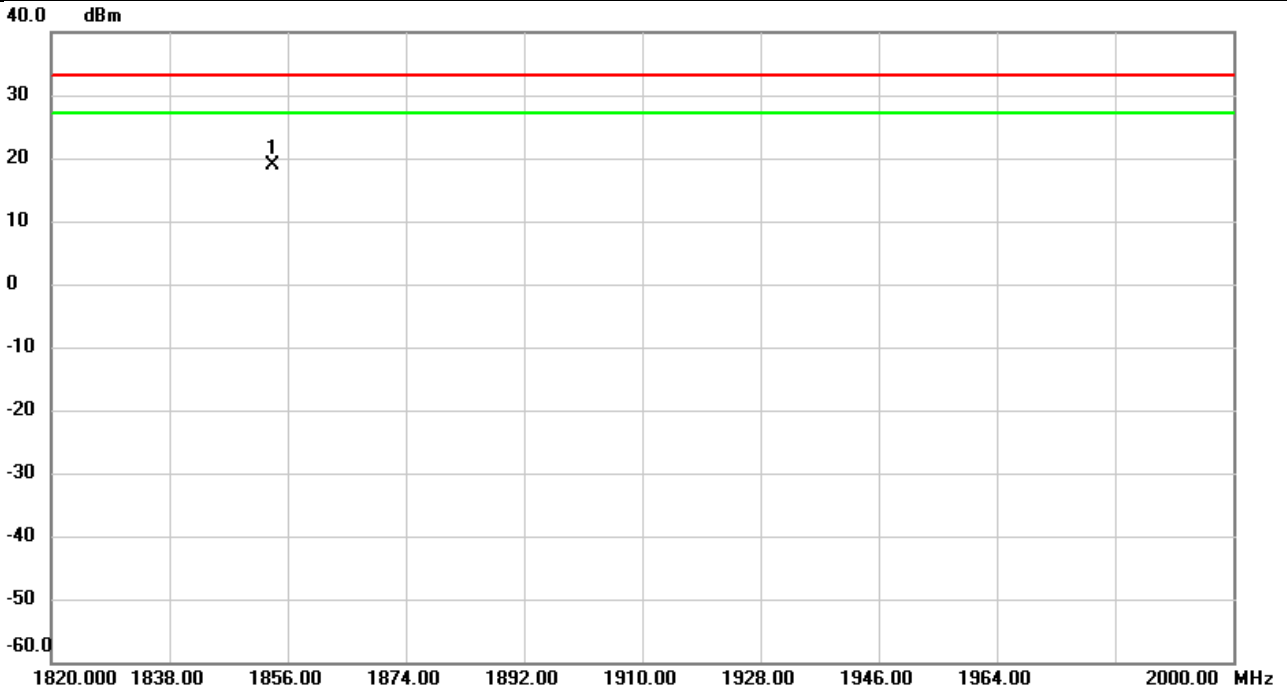

No.	Mk.	Freq.	Reading Level	Correct Factor	Measurement	Limit	Over	Detector	Comment
		MHz	dBm	dB	dBm	dBm	dB		
1	*	1853.834	-21.68	40.63	18.95	33.01	-14.06	peak	

REMARKS:

- (1) Measurement Value = Reading Level + Correct Factor.
- (2) Margin Level = Measurement Value - Limit Value.

Test Mode	WCDMA Band II	Test Date	2021/3/23
Test Channel	CH9800	Polarization	Vertical
Temp	21°C	Hum.	68%

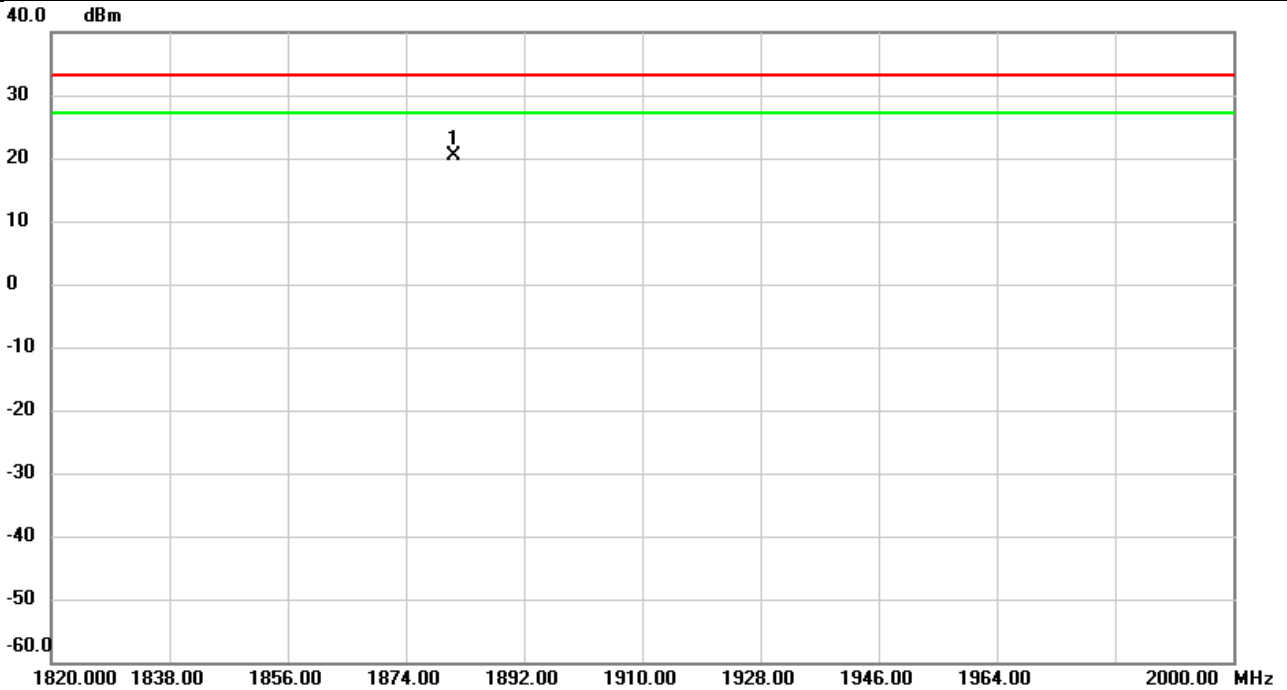

No.	Mk.	Freq. MHz	Reading Level dBm	Correct Factor dB	Measure- ment dBm	Limit dBm	Over dB	Detector	Comment
1	*	1881.296	-19.76	40.20	20.44	33.01	-12.57	peak	

REMARKS:

- (1) Measurement Value = Reading Level + Correct Factor.
- (2) Margin Level = Measurement Value - Limit Value.

Test Mode	WCDMA Band II	Test Date	2021/3/23
Test Channel	CH9800	Polarization	Horizontal
Temp	21°C	Hum.	68%

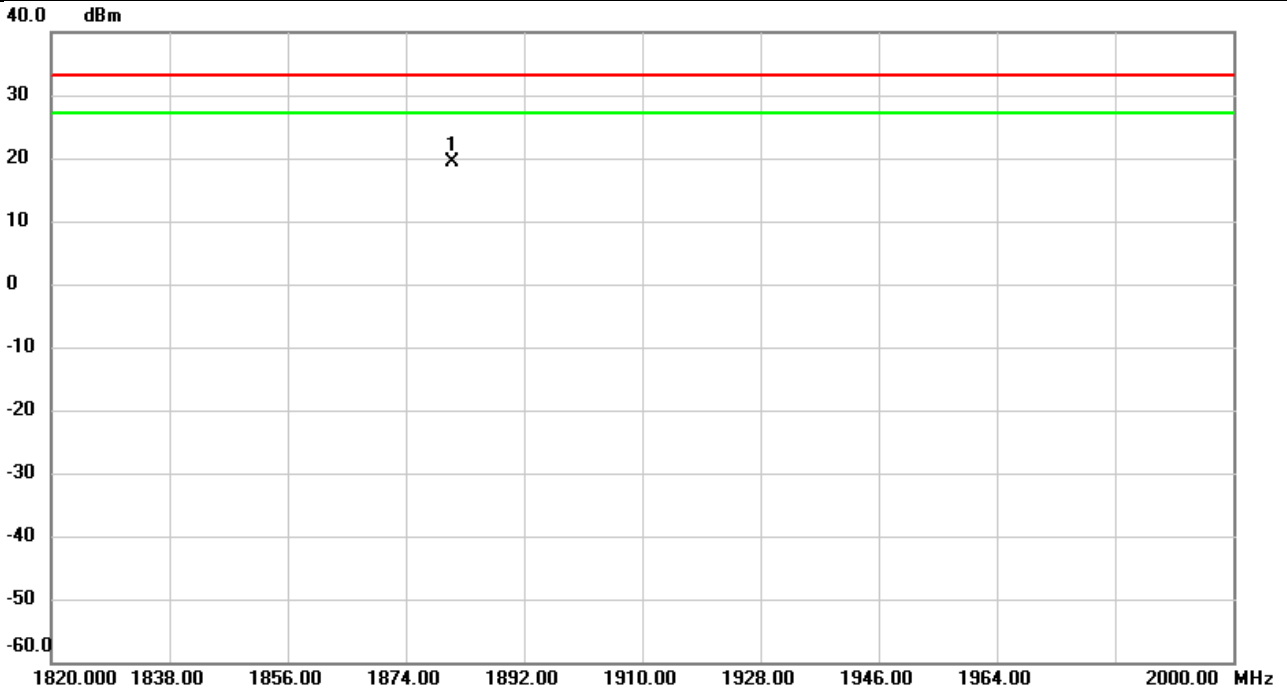

No.	Mk.	Freq. MHz	Reading Level dBm	Correct Factor dB	Measure- ment dBm	Limit dBm	Over dB	Detector	Comment
1	*	1881.080	-21.44	40.73	19.29	33.01	-13.72	peak	

REMARKS:

- (1) Measurement Value = Reading Level + Correct Factor.
- (2) Margin Level = Measurement Value - Limit Value.

Test Mode	WCDMA Band II	Test Date	2021/3/23
Test Channel	CH9938	Polarization	Vertical
Temp	21°C	Hum.	68%

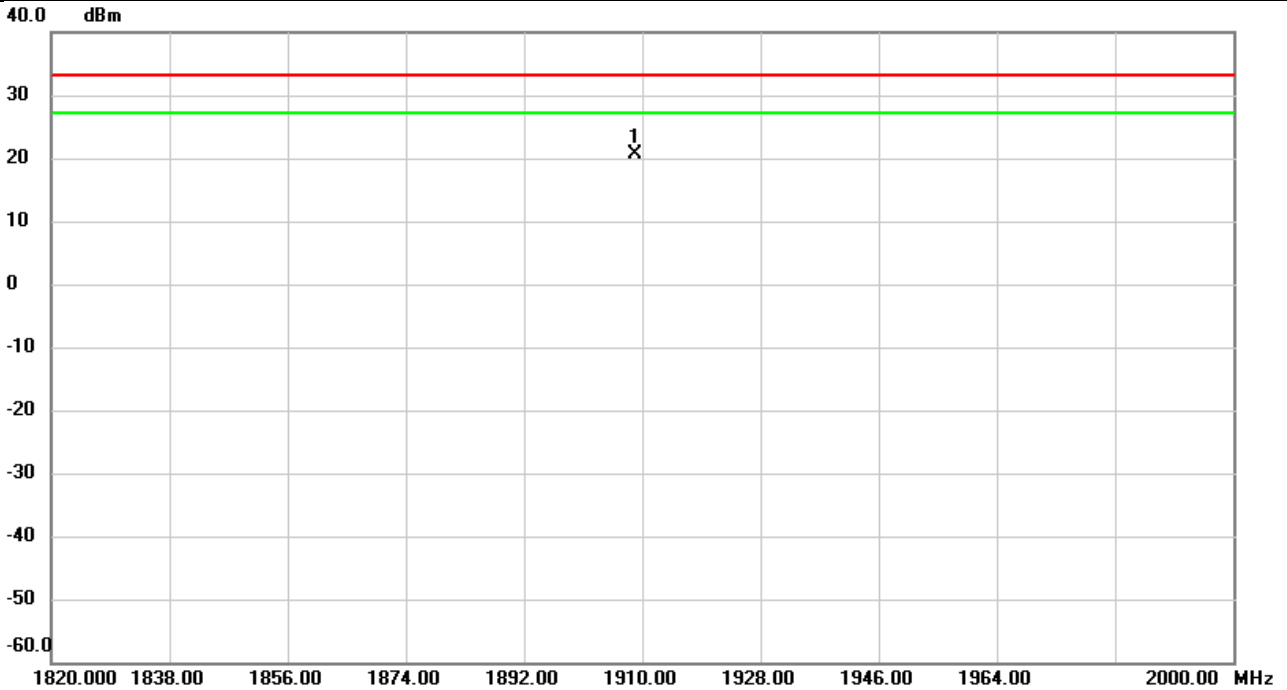

No.	Mk.	Freq. MHz	Reading Level dBm	Correct Factor dB	Measure- ment dBm	Limit dBm	Over dB	Detector	Comment
1	*	1908.842	-19.70	40.32	20.62	33.01	-12.39	peak	

REMARKS:

- (1) Measurement Value = Reading Level + Correct Factor.
- (2) Margin Level = Measurement Value - Limit Value.

Test Mode	WCDMA Band II	Test Date	2021/3/23
Test Channel	CH9938	Polarization	Horizontal
Temp	21°C	Hum.	68%

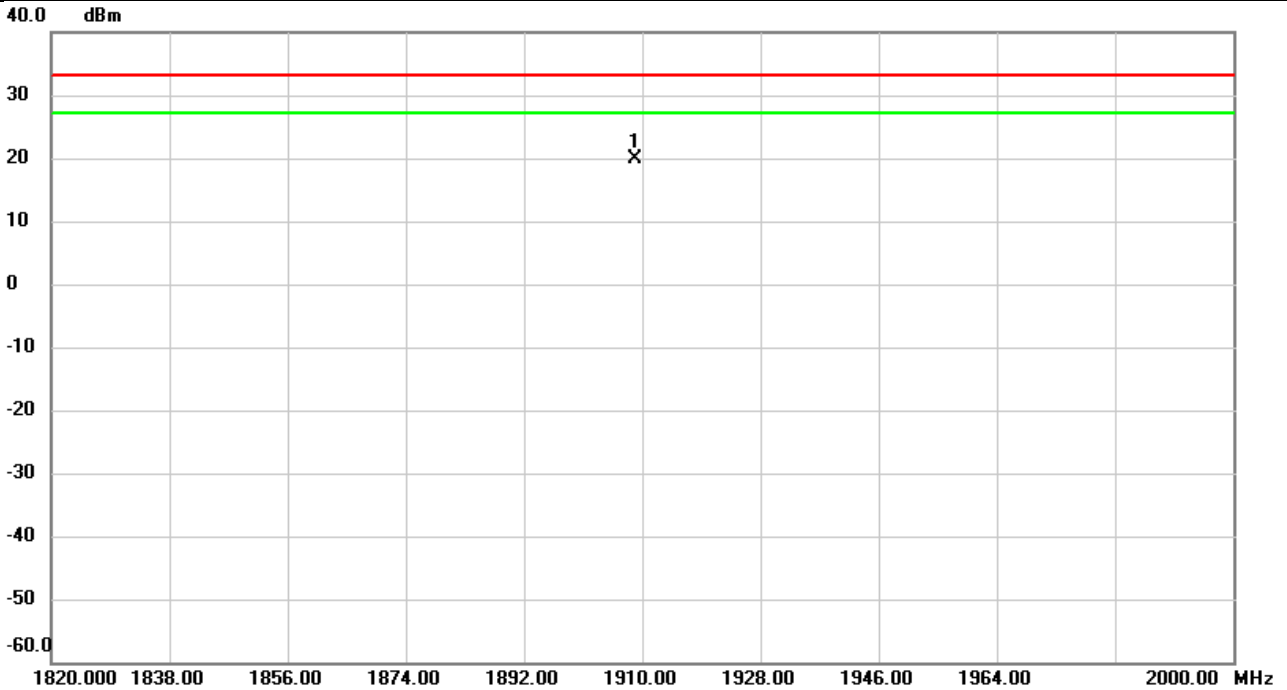

No.	Mk.	Freq. MHz	Reading Level dBm	Correct Factor dB	Measure- ment dBm	Limit dBm	Over dB	Detector	Comment
1	*	1908.848	-20.84	40.83	19.99	33.01	-13.02	peak	

REMARKS:

- (1) Measurement Value = Reading Level + Correct Factor.
- (2) Margin Level = Measurement Value - Limit Value.

Test Mode	LTE Band 2 (QPSK)	Test Date	2021/3/24
Test Channel	CH18700	Polarization	Vertical
Temp	21°C	Hum.	68%

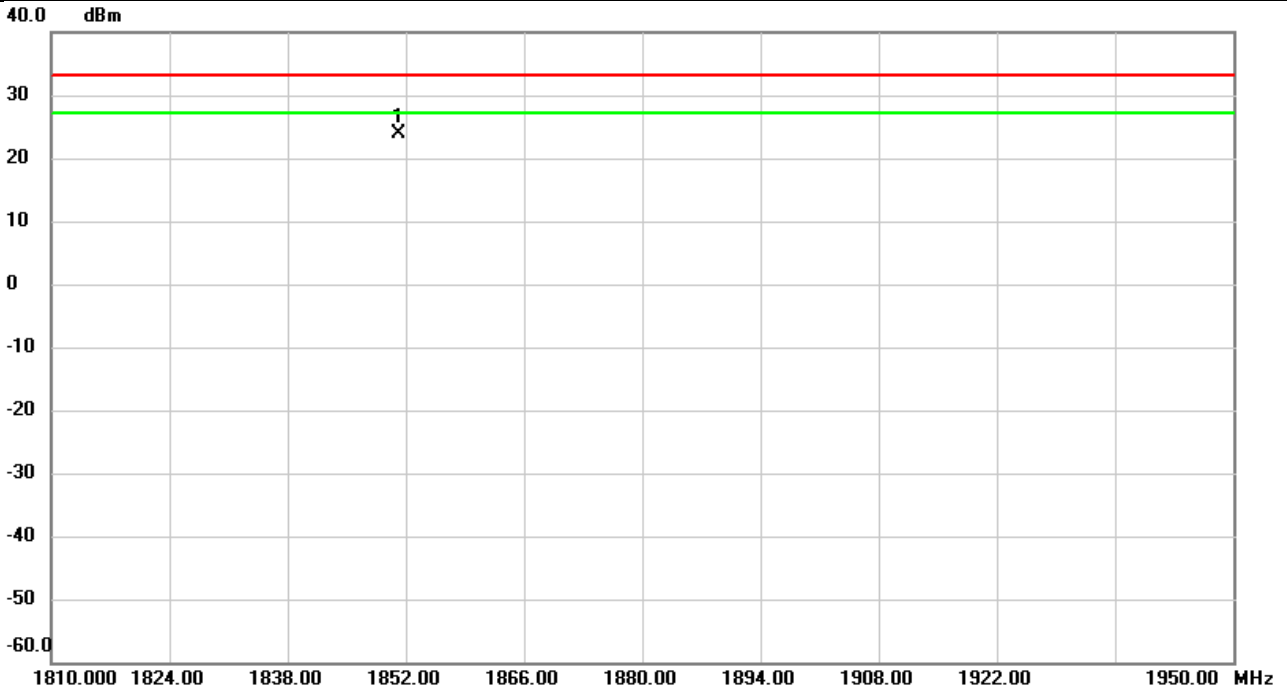

No.	Mk.	Freq. MHz	Reading Level dBm	Correct Factor dB	Measure- ment dBm	Limit dBm	Over dB	Detector	Comment
1	*	1851.071	-16.22	40.07	23.85	33.01	-9.16	peak	

REMARKS:

- (1) Measurement Value = Reading Level + Correct Factor.
- (2) Margin Level = Measurement Value - Limit Value.

Test Mode	LTE Band 2 (QPSK)	Test Date	2021/3/24
Test Channel	CH18700	Polarization	Horizontal
Temp	21°C	Hum.	68%

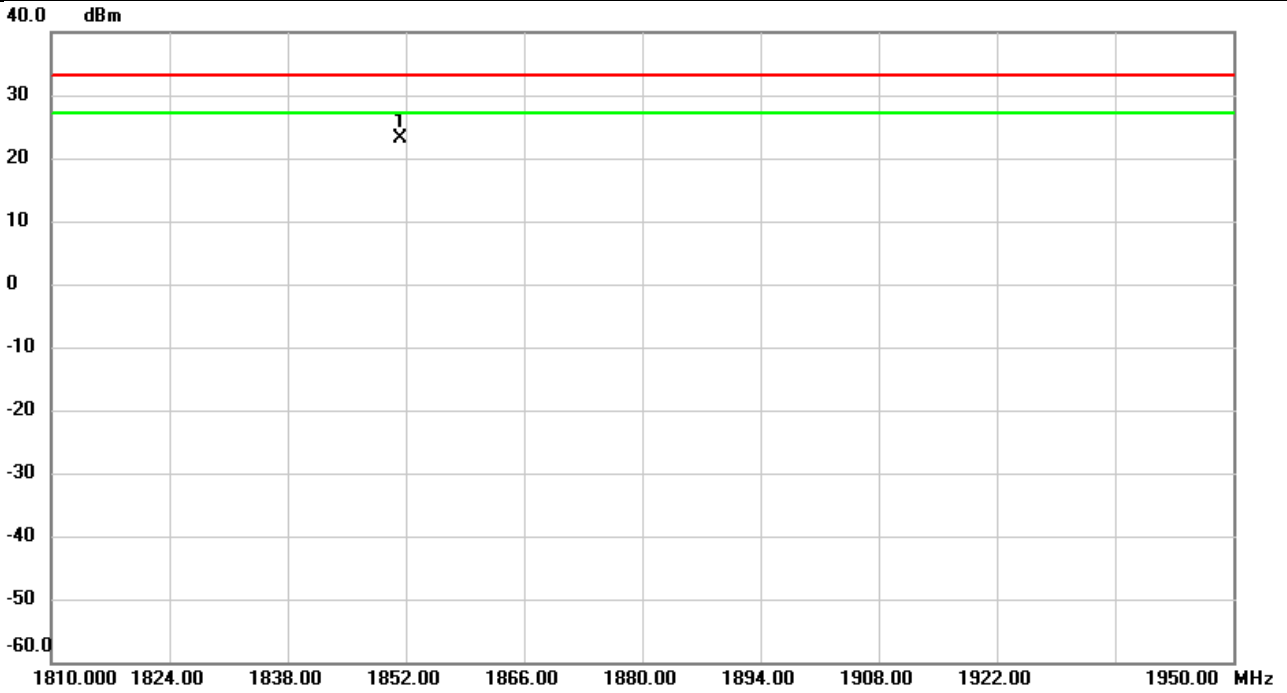

No.	Mk.	Freq.	Reading Level	Correct Factor	Measurement	Limit	Over	Detector	Comment
		MHz	dBm	dB	dBm	dBm	dB		
1	*	1851.319	-17.37	40.62	23.25	33.01	-9.76	peak	

REMARKS:

- (1) Measurement Value = Reading Level + Correct Factor.
- (2) Margin Level = Measurement Value - Limit Value.

Test Mode	LTE Band 2 (QPSK)	Test Date	2021/3/24
Test Channel	CH18900	Polarization	Vertical
Temp	21°C	Hum.	68%

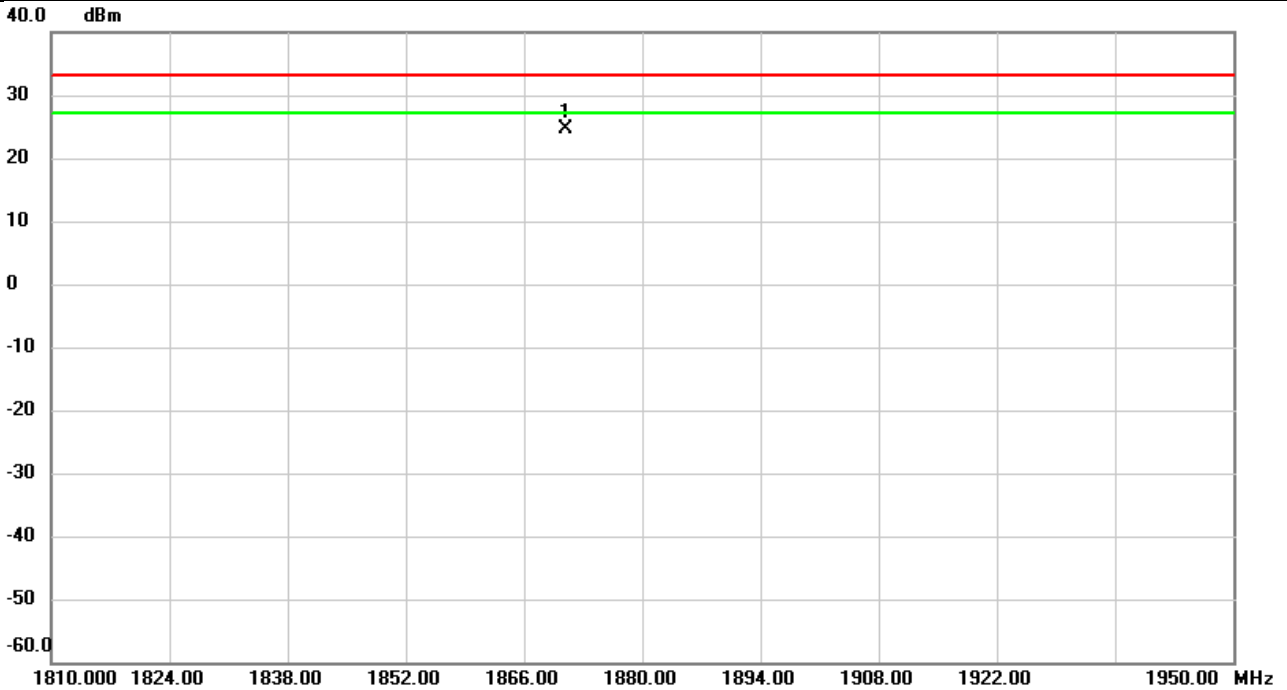

No.	Mk.	Freq.	Reading Level	Correct Factor	Measurement	Limit	Over	Detector	Comment
		MHz	dBm	dB	dBm	dBm	dB		
1	*	1871.035	-15.47	40.16	24.69	33.01	-8.32	peak	

REMARKS:

- (1) Measurement Value = Reading Level + Correct Factor.
- (2) Margin Level = Measurement Value - Limit Value.

Test Mode	LTE Band 2 (QPSK)	Test Date	2021/3/24
Test Channel	CH18900	Polarization	Horizontal
Temp	21°C	Hum.	68%

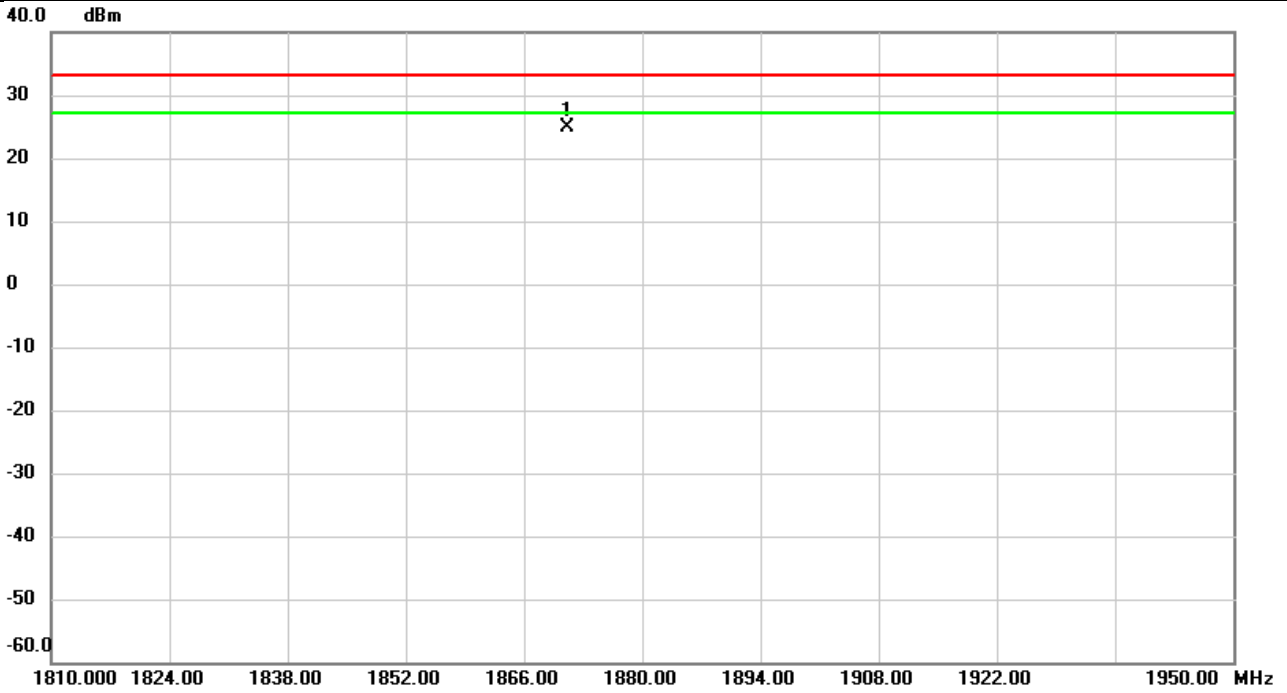

No.	Mk.	Freq.	Reading Level	Correct Factor	Measurement	Limit	Over	Detector	Comment
		MHz	dBm	dB	dBm	dBm	dB		
1	*	1871.203	-15.92	40.69	24.77	33.01	-8.24	peak	

REMARKS:

- (1) Measurement Value = Reading Level + Correct Factor.
- (2) Margin Level = Measurement Value - Limit Value.

Test Mode	LTE Band 2 (QPSK)	Test Date	2021/3/24
Test Channel	CH19100	Polarization	Vertical
Temp	21°C	Hum.	68%

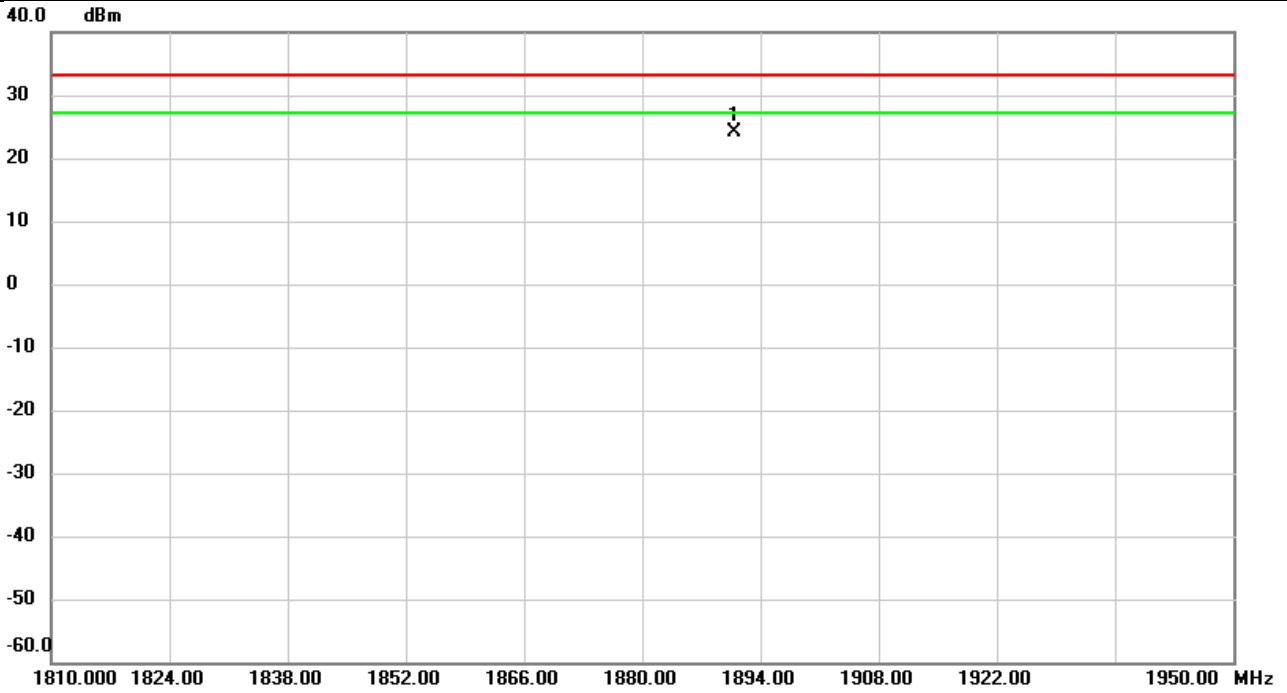

No.	Mk.	Freq. MHz	Reading Level dBm	Correct Factor dB	Measure- ment dBm	Limit dBm	Over dB	Detector	Comment
1	*	1891.009	-16.04	40.24	24.20	33.01	-8.81	peak	

REMARKS:

- (1) Measurement Value = Reading Level + Correct Factor.
- (2) Margin Level = Measurement Value - Limit Value.

Test Mode	LTE Band 2 (QPSK)	Test Date	2021/3/24
Test Channel	CH19100	Polarization	Horizontal
Temp	21°C	Hum.	68%

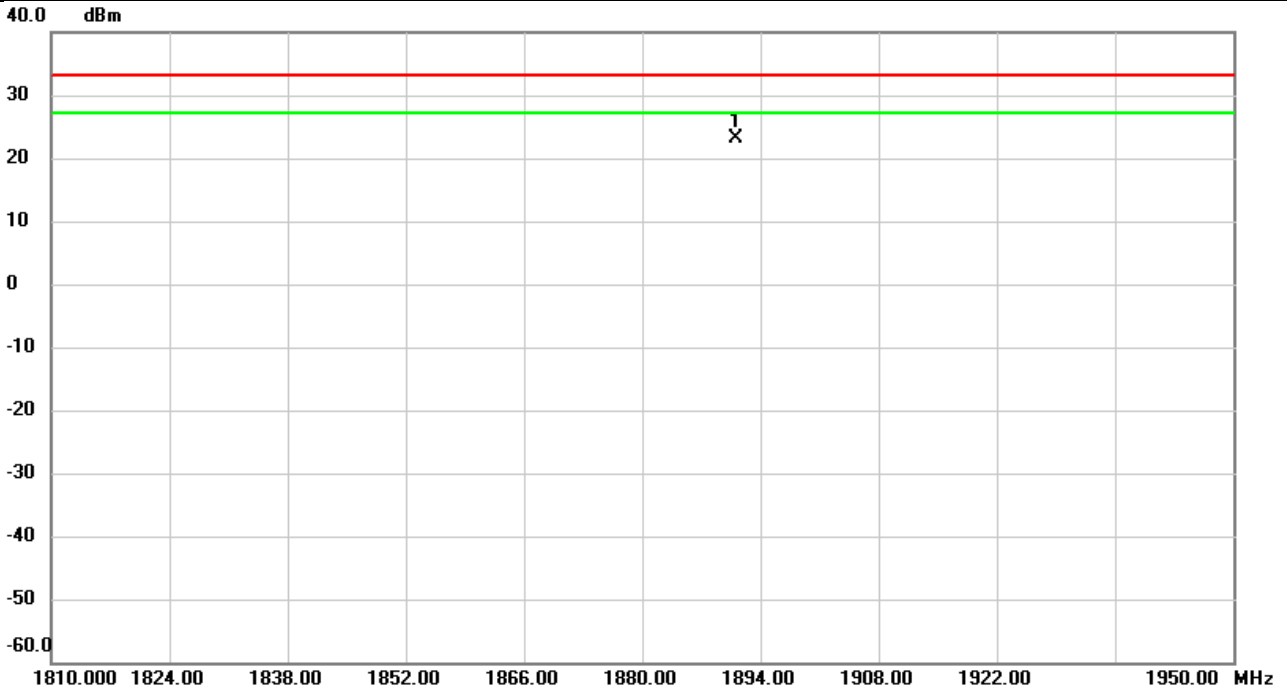

No.	Mk.	Freq.	Reading Level	Correct Factor	Measurement	Limit	Over	Detector	Comment
		MHz	dBm	dB	dBm	dBm	dB		
1	*	1891.046	-17.60	40.76	23.16	33.01	-9.85	peak	

REMARKS:

- (1) Measurement Value = Reading Level + Correct Factor.
- (2) Margin Level = Measurement Value - Limit Value.

APPENDIX C RADIATED SPURIOUS EMISSIONS

Test Mode	WCDMA Band II	Test Date	2021/3/25
Test Channel	CH9800	Polarization	Vertical
Temp	21°C	Hum.	68%

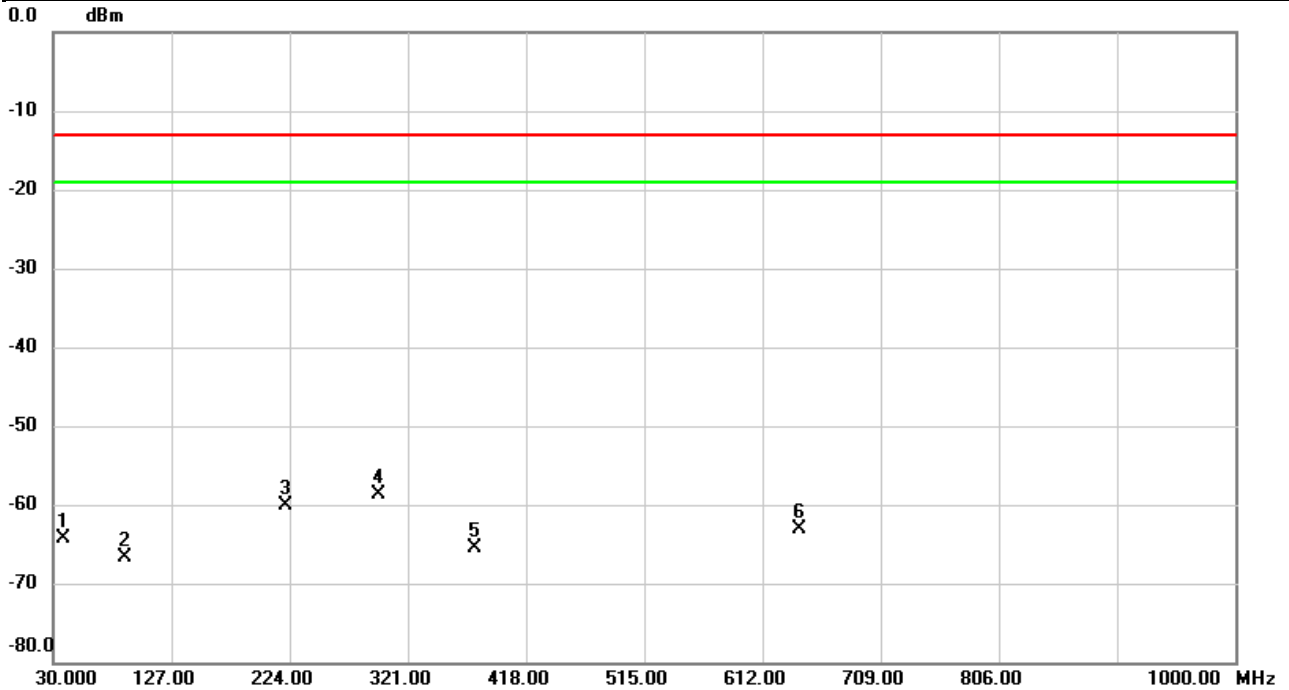

No.	Mk.	Freq. MHz	Reading Level dBm	Correct Factor dB	Measure- ment dBm	Limit dBm	Over dB	Detector	Comment
1		38.7300	-62.47	-1.84	-64.31	-13.00	-51.31	peak	
2		89.1700	-65.01	-1.62	-66.63	-13.00	-53.63	peak	
3		221.0900	-63.63	3.48	-60.15	-13.00	-47.15	peak	
4	*	296.7500	-66.30	7.62	-58.68	-13.00	-45.68	peak	
5		375.3200	-70.00	4.50	-65.50	-13.00	-52.50	peak	
6		642.0700	-75.73	12.61	-63.12	-13.00	-50.12	peak	

REMARKS:

- (1) Measurement Value = Reading Level + Correct Factor.
- (2) Margin Level = Measurement Value - Limit Value.

Test Mode	WCDMA Band II	Test Date	2021/3/25
Test Channel	CH9800	Polarization	Horizontal
Temp	21°C	Hum.	68%

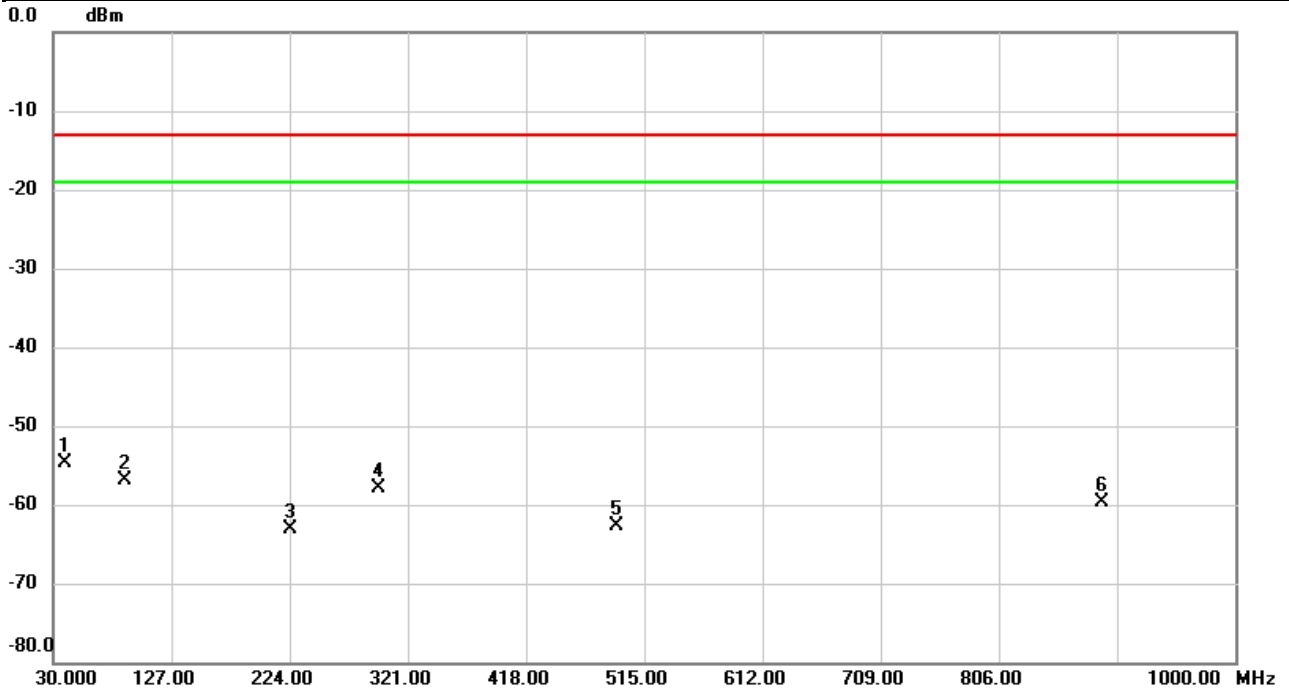

No.	Mk.	Freq. MHz	Reading Level dBm	Correct Factor dB	Measure- ment dBm	Limit dBm	Over dB	Detector	Comment
1	*	39.7000	-71.71	16.97	-54.74	-13.00	-41.74	peak	
2		88.2000	-60.99	4.04	-56.95	-13.00	-43.95	peak	
3		224.0000	-62.10	-0.91	-63.01	-13.00	-50.01	peak	
4		296.7500	-58.59	0.76	-57.83	-13.00	-44.83	peak	
5		491.7200	-73.85	11.21	-62.64	-13.00	-49.64	peak	
6		890.3900	-75.64	15.85	-59.79	-13.00	-46.79	peak	

REMARKS:

- (1) Measurement Value = Reading Level + Correct Factor.
- (2) Margin Level = Measurement Value - Limit Value.

Test Mode	WCDMA Band II	Test Date	2021/3/23
Test Channel	CH9800	Polarization	Vertical
Temp	21°C	Hum.	68%

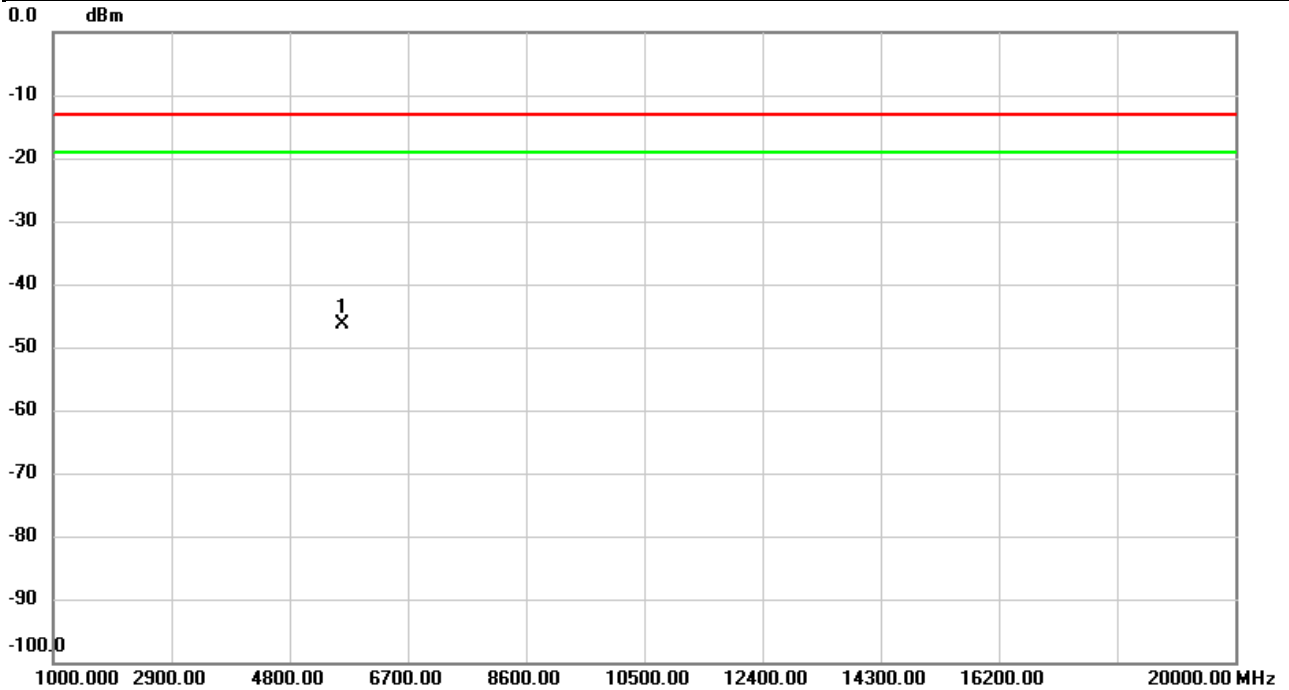

No.	Mk.	Freq.	Reading Level	Correct Factor	Measurement	Limit	Over	Detector	Comment
		MHz	dBm	dB	dBm	dBm	dB		
1	*	5642.333	-48.87	2.38	-46.49	-13.00	-33.49	peak	

REMARKS:

- (1) Measurement Value = Reading Level + Correct Factor.
- (2) Margin Level = Measurement Value - Limit Value.

Test Mode	WCDMA Band II	Test Date	2021/3/23
Test Channel	CH9800	Polarization	Horizontal
Temp	21°C	Hum.	68%

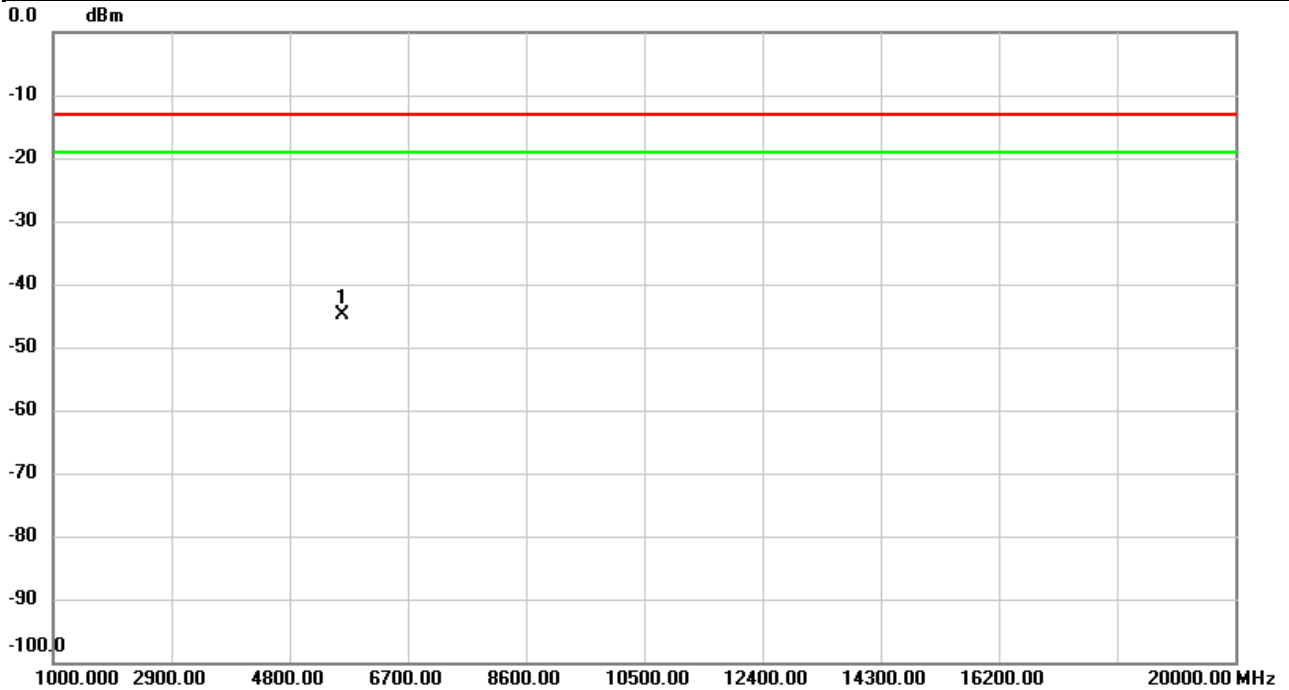

No.	Mk.	Freq.	Reading Level	Correct Factor	Measurement	Limit	Over	Detector	Comment
		MHz	dBm	dB	dBm	dBm	dB		
1	*	5639.167	-47.75	2.76	-44.99	-13.00	-31.99	peak	

REMARKS:

- (1) Measurement Value = Reading Level + Correct Factor.
- (2) Margin Level = Measurement Value - Limit Value.

Test Mode	LTE Band 2 (QPSK)	Test Date	2021/3/25
Test Channel	CH18900	Polarization	Vertical
Temp	21°C	Hum.	68%

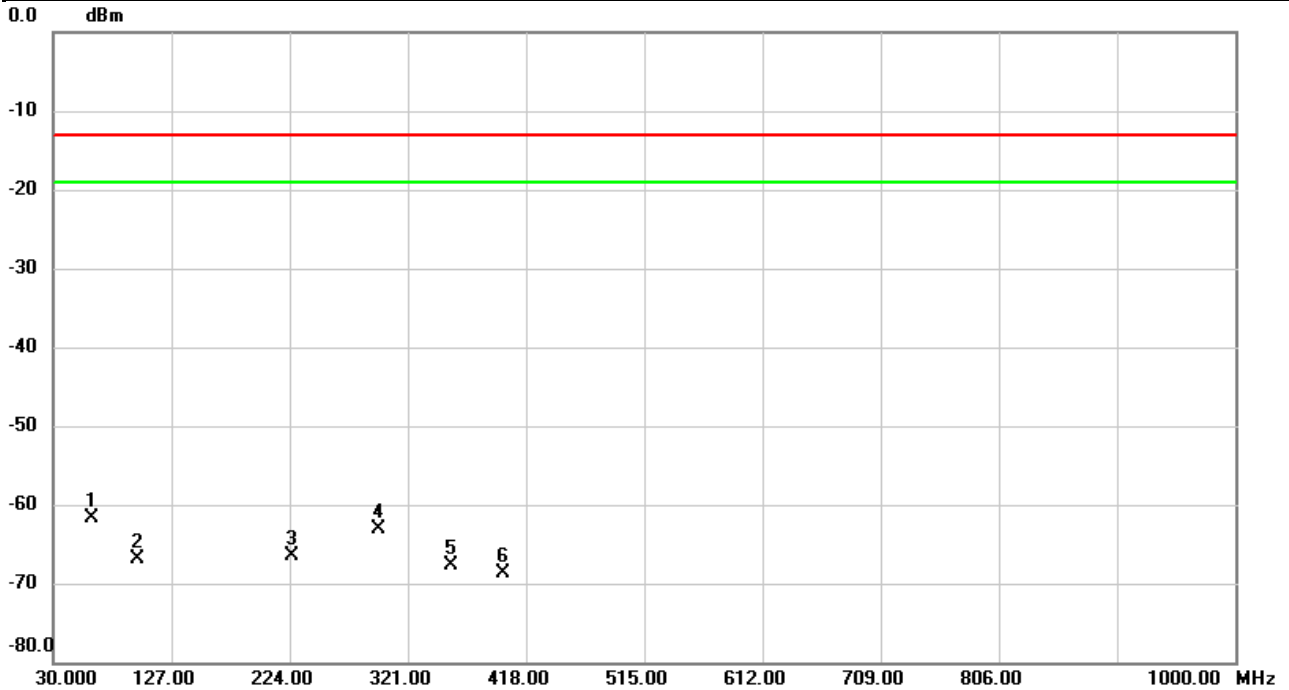

No.	Mk.	Freq. MHz	Reading Level dBm	Correct Factor dB	Measure- ment dBm	Limit dBm	Over dB	Detector	Comment
1	*	62.0100	-60.11	-1.55	-61.66	-13.00	-48.66	peak	
2		98.8700	-67.35	0.52	-66.83	-13.00	-53.83	peak	
3		225.9400	-70.09	3.63	-66.46	-13.00	-53.46	peak	
4		296.7500	-70.81	7.62	-63.19	-13.00	-50.19	peak	
5		355.9200	-73.84	6.14	-67.70	-13.00	-54.70	peak	
6		399.5700	-71.25	2.45	-68.80	-13.00	-55.80	peak	

REMARKS:

- (1) Measurement Value = Reading Level + Correct Factor.
- (2) Margin Level = Measurement Value - Limit Value.

Test Mode	LTE Band 2 (QPSK)	Test Date	2021/3/25
Test Channel	CH18900	Polarization	Horizontal
Temp	21°C	Hum.	68%

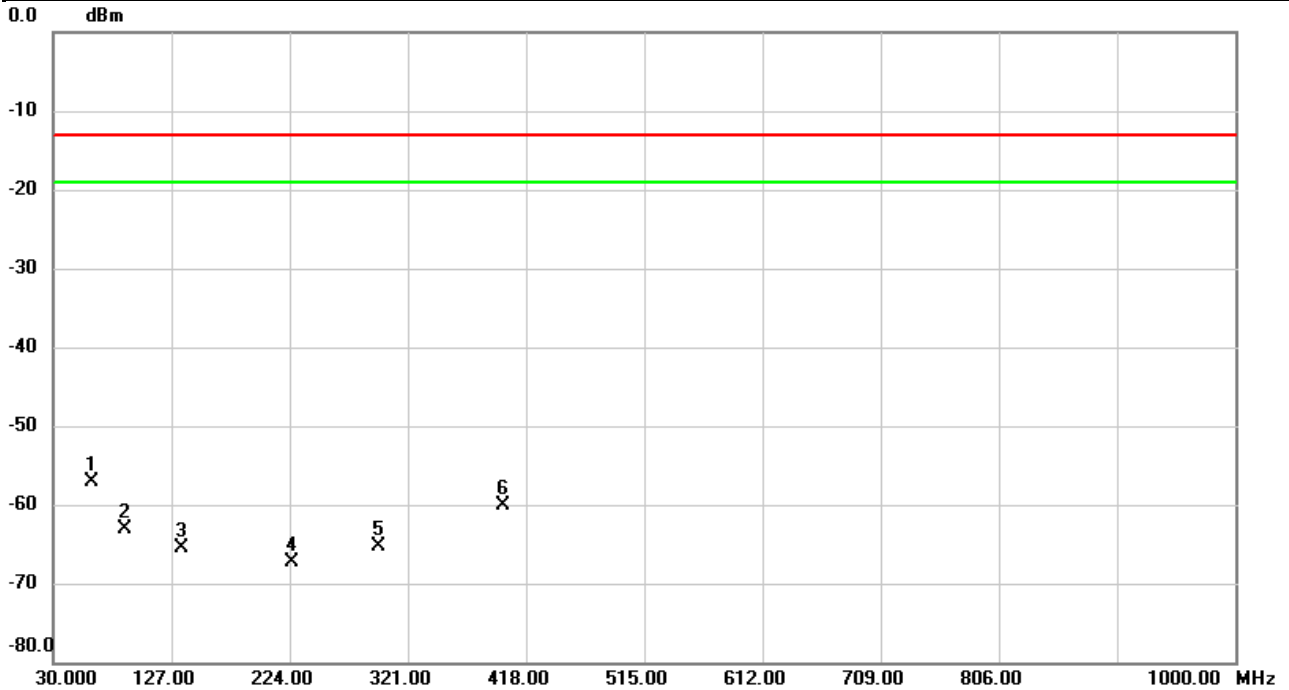

No.	Mk.	Freq.	Reading Level	Correct Factor	Measurement	Limit	Over	Detector	Comment
		MHz	dBm	dB	dBm	dBm	dB		
1	*	61.0400	-63.75	6.68	-57.07	-13.00	-44.07	peak	
2		89.1700	-66.91	3.83	-63.08	-13.00	-50.08	peak	
3		134.7600	-68.34	2.79	-65.55	-13.00	-52.55	peak	
4		225.9400	-66.49	-0.76	-67.25	-13.00	-54.25	peak	
5		296.7500	-65.99	0.76	-65.23	-13.00	-52.23	peak	
6		399.5700	-66.35	6.16	-60.19	-13.00	-47.19	peak	

REMARKS:

- (1) Measurement Value = Reading Level + Correct Factor.
- (2) Margin Level = Measurement Value - Limit Value.

Test Mode	LTE Band 2 (QPSK)	Test Date	2021/3/24
Test Channel	CH18900	Polarization	Vertical
Temp	21°C	Hum.	68%

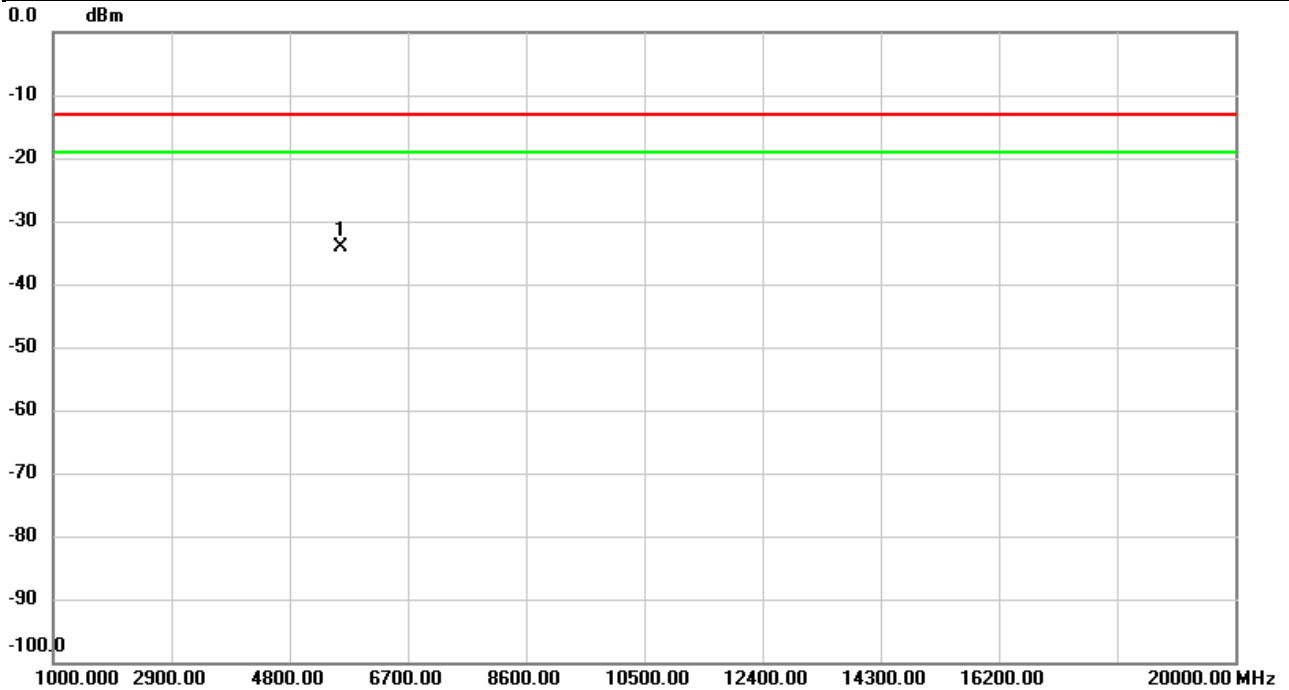

No.	Mk.	Freq.	Reading Level	Correct Factor	Measurement	Limit	Over	Detector	Comment
		MHz	dBm	dB	dBm	dBm	dB		
1	*	5613.200	-36.57	2.44	-34.13	-13.00	-21.13	peak	

REMARKS:

- (1) Measurement Value = Reading Level + Correct Factor.
- (2) Margin Level = Measurement Value - Limit Value.

Test Mode	LTE Band 2 (QPSK)	Test Date	2021/3/24
Test Channel	CH18900	Polarization	Horizontal
Temp	21°C	Hum.	68%

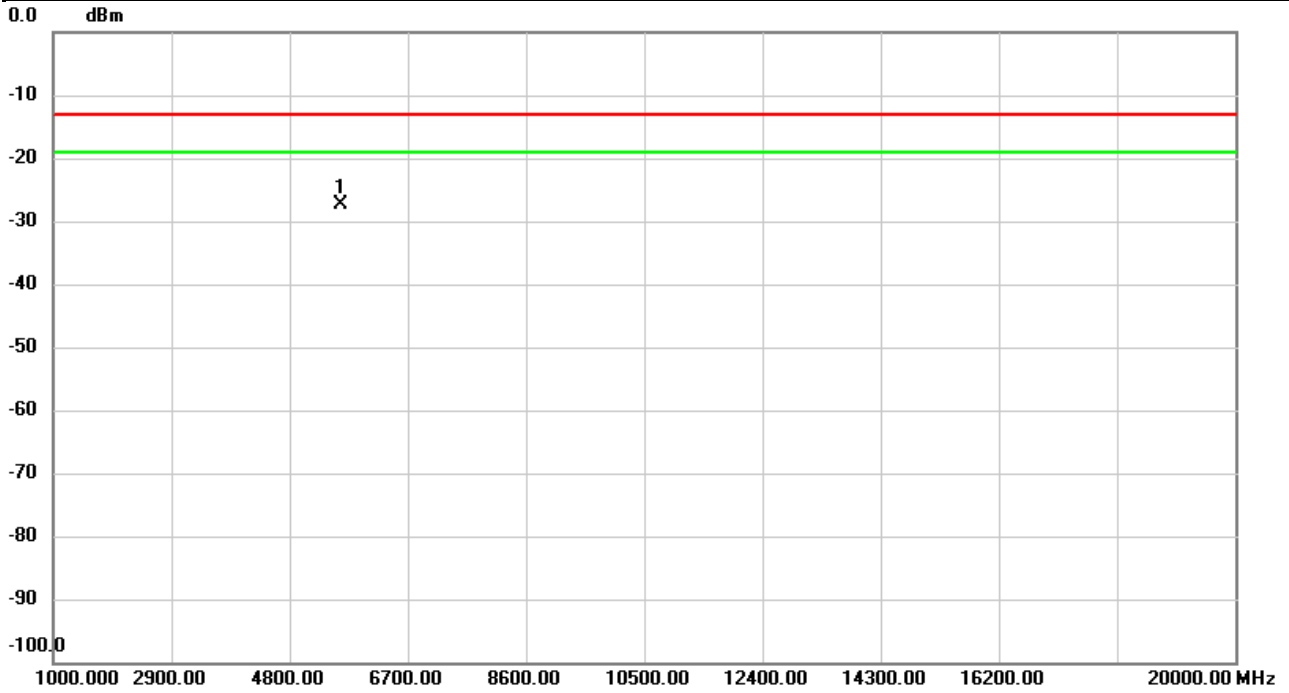

No.	Mk.	Freq.	Reading Level	Correct Factor	Measurement	Limit	Over	Detector	Comment
		MHz	dBm	dB	dBm	dBm	dB		
1	*	5613.200	-30.07	2.82	-27.25	-13.00	-14.25	peak	

REMARKS:

- (1) Measurement Value = Reading Level + Correct Factor.
- (2) Margin Level = Measurement Value - Limit Value.

End of Test Report