



FCC TEST REPORT

(Part 24)

REPORT NO.: RF980702L17-3

MODEL NO.: 0251 (refer to item 3.1 for more details)

RECEIVED: Jul. 02, 2009

TESTED: Jul. 15 ~ Jul. 22, 2009

ISSUED: Aug. 04, 2009

APPLICANT: Wistron Corporation

ADDRESS: 21F, No. 88, Sec. 1, Hsin Tai Wu Rd., Hsichih, Taipei Hsien 221, Taiwan, R.O.C.

ISSUED BY: Bureau Veritas Consumer Products Services (H.K.) Ltd., Taoyuan Branch

LAB ADDRESS: No. 47, 14th Ling, Chia Pau Tsuen, Lin Kou Hsiang, Taipei Hsien 244, Taiwan, R.O.C.

TEST LOCATION: No. 19, Hwa Ya 2nd Rd, Wen Hwa Tsuen, Kwei Shan Hsiang, Taoyuan Hsien 333, Taiwan, R.O.C.

This test report consists of 73 pages in total. It may be duplicated completely for legal use with the approval of the applicant. It should not be reproduced except in full, without the written approval of our laboratory. The client should not use it to claim product endorsement by TAF or any government agencies. The test results in the report only apply to the tested sample.



TABLE OF CONTENTS

1	CERTIFICATION	4
2	SUMMARY OF TEST RESULTS	5
2.1	MEASUREMENT UNCERTAINTY	5
3	GENERAL INFORMATION.....	6
3.1	GENERAL DESCRIPTION OF EUT	6
3.2	DESCRIPTION OF TEST MODES.....	8
3.2.1	CONFIGURATION OF SYSTEM UNDER TEST	9
3.2.2	TEST MODE APPLICABILITY AND TESTED CHANNEL DETAIL	10
3.3	GENERAL DESCRIPTION OF APPLIED STANDARDS	14
3.4	DESCRIPTION OF SUPPORT UNITS	14
4	TEST TYPES AND RESULTS	15
4.1	OUTPUT POWER MEASUREMENT	15
4.1.1	LIMITS OF OUTPUT POWER MEASUREMENT	15
4.1.2	TEST INSTRUMENTS.....	16
4.1.3	TEST PROCEDURES	17
4.1.4	TEST SETUP.....	18
4.1.5	EUT OPERATING CONDITIONS	19
4.1.6	TEST RESULTS	20
4.2	FREQUENCY STABILITY MEASUREMENT.....	28
4.2.1	LIMITS OF FREQUENCY STABILITY MEASUREMENT	28
4.2.2	TEST INSTRUMENTS.....	28
4.2.3	TEST PROCEDURE.....	29
4.2.4	TEST SETUP.....	29
4.2.5	TEST RESULTS	30
4.3	OCCUPIED BANDWIDTH MEASUREMENT	32
4.3.1	LIMITS OF OCCUPIED BANDWIDTH MEASUREMENT	32
4.3.2	TEST INSTRUMENTS.....	32
4.3.3	TEST SETUP.....	32
4.3.4	TEST PROCEDURES	33
4.3.5	EUT OPERATING CONDITION	33
4.3.6	TEST RESULTS	34
4.4	BAND EDGE MEASUREMENT.....	40
4.4.1	LIMITS OF BAND EDGE MEASUREMENT	40
4.4.2	TEST INSTRUMENTS.....	40
4.4.3	TEST SETUP.....	40
4.4.4	TEST PROCEDURES	41
4.4.5	EUT OPERATING CONDITION	41
4.4.6	TEST RESULTS	42
4.5	CONDUCTED SPURIOUS EMISSIONS.....	45
4.5.1	LIMITS OF CONDUCTED SPURIOUS EMISSIONS MEASUREMENT	45
4.5.2	TEST INSTRUMENTS.....	45
4.5.3	TEST PROCEDURE.....	46
4.5.4	TEST SETUP.....	46
4.5.5	EUT OPERATING CONDITIONS	46
4.5.6	TEST RESULTS	47
4.6	RADIATED EMISSION MEASUREMENT (BELOW 1GHz).....	57
4.6.1	LIMITS OF RADIATED EMISSION MEASUREMENT	57
4.6.2	TEST INSTRUMENTS.....	57



A D T

4.6.3	TEST PROCEDURES	58
4.6.4	DEVIATION FROM TEST STANDARD	58
4.6.5	TEST SETUP.....	59
4.6.6	EUT OPERATING CONDITIONS	59
4.6.7	TEST RESULTS	60
4.7	RADIATED EMISSION MEASUREMENT (ABOVE 1GHz)	62
4.7.1	LIMITS OF RADIATED EMISSION MEASUREMENT	62
4.7.2	TEST INSTRUMENTS.....	62
4.7.3	TEST PROCEDURES	63
4.7.4	DEVIATION FROM TEST STANDARD	63
4.7.5	TEST SETUP.....	64
4.7.6	EUT OPERATING CONDITIONS	64
4.7.7	TEST RESULTS	65
5	PHOTOGRAPHS OF THE TEST CONFIGURATION.....	71
6	INFORMATION ON THE TESTING LABORATORIES	72
7	APPENDIX A – MODIFICATIONS RECORDERS FOR ENGINEERING CHANGES TO THE EUT BY THE LAB	73



1 CERTIFICATION

PRODUCT: Notebook Computer
MODEL NO.: 0251 (refer to item 3.1 for more details)
BRAND: lenovo
APPLICANT: Wistron Corporation
TESTED: Jul. 15 ~ Jul. 22, 2009
TEST SAMPLE: ENGINEERING SAMPLE
TEST STANDARDS: **FCC Part 24, Subpart E**
ANSI C63.4-2003

The above equipment (model: 0251) has been tested by **Bureau Veritas Consumer Products Services (H.K.) Ltd., Taoyuan Branch**, and found compliance with the requirement of the above standards. The test record, data evaluation & Equipment Under Test (EUT) configurations represented herein are true and accurate accounts of the measurements of the sample's EMC characteristics under the conditions specified in this report.

PREPARED BY : Rennie Wang , **DATE:** Aug. 04, 2009
Rennie Wang / Supervisor

TECHNICAL ACCEPTANCE : Long Chen , **DATE:** Aug. 04, 2009
Responsible for RF Long Chen / Senior Engineer

APPROVED BY : Gary Chang , **DATE:** Aug. 04, 2009
Gary Chang / Assistant Manager

2 SUMMARY OF TEST RESULTS

The EUT has been tested according to the following specifications:

APPLIED STANDARD: FCC Part 24 & Part 2 / IC RSS-133			
STANDARD SECTION	TEST TYPE AND LIMIT	RESULT	REMARK
2.1046 24.232	Maximum Peak Output Power Limit: max. 2 watts e.i.r.p peak power	PASS	Meet the requirement of limit. Minimum passing margin is 29.69dBm at 1850.20MHz.
2.1055 24.235	Frequency Stability AFC Freq. Error vs. Voltage AFC Freq. Error vs. Temperature Limit: max. ± 2.5 ppm	PASS	Meet the requirement of limit.
2.1049 24.238(b)	Occupied Bandwidth	PASS	Meet the requirement of limit.
24.238(b)	Band Edge Measurements	PASS	Meet the requirement of limit.
2.1051 24.238	Conducted Spurious Emissions	PASS	Meet the requirement of limit.
2.1053 24.238	Radiated Spurious Emissions	PASS	Meet the requirement of limit. Minimum passing margin is -9.19dB at 13368.60MHz.

2.1 MEASUREMENT UNCERTAINTY

Where relevant, the following measurement uncertainty levels have been estimated for tests performed on the EUT as specified in CISPR 16-4-2:

MEASUREMENT	FREQUENCY	UNCERTAINTY
Conducted emissions	9kHz~30MHz	2.44 dB
Radiated emissions	30MHz ~ 200MHz	2.93 dB
	200MHz ~1000MHz	2.95 dB
	1GHz ~ 18GHz	2.26 dB
	18GHz ~ 40GHz	1.94 dB

This uncertainty represents an expanded uncertainty expressed at approximately the 95% confidence level using a coverage factor of k=2.

3 GENERAL INFORMATION

3.1 GENERAL DESCRIPTION OF EUT

EUT	Notebook Computer
MODEL NO.	0251 (refer to NOTE for more details)
FCC ID	PU5-BU7LTN
POWER SUPPLY	7.4Vdc from rechargeable lithium battery 12Vdc from power adapter
MODULATION TYPE	GMSK / 8PSK / BPSK
FREQUENCY RANGE	1850MHz ~ 1910MHz
NUMBER OF CHANNEL	299 (for GPRS/E-GPRS) / 277 (for WCDMA)
MAX. EIRP POWER	GPRS Mode: 29.69dBm (0.931Watts) E-GPRS Mode: 26.75dBm (0.473Watts) WCDMA Mode: 21.48dBm (0.141Watts)
ANTENNA TYPE	PIFA
MAX. ANTENNA GAIN	-1dBi
DATA CABLE	NA
I/O PORTS	Refer to user's manual
ACCESSORY DEVICES	Battery, Adapter

NOTE:

- The following models are provided to this EUT.

MODEL	DESCRIPTION
0251	All models are electrically identical, different model names are for marketing purpose.
2872	

- The EUT was powered by the following adapter:

BRAND:	DELTA
MODEL:	EADP-18SB BA
INPUT:	100-240Vac, 50-60Hz, 0.4A
OUTPUT:	12Vdc, 1.5A
POWER LINE:	1.8m non-shielded cable with one core

3. The EUT is a Notebook Computer. The functions of EUT listed as below:

	TEST STANDARD	REFERENCE REPORT
WLAN 802.11b/g	FCC Part 15, Subpart C (Section 15.247)	RF980702L17
BLUETOOTH		RF980702L17-1
GPRS/E-GPRS/WCDMA 850	FCC Part 22	RF980702L17-2
GPRS/E-GPRS/WCDMA 1900	FCC Part 24	RF980702L17-3

4. The communicated functions of EUT listed as below:

		850MHz	1900MHz	With 802.11b/g + Bluetooth
2G	GPRS	√	√	
	E-GPRS	√	√	
3G	WCDMA	√	√	
	Release 6 HSDPA	√	√	
	Release 6 HSUPA	√	√	

5. Hardware version: SIV

6. Software version: Beta1.

7. IMEI Code: 358733*****.

8. The above EUT information was declared by manufacturer and for more detailed features description, please refer to the manufacturer's specifications or User's Manual.

3.2 DESCRIPTION OF TEST MODES

FOR GPRS/E-GPRS:

299 channels are provided to this EUT. Therefore, the low, middle and high channels are chosen for testing.

	CHANNEL	FREQUENCY	TX MODE
LOW	512	1850.2 MHz	GPRS, E-GPRS
MIDDLE	661	1880.0 MHz	GPRS, E-GPRS
HIGH	810	1909.8 MHz	GPRS, E-GPRS

NOTE:

1. Below 1 GHz, the channel 512, 661, and 810 were pre-tested in chamber. The channel 512 was chosen for final test.
2. Above 1 GHz, the channel 512, 661, and 810 were tested individually.
3. The worst case for final test is chosen when the power control level set 0.
4. The channel space is 0.2MHz.
5. The EUT is a GPRS class 12 device (Multislot class: 12, Mobile Terminal B), which provide 4 up-link. After pre-tested both functions, found up-link with 1 time slot is worse, therefore, test results of output power, frequency stability, occupied bandwidth and band edge tests came out from this.
6. The EUT is an E-GPRS class 12 device (Multislot class: 12, Mobile Terminal B), which provide 4 up-link. After pre-tested both functions, found up-link with 1 time slot is worse, therefore, test results of output power, frequency stability, occupied bandwidth and band edge tests came out from this.
7. The EUT has GPRS & E-GPRS functions. After pre-testing, GPRS function is the worst case for all the emission tests.

FOR WCDMA:

277 channels are provided to this EUT. Therefore, the low, middle and high channels are chosen for testing.

	CHANNEL	FREQUENCY	TX MODE
LOW	9262	1852.4 MHz	WCDMA
MIDDLE	9400	1880.0 MHz	WCDMA
HIGH	9538	1907.6 MHz	WCDMA

NOTE:

1. Below 1 GHz, the channel 9262, 9400 and 9538 were pre-tested in chamber. The channel 9262 was chosen for final test.
2. Above 1 GHz, the channel 9262, 9400 and 9538 were tested individually.
3. The channel space is 0.2MHz.
4. WCDMA-RMC mode has been chosen for the worst case to do the final test and record.

3.2.1 CONFIGURATION OF SYSTEM UNDER TEST

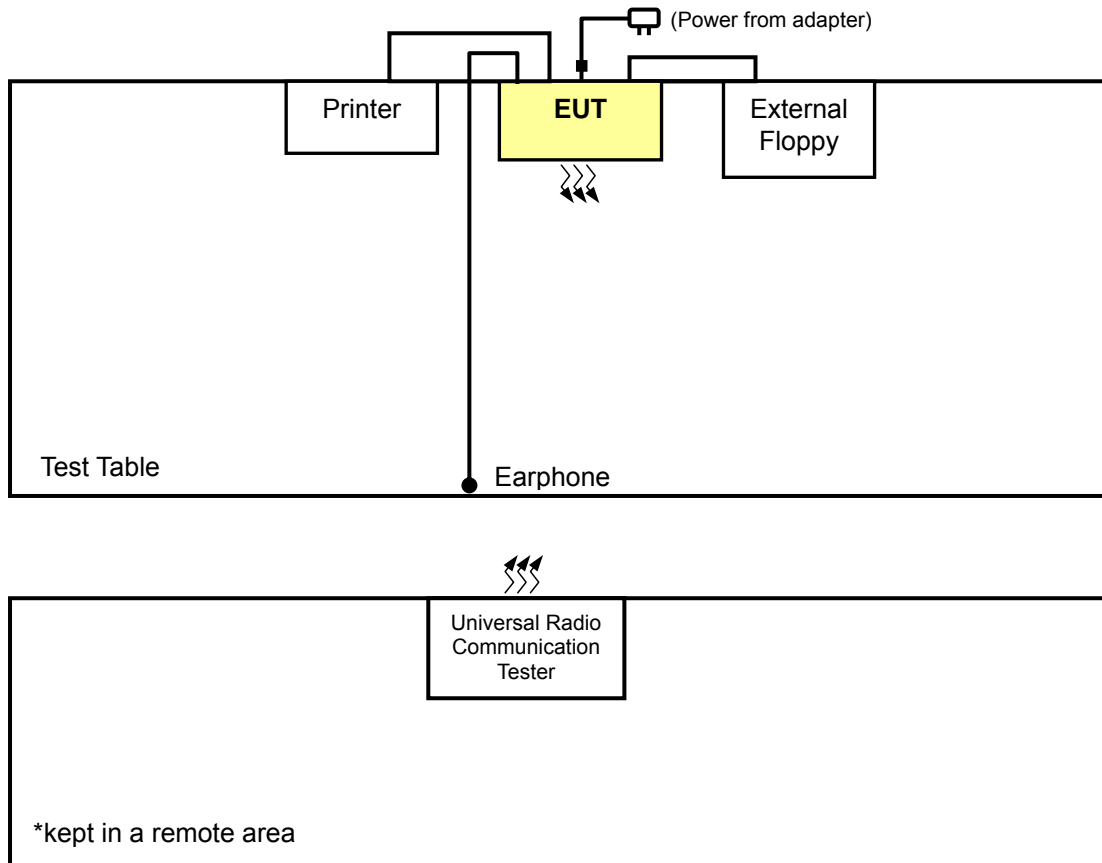

3.2.2 TEST MODE APPLICABILITY AND TESTED CHANNEL DETAIL

FOR GPRS/E-GPRS:

EUT CONFIGURE MODE	APPLICABLE TO							DESCRIPTION
	OP	FS	OB	BE	CE	RE<1G	RE≥1G	
-	√	√	√	√	√	√	√	-

Where

OP: Output power	FS: Frequency stability
OB: Occupied bandwidth	BE: Band edge
CE: Conducted spurious emissions	RE<1G: Radiated emission below 1GHz
RE≥1G: Radiated emission above 1GHz	

OUTPUT POWER MEASUREMENT:

- Pre-Scan has been conducted to determine the worst-case mode from all possible combinations between available modulations and antenna ports (if EUT with antenna diversity architecture).
- Following channel(s) was (were) selected for the final test as listed below.

AVAILABLE CHANNEL	TESTED CHANNEL	MODULATION TECHNOLOGY
512 to 810	512, 661, 810	GPRS, EGPRS

FREQUENCY STABILITY MEASUREMENT:

- Pre-Scan has been conducted to determine the worst-case mode from all possible combinations between available modulations and antenna ports (if EUT with antenna diversity architecture).
- Following channel(s) was (were) selected for the final test as listed below.

AVAILABLE CHANNEL	TESTED CHANNEL	MODULATION TECHNOLOGY
512 to 810	661	GPRS

OCCUPIED BANDWIDTH MEASUREMENT:

- Pre-Scan has been conducted to determine the worst-case mode from all possible combinations between available modulations and antenna ports (if EUT with antenna diversity architecture).
- Following channel(s) was (were) selected for the final test as listed below.

AVAILABLE CHANNEL	TESTED CHANNEL	MODULATION TECHNOLOGY
512 to 810	512, 661, 810	GPRS, EGPRS



BAND EDGE MEASUREMENT:

- Pre-Scan has been conducted to determine the worst-case mode from all possible combinations between available modulations and antenna ports (if EUT with antenna diversity architecture).
- Following channel(s) was (were) selected for the final test as listed below.

AVAILABLE CHANNEL	TESTED CHANNEL	MODULATION TECHNOLOGY
512 to 810	512, 810	GPRS, EGPRS

CONDUCTED SPURIOUS EMISSIONS MEASUREMENT:

- Pre-Scan has been conducted to determine the worst-case mode from all possible combinations between available modulations and antenna ports (if EUT with antenna diversity architecture).
- Following channel(s) was (were) selected for the final test as listed below.

AVAILABLE CHANNEL	TESTED CHANNEL	MODULATION TECHNOLOGY
512 to 810	512, 661, 810	GPRS

RADIATED EMISSION MEASUREMENT (BELOW 1 GHz):

- Pre-Scan has been conducted to determine the worst-case mode from all possible combinations between available modulations and antenna ports (if EUT with antenna diversity architecture).
- Following channel(s) was (were) selected for the final test as listed below.

AVAILABLE CHANNEL	TESTED CHANNEL	MODULATION TECHNOLOGY
512 to 810	512	GPRS

RADIATED EMISSION MEASUREMENT (ABOVE 1 GHz):

- Pre-Scan has been conducted to determine the worst-case mode from all possible combinations between available modulations and antenna ports (if EUT with antenna diversity architecture).
- Following channel(s) was (were) selected for the final test as listed below.

AVAILABLE CHANNEL	TESTED CHANNEL	MODULATION TECHNOLOGY
512 to 810	512, 661, 810	GPRS

FOR WCDMA:

EUT CONFIGURE MODE	APPLICABLE TO							DESCRIPTION
	OP	FS	OB	BE	CE	RE<1G	RE≥1G	
-	√	√	√	√	√	√	√	-

Where

OP: Output power	FS: Frequency stability
OB: Occupied bandwidth	BE: Band edge
CE: Conducted spurious emissions	RE<1G: Radiated emission below 1GHz
RE≥1G: Radiated emission above 1GHz	

OUTPUT POWER MEASUREMENT:

- Pre-Scan has been conducted to determine the worst-case mode from all possible combinations between available modulations and antenna ports (if EUT with antenna diversity architecture).
- Following channel(s) was (were) selected for the final test as listed below.

AVAILABLE CHANNEL	TESTED CHANNEL	MODULATION TECHNOLOGY
9262 to 9538	9262, 9400, 9538	WCDMA

FREQUENCY STABILITY MEASUREMENT:

- Pre-Scan has been conducted to determine the worst-case mode from all possible combinations between available modulations and antenna ports (if EUT with antenna diversity architecture).
- Following channel(s) was (were) selected for the final test as listed below.

AVAILABLE CHANNEL	TESTED CHANNEL	MODULATION TECHNOLOGY
9262 to 9538	9400	WCDMA

OCCUPIED BANDWIDTH MEASUREMENT:

- Pre-Scan has been conducted to determine the worst-case mode from all possible combinations between available modulations and antenna ports (if EUT with antenna diversity architecture).
- Following channel(s) was (were) selected for the final test as listed below.

AVAILABLE CHANNEL	TESTED CHANNEL	MODULATION TECHNOLOGY
9262 to 9538	9262, 9400, 9538	WCDMA



BAND EDGE MEASUREMENT:

- Pre-Scan has been conducted to determine the worst-case mode from all possible combinations between available modulations and antenna ports (if EUT with antenna diversity architecture).
- Following channel(s) was (were) selected for the final test as listed below.

AVAILABLE CHANNEL	TESTED CHANNEL	MODULATION TECHNOLOGY
9262 to 9538	9262, 9538	WCDMA

CONDUCTED SPURIOUS EMISSIONS MEASUREMENT:

- Pre-Scan has been conducted to determine the worst-case mode from all possible combinations between available modulations and antenna ports (if EUT with antenna diversity architecture).
- Following channel(s) was (were) selected for the final test as listed below.

AVAILABLE CHANNEL	TESTED CHANNEL	MODULATION TECHNOLOGY
9262 to 9538	9262, 9400, 9538	WCDMA

RADIATED EMISSION MEASUREMENT (BELOW 1 GHz):

- Pre-Scan has been conducted to determine the worst-case mode from all possible combinations between available modulations and antenna ports (if EUT with antenna diversity architecture).
- Following channel(s) was (were) selected for the final test as listed below.

AVAILABLE CHANNEL	TESTED CHANNEL	MODULATION TECHNOLOGY
9262 to 9538	9262	WCDMA

RADIATED EMISSION MEASUREMENT (ABOVE 1 GHz):

- Pre-Scan has been conducted to determine the worst-case mode from all possible combinations between available modulations and antenna ports (if EUT with antenna diversity architecture).
- Following channel(s) was (were) selected for the final test as listed below.

AVAILABLE CHANNEL	TESTED CHANNEL	MODULATION TECHNOLOGY
9262 to 9538	9262, 9400, 9538	WCDMA

3.3 GENERAL DESCRIPTION OF APPLIED STANDARDS

The EUT is a RF product. According to the specifications of the manufacturer, it must comply with the requirements of the following standards:

FCC 47 CFR Part 2

FCC 47 CFR Part 24

IC RSS-133

ANSI C63.4-2003

ANSI/TIA/EIA-603-C 2004

NOTE: All test items have been performed and recorded as per the above standards.

3.4 DESCRIPTION OF SUPPORT UNITS

The EUT has been tested as an independent unit together with other necessary accessories or support units. The following support units or accessories were used to form a representative test configuration during the tests.

NO.	PRODUCT	BRAND	MODEL NO.	SERIAL NO.	FCC ID
1	PRINTER	HP	HP LASERJET 1300	CNCM065675	FCC DoC Approved
2	EXTERNAL FLOPPY	SONY	MPF82E	50010133	FCC DoC Approved
3	EARPHONE	PHILIPS	HL145	NA	NA
4	UNIVERSAL RADIO COMMUNICATION TESTER	R&S	CMU200	104484	NA
5	NJZ-2000 (GSM+WCDMA SIMULATOR)	JRC	NJZ-2000	ET00054	NA

NO.	SIGNAL CABLE DESCRIPTION OF THE ABOVE SUPPORT UNITS
1	1.8m braid shielded wire, DB25 connector, w/o core.
2	1.8m shielded USB cable.
3	1.2m shielded cable.
4	NA
5	NA

NOTE 1: All power cords of the above support units are non shielded (1.8m).

NOTE 2: Item 4-5 acted as a communication partners to transfer data.

4 TEST TYPES AND RESULTS

4.1 OUTPUT POWER MEASUREMENT

4.1.1 LIMITS OF OUTPUT POWER MEASUREMENT

The radiated peak output power shall be according to the specific rule Part 24.232(b) that “Mobile / Portable station are limited to 2 watts e.i.r.p” and 24.232(c) specific that “Peak transmit power must be measure over any interval of continuous transmission using instrumentation calibration in terms of rms-equivalent voltage.”



4.1.2 TEST INSTRUMENTS

DESCRIPTION & MANUFACTURER	MODEL NO.	SERIAL NO.	DATE OF CALIBRATION	DUE DATE OF CALIBRATION
Test Receiver ROHDE & SCHWARZ	ESIB7	100212	May 25, 2009	May 24, 2010
Spectrum Analyzer ROHDE & SCHWARZ	FSP40	100269	Aug. 08, 2008	Aug. 07, 2009
BILOG Antenna SCHWARZBECK	VULB9168	9168-156	Apr. 30, 2009	Apr. 29, 2010
HORN Antenna SCHWARZBECK	BBHA 9120 D	9120D-563	Aug. 06, 2008	Aug. 05, 2009
HORN Antenna SCHWARZBECK	BBHA 9170	BBHA9170242	Jan. 06, 2009	Jan. 05, 2010
Preamplifier Agilent	8449B	3008A01911	Sep. 10, 2008	Sep. 09, 2009
Preamplifier Agilent	8447D	2944A10638	Dec. 26, 2008	Dec. 25, 2009
RF signal cable HUBER+SUHNNER	SUCOFLEX 104	218190/4 231241/4	May 13, 2009	May 12, 2010
RF signal cable Worken	8D-FB	Cable-HYCH9-01	Aug. 09, 2008	Aug. 08, 2009
Software	ADT_Radiated_ V7.6.15.9.2	NA	NA	NA
Antenna Tower EMCO	2070/2080	512.835.4684	NA	NA
Turn Table EMCO	2087-2.03	NA	NA	NA
Antenna Tower & Turn Table Controller EMCO	2090	NA	NA	NA

- NOTE:**
1. The calibration interval of the above test instruments is 12 months and the calibrations are traceable to NML/ROC and NIST/USA.
 2. The test was performed in HwaYa Chamber 9.
 3. The horn antenna and HP preamplifier (model: 8449B) are used only for the measurement of emission frequency above 1GHz if tested.
 4. The FCC Site Registration No. is 460141.
 5. The IC Site Registration No. is IC 7450F-4.

4.1.3 TEST PROCEDURES

- a. The power was measured with R&S Spectrum Analyzer. All measurements were done at 3 channels, 512, 661 and 810 (GPRS/E-GPRS) / 9262, 9400 and 9538 (WCDMA) (low, middle and high operational frequency range.)
- b. The conducted peak output power used the power splitter via EUT RF power connector between simulation base station and spectrum analyzer. The path loss included the splitter loss, cable loss and 20dB pad loss. The spectrum set RB/VB 1MHz (GPRS/E-GPRS) and 5MHz (WCDMA), then read peak power value and record to the test. (All transmitted path loss shall be considered in the test report data.)
- c. Substitution method is used for E.I.R.P measurement. In the semi-anechoic chamber, EUT placed on the 0.8m height of Turn Table, rotated the table around 360 degrees to search the maximum radiation power and receiver antenna shall be rotated vertical and horizontal polarization and moved height from 1m to 4m to find the maximum polar radiated power. The “Read Value” is the spectrum reading the maximum power value.
- d. The substitution horn antenna is substituted for EUT at the same position and signals generator export the CW signal to the substitution antenna via a tx cable . Rotated the Turn Table and moved receiving antenna to find the maximum radiation power. Adjust output power level of S.G to get a Value of spectrum reading equal to “Read Value “ of step c. Record the power level of S.G
- e. $EIRP = \text{Output power level of S.G} - \text{TX cable loss} + \text{Antenna gain of substitution horn.}$

4.1.4 TEST SETUP

EIRP POWER MEASUREMENT:

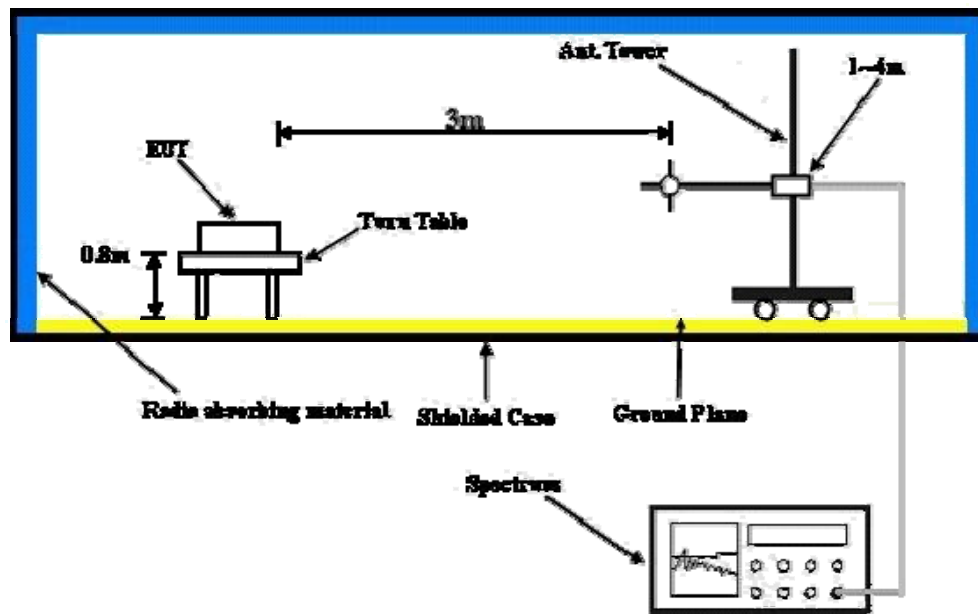

For the actual test configuration, please refer to the attached file (Test Setup Photo).

CONDUCTED POWER MEASUREMENT:

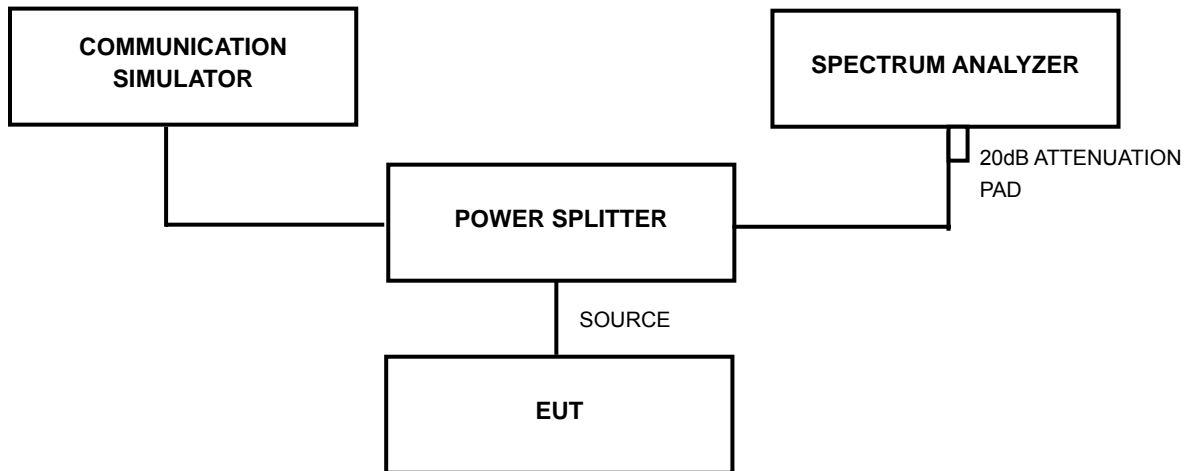

For the actual test configuration, please refer to the related item – Photographs of the Test Configuration.

4.1.5 EUT OPERATING CONDITIONS

- a. The EUT makes a phone call to the communication simulator.
- b. The communication simulator station system controlled an EUT to export maximum output power under transmission mode and specific channel frequency.



4.1.6 TEST RESULTS

FOR GPRS/E-GPRS:

MODE	TX connected	POWER CONTROL LEVEL	0
INPUT POWER (SYSTEM)	120Vac, 60 Hz	DETECTOR FUNCTION	Peak
ENVIRONMENTAL CONDITIONS	23deg. C, 68%RH, 991hPa	TESTED BY	Mark Liao

FOR GPRS MODE (UP-LINK WITH 1 TIME SLOT)

CONDUCTED OUTPUT POWER					
CHANNEL NO.	FREQUENCY (MHz)	RAW VALUE (dBm)	CORRECTION FACTOR (dB)	OUTPUT POWER	
				dBm	Watt
512	1850.2	25.60	4.30	29.90	0.977
661	1880.0	25.80	4.30	30.10	1.023
810	1909.8	25.90	4.30	30.20	1.047

FOR E-GPRS MODE (UP-LINK WITH 1 TIME SLOT)

CONDUCTED OUTPUT POWER					
CHANNEL NO.	FREQUENCY (MHz)	RAW VALUE (dBm)	CORRECTION FACTOR (dB)	OUTPUT POWER	
				dBm	Watt
512	1850.2	22.80	4.30	27.10	0.513
661	1880.0	22.90	4.30	27.20	0.525
810	1909.8	23.10	4.30	27.40	0.550

- REMARKS:** 1. Peak Output Power (dBm) = Raw Value (dBm) + Correction Factor (dB).
 2. Correction Factor (dB) = Power Splitter Loss (dB) + Cable Loss (dB).



A D T

MODE	TX connected	POWER CONTROL LEVEL	0
INPUT POWER (SYSTEM)	120Vac, 60 Hz	DETECTOR FUNCTION	Peak
ENVIRONMENTAL CONDITIONS	23deg. C, 68%RH, 991hPa	TESTED BY	Mark Liao

FOR GPRS MODE (UP-LINK WITH 1 TIME SLOT)

EIRP POWER					
CHANNEL NO.	FREQUENCY (MHz)	S.G VALUE (dBm)	CORRECTION FACTOR (dB)	OUTPUT POWER	
				dBm	Watt
512	1850.2	21.29	8.40	29.69	0.931
661	1880.0	20.10	8.56	28.66	0.735
810	1909.8	19.05	8.50	27.55	0.569

FOR E-GPRS MODE (UP-LINK WITH 1 TIME SLOT)

EIRP POWER					
CHANNEL NO.	FREQUENCY (MHz)	S.G VALUE (dBm)	CORRECTION FACTOR (dB)	OUTPUT POWER	
				dBm	Watt
512	1850.2	18.35	8.40	26.75	0.473
661	1880.0	17.78	8.56	26.34	0.431
810	1909.8	16.91	8.50	25.41	0.348

REMARKS: 1. Peak Output Power (dBm) = Raw Value (dBm) + Correction Factor (dB).

2. Correction Factor (dB) = Receiver Antenna Gain (dBi) + Cable Loss (dB) + Free Space Loss (dB).

The following procedures were followed according to FCC “SAR Measurement Procedures for 3G Devices”, October, 2007.

Output Power Verification

WCDMA

Maximum output power is verified on the High, Middle and Low channels according to the procedures described in section 5.2 of 3GPP TS 34.121, using the appropriate RMC or AMR with TPC (transmit power control) set to all “1” s” for WCDMA/HSDPA or applying the required inner loop power control procedures to maintain maximum output power while HSUPA is active. Results for all applicable physical channel configurations (DPCCH, DPDCHn and spreading codes, HSDPA, HSPA) should be tabulated in the SAR report. All configurations that are not supported by the DUT or cannot be measured due to technical or equipment limitations should be clearly identified.

Release 5 HSDPA Data Devices

Maximum output power is verified on the High, Middle and Low channels according to the Release 5 procedures described in section 5.2 of 3GPP TS 34.121, using an FRC with H-set 1 and a 12.2 kbps RMC with TPC (transmit power control) set to all “1” s” . When HSDPA is active output power is measured according requirements for HS-DPCCH Sub-test 1 - 4. Results for all applicable physical channel configurations (DPCCH, DPDCHn and spreading codes, HS-DPCCH etc.), with and without HSDPA active, should be tabulated in the SAR report. All configurations that are not supported by the DUT or cannot be measured due to technical or equipment limitations should be clearly identified in the SAR report.

Release 6 HSPA Data Devices

Maximum output power is verified on the High, Middle and Low channels according to Release 6 procedures in section 5.2 of 3GPP TS 34.121, using the appropriate RMC, FRC and E-DCH configurations. When E-DCH is not active, TPC (transmit power control) is set to all “1” s” ; otherwise, inner loop power control with power control algorithm 2 is required to maintain E-TFCI requirements. When HSPA is active output power for the applicable HSPA modes should be measured for E-DCH Sub-test 1 - 5. Results for all applicable physical channel configurations (DPCCH, DPDCH and spreading codes, HS-DPCCH, E-DPCCH, E-DPDCHk) should be tabulated in the SAR report. All configurations that are not supported by the DUT or cannot be measured due to technical or equipment limitations should be clearly identified.



A D T

MODE	TX connected	POWER CONTROL LEVEL	0
INPUT POWER (SYSTEM)	120Vac, 60 Hz	DETECTOR FUNCTION	Average
ENVIRONMENTAL CONDITIONS	23deg. C, 68%RH, 991hPa	TESTED BY	Mark Liao

CONDUCTED OUTPUT POWER (WCDMA-RMC)					
CHANNEL NO.	FREQUENCY (MHz)	RAW VALUE (dBm)	CORRECTION FACTOR (dB)	OUTPUT POWER	
				dBm	Watt
9262	1852.40	18.25	4.30	22.55	0.180
9400	1880.00	19.00	4.30	23.30	0.214
9538	1907.60	18.05	4.30	22.35	0.172

CONDUCTED OUTPUT POWER (HSDPA-R6 SUBTEST 1 MODE)					
CHANNEL NO.	FREQUENCY (MHz)	RAW VALUE (dBm)	CORRECTION FACTOR (dB)	OUTPUT POWER	
				dBm	Watt
9262	1852.40	18.30	4.30	22.60	0.182
9400	1880.00	18.91	4.30	23.21	0.209
9538	1907.60	18.05	4.30	22.35	0.172

CONDUCTED OUTPUT POWER (HSDPA-R6 SUBTEST 2 MODE)					
CHANNEL NO.	FREQUENCY (MHz)	RAW VALUE (dBm)	CORRECTION FACTOR (dB)	OUTPUT POWER	
				dBm	Watt
9262	1852.40	18.15	4.30	22.45	0.176
9400	1880.00	18.93	4.30	23.23	0.210
9538	1907.60	18.00	4.30	22.30	0.170

REMARKS: 1. Peak Output Power (dBm) = Raw Value (dBm) + Correction Factor (dB).
 2. Correction Factor (dB) = Power Splitter Loss (dB) + Cable Loss (dB).



MODE	TX connected	POWER CONTROL LEVEL	0
INPUT POWER (SYSTEM)	120Vac, 60 Hz	DETECTOR FUNCTION	Average
ENVIRONMENTAL CONDITIONS	23deg. C, 68%RH, 991hPa	TESTED BY	Mark Liao

CONDUCTED OUTPUT POWER (HSDPA-R6 SUBTEST 3 MODE)					
CHANNEL NO.	FREQUENCY (MHz)	RAW VALUE (dBm)	CORRECTION FACTOR (dB)	OUTPUT POWER	
				dBm	Watt
9262	1852.40	17.82	4.30	22.12	0.163
9400	1880.00	18.55	4.30	22.85	0.193
9538	1907.60	17.65	4.30	21.95	0.157

CONDUCTED OUTPUT POWER (HSDPA-R6 SUBTEST 4 MODE)					
CHANNEL NO.	FREQUENCY (MHz)	RAW VALUE (dBm)	CORRECTION FACTOR (dB)	OUTPUT POWER	
				dBm	Watt
9262	1852.40	18.04	4.30	22.34	0.171
9400	1880.00	18.60	4.30	22.90	0.195
9538	1907.60	17.65	4.30	21.95	0.157

CONDUCTED OUTPUT POWER (HSUPA-R6 SUBTEST 1 MODE)					
CHANNEL NO.	FREQUENCY (MHz)	RAW VALUE (dBm)	CORRECTION FACTOR (dB)	OUTPUT POWER	
				dBm	Watt
9262	1852.40	18.16	4.30	22.46	0.176
9400	1880.00	19.00	4.30	23.30	0.214
9538	1907.60	18.05	4.30	22.35	0.172

REMARKS: 1. Peak Output Power (dBm) = Raw Value (dBm) + Correction Factor (dB).
 2. Correction Factor (dB) = Power Splitter Loss (dB) + Cable Loss (dB).



MODE	TX connected	POWER CONTROL LEVEL	0
INPUT POWER (SYSTEM)	120Vac, 60 Hz	DETECTOR FUNCTION	Average
ENVIRONMENTAL CONDITIONS	23deg. C, 68%RH, 991hPa	TESTED BY	Mark Liao

CONDUCTED OUTPUT POWER (HSUPA-R6 SUBTEST 2 MODE)					
CHANNEL NO.	FREQUENCY (MHz)	RAW VALUE (dBm)	CORRECTION FACTOR (dB)	OUTPUT POWER	
				dBm	Watt
9262	1852.40	16.80	4.30	21.10	0.129
9400	1880.00	17.27	4.30	21.57	0.144
9538	1907.60	16.50	4.30	20.80	0.120

CONDUCTED OUTPUT POWER (HSUPA-R6 SUBTEST 3 MODE)					
CHANNEL NO.	FREQUENCY (MHz)	RAW VALUE (dBm)	CORRECTION FACTOR (dB)	OUTPUT POWER	
				dBm	Watt
9262	1852.40	17.50	4.30	21.80	0.151
9400	1880.00	18.15	4.30	22.45	0.176
9538	1907.60	17.38	4.30	21.68	0.147

CONDUCTED OUTPUT POWER (HSUPA-R6 SUBTEST 4 MODE)					
CHANNEL NO.	FREQUENCY (MHz)	RAW VALUE (dBm)	CORRECTION FACTOR (dB)	OUTPUT POWER	
				dBm	Watt
9262	1852.40	16.98	4.30	21.28	0.134
9400	1880.00	17.53	4.30	21.83	0.152
9538	1907.60	16.80	4.30	21.10	0.129

REMARKS: 1. Peak Output Power (dBm) = Raw Value (dBm) + Correction Factor (dB).
2. Correction Factor (dB) = Power Splitter Loss (dB) + Cable Loss (dB).



A D T

MODE	TX connected	POWER CONTROL LEVEL	0
INPUT POWER (SYSTEM)	120Vac, 60 Hz	DETECTOR FUNCTION	Average
ENVIRONMENTAL CONDITIONS	23deg. C, 68%RH, 991hPa	TESTED BY	Mark Liao

CONDUCTED OUTPUT POWER (HSUPA-R6 SUBTEST 5 MODE)					
CHANNEL NO.	FREQUENCY (MHz)	RAW VALUE (dBm)	CORRECTION FACTOR (dB)	OUTPUT POWER	
				dBm	Watt
9262	1852.40	18.20	4.30	22.50	0.178
9400	1880.00	18.39	4.30	22.69	0.186
9538	1907.60	18.04	4.30	22.34	0.171

REMARKS: 1. Peak Output Power (dBm) = Raw Value (dBm) + Correction Factor (dB).
2. Correction Factor (dB) = Power Splitter Loss (dB) + Cable Loss (dB).



MODE	TX connected	POWER CONTROL LEVEL	0
INPUT POWER	120Vac, 60 Hz	DETECTOR FUNCTION	Average
ENVIRONMENTAL CONDITIONS	23deg. C, 68%RH, 991hPa	TESTED BY	Mark Liao

EIRP POWER (WCDMA-RMC)					
CHANNEL NO.	FREQUENCY (MHz)	S.G VALUE (dBm)	CORRECTION FACTOR (dB)	OUTPUT POWER	
				dBm	Watt
9262	1852.40	13.08	8.40	21.48	0.141
9400	1880.00	12.76	8.56	21.32	0.136
9538	1907.60	11.59	8.50	20.09	0.102

REMARKS: 1. Peak Output Power (dBm) = Raw Value (dBm) + Correction Factor (dB).
2. Correction Factor (dB) = Receiver Antenna Gain (dBi) + Cable Loss (dB) + Free Space Loss (dB).

4.2 FREQUENCY STABILITY MEASUREMENT

4.2.1 LIMITS OF FREQUENCY STABILITY MEASUREMENT

According to the FCC part 24.235 shall be tested the frequency stability. The rule is defined that "The frequency stability shall be sufficient to ensure that the fundamental emission stays within the authorized frequency block." The frequency error rate is according to the JTC standard that the frequency error rate shall be accurate to within 2.5ppm of the received frequency from the base station. The test extreme voltage is according to the 2.1055(d)(1) Vary primary supply voltage from 85 to 115 percent of the nominal value for other than hand carried battery equipment and the extreme temperature rule is comply with the 2.1055(a)(1) $-30^{\circ}\text{C} \sim 50^{\circ}\text{C}$.

4.2.2 TEST INSTRUMENTS

DESCRIPTION & MANUFACTURER	MODEL NO.	SERIAL NO.	CALIBRATED UNTIL	CALIBRATED UNTIL
ROHDE & SCHWARZ Spectrum Analyzer	FSP40	100041	May 13, 2009	May 12, 2010
Hewlett Packard RF cable	8120-6192	01428251	NA	NA
Suhner RF cable	Sucoflex104	204850/4	NA	NA
WIT Standard Temperature & Humidity Chamber	TH-4S-C	W981030	Jun. 29, 2009	Jun. 28, 2010

NOTE: The calibration interval of the above test instruments is 12 months. And the calibrations are traceable to NML/ROC and NIST/USA.

4.2.3 TEST PROCEDURE

- a. Because of the measure the carrier frequency under the condition of the AFC lock, it shall be used the mobile station in the GPRS / WCDMA link mode. This is accomplished with the use of the R&S CMU200 / JRC NJZ-2000 simulator station. The oven room could control the temperatures and humidity. The GPRS link channel is the 661 and the WCDMA link channel is the 9538.
- b. Power must be removed when changing from one temperature to another or one voltage to another voltage. Power warm up is at least 15 min and power applied should perform before recording frequency error.
- c. EUT is connected the external power supply to control the AC input power. The various Volts from the minimum 93.5Volts to 126.5Volts. Each step shall be record the frequency error rate.
- d. The temperature range step is 10 degrees in this test items. All temperature levels shall be hold the $\pm 0.5^{\circ}\text{C}$ during the measurement testing.
- e. The each temperature step shall be at least 0.5 hours, consider the EUT could be test under the stability condition.

NOTE: The frequency error was recorded frequency error from the GSM simulator.

4.2.4 TEST SETUP

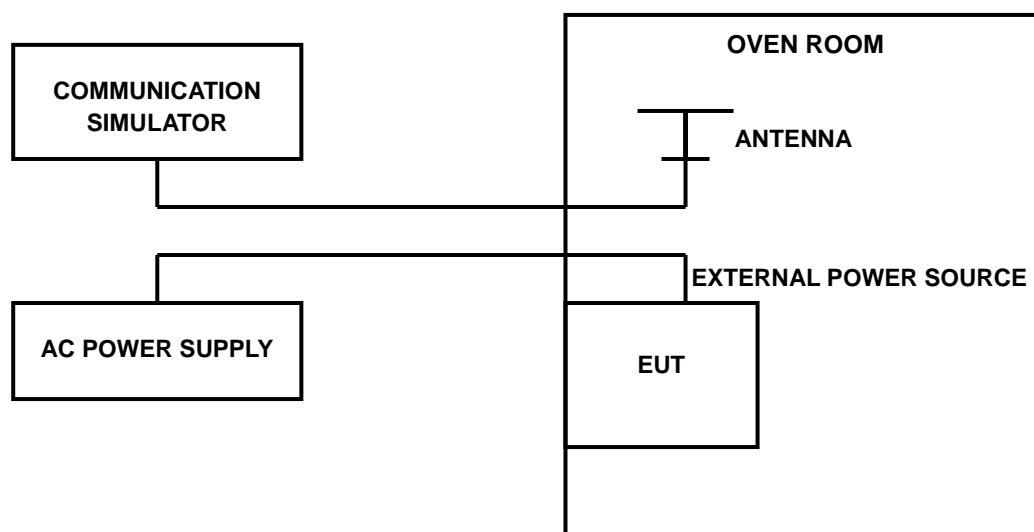



4.2.5 TEST RESULTS

FOR GPRS:

MODE	TX Middle channel	POWER CONTROL LEVEL	0
INPUT POWER (SYSTEM)	120Vac, 60 Hz	ENVIRONMENTAL CONDITIONS	23deg. C, 68%RH, 991hPa
TESTED BY	Mark Liao		

AFC FREQUENCY ERROR vs. VOLTAGE			
VOLTAGE (Volts)	FREQUENCY ERROR (Hz)	FREQUENCY ERROR (ppm)	LIMIT (ppm)
126.5	-3	-0.002	2.5
93.5	5	0.003	2.5

AFC FREQUENCY ERROR vs. TEMP.			
TEMP. (°C)	FREQUENCY ERROR (Hz)	FREQUENCY ERROR (ppm)	LIMIT (ppm)
50	-20	-0.011	2.5
40	-15	-0.008	2.5
30	-11	-0.006	2.5
20	-2	-0.001	2.5
10	2	0.001	2.5
0	6	0.003	2.5
-10	-4	-0.002	2.5
-20	-17	-0.009	2.5
-30	-38	-0.020	2.5



FOR WCDMA:

MODE	TX Middle channel	POWER CONTROL LEVEL	0
INPUT POWER (SYSTEM)	120Vac, 60 Hz	ENVIRONMENTAL CONDITIONS	23deg. C, 68%RH, 991hPa
TESTED BY	Mark Liao		

AFC FREQUENCY ERROR vs. VOLTAGE			
VOLTAGE (Volts)	FREQUENCY ERROR (Hz)	FREQUENCY ERROR (ppm)	LIMIT (ppm)
126.5	-4	-0.002	2.5
93.5	7	0.004	2.5

AFC FREQUENCY ERROR vs. TEMP.			
TEMP. (°C)	FREQUENCY ERROR (Hz)	FREQUENCY ERROR (ppm)	LIMIT (ppm)
50	-23	-0.012	2.5
40	-18	-0.010	2.5
30	-9	-0.005	2.5
20	-2	-0.001	2.5
10	5	0.003	2.5
0	3	0.002	2.5
-10	-13	-0.007	2.5
-20	-22	-0.012	2.5
-30	-31	-0.016	2.5

4.3 OCCUPIED BANDWIDTH MEASUREMENT

4.3.1 LIMITS OF OCCUPIED BANDWIDTH MEASUREMENT

According to FCC 24.238(b) specified that emission bandwidth is defined as the width of the signal between two points, one below the carrier center frequency and one above the carrier center frequency, outside of which all emissions are attenuated at least 26 dB below the transmitter power.

4.3.2 TEST INSTRUMENTS

DESCRIPTION & MANUFACTURER	MODEL NO.	SERIAL NO.	DATE OF CALIBRATION	DUE DATE OF CALIBRATION
ROHDE & SCHWARZ Spectrum Analyzer	FSP40	100041	May 13, 2009	May 12, 2010
Mini-Circuits Power Splitter	ZN2PD-9G	NA	Jun. 26, 2009	Jun. 25, 2010
RF cable	SUCOFLEX 104	274403/4	Aug. 22, 2008	Aug. 21, 2009
RF cable	SUCOFLEX 104	250729/4	Aug. 21, 2008	Aug. 20, 2009
RF cable	SUCOFLEX 104	214377/4	Aug. 21, 2008	Aug. 20, 2009
JFW 20dB attenuation	50HF-020-SMA	NA	NA	NA

NOTE: The calibration interval of the above test instruments is 12 months. And the calibrations are traceable to NML/ROC and NIST/USA.

4.3.3 TEST SETUP

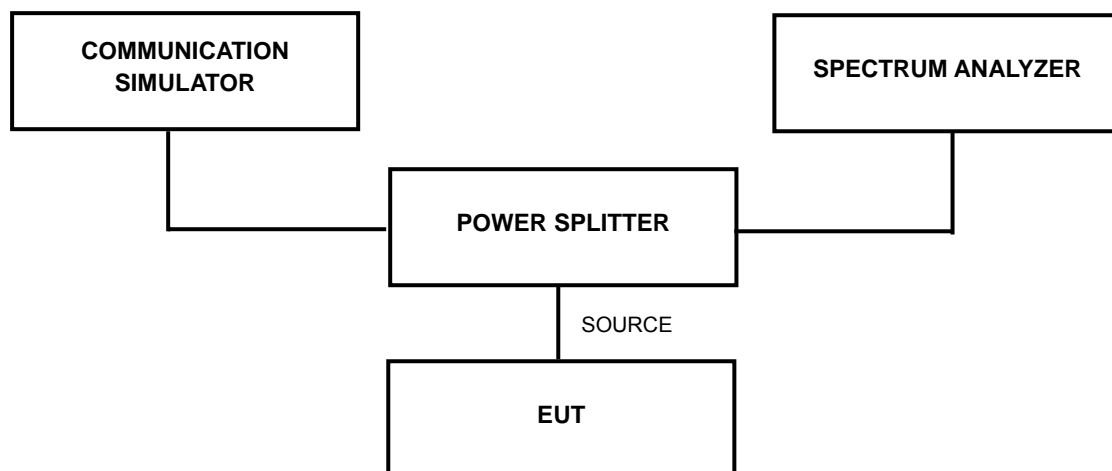

4.3.4 TEST PROCEDURES

- a. The EUT makes a phone call to the communication simulator. The power was measured with R&S Spectrum Analyzer. All measurements were done at 3 channels, 512, 661 and 810 (GPRS/E-GPRS) / 9262, 9400 and 9538 (WCDMA) (low, middle and high operational frequency range.)
- b. The conducted occupied bandwidth used the power splitter via EUT RF power connector between simulation base station and spectrum analyzer. This splitter loss and cable loss are the worst loss 4.3dB in the transmitted path track.
- c. FCC 24.238(b) required a measurement bandwidth is the fundamental emission below 26dB bandwidth.

4.3.5 EUT OPERATING CONDITION

- a. The EUT makes a phone call to the communication simulator.
- b. The communication simulator station system controlled a EUT to export maximum and minimum output power under transmission mode and specific channel frequency.



A D T

4.3.6 TEST RESULTS

FOR GPRS/E-GPRS:

FOR GPRS MODE (UP-LINK WITH 1 TIME SLOT)

CHANNEL	FREQUENCY (MHz)	MAX. OUTPUT POWER -26 dBc BANDWIDTH (MHz)
512	1850.2	0.314
661	1880.0	0.314
810	1909.8	0.316

CH 512

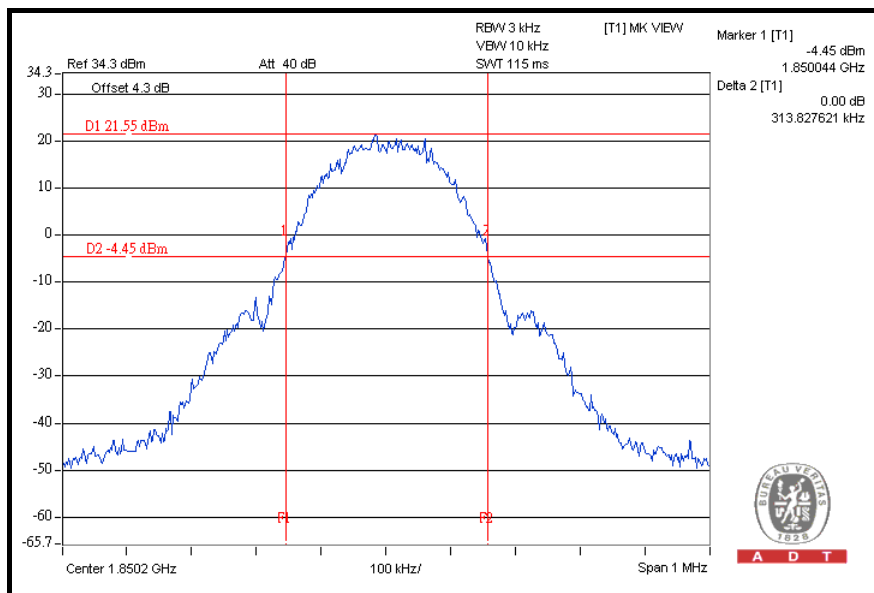



A D T

CH 661

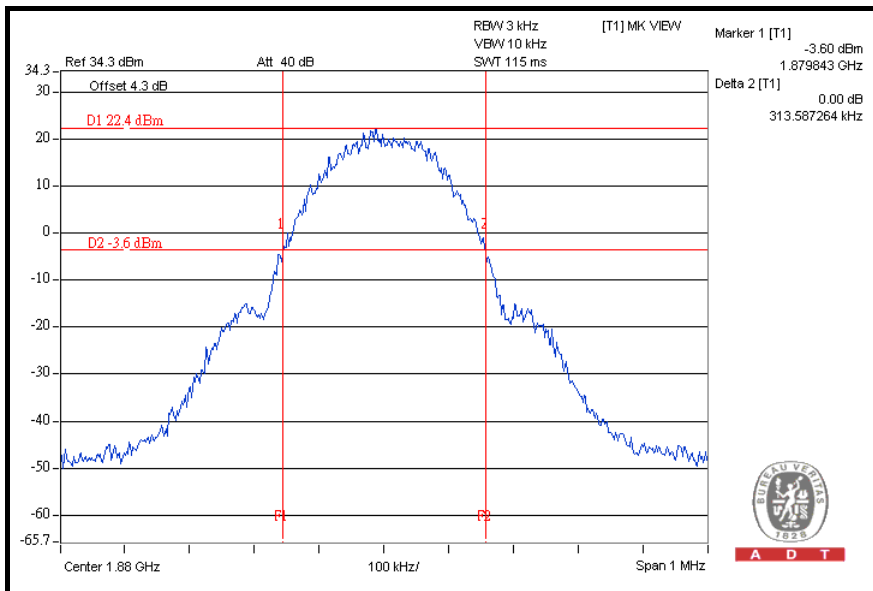

CH 810

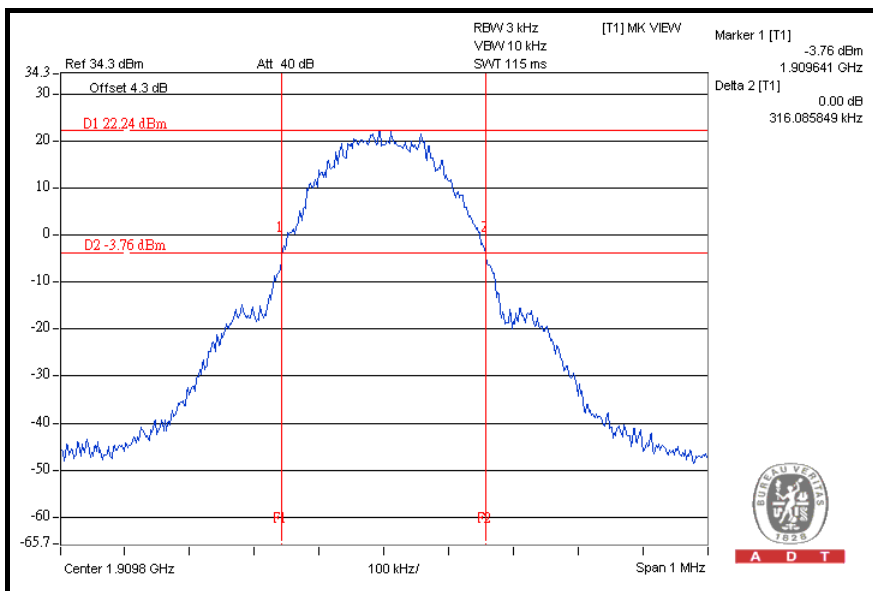

FOR E-GPRS MODE (UP-LINK WITH 1 TIME SLOT)

CHANNEL	FREQUENCY (MHz)	MAX. OUTPUT POWER -26 dBc BANDWIDTH (MHz)
512	1850.2	0.303
661	1880.0	0.310
810	1909.8	0.312

CH 512

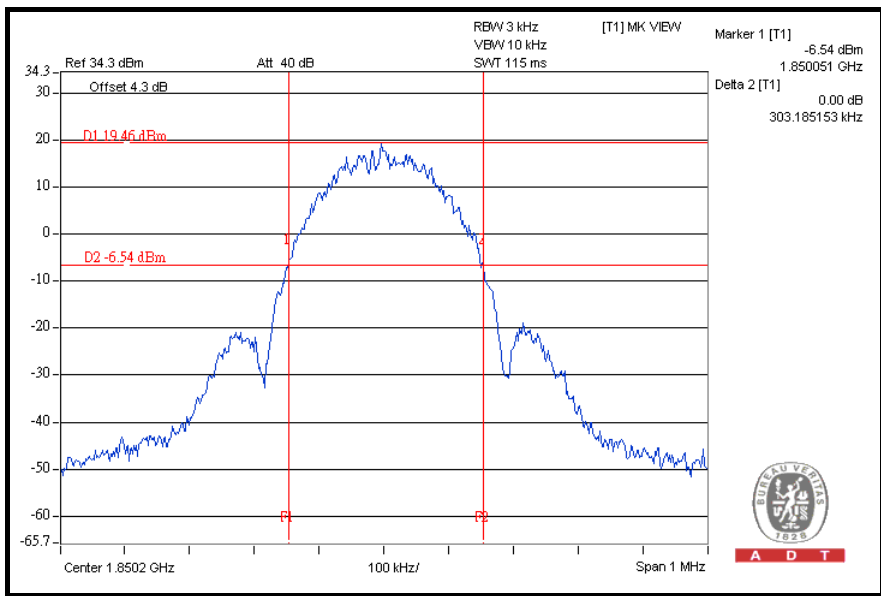



A D T

CH 661

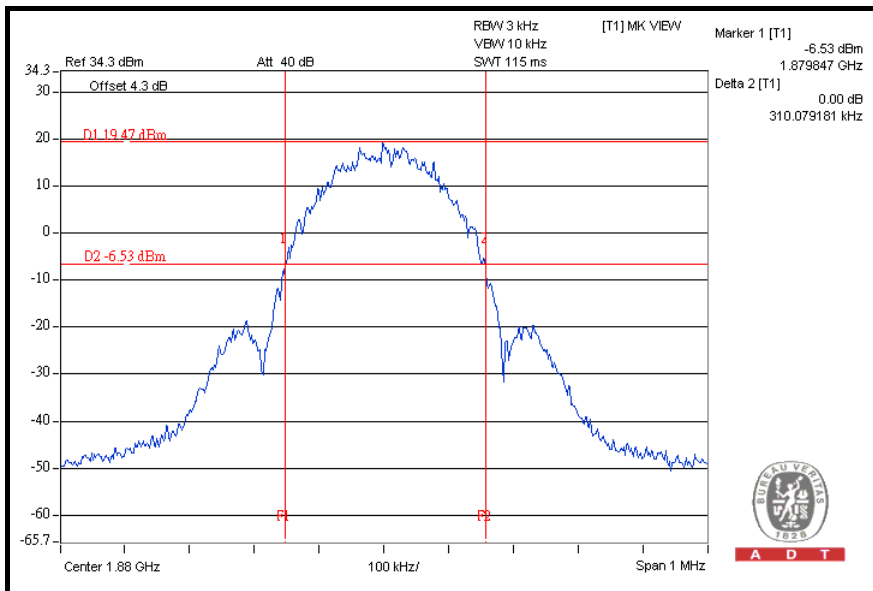

CH 810

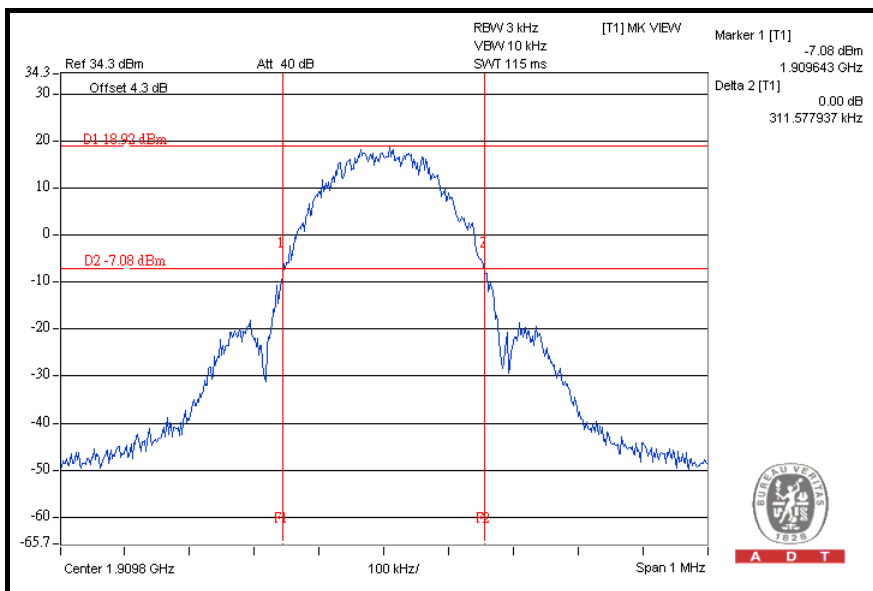

FOR WCDMA:

CHANNEL	FREQUENCY (MHz)	MAX. OUTPUT POWER -26 dBc BANDWIDTH (MHz)
9262	1852.4	4.684
9400	1880.0	4.697
9538	1907.6	4.689

CH 9262

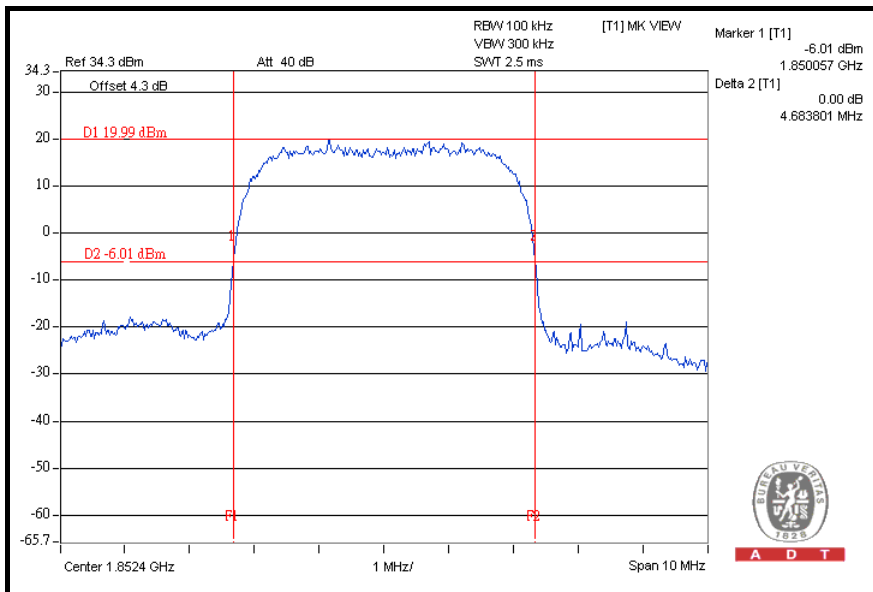



A D T

CH 9400

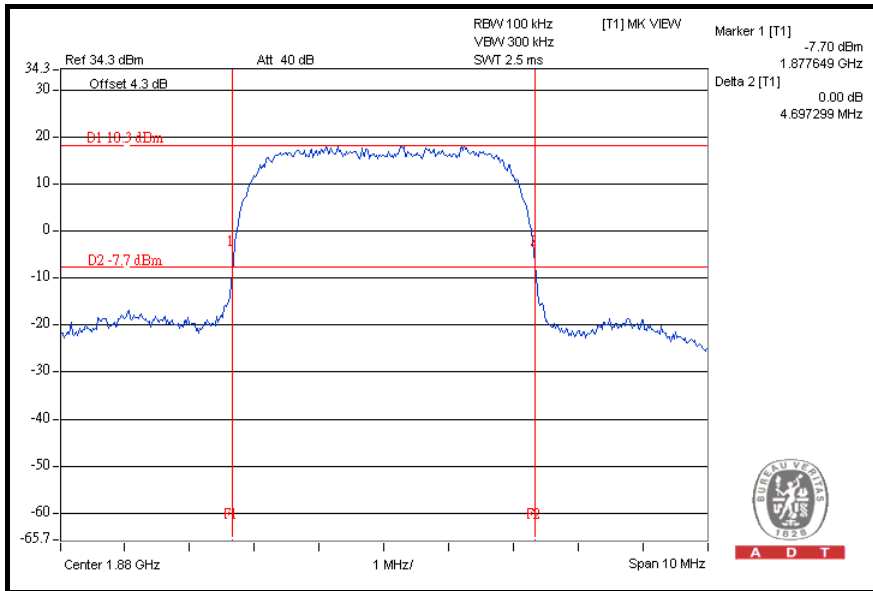

CH 9538

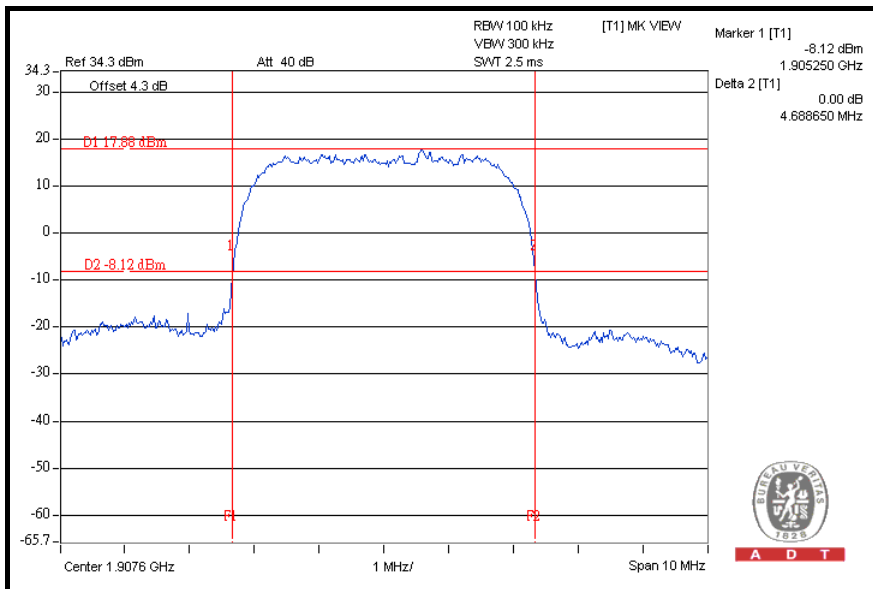

4.4 BAND EDGE MEASUREMENT

4.4.1 LIMITS OF BAND EDGE MEASUREMENT

According to FCC 24.238(a) specified that power of any emission outside of the authorized operating frequency ranges must be attenuated below the transmitting power (P) by a factor of at least $43 + 10 \log(P)$ dB. In the 1 MHz bands immediately outside and adjacent to the frequency block a resolution bandwidth of at least one percent of the emission bandwidth of the fundamental emission of the transmitter may be employed.

4.4.2 TEST INSTRUMENTS

DESCRIPTION & MANUFACTURER	MODEL NO.	SERIAL NO.	DATE OF CALIBRATION	DUE DATE OF CALIBRATION
ROHDE & SCHWARZ Spectrum Analyzer	E4446A	MY44360128	Dec. 06, 2008	Dec. 07, 2009
Mini-Circuits Power Splitter	ZN2PD-9G	NA	Jun. 26, 2009	Jun. 25, 2010
RF cable	SUCOFLEX 104	274403/4	Aug. 22, 2008	Aug. 21, 2009
RF cable	SUCOFLEX 104	250729/4	Aug. 21, 2008	Aug. 20, 2009
RF cable	SUCOFLEX 104	214377/4	Aug. 21, 2008	Aug. 20, 2009
JFW 20dB attenuation	50HF-020-SMA	NA	NA	NA

NOTE: The calibration interval of the above test instruments is 12 months. And the calibrations are traceable to NML/ROC and NIST/USA.

4.4.3 TEST SETUP

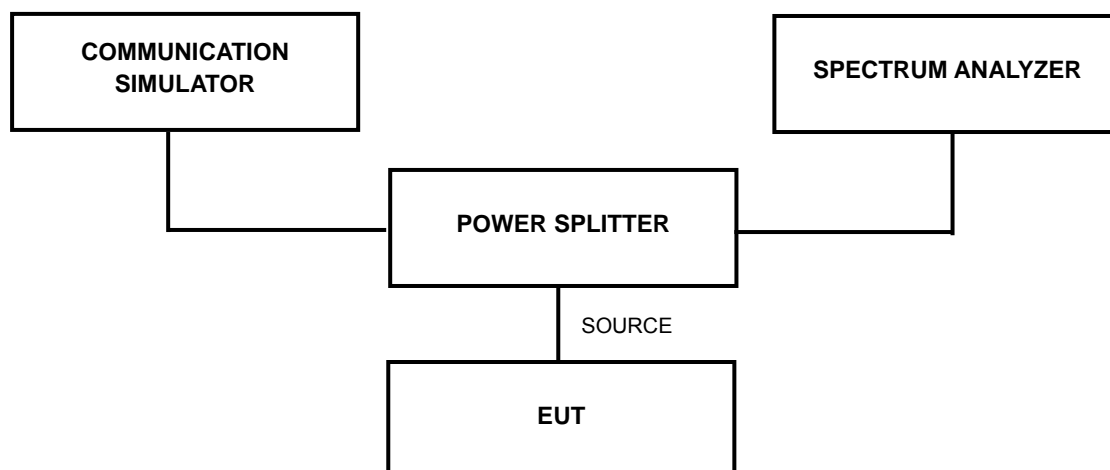

4.4.4 TEST PROCEDURES

- a. The EUT makes a phone call to the communication simulator. The power was measured with R&S Spectrum Analyzer. All measurements were done at 2 channels, 512 and 810 (GPRS/E-GPRS) / 9262 and 9538 (WCDMA) (low and high operational frequency range.)
- b. The band edge measurement used the power splitter via EUT RF power connector between simulation base station and spectrum analyzer. This splitter loss and cable loss are the worst loss 4.3dB in the transmitted path track.
- c. The center frequency of spectrum is the band edge frequency and span is 1.5 MHz. RB of the spectrum is 3kHz and VB of the spectrum is 10kHz (GPRS/E-GPRS).
- d. The center frequency of spectrum is the band edge frequency and span is 10 MHz. RB of the spectrum is 100kHz and VB of the spectrum is 300kHz (WCDMA).
- e. Record the max trace plot into the test report.

4.4.5 EUT OPERATING CONDITION

- a. The EUT makes a phone call to the communication simulator.
- b. The communication simulator station system controlled an EUT to export maximum output power under transmission mode and specific channel frequency.

4.4.6 TEST RESULTS

FOR GPRS/E-GPRS:

FOR GPRS MODE (UP-LINK WITH 1 TIME SLOT)

LOWER BAND EDGE

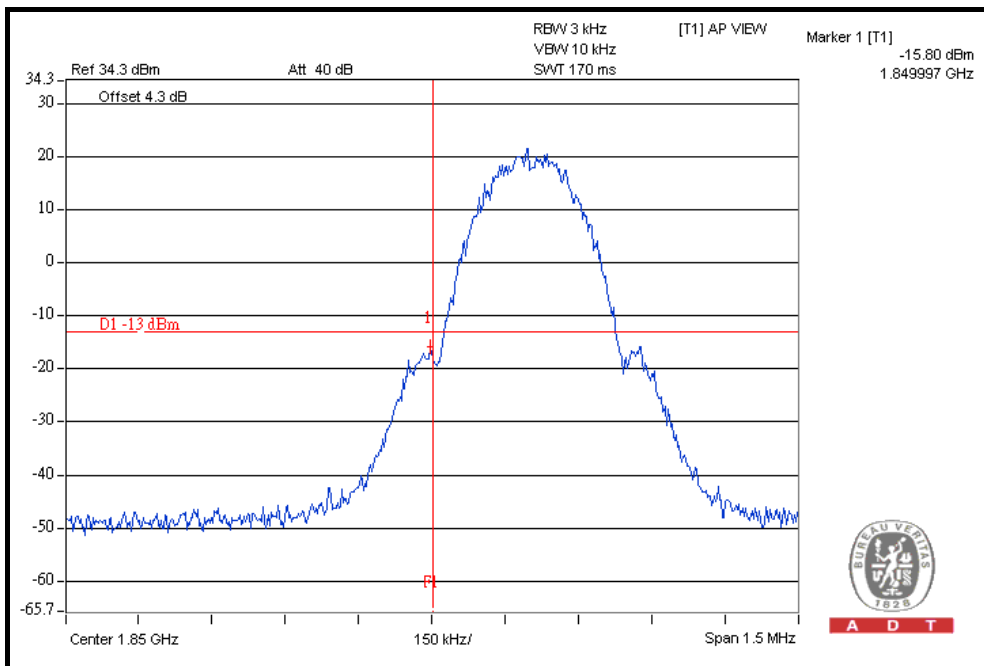
**A D T**

HIGHER BAND EDGE

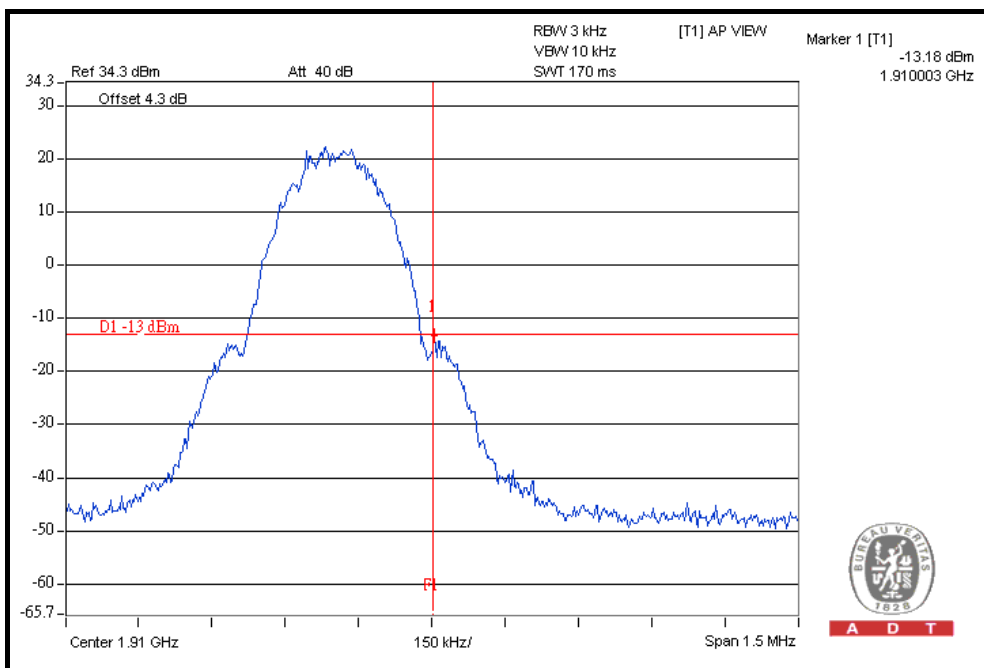
**A D T**



A D T

FOR E-GPRS MODE (UP-LINK WITH 1 TIME SLOT)

LOWER BAND EDGE

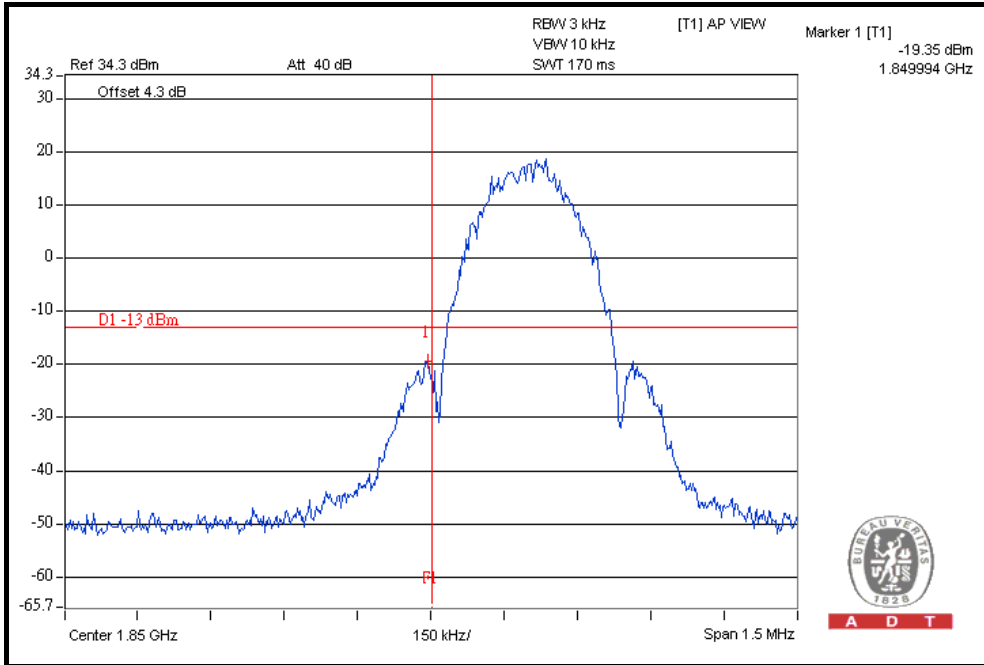

HIGHER BAND EDGE

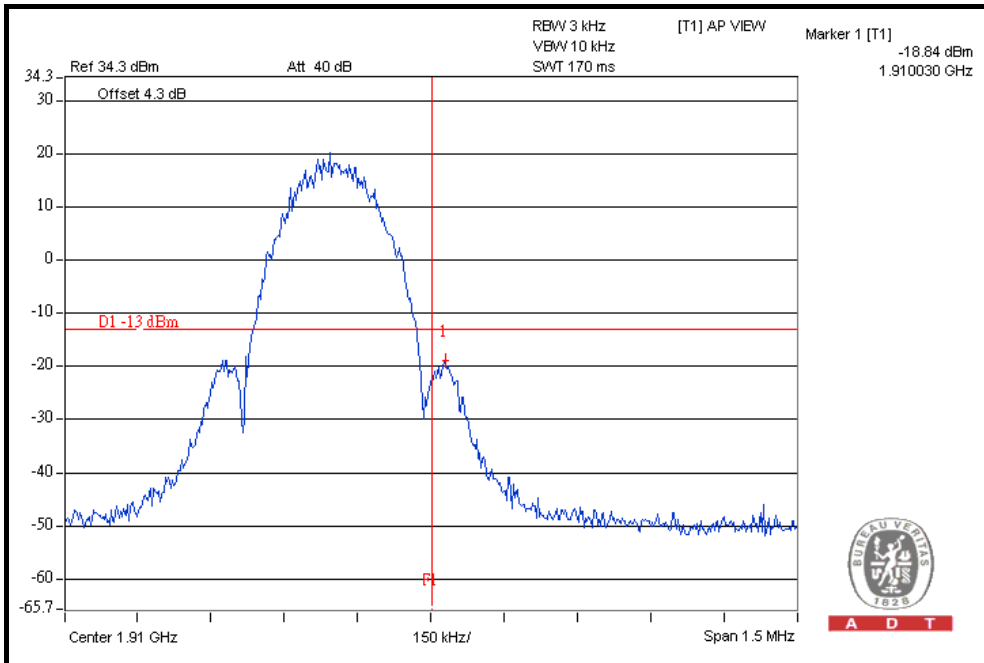



A D T

FOR WCDMA:

LOWER BAND EDGE

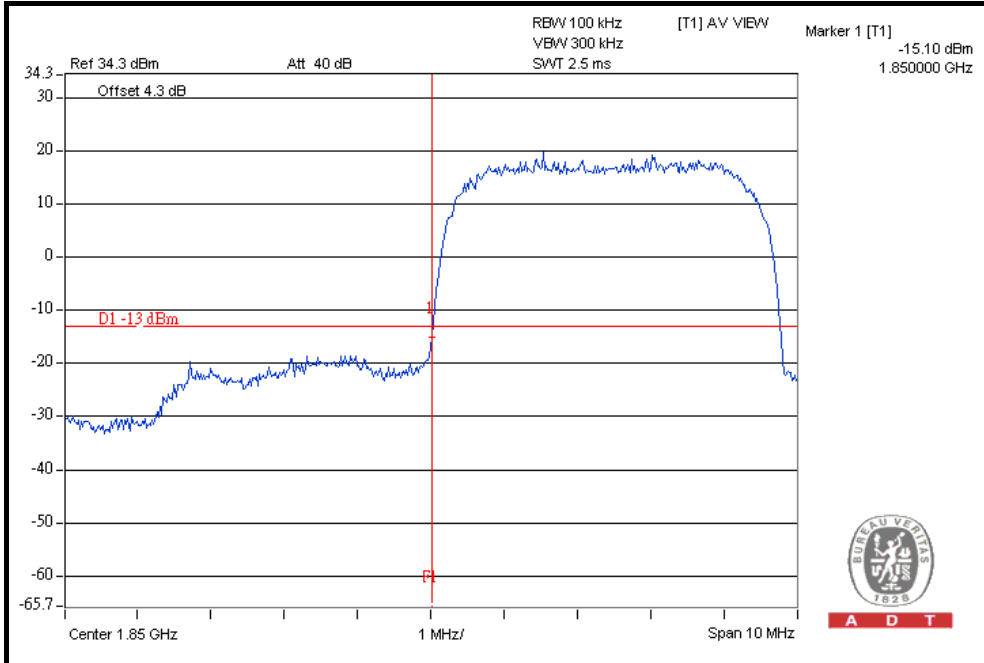

HIGHER BAND EDGE

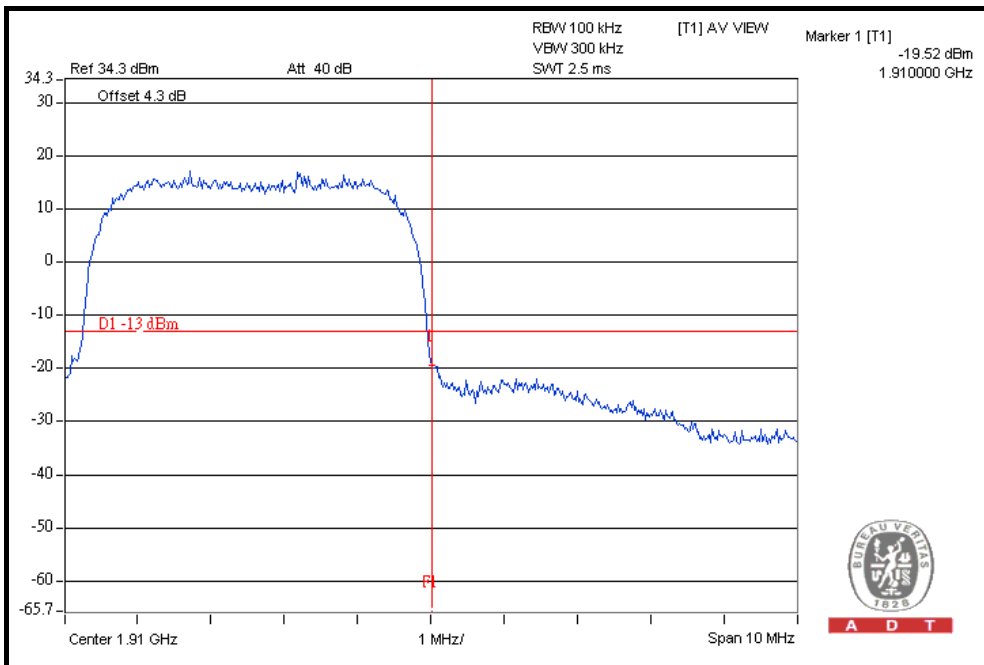

4.5 CONDUCTED SPURIOUS EMISSIONS

4.5.1 LIMITS OF CONDUCTED SPURIOUS EMISSIONS MEASUREMENT

In the FCC 24.238(a), On any frequency outside a licensee's frequency block within USPCS spectrum, the power of any emission shall be attenuated below the transmitter power (P) by at least $43 + 10 \log (P)$ dB. The specified minimum attenuation becomes 43dB and the limit of emission equal to -13dBm .

4.5.2 TEST INSTRUMENTS

DESCRIPTION & MANUFACTURER	MODEL NO.	SERIAL NO.	DATE OF CALIBRATION	DUE DATE OF CALIBRATION
ROHDE & SCHWARZ Spectrum Analyzer	FSP40	100041	May 13, 2009	May 12, 2010
Wainwright Instruments Band Reject Filter	WRCG 1850/1910-1830/1930 -60/9SS	SN1	Mar. 26, 2009	Mar. 25, 2010
WI Highpass filter	WHK3.1/18G-10SS	SN1	Apr. 13, 2009	Apr. 12, 2010
Mini-Circuits Power Splitter	ZN2PD-9G	NA	Jun. 26, 2009	Jun. 25, 2010
RF cable	SUCOFLEX 104	274403/4	Aug. 22, 2008	Aug. 21, 2009
RF cable	SUCOFLEX 104	250729/4	Aug. 21, 2008	Aug. 20, 2009
RF cable	SUCOFLEX 104	214377/4	Aug. 21, 2008	Aug. 20, 2009
JFW 20dB attenuation	50HF-020-SMA	NA	NA	NA

NOTE: The calibration interval of the above test instruments is 12 months. And the calibrations are traceable to NML/ROC and NIST/USA.

4.5.3 TEST PROCEDURE

- a. The EUT makes a phone call to the communication simulator. The power was measured with R&S Spectrum Analyzer. All measurements were done at 3 channels, 512, 661 and 810 (GPRS) / 9262, 9400 and 9538 (WCDMA) (low, middle and high operational frequency range.)
- b. The conducted spurious emission used the power splitter via EUT RF power connector between simulation base station and spectrum analyzer. This splitter loss and cable loss are the worst loss 4.3dB in the transmitted path track.
- c. When the spectrum scanned from 9kHz to 3GHz, it shall be connected to the band reject filter attenuated the carried frequency. The spectrum set RB=1MHz, VB=3MHz.
- d. When the spectrum scanned from 3kHz to 20GHz, it shall be connected to the high pass filter attenuated the carried frequency. The spectrum set set RB=1MHz, VB=3MHz .

4.5.4 TEST SETUP

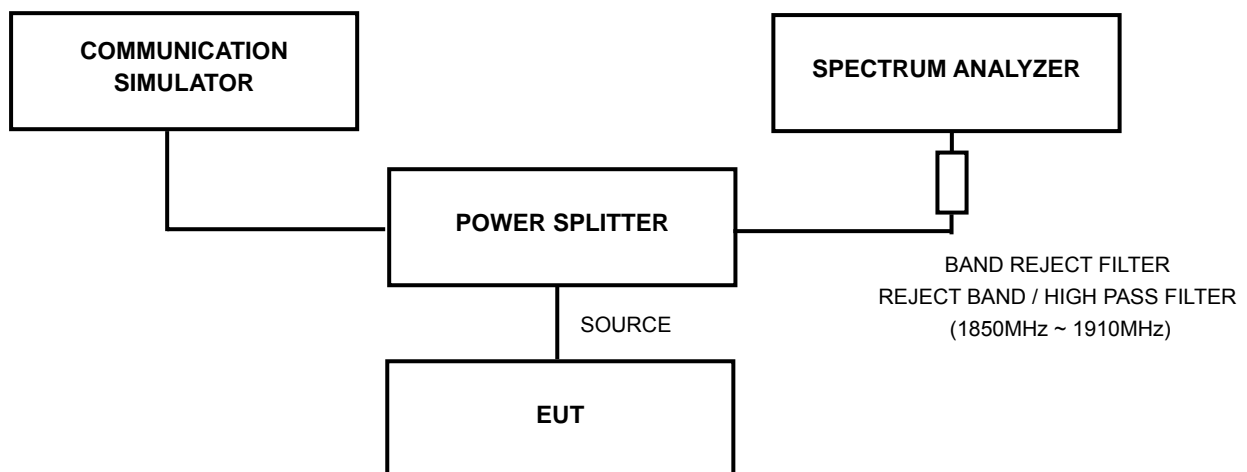

4.5.5 EUT OPERATING CONDITIONS

- a. The EUT makes a phone call to the communication simulator.
- b. The communication simulator station system controlled an EUT to export maximum output power under transmission mode and specific channel frequency.

4.5.6 TEST RESULTS

FOR GPRS:

CH 512: 9kHz ~ 3GHz

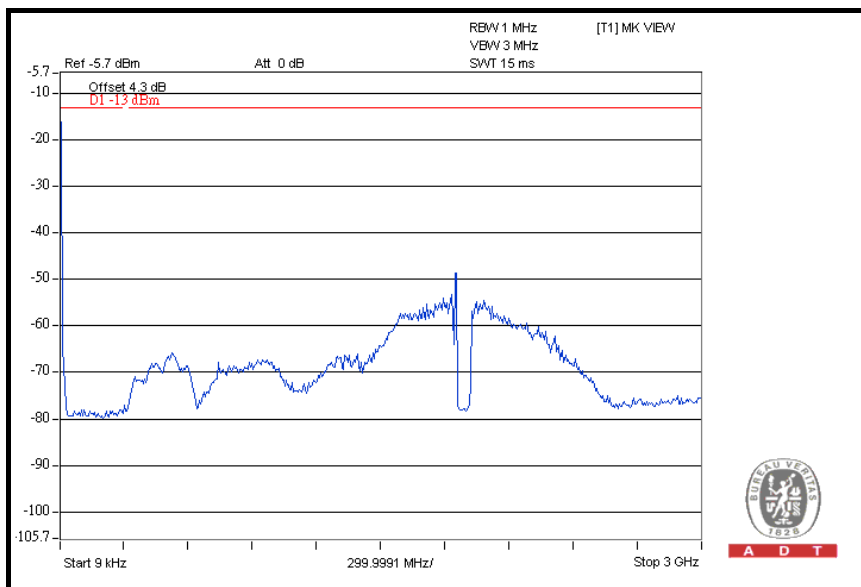

3GHz ~ 10GHz

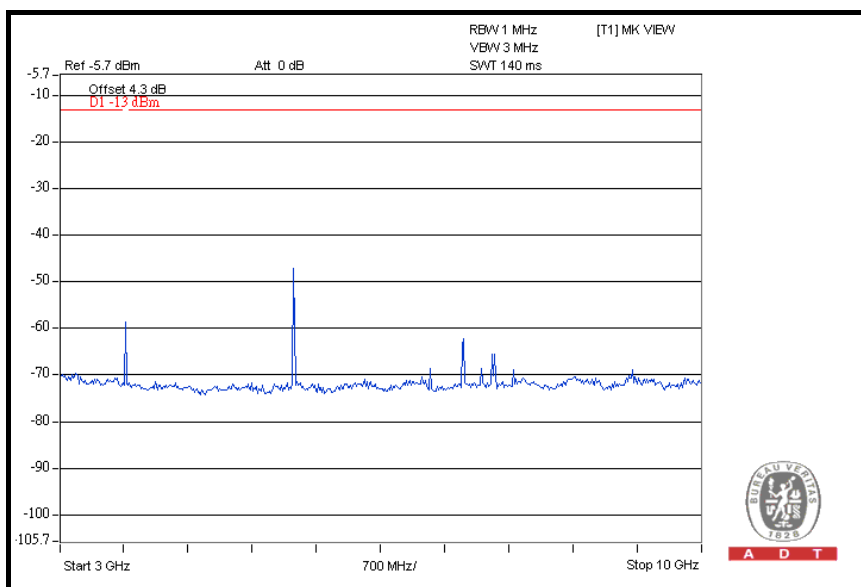



A D T

10GHz ~ 20GHz

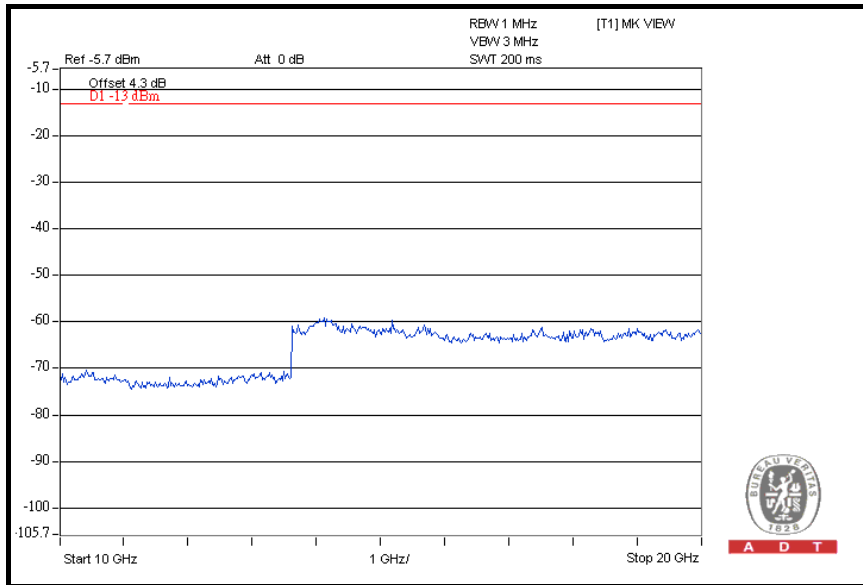

CH 661: 9kHz ~ 3GHz

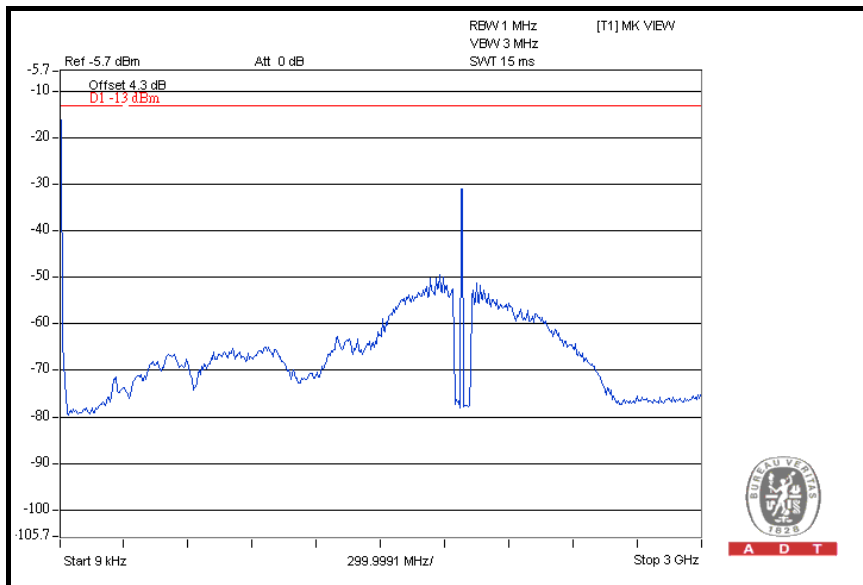



A D T

3GHz ~ 10GHz

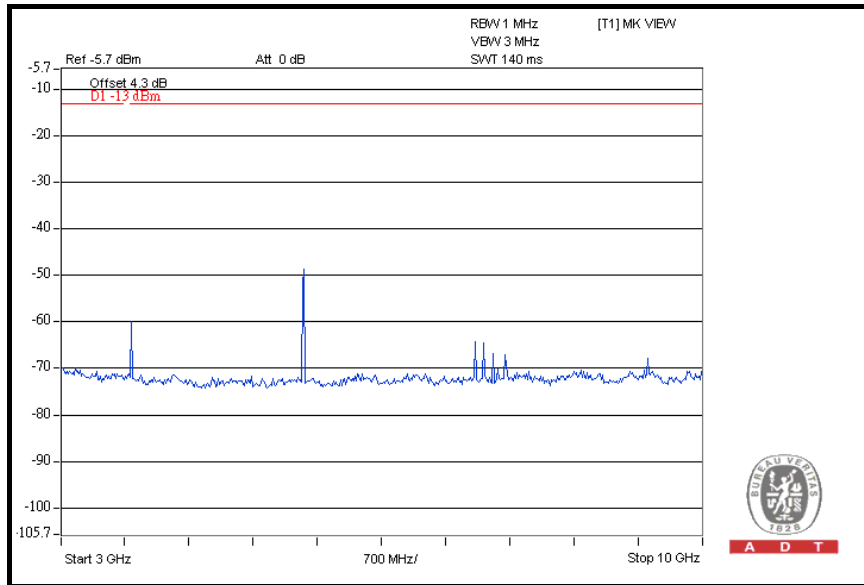

10GHz ~ 20GHz

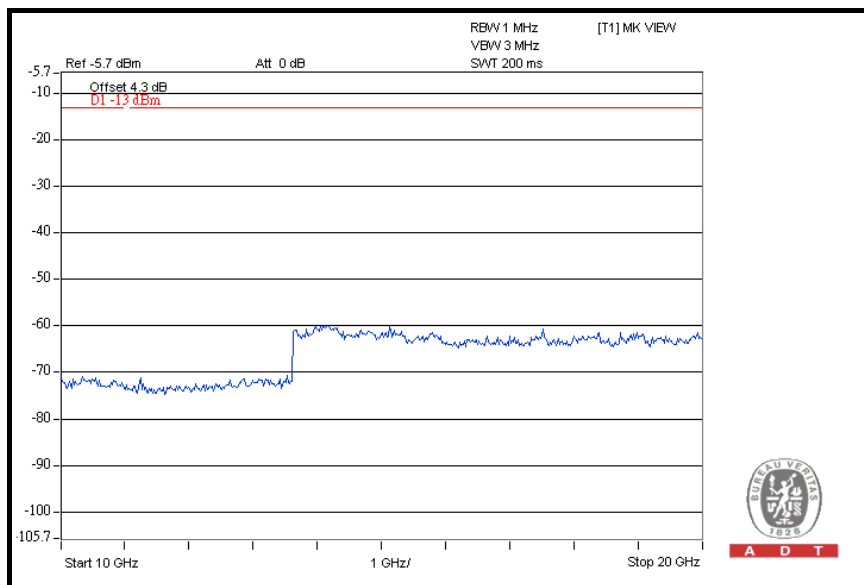

CH 810: 9kHz ~ 3GHz

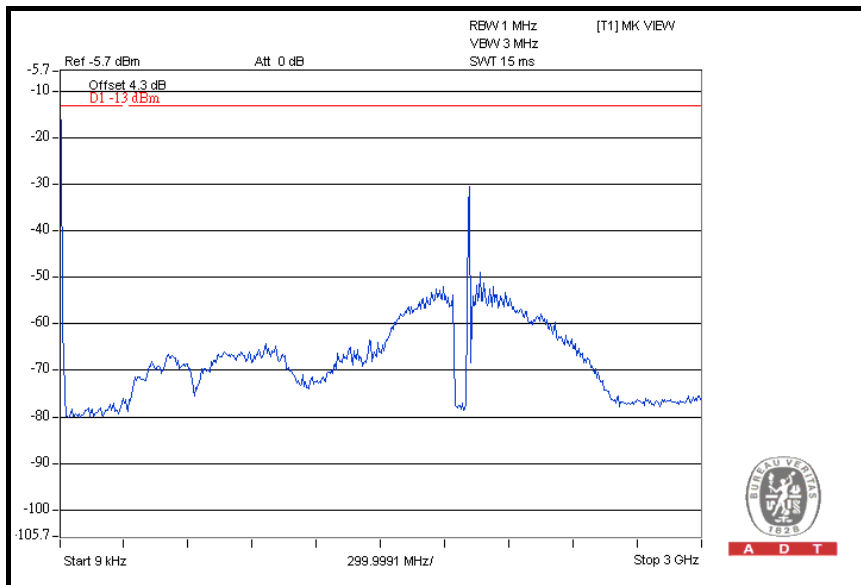

3GHz ~ 10GHz

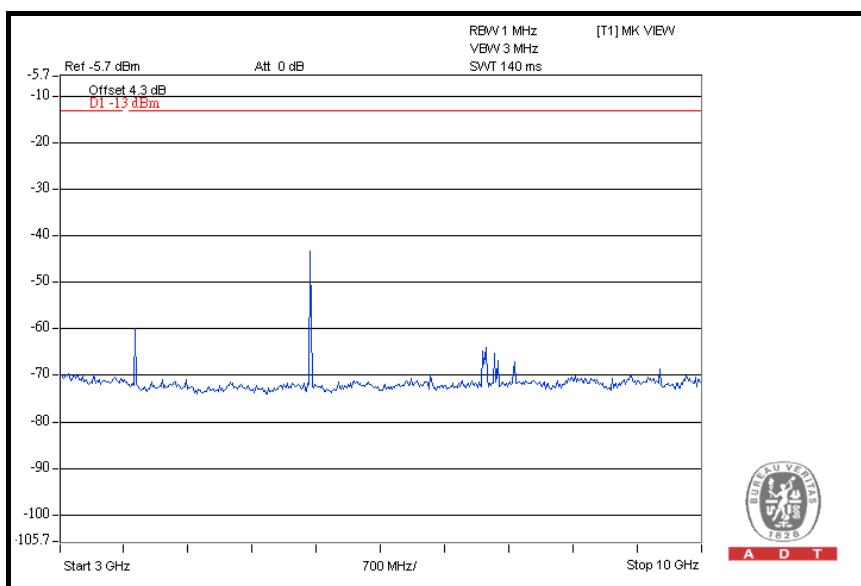



A D T

10GHz ~ 20GHz

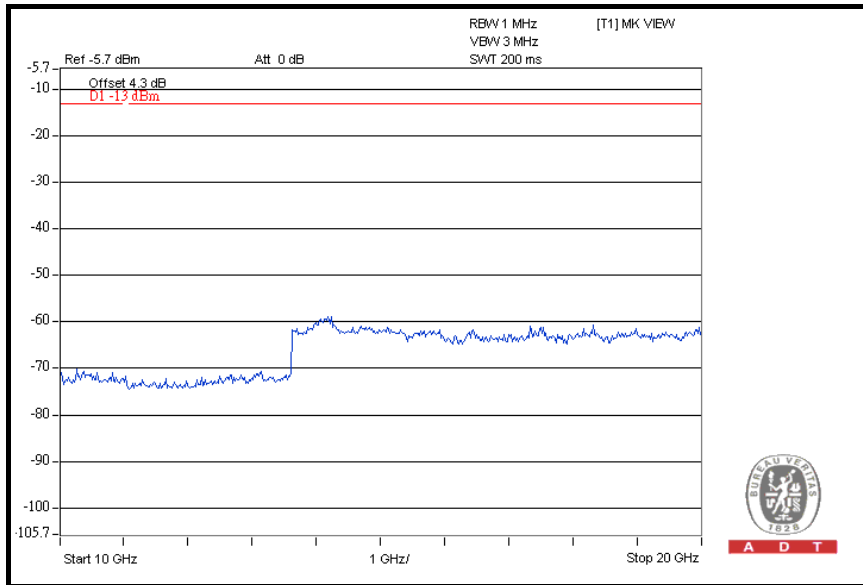



A D T

FOR WCDMA:

CH 9262: 9kHz ~ 3GHz

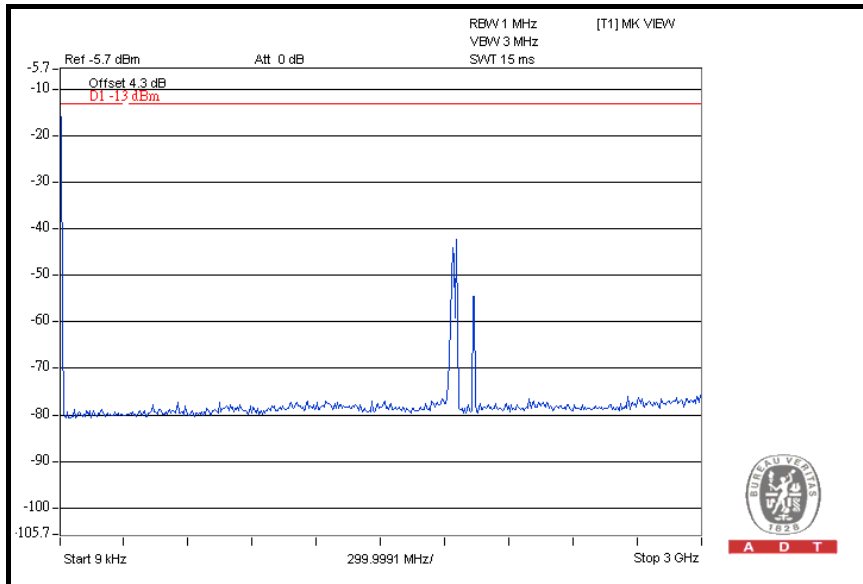

3GHz ~ 10GHz

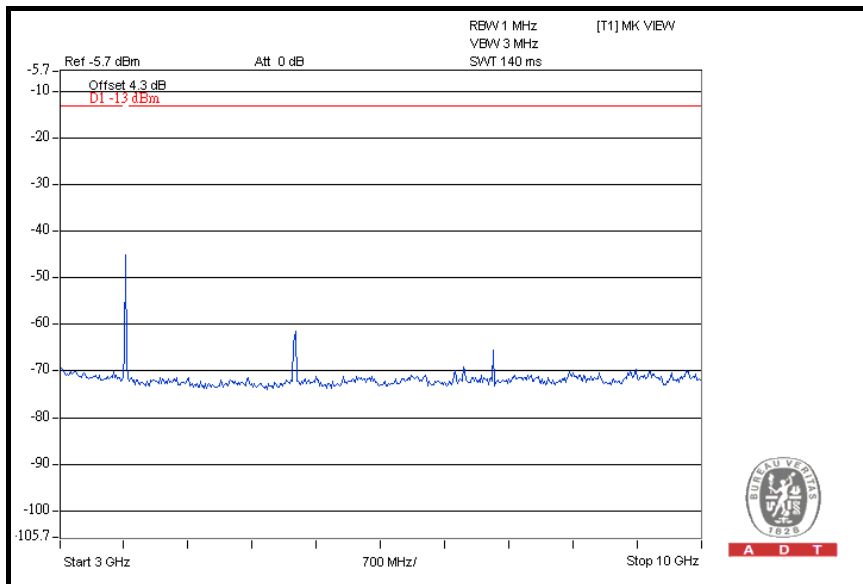



A D T

10GHz ~ 20GHz

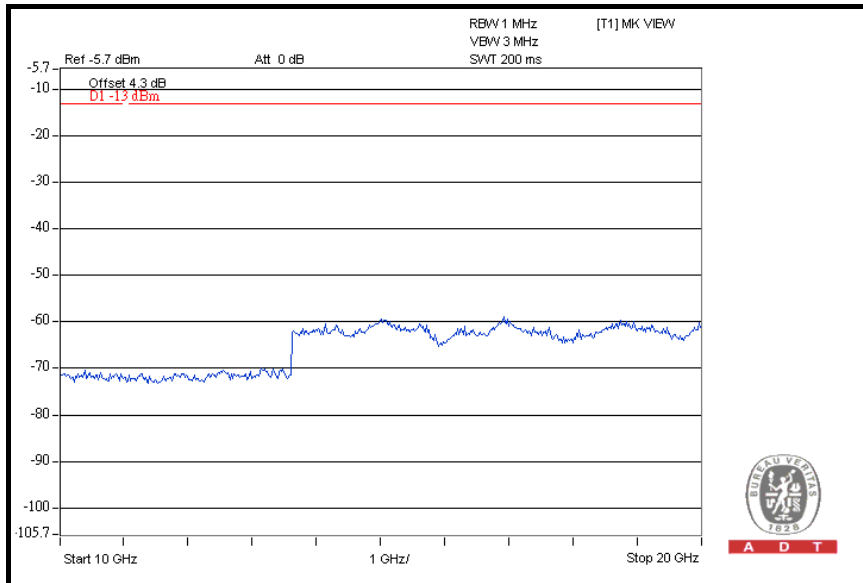

CH 9400: 9kHz ~ 3GHz

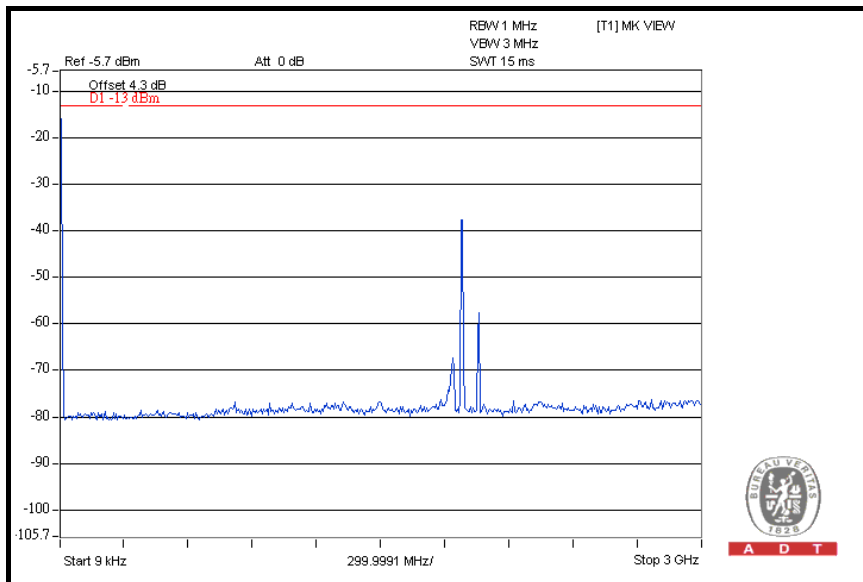



A D T

3GHz ~ 10GHz

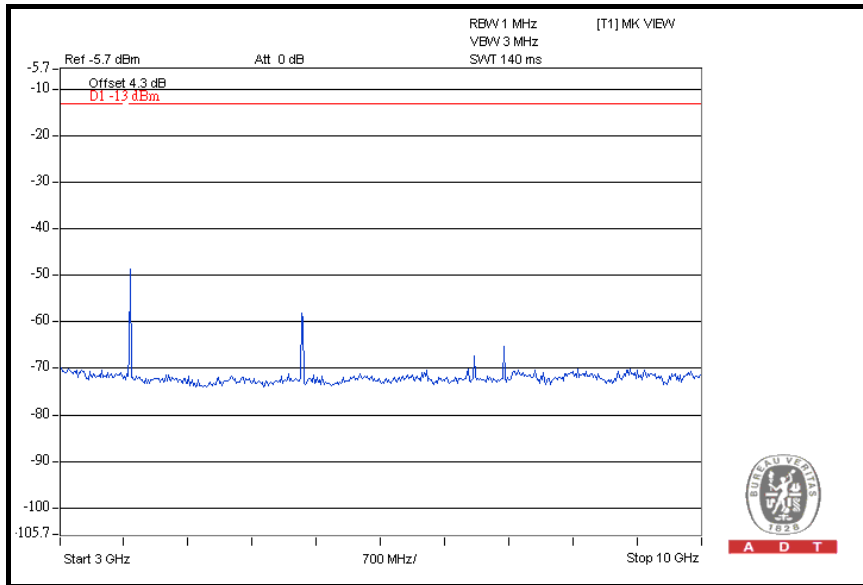

10GHz ~ 20GHz

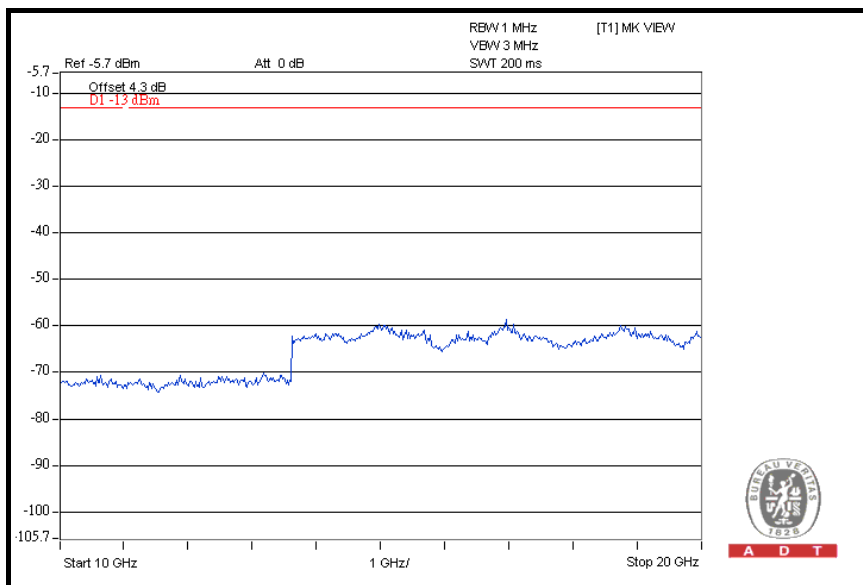



A D T

CH 9538: 9kHz ~ 3GHz

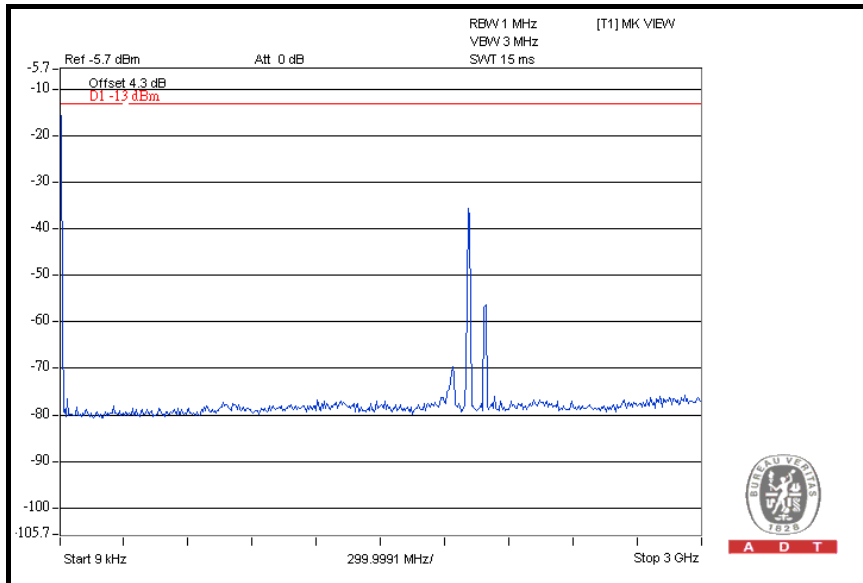

3GHz ~ 10GHz

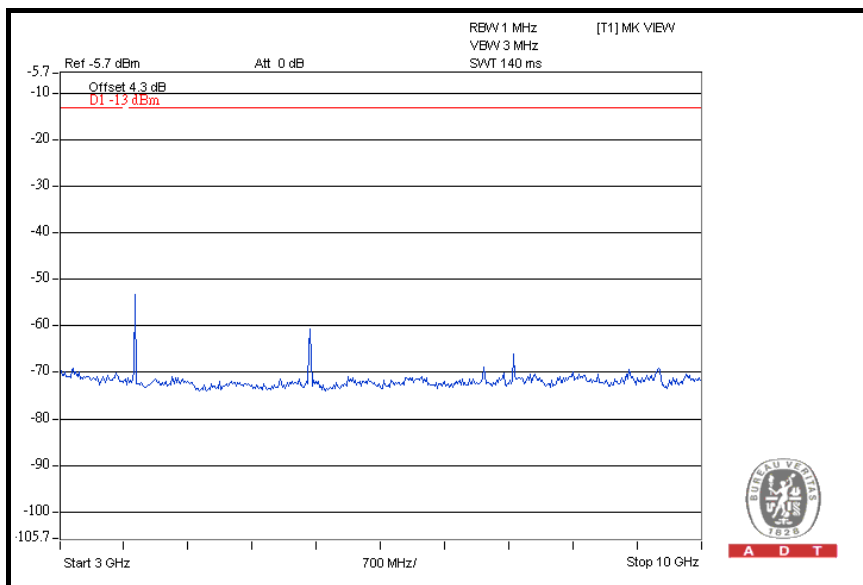



A D T

10GHz ~ 20GHz

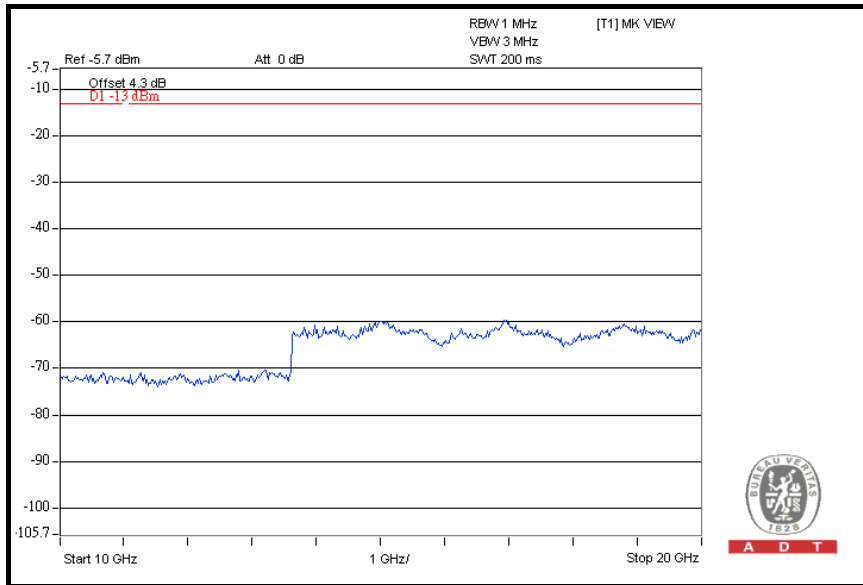

4.6 RADIATED EMISSION MEASUREMENT (BELOW 1GHz)

4.6.1 LIMITS OF RADIATED EMISSION MEASUREMENT

In the FCC 24.238(a), On any frequency outside a licensee's frequency block within USPCS spectrum, the power of any emission shall be attenuated below the transmitter power (P) by at least $43 + 10 \log (P)$ dB. The emission of limit equal to -13 dBm. So the limit of emission is the same absolute specified line.

LIMIT (dBm)	EQUIVALENT FIELD STRENGTH AT 3m (dBuV/m) (NOTE)
-13	82.22

NOTE: The following formula is used to convert the equipment radiated power to field strength.

$$E = [1000000\sqrt{(30P)}] / 3 \text{ uV/m, where P is Watts.}$$

4.6.2 TEST INSTRUMENTS

Same as 4.1.2.

4.6.3 TEST PROCEDURES

- a. The EUT was placed on the top of a rotating table 0.8 meters above the ground at a 3 meters semi-anechoic chamber. The table was rotated 360 degrees to determine the position of the highest radiation.
- b. The EUT was set 3 meters away from the interference-receiving antenna, which was mounted on the top of a variable-height antenna tower.
- c. The antenna is a broadband antenna, and its height is varied from one meter to four meters above the ground to determine the maximum value of the field strength. Both horizontal and vertical polarizations of the antenna are set to make the measurement.
- d. For each suspected emission, the EUT was arranged to its worst case and then the antenna was tuned to heights from 1 meter to 4 meters and the rotatable table was turned from 0 degrees to 360 degrees to find the maximum reading.
- e. The test-receiver system was set to Peak Detect Function and Specified Bandwidth with Maximum Hold Mode.
- f. If the emission level of the EUT in peak mode was lower than the limit specified, then testing could be stopped and the peak values of the EUT would be reported. Otherwise the emissions would be re-tested one by one using peak, quasi-peak or average method as specified and then reported in a data sheet.

NOTE: The resolution bandwidth of spectrum analyzer is 1 MHz and the video bandwidth is 3 MHz.

4.6.4 DEVIATION FROM TEST STANDARD

No deviation

4.6.5 TEST SETUP

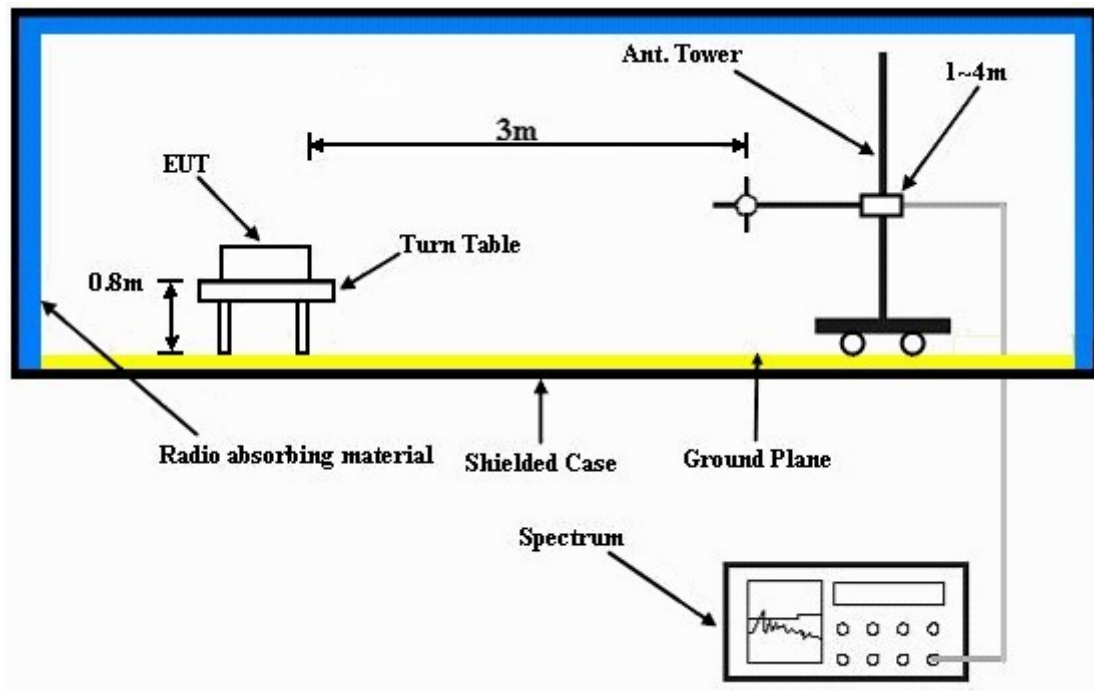

For the actual test configuration, please refer to the attached file (Test Setup Photo).

4.6.6 EUT OPERATING CONDITIONS

- a. The EUT makes a phone call to the communication simulator.
- b. The communication simulator station system controlled an EUT to export maximum output power under transmission mode and specific channel frequency.

4.6.7 TEST RESULTS

FOR GPRS:

MODE	TX channel 661	DETECTOR FUNCTION	Peak
FREQUENCY RANGE	Below 1000 MHz	INPUT POWER (SYSTEM)	120Vac, 60 Hz
ENVIRONMENTAL CONDITIONS	23deg. C, 70%RH, 991hPa	TESTED BY	Lori Chiu

ANTENNA POLARITY & TEST DISTANCE: HORIZONTAL AT 3 M								
No.	Freq. (MHz)	Emission Level (dBuV/m)	Limit (dBuV/m)	Margin (dB)	Antenna Height (m)	Table Angle (Degree)	Raw Value (dBuV)	Correction Factor (dB/m)
1	158.30	48.07	82.22	-34.15	1.75 H	271	34.32	13.74
2	171.90	47.36	82.22	-34.86	1.75 H	235	34.56	12.81
3	226.33	44.46	82.22	-37.76	1.50 H	142	32.69	11.77
4	253.55	45.67	82.22	-36.55	1.25 H	82	32.77	12.90
5	294.37	49.25	82.22	-32.97	1.00 H	58	35.68	13.57
6	393.51	44.92	82.22	-37.30	1.00 H	103	29.02	15.90
ANTENNA POLARITY & TEST DISTANCE: VERTICAL AT 3 M								
No.	Freq. (MHz)	Emission Level (dBuV/m)	Limit (dBuV/m)	Margin (dB)	Antenna Height (m)	Table Angle (Degree)	Raw Value (dBuV)	Correction Factor (dB/m)
1	125.25	47.65	82.22	-34.57	1.00 V	274	35.69	11.95
2	169.96	48.80	82.22	-33.42	1.00 V	103	35.85	12.95
3	294.37	47.70	82.22	-34.52	1.50 V	196	34.12	13.57
4	700.64	51.06	82.22	-31.16	1.00 V	25	28.31	22.75
5	731.74	49.24	82.22	-32.98	1.00 V	34	25.73	23.50
6	799.78	47.83	82.22	-34.39	1.00 V	25	22.52	25.31

NOTE:

1. Emission level (dBuV/m) = Raw Value (dBuV) + Correction Factor (dB).
2. Correction Factor (dB/m) = Antenna Factor (dB/m) + Cable Factor (dB).
3. The other emission levels were very low against the limit.
4. Margin value = Emission level – Limit value.
5. This is valid for all 3 channels.



FOR WCDMA:

MODE	TX channel 9262	DETECTOR FUNCTION	Peak
FREQUENCY RANGE	Below 1000 MHz	INPUT POWER (SYSTEM)	120Vac, 60 Hz
ENVIRONMENTAL CONDITIONS	23deg. C, 70%RH, 991hPa	TESTED BY	Lori Chiu

ANTENNA POLARITY & TEST DISTANCE: HORIZONTAL AT 3 M								
No.	Freq. (MHz)	Emission Level (dBuV/m)	Limit (dBuV/m)	Margin (dB)	Antenna Height (m)	Table Angle (Degree)	Raw Value (dBuV)	Correction Factor (dB/m)
1	150.52	46.19	82.22	-36.03	1.25 H	250	32.30	13.89
2	173.85	46.58	82.22	-35.64	1.25 H	49	33.92	12.66
3	206.89	45.04	82.22	-37.18	1.00 H	286	34.14	10.90
4	232.16	45.54	82.22	-36.68	1.50 H	163	33.51	12.03
5	294.37	49.26	82.22	-32.96	1.25 H	82	35.68	13.57
6	393.51	45.35	82.22	-36.87	1.00 H	103	29.45	15.90

ANTENNA POLARITY & TEST DISTANCE: VERTICAL AT 3 M								
No.	Freq. (MHz)	Emission Level (dBuV/m)	Limit (dBuV/m)	Margin (dB)	Antenna Height (m)	Table Angle (Degree)	Raw Value (dBuV)	Correction Factor (dB/m)
1	169.96	48.25	82.22	-33.97	1.00 V	115	35.30	12.95
2	251.60	48.14	82.22	-34.08	1.00 V	121	35.28	12.86
3	294.37	48.01	82.22	-34.21	1.75 V	22	34.43	13.57
4	700.64	53.00	82.22	-29.22	1.00 V	10	30.26	22.75
5	733.69	49.10	82.22	-33.12	1.25 V	10	25.55	23.55
6	910.58	49.30	82.22	-32.92	2.00 V	295	23.11	26.19

NOTE:

1. Emission level (dBuV/m) = Raw Value (dBuV) + Correction Factor (dB).
2. Correction Factor (dB/m) = Antenna Factor (dB/m) + Cable Factor (dB).
3. The other emission levels were very low against the limit.
4. Margin value = Emission level – Limit value.
5. This is valid for all 3 channels.

4.7 RADIATED EMISSION MEASUREMENT (ABOVE 1GHz)

4.7.1 LIMITS OF RADIATED EMISSION MEASUREMENT

In the FCC 24.238(a), On any frequency outside a licensee's frequency block within USPCS spectrum, the power of any emission shall be attenuated below the transmitter power (P) by at least $43 + 10 \log (P)$ dB. The specified minimum attenuation becomes 43dB and the limit of emission equal to -13dBm .

4.7.2 TEST INSTRUMENTS

Same as 4.1.2.

4.7.3 TEST PROCEDURES

- a. Substitution method is used for E.I.R.P measurement. In the semi-anechoic chamber, EUT placed on the 0.8m height of Turn Table, rotated the table around 360 degrees to search the maximum radiation power and receiver antenna shall be rotated vertical and horizontal polarization and moved height from 1m to 4m to find the maximum polar radiated power. The “Read Value” is the spectrum reading the maximum power value.
- b. The substitution horn antenna is substituted for EUT at the same position and signals generator export the CW signal to the substitution antenna via a TX cable. Rotated the Turn Table and moved receiving antenna to find the maximum radiation power. Adjust output power level of S.G to get a Value of spectrum reading equal to “Read Value “ of step a. Record the power level of S.G
- c. $EIRP = \text{Output power level of S.G} - \text{TX cable loss} + \text{Antenna gain of substitution horn.}$

NOTE: The resolution bandwidth and video bandwidth of test receiver/spectrum analyzer is 1MHz/3MHz.

4.7.4 DEVIATION FROM TEST STANDARD

No deviation

4.7.5 TEST SETUP

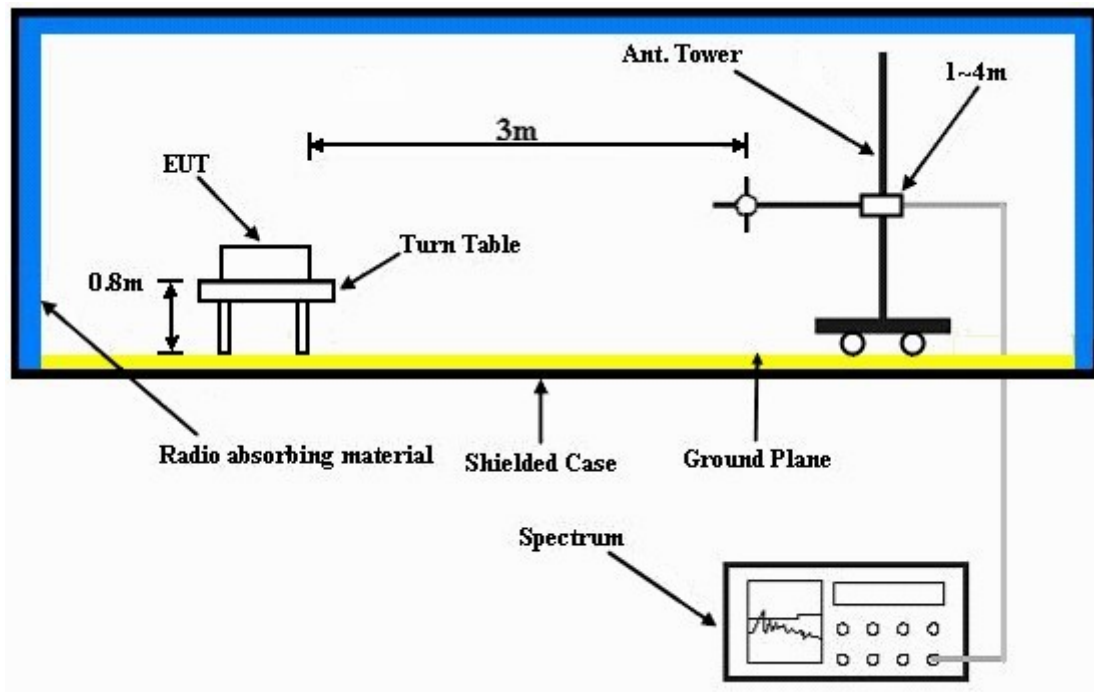

For the actual test configuration, please refer to the attached file (Test Setup Photo).

4.7.6 EUT OPERATING CONDITIONS

- a. The EUT makes a phone call to the communication simulator.
- b. The communication simulator station system controlled an EUT to export maximum output power under transmission mode and specific channel frequency.



4.7.7 TEST RESULTS

FOR GPRS:

MODE	TX channel 512	FREQUENCY RANGE	Above 1000 MHz
INPUT POWER	120Vac, 60 Hz	ENVIRONMENTAL CONDITIONS	23deg. C, 68%RH, 991hPa
TESTED BY	Mark Liao		

ANTENNA POLARITY & TEST DISTANCE: HORIZONTAL AT 3 M						
No.	Freq. (MHz)	Emission Level (dBuV)	Limit (dBm)	S.G Power Value (dBm)	Correction Factor (dB)	Power Value (dBm)
1	3700.40	46.13	-13.00	-58.79	9.90	-48.89
2	5550.60	50.88	-13.00	-53.89	9.71	-44.18
3	12950.00	69.87	-13.00	-33.49	8.28	-25.21
ANTENNA POLARITY & TEST DISTANCE: VERTICAL AT 3 M						
No.	Freq. (MHz)	Emission Level (dBuV)	Limit (dBm)	S.G Power Value (dBm)	Correction Factor (dB)	Power Value (dBm)
1	3700.40	45.83	-13.00	-59.12	9.90	-49.22
2	5550.60	49.08	-13.00	-55.72	9.71	-46.01
3	12950.00	71.56	-13.00	-31.80	8.28	-23.52

NOTE: Power Value (dBum) = S.G Power Value (dBm) + Correction Factor (dB).



A D T

MODE	TX channel 661	FREQUENCY RANGE	Above 1000 MHz
INPUT POWER	120Vac, 60 Hz	ENVIRONMENTAL CONDITIONS	23deg. C, 68%RH, 991hPa
TESTED BY	Mark Liao		

ANTENNA POLARITY & TEST DISTANCE: HORIZONTAL AT 3 M						
No.	Freq. (MHz)	Emission Level (dBuV)	Limit (dBm)	S.G Power Value (dBm)	Correction Factor (dB)	Power Value (dBm)
1	3760.00	44.51	-13.00	-60.40	9.88	-50.52
2	5640.00	49.35	-13.00	-55.37	9.64	-45.73
3	13160.00	70.03	-13.00	-32.97	7.95	-25.02
ANTENNA POLARITY & TEST DISTANCE: VERTICAL AT 3 M						
No.	Freq. (MHz)	Emission Level (dBuV)	Limit (dBm)	S.G Power Value (dBm)	Correction Factor (dB)	Power Value (dBm)
1	3760.00	46.93	-13.00	-58.00	9.88	-48.12
2	5640.00	51.15	-13.00	-53.57	9.64	-43.93
3	13160.00	72.11	-13.00	-30.89	7.95	-22.94

NOTE: Power Value (dBum) = S.G Power Value (dBm) + Correction Factor (dB).



MODE	TX channel 810	FREQUENCY RANGE	Above 1000 MHz
INPUT POWER	120Vac, 60 Hz	ENVIRONMENTAL CONDITIONS	23deg. C, 68%RH, 991hPa
TESTED BY	Mark Liao		

ANTENNA POLARITY & TEST DISTANCE: HORIZONTAL AT 3 M						
No.	Freq. (MHz)	Emission Level (dBuV)	Limit (dBm)	S.G Power Value (dBm)	Correction Factor (dB)	Power Value (dBm)
1	3819.60	45.76	-13.00	-59.18	9.85	-49.33
2	5729.40	49.06	-13.00	-55.63	9.62	-46.01
3	13368.60	70.54	-13.00	-31.99	7.48	-24.51
ANTENNA POLARITY & TEST DISTANCE: VERTICAL AT 3 M						
No.	Freq. (MHz)	Emission Level (dBuV)	Limit (dBm)	S.G Power Value (dBm)	Correction Factor (dB)	Power Value (dBm)
1	3819.60	45.88	-13.00	-59.06	9.85	-49.21
2	5729.40	49.12	-13.00	-55.55	9.62	-45.93
3	13368.60	72.89	-13.00	-29.67	7.48	-22.19

NOTE: Power Value (dBum) = S.G Power Value (dBm) + Correction Factor (dB).



FOR WCDMA:

MODE	TX channel 9262	FREQUENCY RANGE	Above 1000 MHz
INPUT POWER	120Vac, 60 Hz	ENVIRONMENTAL CONDITIONS	23deg. C, 68%RH, 991hPa
TESTED BY	Mark Liao		

ANTENNA POLARITY & TEST DISTANCE: HORIZONTAL AT 3 M						
No.	Freq. (MHz)	Emission Level (dBuV)	Limit (dBm)	S.G Power Value (dBm)	Correction Factor (dB)	Power Value (dBm)
1	3704.80	50.72	-13.00	-54.21	9.90	-44.31
2	5557.20	48.07	-13.00	-56.71	9.73	-46.98
ANTENNA POLARITY & TEST DISTANCE: VERTICAL AT 3 M						
No.	Freq. (MHz)	Emission Level (dBuV)	Limit (dBm)	S.G Power Value (dBm)	Correction Factor (dB)	Power Value (dBm)
1	3704.80	50.3	-13.00	-54.66	9.90	-44.76
2	5557.20	48.24	-13.00	-56.51	9.73	-46.78

NOTE: Power Value (dBum) = S.G Power Value (dBm) + Correction Factor (dB).



MODE	TX channel 9400	FREQUENCY RANGE	Above 1000 MHz
INPUT POWER	120Vac, 60 Hz	ENVIRONMENTAL CONDITIONS	23deg. C, 68%RH, 991hPa
TESTED BY	Mark Liao		

ANTENNA POLARITY & TEST DISTANCE: HORIZONTAL AT 3 M						
No.	Freq. (MHz)	Emission Level (dBuV)	Limit (dBm)	S.G Power Value (dBm)	Correction Factor (dB)	Power Value (dBm)
1	3760.00	51.27	-13.00	-53.69	9.88	-43.81
2	5640.00	48.56	-13.00	-56.15	9.64	-46.51
ANTENNA POLARITY & TEST DISTANCE: VERTICAL AT 3 M						
No.	Freq. (MHz)	Emission Level (dBuV)	Limit (dBm)	S.G Power Value (dBm)	Correction Factor (dB)	Power Value (dBm)
1	3760.00	51.36	-13.00	-53.58	9.88	-43.70
2	5640.00	48.36	-13.00	-56.31	9.64	-46.67

NOTE: Power Value (dBum) = S.G Power Value (dBm) + Correction Factor (dB).



MODE	TX channel 9538	FREQUENCY RANGE	Above 1000 MHz
INPUT POWER	120Vac, 60 Hz	ENVIRONMENTAL CONDITIONS	23deg. C, 68%RH, 991hPa
TESTED BY	Mark Liao		

ANTENNA POLARITY & TEST DISTANCE: HORIZONTAL AT 3 M						
No.	Freq. (MHz)	Emission Level (dBuV)	Limit (dBm)	S.G Power Value (dBm)	Correction Factor (dB)	Power Value (dBm)
1	3815.20	51.58	-13.00	-53.33	9.85	-43.48
2	5722.80	48.71	-13.00	-55.95	9.62	-46.33
ANTENNA POLARITY & TEST DISTANCE: VERTICAL AT 3 M						
No.	Freq. (MHz)	Emission Level (dBuV)	Limit (dBm)	S.G Power Value (dBm)	Correction Factor (dB)	Power Value (dBm)
1	3815.20	51.69	-13.00	-53.24	9.85	-43.39
2	5722.80	48.56	-13.00	-56.11	9.62	-46.49

NOTE: Power Value (dBum) = S.G Power Value (dBm) + Correction Factor (dB).

5 PHOTOGRAPHS OF THE TEST CONFIGURATION

Please refer to the attached file (Test Setup Photo).



A D T

6 INFORMATION ON THE TESTING LABORATORIES

We, Bureau Veritas Consumer Products Services (H.K.) Ltd., Taoyuan Branch, were founded in 1988 to provide our best service in EMC, Radio, Telecom and Safety consultation. Our laboratories are accredited and approved by the following approval agencies according to ISO/IEC 17025.

USA	FCC, NVLAP
GERMANY	TUV Rheinland
JAPAN	VCCI
NORWAY	NEMKO
CANADA	INDUSTRY CANADA , CSA
R.O.C.	TAF, BSMI, NCC
NETHERLANDS	Telefication
SINGAPORE	GOST-ASIA (MOU)
RUSSIA	CERTIS (MOU)

Copies of accreditation certificates of our laboratories obtained from approval agencies can be downloaded from our web site: www.adt.com.tw/index.5/phtml.
If you have any comments, please feel free to contact us at the following:

Linko EMC/RF Lab:
Tel: 886-2-26052180
Fax: 886-2-26051924

Hsin Chu EMC/RF Lab:
Tel: 886-3-5935343
Fax: 886-3-5935342

Hwa Ya EMC/RF/Safety/Telecom Lab:
Tel: 886-3-3183232
Fax: 886-3-3185050

Web Site: www.adt.com.tw

The address and road map of all our labs can be found in our web site also.



7 APPENDIX A – MODIFICATIONS RECORDERS FOR ENGINEERING CHANGES TO THE EUT BY THE LAB

No any modifications are made to the EUT by the lab during the test.

---END---