

APPLICATION CERTIFICATION FCC Part 15C
On Behalf of
Pipo Technology Co., Ltd.

Mobile Internet Device
Model No.: P804, P831, P832, P891, P826

FCC ID: PT7P804

Prepared for : Pipo Technology Co., Ltd.
Address : Area C, 3F, Bao Yun Da Logistics Centre, Warehouse, Xi Xiang Avenue, Bao An District, Shenzhen, China

Prepared by : ACCURATE TECHNOLOGY CO., LTD
Address : F1, Bldg. A, Changyuan New Material Port, Keyuan Rd. Science & Industry Park, Nanshan, Shenzhen, Guangdong P.R. China

Tel: (0755) 26503290
Fax: (0755) 26503396

Report Number : ATE20122384
Date of Test : October 16-30, 2012
Date of Report : October 31, 2012

TABLE OF CONTENTS

Description	Page
Test Report Certification	
1. GENERAL INFORMATION	5
1.1. Description of Device (EUT).....	5
1.2. Carrier Frequency of Channels.....	6
1.3. Test Procedure	6
1.4. Special Accessory and Auxiliary Equipment	6
1.5. Description of Test Facility	6
1.6. Measurement Uncertainty.....	7
2. MEASURING DEVICE AND TEST EQUIPMENT	8
3. OPERATION OF EUT DURING TESTING	9
3.1. Operating Mode	9
3.2. Configuration and peripherals	10
4. TEST PROCEDURES AND RESULTS	11
5. 6DB BANDWIDTH MEASUREMENT.....	12
5.1. Block Diagram of Test Setup.....	12
5.2. The Requirement For Section 15.247(a)(2).....	12
5.3. EUT Configuration on Measurement	12
5.4. Operating Condition of EUT	12
5.5. Test Procedure	13
5.6. Test Result	13
6. MAXIMUM PEAK OUTPUT POWER	27
6.1. Block Diagram of Test Setup.....	27
6.2. The Requirement For Section 15.247(b)(3).....	27
6.3. EUT Configuration on Measurement	27
6.4. Operating Condition of EUT	27
6.5. Test Procedure	28
6.6. Test Result	28
7. POWER SPECTRAL DENSITY MEASUREMENT.....	42
7.1. Block Diagram of Test Setup.....	42
7.2. The Requirement For Section 15.247(e).....	42
7.3. EUT Configuration on Measurement	42
7.4. Operating Condition of EUT	42
7.5. Test Procedure	43
7.6. Test Result	44
8. BAND EDGE COMPLIANCE TEST	58
8.1. Block Diagram of Test Setup.....	58
8.2. The Requirement For Section 15.247(d)	58
8.3. EUT Configuration on Measurement	58
8.4. Operating Condition of EUT	59
8.5. Test Procedure	59
8.6. Test Result	60
9. RADIATED SPURIOUS EMISSION TEST	93
9.1. Block Diagram of Test Setup.....	93
9.2. The Limit For Section 15.247(d)	94
9.3. Restricted bands of operation	94

- 9.4. Configuration of EUT on Measurement95
- 9.5. Operating Condition of EUT95
- 9.6. Test Procedure95
- 9.7. The Field Strength of Radiation Emission Measurement Results96
- 10. CONDUCTED SPURIOUS EMISSION COMPLIANCE TEST 180**
 - 10.1. Block Diagram of Test Setup..... 180
 - 10.2. The Requirement For Section 15.247(d) 180
 - 10.3. EUT Configuration on Measurement 180
 - 10.4. Operating Condition of EUT 181
 - 10.5. Test Procedure 181
 - 10.6. Test Result 181
- 11. AC POWER LINE CONDUCTED EMISSION FOR FCC PART 15 SECTION 15.207(A) 194**
 - 11.1. Block Diagram of Test Setup..... 194
 - 11.2. The Emission Limit 194
 - 11.3. Configuration of EUT on Measurement 195
 - 11.4. Operating Condition of EUT 195
 - 11.5. Test Procedure 195
 - 11.6. Power Line Conducted Emission Measurement Results 196
- 12. ANTENNA REQUIREMENT..... 199**
 - 12.1. The Requirement 199
 - 12.2. Antenna Construction 199

Test Report Certification

Applicant : Pipo Technology Co., Ltd.
Manufacturer : Pipo Technology Co., Ltd.
EUT Description : Mobile Internet Device
(A) MODEL NO.: P804, P831, P832, P891, P826
(B) SERIAL NO.: N/A
(C) POWER SUPPLY: DC 3.7V (Li-polymer battery) & AC 120V/60Hz
(Adapter input)

Measurement Procedure Used:

**FCC Rules and Regulations Part 15 Subpart C Section 15.247
ANSI C63.4: 2009**

The EUT was tested according to DTS test procedure of October 04, 2012 KDB558074 D01
DTS Meas Guidance v02 for compliance to FCC 47CFR 15.247 requirements

The device described above is tested by ACCURATE TECHNOLOGY CO. LTD to determine the maximum emission levels emanating from the device. The maximum emission levels are compared to the FCC Part 15 Subpart C Section 15.247 limits. The measurement results are contained in this test report and ACCURATE TECHNOLOGY CO. LTD is assumed full responsibility for the accuracy and completeness of these measurements. Also, this report shows that the Equipment Under Test (EUT) is to be technically compliant with the FCC requirements.

This report applies to above tested sample only. This report shall not be reproduced in part without written approval of ACCURATE TECHNOLOGY CO. LTD.

Date of Test : October 16-30, 2012

Prepared by : Apple Lv
(Engineer)

Approved & Authorized Signer : Heunb
(Manager)

1. GENERAL INFORMATION

1.1. Description of Device (EUT)

EUT	:	Mobile Internet Device
Model Number	:	P804, P831, P832, P891, P826 (Note: These samples are same except for the appearance is difference. So we prepare the P804 for FCC test.)
Frequency Range	:	802.11b/g/n(20MHz): 2412-2462MHz 802.11n(40MHz): 2422-2452MHz
Number of Channels	:	802.11b/g/n (20MHz):11 802.11n (40MHz): 7
Antenna Gain	:	0dBi
Power Supply	:	DC 3.7V (Li-polymer battery) & AC 120V/60Hz (Adapter input)
Adapter	:	Model number: DNS-050200CW Input: AC 100-240V; 50/60Hz 0.35A Output: DC 5V/2.0A Output line: Non-shielded, Non-detachable, 1.5m with a ferrite core
Data Rate	:	802.11b: 11, 5.5, 2, 1 Mbps 802.11g: 54, 48, 36, 24, 18, 12, 9, 6 Mbps 802.11n: up to 150Mbps
Applicant	:	Pipo Technology Co., Ltd.
Address	:	Area C, 3F, Bao Yun Da Logistics Centre, Warehouse, Xi Xiang Avenue, Bao An District, Shenzhen, China
Manufacturer	:	Pipo Technology Co., Ltd.
Address	:	Area C, 3F, Bao Yun Da Logistics Centre, Warehouse, Xi Xiang Avenue, Bao An District, Shenzhen, China
Date of sample received	:	October 16, 2012
Date of Test	:	October 16-30, 2012

1.2. Carrier Frequency of Channels

802.11b, 802.11g, 802.11n (20MHz)

Channel	Frequency(MHz)	Channel	Frequency(MHz)
01	2412	07	2442
02	2417	08	2447
03	2422	09	2452
04	2427	10	2457
05	2432	11	2462
06	2437	---	---

802.11n (40MHz)

Channel	Frequency(MHz)	Channel	Frequency(MHz)
---	---	07	2442
---	---	08	2447
03	2422	09	2452
04	2427	---	---
05	2432	---	---
06	2437	---	---

1.3. Test Procedure

The EUT was tested according to DTS test procedure of October 04, 2012 KDB558074 D01 DTS Meas Guidance v02 for compliance to FCC 47CFR 15.247 requirements

1.4. Special Accessory and Auxiliary Equipment

N/A

1.5. Description of Test Facility

EMC Lab : Accredited by TUV Rheinland Shenzhen

Listed by FCC
The Registration Number is 752051

Listed by Industry Canada
The Registration Number is 5077A-2

Accredited by China National Accreditation Committee for Laboratories
The Certificate Registration Number is L3193

Name of Firm : ACCURATE TECHNOLOGY CO. LTD

Site Location : F1, Bldg. A, Changyuan New Material Port, Keyuan Rd. Science & Industry Park, Nanshan, Shenzhen, Guangdong P.R. China

1.6.Measurement Uncertainty

Conducted Emission Expanded Uncertainty = 2.23dB, k=2

Radiated emission expanded uncertainty
(9kHz-30MHz) = 3.08dB, k=2

Radiated emission expanded uncertainty
(30MHz-1000MHz) = 4.42dB, k=2

Radiated emission expanded uncertainty
(Above 1GHz) = 4.06dB, k=2

2. MEASURING DEVICE AND TEST EQUIPMENT

Table 1: List of Test and Measurement Equipment

Kind of equipment	Manufacturer	Type	S/N	Calibrated dates	Calibrated until
EMI Test Receiver	Rohde&Schwarz	ESCS30	100307	Jan. 8, 2012	Jan. 7, 2013
EMI Test Receiver	Rohde&Schwarz	ESPI3	101526/003	Jan. 8, 2012	Jan. 7, 2013
Spectrum Analyzer	Agilent	E7405A	MY45115511	Jan. 8, 2012	Jan. 7, 2013
Pre-Amplifier	Rohde&Schwarz	CBLU118354 0-01	3791	Jan. 8, 2012	Jan. 7, 2013
Loop Antenna	Schwarzbeck	FMZB1516	1516131	Jan. 8, 2012	Jan. 7, 2013
Bilog Antenna	Schwarzbeck	VULB9163	9163-323	Jan. 8, 2012	Jan. 7, 2013
Horn Antenna	Schwarzbeck	BBHA9120D	9120D-655	Jan. 8, 2012	Jan. 7, 2013
Horn Antenna	Schwarzbeck	BBHA9170	9170-359	Jan. 8, 2012	Jan. 7, 2013
LISN	Rohde&Schwarz	ESH3-Z5	100305	Jan. 8, 2012	Jan. 7, 2013
LISN	Schwarzbeck	NSLK8126	8126431	Jan. 8, 2012	Jan. 7, 2013
Highpass Filter	Wainwright Instruments	WHKX3.6/18 G-10SS	N/A	Jan. 8, 2012	Jan. 7, 2013
Band Reject Filter	Wainwright Instruments	WRCG2400/2 485-2375/2510 -60/11SS	N/A	Jan. 8, 2012	Jan. 7, 2013

3. OPERATION OF EUT DURING TESTING

3.1.Operating Mode

The mode is used: **1.802.11b Transmitting mode**

Low Channel: 2412MHz

Middle Channel: 2437MHz

High Channel: 2462MHz

2.802.11g Transmitting mode

Low Channel: 2412MHz

Middle Channel: 2437MHz

High Channel: 2462MHz

3.802.11n (20MHz) Transmitting mode

Low Channel: 2412MHz

Middle Channel: 2437MHz

High Channel: 2462MHz

4.802.11n (40MHz) Transmitting mode

Low Channel: 2422MHz

Middle Channel: 2437MHz

High Channel: 2452MHz

5. Charging

3.2. Configuration and peripherals

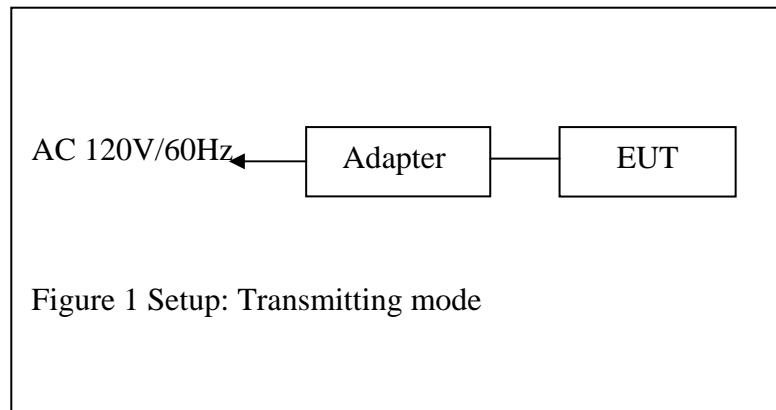

4. TEST PROCEDURES AND RESULTS

FCC Rules	Description of Test	Result
Section 15.247(a)(2)	6dB Bandwidth Test	Compliant
Section 15.247(e)	Power Spectral Density Test	Compliant
Section 15.247(b)(3)	Maximum Peak Output Power Test	Compliant
Section 15.247(d)	Band Edge Compliance Test	Compliant
Section 15.247(d) Section 15.209	Radiated Spurious Emission Test	Compliant
Section 15.247(d)	Conducted Spurious Emission Test	Compliant
Section 15.207	AC Power Line Conducted Emission Test	Compliant
Section 15.203	Antenna Requirement	Compliant

5. 6DB BANDWIDTH MEASUREMENT

5.1. Block Diagram of Test Setup

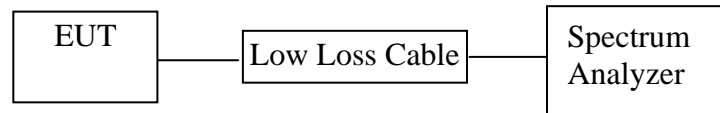

(EUT: Mobile Internet Device)

5.2. The Requirement For Section 15.247(a)(2)

Section 15.247(a)(2): Systems using digital modulation techniques may operate in the 902-928MHz, 2400-2483.5MHz, and 5725-5850MHz bands. The minimum 6 dB bandwidth shall be at least 500 kHz.

5.3. EUT Configuration on Measurement

The following equipment are installed on the emission measurement to meet the commission requirements and operating regulations in a manner which tends to maximize its emission characteristics in normal application.

5.3.1. Mobile Internet Device (EUT)

Model Number : P804
 Serial Number : N/A
 Manufacturer : Pipo Technology Co., Ltd.

5.4. Operating Condition of EUT

5.4.1. Setup the EUT and simulator as shown as Section 5.1.

5.4.2. Turn on the power of all equipment.

5.4.3. Let the EUT work in TX modes measure it. The transmit frequency are 2412-2462 and 2422-2452MHz. We select 2412MHz, 2437MHz, 2462MHz and 2422MHz, 2437MHz, 2452MHz TX frequency to transmit.

5.5. Test Procedure

1. Set resolution bandwidth (RBW) = 1-5% or DTS BW, not to exceed 100 kHz.
2. Set the video bandwidth (VBW) $\geq 3 \times$ RBW.
3. Detector = Peak.
4. Trace mode = max hold.
5. Sweep = auto couple.
6. Allow the trace to stabilize.
7. Measure the maximum width of the emission that is constrained by the frequencies associated with the two outermost amplitude points (upper and lower) that are attenuated by 6 dB relative to the maximum level measured in the fundamental emission.

5.6. Test Result

PASS.

Date of Test:	<u>October 26, 2012</u>	Temperature:	<u>25°C</u>
EUT:	<u>Mobile Internet Device</u>	Humidity:	<u>50%</u>
Model No.:	<u>P804</u>	Power Supply:	<u>AC 120V/60HZ</u>
Test Mode:	<u>TX</u>	Test Engineer:	<u>Pei</u>

The test was performed with 802.11b

Channel	Frequency (MHz)	6dB Bandwidth (MHz)	Limit (MHz)
Low	2412	10.04	> 0.5MHz
Middle	2437	10.04	> 0.5MHz
High	2462	10.08	> 0.5MHz

The test was performed with 802.11g

Channel	Frequency (MHz)	6dB Bandwidth (MHz)	Limit (MHz)
Low	2412	16.28	> 0.5MHz
Middle	2437	16.24	> 0.5MHz
High	2462	16.28	> 0.5MHz

The test was performed with 802.11n (Bandwidth: 20 MHz)			
Channel	Frequency (MHz)	6dB Bandwidth (MHz)	Limit (MHz)
Low	2412	17.32	> 0.5MHz
Middle	2437	17.20	> 0.5MHz
High	2462	17.36	> 0.5MHz

The test was performed with 802.11n (Bandwidth: 40 MHz)			
Channel	Frequency (MHz)	6dB Bandwidth (MHz)	Limit (MHz)
Low	2422	35.76	> 0.5MHz
Middle	2437	35.56	> 0.5MHz
High	2452	35.44	> 0.5MHz

The spectrum analyzer plots are attached as below.

802.11b Channel Low 2412MHz

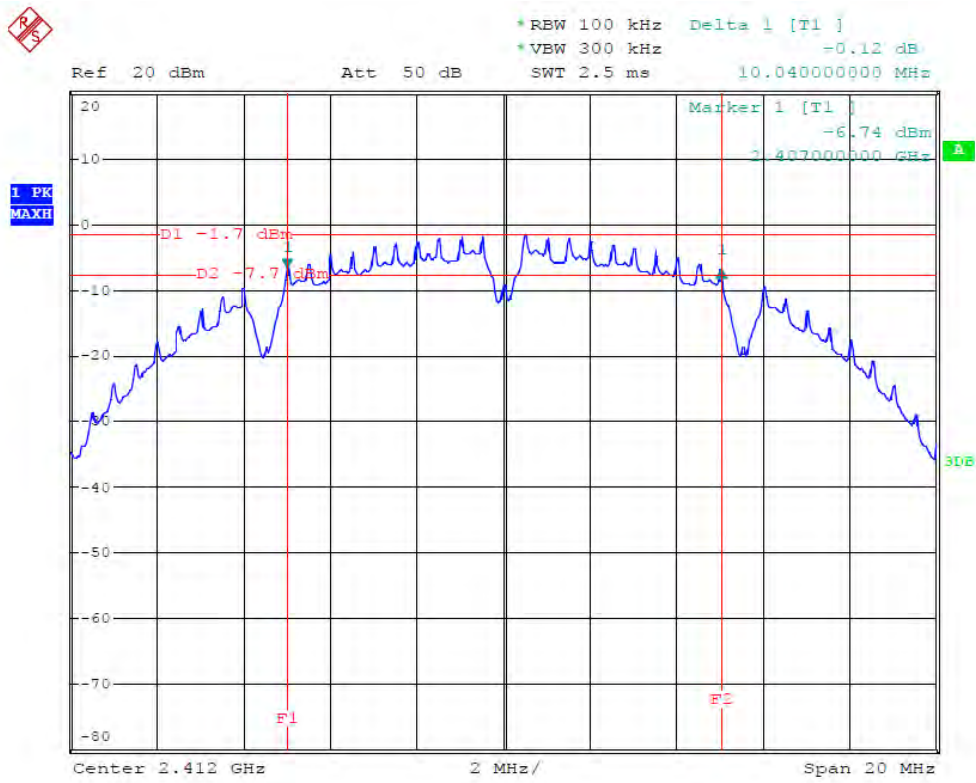

Date: 26.OCT.2012 19:26:04

802.11b Channel Middle 2437MHz

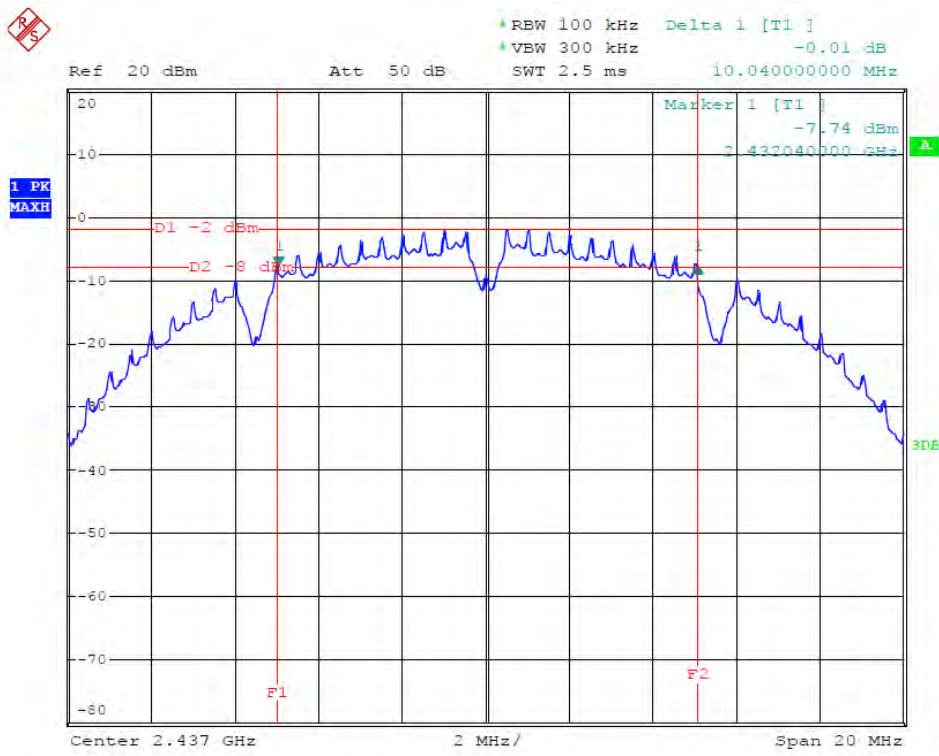

Date: 26.OCT.2012 19:28:12

802.11b Channel High 2462MHz

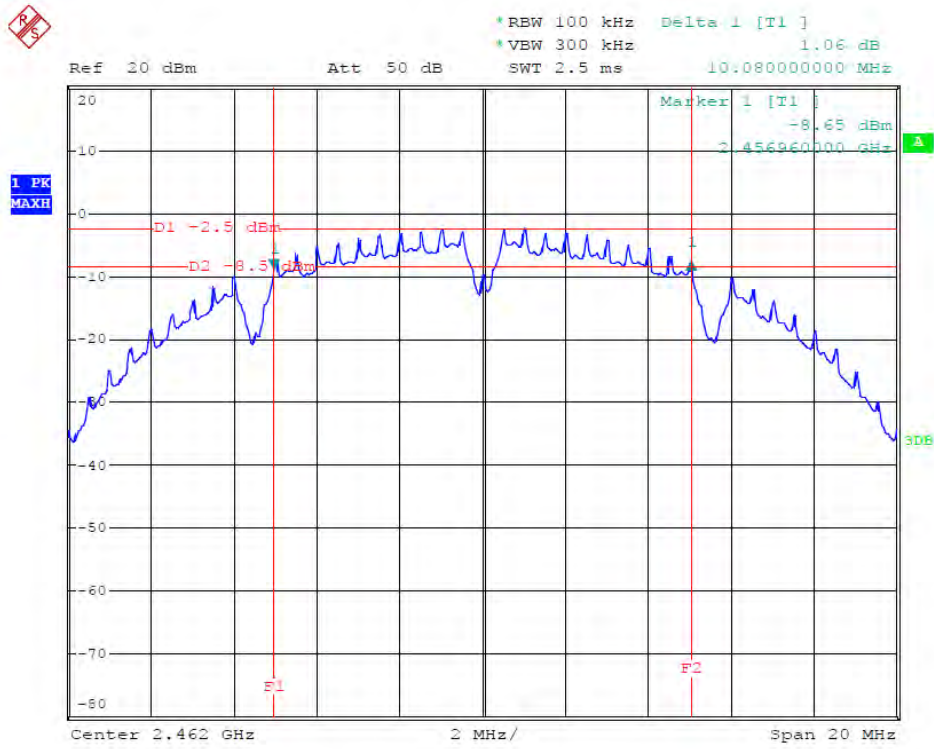

Date: 26.OCT.2012 19:39:13

802.11g Channel Low 2412MHz

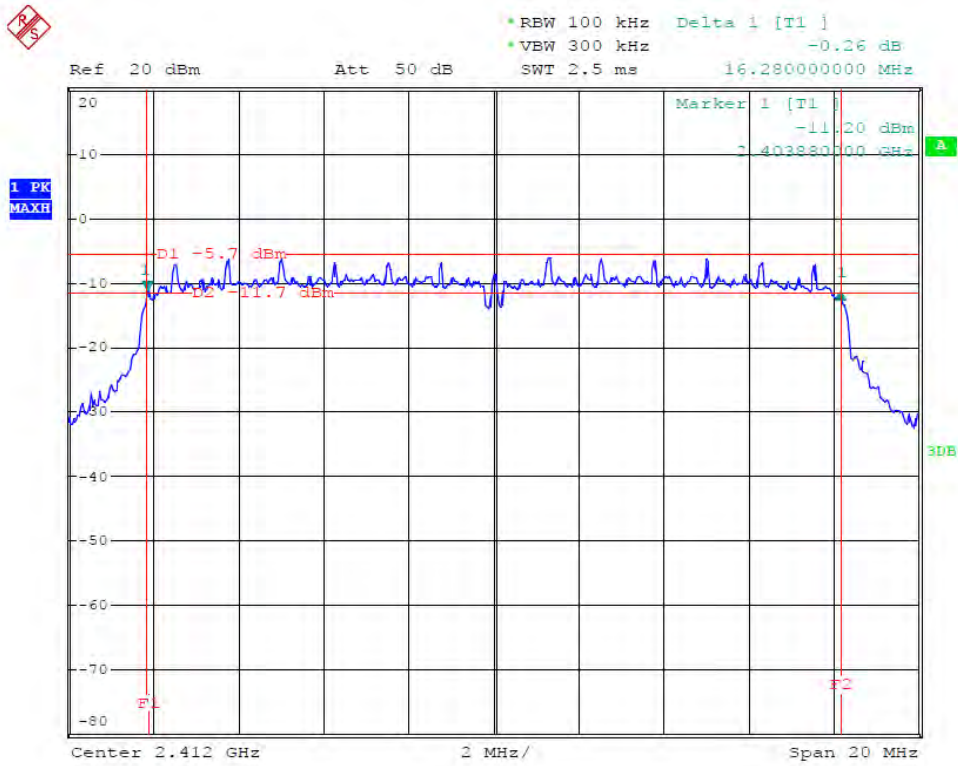

Date: 26.OCT.2012 19:35:47

802.11g Channel Middle 2437MHz

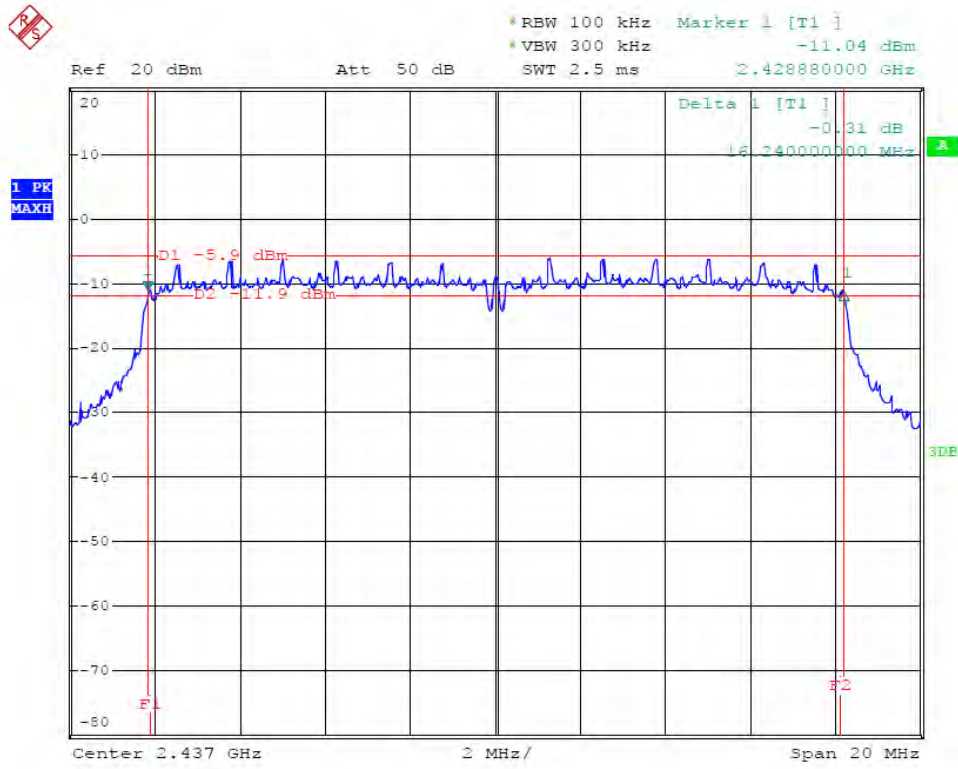

Date: 26.OCT.2012 19:33:51

802.11g Channel High 2462MHz

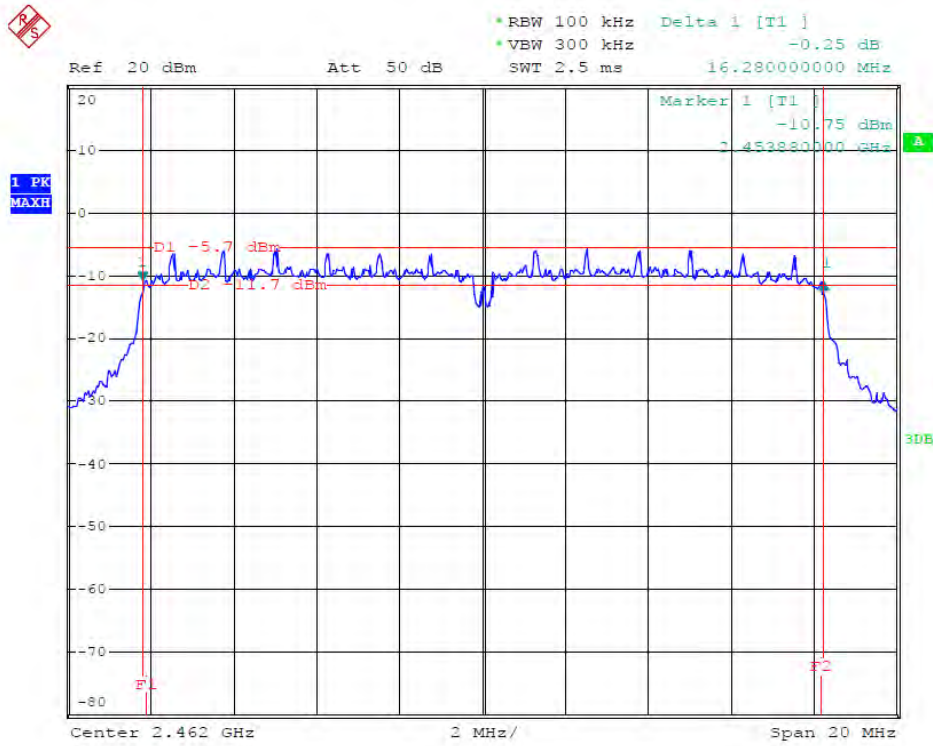

Date: 26.OCT.2012 19:32:26

802.11n Channel Low 2412MHz (20MHz)

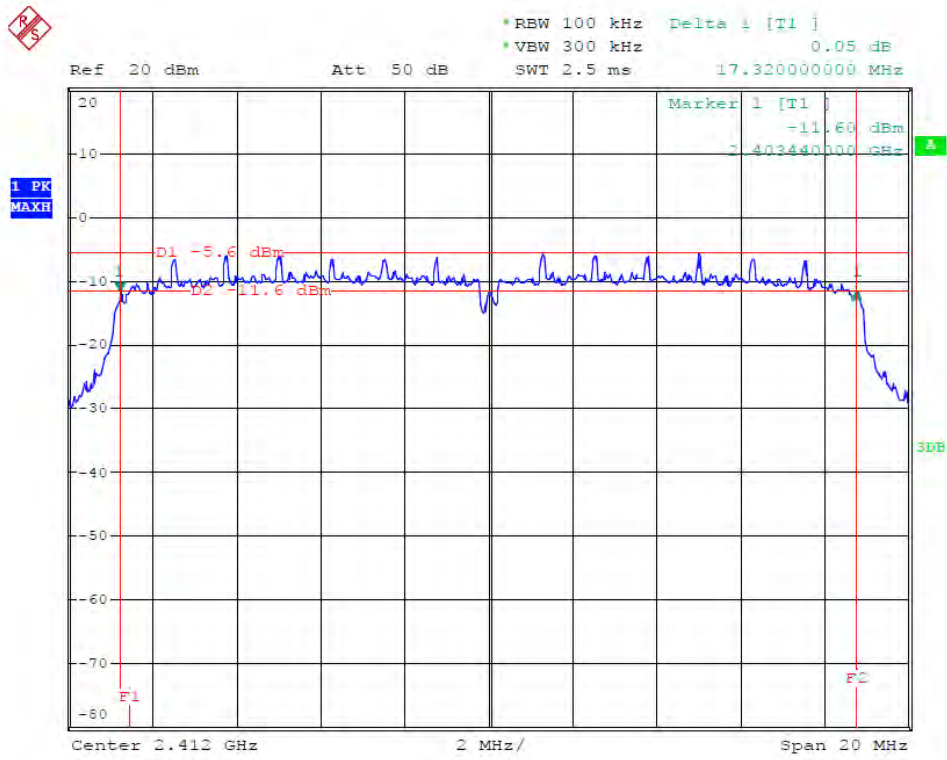

Date: 26.OCT.2012 19:45:32

802.11n Channel Middle 2437MHz(20MHz)

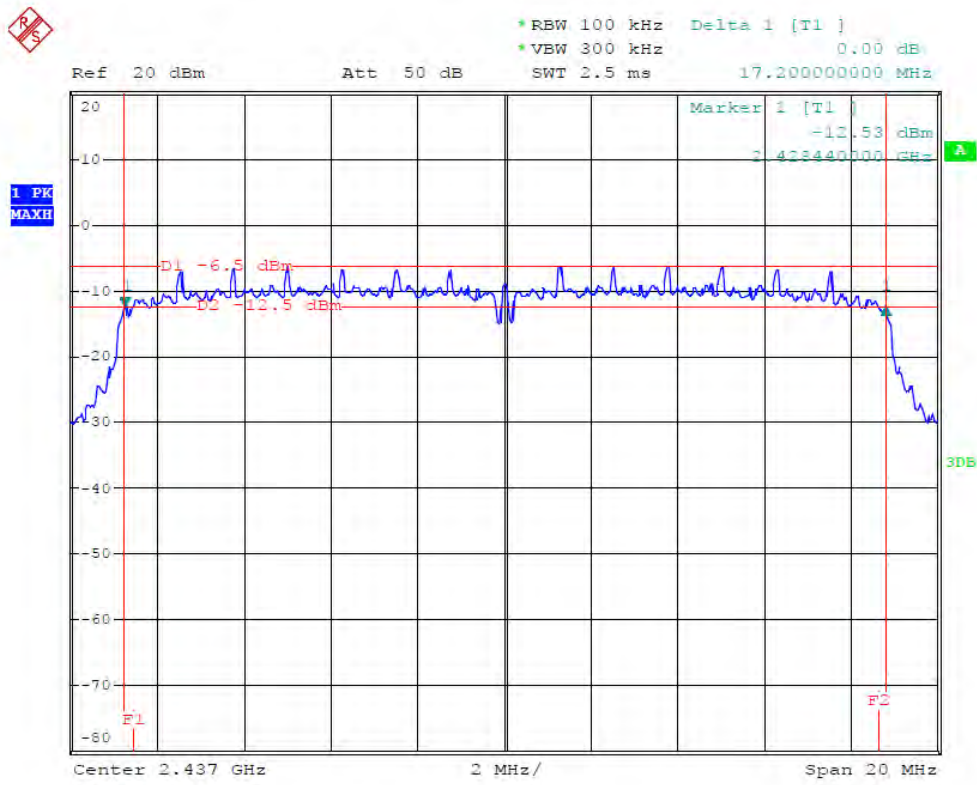

Date: 26.OCT.2012 19:43:00

802.11n Channel High 2462MHz(20MHz)

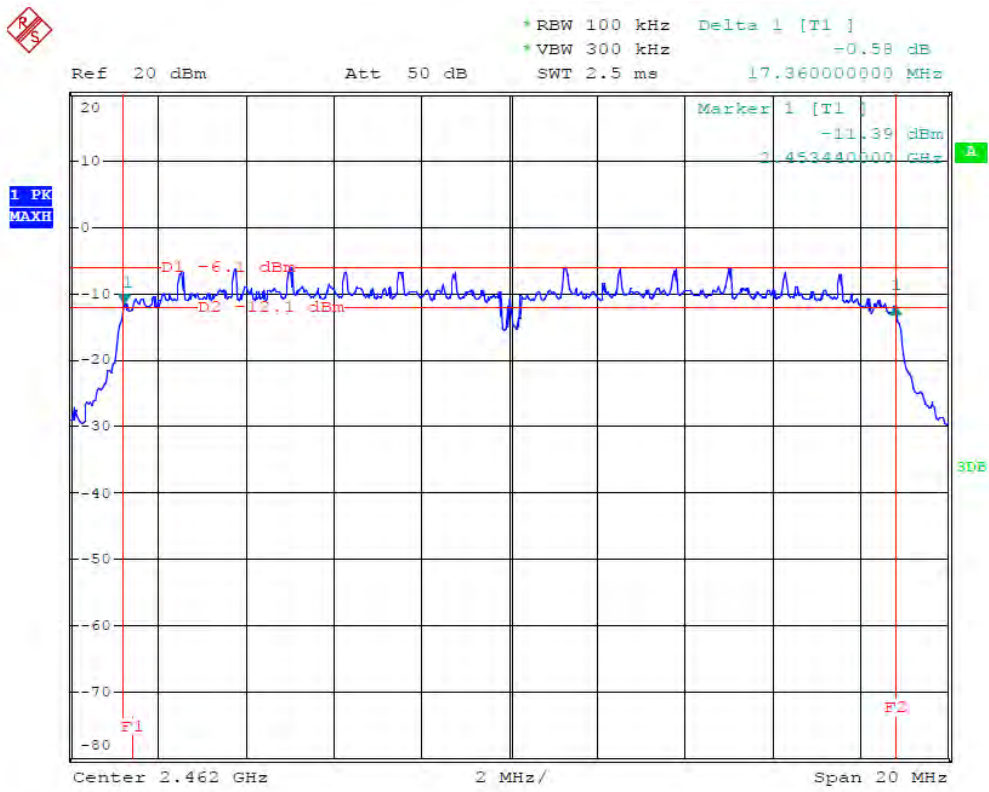

Date: 26.OCT.2012 19:41:47

802.11n Channel Low 2422MHz (40MHz)



Date: 26.OCT.2012 19:18:18

802.11n Channel Middle 2437MHz(40MHz)

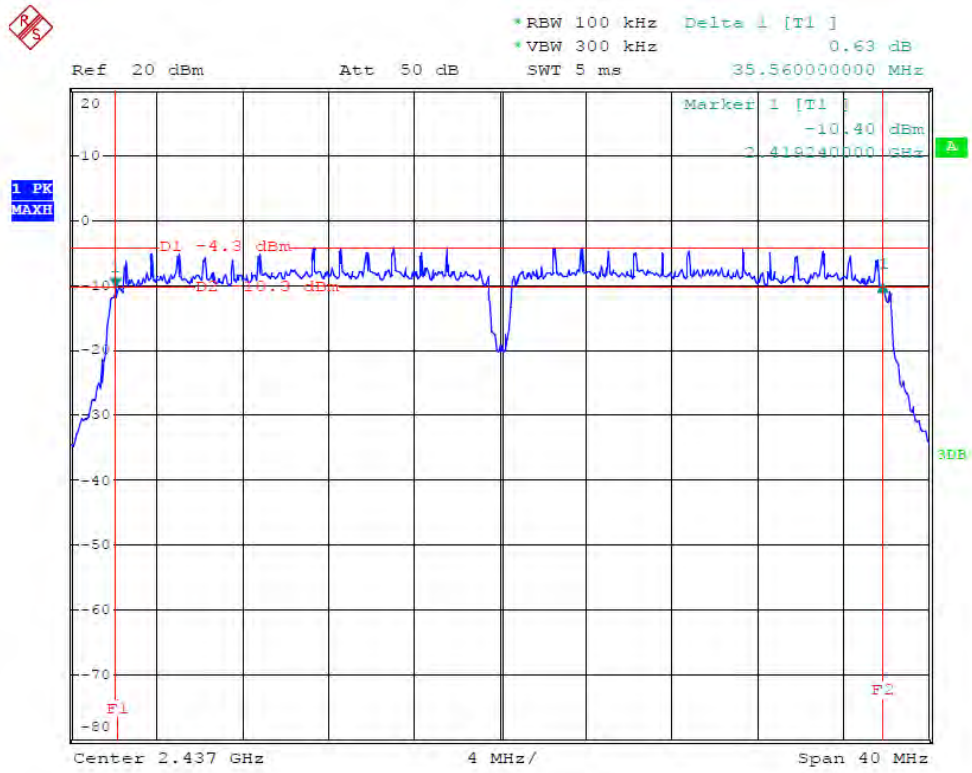

Date: 26.OCT.2012 19:19:57

802.11n Channel High 2452MHz(40MHz)

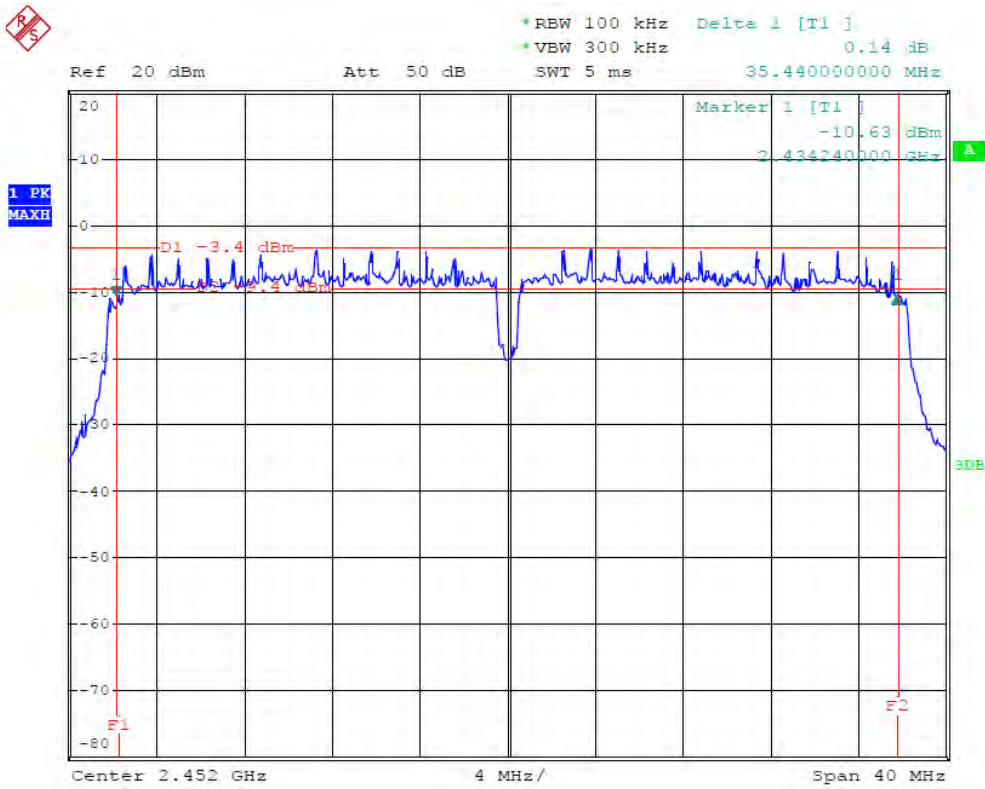

Date: 26.OCT.2012 19:23:57

6. MAXIMUM PEAK OUTPUT POWER

6.1. Block Diagram of Test Setup

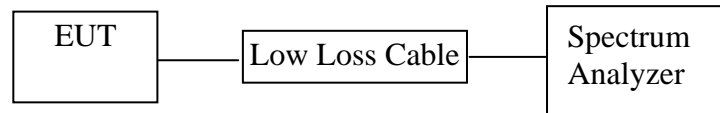

(EUT: Mobile Internet Device)

6.2. The Requirement For Section 15.247(b)(3)

Section 15.247(b)(3): For systems using digital modulation in the 902-928MHz, 2400-2483.5MHz, and 5725-5850MHz bands: 1 Watt.

6.3. EUT Configuration on Measurement

The following equipment are installed on the emission Measurement to meet the commission requirements and operating regulations in a manner which tends to maximize its emission characteristics in normal application.

6.3.1. Mobile Internet Device (EUT)

Model Number : P804
 Serial Number : N/A
 Manufacturer : Pipo Technology Co., Ltd.

6.4. Operating Condition of EUT

6.4.1. Setup the EUT and simulator as shown as Section 6.1.

6.4.2. Turn on the power of all equipment.

6.4.3. Let the EUT work in TX modes measure it. The transmit frequency are 2412-2462 and 2422-2452MHz. We select 2412MHz, 2437MHz, 2462MHz and 2422MHz, 2437MHz, 2452MHz TX frequency to transmit.

6.5. Test Procedure

6.5.1. The EUT was tested according to DTS test procedure of October 04, 2012 KDB558074 D01 DTS Meas Guidance v02 for compliance to FCC 47CFR 15.247 requirements.

6.5.2. The transmitter output was connected to the spectrum analyzer through a low loss cable.

6.5.3. Set RBW of spectrum analyzer to 1MHz and VBW to 3MHz.

6.5.4. Measurement the maximum peak output power.

6.6. Test Result

PASS.

Date of Test:	<u>October 26, 2012</u>	Temperature:	<u>25°C</u>
EUT:	<u>Mobile Internet Device</u>	Humidity:	<u>50%</u>
Model No.:	<u>P804</u>	Power Supply:	<u>AC 120V/60HZ</u>
Test Mode:	<u>TX</u>	Test Engineer:	<u>Pei</u>

The test was performed with 802.11b

Channel	Frequency (MHz)	Peak Output Power (dBm)	Peak Output Power (mW)	Limits dBm / W
Low	2412	9.12	8.17	30 dBm / 1 W
Middle	2437	9.16	8.24	30 dBm / 1 W
High	2462	10.09	10.21	30 dBm / 1 W

The test was performed with 802.11g

Channel	Frequency (MHz)	Peak Output Power (dBm)	Peak Output Power (mW)	Limits dBm / W
Low	2412	10.61	11.51	30 dBm / 1 W
Middle	2437	10.25	10.59	30 dBm / 1 W
High	2462	10.06	10.14	30 dBm / 1 W

The test was performed with 802.11n (20MHz)				
Channel	Frequency (MHz)	Peak Output Power (dBm)	Peak Output Power (mW)	Limits dBm / W
Low	2412	10.32	10.76	30 dBm / 1 W
Middle	2437	10.29	10.69	30 dBm / 1 W
High	2462	9.93	9.84	30 dBm / 1 W

The test was performed with 802.11n (40MHz)				
Channel	Frequency (MHz)	Peak Output Power (dBm)	Peak Output Power (mW)	Limits dBm / W
Low	2422	10.83	12.11	30 dBm / 1 W
Middle	2437	10.54	11.32	30 dBm / 1 W
High	2452	10.60	11.48	30 dBm / 1 W

The spectrum analyzer plots are attached as below.

802.11b Channel Low 2412MHz

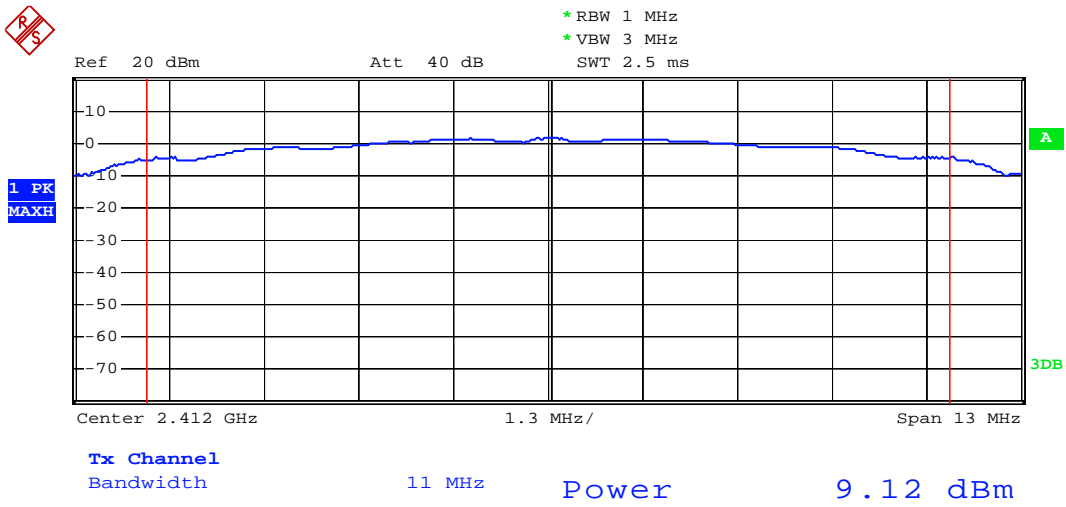

Date: 26.OCT.2012 19:47:43

802.11b Channel Middle 2437MHz

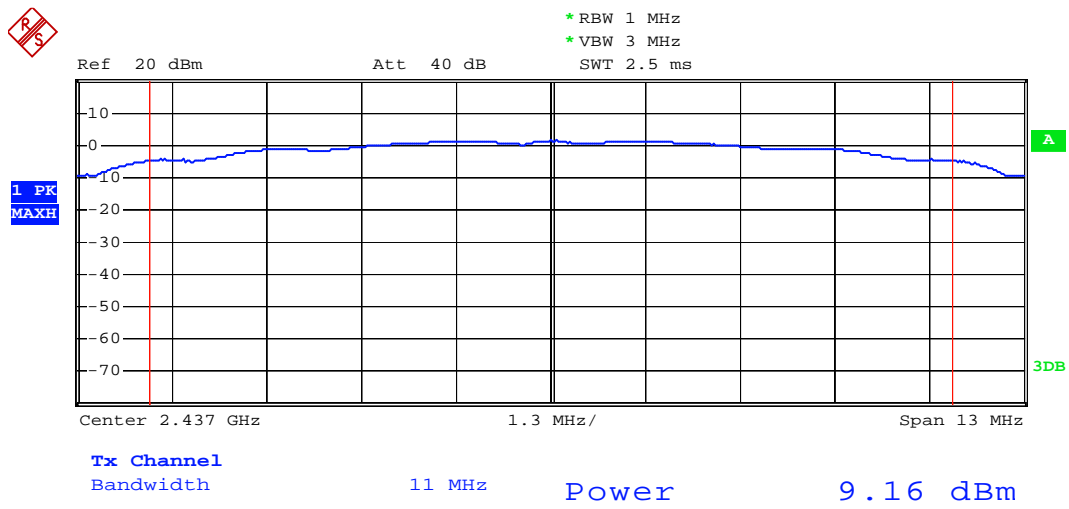

Date: 26.OCT.2012 19:48:08

802.11b Channel High 2462MHz

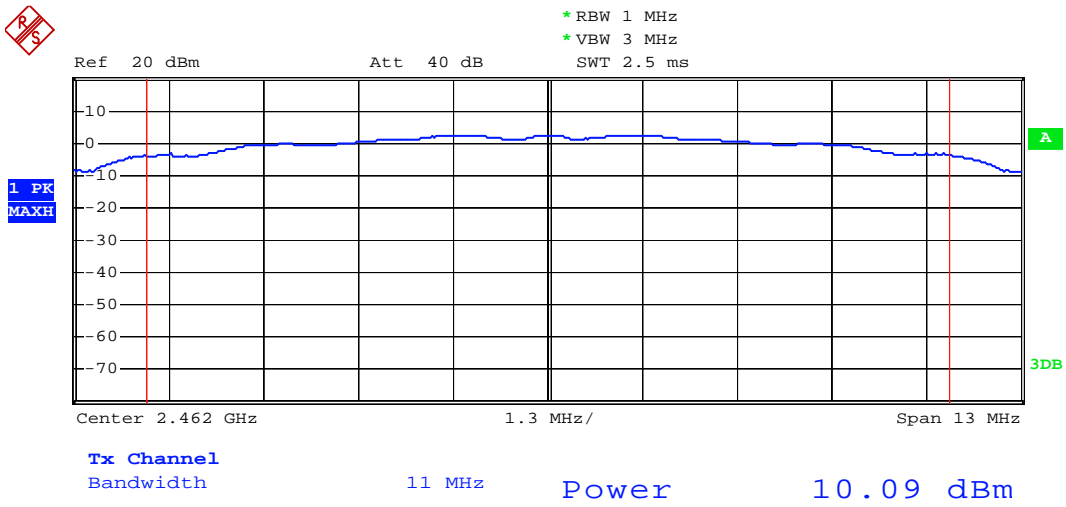

Date: 26.OCT.2012 19:48:33

802.11g Channel Low 2412MHz

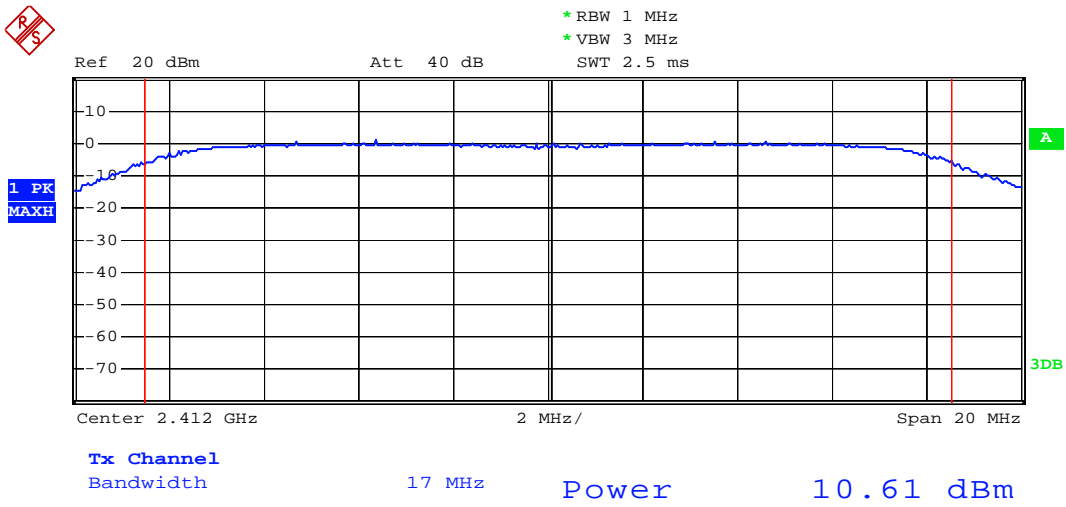

Date: 26.OCT.2012 19:52:13

802.11g Channel Middle 2437MHz

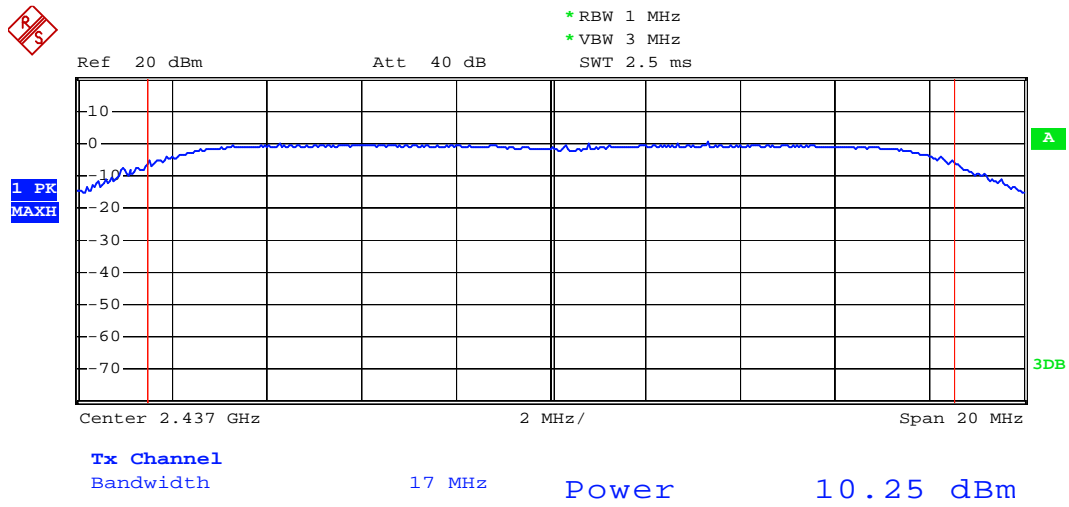

Date: 26.OCT.2012 19:50:48

802.11g Channel High 2462MHz

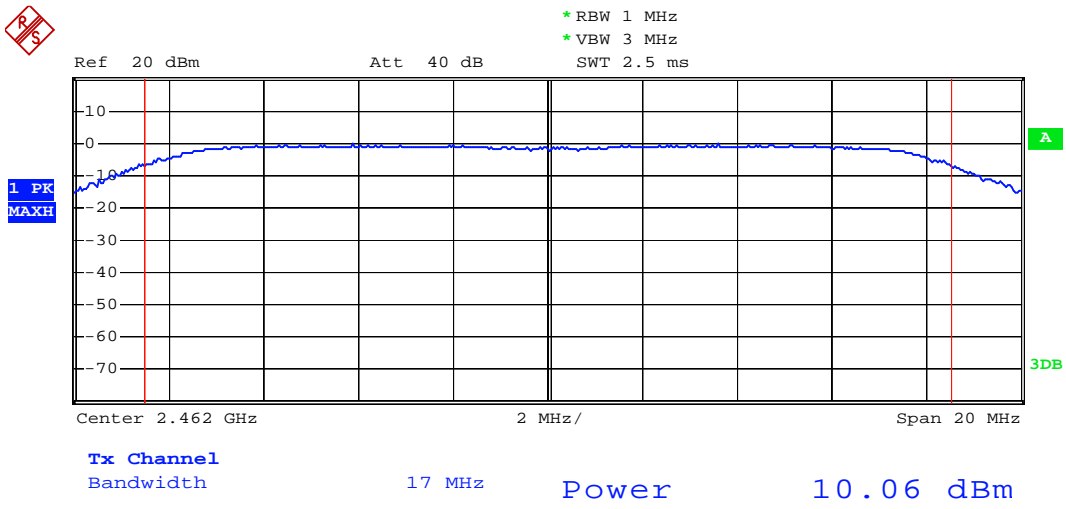

Date: 26.OCT.2012 19:50:23

802.11n Channel Low 2412MHz (20MHz)

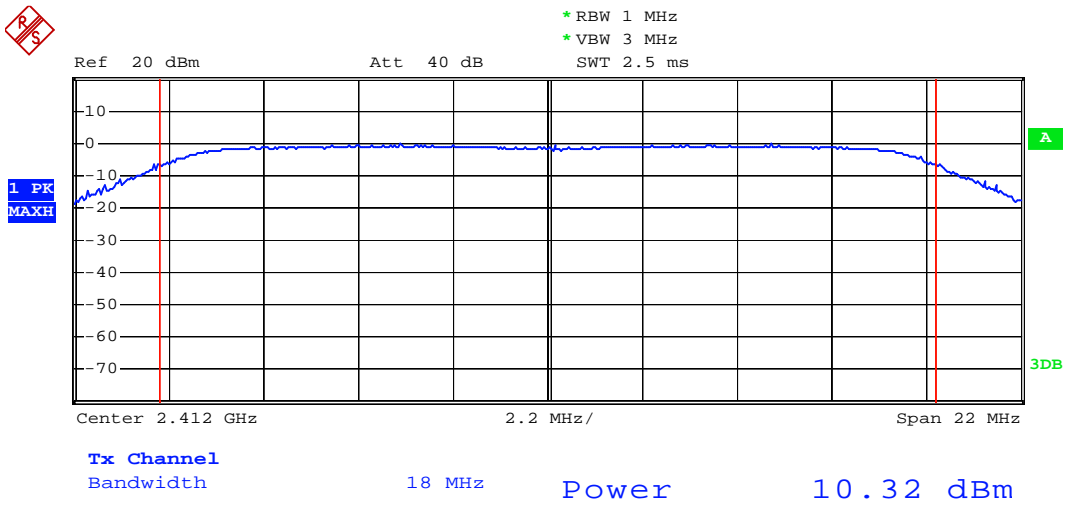

Date: 26.OCT.2012 19:53:27

802.11n Channel Middle 2437MHz (20MHz)

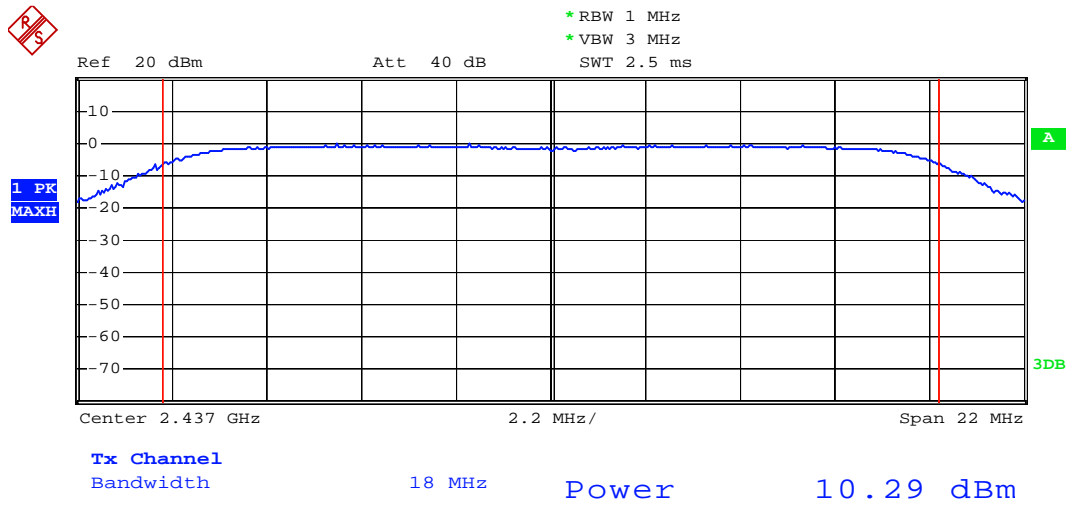

Date: 26.OCT.2012 19:54:07

802.11n Channel High 2462MHz (20MHz)

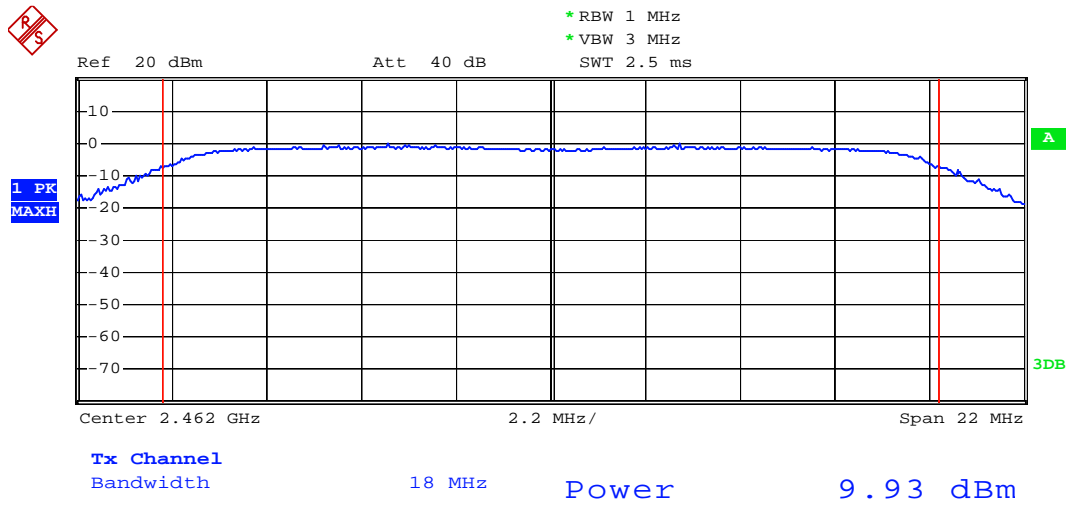

Date: 26.OCT.2012 19:54:43

802.11n Channel Low 2422MHz (40MHz)

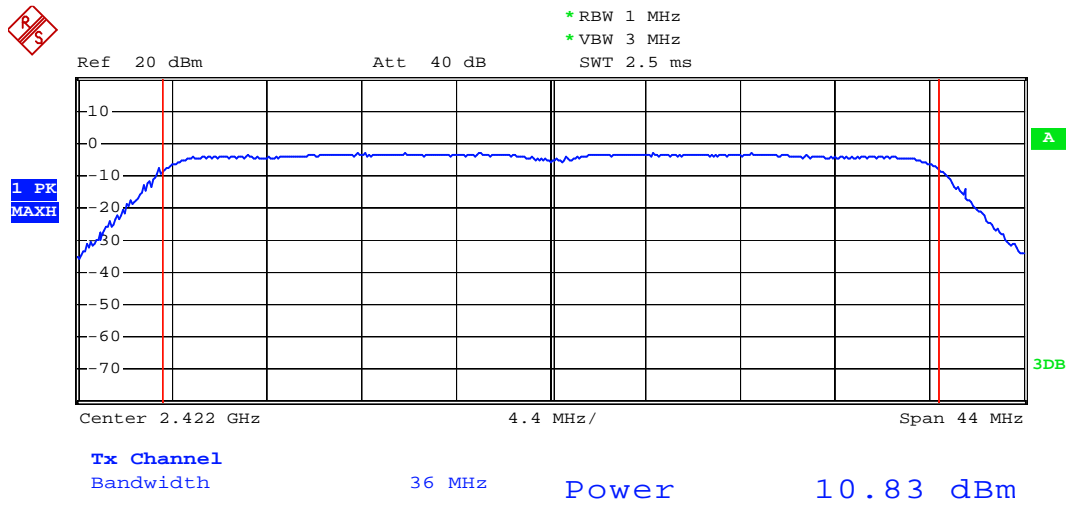

Date: 26.OCT.2012 19:56:02

802.11n Channel Middle 2437MHz (40MHz)

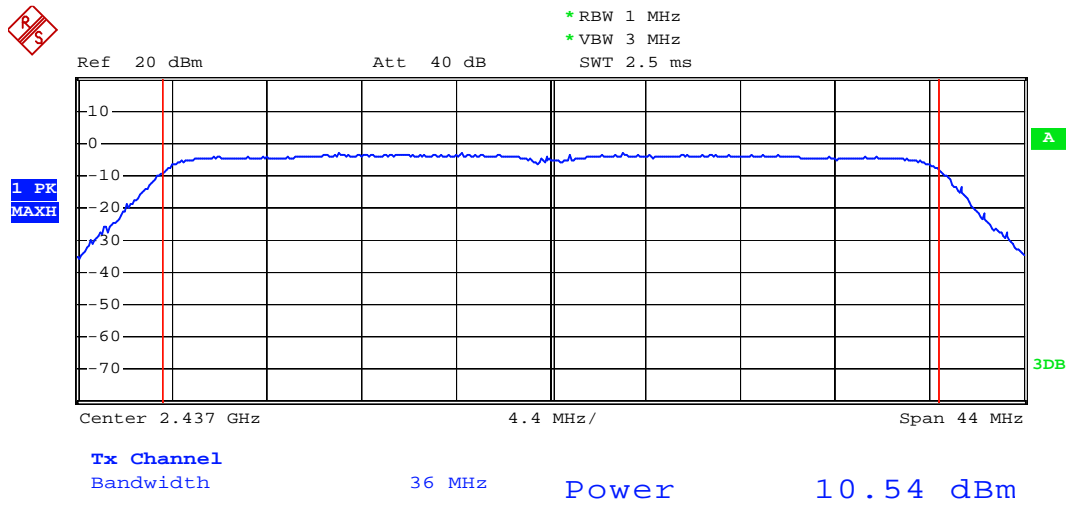

Date: 26.OCT.2012 19:56:33

802.11n Channel High 2452MHz (40MHz)

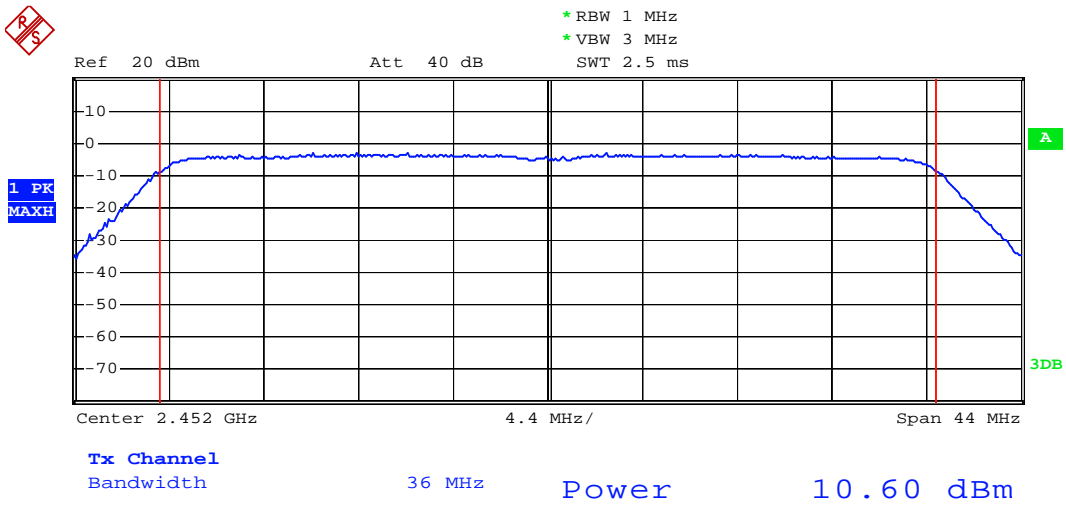

Date: 26.OCT.2012 19:58:05

7. POWER SPECTRAL DENSITY MEASUREMENT

7.1. Block Diagram of Test Setup



(EUT: Mobile Internet Device)

7.2. The Requirement For Section 15.247(e)

Section 15.247(e): For digitally modulated systems, the power spectral density conducted from the intentional radiator to the antenna shall not be greater than 8 dBm in any 3 kHz band during any time interval of continuous transmission.

7.3. EUT Configuration on Measurement

The following equipment are installed on the emission Measurement to meet the commission requirements and operating regulations in a manner which tends to maximize its emission characteristics in normal application.

7.3.1. Mobile Internet Device (EUT)

Model Number : P804
 Serial Number : N/A
 Manufacturer : Pipo Technology Co., Ltd.

7.4. Operating Condition of EUT

7.4.1. Setup the EUT and simulator as shown as Section 7.1.

7.4.2. Turn on the power of all equipment.

7.4.3. Let the EUT work in TX modes measure it. The transmit frequency are 2412-2462 and 2422-2452MHz. We select 2412MHz, 2437MHz, 2462MHz and 2422MHz, 2437MHz, 2452MHz TX frequency to transmit.

7.5. Test Procedure

7.5.1. The EUT was tested according to DTS test procedure of October 04, 2012 KDB558074 D01 DTS Meas Guidance v02 for compliance to FCC 47CFR 15.247 requirements.

7.5.2. The transmitter output was connected to the spectrum analyzer through a low loss cable.

7.5.3. Measurement Procedure PK PSD:

This procedure must be used if maximum peak conducted output power was used to demonstrate compliance to the fundamental output power limit, and is optional if the maximum (average) conducted output power was used to demonstrate compliance.

1. Set analyzer center frequency to DTS channel center frequency.
2. Set the span to 1.5 times the DTS channel bandwidth.
3. Set the RBW \geq 3 kHz.
4. Set the VBW \geq 3 x RBW.
5. Detector = peak.
6. Sweep time = auto couple.
7. Trace mode = max hold.
8. Allow trace to fully stabilize.
9. Use the peak marker function to determine the maximum amplitude level.
10. If measured value exceeds limit, reduce RBW (no less than 3 kHz) and repeat.

7.5.4. Measurement the maximum power spectral density.

7.6. Test Result

PASS.

Date of Test:	<u>October 26, 2012</u>	Temperature:	<u>25°C</u>
EUT:	<u>Mobile Internet Device</u>	Humidity:	<u>50%</u>
Model No.:	<u>P804</u>	Power Supply:	<u>AC 120V/60HZ</u>
Test Mode:	<u>TX</u>	Test Engineer:	<u>Pei</u>

The test was performed with 802.11b

Channel	Frequency (MHz)	Power Spectral Density (dBm)	Limits (dBm)
Low	2412	-14.58	8 dBm
Middle	2437	-16.17	8 dBm
High	2462	-16.43	8 dBm

The test was performed with 802.11g

Channel	Frequency (MHz)	Power Spectral Density (dBm)	Limits (dBm)
Low	2412	-22.15	8 dBm
Middle	2437	-21.79	8 dBm
High	2462	-22.24	8 dBm

The test was performed with 802.11n (20MHz)

Channel	Frequency (MHz)	Power Spectral Density (dBm)	Limits (dBm)
Low	2412	-22.35	8 dBm
Middle	2437	-24.57	8 dBm
High	2462	-24.46	8 dBm

The test was performed with 802.11n (40MHz)

Channel	Frequency (MHz)	Power Spectral Density (dBm)	Limits (dBm)
Low	2422	-26.17	8 dBm
Middle	2437	-26.51	8 dBm
High	2452	-26.42	8 dBm

The spectrum analyzer plots are attached as below.

802.11b Channel Low 2412MHz

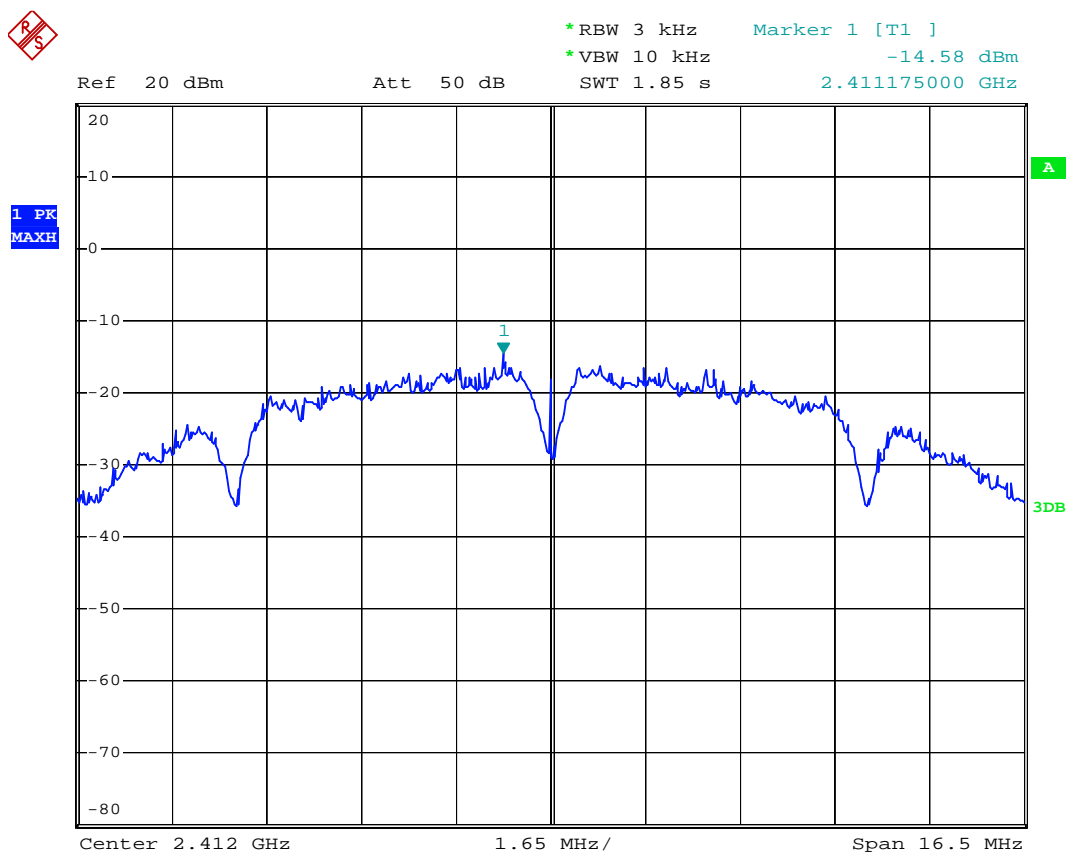

Date: 26.OCT.2012 20:06:10

802.11b Channel Middle 2437MHz

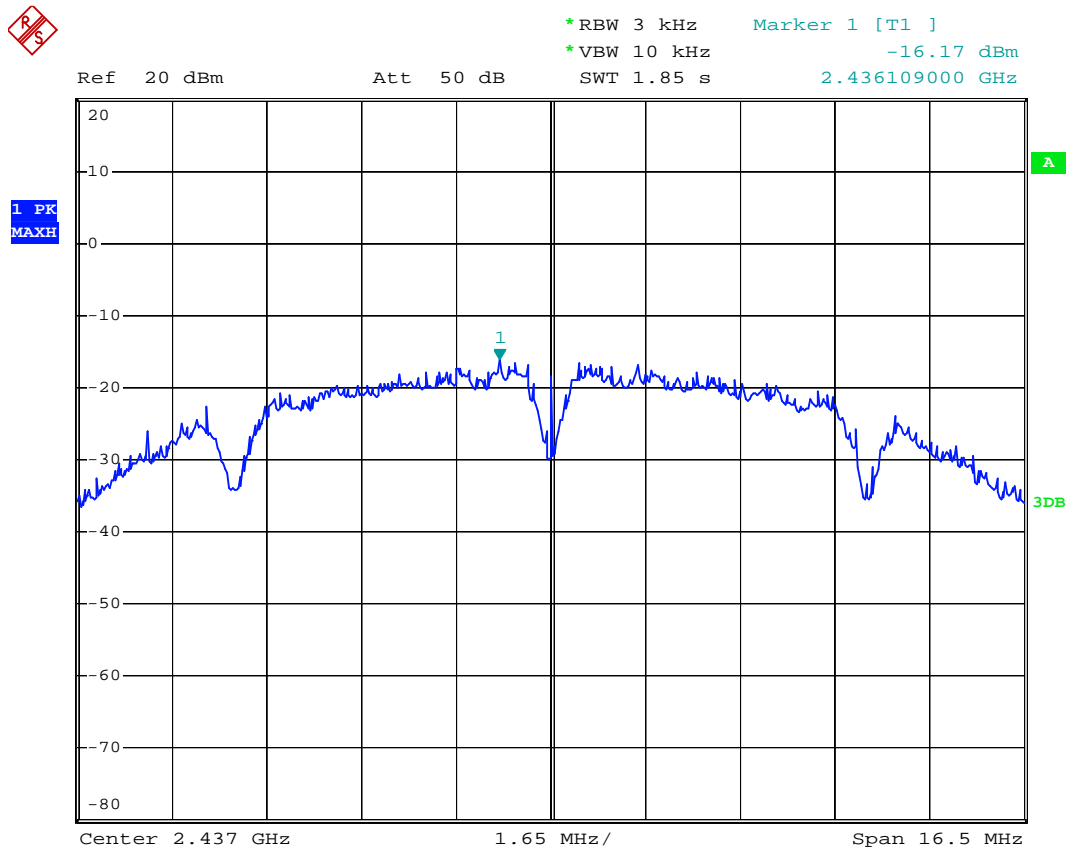

Date: 26.OCT.2012 20:07:40

802.11b Channel High 2462MHz

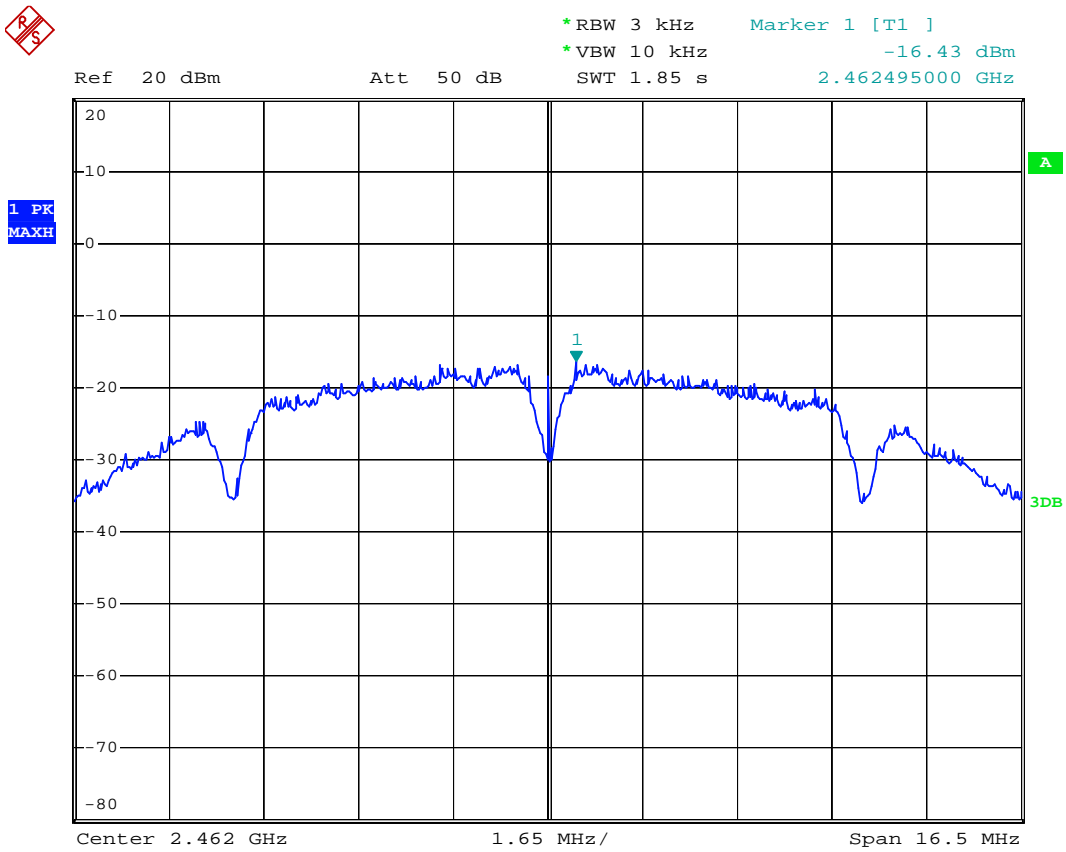

Date: 26.OCT.2012 20:11:56

802.11g Channel Low 2412MHz



*RBW 3 kHz Marker 1 [T1]
*VBW 10 kHz -22.15 dBm
SWT 2.9 s 2.418273000 GHz

Ref 20 dBm

Att 50 dB

1 PK
MAXH

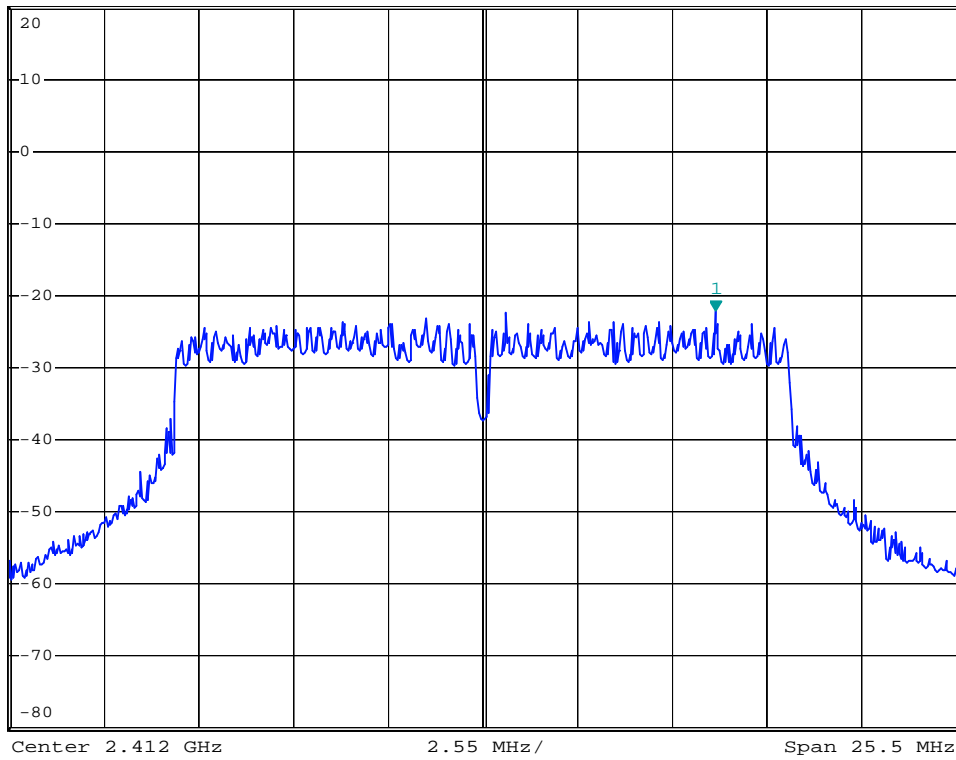

Date: 26.OCT.2012 20:18:11

802.11g Channel Middle 2437MHz



*RBW 3 kHz Marker 1 [T1]
*VBW 10 kHz -21.79 dBm
SWT 2.9 s 2.442661000 GHz

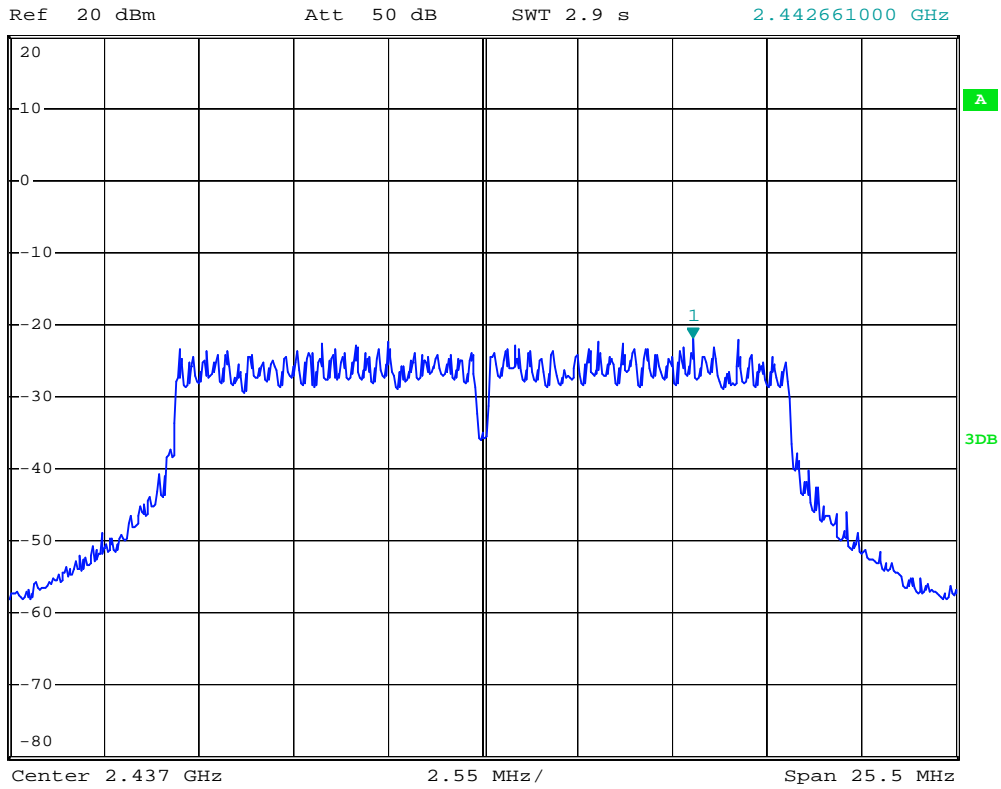

Date: 26.OCT.2012 20:17:26

802.11g Channel High 2462MHz



*RBW 3 kHz Marker 1 [T1]
*VBW 10 kHz -22.24 dBm
SWT 2.9 s 2.457002000 GHz

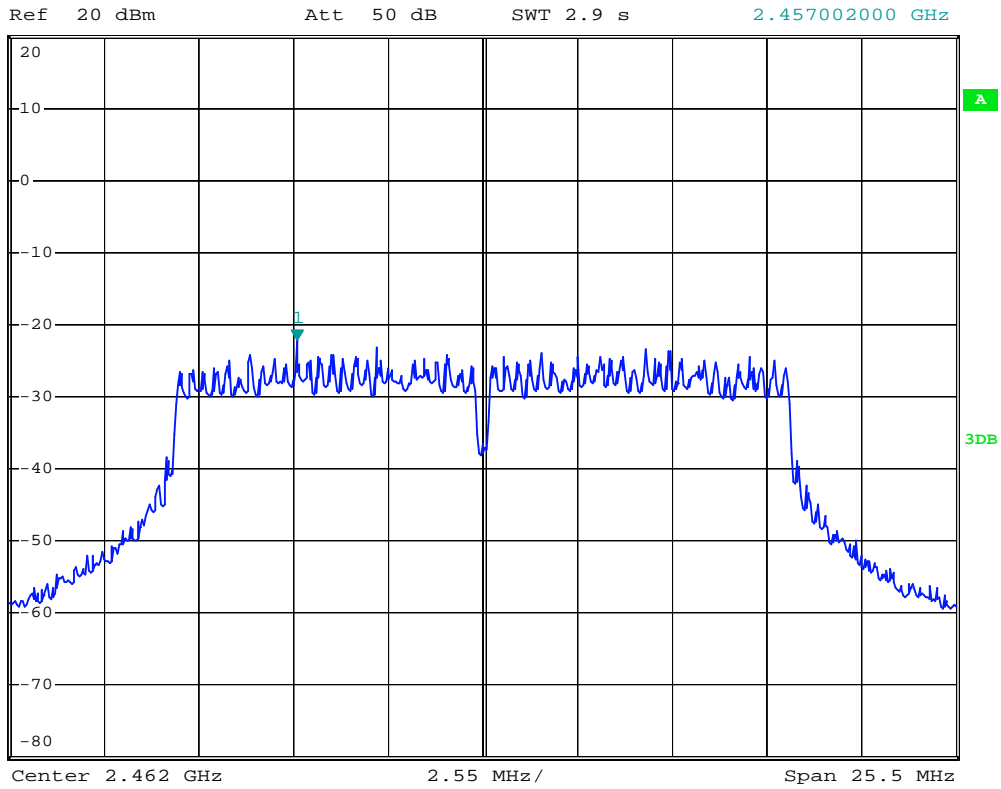

Date: 26.OCT.2012 20:15:52

802.11n Channel Low 2412MHz (20MHz)

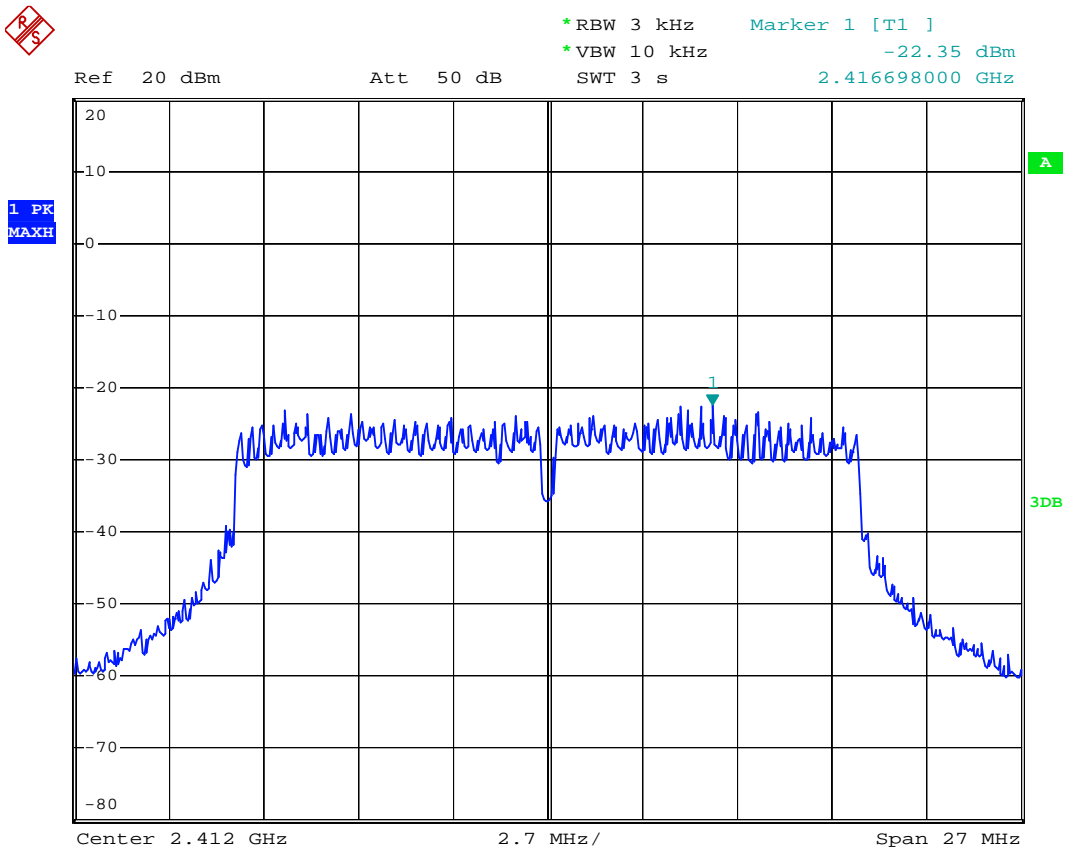

Date: 26.OCT.2012 20:20:09

802.11n Channel Middle 2437MHz (20MHz)

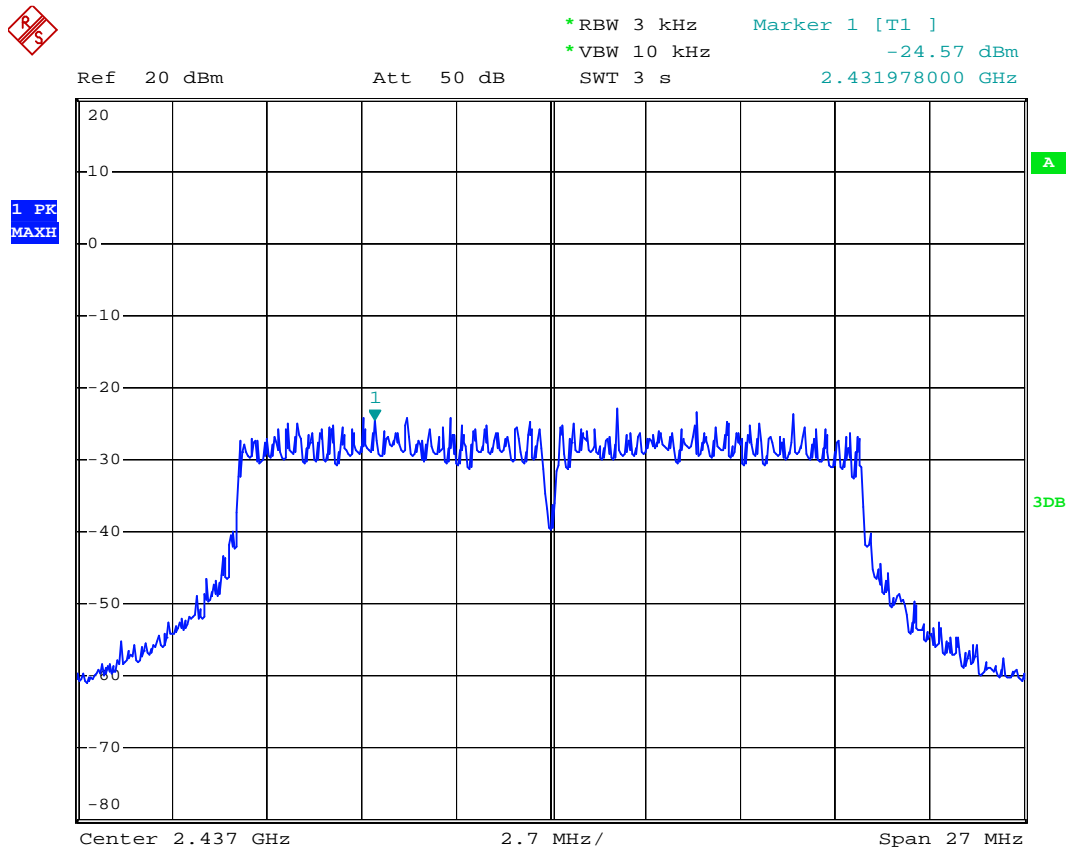

Date: 26.OCT.2012 20:20:36

802.11n Channel High 2462MHz(20MHz)

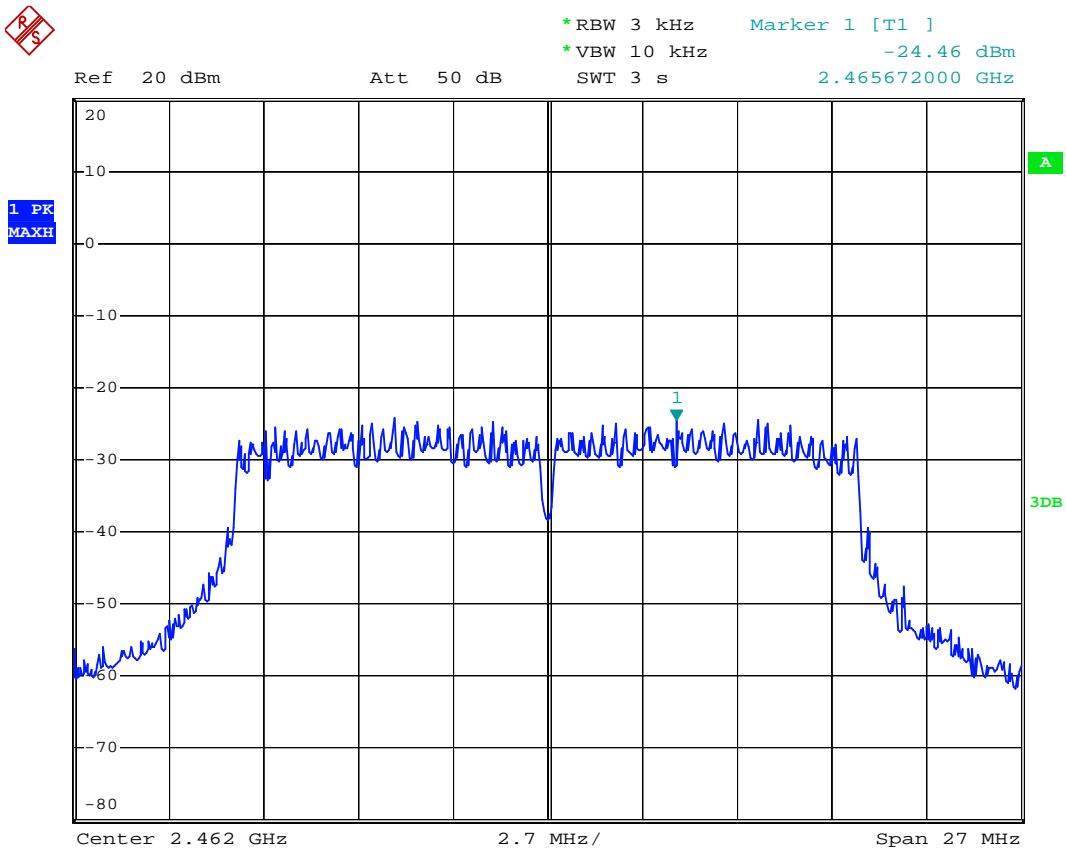

Date: 26.OCT.2012 20:24:14

802.11n Channel Low 2422MHz (40MHz)

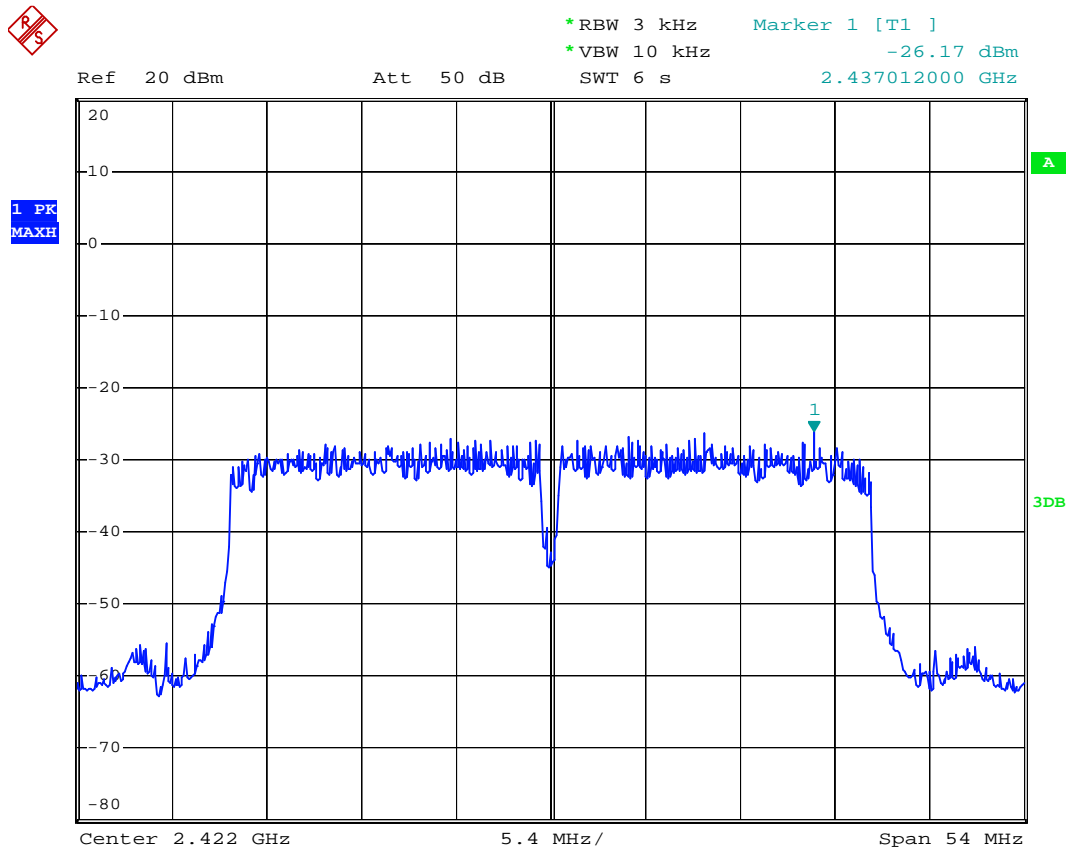

Date: 26.OCT.2012 20:03:51

802.11n Channel Middle 2437MHz(40MHz)

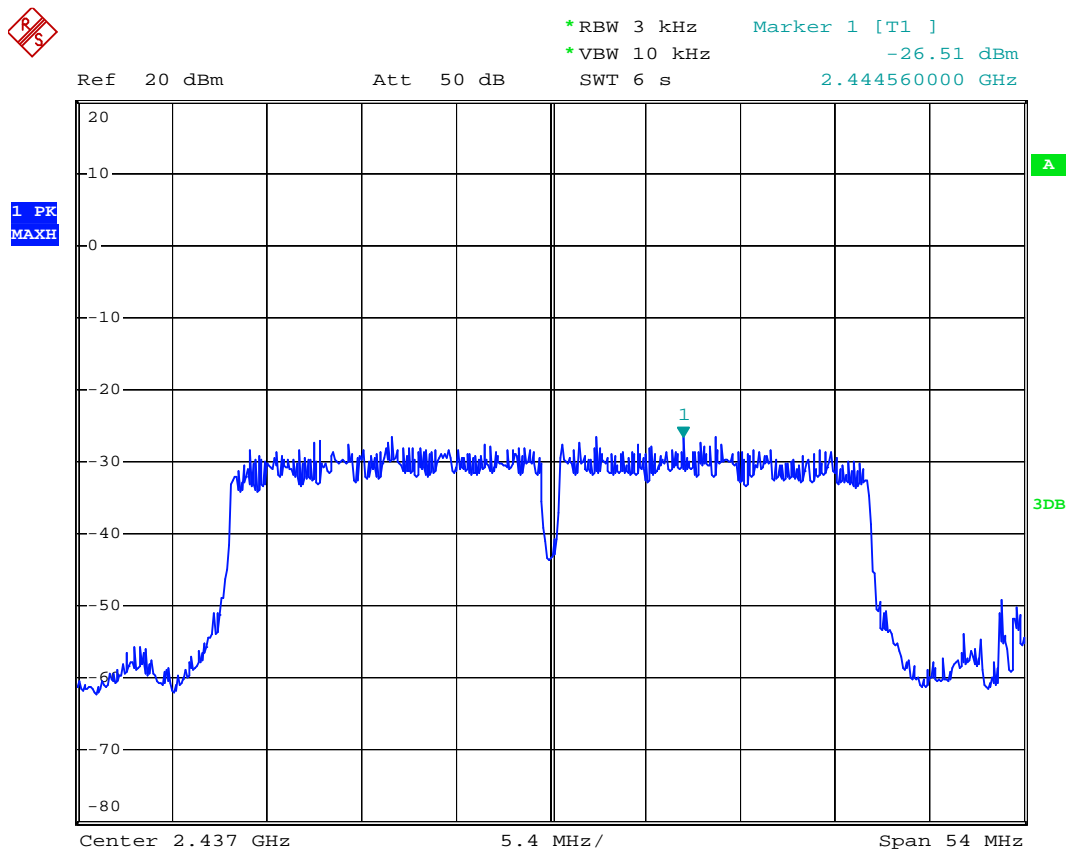

Date: 26.OCT.2012 20:03:09

802.11n Channel High 2452MHz(40MHz)

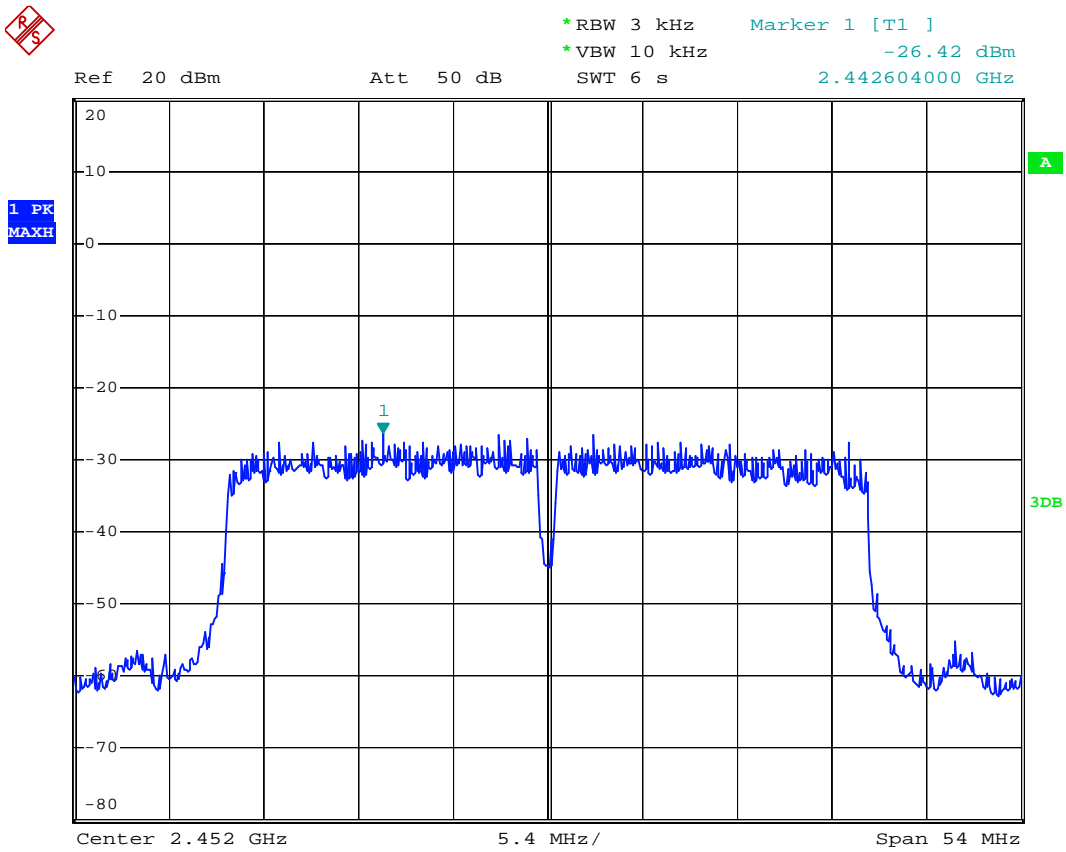

Date: 26.OCT.2012 20:02:23

8. BAND EDGE COMPLIANCE TEST

8.1. Block Diagram of Test Setup



(EUT: Mobile Internet Device)

8.2. The Requirement For Section 15.247(d)

Section 15.247(d): In any 100 kHz bandwidth outside the frequency band in which the spread spectrum or digitally modulated intentional radiator is operating, the radio frequency power that is produced by the intentional radiator shall be at least 20 dB below that in the 100 kHz bandwidth within the band that contains the highest level of the desired power, based on either an RF conducted or a radiated measurement, provided the transmitter demonstrates compliance with the peak conducted power limits. If the transmitter complies with the conducted power limits based on the use of RMS averaging over a time interval, as permitted under paragraph (b)(3) of this section, the attenuation required under this paragraph shall be 30 dB instead of 20 dB. Attenuation below the general limits specified in Section 15.209(a) is not required. In addition, radiated emissions which fall in the restricted bands, as defined in Section 15.205(a), must also comply with the radiated emission limits specified in Section 15.209(a).

8.3. EUT Configuration on Measurement

The following equipment are installed on the emission Measurement to meet the commission requirements and operating regulations in a manner which tends to maximize its emission characteristics in normal application.

8.3.1. Mobile Internet Device (EUT)

Model Number : P804
 Serial Number : N/A
 Manufacturer : Pipo Technology Co., Ltd.

8.4. Operating Condition of EUT

8.4.1. Setup the EUT and simulator as shown as Section 8.1.

8.4.2. Turn on the power of all equipment.

8.4.3. Let the EUT work in TX modes measure it. The transmit frequency are 2412-2462 and 2422-2452MHz MHz. We select 2412MHz, 2462MHz and 2422MHz, 2452MHz TX frequency to transmit.

8.5. Test Procedure

Conducted Band Edge:

8.5.1. The transmitter output was connected to the spectrum analyzer via a low loss cable.

8.5.2. Set RBW of spectrum analyzer to 100kHz and VBW to 300kHz.

Radiate Band Edge:

8.5.3. The EUT is placed on a turntable, which is 0.8m above the ground plane and worked at highest radiated power.

8.5.4. The turntable was rotated for 360 degrees to determine the position of maximum emission level.

8.5.5. EUT is set 3m away from the receiving antenna, which is varied from 1m to 4m to find out the highest emission.

8.5.6. Set the spectrum analyzer in the following setting in order to capture the lower and upper band-edges of the emission:

RBW=1MHz, VBW=1MHz

8.5.7. The band edges was measured and recorded.

8.6. Test Result

Pass**Conducted test**

Date of Test:	<u>October 26, 2012</u>	Temperature:	<u>25°C</u>
EUT:	<u>Mobile Internet Device</u>	Humidity:	<u>50%</u>
Model No.:	<u>P804</u>	Power Supply:	<u>AC 120V/60HZ</u>
Test Mode:	<u>TX</u>	Test Engineer:	<u>Pei</u>

The test was performed with 802.11b

Frequency (MHz)	Result of Band Edge (dBc)	Limit of Band Edge (dBc)
2412	39.02	> 20dBc
2462	40.49	> 20dBc

The test was performed with 802.11g

Frequency (MHz)	Result of Band Edge (dBc)	Limit of Band Edge (dBc)
2412	36.97	> 20dBc
2462	39.94	> 20dBc

The test was performed with 802.11n (20MHz)

Frequency (MHz)	Result of Band Edge (dBc)	Limit of Band Edge (dBc)
2412	34.18	> 20dBc
2462	39.97	> 20dBc

The test was performed with 802.11n (40MHz)

Frequency (MHz)	Result of Band Edge (dBc)	Limit of Band Edge (dBc)
2422	29.98	> 20dBc
2452	38.07	> 20dBc

802.11b Channel Low 2412MHz

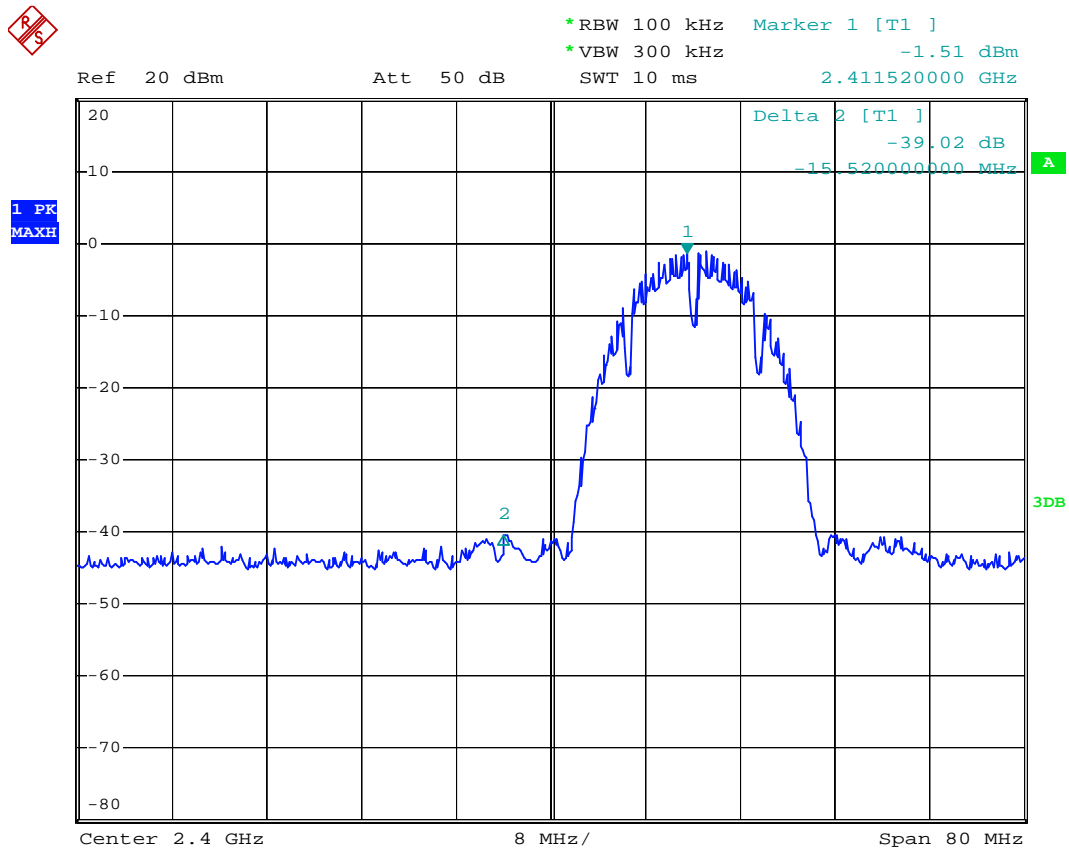

Date: 26.OCT.2012 19:05:59

802.11b Channel High 2462MHz



*RBW 100 kHz Marker 1 [T1]
*VBW 300 kHz -1.52 dBm
SWT 10 ms 2.462540000 GHz

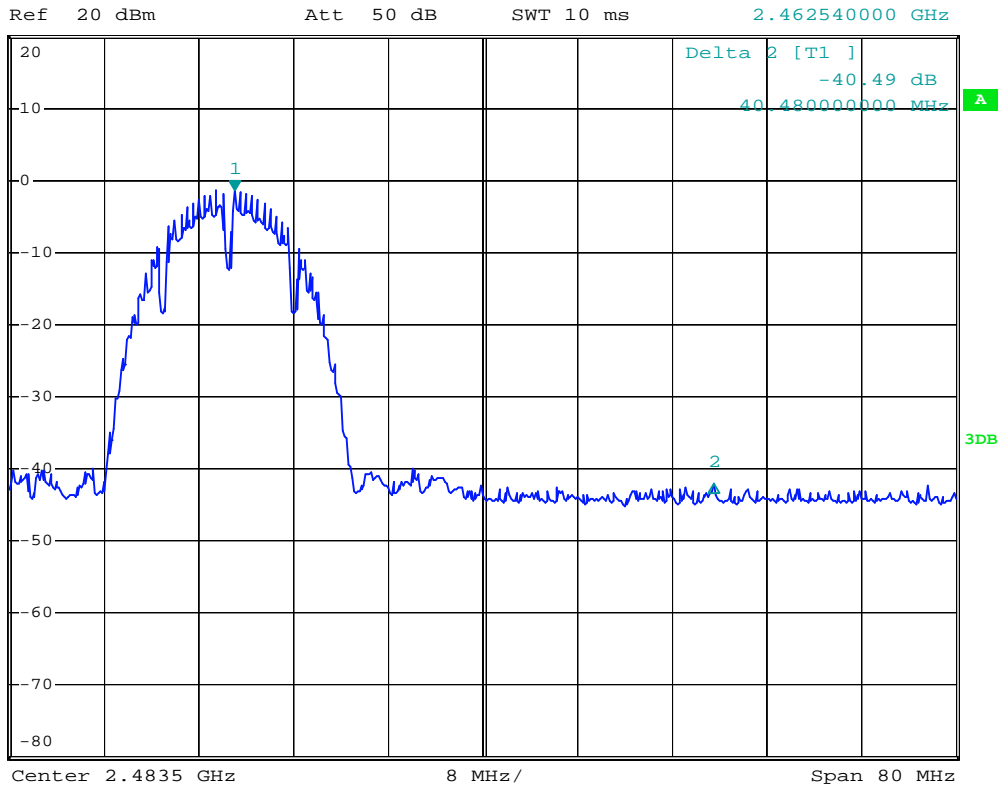

Date: 26.OCT.2012 19:07:03

802.11g Channel Low 2412MHz

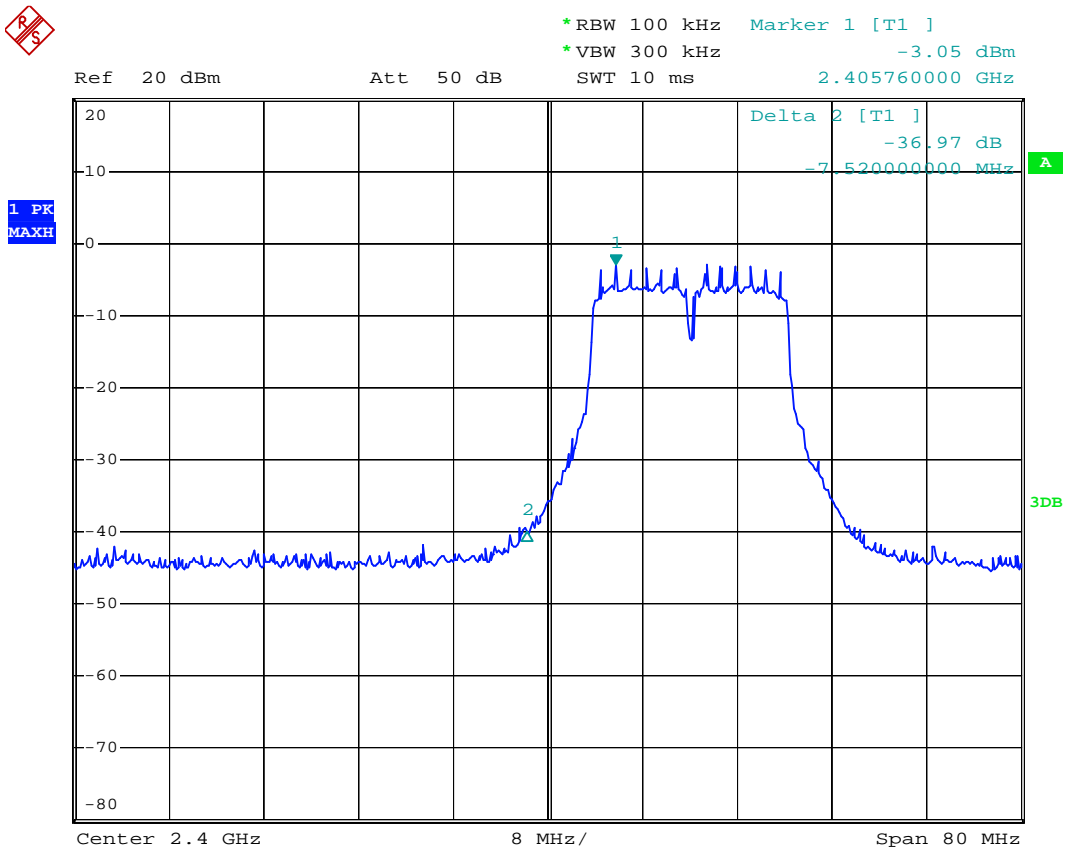

Date: 26.OCT.2012 19:09:46

802.11g Channel High 2462MHz



*RBW 100 kHz Delta 2 [T1]
*VBW 300 kHz -39.94 dB
SWT 10 ms 23.68000000 MHz

Ref 20 dBm Att 50 dB

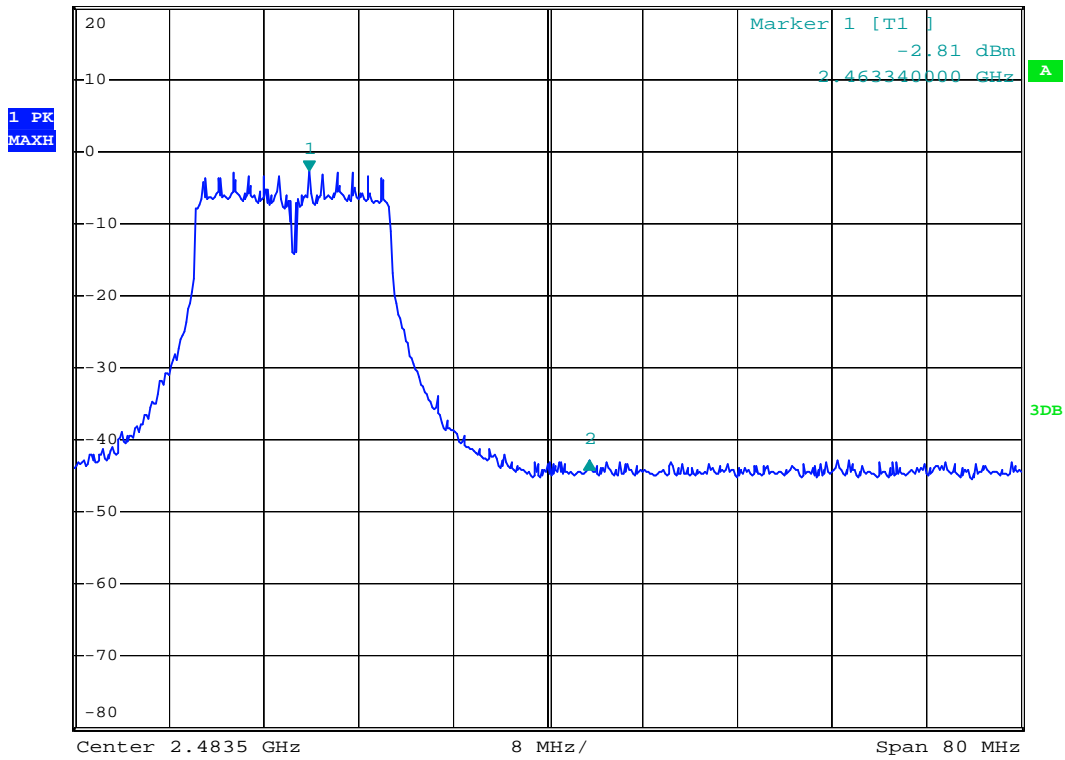

Date: 26.OCT.2012 19:09:09

802.11n Channel Low 2412MHz (20MHz)

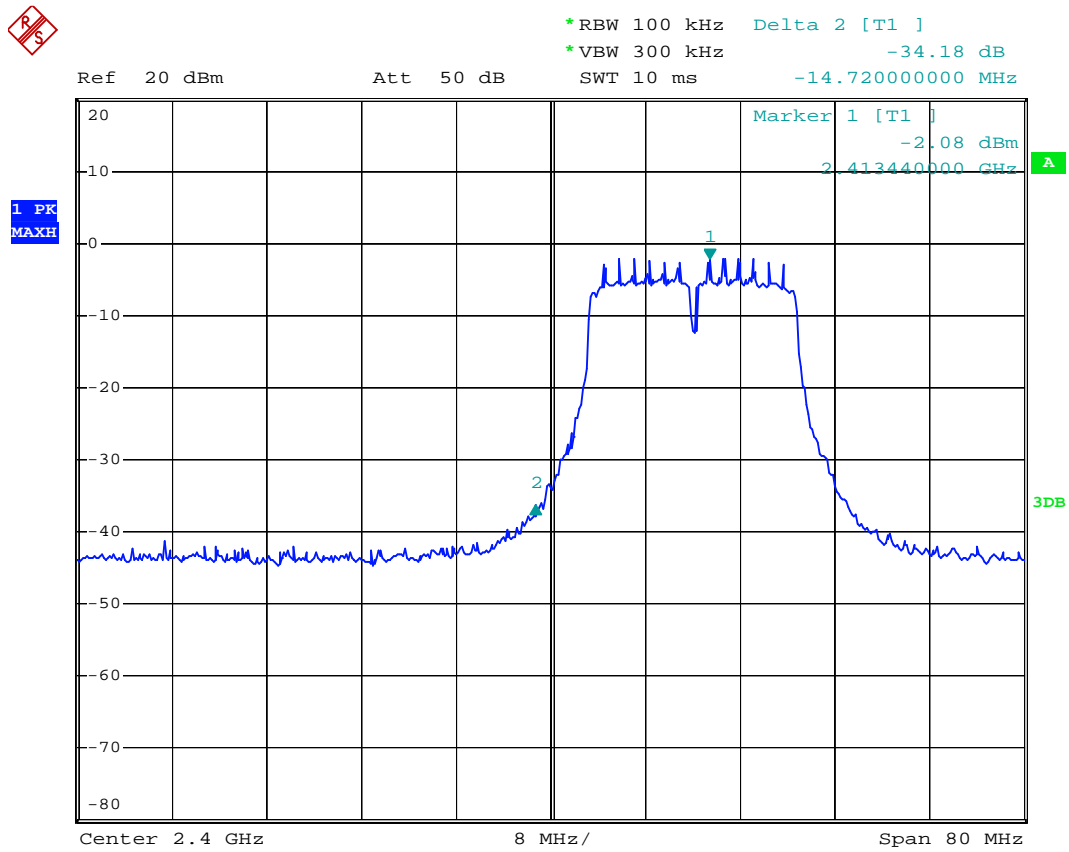

Date: 26.OCT.2012 19:12:42

802.11n Channel High 2462MHz (20MHz)

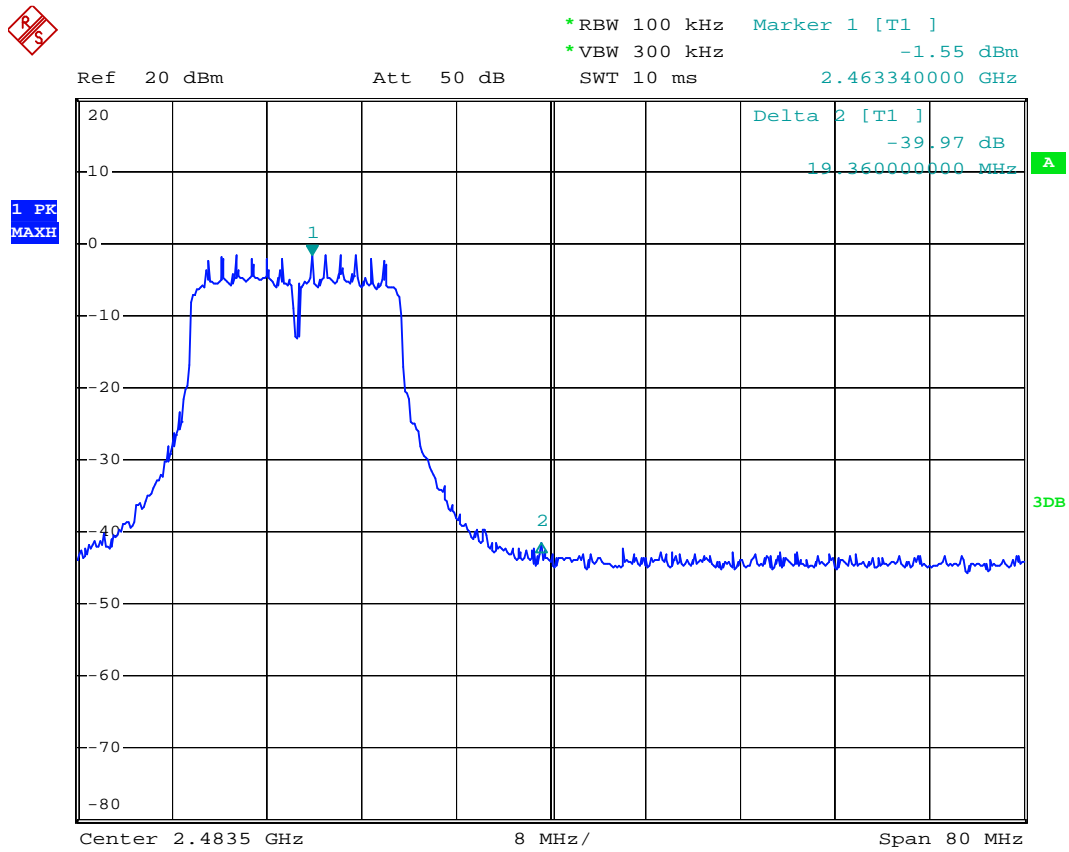

Date: 26.OCT.2012 19:13:24

802.11n Channel Low 2422MHz (40MHz)

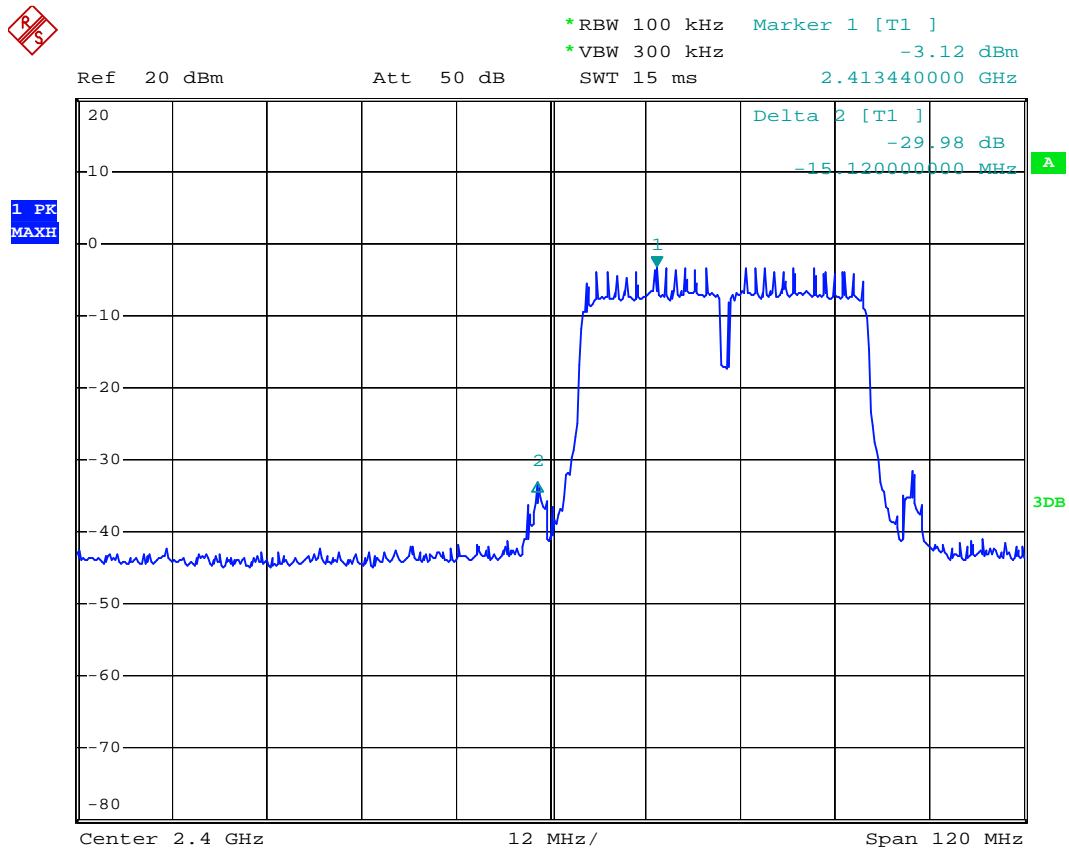

Date: 26.OCT.2012 19:15:46

802.11n Channel High 2452MHz (40MHz)

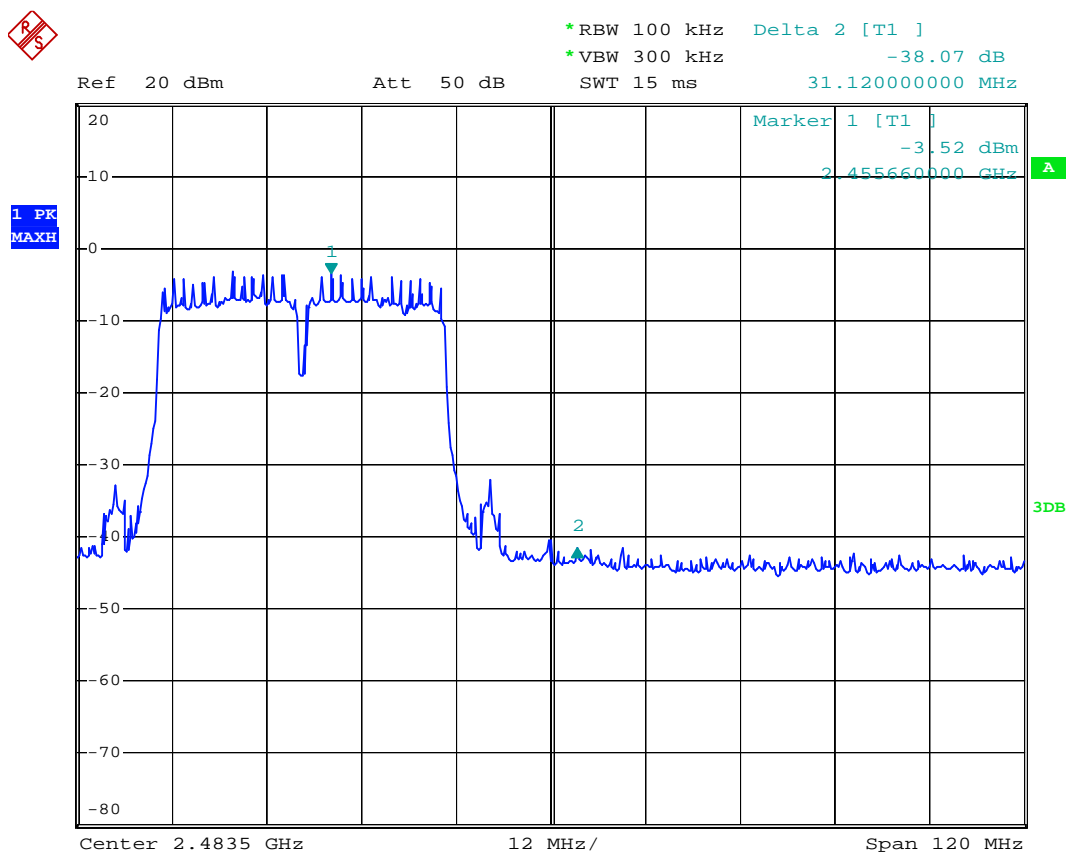

Date: 26.OCT.2012 19:15:00

Date: 23.AUG.2012

Radiated Band Edge Result

Date of Test:	<u>October 22, 2012</u>	Temperature:	<u>25°C</u>
EUT:	<u>Mobile Internet Device</u>	Humidity:	<u>50%</u>
Model No.:	<u>P804</u>	Power Supply:	<u>AC 120V/60Hz</u>
Test Mode:	<u>802.11b Channel Low 2412MHz</u>	Test Engineer:	<u>Pei</u>

Frequency (MHz)	Reading(dBμV/m)		Factor(dB) Corr.	Result(dBμV/m)		Limit(dBμV/m)		Margin(dB)		Polarization
	AV	PEAK		AV	PEAK	AV	PEAK	AV	PEAK	
2310.000	40.00	49.97	-7.81	32.19	42.16	54.00	74.00	-21.81	-31.84	Vertical
2359.168	40.28	51.20	-7.73	32.55	43.47	54.00	74.00	-21.45	-30.53	Vertical
2390.000	42.82	51.04	-7.53	35.29	43.51	54.00	74.00	-18.71	-30.49	Vertical
2310.000	39.18	46.79	-7.81	31.37	38.98	54.00	74.00	-22.63	-35.02	Horizontal
2342.882	40.15	48.46	-7.79	32.36	40.67	54.00	74.00	-21.64	-33.33	Horizontal
2390.000	36.99	43.96	-7.53	29.46	36.43	54.00	74.00	-24.54	-37.57	Horizontal

Note:

1. Emissions attenuated more than 20 dB below the permissible value are not reported.
2. The field strength is calculated by adding the antenna factor, high pass filter loss(if used) and cable loss, and subtracting the amplifier gain(if any)from the measured reading. The basic equation calculation is as follows:

$$\text{Result} = \text{Reading} + \text{Corrected Factor}$$
3. Display the measurement of peak values.

Date of Test:	<u>October 22, 2012</u>	Temperature:	<u>25°C</u>
EUT:	<u>Mobile Internet Device</u>	Humidity:	<u>50%</u>
Model No.:	<u>P804</u>	Power Supply:	<u>AC 120V/60Hz</u>
Test Mode:	<u>802.11b Channel High 2462MHz</u>	Test Engineer:	<u>Pei</u>

Frequency (MHz)	Reading(dBμV/m)		Factor(dB) Corr.	Result(dBμV/m)		Limit(dBμV/m)		Margin(dB)		Polarization
	AV	PEAK		AV	PEAK	AV	PEAK	AV	PEAK	
2483.500	45.88	35.11	-7.37	38.51	27.74	54.00	74.00	-15.49	-46.26	Vertical
2491.627	36.18	47.66	-7.39	28.79	40.27	54.00	74.00	-25.21	-33.73	Vertical
2500.000	34.28	43.96	-7.40	26.88	36.56	54.00	74.00	-27.12	-37.44	Vertical
2483.500	33.69	44.87	-7.37	26.32	37.50	54.00	74.00	-27.68	-36.50	Horizontal
2494.641	35.28	46.34	-7.39	27.89	38.95	54.00	74.00	-26.11	-35.05	Horizontal
2500.000	31.28	43.81	-7.40	23.88	36.41	54.00	74.00	-30.12	-37.59	Horizontal

Note:

1. Emissions attenuated more than 20 dB below the permissible value are not reported.
2. The field strength is calculated by adding the antenna factor, high pass filter loss(if used) and cable loss, and subtracting the amplifier gain(if any)from the measured reading. The basic equation calculation is as follows:
Result = Reading + Corrected Factor
3. Display the measurement of peak values.

Date of Test:	<u>October 22, 2012</u>	Temperature:	<u>25°C</u>
EUT:	<u>Mobile Internet Device</u>	Humidity:	<u>50%</u>
Model No.:	<u>P804</u>	Power Supply:	<u>AC 120V/60Hz</u>
Test Mode:	<u>802.11g Channel Low 2412MHz</u>	Test Engineer:	<u>Pei</u>

Frequency (MHz)	Reading(dBμV/m)		Factor(dB) Corr.	Result(dBμV/m)		Limit(dBμV/m)		Margin(dB)		Polarization
	AV	PEAK		AV	PEAK	AV	PEAK	AV	PEAK	
2310.000	37.61	48.53	-7.81	29.80	40.72	54.00	74.00	-24.20	-33.28	Vertical
2345.380	38.29	50.02	-7.79	30.50	42.23	54.00	74.00	-23.50	-31.77	Vertical
2390.000	35.91	46.54	-7.53	28.38	39.01	54.00	74.00	-25.62	-34.99	Vertical
2310.000	38.91	47.47	-7.81	31.10	39.66	54.00	74.00	-22.90	-34.34	Horizontal
2344.686	38.22	49.93	-7.79	30.43	42.14	54.00	74.00	-23.57	-31.86	Horizontal
2390.000	36.43	45.66	-7.53	28.90	38.13	54.00	74.00	-25.10	-35.87	Horizontal

Note:

1. Emissions attenuated more than 20 dB below the permissible value are not reported.
2. The field strength is calculated by adding the antenna factor, high pass filter loss(if used) and cable loss, and subtracting the amplifier gain(if any)from the measured reading. The basic equation calculation is as follows:

$$\text{Result} = \text{Reading} + \text{Corrected Factor}$$
3. Display the measurement of peak values.

Date of Test:	<u>October 22, 2012</u>	Temperature:	<u>25°C</u>
EUT:	<u>Mobile Internet Device</u>	Humidity:	<u>50%</u>
Model No.:	<u>P804</u>	Power Supply:	<u>AC 120V/60Hz</u>
Test Mode:	<u>802.11g Channel High 2462MHz</u>	Test Engineer:	<u>Pei</u>

Frequency (MHz)	Reading(dBμV/m)		Factor(dB) Corr.	Result(dBμV/m)		Limit(dBμV/m)		Margin(dB)		Polarization
	AV	PEAK		AV	PEAK	AV	PEAK	AV	PEAK	
2483.500	34.17	45.47	-7.37	26.80	38.10	54.00	74.00	-27.20	-35.90	Vertical
2494.006	35.91	46.64	-7.40	28.51	39.24	54.00	74.00	-25.49	-34.76	Vertical
2500.000	32.58	44.82	-7.40	25.18	37.42	54.00	74.00	-28.82	-36.58	Vertical
2483.500	34.67	44.50	-7.37	27.30	37.13	54.00	74.00	-26.70	-36.87	Horizontal
2493.848	34.19	45.47	-7.40	26.79	38.07	54.00	74.00	-27.21	-35.93	Horizontal
2500.000	36.48	45.21	-7.40	29.08	37.81	54.00	74.00	-24.92	-36.19	Horizontal

Note:

1. Emissions attenuated more than 20 dB below the permissible value are not reported.
2. The field strength is calculated by adding the antenna factor, high pass filter loss(if used) and cable loss, and subtracting the amplifier gain(if any)from the measured reading. The basic equation calculation is as follows:
Result = Reading + Corrected Factor
3. Display the measurement of peak values.

Date of Test:	<u>October 22, 2012</u>	Temperature:	<u>25°C</u>
EUT:	<u>Mobile Internet Device</u>	Humidity:	<u>50%</u>
Model No.:	<u>P804</u>	Power Supply:	<u>AC 120V/60Hz</u>
	<u>802.11n Channel Low 2412MHz</u>		
Test Mode:	<u>(20MHz)</u>	Test Engineer:	<u>Pei</u>

Frequency (MHz)	Reading(dBμV/m)		Factor(dB) Corr.	Result(dBμV/m)		Limit(dBμV/m)		Margin(dB)		Polarization
	AV	PEAK		AV	PEAK	AV	PEAK	AV	PEAK	
2310.000	39.33	48.26	-7.81	31.52	40.45	54.00	74.00	-22.48	-33.55	Vertical
2358.191	39.36	50.86	-7.74	31.62	43.12	54.00	74.00	-22.38	-30.88	Vertical
2390.000	34.58	44.94	-7.53	27.05	37.41	54.00	74.00	-26.95	-36.59	Vertical
2310.000	39.24	47.88	-7.81	31.43	40.07	54.00	74.00	-22.57	-33.93	Horizontal
2343.160	39.88	50.17	-7.79	32.09	42.38	54.00	74.00	-21.91	-31.62	Horizontal
2390.000	34.81	45.76	-7.53	27.28	38.23	54.00	74.00	-26.72	-35.77	Horizontal

Note:

1. Emissions attenuated more than 20 dB below the permissible value are not reported.
2. The field strength is calculated by adding the antenna factor, high pass filter loss(if used) and cable loss, and subtracting the amplifier gain(if any)from the measured reading. The basic equation calculation is as follows:

$$\text{Result} = \text{Reading} + \text{Corrected Factor}$$
3. Display the measurement of peak values.

Date of Test:	<u>October 22, 2012</u>	Temperature:	<u>25°C</u>
EUT:	<u>Mobile Internet Device</u>	Humidity:	<u>50%</u>
Model No.:	<u>P804</u>	Power Supply:	<u>AC 120V/60Hz</u>
Test Mode:	<u>802.11n Channel High 2462MHz (20MHz)</u>	Test Engineer:	<u>Pei</u>

Frequency (MHz)	Reading(dBμV/m)		Factor(dB) Corr.	Result(dBμV/m)		Limit(dBμV/m)		Margin(dB)		Polarization
	AV	PEAK		AV	PEAK	AV	PEAK	AV	PEAK	
2483.500	33.80	44.77	-7.37	26.43	37.40	54.00	74.00	-27.57	-36.60	Vertical
2492.102	35.17	48.02	-7.39	27.78	40.63	54.00	74.00	-26.22	-33.37	Vertical
2500.000	32.93	44.65	-7.40	25.53	37.25	54.00	74.00	-28.47	-36.75	Vertical
2483.500	34.28	45.40	-7.37	26.91	38.03	54.00	74.00	-27.09	-35.97	Horizontal
2493.372	37.92	46.17	-7.39	30.53	38.78	54.00	74.00	-23.47	-35.22	Horizontal
2500.000	35.91	44.68	-7.40	28.51	37.28	54.00	74.00	-25.49	-36.72	Horizontal

Note:

1. Emissions attenuated more than 20 dB below the permissible value are not reported.
2. The field strength is calculated by adding the antenna factor, high pass filter loss(if used) and cable loss, and subtracting the amplifier gain(if any)from the measured reading. The basic equation calculation is as follows:
Result = Reading + Corrected Factor
3. Display the measurement of peak values.

Date of Test:	October 22, 2012	Temperature:	25°C
EUT:	Mobile Internet Device	Humidity:	50%
Model No.:	P804	Power Supply:	AC 120V/60Hz
Test Mode:	802.11n Channel Low 2422MHz (40MHz)	Test Engineer:	Pei

Frequency (MHz)	Reading(dBμV/m)		Factor(dB) Corr.	Result(dBμV/m)		Limit(dBμV/m)		Margin(dB)		Polarization
	AV	PEAK		AV	PEAK	AV	PEAK	AV	PEAK	
2310.000	43.08	50.94	-7.81	35.27	43.13	54.00	74.00	-18.73	-30.87	Vertical
2342.646	42.18	52.49	-7.79	34.39	44.70	54.00	74.00	-19.61	-29.30	Vertical
2390.000	43.99	51.17	-7.53	36.46	43.64	54.00	74.00	-17.54	-30.36	Vertical
2310.000	40.28	47.08	-7.81	32.47	39.27	54.00	74.00	-21.53	-34.73	Horizontal
2335.020	43.17	50.71	-7.80	35.37	42.91	54.00	74.00	-18.63	-31.09	Horizontal
2390.000	39.83	47.97	-7.53	32.30	40.44	54.00	74.00	-21.70	-33.56	Horizontal

Note:

1. Emissions attenuated more than 20 dB below the permissible value are not reported.
2. The field strength is calculated by adding the antenna factor, high pass filter loss(if used) and cable loss, and subtracting the amplifier gain(if any)from the measured reading. The basic equation calculation is as follows:
Result = Reading + Corrected Factor
3. Display the measurement of peak values.

Date of Test:	<u>October 22, 2012</u>	Temperature:	<u>25°C</u>
EUT:	<u>Mobile Internet Device</u>	Humidity:	<u>50%</u>
Model No.:	<u>P804</u>	Power Supply:	<u>AC 120V/60Hz</u>
	<u>802.11n Channel High 2452MHz</u>		
Test Mode:	<u>(40MHz)</u>	Test Engineer:	<u>Pei</u>

Frequency (MHz)	Reading(dBμV/m)		Factor(dB) Corr.	Result(dBμV/m)		Limit(dBμV/m)		Margin(dB)		Polarization
	AV	PEAK		AV	PEAK	AV	PEAK	AV	PEAK	
2483.500	41.89	48.40	-7.37	34.52	41.03	54.00	74.00	-19.48	-32.97	Vertical
2494.262	41.00	48.52	-7.39	33.61	41.13	54.00	74.00	-20.39	-32.87	Vertical
2500.000	38.91	46.08	-7.40	31.51	38.68	54.00	74.00	-22.49	-35.32	Vertical
2483.500	35.17	44.87	-7.37	27.80	37.50	54.00	74.00	-26.20	-36.50	Horizontal
2494.262	36.99	46.29	-7.39	29.60	38.90	54.00	74.00	-24.40	-35.10	Horizontal
2500.000	33.55	44.48	-7.40	26.15	37.08	54.00	74.00	-27.85	-36.92	Horizontal

Note:

1. Emissions attenuated more than 20 dB below the permissible value are not reported.
2. The field strength is calculated by adding the antenna factor, high pass filter loss(if used) and cable loss, and subtracting the amplifier gain(if any)from the measured reading. The basic equation calculation is as follows:
Result = Reading + Corrected Factor
3. Display the measurement of peak values.

AC 120V/60Hz



ACCURATE TECHNOLOGY CO., LTD.

F1,Bldg,A,Changyuan New Material Port Keyuan Rd,
Science & Industry Park,Nanshan Shenzhen,P.R.China

Site: 966 chamber
Tel:+86-0755-26503290
Fax:+86-0755-26503396

Job No.: star #2557	Polarization: Horizontal
Standard: FCC 15C PK	Power Source: AC 120V/60Hz
Test item: Radiation Test	Date: 12/10/22/
Temp.(C)/Hum.(%) 23 C / 49 %	Time: 13/18/32
EUT: Mobile internet device	Engineer Signature:
Mode: TX Channel 1(802.11b)	Distance: 3m
Model: P804	
Manufacturer: Pipo	

Note: Report No.:ATE20122384

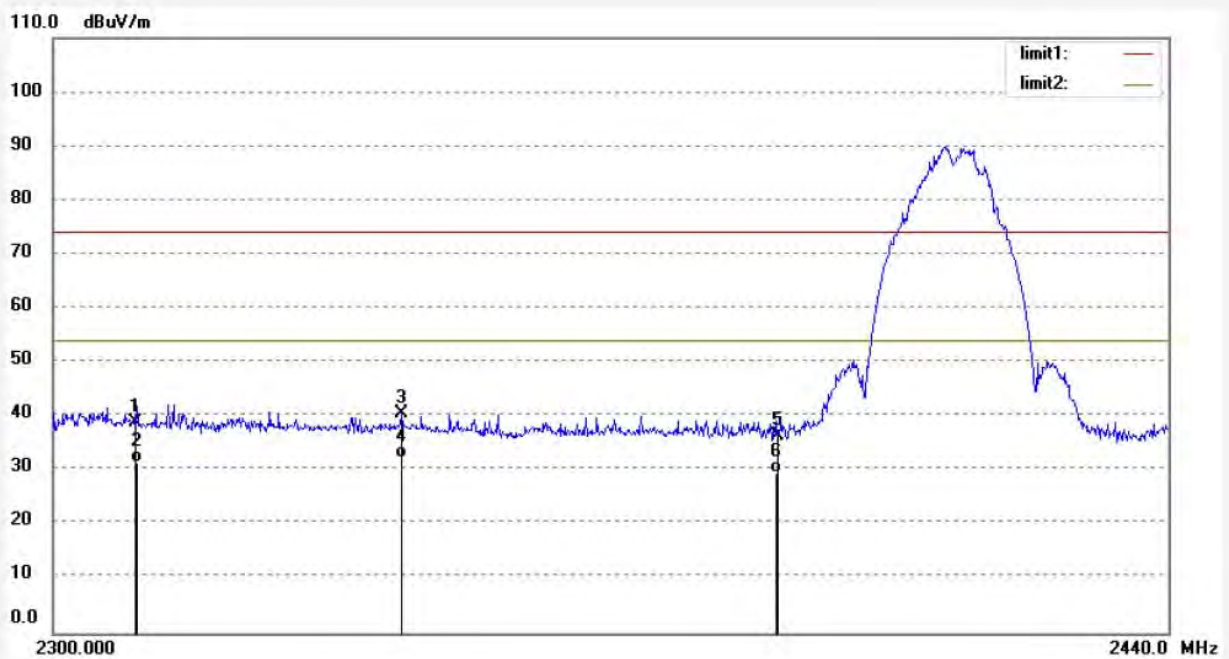

No.	Freq. (MHz)	Reading (dBuV/m)	Factor (dB)	Result (dBuV/m)	Limit (dBuV/m)	Margin (dB)	Detector	Height (cm)	Degree (deg.)	Remark
1	2310.000	46.79	-7.81	38.98	74.00	-35.02	peak			
2	2310.000	39.18	-7.81	31.37	54.00	-22.63	AVG			
3	2342.882	48.46	-7.79	40.67	74.00	-33.33	peak			
4	2342.882	40.15	-7.79	32.36	54.00	-21.64	AVG			
5	2390.000	43.96	-7.53	36.43	74.00	-37.57	peak			
6	2390.000	36.99	-7.53	29.46	54.00	-24.54	AVG			



ACCURATE TECHNOLOGY CO., LTD.

F1,Bldg,A,Changyuan New Material Port Keyuan Rd,
Science & Industry Park,Nanshan Shenzhen,P.R.China

Site: 966 chamber
Tel:+86-0755-26503290
Fax:+86-0755-26503396

Job No.: star #2558	Polarization: Vertical
Standard: FCC 15C PK	Power Source: AC 120V/60Hz
Test item: Radiation Test	Date: 12/10/22/
Temp.(C)/Hum.(%) 23 C / 49 %	Time: 13/22/34
EUT: Mobile internet device	Engineer Signature:
Mode: TX Channel 1(802.11b)	Distance: 3m
Model: P804	
Manufacturer: Pipo	

Note: Report No.:ATE20122384

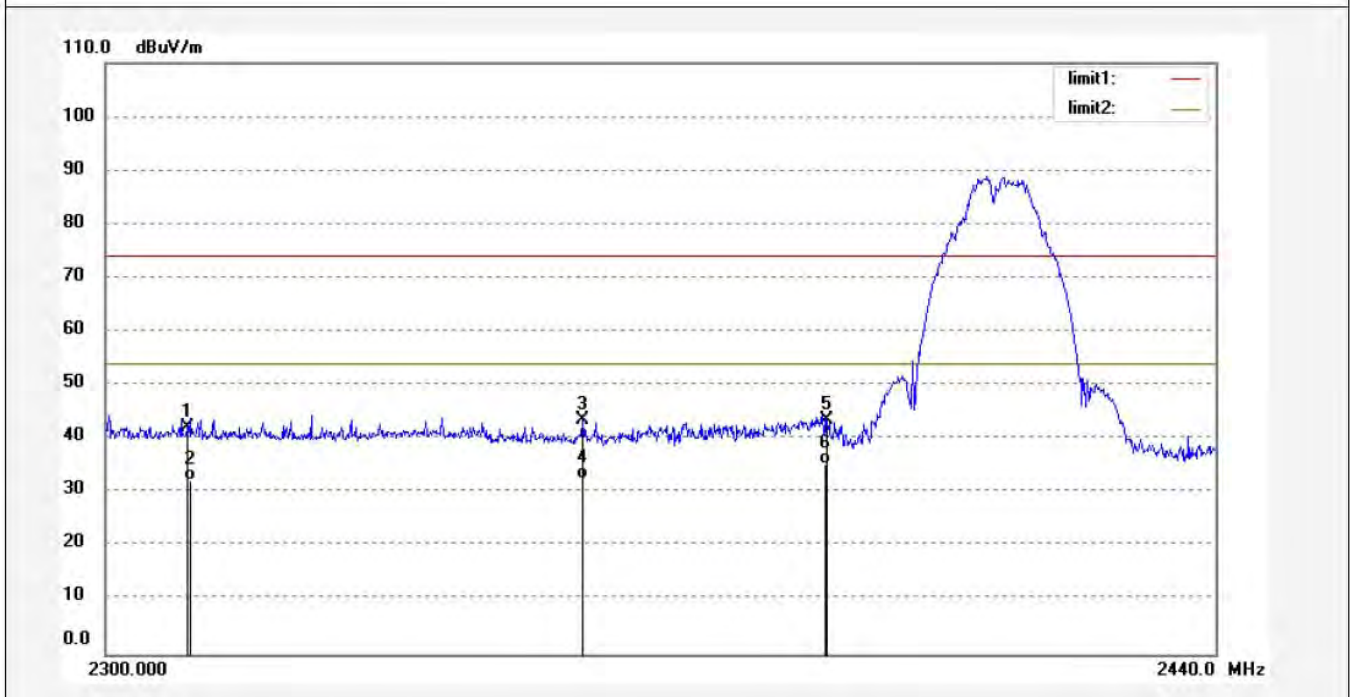

No.	Freq. (MHz)	Reading (dBuV/m)	Factor (dB)	Result (dBuV/m)	Limit (dBuV/m)	Margin (dB)	Detector	Height (cm)	Degree (deg.)	Remark
1	2310.000	49.97	-7.81	42.16	74.00	-31.84	peak			
2	2310.000	40.00	-7.81	32.19	54.00	-21.81	AVG			
3	2359.168	51.20	-7.73	43.47	74.00	-30.53	peak			
4	2359.168	40.28	-7.73	32.55	54.00	-21.45	AVG			
5	2390.000	51.04	-7.53	43.51	74.00	-30.49	peak			
6	2390.000	42.82	-7.53	35.29	54.00	-18.71	AVG			



ACCURATE TECHNOLOGY CO., LTD.

F1,Bldg,A,Changyuan New Material Port Keyuan Rd,
Science & Industry Park,Nanshan Shenzhen,P.R.China

Site: 966 chamber
Tel:+86-0755-26503290
Fax:+86-0755-26503396

Job No.: star #2560
Standard: FCC 15C PK
Test item: Radiation Test
Temp.(C)/Hum.(%) 23 C / 49 %
EUT: Mobile internet device
Mode: TX Channel 11(802.11b)
Model: P804
Manufacturer: Pipo

Polarization: Horizontal
Power Source: AC 120V/60Hz
Date: 12/10/22/
Time: 13/32/24
Engineer Signature:
Distance: 3m

Note: Report No.:ATE20122384

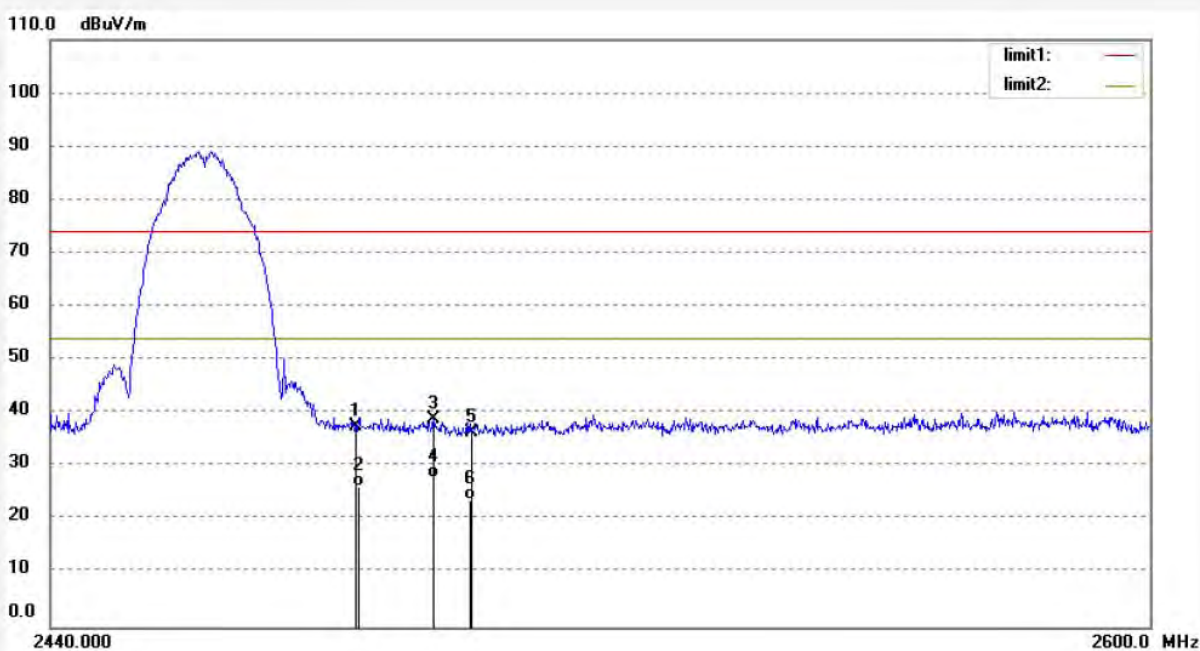

No.	Freq. (MHz)	Reading (dBuV/m)	Factor (dB)	Result (dBuV/m)	Limit (dBuV/m)	Margin (dB)	Detector	Height (cm)	Degree (deg.)	Remark
1	2483.500	44.87	-7.37	37.50	74.00	-36.50	peak			
2	2483.500	33.69	-7.37	26.32	54.00	-27.68	AVG			
3	2494.641	46.34	-7.39	38.95	74.00	-35.05	peak			
4	2494.641	35.28	-7.39	27.89	54.00	-26.11	AVG			
5	2500.000	43.81	-7.40	36.41	74.00	-37.59	peak			
6	2500.000	31.28	-7.40	23.88	54.00	-30.12	AVG			



ACCURATE TECHNOLOGY CO., LTD.

F1,Bldg,A,Changyuan New Material Port Keyuan Rd,
Science & Industry Park,Nanshan Shenzhen,P.R.China

Site: 966 chamber
Tel:+86-0755-26503290
Fax:+86-0755-26503396

Job No.: star #2559	Polarization: Vertical
Standard: FCC 15C PK	Power Source: AC 120V/60Hz
Test item: Radiation Test	Date: 12/10/22/
Temp.(C)/Hum.(%) 23 C / 49 %	Time: 13/27/41
EUT: Mobile internet device	Engineer Signature:
Mode: TX Channel 11(802.11b)	Distance: 3m
Model: P804	
Manufacturer: Pipo	

Note: Report No.:ATE20122384

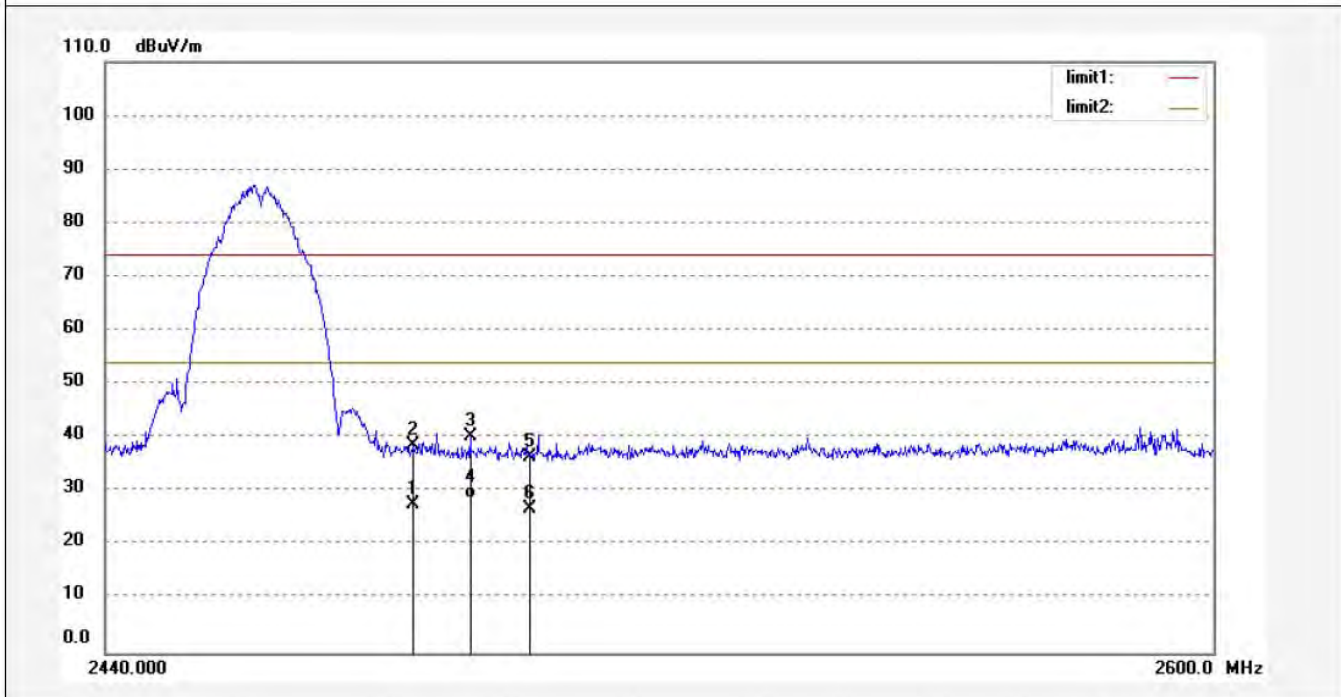

No.	Freq. (MHz)	Reading (dBuV/m)	Factor (dB)	Result (dBuV/m)	Limit (dBuV/m)	Margin (dB)	Detector	Height (cm)	Degree (deg.)	Remark
1	2483.500	35.11	-7.37	27.74	74.00	-46.26	peak			
2	2483.500	45.88	-7.37	38.51	54.00	-15.49	AVG			
3	2491.627	47.66	-7.39	40.27	74.00	-33.73	peak			
4	2491.627	36.18	-7.39	28.79	54.00	-25.21	AVG			
5	2500.000	43.96	-7.40	36.56	74.00	-37.44	peak			
6	2500.000	34.28	-7.40	26.88	54.00	-77.12	AVG			



ACCURATE TECHNOLOGY CO., LTD.

F1,Bldg,A,Changyuan New Material Port Keyuan Rd,
Science & Industry Park,Nanshan Shenzhen,P.R.China

Site: 966 chamber
Tel:+86-0755-26503290
Fax:+86-0755-26503396

Job No.: star #2565
Standard: FCC 15C PK
Test item: Radiation Test
Temp.(C)/Hum.(%) 23 C / 49 %
EUT: Mobile internet device
Mode: TX Channel 1(802.11g)
Model: P804
Manufacturer: Pipo

Polarization: Horizontal
Power Source: AC 120V/60Hz
Date: 12/10/22/
Time: 13/52/31
Engineer Signature:
Distance: 3m

Note: Report No.:ATE20122384

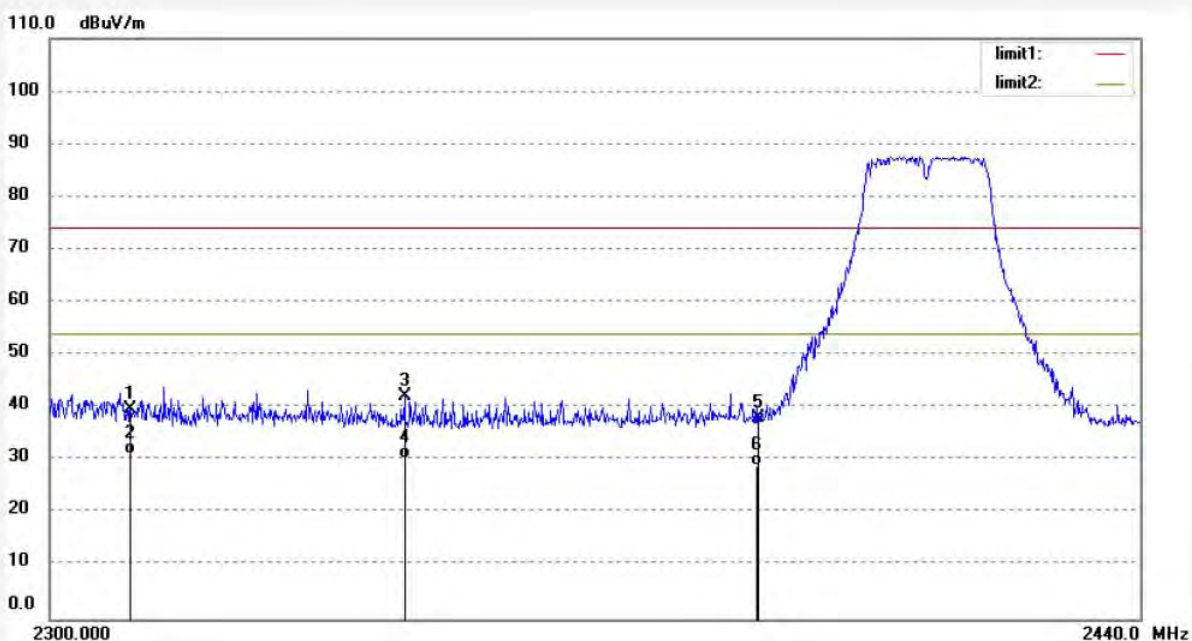

No.	Freq. (MHz)	Reading (dBuV/m)	Factor (dB)	Result (dBuV/m)	Limit (dBuV/m)	Margin (dB)	Detector	Height (cm)	Degree (deg.)	Remark
1	2310.000	47.47	-7.81	39.66	74.00	-34.34	peak			
2	2310.000	38.91	-7.81	31.10	54.00	-22.90	AVG			
3	2344.686	49.93	-7.79	42.14	74.00	-31.86	peak			
4	2344.686	38.22	-7.79	30.43	54.00	-23.57	AVG			
5	2390.000	45.66	-7.53	38.13	74.00	-35.87	peak			
6	2390.000	36.43	-7.53	28.90	54.00	-25.10	AVG			



ACCURATE TECHNOLOGY CO., LTD.

F1,Bldg,A,Changyuan New Material Port Keyuan Rd,
Science & Industry Park,Nanshan Shenzhen,P.R.China

Site: 966 chamber
Tel:+86-0755-26503290
Fax:+86-0755-26503396

Job No.: star #2564
Standard: FCC 15C PK
Test item: Radiation Test
Temp.(C)/Hum.(%) 23 C / 49 %
EUT: Mobile internet device
Mode: TX Channel 1(802.11g)
Model: P804
Manufacturer: Pipo

Polarization: Vertical
Power Source: AC 120V/60Hz
Date: 12/10/22/
Time: 13/48/54
Engineer Signature:
Distance: 3m

Note: Report No.:ATE20122384

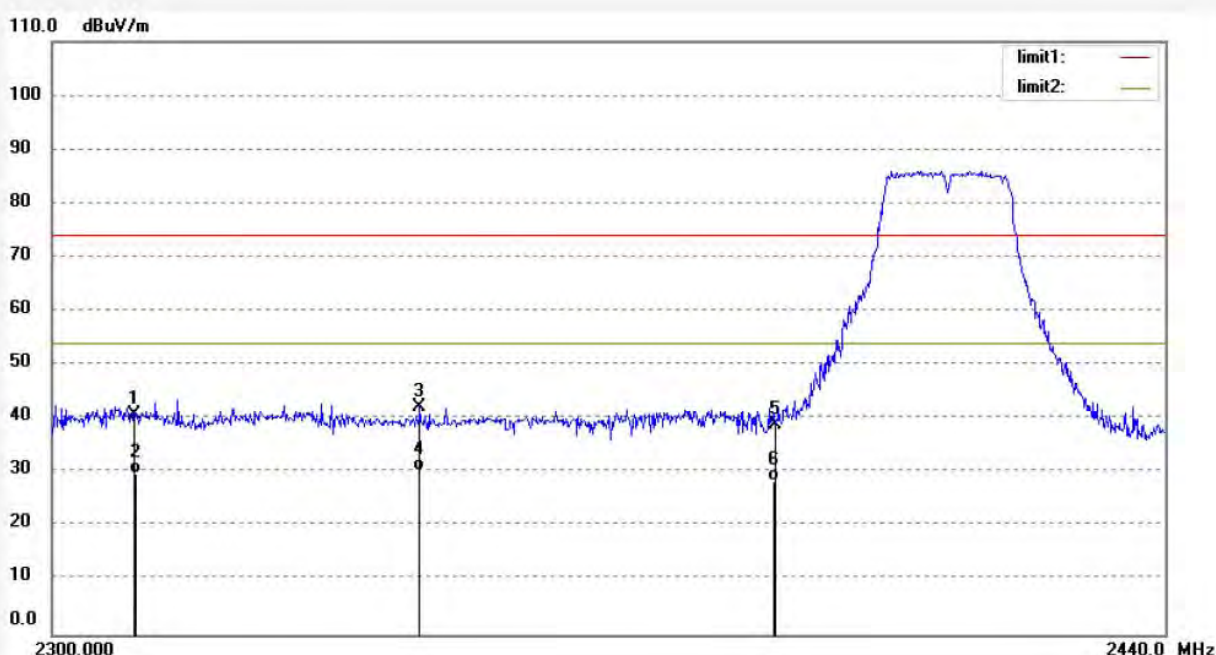

No.	Freq. (MHz)	Reading (dBuV/m)	Factor (dB)	Result (dBuV/m)	Limit (dBuV/m)	Margin (dB)	Detector	Height (cm)	Degree (deg.)	Remark
1	2310.000	48.53	-7.81	40.72	74.00	-33.28	peak			
2	2310.000	37.61	-7.81	29.80	54.00	-24.20	AVG			
3	2345.380	50.02	-7.79	42.23	74.00	-31.77	peak			
4	2345.380	38.29	-7.79	30.50	54.00	-23.50	AVG			
5	2390.000	46.54	-7.53	39.01	74.00	-34.99	peak			
6	2390.000	35.91	-7.53	28.38	54.00	-25.62	AVG			



ACCURATE TECHNOLOGY CO., LTD.

F1,Bldg,A,Changyuan New Material Port Keyuan Rd,
Science & Industry Park,Nanshan Shenzhen,P.R.China

Site: 966 chamber
Tel:+86-0755-26503290
Fax:+86-0755-26503396

Job No.: star #2562
Standard: FCC 15C PK
Test item: Radiation Test
Temp.(C)/Hum.(%) 23 C / 49 %
EUT: Mobile internet device
Mode: TX Channel 11(802.11g)
Model: P804
Manufacturer: Pipo

Polarization: Horizontal
Power Source: AC 120V/60Hz
Date: 12/10/22/
Time: 13/38/10
Engineer Signature:
Distance: 3m

Note: Report No.:ATE20122384

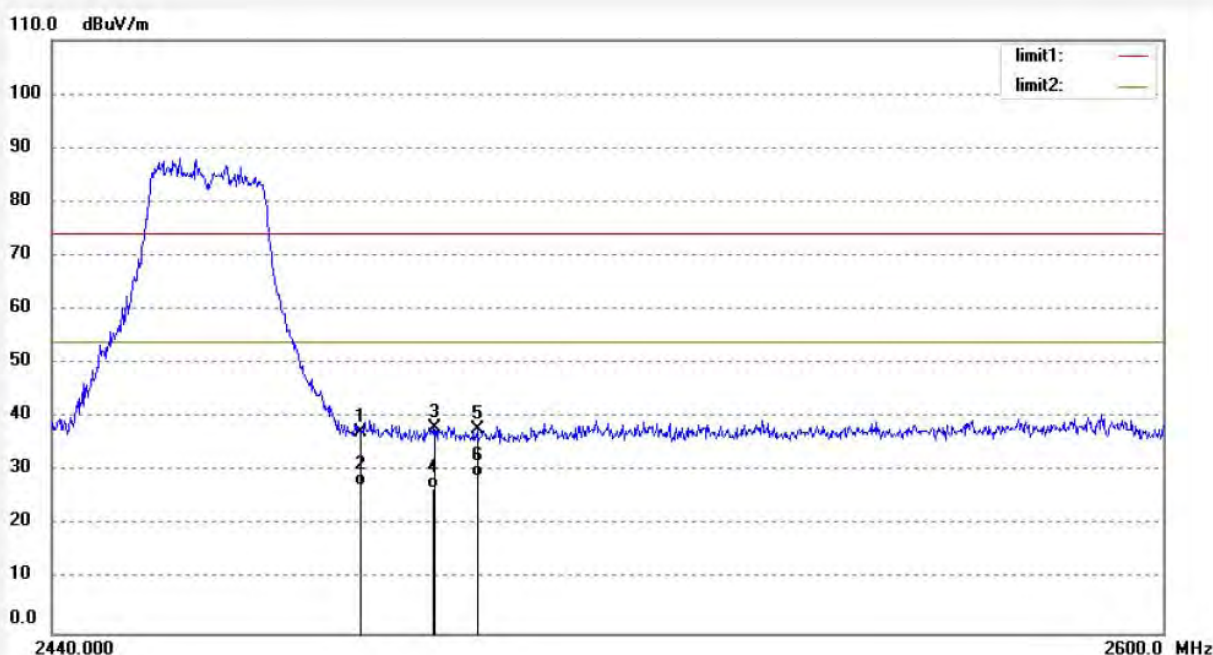

No.	Freq. (MHz)	Reading (dBuV/m)	Factor (dB)	Result (dBuV/m)	Limit (dBuV/m)	Margin (dB)	Detector	Height (cm)	Degree (deg.)	Remark
1	2483.500	44.50	-7.37	37.13	74.00	-36.87	peak			
2	2483.500	34.67	-7.37	27.30	54.00	-26.70	AVG			
3	2493.848	45.47	-7.40	38.07	74.00	-35.93	peak			
4	2493.848	34.19	-7.40	26.79	54.00	-27.21	AVG			
5	2500.000	45.21	-7.40	37.81	74.00	-36.19	peak			
6	2500.000	36.48	-7.40	29.08	54.00	-24.92	AVG			



ACCURATE TECHNOLOGY CO., LTD.

F1,Bldg,A,Changyuan New Material Port Keyuan Rd,
Science & Industry Park,Nanshan Shenzhen,P.R.China

Site: 966 chamber
Tel:+86-0755-26503290
Fax:+86-0755-26503396

Job No.: star #2563	Polarization: Vertical
Standard: FCC 15C PK	Power Source: AC 120V/60Hz
Test item: Radiation Test	Date: 12/10/22/
Temp.(C)/Hum.(%) 23 C / 49 %	Time: 13/44/42
EUT: Mobile internet device	Engineer Signature:
Mode: TX Channel 11(802.11g)	Distance: 3m
Model: P804	
Manufacturer: Pipo	

Note: Report No.:ATE20122384

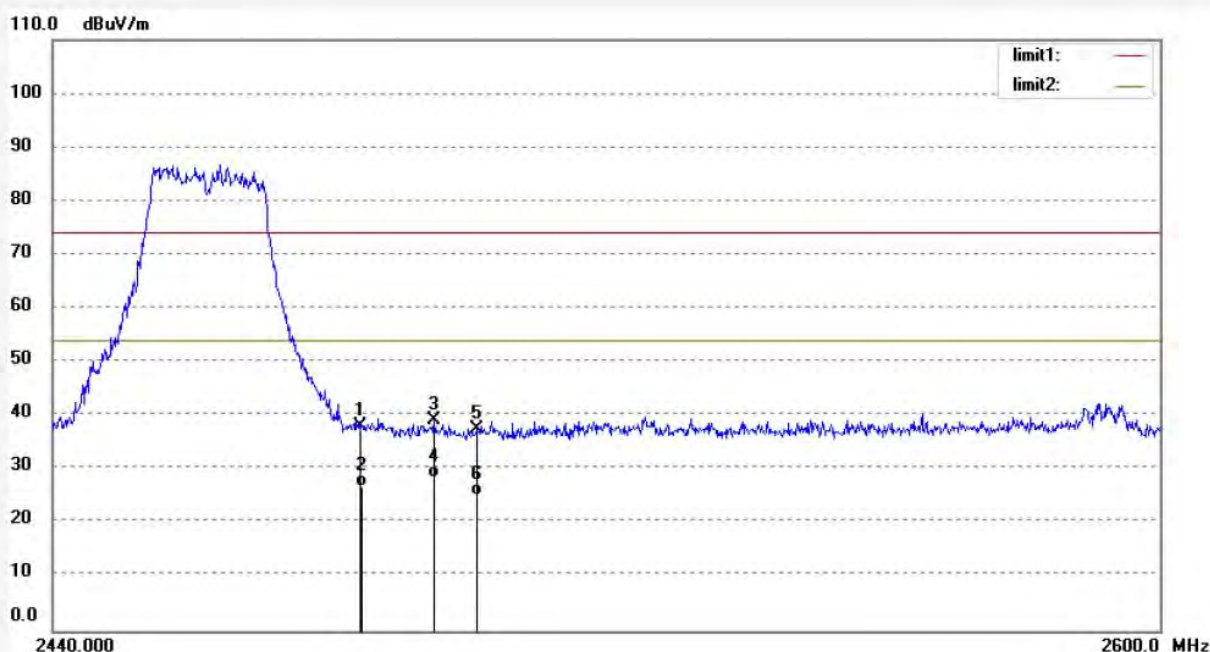

No.	Freq. (MHz)	Reading (dBuV/m)	Factor (dB)	Result (dBuV/m)	Limit (dBuV/m)	Margin (dB)	Detector	Height (cm)	Degree (deg.)	Remark
1	2483.500	45.47	-7.37	38.10	74.00	-35.90	peak			
2	2483.500	34.17	-7.37	26.80	54.00	-27.20	AVG			
3	2494.006	46.64	-7.40	39.24	74.00	-34.76	peak			
4	2494.006	35.91	-7.40	28.51	54.00	-25.49	AVG			
5	2500.000	44.82	-7.40	37.42	74.00	-36.58	peak			
6	2500.000	32.58	-7.40	25.18	54.00	-28.82	AVG			

ACCURATE TECHNOLOGY CO., LTD.

 F1,Bldg,A,Changyuan New Material Port Keyuan Rd,
 Science & Industry Park,Nanshan Shenzhen,P.R.China

 Site: 966 chamber
 Tel:+86-0755-26503290
 Fax:+86-0755-26503396

Job No.: star #2566

Standard: FCC 15C PK

Test item: Radiation Test

Temp.(C)/Hum.(%) 23 C / 49 %

EUT: Mobile internet device

Mode: TX Channel 1(802.11n)

Model: P804

Manufacturer: Pipo

Polarization: Horizontal

Power Source: AC 120V/60Hz

Date: 12/10/22/

Time: 13/58/23

Engineer Signature:

Distance: 3m

Note: Report No.:ATE20122384

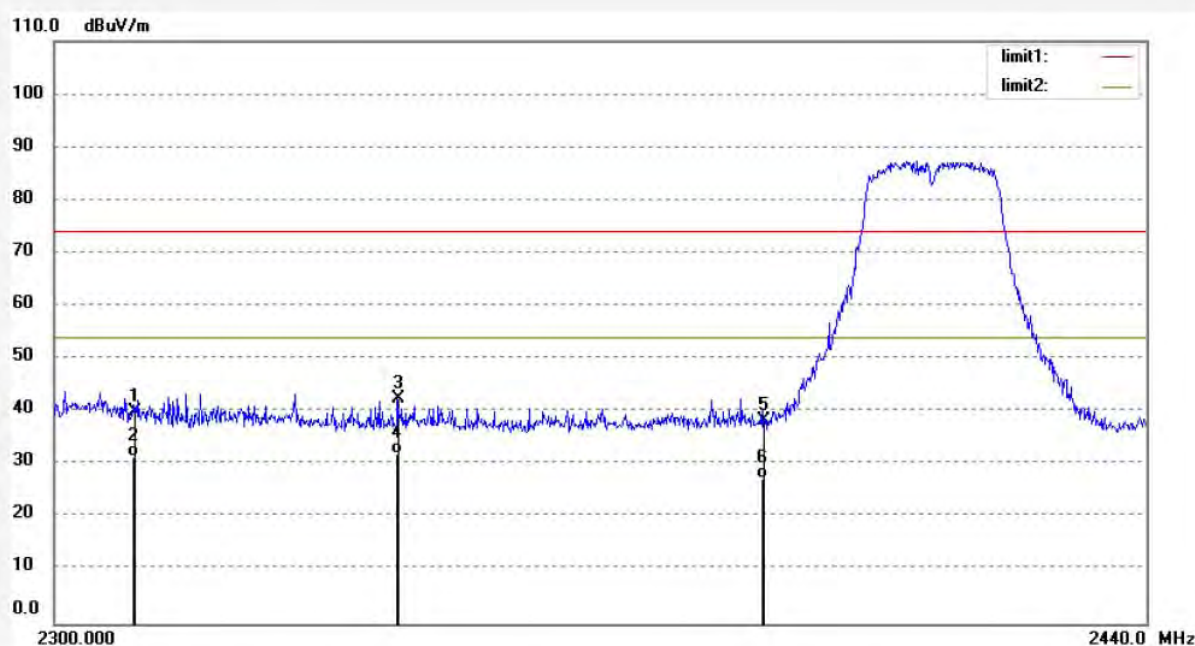

No.	Freq. (MHz)	Reading (dBuV/m)	Factor (dB)	Result (dBuV/m)	Limit (dBuV/m)	Margin (dB)	Detector	Height (cm)	Degree (deg.)	Remark
1	2310.000	47.88	-7.81	40.07	74.00	-33.93	peak			
2	2310.000	39.24	-7.81	31.43	54.00	-22.57	AVG			
3	2343.160	50.17	-7.79	42.38	74.00	-31.62	peak			
4	2343.160	39.88	-7.79	32.09	54.00	-21.91	AVG			
5	2390.000	45.76	-7.53	38.23	74.00	-35.77	peak			
6	2390.000	34.81	-7.53	27.28	54.00	-26.72	AVG			



ACCURATE TECHNOLOGY CO., LTD.

F1,Bldg,A,Changyuan New Material Port Keyuan Rd,
Science & Industry Park,Nanshan Shenzhen,P.R.China

Site: 966 chamber
Tel:+86-0755-26503290
Fax:+86-0755-26503396

Job No.: star #2567	Polarization: Vertical
Standard: FCC 15C PK	Power Source: AC 120V/60Hz
Test item: Radiation Test	Date: 12/10/22/
Temp.(C)/Hum.(%) 23 C / 49 %	Time: 14/03/14
EUT: Mobile internet device	Engineer Signature:
Mode: TX Channel 1(802.11n)	Distance: 3m
Model: P804	
Manufacturer: Pipo	

Note: Report No.:ATE20122384

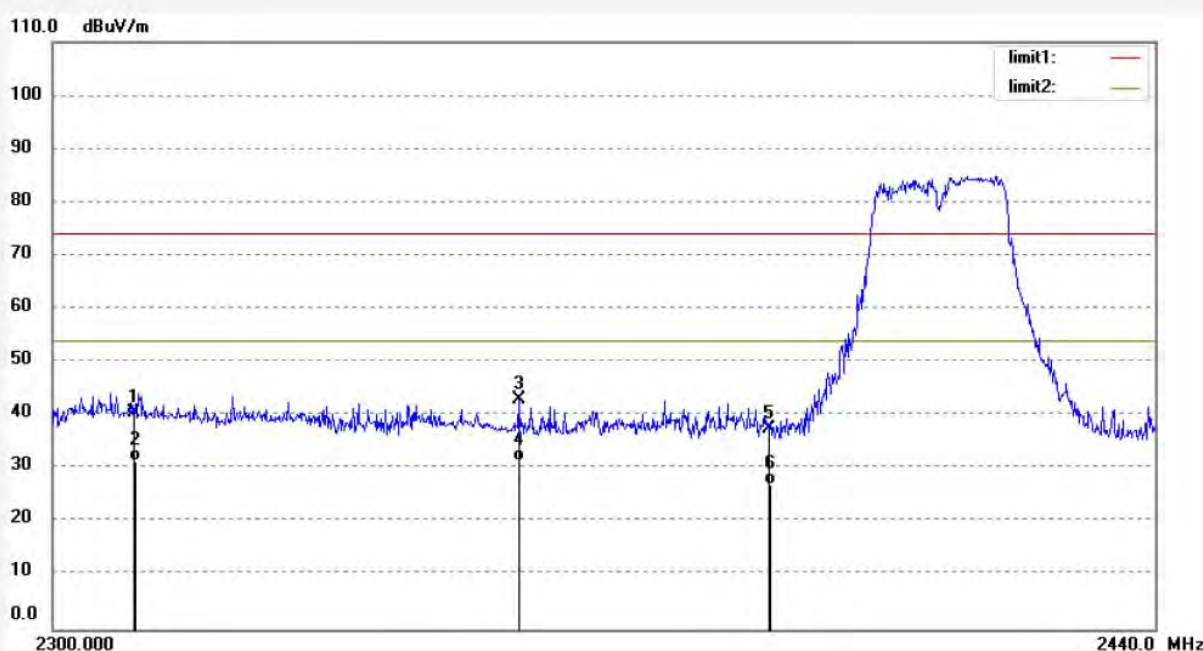

No.	Freq. (MHz)	Reading (dBuV/m)	Factor (dB)	Result (dBuV/m)	Limit (dBuV/m)	Margin (dB)	Detector	Height (cm)	Degree (deg.)	Remark
1	2310.000	48.26	-7.81	40.45	74.00	-33.55	peak			
2	2310.000	39.33	-7.81	31.52	54.00	-22.48	AVG			
3	2358.191	50.86	-7.74	43.12	74.00	-30.88	peak			
4	2358.191	39.36	-7.74	31.62	54.00	-22.38	AVG			
5	2390.000	44.94	-7.53	37.41	74.00	-36.59	peak			
6	2390.000	34.58	-7.53	27.05	54.00	-26.95	AVG			



ACCURATE TECHNOLOGY CO., LTD.

F1,Bldg,A,Changyuan New Material Port Keyuan Rd,
Science & Industry Park,Nanshan Shenzhen,P.R.China

Site: 966 chamber
Tel:+86-0755-26503290
Fax:+86-0755-26503396

Job No.: star #2569	Polarization: Horizontal
Standard: FCC 15C PK	Power Source: AC 120V/60Hz
Test item: Radiation Test	Date: 12/10/22/
Temp.(C)/Hum.(%) 23 C / 49 %	Time: 14/15/12
EUT: Mobile internet device	Engineer Signature:
Mode: TX Channel 11(802.11n)	Distance: 3m
Model: P804	
Manufacturer: Pipo	

Note: Report No.:ATE20122384

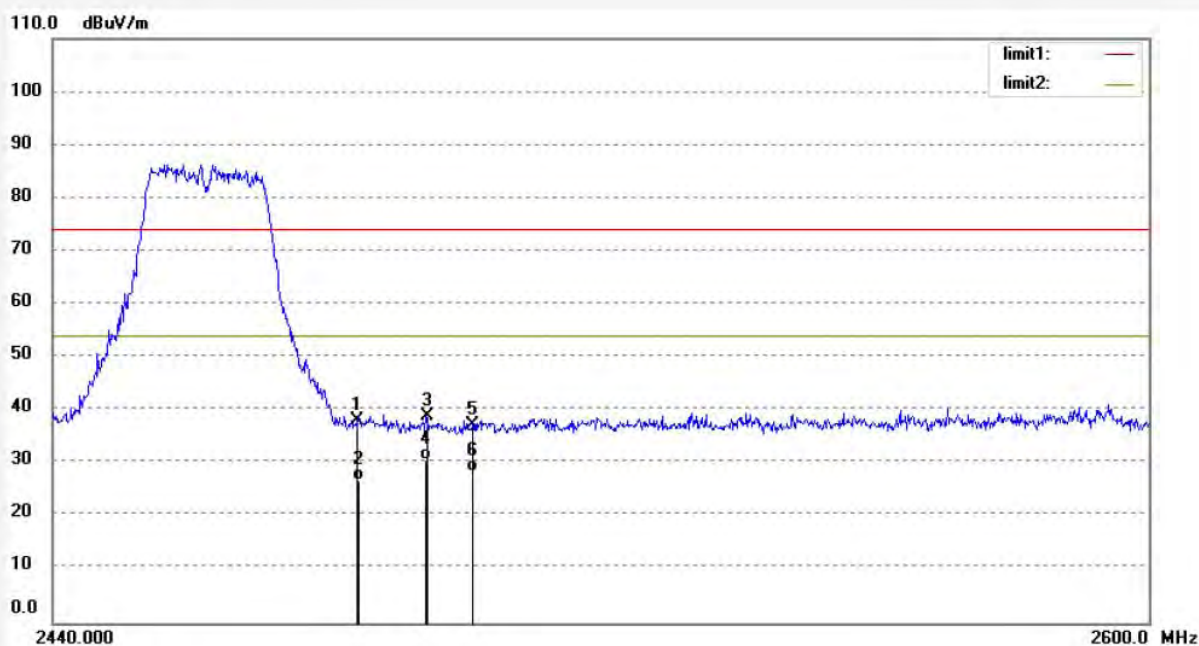

No.	Freq. (MHz)	Reading (dBuV/m)	Factor (dB)	Result (dBuV/m)	Limit (dBuV/m)	Margin (dB)	Detector	Height (cm)	Degree (deg.)	Remark
1	2483.500	45.40	-7.37	38.03	74.00	-35.97	peak			
2	2483.500	34.28	-7.37	26.91	54.00	-27.09	AVG			
3	2493.372	46.17	-7.39	38.78	74.00	-35.22	peak			
4	2493.372	37.92	-7.39	30.53	54.00	-23.47	AVG			
5	2500.000	44.68	-7.40	37.28	74.00	-36.72	peak			
6	2500.000	35.91	-7.40	28.51	54.00	-25.49	AVG			



ACCURATE TECHNOLOGY CO., LTD.

F1,Bldg,A,Changyuan New Material Port Keyuan Rd,
Science & Industry Park,Nanshan Shenzhen,P.R.China

Site: 966 chamber
Tel:+86-0755-26503290
Fax:+86-0755-26503396

Job No.: star #2568	Polarization: Vertical
Standard: FCC 15C PK	Power Source: AC 120V/60Hz
Test item: Radiation Test	Date: 12/10/22/
Temp.(C)/Hum.(%) 23 C / 49 %	Time: 14/10/25
EUT: Mobile internet device	Engineer Signature:
Mode: TX Channel 11(802.11n)	Distance: 3m
Model: P804	
Manufacturer: Pipo	

Note: Report No.:ATE20122384

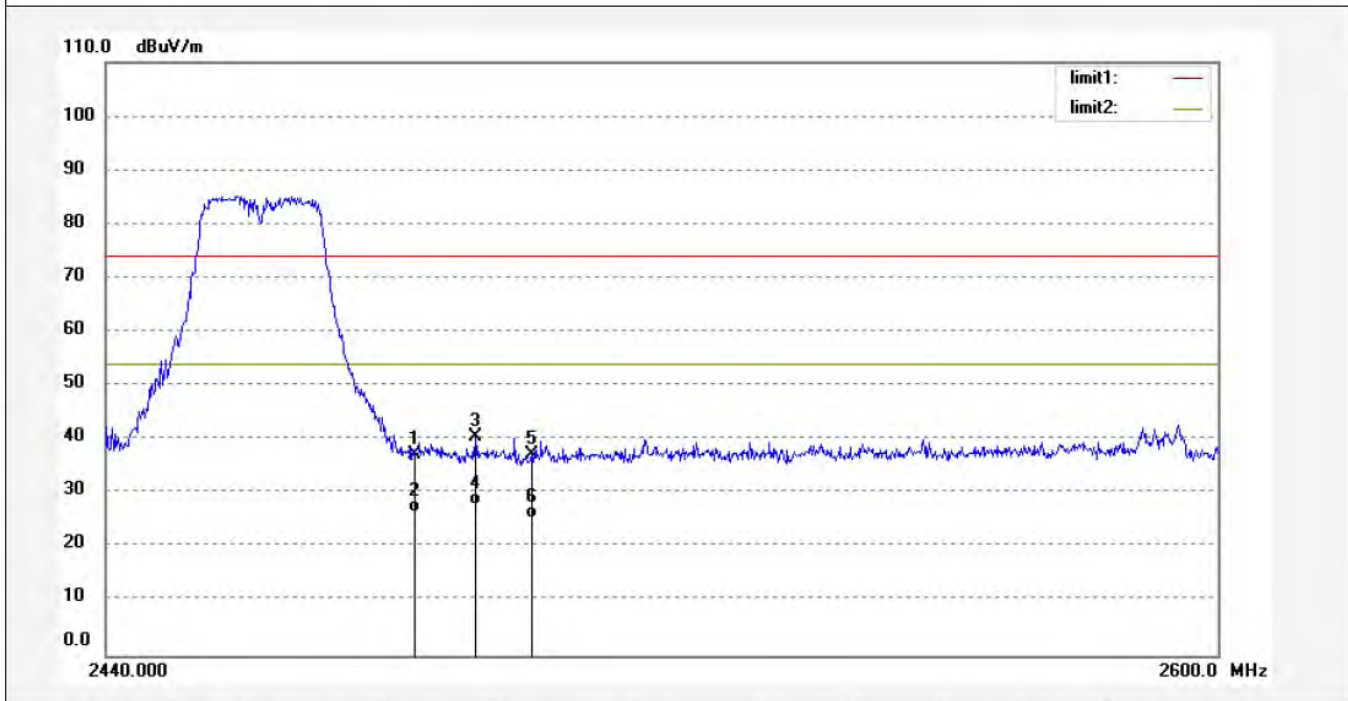

No.	Freq. (MHz)	Reading (dBuV/m)	Factor (dB)	Result (dBuV/m)	Limit (dBuV/m)	Margin (dB)	Detector	Height (cm)	Degree (deg.)	Remark
1	2483.500	44.77	-7.37	37.40	74.00	-36.60	peak			
2	2483.500	33.80	-7.37	26.43	54.00	-27.57	AVG			
3	2492.102	48.02	-7.39	40.63	74.00	-33.37	peak			
4	2492.102	35.17	-7.39	27.78	54.00	-26.22	AVG			
5	2500.000	44.65	-7.40	37.25	74.00	-36.75	peak			
6	2500.000	32.93	-7.40	25.53	54.00	-28.47	AVG			



ACCURATE TECHNOLOGY CO., LTD.

F1,Bldg,A,Changyuan New Material Port Keyuan Rd,
Science & Industry Park,Nanshan Shenzhen,P.R.China

Site: 966 chamber
Tel:+86-0755-26503290
Fax:+86-0755-26503396

Job No.: star #2573	Polarization: Horizontal
Standard: FCC 15C PK	Power Source: AC 120V/60Hz
Test item: Radiation Test	Date: 12/10/22/
Temp.(C)/Hum.(%) 23 C / 49 %	Time: 14/39/42
EUT: Mobile internet device	Engineer Signature:
Mode: TX Channel 3(802.11n)40MHz	Distance: 3m
Model: P804	
Manufacturer: Pipo	

Note: Report No.:ATE20122384

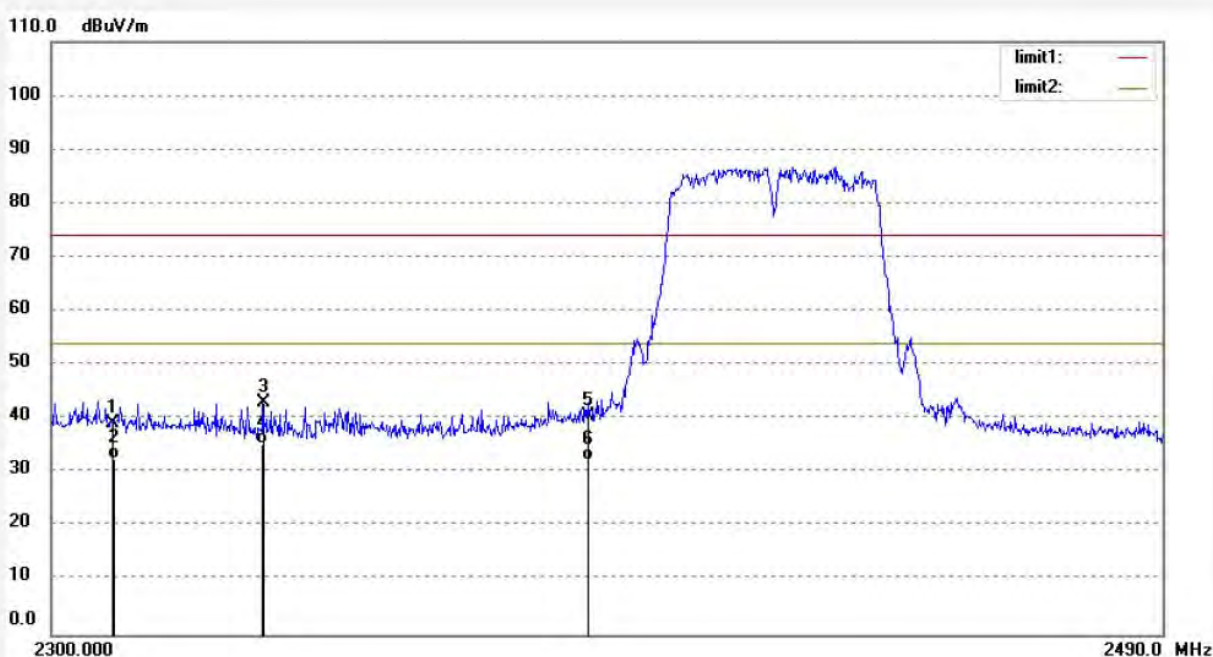

No.	Freq. (MHz)	Reading (dBuV/m)	Factor (dB)	Result (dBuV/m)	Limit (dBuV/m)	Margin (dB)	Detector	Height (cm)	Degree (deg.)	Remark
1	2310.000	47.08	-7.81	39.27	74.00	-34.73	peak			
2	2310.000	40.28	-7.81	32.47	54.00	-21.53	AVG			
3	2335.020	50.71	-7.80	42.91	74.00	-31.09	peak			
4	2335.020	43.17	-7.80	35.37	54.00	-18.63	AVG			
5	2390.000	47.97	-7.53	40.44	74.00	-33.56	peak			
6	2390.000	39.83	-7.53	32.30	54.00	-21.70	AVG			



ACCURATE TECHNOLOGY CO., LTD.

F1,Bldg.A,Changyuan New Material Port Keyuan Rd,
Science & Industry Park,Nanshan Shenzhen,P.R.China

Site: 966 chamber
Tel:+86-0755-26503290
Fax:+86-0755-26503396

Job No.: star #2572	Polarization: Vertical
Standard: FCC 15C PK	Power Source: AC 120V/60Hz
Test item: Radiation Test	Date: 12/10/22/
Temp.(C)/Hum.(%) 23 C / 49 %	Time: 14/33/52
EUT: Mobile internet device	Engineer Signature:
Mode: TX Channel 3(802.11n)40MHz	Distance: 3m
Model: P804	
Manufacturer: Pipo	

Note: Report No.:ATE20122384

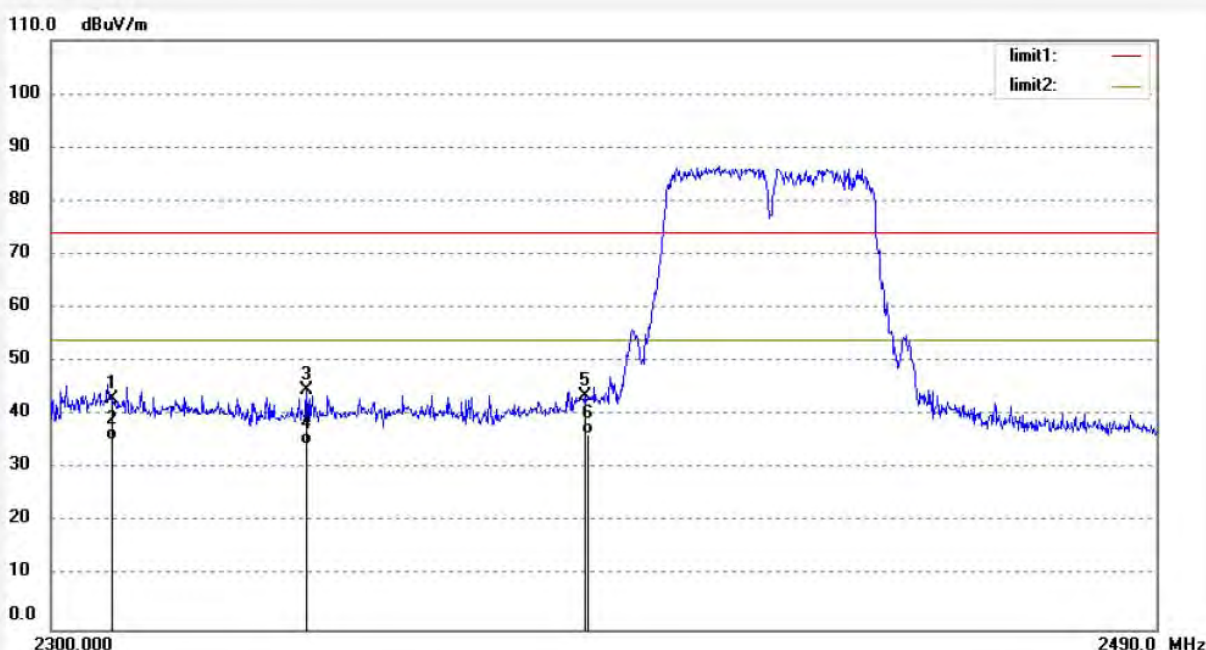

No.	Freq. (MHz)	Reading (dBuV/m)	Factor (dB)	Result (dBuV/m)	Limit (dBuV/m)	Margin (dB)	Detector	Height (cm)	Degree (deg.)	Remark
1	2310.000	50.94	-7.81	43.13	74.00	-30.87	peak			
2	2310.000	43.08	-7.81	35.27	54.00	-18.73	AVG			
3	2342.646	52.49	-7.79	44.70	74.00	-29.30	peak			
4	2342.646	42.18	-7.79	34.39	54.00	-19.61	AVG			
5	2390.000	51.17	-7.53	43.64	74.00	-30.36	peak			
6	2390.000	43.99	-7.53	36.46	54.00	-17.54	AVG			



ACCURATE TECHNOLOGY CO., LTD.

F1,Bldg,A,Changyuan New Material Port Keyuan Rd,
Science & Industry Park,Nanshan Shenzhen,P.R.China

Site: 966 chamber
Tel:+86-0755-26503290
Fax:+86-0755-26503396

Job No.: star #2570	Polarization: Horizontal
Standard: FCC 15C PK	Power Source: AC 120V/60Hz
Test item: Radiation Test	Date: 12/10/22/
Temp.(C)/Hum.(%) 23 C / 49 %	Time: 14/21/19
EUT: Mobile internet device	Engineer Signature:
Mode: TX Channel 9(802.11n)40MHz	Distance: 3m
Model: P804	
Manufacturer: Pipo	

Note: Report No.:ATE20122384

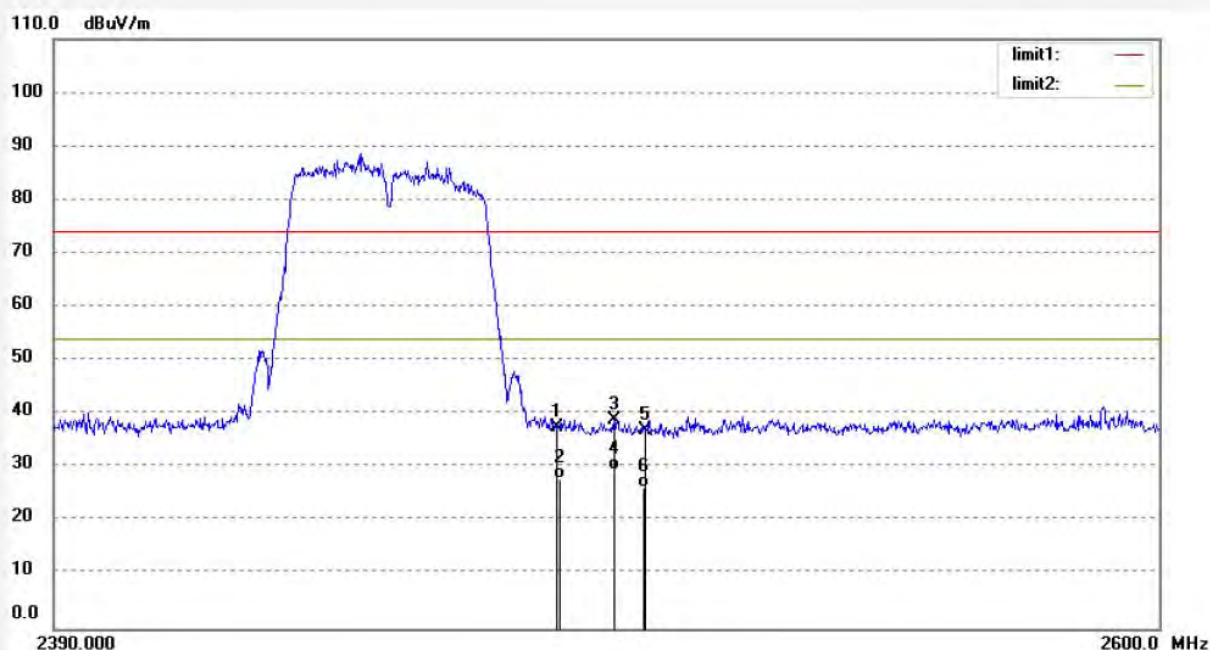

No.	Freq. (MHz)	Reading (dBuV/m)	Factor (dB)	Result (dBuV/m)	Limit (dBuV/m)	Margin (dB)	Detector	Height (cm)	Degree (deg.)	Remark
1	2483.500	44.87	-7.37	37.50	74.00	-36.50	peak			
2	2483.500	35.17	-7.37	27.80	54.00	-26.20	AVG			
3	2494.262	46.29	-7.39	38.90	74.00	-35.10	peak			
4	2494.262	36.99	-7.39	29.60	54.00	-24.40	AVG			
5	2500.000	44.48	-7.40	37.08	74.00	-36.92	peak			
6	2500.000	33.55	-7.40	26.15	54.00	-27.85	AVG			



ACCURATE TECHNOLOGY CO., LTD.

F1,Bldg,A,Changyuan New Material Port Keyuan Rd,
Science & Industry Park,Nanshan Shenzhen,P.R.China

Site: 966 chamber
Tel:+86-0755-26503290
Fax:+86-0755-26503396

Job No.: star #2571	Polarization: Vertical
Standard: FCC 15C PK	Power Source: AC 120V/60Hz
Test item: Radiation Test	Date: 12/10/22/
Temp.(C)/Hum.(%) 23 C / 49 %	Time: 14/27/55
EUT: Mobile internet device	Engineer Signature:
Mode: TX Channel 9(802.11n)40MHz	Distance: 3m
Model: P804	
Manufacturer: Pipo	

Note: Report No.:ATE20122384

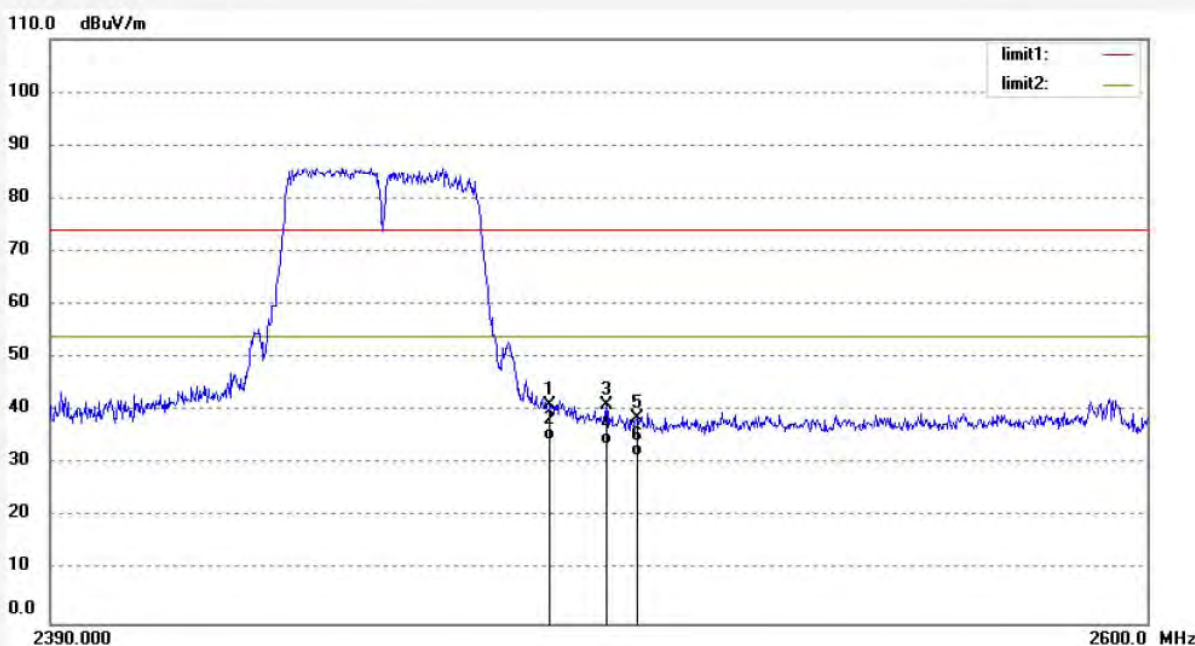

No.	Freq. (MHz)	Reading (dBuV/m)	Factor (dB)	Result (dBuV/m)	Limit (dBuV/m)	Margin (dB)	Detector	Height (cm)	Degree (deg.)	Remark
1	2483.500	48.40	-7.37	41.03	74.00	-32.97	peak			
2	2483.500	41.89	-7.37	34.52	54.00	-19.48	AVG			
3	2494.262	48.52	-7.39	41.13	74.00	-32.87	peak			
4	2494.262	41.00	-7.39	33.61	54.00	-20.39	AVG			
5	2500.000	46.08	-7.40	38.68	74.00	-35.32	peak			
6	2500.000	38.91	-7.40	31.51	54.00	-22.49	AVG			

9. RADIATED SPURIOUS EMISSION TEST

9.1. Block Diagram of Test Setup

9.1.1. Block diagram of connection between the EUT and peripherals

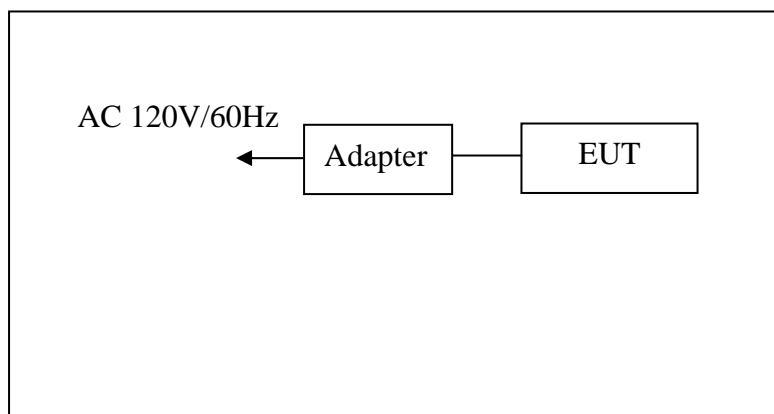

Setup: Transmitting mode

(EUT: Mobile Internet Device)

9.1.2. Semi-Anechoic Chamber Test Setup Diagram

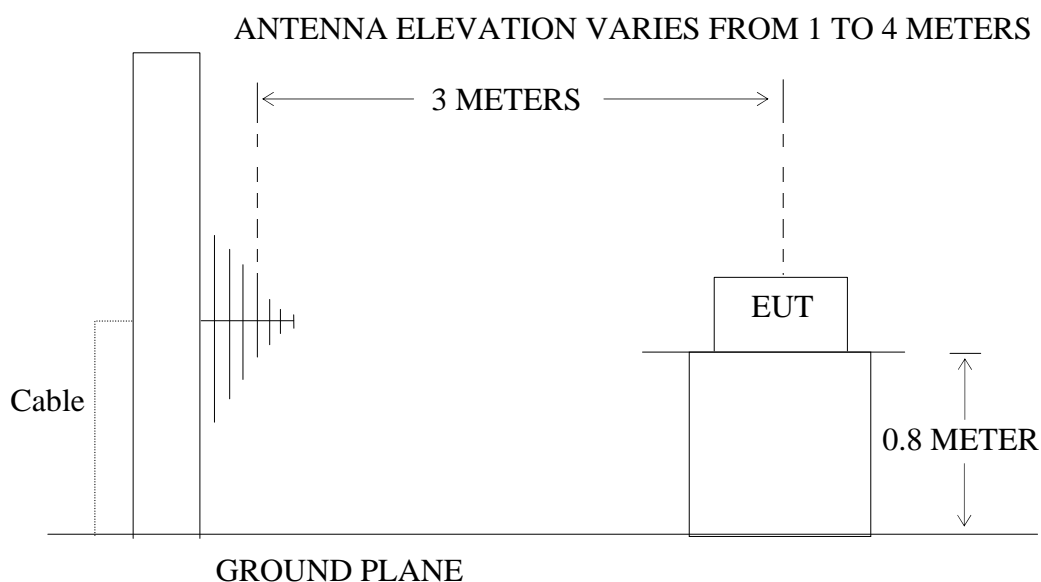

(EUT: Mobile Internet Device)

9.2.The Limit For Section 15.247(d)

Section 15.247(d): In any 100 kHz bandwidth outside the frequency band in which the spread spectrum or digitally modulated intentional radiator is operating, the radio frequency power that is produced by the intentional radiator shall be at least 20 dB below that in the 100 kHz bandwidth within the band that contains the highest level of the desired power, based on either an RF conducted or a radiated measurement, provided the transmitter demonstrates compliance with the peak conducted power limits. If the transmitter complies with the conducted power limits based on the use of RMS averaging over a time interval, as permitted under paragraph (b)(3) of this section, the attenuation required under this paragraph shall be 30 dB instead of 20 dB. Attenuation below the general limits specified in Section 15.209(a) is not required. In addition, radiated emissions which fall in the restricted bands, as defined in Section 15.205(a), must also comply with the radiated emission limits specified in Section 15.209(a).

9.3.Restricted bands of operation

9.3.1.FCC Part 15.205 Restricted bands of operation

(a) Except as shown in paragraph (d) of this section, Only spurious emissions are permitted in any of the frequency bands listed below:

MHz	MHz	MHz	GHz
0.090-0.110	16.42-16.423	399.9-410	4.5-5.15
¹ 0.495-0.505	16.69475-16.69525	608-614	5.35-5.46
2.1735-2.1905	16.80425-16.80475	960-1240	7.25-7.75
4.125-4.128	25.5-25.67	1300-1427	8.025-8.5
4.17725-4.17775	37.5-38.25	1435-1626.5	9.0-9.2
4.20725-4.20775	73-74.6	1645.5-1646.5	9.3-9.5
6.215-6.218	74.8-75.2	1660-1710	10.6-12.7
6.26775-6.26825	108-121.94	1718.8-1722.2	13.25-13.4
6.31175-6.31225	123-138	2200-2300	14.47-14.5
8.291-8.294	149.9-150.05	2310-2390	15.35-16.2
8.362-8.366	156.52475-156.52525	2483.5-2500	17.7-21.4
8.37625-8.38675	156.7-156.9	2690-2900	22.01-23.12
8.41425-8.41475	162.0125-167.17	3260-3267	23.6-24.0
12.29-12.293	167.72-173.2	3332-3339	31.2-31.8
12.51975-12.52025	240-285	3345.8-3358	36.43-36.5
12.57675-12.57725	322-335.4	3600-4400	(²)
13.36-13.41			

¹Until February 1, 1999, this restricted band shall be 0.490-0.510

²Above 38.6

(b) Except as provided in paragraphs (d) and (e), the field strength of emission appearing within these frequency bands shall not exceed the limits shown in Section 15.209. At frequencies equal to or less than 1000MHz, Compliance with the limits in Section 15.209 shall be demonstrated using measurement instrumentation employing a CISPR quasi-peak detector. Above 1000MHz, compliance with the emission limits in Section 15.209 shall be demonstrated based on the average value of the measured emissions. The provisions in Section 15.35 apply to these measurements.

9.4. Configuration of EUT on Measurement

The following equipment are installed on Radiated Emission Measurement to meet the commission requirements and operating regulations in a manner which tends to maximize its emission characteristics in normal application.

9.4.1. Mobile Internet Device (EUT)

Model Number : P804
 Serial Number : N/A
 Manufacturer : Pipo Technology Co., Ltd.

9.5. Operating Condition of EUT

9.5.1. Setup the EUT and simulator as shown as Section 9.1.

9.5.2. Turn on the power of all equipment.

9.5.3. Let the EUT work in TX modes measure it. The transmit frequency are 2412-2462 and 2422-2452MHz. We select 2412MHz, 2437MHz, 2462MHz and 2422MHz, 2437MHz, 2452MHz TX frequency to transmit.

9.6. Test Procedure

The EUT and its simulators are placed on a turntable, which is 0.8 meter high above ground. The turntable can rotate 360 degrees to determine the position of the maximum emission level. EUT is set 3.0 meters away from the receiving antenna, which is mounted on an antenna tower. The antenna can be moved up and down between 1.0 meter and 4 meters to find out the maximum emission level. Broadband antenna (calibrated bilog antenna) is used as receiving antenna. Both horizontal and vertical polarizations of the antenna are set on measurement. In order to find the maximum emission levels, all of the interface cables must be manipulated according to ANSI C63.4: 2009 on radiated emission measurement. The EUT was tested in 3 orthogonal planes.

The worst-case data rate for this channel to be 1Mbps for 802.11b mode and 6Mbps for 802.11g mode and 150Mbps for 802.11n mode, based on previous with 802.11 WLAN product design architectures.

The bandwidth of test receiver is set at 9kHz in below 30MHz. and set at 120kHz in 30-1000MHz, and 1MHz in above 1000MHz.

The frequency range from 9kHz to 25GHz is checked.

The final measurement in band 9-90kHz, 110-490kHz and above 1000MHz is performed with Average detector. Except those frequency bands mention above, the final measurement for frequencies below 1000MHz is performed with Quasi Peak detector.

The field strength is calculated by adding the antenna factor, and cable loss, and subtracting the amplifier gain from the measured reading. The basic equation calculation is as follows:

Result = Reading + Corrected Factor

Where Corrected Factor = Antenna Factor + Cable Loss – Amplifier Gain

9.7. The Field Strength of Radiation Emission Measurement Results

PASS.

Date of Test:	October 22, 2012	Temperature:	25°C
EUT:	Mobile Internet Device	Humidity:	50%
Model No.:	P804	Power Supply:	AC 120V/60HZ
Test Mode:	802.11b Channel Low 2412MHz	Test Engineer:	Pei

For Below 30MHz

Frequency (MHz)	Reading (dBμV/m)	Factor(dB) Corr.	Result (dBμV/m)	Limit (dBμV/m)	Margin (dB)	Polarization
	QP		QP	QP	QP	
-	-	-	-	-	-	X
-	-	-	-	-	-	Y
-	-	-	-	-	-	Z

For 30MHz-1000MHz

Corrected Factor = Antenna Factor + Cable Loss – Amplifier Gain

Frequency (MHz)	Reading (dBμV/m)	Factor Corr. (dB)	Result (dBμV/m)	Limit (dBμV/m)	Margin (dB)	Polarization
	QP		QP	QP	QP	
154.2427	19.30	11.56	30.86	43.50	-12.64	Vertical
268.7212	14.15	18.32	32.47	46.00	-13.53	Vertical
312.5482	17.30	19.13	36.43	46.00	-9.57	Vertical
268.7212	24.20	18.32	42.52	46.00	-3.48	Horizontal
312.5482	24.68	19.13	43.81	46.00	-2.19	Horizontal
346.0740	22.50	20.37	42.89	46.00	-3.11	Horizontal

For 1GHz-25GHz

Corrected Factor = Antenna Factor + Cable Loss – Amplifier Gain

Frequency (MHz)	Reading(dBμV/m)		Factor Corr. (dB)	Result(dBμV/m)		Limit(dBμV/m)		Margin(dBμV/m)		Polarization
	AV	PEAK		AV	PEAK	AV	PEAK	AV	PEAK	
-	-	-	-	-	-	-	-	-	-	Vertical
-	-	-	-	-	-	-	-	-	-	Horizontal

Note: 1. Emissions attenuated more than 20 dB below the permissible value are not reported.

2. *: Denotes restricted band of operation.

3. The fundamental radiated emissions were reduced by Band Reject Filter in the attached plots.

Date of Test:	October 22, 2012	Temperature:	25°C
EUT:	Mobile Internet Device	Humidity:	50%
Model No.:	P804	Power Supply:	AC 120V/60HZ
Test Mode:	802.11b Channel Middle 2437MHz	Test Engineer:	Pei

For Below 30MHz

Frequency (MHz)	Reading (dBμV/m)	Factor(dB) Corr.	Result (dBμV/m)	Limit (dBμV/m)	Margin (dB)	Polarization
	QP		QP	QP	QP	
-	-	-	-	-	-	X
-	-	-	-	-	-	Y
-	-	-	-	-	-	Z

For 30MHz-1000MHz

Corrected Factor = Antenna Factor + Cable Loss – Amplifier Gain

Frequency (MHz)	Reading (dBμV/m)	Factor Corr. (dB)	Result (dBμV/m)	Limit (dBμV/m)	Margin (dB)	Polarization
	QP		QP	QP	QP	
154.2427	20.32	11.56	31.88	43.50	-11.62	Vertical
268.7212	15.32	18.32	33.64	46.00	-12.36	Vertical
312.5482	17.03	19.13	36.16	46.00	-9.84	Vertical
268.7212	25.14	18.32	43.46	46.00	-2.54	Horizontal
312.5482	25.46	19.13	44.59	46.00	-1.41	Horizontal
346.0740	21.12	20.37	41.49	46.00	-4.51	Horizontal

For 1GHz-25GHz

Corrected Factor = Antenna Factor + Cable Loss – Amplifier Gain

Frequency (MHz)	Reading(dBμV/m)		Factor Corr. (dB)	Result(dBμV/m)		Limit(dBμV/m)		Margin(dBμV/m)		Polarization
	AV	PEAK		AV	PEAK	AV	PEAK	AV	PEAK	
-	-	-	-	-	-	-	-	-	-	Vertical
-	-	-	-	-	-	-	-	-	-	Horizontal

Note: 1. Emissions attenuated more than 20 dB below the permissible value are not reported.

2. *: Denotes restricted band of operation.

3. The fundamental radiated emissions were reduced by Band Reject Filter in the attached plots.

Date of Test:	October 22, 2012	Temperature:	25°C
EUT:	Mobile Internet Device	Humidity:	50%
Model No.:	P804	Power Supply:	AC 120V/60HZ
Test Mode:	802.11b Channel High 2462MHz	Test Engineer:	Pei

For Below 30MHz

Frequency (MHz)	Reading (dBμV/m)	Factor(dB) Corr.	Result (dBμV/m)	Limit (dBμV/m)	Margin (dB)	Polarization
	QP		QP	QP	QP	
-	-	-	-	-	-	X
-	-	-	-	-	-	Y
-	-	-	-	-	-	Z

For 30MHz-1000MHz

Corrected Factor = Antenna Factor + Cable Loss – Amplifier Gain

Frequency (MHz)	Reading (dBμV/m)	Factor Corr. (dB)	Result (dBμV/m)	Limit (dBμV/m)	Margin (dB)	Polarization
	QP		QP	QP	QP	
154.2428	21.42	11.56	32.98	43.50	-10.52	Vertical
312.5482	16.89	19.13	36.02	46.00	-9.98	Vertical
412.5395	13.13	22.96	36.09	46.00	-9.91	Vertical
268.7212	24.76	18.32	43.08	46.00	-2.92	Horizontal
312.5482	24.26	19.13	43.39	46.00	-2.61	Horizontal
346.0740	20.99	20.37	41.36	46.00	-4.64	Horizontal

For 1GHz-25GHz

Corrected Factor = Antenna Factor + Cable Loss – Amplifier Gain

Frequency (MHz)	Reading(dBμV/m)		Factor Corr. (dB)	Result(dBμV/m)		Limit(dBμV/m)		Margin(dBμV/m)		Polarization
	AV	PEAK		AV	PEAK	AV	PEAK	AV	PEAK	
-	-	-	-	-	-	-	-	-	-	Vertical
-	-	-	-	-	-	-	-	-	-	Horizontal

Note: 1. Emissions attenuated more than 20 dB below the permissible value are not reported.**2. *: Denotes restricted band of operation.****3. The fundamental radiated emissions were reduced by Band Reject Filter in the attached plots.**

Date of Test:	October 22, 2012	Temperature:	25°C
EUT:	Mobile Internet Device	Humidity:	50%
Model No.:	P804	Power Supply:	AC 120V/60HZ
Test Mode:	802.11g Channel Low 2412MHz	Test Engineer:	Pei

For Below 30MHz

Frequency (MHz)	Reading (dBμV/m)	Factor(dB) Corr.	Result (dBμV/m)	Limit (dBμV/m)	Margin (dB)	Polarization
	QP		QP	QP	QP	
-	-	-	-	-	-	X
-	-	-	-	-	-	Y
-	-	-	-	-	-	Z

For 30MHz-1000MHz

Corrected Factor = Antenna Factor + Cable Loss – Amplifier Gain

Frequency (MHz)	Reading (dBμV/m)	Factor Corr. (dB)	Result (dBμV/m)	Limit (dBμV/m)	Margin (dB)	Polarization
	QP		QP	QP	QP	
231.0398	15.83	16.05	31.88	46.00	-14.12	Vertical
268.7212	14.95	18.32	33.27	46.00	-12.73	Vertical
312.5482	17.33	19.13	36.46	46.00	-9.54	Vertical
268.7212	24.72	18.32	43.04	46.00	-2.96	Horizontal
312.5482	24.90	19.13	44.03	46.00	-1.97	Horizontal
346.0740	21.04	20.37	41.41	46.00	-4.59	Horizontal

For 1GHz-25GHz

Corrected Factor = Antenna Factor + Cable Loss – Amplifier Gain

Frequency (MHz)	Reading(dBμV/m)		Factor Corr. (dB)	Result(dBμV/m)		Limit(dBμV/m)		Margin(dBμV/m)		Polarization
	AV	PEAK		AV	PEAK	AV	PEAK	AV	PEAK	
-	-	-	-	-	-	-	-	-	-	Vertical
-	-	-	-	-	-	-	-	-	-	Horizontal

Note: 1. Emissions attenuated more than 20 dB below the permissible value are not reported.

2. *: Denotes restricted band of operation.

3. The fundamental radiated emissions were reduced by Band Reject Filter in the attached plots.

Date of Test:	October 22, 2012	Temperature:	25°C
EUT:	Mobile Internet Device	Humidity:	50%
Model No.:	P804	Power Supply:	AC 120V/60HZ
Test Mode:	802.11g Channel Middle 2437MHz	Test Engineer:	Pei

For Below 30MHz

Frequency (MHz)	Reading (dBμV/m)		Factor(dB) Corr.	Result (dBμV/m)		Limit (dBμV/m)	Margin (dB)		Polarization
	QP			QP			QP		
-	-	-	-	-	-	-	-	-	X
-	-	-	-	-	-	-	-	-	Y
-	-	-	-	-	-	-	-	-	Z

For 30MHz-1000MHz

Corrected Factor = Antenna Factor + Cable Loss – Amplifier Gain

Frequency (MHz)	Reading (dBμV/m)		Factor Corr. (dB)	Result (dBμV/m)		Limit (dBμV/m)	Margin (dB)		Polarization
	QP			QP			QP		
154.2428	21.07		11.56	32.63		43.50	-10.87		Vertical
312.5482	16.67		19.13	35.80		46.00	-10.20		Vertical
402.5168	16.76		22.39	39.15		46.00	-6.85		Vertical
154.2427	27.51		11.56	39.07		43.50	-4.43		Horizontal
268.7212	25.47		18.32	43.79		46.00	-2.21		Horizontal
312.5482	23.62		19.13	42.75		46.00	-3.25		Horizontal

For 1GHz-25GHz

Corrected Factor = Antenna Factor + Cable Loss – Amplifier Gain

Frequency (MHz)	Reading(dBμV/m)		Factor Corr. (dB)	Result(dBμV/m)		Limit(dBμV/m)		Margin(dBμV/m)		Polarization
	AV	PEAK		AV	PEAK	AV	PEAK	AV	PEAK	
-	-	-	-	-	-	-	-	-	-	Vertical
-	-	-	-	-	-	-	-	-	-	Horizontal

Note: 1. Emissions attenuated more than 20 dB below the permissible value are not reported.**2. *: Denotes restricted band of operation.****3. The fundamental radiated emissions were reduced by Band Reject Filter in the attached plots.**

Date of Test:	October 22, 2012	Temperature:	25°C
EUT:	Mobile Internet Device	Humidity:	50%
Model No.:	P804	Power Supply:	AC 120V/60HZ
Test Mode:	802.11g Channel High 2462MHz	Test Engineer:	Pei

For Below 30MHz

Frequency (MHz)	Reading (dBμV/m)	Factor(dB) Corr.	Result (dBμV/m)	Limit (dBμV/m)	Margin (dB)	Polarization
	QP		QP	QP	QP	
-	-	-	-	-	-	X
-	-	-	-	-	-	Y
-	-	-	-	-	-	Z

For 30MHz-1000MHz

Corrected Factor = Antenna Factor + Cable Loss – Amplifier Gain

Frequency (MHz)	Reading (dBμV/m)	Factor Corr. (dB)	Result (dBμV/m)	Limit (dBμV/m)	Margin (dB)	Polarization
	QP		QP	QP	QP	
154.2427	22.79	11.56	34.35	43.50	-9.15	Vertical
312.5482	17.18	19.13	36.31	46.00	-9.69	Vertical
402.5167	14.46	22.39	36.85	46.00	-9.15	Vertical
268.7212	25.14	18.32	43.46	46.00	-2.54	Horizontal
312.5482	24.78	19.13	43.91	46.00	-2.09	Horizontal
346.0740	21.20	20.37	41.57	46.00	-4.43	Horizontal

For 1GHz-25GHz

Corrected Factor = Antenna Factor + Cable Loss – Amplifier Gain

Frequency (MHz)	Reading(dBμV/m)		Factor Corr. (dB)	Result(dBμV/m)		Limit(dBμV/m)		Margin(dBμV/m)		Polarization
	AV	PEAK		AV	PEAK	AV	PEAK	AV	PEAK	
-	-	-	-	-	-	-	-	-	-	Vertical
-	-	-	-	-	-	-	-	-	-	Horizontal

Note: 1. Emissions attenuated more than 20 dB below the permissible value are not reported.**2. *: Denotes restricted band of operation.****3. The fundamental radiated emissions were reduced by Band Reject Filter in the attached plots.**

Date of Test:	<u>October 22, 2012</u>	Temperature:	<u>25°C</u>
EUT:	<u>Mobile Internet Device</u>	Humidity:	<u>50%</u>
Model No.:	<u>P804</u>	Power Supply:	<u>AC 120V/60HZ</u>
	<u>802.11n Channel Low 2412MHz</u>		
Test Mode:	<u>(20MHz)</u>	Test Engineer:	<u>Pei</u>

For Below 30MHz

Frequency (MHz)	Reading (dBμV/m)	Factor(dB) Corr.	Result (dBμV/m)	Limit (dBμV/m)	Margin (dB)	Polarization
	QP		QP	QP	QP	
-	-	-	-	-	-	X
-	-	-	-	-	-	Y
-	-	-	-	-	-	Z

For 30MHz-1000MHz

Corrected Factor = Antenna Factor + Cable Loss – Amplifier Gain

Frequency (MHz)	Reading (dBμV/m)	Factor Corr. (dB)	Result (dBμV/m)	Limit (dBμV/m)	Margin (dB)	Polarization
	QP		QP	QP	QP	
154.2428	20.65	11.56	32.21	43.50	-11.29	Vertical
268.7212	14.78	18.32	33.10	46.00	-12.90	Vertical
312.5482	17.32	19.13	36.45	46.00	-9.55	Vertical
268.7212	24.89	18.32	43.21	46.00	-2.79	Horizontal
312.5482	24.87	19.13	44.00	46.00	-2.00	Horizontal
346.0740	21.20	20.37	41.57	46.00	-4.43	Horizontal

For 1GHz-25GHz

Corrected Factor = Antenna Factor + Cable Loss – Amplifier Gain

Frequency (MHz)	Reading(dBμV/m)		Factor Corr. (dB)	Result(dBμV/m)		Limit(dBμV/m)		Margin(dBμV/m)		Polarization
	AV	PEAK		AV	PEAK	AV	PEAK	AV	PEAK	
-	-	-	-	-	-	-	-	-	-	Vertical
-	-	-	-	-	-	-	-	-	-	Horizontal

Note: 1. Emissions attenuated more than 20 dB below the permissible value are not reported.

2. *: Denotes restricted band of operation.

3. The fundamental radiated emissions were reduced by Band Reject Filter in the attached plots.

Date of Test:	<u>October 22, 2012</u>	Temperature:	<u>25°C</u>
EUT:	<u>Mobile Internet Device</u>	Humidity:	<u>50%</u>
Model No.:	<u>P804</u>	Power Supply:	<u>AC 120V/60HZ</u>
Test Mode:	<u>802.11n Channel Middle 2437MHz (20MHz)</u>	Test Engineer:	<u>Pei</u>

For Below 30MHz

Frequency (MHz)	Reading (dBμV/m)	Factor(dB) Corr.	Result (dBμV/m)	Limit (dBμV/m)	Margin (dB)	Polarization
	QP		QP	QP	QP	
-	-	-	-	-	-	X
-	-	-	-	-	-	Y
-	-	-	-	-	-	Z

For 30MHz-1000MHz

Corrected Factor = Antenna Factor + Cable Loss – Amplifier Gain

Frequency (MHz)	Reading (dBμV/m)	Factor Corr. (dB)	Result (dBμV/m)	Limit (dBμV/m)	Margin (dB)	Polarization
	QP		QP	QP	QP	
154.2427	22.93	11.56	34.49	43.50	-9.01	Vertical
268.7212	14.03	18.32	32.35	46.00	-13.65	Vertical
312.5482	17.56	19.13	36.69	46.00	-9.31	Vertical
268.7212	25.14	18.32	43.46	46.00	-2.54	Horizontal
312.5482	24.78	19.13	43.91	46.00	-2.09	Horizontal
346.0740	20.95	20.37	41.32	46.00	-4.68	Horizontal

For 1GHz-25GHz

Corrected Factor = Antenna Factor + Cable Loss – Amplifier Gain

Frequency (MHz)	Reading(dBμV/m)		Factor Corr. (dB)	Result(dBμV/m)		Limit(dBμV/m)		Margin(dBμV/m)		Polarization
	AV	PEAK		AV	PEAK	AV	PEAK	AV	PEAK	
-	-	-	-	-	-	-	-	-	-	Vertical
-	-	-	-	-	-	-	-	-	-	Horizontal

Note: 1. Emissions attenuated more than 20 dB below the permissible value are not reported.

2. *: Denotes restricted band of operation.

3. The fundamental radiated emissions were reduced by Band Reject Filter in the attached plots.

Date of Test:	<u>October 22, 2012</u>	Temperature:	<u>25°C</u>
EUT:	<u>Mobile Internet Device</u>	Humidity:	<u>50%</u>
Model No.:	<u>P804</u>	Power Supply:	<u>AC 120V/60HZ</u>
Test Mode:	<u>802.11n Channel High 2462MHz</u> <u>(20MHz)</u>	Test Engineer:	<u>Pei</u>

For Below 30MHz

Frequency (MHz)	Reading (dBμV/m)	Factor(dB) Corr.	Result (dBμV/m)	Limit (dBμV/m)	Margin (dB)	Polarization
	QP		QP	QP	QP	
-	-	-	-	-	-	X
-	-	-	-	-	-	Y
-	-	-	-	-	-	Z

For 30MHz-1000MHz

Corrected Factor = Antenna Factor + Cable Loss – Amplifier Gain

Frequency (MHz)	Reading (dBμV/m)	Factor Corr. (dB)	Result (dBμV/m)	Limit (dBμV/m)	Margin (dB)	Polarization
	QP		QP	QP	QP	
154.2428	21.79	11.56	33.35	43.50	-10.15	Vertical
231.0399	16.98	16.05	33.03	46.00	-12.97	Vertical
312.5482	17.03	19.13	36.16	46.00	-9.84	Vertical
268.7212	24.32	18.32	42.64	46.00	-3.36	Horizontal
312.5482	24.79	19.13	43.92	46.00	-2.08	Horizontal
346.0740	21.02	20.37	41.39	46.00	-4.61	Horizontal

For 1GHz-25GHz

Corrected Factor = Antenna Factor + Cable Loss – Amplifier Gain

Frequency (MHz)	Reading(dBμV/m)		Factor Corr. (dB)	Result(dBμV/m)		Limit(dBμV/m)		Margin(dBμV/m)		Polarization
	AV	PEAK		AV	PEAK	AV	PEAK	AV	PEAK	
-	-	-	-	-	-	-	-	-	-	Vertical
-	-	-	-	-	-	-	-	-	-	Horizontal

Note: 1. Emissions attenuated more than 20 dB below the permissible value are not reported.**2. *: Denotes restricted band of operation.****3. The fundamental radiated emissions were reduced by Band Reject Filter in the attached plots.**

Date of Test:	<u>October 22, 2012</u>	Temperature:	<u>25°C</u>
EUT:	<u>Mobile Internet Device</u>	Humidity:	<u>50%</u>
Model No.:	<u>P804</u>	Power Supply:	<u>AC 120V/60HZ</u>
Test Mode:	<u>802.11n Channel Low 2422MHz (40MHz)</u>	Test Engineer:	<u>Pei</u>

For Below 30MHz

Frequency (MHz)	Reading (dBμV/m)	Factor(dB) Corr.	Result (dBμV/m)	Limit (dBμV/m)	Margin (dB)	Polarization
	QP		QP	QP	QP	
-	-	-	-	-	-	X
-	-	-	-	-	-	Y
-	-	-	-	-	-	Z

For 30MHz-1000MHz

Corrected Factor = Antenna Factor + Cable Loss – Amplifier Gain

Frequency (MHz)	Reading (dBμV/m)	Factor Corr. (dB)	Result (dBμV/m)	Limit (dBμV/m)	Margin (dB)	Polarization
	QP		QP	QP	QP	
154.2427	21.12	11.56	32.68	43.50	-10.82	Vertical
268.7212	14.29	18.32	32.61	46.00	-13.39	Vertical
312.5482	17.01	19.13	36.14	46.00	-9.86	Vertical
268.7212	24.49	18.32	42.81	46.00	-3.19	Horizontal
312.5482	25.31	19.13	44.44	46.00	-1.56	Horizontal
346.0740	21.38	20.37	41.75	46.00	-4.25	Horizontal

For 1GHz-25GHz

Corrected Factor = Antenna Factor + Cable Loss – Amplifier Gain

Frequency (MHz)	Reading(dBμV/m)		Factor Corr. (dB)	Result(dBμV/m)		Limit(dBμV/m)		Margin(dBμV/m)		Polarization
	AV	PEAK		AV	PEAK	AV	PEAK	AV	PEAK	
-	-	-	-	-	-	-	-	-	-	Vertical
-	-	-	-	-	-	-	-	-	-	Horizontal

Note: 1. Emissions attenuated more than 20 dB below the permissible value are not reported.

2. *: Denotes restricted band of operation.

3. The fundamental radiated emissions were reduced by Band Reject Filter in the attached plots.

Date of Test:	<u>October 22, 2012</u>	Temperature:	<u>25°C</u>
EUT:	<u>Mobile Internet Device</u>	Humidity:	<u>50%</u>
Model No.:	<u>P804</u>	Power Supply:	<u>AC 120V/60HZ</u>
Test Mode:	<u>802.11n Channel Middle 2437MHz (40MHz)</u>	Test Engineer:	<u>Pei</u>

For Below 30MHz

Frequency (MHz)	Reading (dBμV/m)	Factor(dB) Corr.	Result (dBμV/m)	Limit (dBμV/m)	Margin (dB)	Polarization
	QP		QP	QP	QP	
-	-	-	-	-	-	X
-	-	-	-	-	-	Y
-	-	-	-	-	-	Z

For 30MHz-1000MHz

Corrected Factor = Antenna Factor + Cable Loss – Amplifier Gain

Frequency (MHz)	Reading (dBμV/m)	Factor Corr. (dB)	Result (dBμV/m)	Limit (dBμV/m)	Margin (dB)	Polarization
	QP		QP	QP	QP	
268.7212	24.73	18.32	43.05	46.00	-2.95	Vertical
313.6482	25.00	19.15	44.15	46.00	-1.85	Vertical
346.0740	21.23	20.37	41.60	46.00	-4.04	Vertical
154.2428	20.64	11.56	32.20	43.50	-11.30	Horizontal
268.7212	15.20	18.32	33.52	46.00	-12.47	Horizontal
312.5482	16.90	19.13	36.03	46.00	-9.97	Horizontal

For 1GHz-25GHz

Corrected Factor = Antenna Factor + Cable Loss – Amplifier Gain

Frequency (MHz)	Reading(dBμV/m)		Factor Corr. (dB)	Result(dBμV/m)		Limit(dBμV/m)		Margin(dBμV/m)		Polarization
	AV	PEAK		AV	PEAK	AV	PEAK	AV	PEAK	
-	-	-	-	-	-	-	-	-	-	Vertical
-	-	-	-	-	-	-	-	-	-	Horizontal

Note: 1. Emissions attenuated more than 20 dB below the permissible value are not reported.

2. *: Denotes restricted band of operation.

3. The fundamental radiated emissions were reduced by Band Reject Filter in the attached plots.

Date of Test:	<u>October 22, 2012</u>	Temperature:	<u>25°C</u>
EUT:	<u>Mobile Internet Device</u>	Humidity:	<u>50%</u>
Model No.:	<u>P804</u>	Power Supply:	<u>AC 120V/60HZ</u>
Test Mode:	<u>802.11n Channel High 2452MHz</u> <u>(40MHz)</u>	Test Engineer:	<u>Pei</u>

For Below 30MHz

Frequency (MHz)	Reading (dBμV/m)	Factor(dB) Corr.	Result (dBμV/m)	Limit (dBμV/m)	Margin (dB)	Polarization
	QP		QP	QP	QP	
-	-	-	-	-	-	X
-	-	-	-	-	-	Y
-	-	-	-	-	-	Z

For 30MHz-1000MHz

Corrected Factor = Antenna Factor + Cable Loss – Amplifier Gain

Frequency (MHz)	Reading (dBμV/m)	Factor Corr. (dB)	Result (dBμV/m)	Limit (dBμV/m)	Margin (dB)	Polarization
	QP		QP	QP	QP	
154.2427	21.06	11.56	32.62	43.50	-10.88	Vertical
268.7212	13.50	18.32	31.82	46.00	-14.18	Vertical
312.5482	17.72	19.13	36.85	46.00	-9.15	Vertical
280.2936	24.61	18.29	42.90	46.00	-3.10	Horizontal
312.5482	25.46	19.13	44.59	46.00	-1.41	Horizontal
346.0740	21.28	20.37	41.65	46.00	-4.35	Horizontal

For 1GHz-25GHz

Corrected Factor = Antenna Factor + Cable Loss – Amplifier Gain

Frequency (MHz)	Reading(dBμV/m)		Factor Corr. (dB)	Result(dBμV/m)		Limit(dBμV/m)		Margin(dBμV/m)		Polarization
	AV	PEAK		AV	PEAK	AV	PEAK	AV	PEAK	
-	-	-	-	-	-	-	-	-	-	Vertical
-	-	-	-	-	-	-	-	-	-	Horizontal

- Note: 1. Emissions attenuated more than 20 dB below the permissible value are not reported.**
- 2. *: Denotes restricted band of operation.**
- 3. The fundamental radiated emissions were reduced by Band Reject Filter in the attached plots.**



ACCURATE TECHNOLOGY CO., LTD.

F1,Bldg,A,Changyuan New Material Port Keyuan Rd,
Science & Industry Park,Nanshan Shenzhen,P.R.China

Site: 966 chamber
Tel:+86-0755-26503290
Fax:+86-0755-26503396

Job No.: star #2485

Standard: FCC Class B 3M Radiated

Test item: Radiation Test

Temp.(C)/Hum.(%) 23 C / 49 %

EUT: Mobile internet device

Mode: TX Channel 1(802.11b)

Model: P804

Manufacturer: Pipo

Polarization: Horizontal

Power Source: AC 120V/60Hz

Date: 12/10/22/

Time: 8/28/28

Engineer Signature:

Distance: 3m

Note: Report No.:ATE20122384

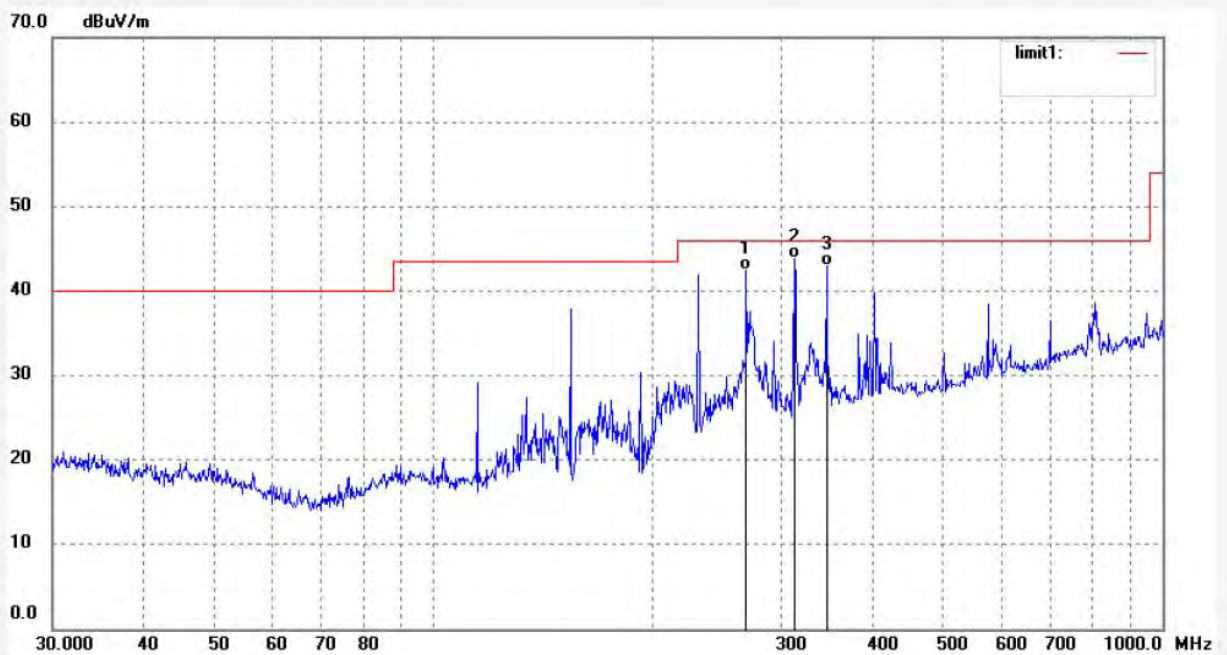

No.	Freq. (MHz)	Reading (dBuV/m)	Factor (dB)	Result (dBuV/m)	Limit (dBuV/m)	Margin (dB)	Detector	Height (cm)	Degree (deg.)	Remark
1	268.7212	24.20	18.32	42.52	46.00	-3.48	QP			
2	312.5482	24.68	19.13	43.81	46.00	-2.19	QP			
3	346.0740	22.52	20.37	42.89	46.00	-3.11	QP			



ACCURATE TECHNOLOGY CO., LTD.

F1,Bldg,A,Changyuan New Material Port Keyuan Rd,
Science & Industry Park,Nanshan Shenzhen,P.R.China

Site: 966 chamber
Tel:+86-0755-26503290
Fax:+86-0755-26503396

Job No.: star #2486

Standard: FCC Class B 3M Radiated

Test item: Radiation Test

Temp.(C)/Hum.(%) 23 C / 49 %

EUT: Mobile internet device

Mode: TX Channel 1(802.11b)

Model: P804

Manufacturer: Pipo

Polarization: Vertical

Power Source: AC 120V/60Hz

Date: 12/10/22/

Time: 8/34/10

Engineer Signature:

Distance: 3m

Note: Report No.:ATE20122384

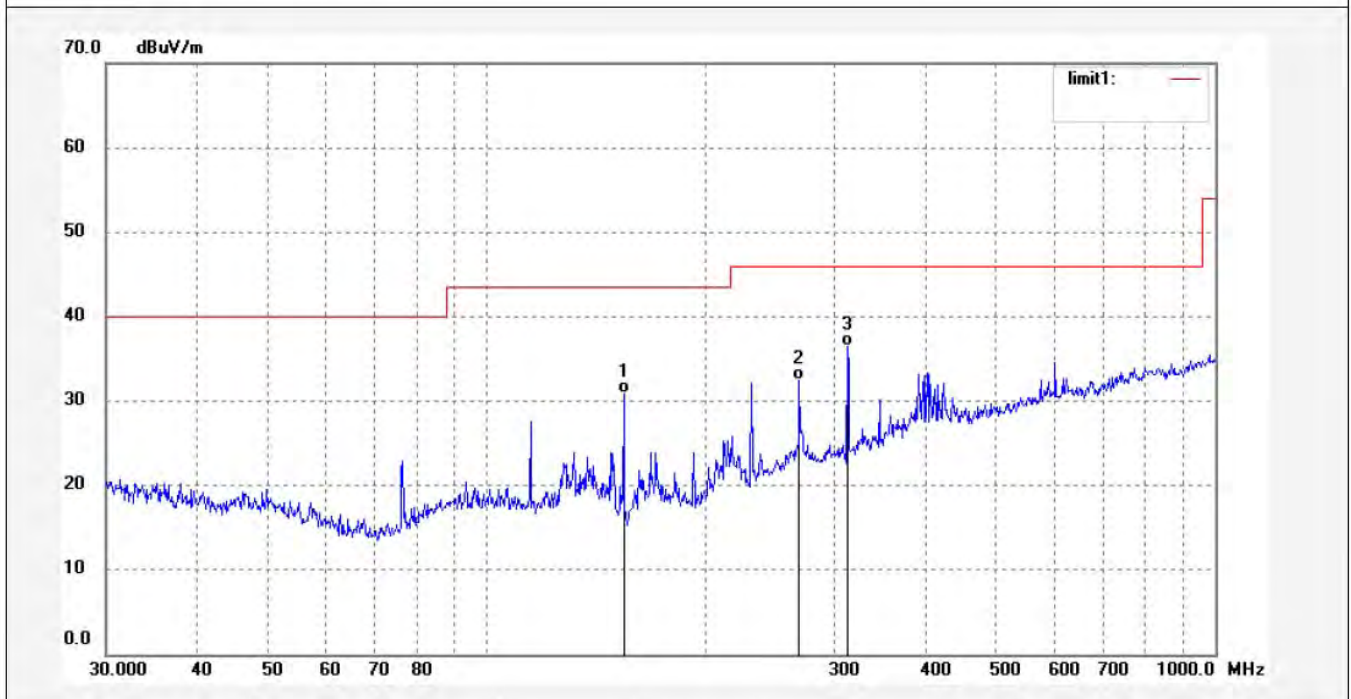

No.	Freq. (MHz)	Reading (dBuV/m)	Factor (dB)	Result (dBuV/m)	Limit (dBuV/m)	Margin (dB)	Detector	Height (cm)	Degree (deg.)	Remark
1	154.2427	19.30	11.56	30.86	43.50	-12.64	QP			
2	268.7212	14.15	18.32	32.47	46.00	-13.53	QP			
3	312.5482	17.30	19.13	36.43	46.00	-9.57	QP			



ACCURATE TECHNOLOGY CO., LTD.

F1,Bldg,A,Changyuan New Material Port Keyuan Rd,
Science & Industry Park,Nanshan Shenzhen,P.R.China

Site: 966 chamber
Tel:+86-0755-26503290
Fax:+86-0755-26503396

Job No.: star #2509
Standard: FCC Class B 3M Radiated
Test item: Radiation Test
Temp.(C)/Hum.(%) 23 C / 49 %
EUT: Mobile internet device
Mode: TX Channel 1(802.11b)
Model: P804
Manufacturer: Pipo

Polarization: Horizontal
Power Source: AC 120V/60Hz
Date: 12/10/22/
Time: 10/02/57
Engineer Signature:
Distance: 3m

Note: Report No.:ATE20122384

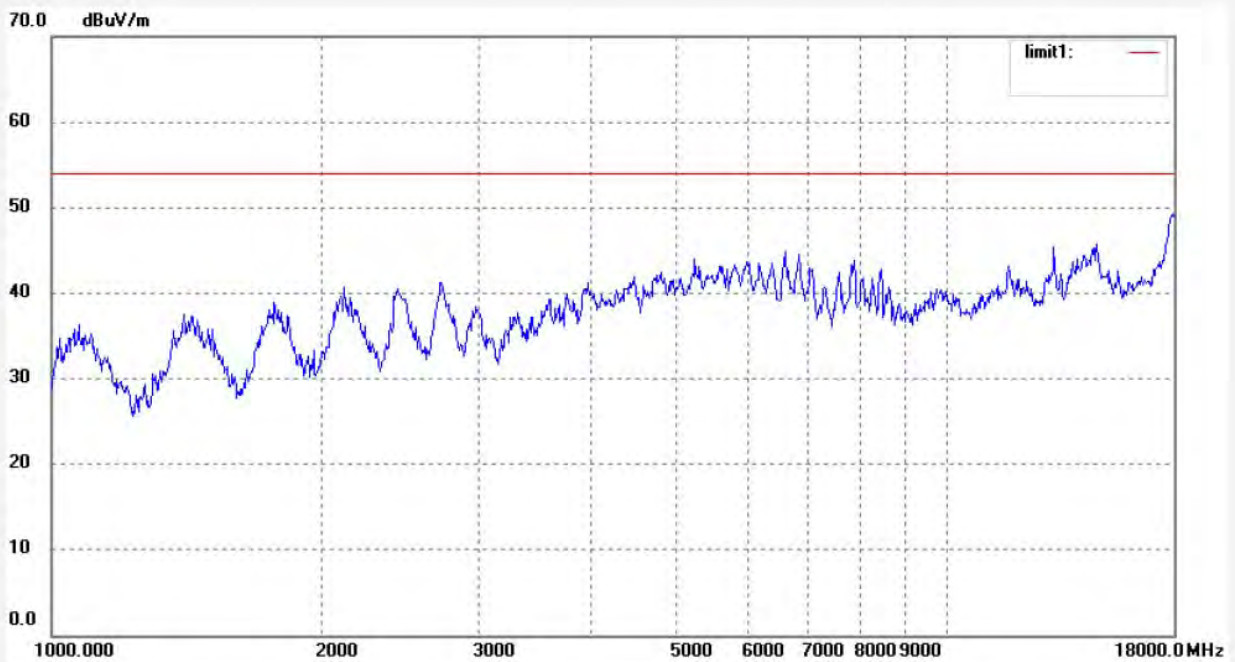

No.	Freq. (MHz)	Reading (dBuV/m)	Factor (dB)	Result (dBuV/m)	Limit (dBuV/m)	Margin (dB)	Detector	Height (cm)	Degree (deg.)	Remark
-----	-------------	------------------	-------------	-----------------	----------------	-------------	----------	-------------	---------------	--------



ACCURATE TECHNOLOGY CO., LTD.

F1,Bldg,A,Changyuan New Material Port Keyuan Rd,
Science & Industry Park,Nanshan Shenzhen,P.R.China

Site: 966 chamber
Tel:+86-0755-26503290
Fax:+86-0755-26503396

Job No.: star #2510	Polarization: Vertical
Standard: FCC Class B 3M Radiated	Power Source: AC 120V/60Hz
Test item: Radiation Test	Date: 12/10/22/
Temp.(C)/Hum.(%) 23 C / 49 %	Time: 10/06/21
EUT: Mobile internet device	Engineer Signature:
Mode: TX Channel 1(802.11b)	Distance: 3m
Model: P804	
Manufacturer: Pipo	

Note: Report No.:ATE20122384

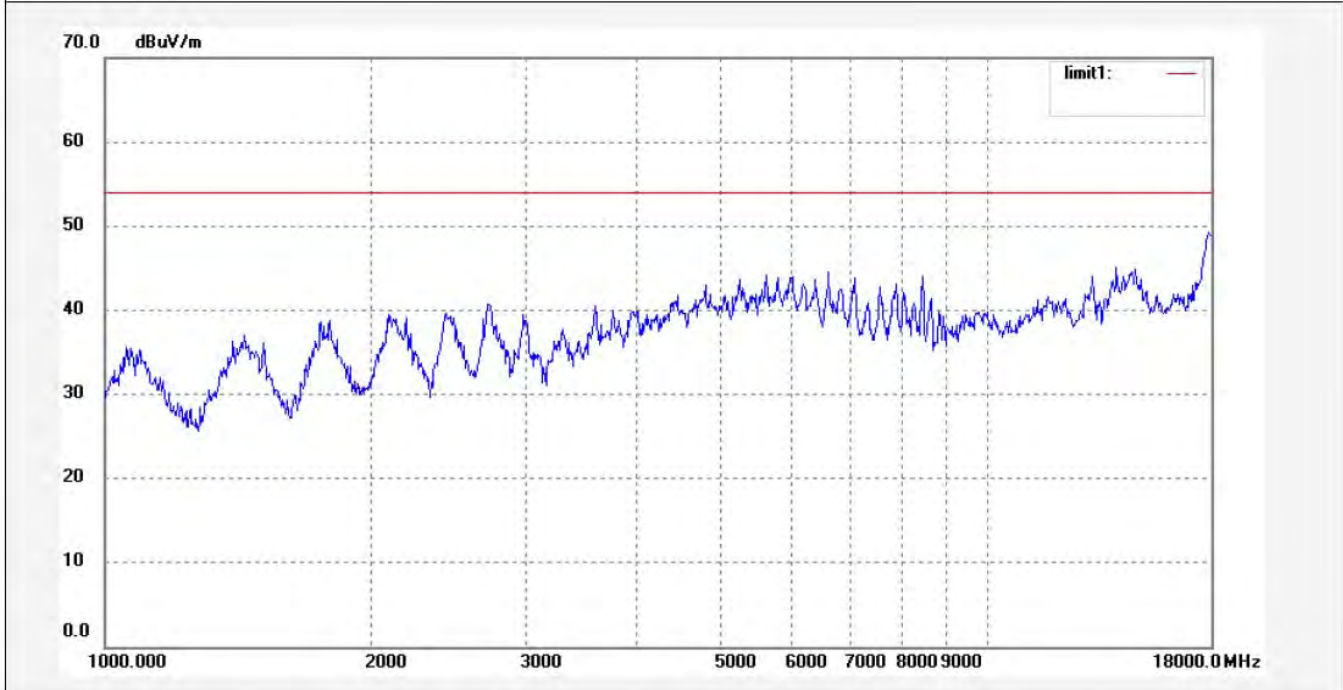

No.	Freq. (MHz)	Reading (dBuV/m)	Factor (dB)	Result (dBuV/m)	Limit (dBuV/m)	Margin (dB)	Detector	Height (cm)	Degree (deg.)	Remark
-----	-------------	------------------	-------------	-----------------	----------------	-------------	----------	-------------	---------------	--------



ACCURATE TECHNOLOGY CO., LTD.

F1,Bldg,A,Changyuan New Material Port Keyuan Rd,
Science & Industry Park,Nanshan Shenzhen,P.R.China

Site: 966 chamber
Tel:+86-0755-26503290
Fax:+86-0755-26503396

Job No.: star #2534	Polarization: Horizontal
Standard: FCC Class B 3M Radiated	Power Source: AC 120V/60Hz
Test item: Radiation Test	Date: 12/10/22/
Temp.(C)/Hum.(%) 23 C / 49 %	Time: 11/40/47
EUT: Mobile internet device	Engineer Signature:
Mode: TX Channel 1(802.11b)	Distance: 3m
Model: P804	
Manufacturer: Pipo	

Note: Report No.:ATE20122384

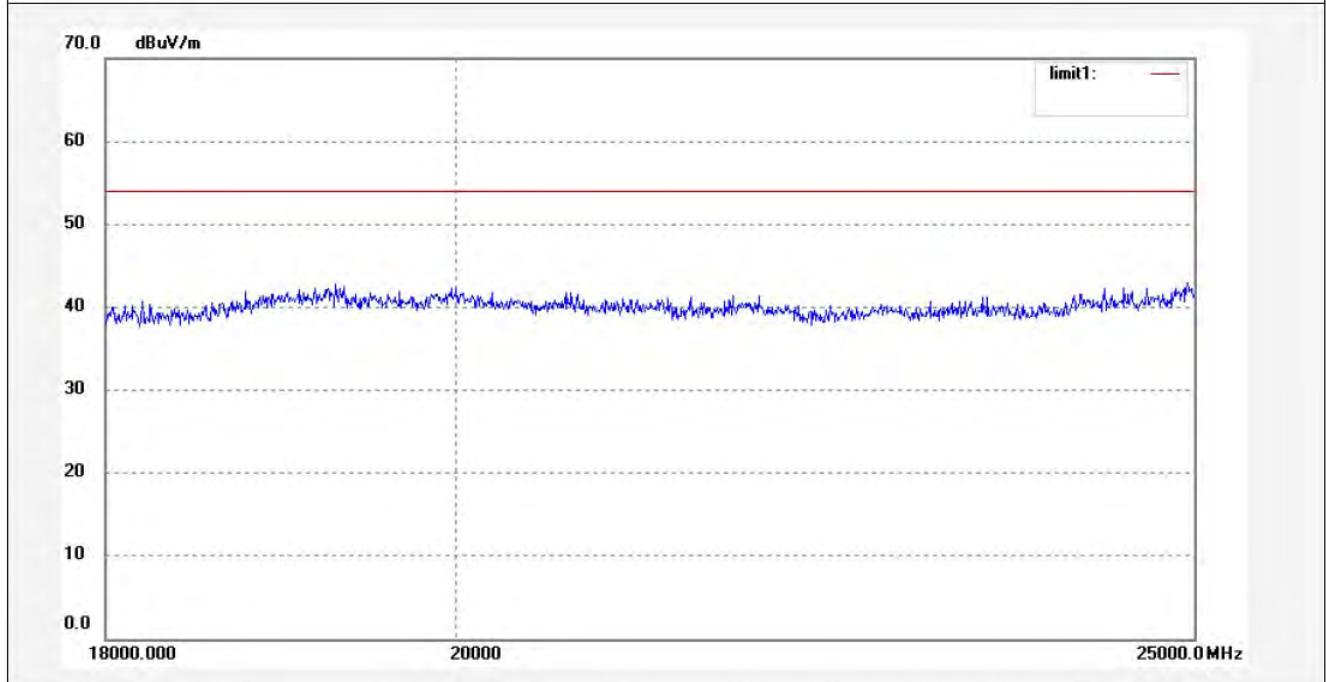

No.	Freq. (MHz)	Reading (dBuV/m)	Factor (dB)	Result (dBuV/m)	Limit (dBuV/m)	Margin (dB)	Detector	Height (cm)	Degree (deg.)	Remark
-----	-------------	------------------	-------------	-----------------	----------------	-------------	----------	-------------	---------------	--------



ACCURATE TECHNOLOGY CO., LTD.

F1,Bldg,A,Changyuan New Material Port Keyuan Rd,
Science & Industry Park,Nanshan Shenzhen,P.R.China

Site: 966 chamber
Tel:+86-0755-26503290
Fax:+86-0755-26503396

Job No.: star #2533	Polarization: Vertical
Standard: FCC Class B 3M Radiated	Power Source: AC 120V/60Hz
Test item: Radiation Test	Date: 12/10/22/
Temp.(C)/Hum.(%) 23 C / 49 %	Time: 11/35/40
EUT: Mobile internet device	Engineer Signature:
Mode: TX Channel 1(802.11b)	Distance: 3m
Model: P804	
Manufacturer: Pipo	

Note: Report No.:ATE20122384

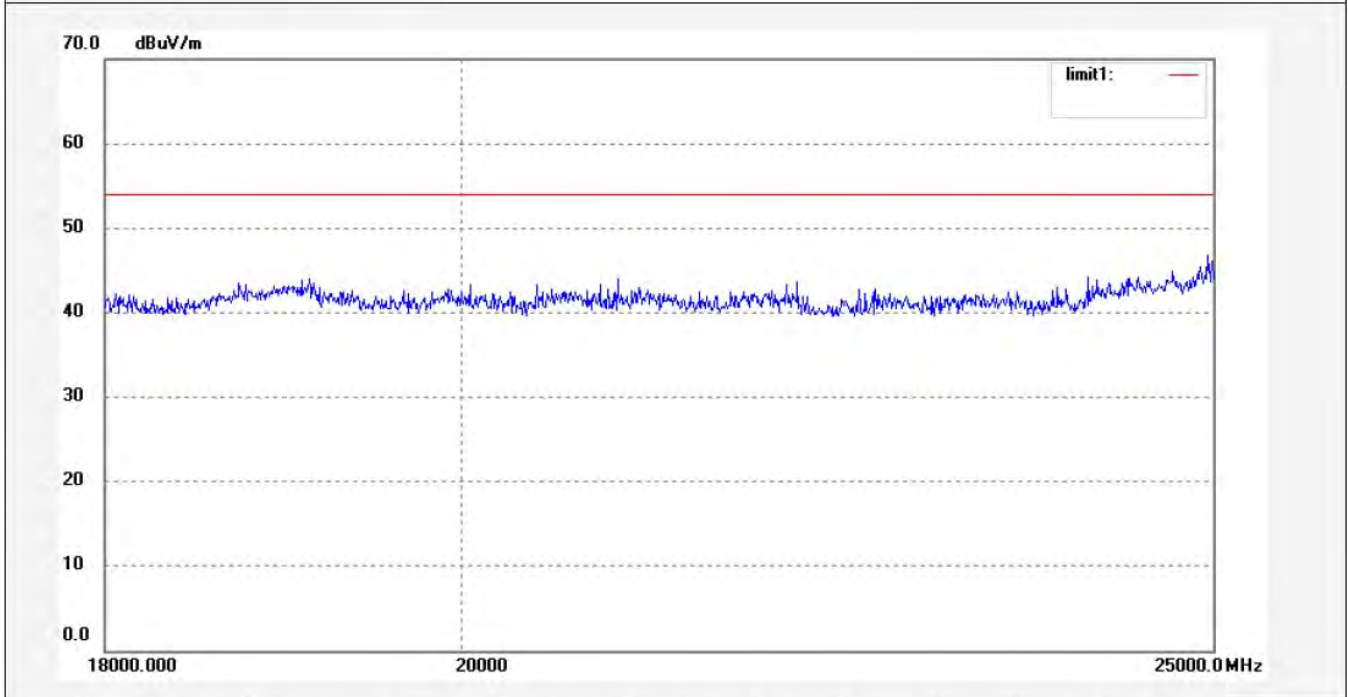

No.	Freq. (MHz)	Reading (dBuV/m)	Factor (dB)	Result (dBuV/m)	Limit (dBuV/m)	Margin (dB)	Detector	Height (cm)	Degree (deg.)	Remark
-----	-------------	------------------	-------------	-----------------	----------------	-------------	----------	-------------	---------------	--------



ACCURATE TECHNOLOGY CO., LTD.

F1,Bldg,A,Changyuan New Material Port Keyuan Rd,
Science & Industry Park,Nanshan Shenzhen,P.R.China

Site: 966 chamber
Tel:+86-0755-26503290
Fax:+86-0755-26503396

Job No.: star #2488	Polarization: Horizontal
Standard: FCC Class B 3M Radiated	Power Source: AC 120V/60Hz
Test item: Radiation Test	Date: 12/10/22/
Temp.(C)/Hum.(%) 23 C / 49 %	Time: 8/42/48
EUT: Mobile internet device	Engineer Signature:
Mode: TX Channel 6(802.11b)	Distance: 3m
Model: P804	
Manufacturer: Pipo	

Note: Report No.:ATE20122384

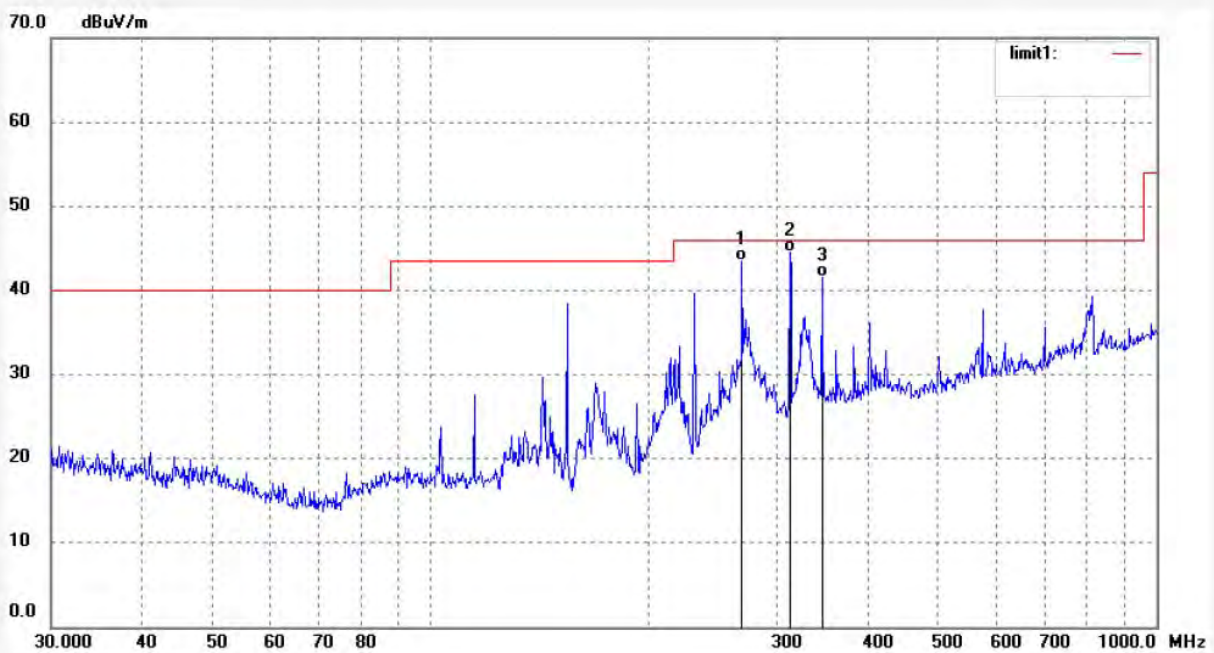

No.	Freq. (MHz)	Reading (dBuV/m)	Factor (dB)	Result (dBuV/m)	Limit (dBuV/m)	Margin (dB)	Detector	Height (cm)	Degree (deg.)	Remark
1	268.7212	25.14	18.32	43.46	46.00	-2.54	QP			
2	312.5482	25.46	19.13	44.59	46.00	-1.41	QP			
3	346.0740	21.12	20.37	41.49	46.00	-4.51	QP			



ACCURATE TECHNOLOGY CO., LTD.

F1,Bldg,A,Changyuan New Material Port Keyuan Rd,
Science & Industry Park,Nanshan Shenzhen,P.R.China

Site: 966 chamber
Tel:+86-0755-26503290
Fax:+86-0755-26503396

Job No.: star #2487	Polarization: Vertical
Standard: FCC Class B 3M Radiated	Power Source: AC 120V/60Hz
Test item: Radiation Test	Date: 12/10/22/
Temp.(C)/Hum.(%) 23 C / 49 %	Time: 8/39/53
EUT: Mobile internet device	Engineer Signature:
Mode: TX Channel 6(802.11b)	Distance: 3m
Model: P804	
Manufacturer: Pipo	

Note: Report No.:ATE20122384

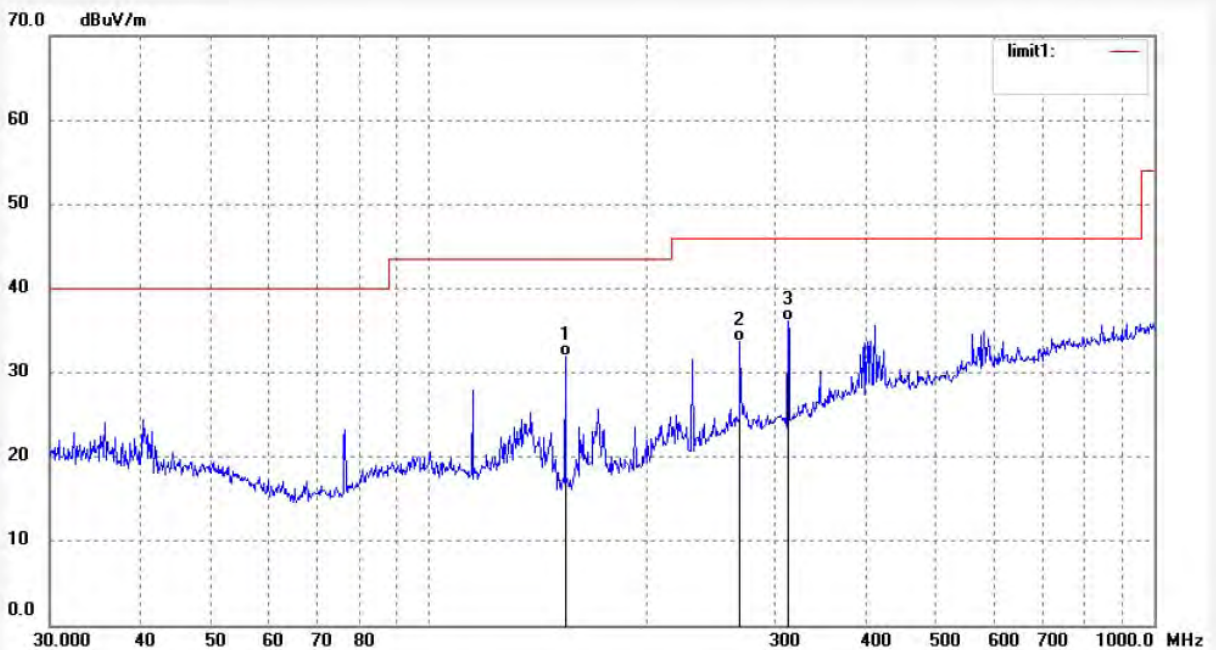

No.	Freq. (MHz)	Reading (dBuV/m)	Factor (dB)	Result (dBuV/m)	Limit (dBuV/m)	Margin (dB)	Detector	Height (cm)	Degree (deg.)	Remark
1	154.2427	20.32	11.56	31.88	43.50	-11.62	QP			
2	268.7212	15.32	18.32	33.64	46.00	-12.36	QP			
3	312.5482	17.03	19.13	36.16	46.00	-9.84	QP			



ACCURATE TECHNOLOGY CO., LTD.

F1,Bldg,A,Changyuan New Material Port Keyuan Rd,
Science & Industry Park,Nanshan Shenzhen,P.R.China

Site: 966 chamber
Tel:+86-0755-26503290
Fax:+86-0755-26503396

Job No.: star #2512
Standard: FCC Class B 3M Radiated
Test item: Radiation Test
Temp.(C)/Hum.(%) 23 C / 49 %
EUT: Mobile internet device
Mode: TX Channel 6(802.11b)
Model: P804
Manufacturer: Pipo

Polarization: Horizontal
Power Source: AC 120V/60Hz
Date: 12/10/22/
Time: 10/14/21
Engineer Signature:
Distance: 3m

Note: Report No.:ATE20122384

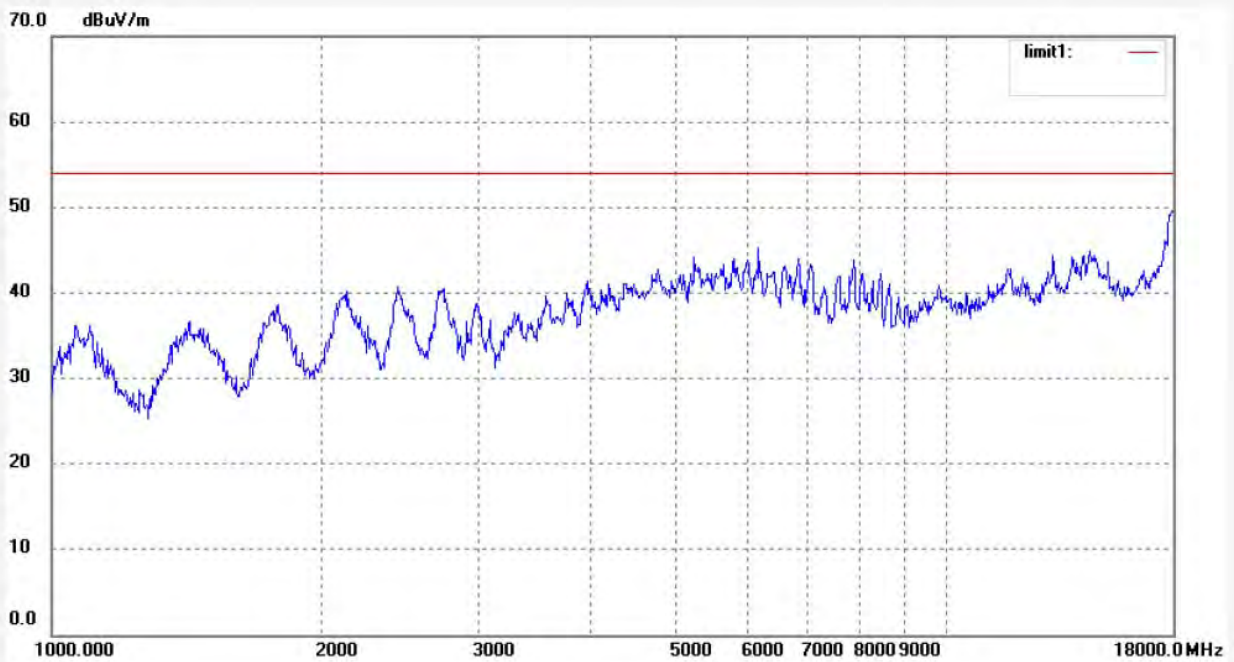

No.	Freq. (MHz)	Reading (dBuV/m)	Factor (dB)	Result (dBuV/m)	Limit (dBuV/m)	Margin (dB)	Detector	Height (cm)	Degree (deg.)	Remark
-----	-------------	------------------	-------------	-----------------	----------------	-------------	----------	-------------	---------------	--------



ACCURATE TECHNOLOGY CO., LTD.

F1,Bldg,A,Changyuan New Material Port Keyuan Rd,
Science & Industry Park,Nanshan Shenzhen,P.R.China

Site: 966 chamber
Tel:+86-0755-26503290
Fax:+86-0755-26503396

Job No.: star #2511
Standard: FCC Class B 3M Radiated
Test item: Radiation Test
Temp.(C)/Hum.(%) 23 C / 49 %
EUT: Mobile internet device
Mode: TX Channel 6(802.11b)
Model: P804
Manufacturer: Pipo

Polarization: Vertical
Power Source: AC 120V/60Hz
Date: 12/10/22/
Time: 10/10/42
Engineer Signature:
Distance: 3m

Note: Report No.:ATE20122384

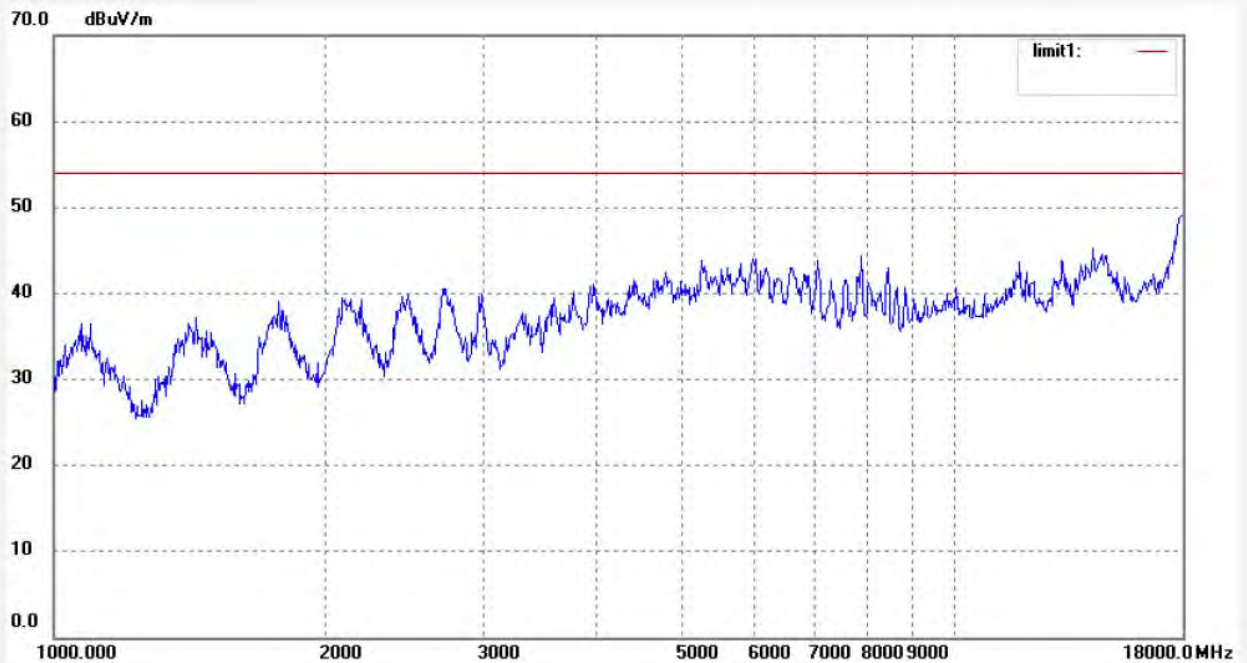

No.	Freq. (MHz)	Reading (dBuV/m)	Factor (dB)	Result (dBuV/m)	Limit (dBuV/m)	Margin (dB)	Detector	Height (cm)	Degree (deg.)	Remark
-----	-------------	------------------	-------------	-----------------	----------------	-------------	----------	-------------	---------------	--------



ACCURATE TECHNOLOGY CO., LTD.

F1,Bldg.A,Changyuan New Material Port Keyuan Rd,
Science & Industry Park,Nanshan Shenzhen,P.R.China

Site: 966 chamber
Tel:+86-0755-26503290
Fax:+86-0755-26503396

Job No.: star #2535	Polarization: Horizontal
Standard: FCC Class B 3M Radiated	Power Source: AC 120V/60Hz
Test item: Radiation Test	Date: 12/10/22/
Temp.(C)/Hum.(%) 23 C / 49 %	Time: 11/43/05
EUT: Mobile internet device	Engineer Signature:
Mode: TX Channel 6(802.11b)	Distance: 3m
Model: P804	
Manufacturer: Pipo	

Note: Report No.:ATE20122384

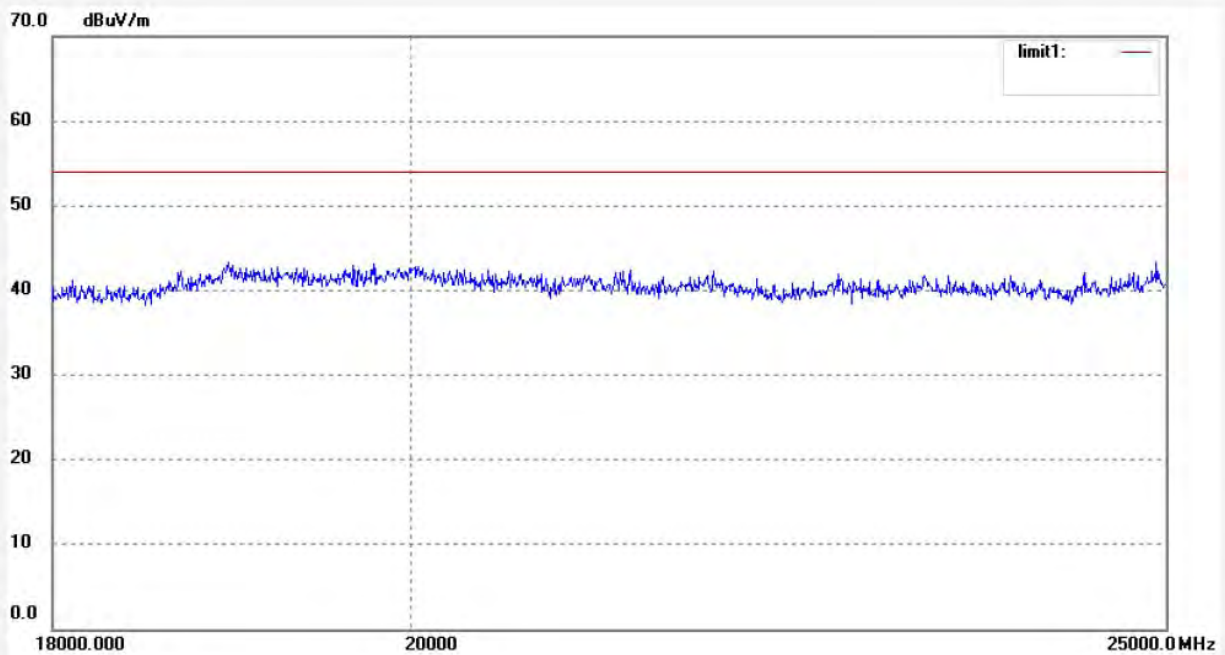

No.	Freq. (MHz)	Reading (dBuV/m)	Factor (dB)	Result (dBuV/m)	Limit (dBuV/m)	Margin (dB)	Detector	Height (cm)	Degree (deg.)	Remark



ACCURATE TECHNOLOGY CO., LTD.

F1,Bldg,A,Changyuan New Material Port Keyuan Rd,
Science & Industry Park,Nanshan Shenzhen,P.R.China

Site: 966 chamber
Tel:+86-0755-26503290
Fax:+86-0755-26503396

Job No.: star #2536	Polarization: Vertical
Standard: FCC Class B 3M Radiated	Power Source: AC 120V/60Hz
Test item: Radiation Test	Date: 12/10/22/
Temp.(C)/Hum.(%) 23 C / 49 %	Time: 11/48/21
EUT: Mobile internet device	Engineer Signature:
Mode: TX Channel 6(802.11b)	Distance: 3m
Model: P804	
Manufacturer: Pipo	

Note: Report No.:ATE20122384

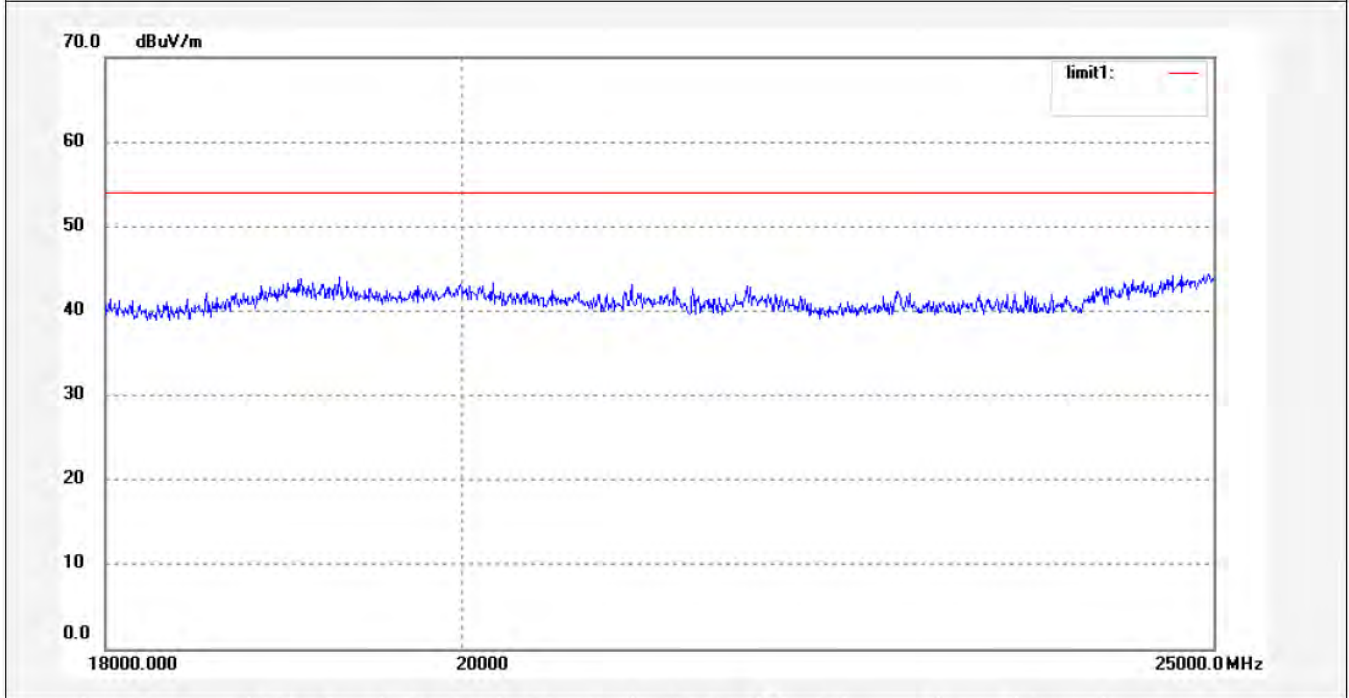

No.	Freq. (MHz)	Reading (dBuV/m)	Factor (dB)	Result (dBuV/m)	Limit (dBuV/m)	Margin (dB)	Detector	Height (cm)	Degree (deg.)	Remark
-----	-------------	------------------	-------------	-----------------	----------------	-------------	----------	-------------	---------------	--------



ACCURATE TECHNOLOGY CO., LTD.

F1,Bldg,A,Changyuan New Material Port Keyuan Rd,
Science & Industry Park,Nanshan Shenzhen,P.R.China

Site: 966 chamber
Tel:+86-0755-26503290
Fax:+86-0755-26503396

Job No.: star #2489	Polarization: Horizontal
Standard: FCC Class B 3M Radiated	Power Source: AC 120V/60Hz
Test item: Radiation Test	Date: 12/10/22/
Temp.(C)/Hum.(%) 23 C / 49 %	Time: 8/46/37
EUT: Mobile internet device	Engineer Signature:
Mode: TX Channel 11(802.11b)	Distance: 3m
Model: P804	
Manufacturer: Pipo	

Note: Report No.:ATE20122384

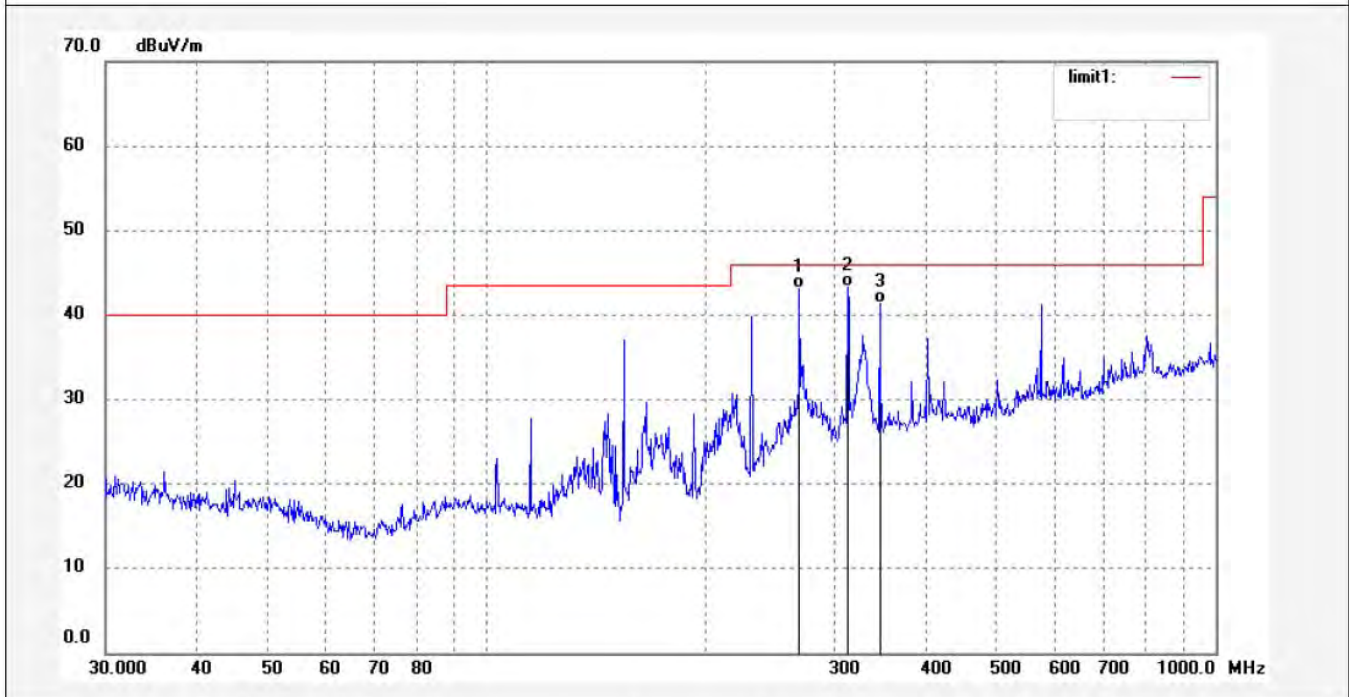

No.	Freq. (MHz)	Reading (dBuV/m)	Factor (dB)	Result (dBuV/m)	Limit (dBuV/m)	Margin (dB)	Detector	Height (cm)	Degree (deg.)	Remark
1	268.7212	24.76	18.32	43.08	46.00	-2.92	QP			
2	312.5482	24.26	19.13	43.39	46.00	-2.61	QP			
3	346.0740	20.99	20.37	41.36	46.00	-4.64	QP			



ACCURATE TECHNOLOGY CO., LTD.

F1,Bldg,A,Changyuan New Material Port Keyuan Rd,
Science & Industry Park,Nanshan Shenzhen,P.R.China

Site: 966 chamber
Tel:+86-0755-26503290
Fax:+86-0755-26503396

Job No.: star #2490
Standard: FCC Class B 3M Radiated
Test item: Radiation Test
Temp.(C)/Hum.(%) 23 C / 49 %
EUT: Mobile internet device
Mode: TX Channel 11(802.11b)
Model: P804
Manufacturer: Pipo

Polarization: Vertical
Power Source: AC 120V/60Hz
Date: 12/10/22/
Time: 8/50/50
Engineer Signature:
Distance: 3m

Note: Report No.:ATE20122384

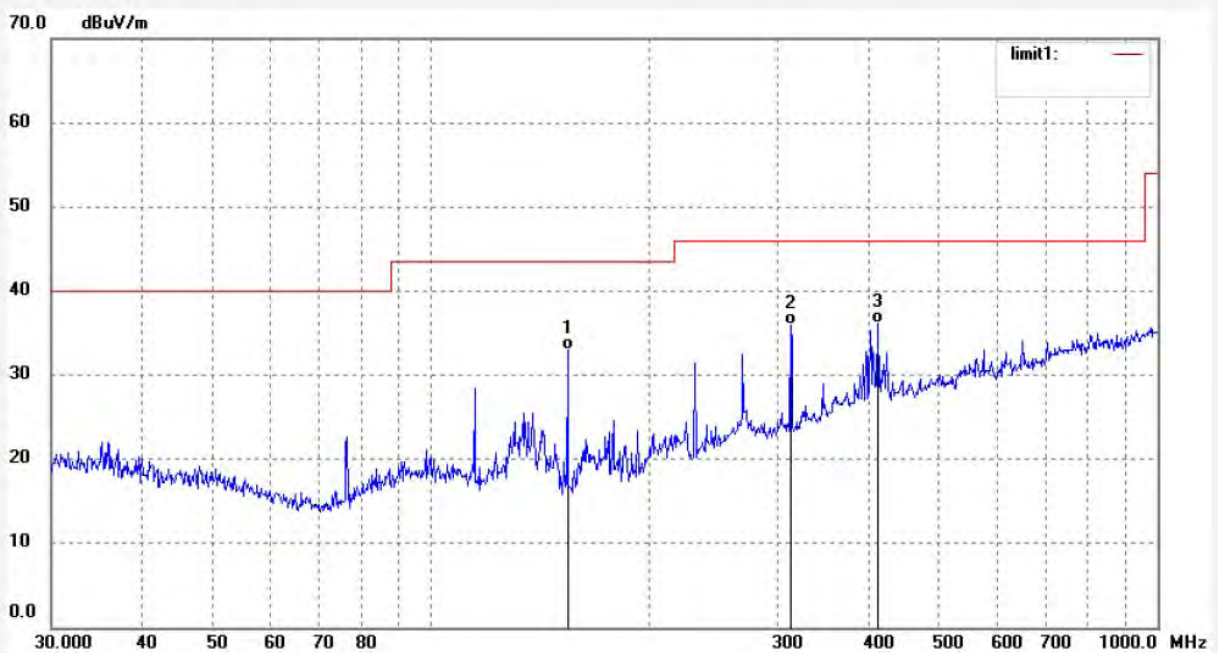

No.	Freq. (MHz)	Reading (dBuV/m)	Factor (dB)	Result (dBuV/m)	Limit (dBuV/m)	Margin (dB)	Detector	Height (cm)	Degree (deg.)	Remark
1	154.2428	21.42	11.56	32.98	43.50	-10.52	QP			
2	312.5482	16.89	19.13	36.02	46.00	-9.98	QP			
3	412.5395	13.13	22.96	36.09	46.00	-9.91	QP			



ACCURATE TECHNOLOGY CO., LTD.

F1,Bldg,A,Changyuan New Material Port Keyuan Rd,
Science & Industry Park,Nanshan Shenzhen,P.R.China

Site: 966 chamber
Tel:+86-0755-26503290
Fax:+86-0755-26503396

Job No.: star #2513	Polarization: Horizontal
Standard: FCC Class B 3M Radiated	Power Source: AC 120V/60Hz
Test item: Radiation Test	Date: 12/10/22/
Temp.(C)/Hum.(%) 23 C / 49 %	Time: 10/18/09
EUT: Mobile internet device	Engineer Signature:
Mode: TX Channel 11(802.11b)	Distance: 3m
Model: P804	
Manufacturer: Pipo	

Note: Report No.:ATE20122384

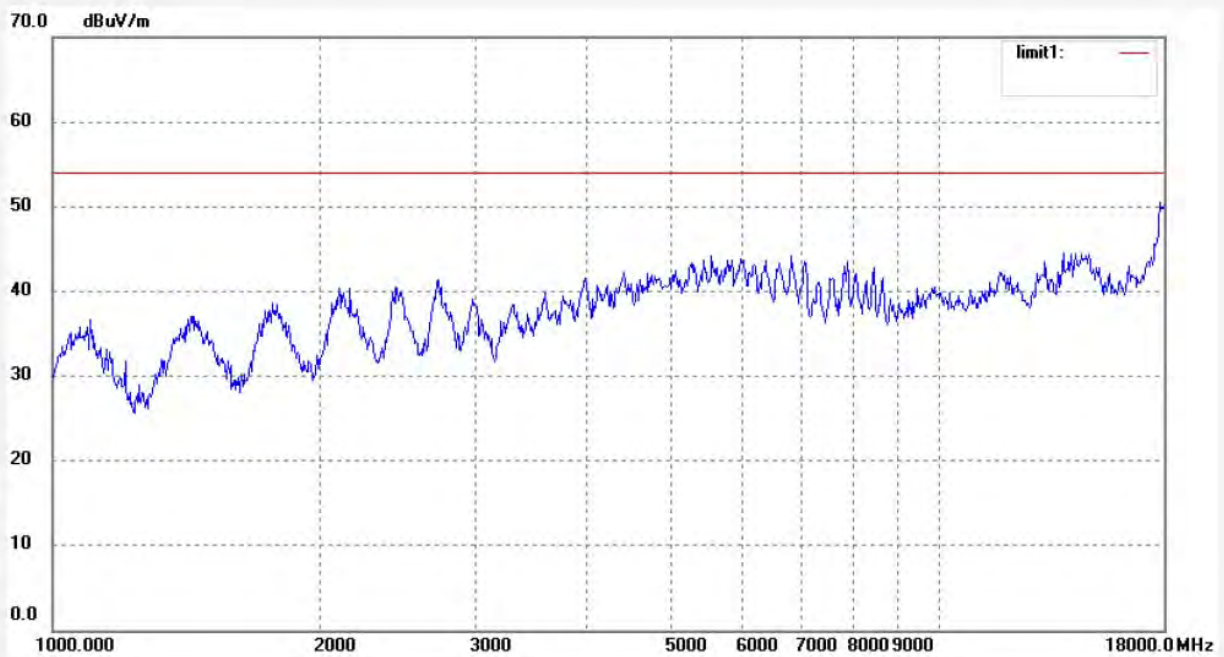

No.	Freq. (MHz)	Reading (dBuV/m)	Factor (dB)	Result (dBuV/m)	Limit (dBuV/m)	Margin (dB)	Detector	Height (cm)	Degree (deg.)	Remark
-----	-------------	------------------	-------------	-----------------	----------------	-------------	----------	-------------	---------------	--------



ACCURATE TECHNOLOGY CO., LTD.

F1,Bldg,A,Changyuan New Material Port Keyuan Rd,
Science & Industry Park,Nanshan Shenzhen,P.R.China

Site: 966 chamber
Tel:+86-0755-26503290
Fax:+86-0755-26503396

Job No.: star #2514	Polarization: Vertical
Standard: FCC Class B 3M Radiated	Power Source: AC 120V/60Hz
Test item: Radiation Test	Date: 12/10/22/
Temp.(C)/Hum.(%) 23 C / 49 %	Time: 10/22/55
EUT: Mobile internet device	Engineer Signature:
Mode: TX Channel 11(802.11b)	Distance: 3m
Model: P804	
Manufacturer: Pipo	

Note: Report No.:ATE20122384

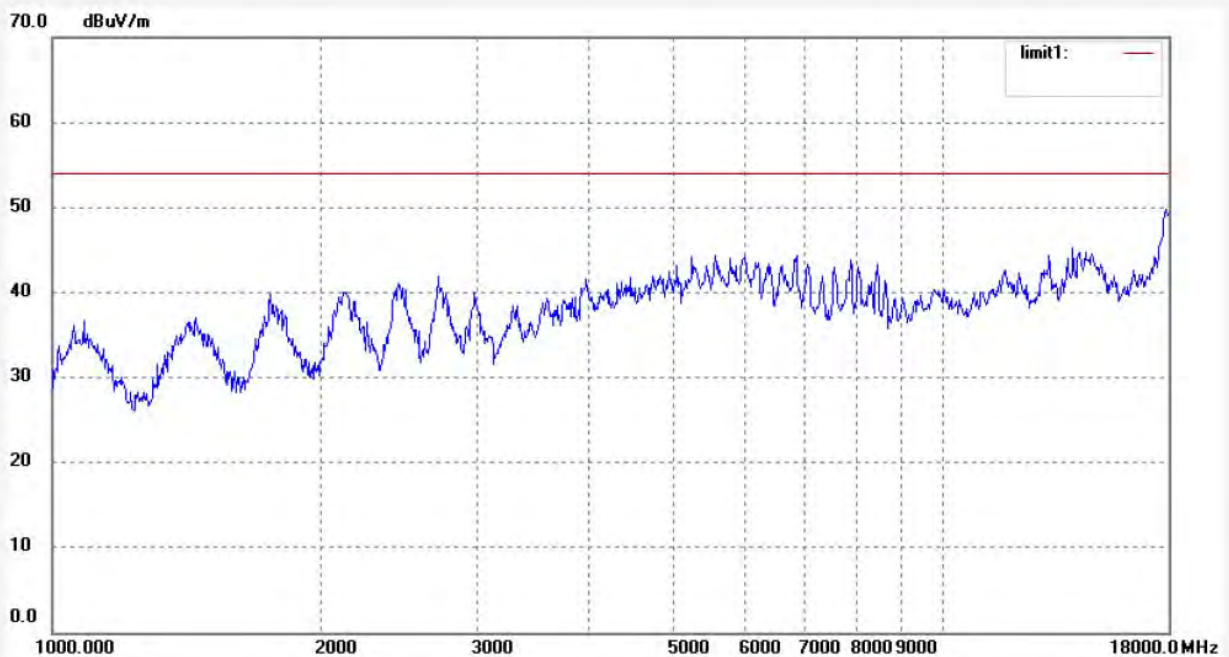

No.	Freq. (MHz)	Reading (dBuV/m)	Factor (dB)	Result (dBuV/m)	Limit (dBuV/m)	Margin (dB)	Detector	Height (cm)	Degree (deg.)	Remark
-----	-------------	------------------	-------------	-----------------	----------------	-------------	----------	-------------	---------------	--------



ACCURATE TECHNOLOGY CO., LTD.

F1,Bldg,A,Changyuan New Material Port Keyuan Rd,
Science & Industry Park,Nanshan Shenzhen,P.R.China

Site: 966 chamber
Tel:+86-0755-26503290
Fax:+86-0755-26503396

Job No.: star #2538	Polarization: Horizontal
Standard: FCC Class B 3M Radiated	Power Source: AC 120V/60Hz
Test item: Radiation Test	Date: 12/10/22/
Temp.(C)/Hum.(%) 23 C / 49 %	Time: 11/56/00
EUT: Mobile internet device	Engineer Signature:
Mode: TX Channel 11(802.11b)	Distance: 3m
Model: P804	
Manufacturer: Pipo	

Note: Report No.:ATE20122384

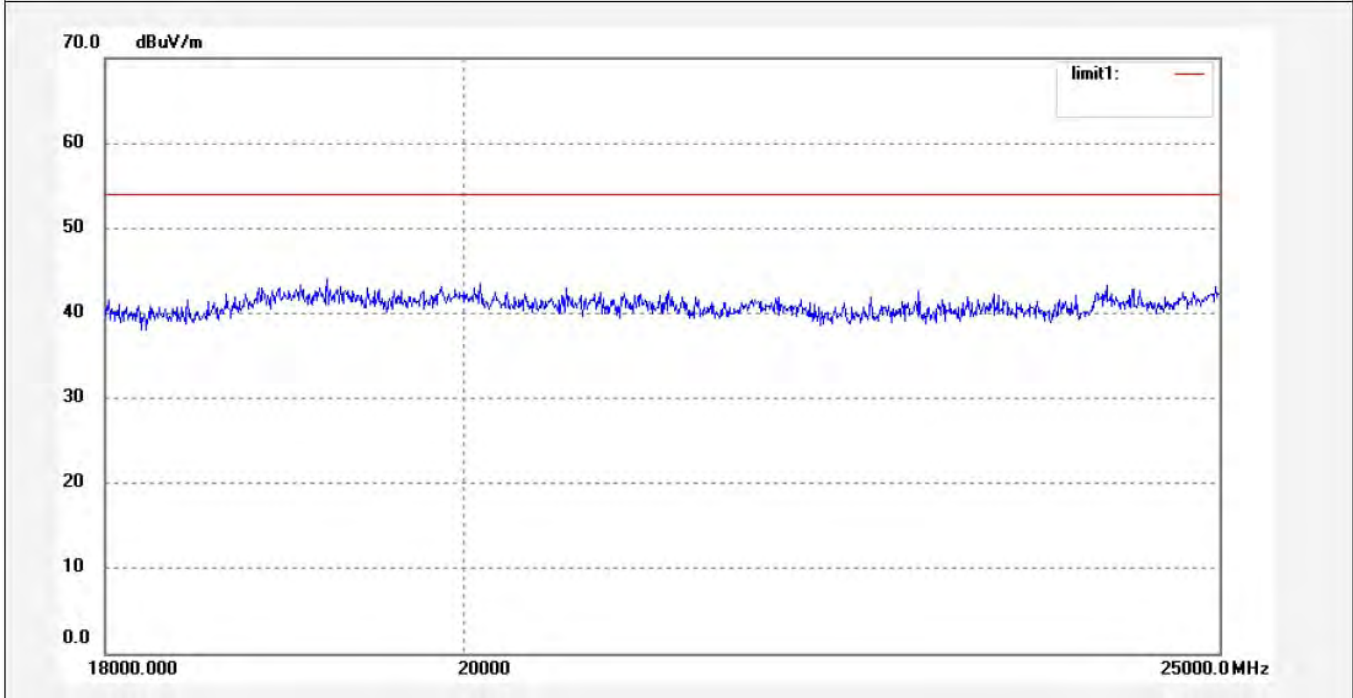

No.	Freq. (MHz)	Reading (dBuV/m)	Factor (dB)	Result (dBuV/m)	Limit (dBuV/m)	Margin (dB)	Detector	Height (cm)	Degree (deg.)	Remark
-----	-------------	------------------	-------------	-----------------	----------------	-------------	----------	-------------	---------------	--------



ACCURATE TECHNOLOGY CO., LTD.

F1,Bldg,A,Changyuan New Material Port Keyuan Rd,
Science & Industry Park,Nanshan Shenzhen,P.R.China

Site: 966 chamber
Tel:+86-0755-26503290
Fax:+86-0755-26503396

Job No.: star #2537	Polarization: Vertical
Standard: FCC Class B 3M Radiated	Power Source: AC 120V/60Hz
Test item: Radiation Test	Date: 12/10/22/
Temp.(C)/Hum.(%) 23 C / 49 %	Time: 11/53/37
EUT: Mobile internet device	Engineer Signature:
Mode: TX Channel 11(802.11b)	Distance: 3m
Model: P804	
Manufacturer: Pipo	

Note: Report No.:ATE20122384

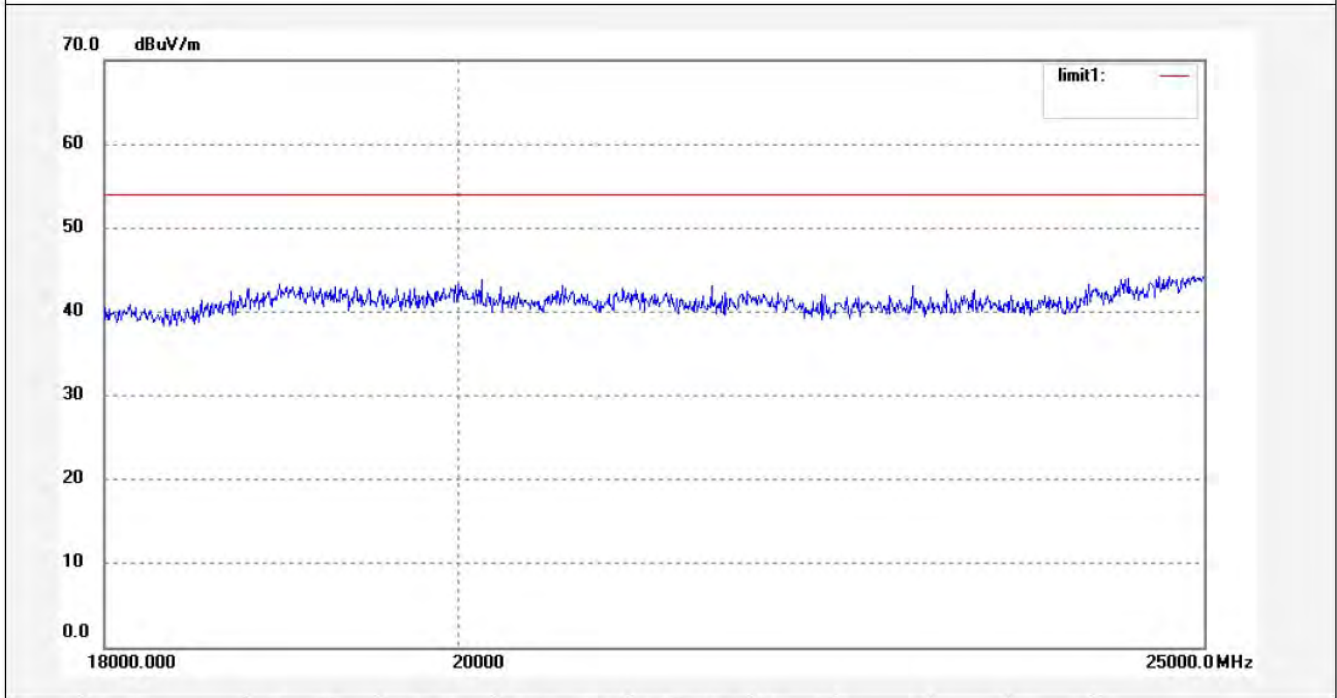

No.	Freq. (MHz)	Reading (dBuV/m)	Factor (dB)	Result (dBuV/m)	Limit (dBuV/m)	Margin (dB)	Detector	Height (cm)	Degree (deg.)	Remark
-----	-------------	------------------	-------------	-----------------	----------------	-------------	----------	-------------	---------------	--------



ACCURATE TECHNOLOGY CO., LTD.

F1,Bldg,A,Changyuan New Material Port Keyuan Rd,
Science & Industry Park,Nanshan Shenzhen,P.R.China

Site: 966 chamber
Tel:+86-0755-26503290
Fax:+86-0755-26503396

Job No.: star #2492	Polarization: Horizontal
Standard: FCC Class B 3M Radiated	Power Source: AC 120V/60Hz
Test item: Radiation Test	Date: 12/10/22/
Temp.(C)/Hum.(%) 23 C / 49 %	Time: 8/56/41
EUT: Mobile internet device	Engineer Signature:
Mode: TX Channel 1(802.11g)	Distance: 3m
Model: P804	
Manufacturer: Pipo	

Note: Report No.:ATE20122384

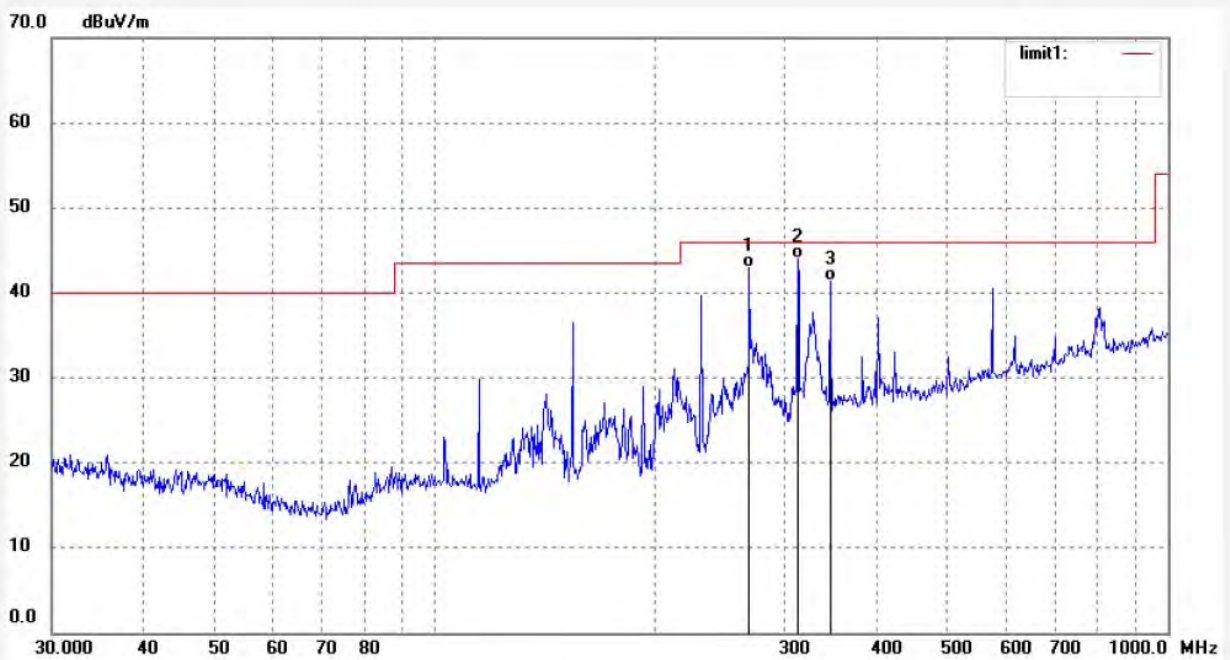

No.	Freq. (MHz)	Reading (dBuV/m)	Factor (dB)	Result (dBuV/m)	Limit (dBuV/m)	Margin (dB)	Detector	Height (cm)	Degree (deg.)	Remark
1	268.7212	24.72	18.32	43.04	46.00	-2.96	QP			
2	312.5482	24.90	19.13	44.03	46.00	-1.97	QP			
3	346.0740	21.04	20.37	41.41	46.00	-4.59	QP			



ACCURATE TECHNOLOGY CO., LTD.

F1,Bldg,A,Changyuan New Material Port Keyuan Rd,
Science & Industry Park,Nanshan Shenzhen,P.R.China

Site: 966 chamber
Tel:+86-0755-26503290
Fax:+86-0755-26503396

Job No.: star #2491	Polarization: Vertical
Standard: FCC Class B 3M Radiated	Power Source: AC 120V/60Hz
Test item: Radiation Test	Date: 12/10/22/
Temp.(C)/Hum.(%) 23 C / 49 %	Time: 8/53/49
EUT: Mobile internet device	Engineer Signature:
Mode: TX Channel 1(802.11g)	Distance: 3m
Model: P804	
Manufacturer: Pipo	

Note: Report No.:ATE20122384

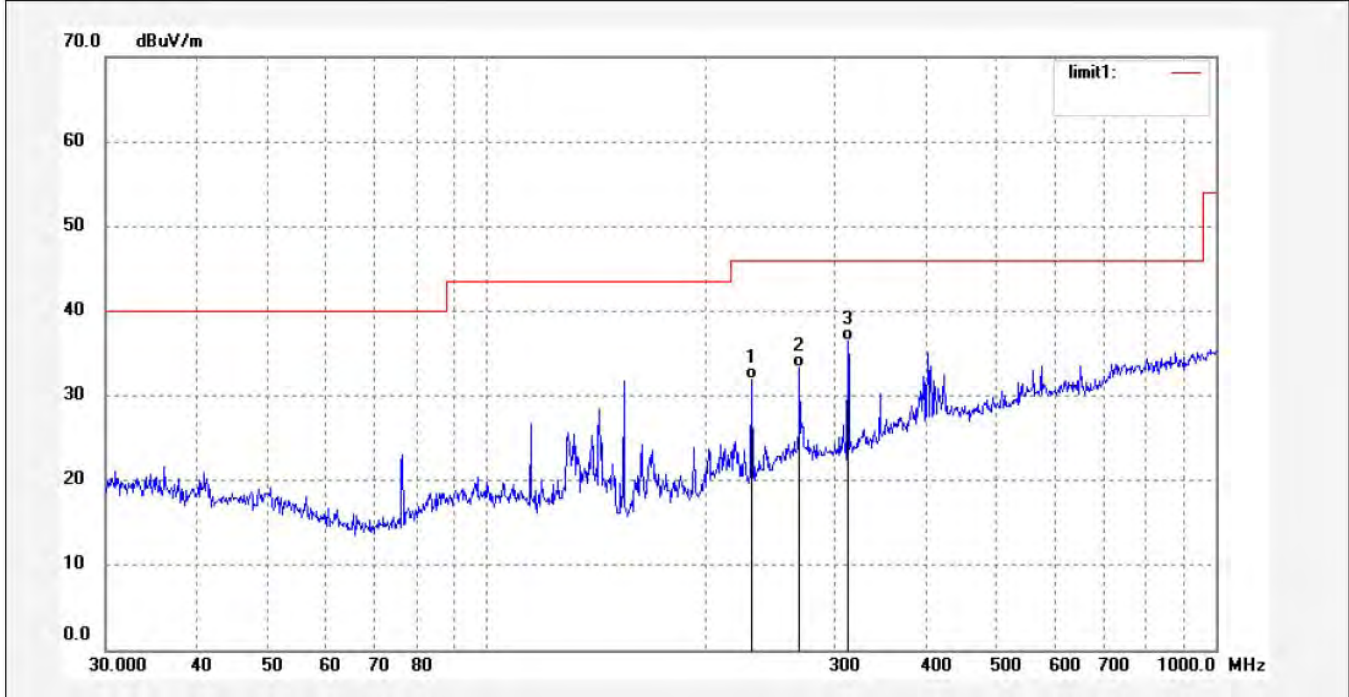

No.	Freq. (MHz)	Reading (dBuV/m)	Factor (dB)	Result (dBuV/m)	Limit (dBuV/m)	Margin (dB)	Detector	Height (cm)	Degree (deg.)	Remark
1	231.0398	15.83	16.05	31.88	46.00	-14.12	QP			
2	268.7212	14.95	18.32	33.27	46.00	-12.73	QP			
3	312.5482	17.33	19.13	36.46	46.00	-9.54	QP			



ACCURATE TECHNOLOGY CO., LTD.

F1,Bldg,A,Changyuan New Material Port Keyuan Rd,
Science & Industry Park,Nanshan Shenzhen,P.R.China

Site: 966 chamber
Tel:+86-0755-26503290
Fax:+86-0755-26503396

Job No.: star #2516
Standard: FCC Class B 3M Radiated
Test item: Radiation Test
Temp.(C)/Hum.(%) 23 C / 49 %
EUT: Mobile internet device
Mode: TX Channel 1(802.11g)
Model: P804
Manufacturer: Pipo

Polarization: Horizontal
Power Source: AC 120V/60Hz
Date: 12/10/22/
Time: 10/27/44
Engineer Signature:
Distance: 3m

Note: Report No.:ATE20122384

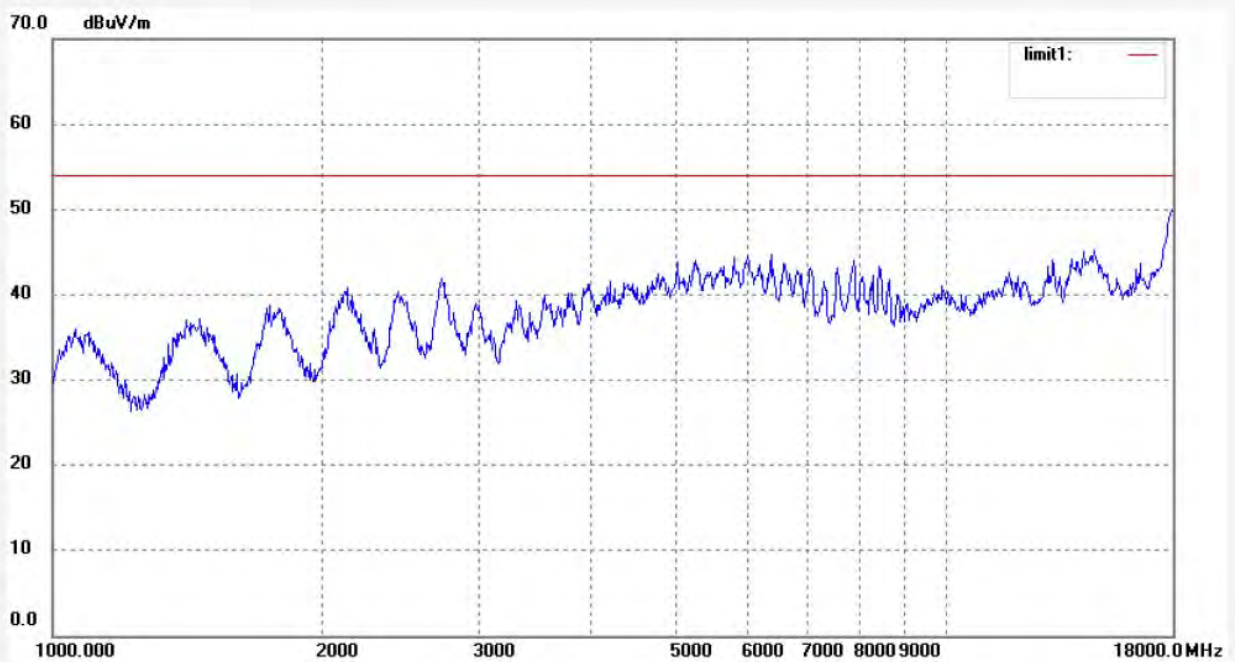

No.	Freq. (MHz)	Reading (dBuV/m)	Factor (dB)	Result (dBuV/m)	Limit (dBuV/m)	Margin (dB)	Detector	Height (cm)	Degree (deg.)	Remark
-----	-------------	------------------	-------------	-----------------	----------------	-------------	----------	-------------	---------------	--------



ACCURATE TECHNOLOGY CO., LTD.

F1,Bldg,A,Changyuan New Material Port Keyuan Rd,
Science & Industry Park,Nanshan Shenzhen,P.R.China

Site: 966 chamber
Tel:+86-0755-26503290
Fax:+86-0755-26503396

Job No.: star #2515	Polarization: Vertical
Standard: FCC Class B 3M Radiated	Power Source: AC 120V/60Hz
Test item: Radiation Test	Date: 12/10/22/
Temp.(C)/Hum.(%) 23 C / 49 %	Time: 10/25/36
EUT: Mobile internet device	Engineer Signature:
Mode: TX Channel 1(802.11g)	Distance: 3m
Model: P804	
Manufacturer: Pipo	

Note: Report No.:ATE20122384

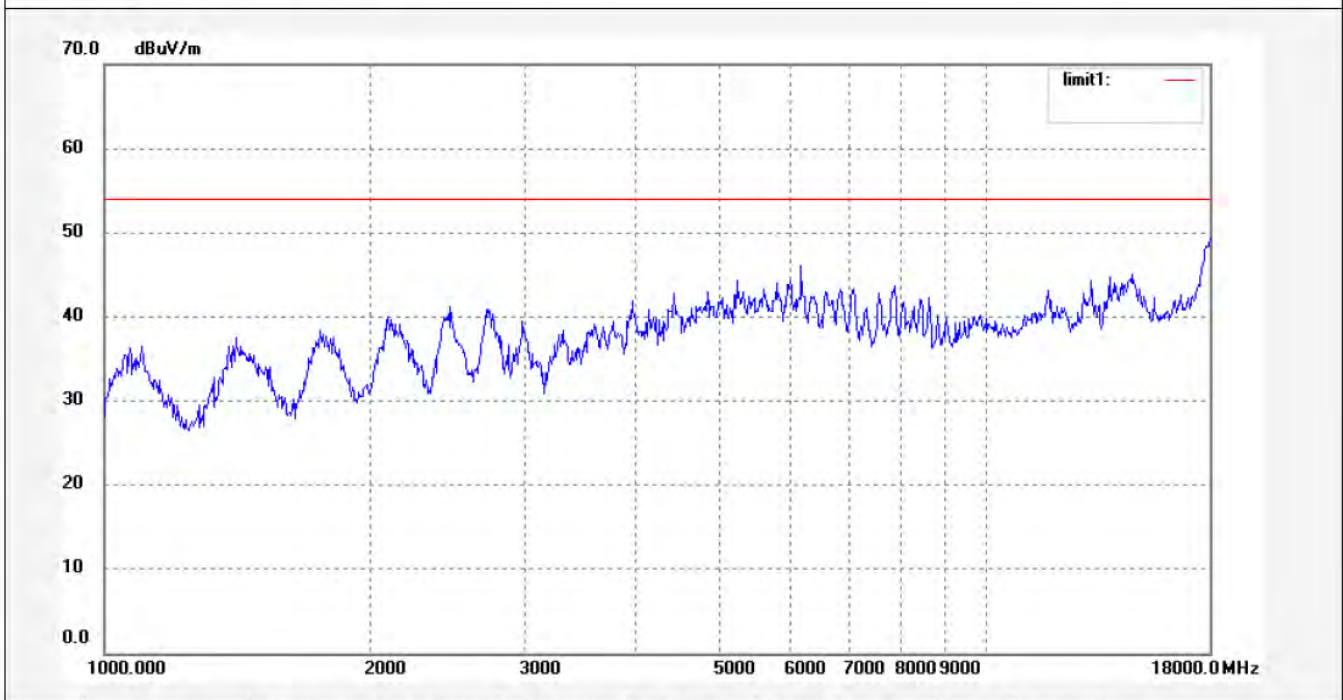

No.	Freq. (MHz)	Reading (dBuV/m)	Factor (dB)	Result (dBuV/m)	Limit (dBuV/m)	Margin (dB)	Detector	Height (cm)	Degree (deg.)	Remark
-----	-------------	------------------	-------------	-----------------	----------------	-------------	----------	-------------	---------------	--------



ACCURATE TECHNOLOGY CO., LTD.

F1,Bldg,A,Changyuan New Material Port Keyuan Rd,
Science & Industry Park,Nanshan Shenzhen,P.R.China

Site: 966 chamber
Tel:+86-0755-26503290
Fax:+86-0755-26503396

Job No.: star #2539	Polarization: Horizontal
Standard: FCC Class B 3M Radiated	Power Source: AC 120V/60Hz
Test item: Radiation Test	Date: 12/10/22/
Temp.(C)/Hum.(%) 23 C / 49 %	Time: 11/59/53
EUT: Mobile internet device	Engineer Signature:
Mode: TX Channel 1(802.11g)	Distance: 3m
Model: P804	
Manufacturer: Pipo	

Note: Report No.:ATE20122384

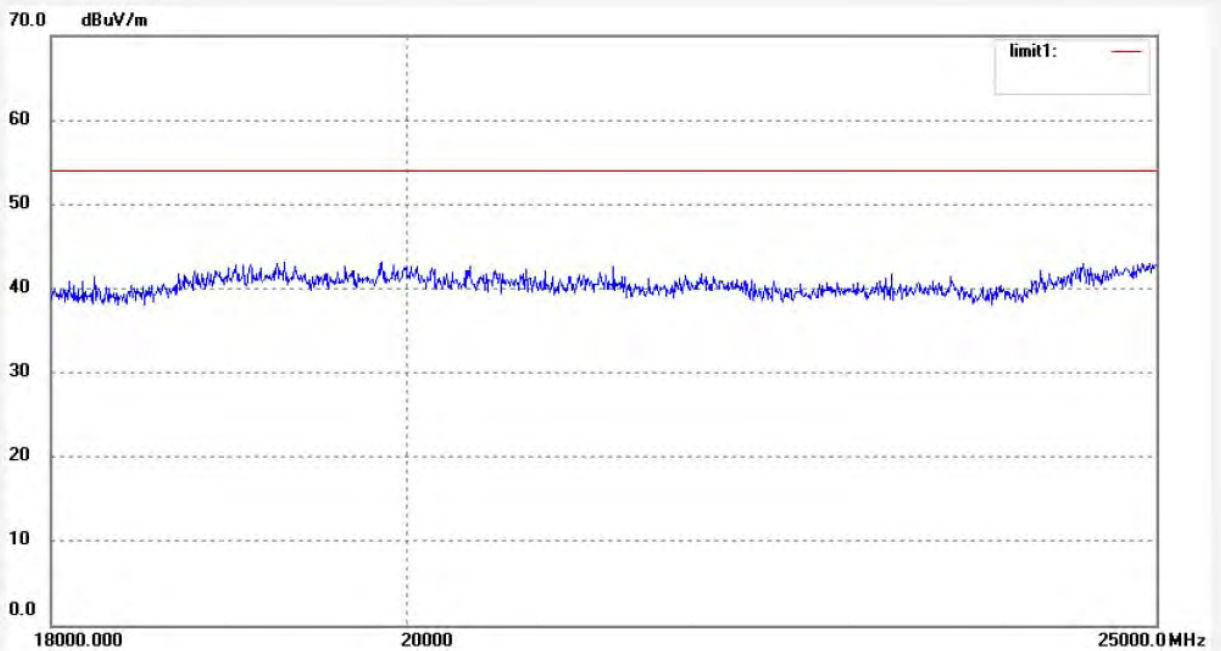

No.	Freq. (MHz)	Reading (dBuV/m)	Factor (dB)	Result (dBuV/m)	Limit (dBuV/m)	Margin (dB)	Detector	Height (cm)	Degree (deg.)	Remark
-----	-------------	------------------	-------------	-----------------	----------------	-------------	----------	-------------	---------------	--------



ACCURATE TECHNOLOGY CO., LTD.

F1,Bldg,A,Changyuan New Material Port Keyuan Rd,
Science & Industry Park,Nanshan Shenzhen,P.R.China

Site: 966 chamber
Tel:+86-0755-26503290
Fax:+86-0755-26503396

Job No.: star #2540	Polarization: Vertical
Standard: FCC Class B 3M Radiated	Power Source: AC 120V/60Hz
Test item: Radiation Test	Date: 12/10/22/
Temp.(C)/Hum.(%) 23 C / 49 %	Time: 12/04/12
EUT: Mobile internet device	Engineer Signature:
Mode: TX Channel 1(802.11g)	Distance: 3m
Model: P804	
Manufacturer: Pipo	

Note: Report No.:ATE20122384

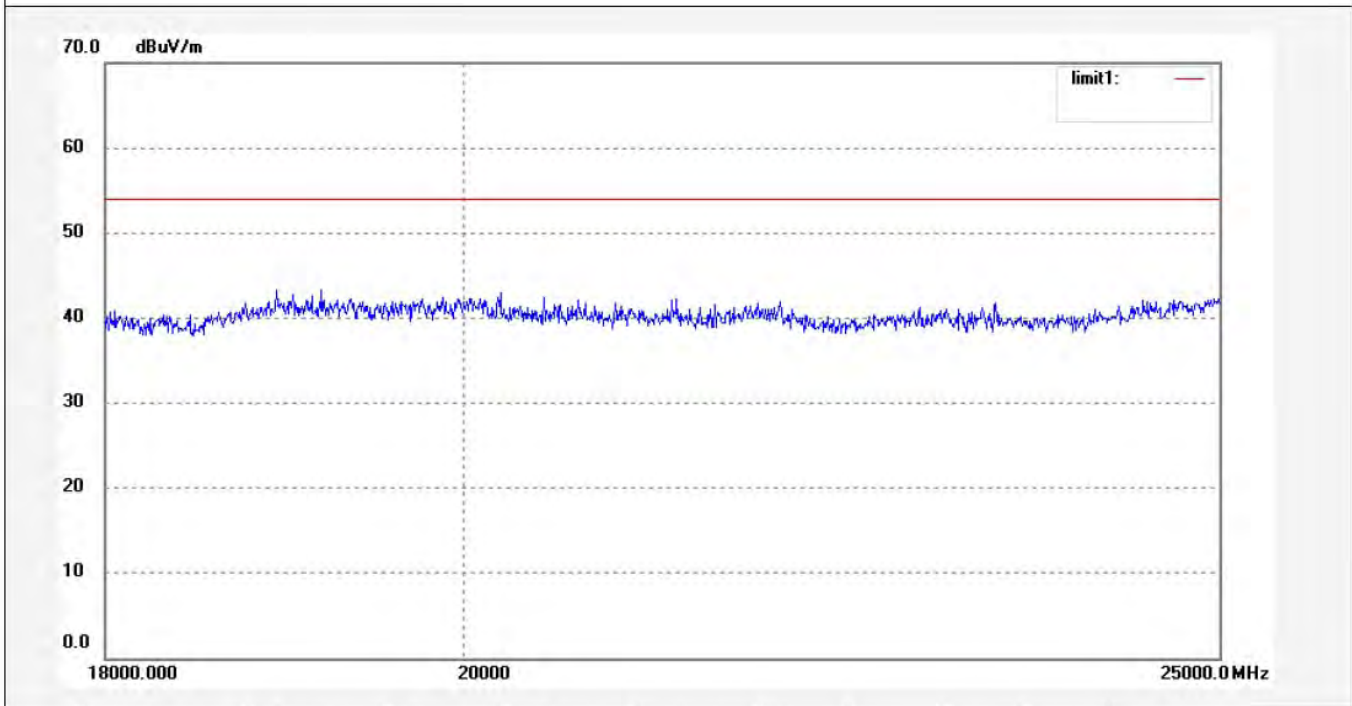

No.	Freq. (MHz)	Reading (dBuV/m)	Factor (dB)	Result (dBuV/m)	Limit (dBuV/m)	Margin (dB)	Detector	Height (cm)	Degree (deg.)	Remark
-----	-------------	------------------	-------------	-----------------	----------------	-------------	----------	-------------	---------------	--------



ACCURATE TECHNOLOGY CO., LTD.

F1,Bldg,A,Changyuan New Material Port Keyuan Rd,
Science & Industry Park,Nanshan Shenzhen,P.R.China

Site: 966 chamber
Tel:+86-0755-26503290
Fax:+86-0755-26503396

Job No.: star #2493
Standard: FCC Class B 3M Radiated
Test item: Radiation Test
Temp.(C)/Hum.(%) 23 C / 49 %
EUT: Mobile internet device
Mode: TX Channel 6(802.11g)
Model: P804
Manufacturer: Pipo

Polarization: Horizontal
Power Source: AC 120V/60Hz
Date: 12/10/22/
Time: 9/00/44
Engineer Signature:
Distance: 3m

Note: Report No.:ATE20122384

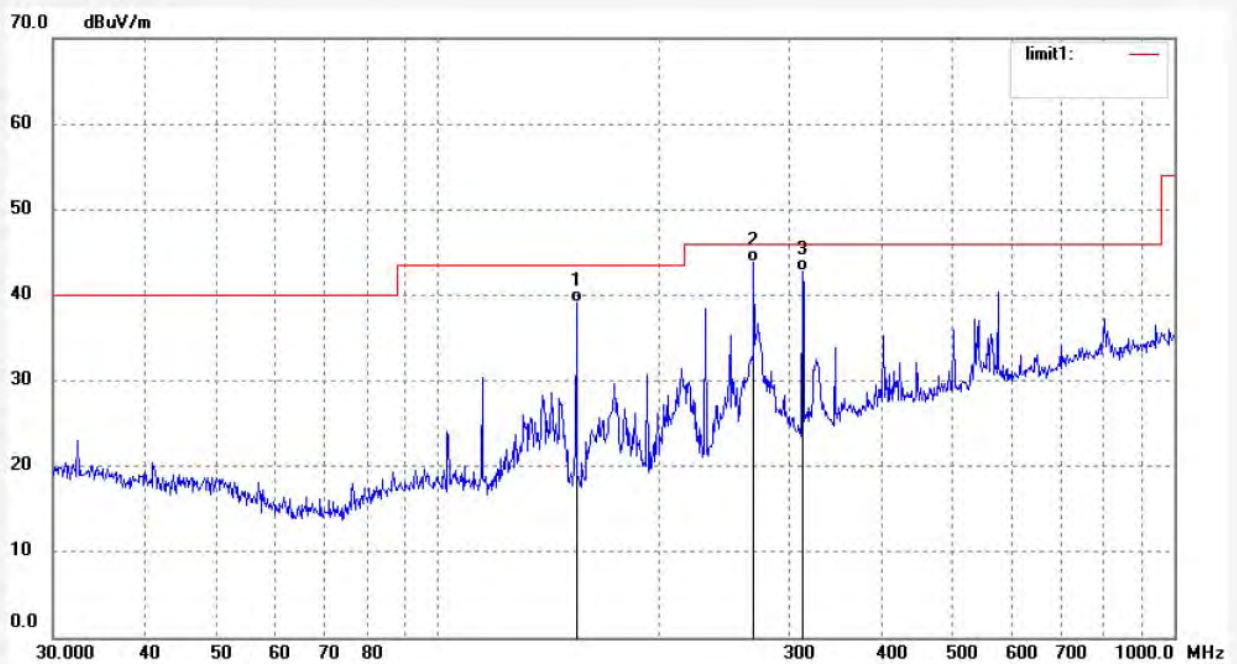

No.	Freq. (MHz)	Reading (dBuV/m)	Factor (dB)	Result (dBuV/m)	Limit (dBuV/m)	Margin (dB)	Detector	Height (cm)	Degree (deg.)	Remark
1	154.2427	27.51	11.56	39.07	43.50	-4.43	QP			
2	268.7212	25.47	18.32	43.79	46.00	-2.21	QP			
3	312.5482	23.62	19.13	42.75	46.00	-3.25	QP			



ACCURATE TECHNOLOGY CO., LTD.

F1,Bldg,A,Changyuan New Material Port Keyuan Rd,
Science & Industry Park,Nanshan Shenzhen,P.R.China

Site: 966 chamber
Tel:+86-0755-26503290
Fax:+86-0755-26503396

Job No.: star #2494
Standard: FCC Class B 3M Radiated
Test item: Radiation Test
Temp.(C)/Hum.(%) 23 C / 49 %
EUT: Mobile internet device
Mode: TX Channel 6(802.11g)
Model: P804
Manufacturer: Pipo

Polarization: Vertical
Power Source: AC 120V/60Hz
Date: 12/10/22/
Time: 9/05/12
Engineer Signature:
Distance: 3m

Note: Report No.:ATE20122384

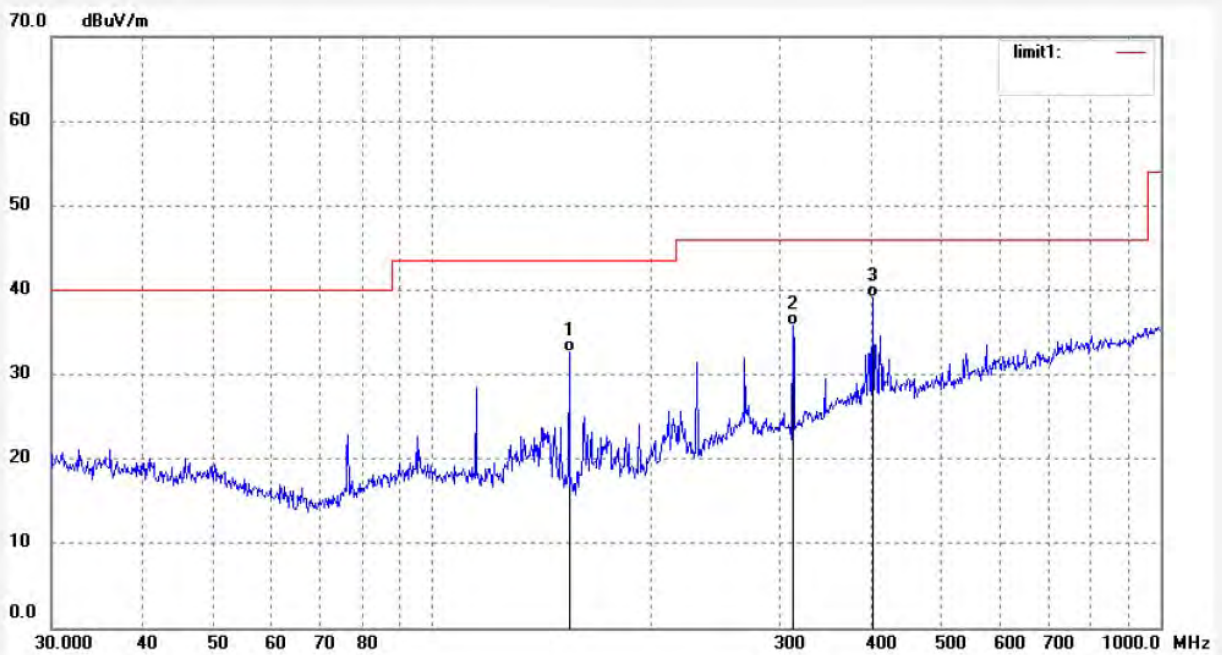

No.	Freq. (MHz)	Reading (dBuV/m)	Factor (dB)	Result (dBuV/m)	Limit (dBuV/m)	Margin (dB)	Detector	Height (cm)	Degree (deg.)	Remark
1	154.2428	21.07	11.56	32.63	43.50	-10.87	QP			
2	312.5482	16.67	19.13	35.80	46.00	-10.20	QP			
3	402.5168	16.76	22.39	39.15	46.00	-6.85	QP			



ACCURATE TECHNOLOGY CO., LTD.

F1,Bldg,A,Changyuan New Material Port Keyuan Rd,
Science & Industry Park,Nanshan Shenzhen,P.R.China

Site: 966 chamber
Tel:+86-0755-26503290
Fax:+86-0755-26503396

Job No.: star #2517	Polarization: Horizontal
Standard: FCC Class B 3M Radiated	Power Source: AC 120V/60Hz
Test item: Radiation Test	Date: 12/10/22/
Temp.(C)/Hum.(%) 23 C / 49 %	Time: 10/31/37
EUT: Mobile internet device	Engineer Signature:
Mode: TX Channel 6(802.11g)	Distance: 3m
Model: P804	
Manufacturer: Pipo	

Note: Report No.:ATE20122384

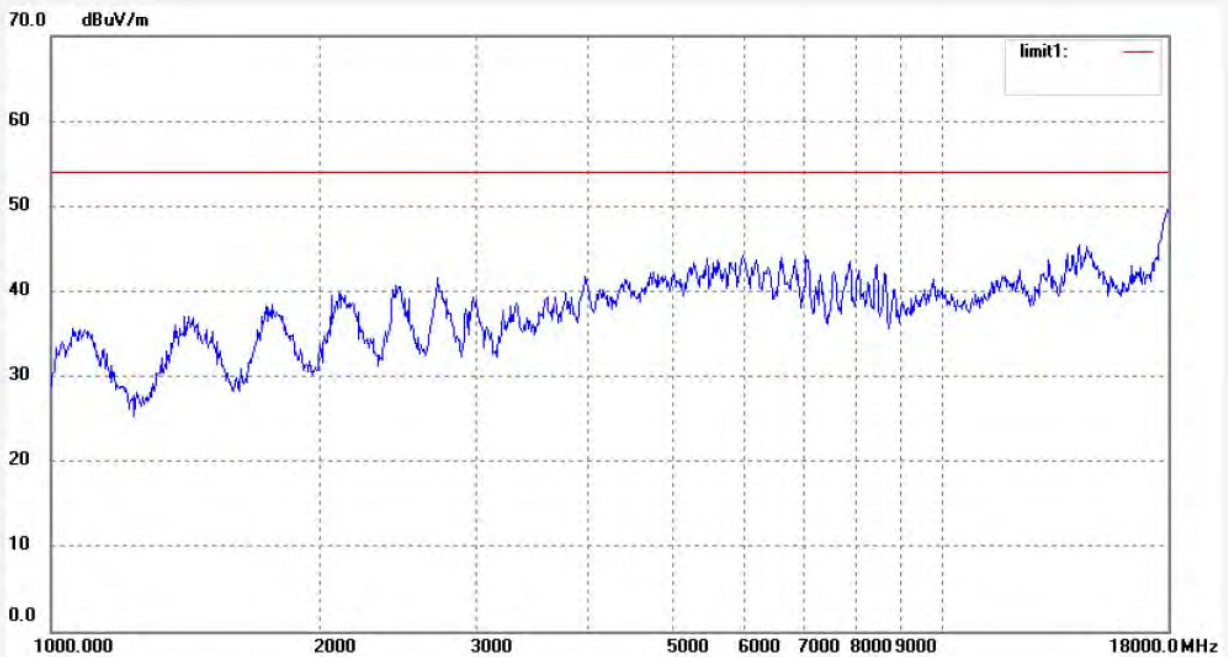

No.	Freq. (MHz)	Reading (dBuV/m)	Factor (dB)	Result (dBuV/m)	Limit (dBuV/m)	Margin (dB)	Detector	Height (cm)	Degree (deg.)	Remark
-----	-------------	------------------	-------------	-----------------	----------------	-------------	----------	-------------	---------------	--------



ACCURATE TECHNOLOGY CO., LTD.

F1,Bldg,A,Changyuan New Material Port Keyuan Rd,
Science & Industry Park,Nanshan Shenzhen,P.R.China

Site: 966 chamber
Tel:+86-0755-26503290
Fax:+86-0755-26503396

Job No.: star #2518	Polarization: Vertical
Standard: FCC Class B 3M Radiated	Power Source: AC 120V/60Hz
Test item: Radiation Test	Date: 12/10/22/
Temp.(C)/Hum.(%) 23 C / 49 %	Time: 10/35/22
EUT: Mobile internet device	Engineer Signature:
Mode: TX Channel 6(802.11g)	Distance: 3m
Model: P804	
Manufacturer: Pipo	

Note: Report No.:ATE20122384

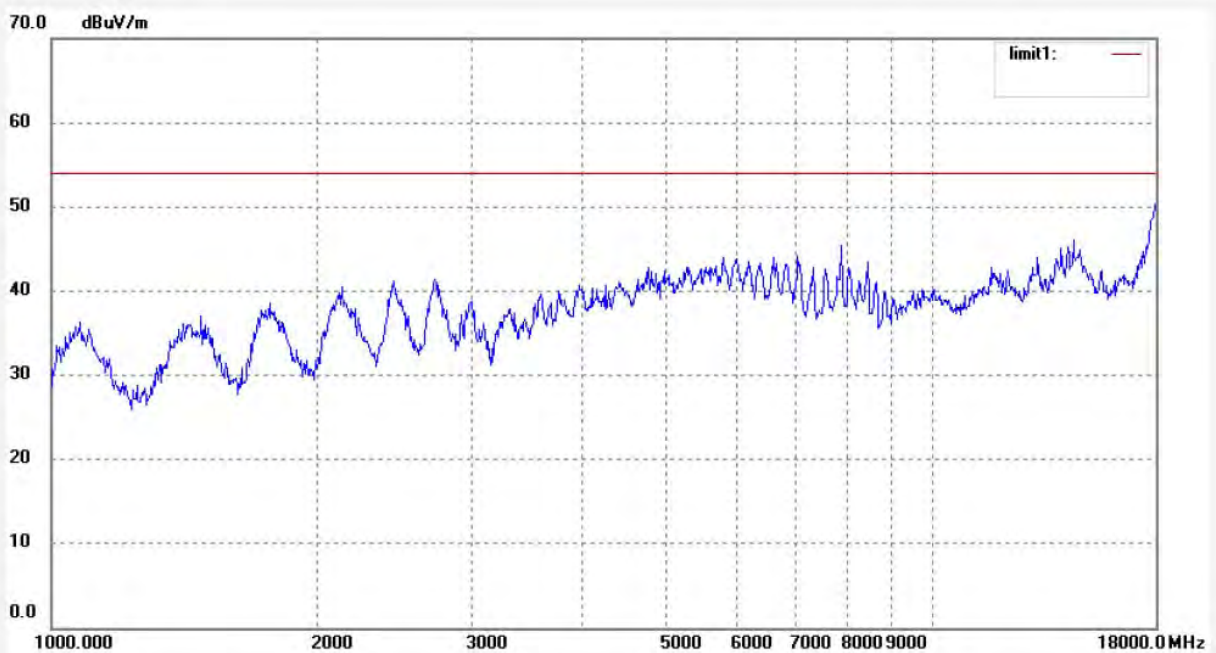

No.	Freq. (MHz)	Reading (dBuV/m)	Factor (dB)	Result (dBuV/m)	Limit (dBuV/m)	Margin (dB)	Detector	Height (cm)	Degree (deg.)	Remark
-----	-------------	------------------	-------------	-----------------	----------------	-------------	----------	-------------	---------------	--------