

APPLICATION CERTIFICATION FCC Part 15C  
On Behalf of  
PIPO TECHNOLOGY CO., LIMITED

Media box  
Model No.: X9

FCC ID: PT7-X9

Prepared for : PIPO TECHNOLOGY CO., LIMITED  
Address : Area C, 3F, Bao Yun Da Logistics Centre,  
Warehouse Building, Xi Xiang Avenue, Bao An  
District, Shenzhen, China.  
Prepared by : ACCURATE TECHNOLOGY CO., LTD  
Address : F1, Bldg. A&D, Chan Yuan New Material Port,  
Keyuan Rd. Science & Industry Park, Nan Shan,  
Shenzhen, Guangdong P.R. China  
Tel: (0755) 26503290  
Fax: (0755) 26503396

Report No. : ATE20161167  
Date of Test : Jun 13-27, 2016  
Date of Report : Jun 28, 2016

## TABLE OF CONTENTS

Description	Page
Test Report Certification	
<b>1. GENERAL INFORMATION .....</b>	<b>5</b>
1.1. Description of Device (EUT).....	5
1.2. Carrier Frequency of Channels.....	6
1.3. Accessory and Auxiliary Equipment .....	6
1.4. Description of Test Facility .....	7
1.5. Measurement Uncertainty.....	7
<b>2. MEASURING DEVICE AND TEST EQUIPMENT .....</b>	<b>8</b>
<b>3. OPERATION OF EUT DURING TESTING .....</b>	<b>9</b>
3.1. Operating Mode .....	9
3.2. Configuration and peripherals .....	9
<b>4. TEST PROCEDURES AND RESULTS .....</b>	<b>10</b>
<b>5. POWER LINE CONDUCTED MEASUREMENT .....</b>	<b>11</b>
5.1. Block Diagram of Test Setup.....	11
5.2. Power Line Conducted Emission Measurement Limits.....	11
5.3. Configuration of EUT on Measurement .....	11
5.4. Operating Condition of EUT .....	11
5.5. Test Procedure .....	12
5.6. Power Line Conducted Emission Measurement Results .....	13
<b>6. 6DB&amp;20DB BANDWIDTH MEASUREMENT .....</b>	<b>19</b>
6.1. Block Diagram of Test Setup.....	19
6.2. The Requirement For Section 15.247(a)(2).....	19
6.3. EUT Configuration on Measurement .....	19
6.4. Operating Condition of EUT .....	19
6.5. Test Procedure .....	19
6.6. Test Result .....	20
<b>7. MAXIMUM CONDUCTED (AVERAGE) OUTPUT POWER .....</b>	<b>33</b>
7.1. Block Diagram of Test Setup.....	33
7.2. The Requirement For Section 15.247(b)(3).....	33
7.3. EUT Configuration on Measurement .....	33
7.4. Operating Condition of EUT .....	33
7.5. Test Procedure .....	33
7.6. Test Result .....	34
<b>8. POWER SPECTRAL DENSITY MEASUREMENT.....</b>	<b>34</b>
8.1. Block Diagram of Test Setup.....	41
8.2. The Requirement For Section 15.247(e).....	41
8.3. EUT Configuration on Measurement .....	41
8.4. Operating Condition of EUT .....	41
8.5. Test Procedure .....	41
8.6. Test Result .....	42
<b>9. BAND EDGE COMPLIANCE TEST .....</b>	<b>49</b>
9.1. Block Diagram of Test Setup.....	49
9.2. The Requirement For Section 15.247(d) .....	49

- 9.3. EUT Configuration on Measurement .....49
- 9.4. Operating Condition of EUT .....49
- 9.5. Test Procedure .....49
- 9.6. Test Result .....50
- 10. RADIATED SPURIOUS EMISSION TEST .....72**
  - 10.1. Block Diagram of Test Setup.....72
  - 10.2. The Limit For Section 15.247(d) .....73
  - 10.3. Restricted bands of operation .....74
  - 10.4. Configuration of EUT on Measurement .....74
  - 10.5. Operating Condition of EUT .....75
  - 10.6. Test Procedure .....75
  - 10.7. The Field Strength of Radiation Emission Measurement Results .....76
- 11. ANTENNA REQUIREMENT.....107**
  - 11.1. The Requirement .....107
  - 11.2. Antenna Construction .....107

### Test Report Certification

Applicant : PIPO TECHNOLOGY CO., LIMITED  
Manufacturer : PIPO TECHNOLOGY CO., LIMITED  
EUT Description : Media box  
(A) MODEL NO.: X9  
(B) Trade Mark. : N/A  
(C) POWER SUPPLY: AC 100-240V~50/60Hz

Measurement Procedure Used:

**FCC Rules and Regulations Part 15 Subpart C Section 15.247:2015**  
**ANSI C63.10: 2013**

The EUT was tested according to DTS test procedure of Apr 08, 2016 KDB558074 D01 DTS Meas Guidance v03r05 for compliance to FCC 47CFR 15.247 requirements

The device described above is tested by ACCURATE TECHNOLOGY CO. LTD to determine the maximum emission levels emanating from the device. The maximum emission levels are compared to the FCC Part 15 Subpart C Section 15.247 limits. The measurement results are contained in this test report and ACCURATE TECHNOLOGY CO. LTD is assumed full responsibility for the accuracy and completeness of these measurements. Also, this report shows that the Equipment Under Test (EUT) is to be technically compliant with the FCC requirements.

This report applies to above tested sample only. This report shall not be reproduced in part without written approval of ACCURATE TECHNOLOGY CO. LTD.

Date of Test : Jun 13-27, 2016  
Date of Report : Jun 28, 2016

Prepared by :   
(Mark Chen, Engineer)

Approved & Authorized Signer :   
( Sean Liu, Manager)

## 1. GENERAL INFORMATION

### 1.1. Description of Device (EUT)

EUT	:	Media box
Model Number	:	X9
Frequency Range	:	802.11b/g/n(20MHz): 2412-2462MHz 802.11n(40MHz): 2422-2452MHz
Number of Channels	:	802.11b/g/n (20MHz):11 802.11n (40MHz): 7
Antenna Gain	:	2dBi
Type of Antenna	:	External Antenna
Power Supply	:	AC 100-240V~50/60Hz
Adapter information	:	Model:KA1433-1202400JP Input: 100-240V~50/60Hz 1.0A Max Out: 12V/2400mA
Data Rate	:	802.11b: 11, 5.5, 2, 1 Mbps 802.11g: 54, 48, 36, 24, 18, 12, 9, 6 Mbps 802.11n: up to 150Mbps
Modulation Type	:	CCK, OFDM, QPSK, BPSK, 16QAM, 64QAM
Applicant Address	:	PIPO TECHNOLOGY CO., LIMITED Area C, 3F, Bao Yun Da Logistics Centre, Warehouse Building, Xi Xiang Avenue, Bao An District, Shenzhen, China.
Manufacturer Address	:	PIPO TECHNOLOGY CO., LIMITED Area C, 3F, Bao Yun Da Logistics Centre, Warehouse Building, Xi Xiang Avenue, Bao An District, Shenzhen, China.
Date of sample received	:	Jun 13, 2016
Date of Test	:	Jun 13-27, 2016

## 1.2. Carrier Frequency of Channels

802.11b, 802.11g, 802.11n (20MHz)

Channel	Frequency(MHz)	Channel	Frequency(MHz)
01	2412	07	2442
02	2417	08	2447
03	2422	09	2452
04	2427	10	2457
05	2432	11	2462
06	2437	---	---

802.11n (40MHz)

Channel	Frequency(MHz)	Channel	Frequency(MHz)
---	---	07	2442
---	---	08	2447
03	2422	09	2452
04	2427	---	---
05	2432	---	---
06	2437	---	---

## 1.3. Accessory and Auxiliary Equipment

N/A

#### 1.4. Description of Test Facility

EMC Lab : Accredited by TUV Rheinland Shenzhen

Listed by FCC  
The Registration Number is 752051

Listed by Industry Canada  
The Registration Number is 5077A-2

Accredited by China National Accreditation Committee  
for Laboratories  
The Certificate Registration Number is L3193

Name of Firm : ACCURATE TECHNOLOGY CO. LTD  
Site Location : F1, Bldg. A, Changyuan New Material Port, Keyuan Rd.  
Science & Industry Park, Nanshan, Shenzhen, Guangdong  
P.R. China

#### 1.5. Measurement Uncertainty

Conducted Emission Expanded Uncertainty = 2.23dB, k=2

Radiated emission expanded uncertainty = 3.08dB, k=2  
(9kHz-30MHz)

Radiated emission expanded uncertainty = 4.42dB, k=2  
(30MHz-1000MHz)

Radiated emission expanded uncertainty = 4.06dB, k=2  
(Above 1GHz)

## 2. MEASURING DEVICE AND TEST EQUIPMENT

**Table 1: List of Test and Measurement Equipment**

Kind of equipment	Manufacturer	Type	S/N	Calibrated dates	Calibrated until
EMI Test Receiver	Rohde&Schwarz	ESCS30	100307	Jan. 9, 2016	1 Year
EMI Test Receiver	Rohde&Schwarz	ESPI3	101526/003	Jan. 9, 2016	1 Year
Spectrum Analyzer	Agilent	E7405A	MY45115511	Jan. 9, 2016	1 Year
Pre-Amplifier	Rohde&Schwarz	CBLU118354 0-01	3791	Jan. 9, 2016	1 Year
Loop Antenna	Schwarzbeck	FMZB1516	1516131	Jan. 14, 2016	1 Year
Bilog Antenna	Schwarzbeck	VULB9163	9163-323	Jan. 14, 2016	1 Year
Horn Antenna	Schwarzbeck	BBHA9120D	9120D-655	Jan. 14, 2016	1 Year
Horn Antenna	Schwarzbeck	BBHA9170	9170-359	Jan. 14, 2016	1 Year
LISN	Rohde&Schwarz	ESH3-Z5	100305	Jan. 9, 2016	1 Year
LISN	Schwarzbeck	NSLK8126	8126431	Jan. 9, 2016	1 Year
Highpass Filter	Wainwright Instruments	WHKX3.6/18 G-10SS	N/A	Jan. 9, 2016	1 Year
Band Reject Filter	Wainwright Instruments	WRCG2400/2 485-2375/2510 -60/11SS	N/A	Jan. 9, 2016	1 Year



### 3. OPERATION OF EUT DURING TESTING

#### 3.1. Operating Mode

The mode is used: **1.802.11b Transmitting mode**

Low Channel: 2412MHz

Middle Channel: 2437MHz

High Channel: 2462MHz

#### **2.802.11g Transmitting mode**

Low Channel: 2412MHz

Middle Channel: 2437MHz

High Channel: 2462MHz

#### **3.802.11n (20MHz) Transmitting mode**

Low Channel: 2412MHz

Middle Channel: 2437MHz

High Channel: 2462MHz

#### **4.802.11n (40MHz) Transmitting mode**

Low Channel: 2422MHz

Middle Channel: 2437MHz

High Channel: 2452MHz

#### 3.2. Configuration and peripherals

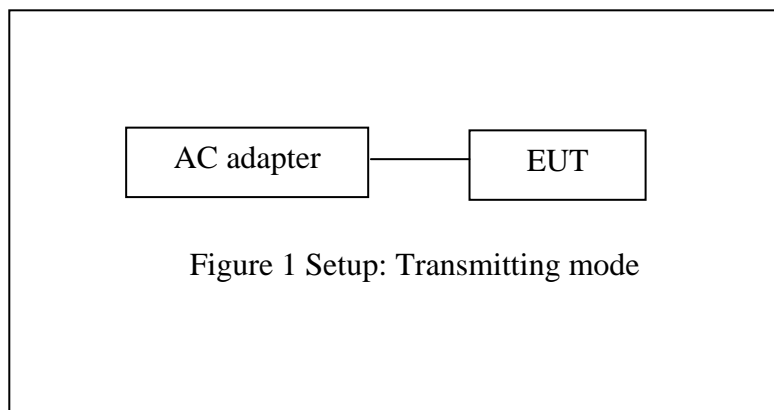

#### 4. TEST PROCEDURES AND RESULTS

<b>FCC Rules</b>	<b>Description of Test</b>	<b>Result</b>
Section 15.207	Power Line Conducted Emission	Compliant
Section 15.247(a)(2)	6dB&20dB Bandwidth Test	Compliant
Section 15.247(e)	Power Spectral Density Test	Compliant
Section 15.247(b)(3)	Maximum Peak Output Power Test	Compliant
Section 15.247(d)	Band Edge Compliance Test	Compliant
Section 15.247(d) Section 15.209	Radiated Spurious Emission Test	Compliant
Section 15.247(d)	Conducted Spurious Emission Test	Compliant
Section 15.203	Antenna Requirement	Compliant

## 5. POWER LINE CONDUCTED MEASUREMENT

### 5.1. Block Diagram of Test Setup

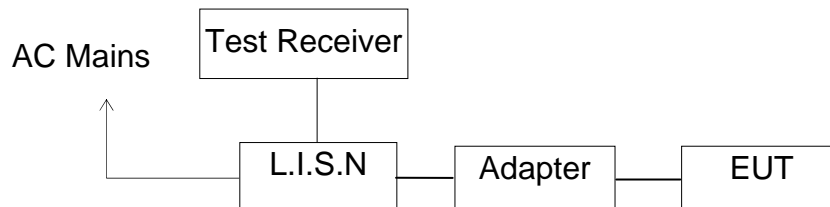

(EUT: Media box)

### 5.2. Power Line Conducted Emission Measurement Limits

Frequency (MHz)	Limit dB( $\mu$ V)	
	Quasi-peak Level	Average Level
0.15 - 0.50	66.0 – 56.0 *	56.0 – 46.0 *
0.50 - 5.00	56.0	46.0
5.00 - 30.00	60.0	50.0

NOTE1: The lower limit shall apply at the transition frequencies.  
NOTE2: The limit decreases linearly with the logarithm of the frequency in the range 0.15MHz to 0.50MHz.

### 5.3. Configuration of EUT on Measurement

The following equipments are installed on Power Line Conducted Emission Measurement to meet the commission requirement and operating regulations in a manner, which tends to maximize its emission characteristics in a normal application.

### 5.4. Operating Condition of EUT

- 5.4.1. Setup the EUT and simulator as shown as Section 5.1.
- 5.4.2. Turn on the power of all equipment.
- 5.4.3. Let the EUT work in test mode and measure it.

### 5.5. Test Procedure

The EUT is put on the plane 0.8m high above the ground by insulating support and is connected to the power mains through a line impedance stabilization network (L.I.S.N.). This provides a 50ohm coupling impedance for the EUT system. Please refer the block diagram of the test setup and photographs. Both sides of AC lines are checked to find out the maximum conducted emission. In order to find the maximum emission levels, the relative positions of equipment and all of the interface cables shall be changed according to ANSI C63.10: 2013 on Conducted Emission Measurement.

The bandwidth of test receiver (R & S ESCS30) is set at 9kHz.

The frequency range from 150kHz to 30MHz is checked.

### 5.6.Power Line Conducted Emission Measurement Results

**PASS.**

The frequency range from 150kHz to 30MHz is checked.

Test mode : WIFI Communicating(120V/60Hz)								
Model: X9								
<b>MEASUREMENT RESULT: "PIPO617009_fin"</b>								
6/17/2016 9:54AM								
Frequency	Level	Transd	Limit	Margin	Detector	Line	PE	
MHz	dBµV	dB	dBµV	dB				
0.555000	41.10	10.7	56	14.9	QP	L1	GND	
1.050000	26.60	10.9	56	29.4	QP	L1	GND	
24.835000	38.10	11.5	60	21.9	QP	L1	GND	
<b>MEASUREMENT RESULT: "PIPO617009_fin2"</b>								
6/17/2016 9:54AM								
Frequency	Level	Transd	Limit	Margin	Detector	Line	PE	
MHz	dBµV	dB	dBµV	dB				
0.555000	34.70	10.7	46	11.3	AV	L1	GND	
1.115000	19.50	10.9	46	26.5	AV	L1	GND	
24.820000	33.80	11.5	50	16.2	AV	L1	GND	
<b>MEASUREMENT RESULT: "PIPO617010_fin"</b>								
6/17/2016 9:58AM								
Frequency	Level	Transd	Limit	Margin	Detector	Line	PE	
MHz	dBµV	dB	dBµV	dB				
0.555000	39.30	10.7	56	16.7	QP	N	GND	
1.135000	28.40	10.9	56	27.6	QP	N	GND	
24.535000	36.10	11.5	60	23.9	QP	N	GND	
<b>MEASUREMENT RESULT: "PIPO617010_fin2"</b>								
6/17/2016 9:58AM								
Frequency	Level	Transd	Limit	Margin	Detector	Line	PE	
MHz	dBµV	dB	dBµV	dB				
0.560000	31.60	10.7	46	14.4	AV	N	GND	
1.100000	20.60	10.9	46	25.4	AV	N	GND	
24.445000	31.40	11.5	50	18.6	AV	N	GND	

Test mode : WIFI Communicating(240V/60Hz)								
Model: X9								
<b>MEASUREMENT RESULT: "PIPO617016_fin"</b>								
6/17/2016 10:22AM								
Frequency	Level	Transd	Limit	Margin	Detector	Line	PE	
MHz	dBµV	dB	dBµV	dB				
0.565000	40.70	10.7	56	15.3	QP	L1	GND	
0.910000	32.00	10.8	56	24.0	QP	L1	GND	
26.680000	39.90	11.5	60	20.1	QP	L1	GND	
<b>MEASUREMENT RESULT: "PIPO617016_fin2"</b>								
6/17/2016 10:22AM								
Frequency	Level	Transd	Limit	Margin	Detector	Line	PE	
MHz	dBµV	dB	dBµV	dB				
0.570000	33.80	10.7	46	12.2	AV	L1	GND	
0.895000	25.80	10.8	46	20.2	AV	L1	GND	
26.230000	35.40	11.5	50	14.6	AV	L1	GND	
<b>MEASUREMENT RESULT: "PIPO617015_fin"</b>								
6/17/2016 10:18AM								
Frequency	Level	Transd	Limit	Margin	Detector	Line	PE	
MHz	dBµV	dB	dBµV	dB				
0.560000	38.90	10.7	56	17.1	QP	N	GND	
0.915000	31.10	10.8	56	24.9	QP	N	GND	
26.980000	37.60	11.5	60	22.4	QP	N	GND	
<b>MEASUREMENT RESULT: "PIPO617015_fin2"</b>								
6/17/2016 10:18AM								
Frequency	Level	Transd	Limit	Margin	Detector	Line	PE	
MHz	dBµV	dB	dBµV	dB				
0.570000	31.00	10.7	46	15.0	AV	N	GND	
0.895000	25.40	10.8	46	20.6	AV	N	GND	
26.650000	33.90	11.5	50	16.1	AV	N	GND	

Emissions attenuated more than 20 dB below the permissible value are not reported.

The spectral diagrams are attached as below.

**ACCURATE TECHNOLOGY CO., LTD**

**CONDUCTED EMISSION STANDARD FCC PART 15B**

EUT: Media box M/N:X9  
 Manufacturer: PIPO TECHNOLOGY CO., LTD  
 Operating Condition: WiFi Communicating  
 Test Site: 1#Shielding Room  
 Operator: STAR  
 Test Specification: L 120V/60Hz  
 Comment: Report No.:ATE20161167  
 Start of Test: 6/17/2016 / 9:50:56AM

**SCAN TABLE: "V 9K-30MHz fin"**

Short Description:		SUB STD_VTERM2 1.70					
Start	Stop	Step	Detector	Meas. Time	IF Bandw.	Transducer	
9.0 kHz	150.0 kHz	100.0 Hz	QuasiPeak	1.0 s	200 Hz	NSLK8126 2008	
150.0 kHz	30.0 MHz	5.0 kHz	QuasiPeak	1.0 s	9 kHz	NSLK8126 2008	
			Average				
			Average				

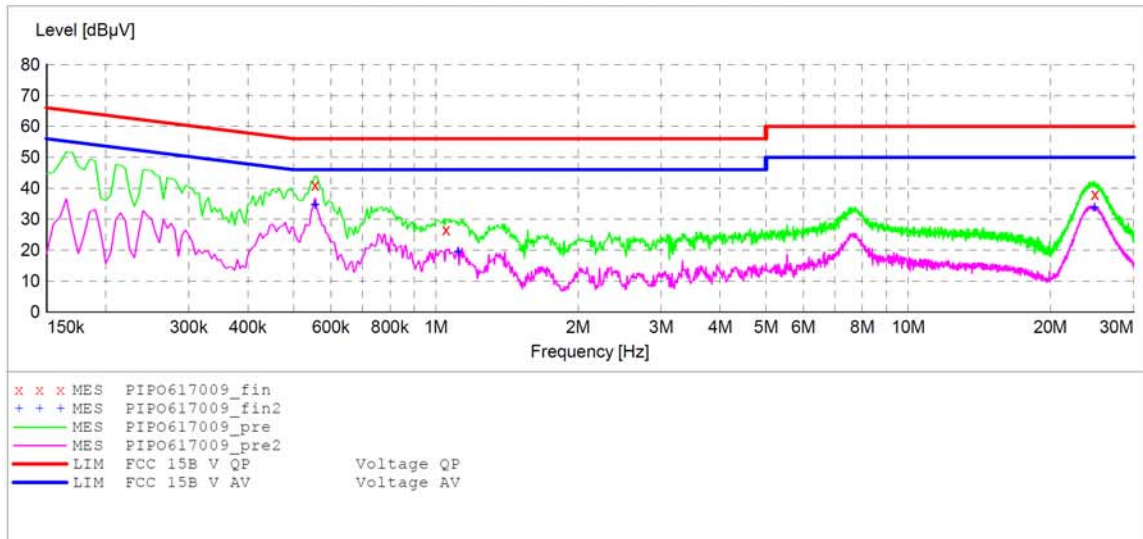

**MEASUREMENT RESULT: "PIPO617009\_fin"**

6/17/2016 9:54AM

Frequency MHz	Level dBµV	Transd dB	Limit dBµV	Margin dB	Detector	Line	PE
0.555000	41.10	10.7	56	14.9	QP	L1	GND
1.050000	26.60	10.9	56	29.4	QP	L1	GND
24.835000	38.10	11.5	60	21.9	QP	L1	GND

**MEASUREMENT RESULT: "PIPO617009\_fin2"**

6/17/2016 9:54AM

Frequency MHz	Level dBµV	Transd dB	Limit dBµV	Margin dB	Detector	Line	PE
0.555000	34.70	10.7	46	11.3	AV	L1	GND
1.115000	19.50	10.9	46	26.5	AV	L1	GND
24.820000	33.80	11.5	50	16.2	AV	L1	GND

**ACCURATE TECHNOLOGY CO., LTD**

**CONDUCTED EMISSION STANDARD FCC PART 15B**

EUT: Media box M/N:X9  
 Manufacturer: PIPO TECHNOLOGY CO., LTD  
 Operating Condition: WiFi Communicating  
 Test Site: 1#Shielding Room  
 Operator: STAR  
 Test Specification: N 120V/60Hz  
 Comment: Report No.:ATE20161167  
 Start of Test: 6/17/2016 / 9:55:12AM

**SCAN TABLE: "V 9K-30MHz fin"**

Short Description:		_SUB_STD_VTERM2 1.70					
Start	Stop	Step	Detector	Meas. Time	IF Bandw.	Transducer	
9.0 kHz	150.0 kHz	100.0 Hz	QuasiPeak	1.0 s	200 Hz	NSLK8126 2008	
Average							
150.0 kHz	30.0 MHz	5.0 kHz	QuasiPeak	1.0 s	9 kHz	NSLK8126 2008	
Average							

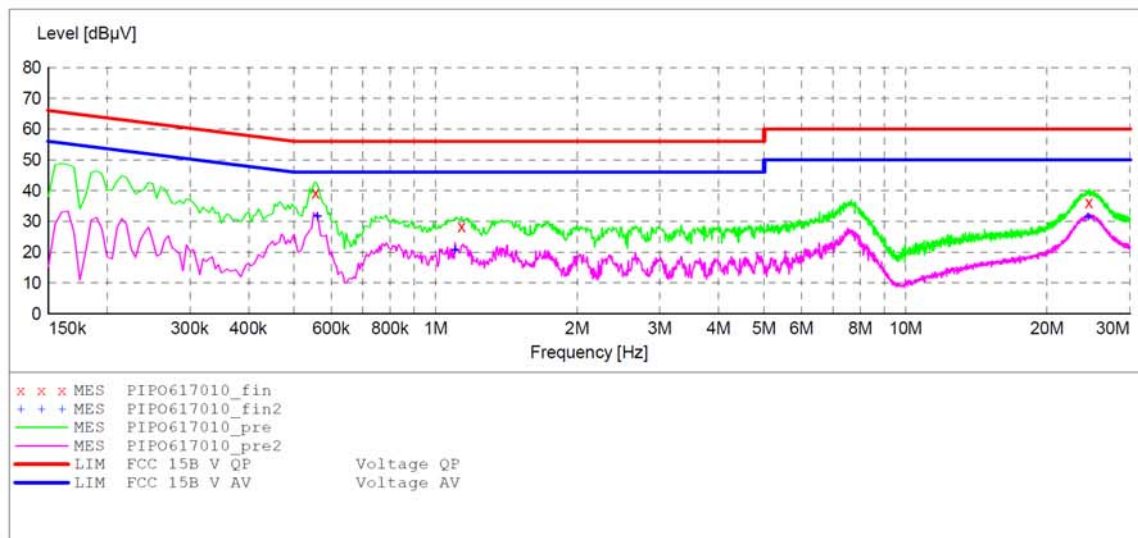

**MEASUREMENT RESULT: "PIPO617010\_fin"**

6/17/2016 9:58AM

Frequency MHz	Level dBµV	Transd dB	Limit dBµV	Margin dB	Detector	Line	PE
0.555000	39.30	10.7	56	16.7	QP	N	GND
1.135000	28.40	10.9	56	27.6	QP	N	GND
24.535000	36.10	11.5	60	23.9	QP	N	GND

**MEASUREMENT RESULT: "PIPO617010\_fin2"**

6/17/2016 9:58AM

Frequency MHz	Level dBµV	Transd dB	Limit dBµV	Margin dB	Detector	Line	PE
0.560000	31.60	10.7	46	14.4	AV	N	GND
1.100000	20.60	10.9	46	25.4	AV	N	GND
24.445000	31.40	11.5	50	18.6	AV	N	GND



**ACCURATE TECHNOLOGY CO., LTD**

**CONDUCTED EMISSION STANDARD FCC PART 15B**

EUT: Media box M/N:X9  
 Manufacturer: PIPO TECHNOLOGY CO., LTD  
 Operating Condition: WiFi Communicating  
 Test Site: 1#Shielding Room  
 Operator: STAR  
 Test Specification: L 240V/60Hz  
 Comment: Report No.:ATE20161167  
 Start of Test: 6/17/2016 / 10:19:47AM

**SCAN TABLE: "V 9K-30MHz fin"**

Start Frequency	Stop Frequency	Step Width	Detector	Meas. Time	IF Bandw.	Transducer
9.0 kHz	150.0 kHz	100.0 Hz	QuasiPeak	1.0 s	200 Hz	NSLK8126 2008
150.0 kHz	30.0 MHz	5.0 kHz	QuasiPeak	1.0 s	9 kHz	NSLK8126 2008

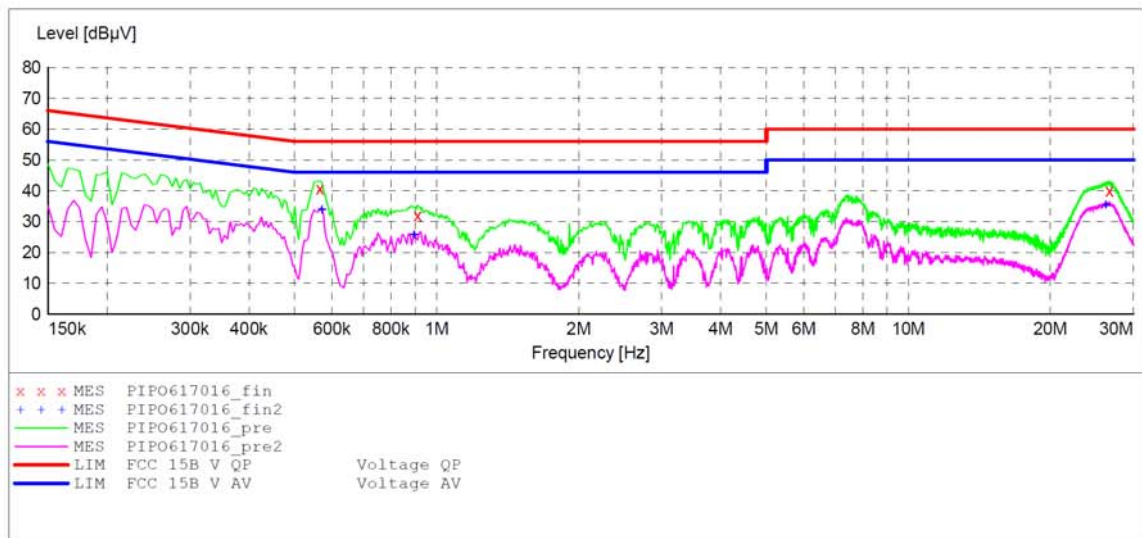

**MEASUREMENT RESULT: "PIPO617016\_fin"**

6/17/2016 10:22AM

Frequency MHz	Level dBµV	Transd dB	Limit dBµV	Margin dB	Detector	Line	PE
0.565000	40.70	10.7	56	15.3	QP	L1	GND
0.910000	32.00	10.8	56	24.0	QP	L1	GND
26.680000	39.90	11.5	60	20.1	QP	L1	GND

**MEASUREMENT RESULT: "PIPO617016\_fin2"**

6/17/2016 10:22AM

Frequency MHz	Level dBµV	Transd dB	Limit dBµV	Margin dB	Detector	Line	PE
0.570000	33.80	10.7	46	12.2	AV	L1	GND
0.895000	25.80	10.8	46	20.2	AV	L1	GND
26.230000	35.40	11.5	50	14.6	AV	L1	GND

**ACCURATE TECHNOLOGY CO., LTD**

**CONDUCTED EMISSION STANDARD FCC PART 15B**

EUT: Media box M/N:X9  
 Manufacturer: PIPO TECHNOLOGY CO., LTD  
 Operating Condition: WiFi Communicating  
 Test Site: 1#Shielding Room  
 Operator: STAR  
 Test Specification: N 240V/60Hz  
 Comment: Report No.:ATE20161167  
 Start of Test: 6/17/2016 / 10:15:49AM

**SCAN TABLE: "V 9K-30MHz fin"**

Start	Stop	Step	Detector	Meas. Time	IF Bandw.	Transducer
9.0 kHz	150.0 kHz	100.0 Hz	QuasiPeak Average	1.0 s	200 Hz	NSLK8126 2008
150.0 kHz	30.0 MHz	5.0 kHz	QuasiPeak Average	1.0 s	9 kHz	NSLK8126 2008

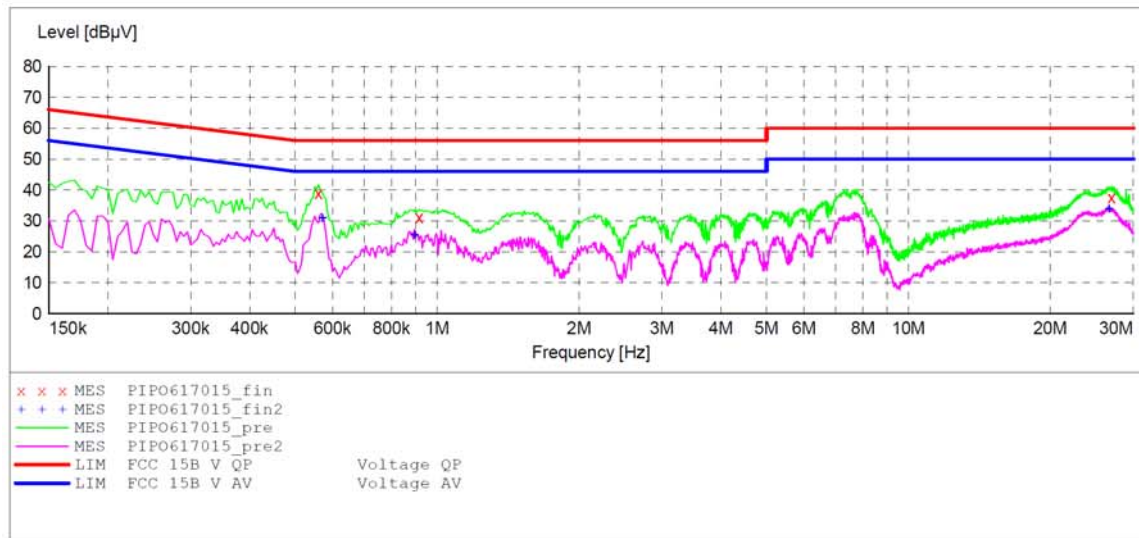

**MEASUREMENT RESULT: "PIPO617015\_fin"**

6/17/2016 10:18AM

Frequency MHz	Level dBµV	Transd dB	Limit dBµV	Margin dB	Detector	Line	PE
0.560000	38.90	10.7	56	17.1	QP	N	GND
0.915000	31.10	10.8	56	24.9	QP	N	GND
26.980000	37.60	11.5	60	22.4	QP	N	GND

**MEASUREMENT RESULT: "PIPO617015\_fin2"**

6/17/2016 10:18AM

Frequency MHz	Level dBµV	Transd dB	Limit dBµV	Margin dB	Detector	Line	PE
0.570000	31.00	10.7	46	15.0	AV	N	GND
0.895000	25.40	10.8	46	20.6	AV	N	GND
26.650000	33.90	11.5	50	16.1	AV	N	GND

## 6. 6DB&20DB BANDWIDTH MEASUREMENT

### 6.1. Block Diagram of Test Setup

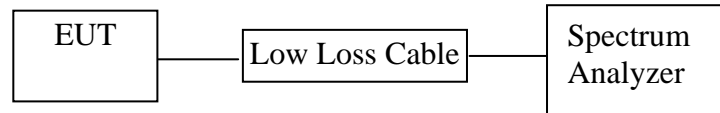

### 6.2. The Requirement For Section 15.247(a)(2)

Section 15.247(a)(2): Systems using digital modulation techniques may operate in the 902-928MHz, 2400-2483.5MHz, and 5725-5850MHz bands. The minimum 6 dB bandwidth shall be at least 500 kHz.

### 6.3. EUT Configuration on Measurement

The equipment are installed on the emission measurement to meet the commission requirements and operating regulations in a manner which tends to maximize its emission characteristics in normal application.

### 6.4. Operating Condition of EUT

6.4.1. Setup the EUT and simulator as shown as Section 5.1.

6.4.2. Turn on the power of all equipment.

6.4.3. Let the EUT work in TX modes measure it. The transmit frequency are 2412-2462 and 2422-2452MHz. We select 2412MHz, 2437MHz, 2462MHz and 2422MHz, 2437MHz, 2452MHz TX frequency to transmit.

### 6.5. Test Procedure

1. Set resolution bandwidth (RBW) = 100 kHz.
2. Set the video bandwidth (VBW)  $\geq 3 \times$  RBW.
3. Detector = Peak.
4. Trace mode = max hold.
5. Sweep = auto couple.
6. Allow the trace to stabilize.
7. Measure the maximum width of the emission that is constrained by the frequencies associated with the two outermost amplitude points (upper and lower) that are attenuated by 6 dB relative to the maximum level measured in the fundamental emission.

20dB bandwidth

1. Set resolution bandwidth (RBW) = 1%-5% OBW.
2. Set the video bandwidth (VBW)  $\geq 3 \times$  RBW.

3. Detector = Peak.
4. Trace mode = max hold.
5. Sweep = auto couple.
6. Allow the trace to stabilize.
7. Once the reference level is established, the equipment is conditioned with typical modulating signals to produce the worst-case (i.e., the widest) bandwidth. Unless otherwise specified for an unlicensed wireless device, measure the bandwidth at the - 20 dB levels with respect to the reference level

### 6.6. Test Result

The test was performed with 802.11b				
Channel	Frequency (MHz)	6dB Bandwidth (MHz)	Limit (MHz)	20dB Bandwidth (MHz)
Low	2412	10.12	> 0.5MHz	17.598
Middle	2437	10.12	> 0.5MHz	17.135
High	2462	10.12	> 0.5MHz	17.540

The test was performed with 802.11g				
Channel	Frequency (MHz)	6dB Bandwidth (MHz)	Limit (MHz)	20dB Bandwidth (MHz)
Low	2412	16.60	> 0.5MHz	19.740
Middle	2437	16.60	> 0.5MHz	19.392
High	2462	16.60	> 0.5MHz	19.624

The test was performed with 802.11n (Bandwidth: 20 MHz)				
Channel	Frequency (MHz)	6dB Bandwidth (MHz)	Limit (MHz)	20dB Bandwidth (MHz)
Low	2412	17.84	> 0.5MHz	20.904
Middle	2437	17.84	> 0.5MHz	20.123
High	2462	17.84	> 0.5MHz	19.472

The test was performed with 802.11n (Bandwidth: 40 MHz)				
Channel	Frequency (MHz)	6dB Bandwidth (MHz)	Limit (MHz)	20dB Bandwidth (MHz)
Low	2422	36.56	> 0.5MHz	40.84
Middle	2437	36.56	> 0.5MHz	40.96
High	2452	36.56	> 0.5MHz	40.96

The spectrum analyzer plots are attached as below.

### 6dB Bandwidth 802.11b Channel Low 2412MHz

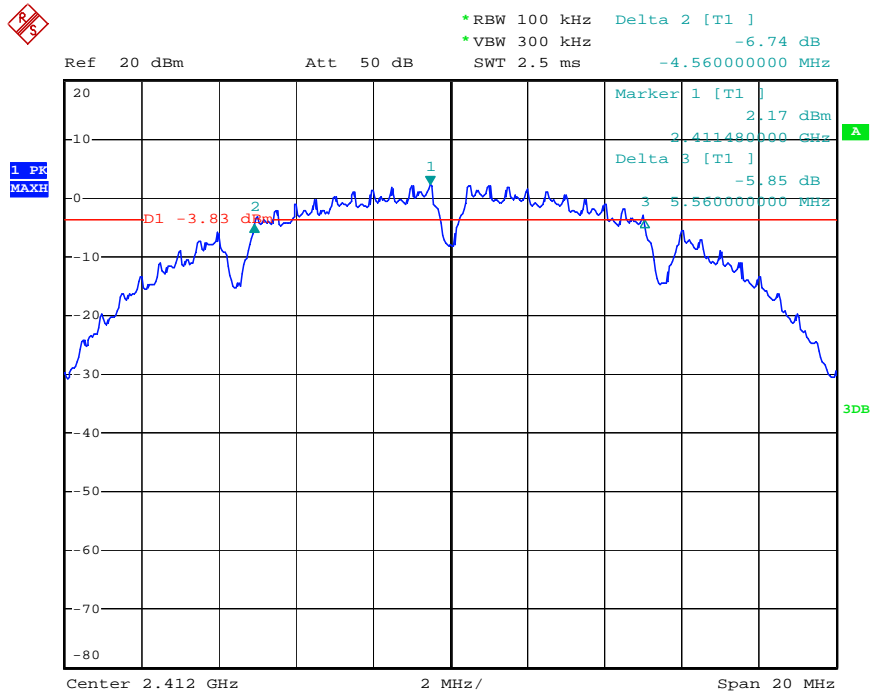

### 802.11b Channel Middle 2437MHz

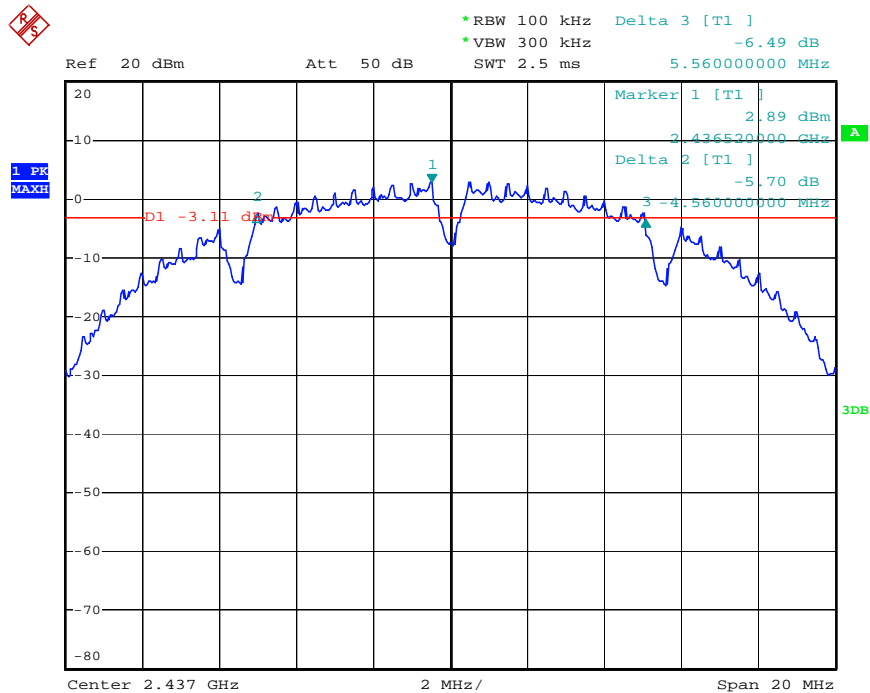

### 802.11b Channel High 2462MHz

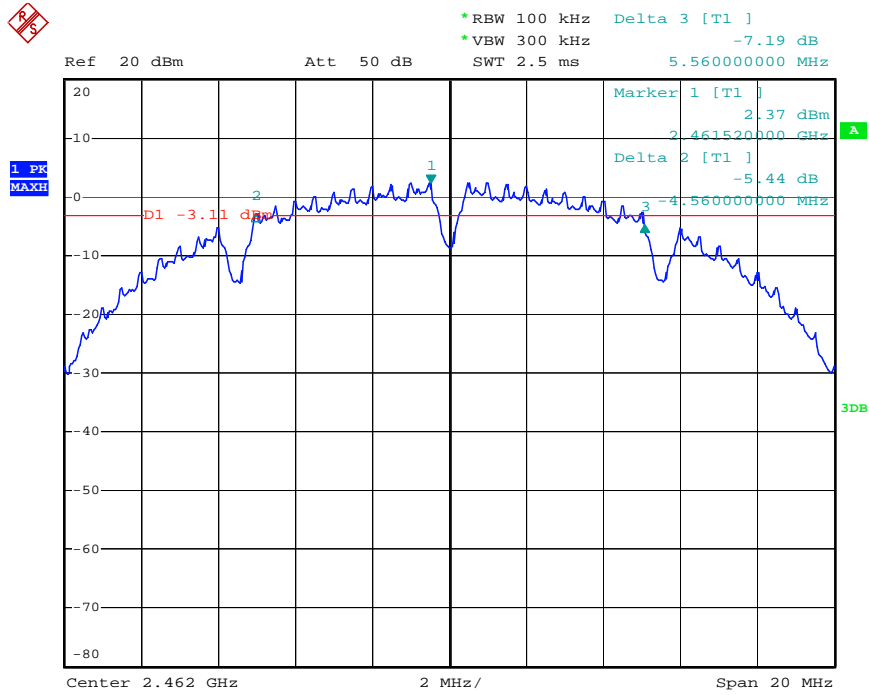

### 802.11g Channel Low 2412MHz

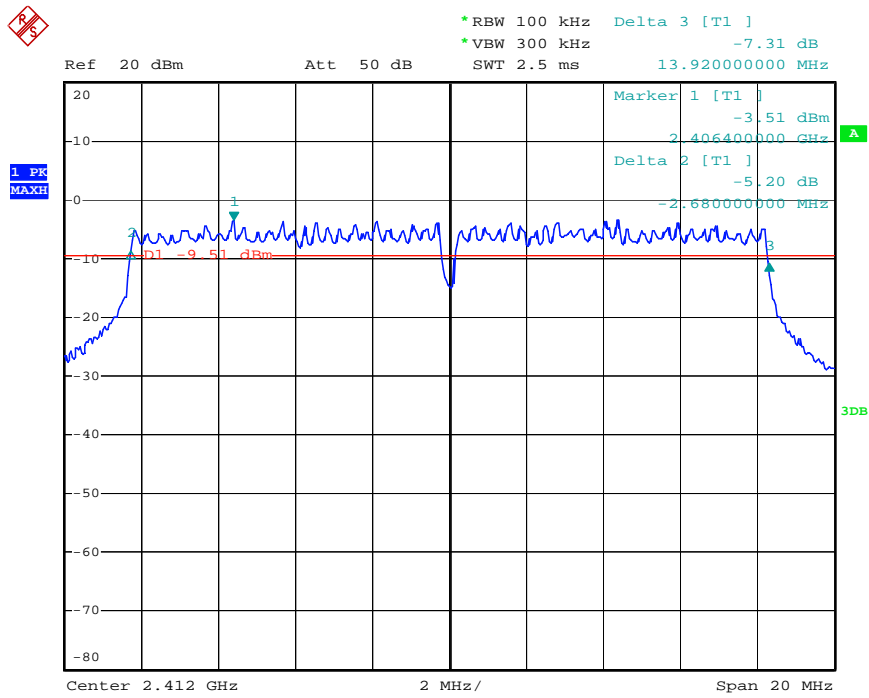

### 802.11g Channel Middle 2437MHz

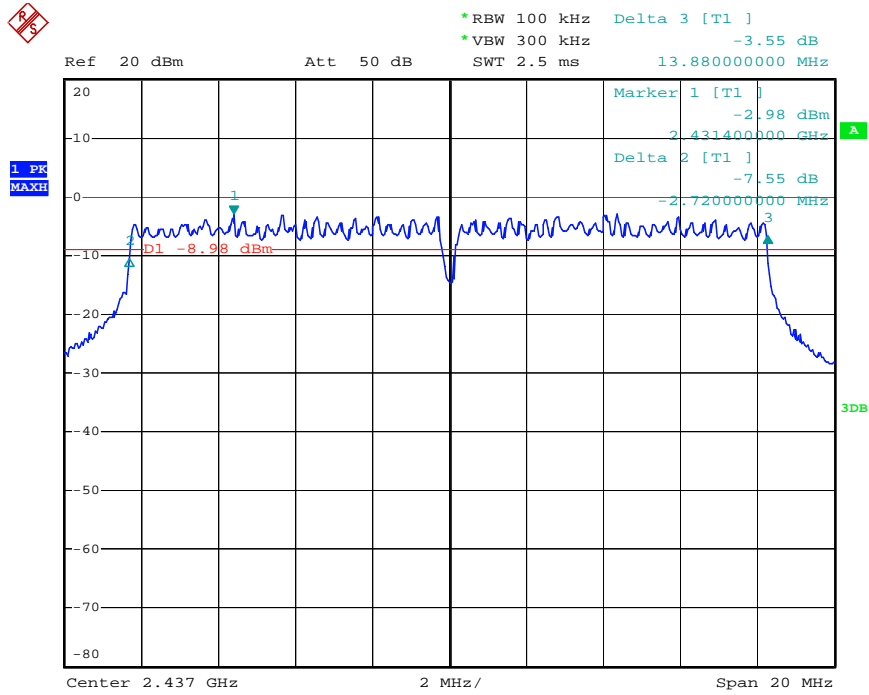

### 802.11g Channel High 2462MHz

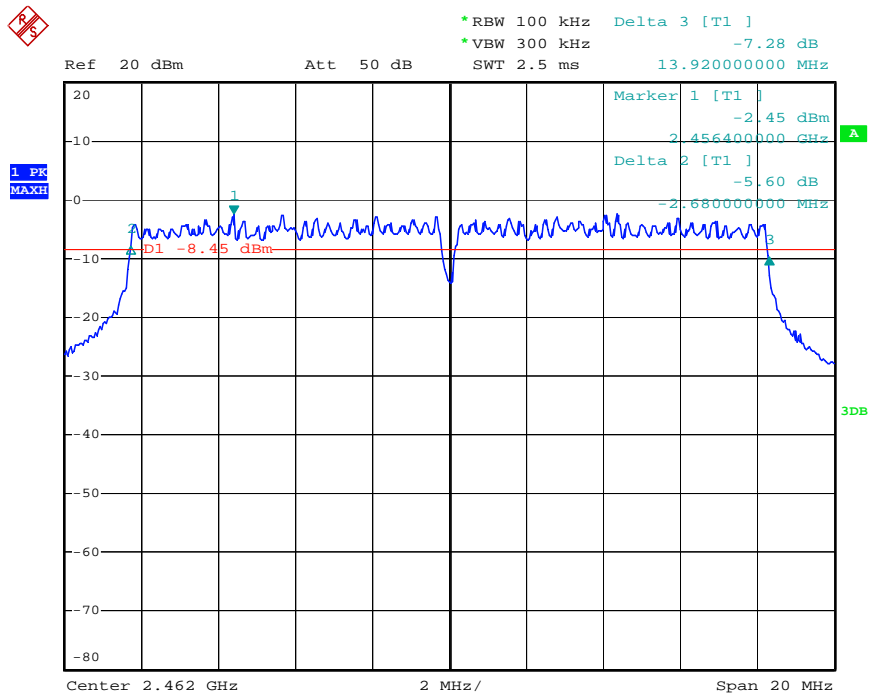

### 802.11n Channel Low 2412MHz (20MHz)

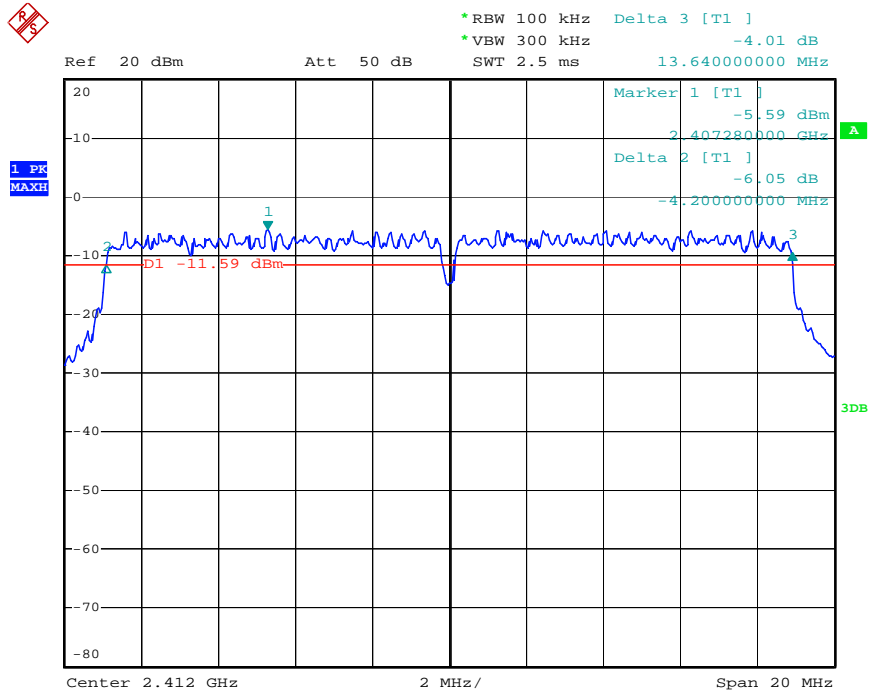

### 802.11n Channel Middle 2437MHz(20MHz)

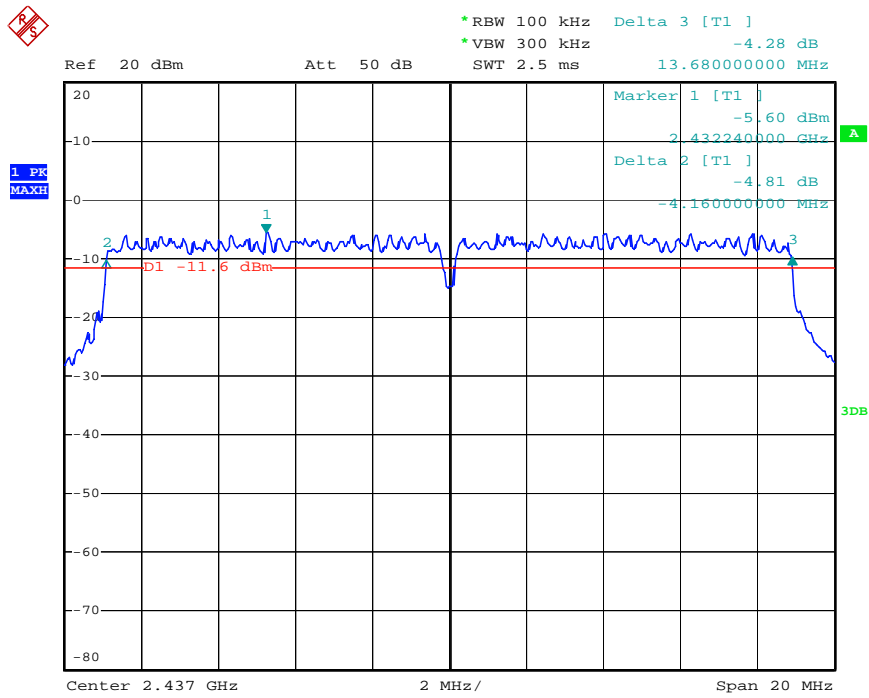



### 802.11n Channel High 2462MHz(20MHz)

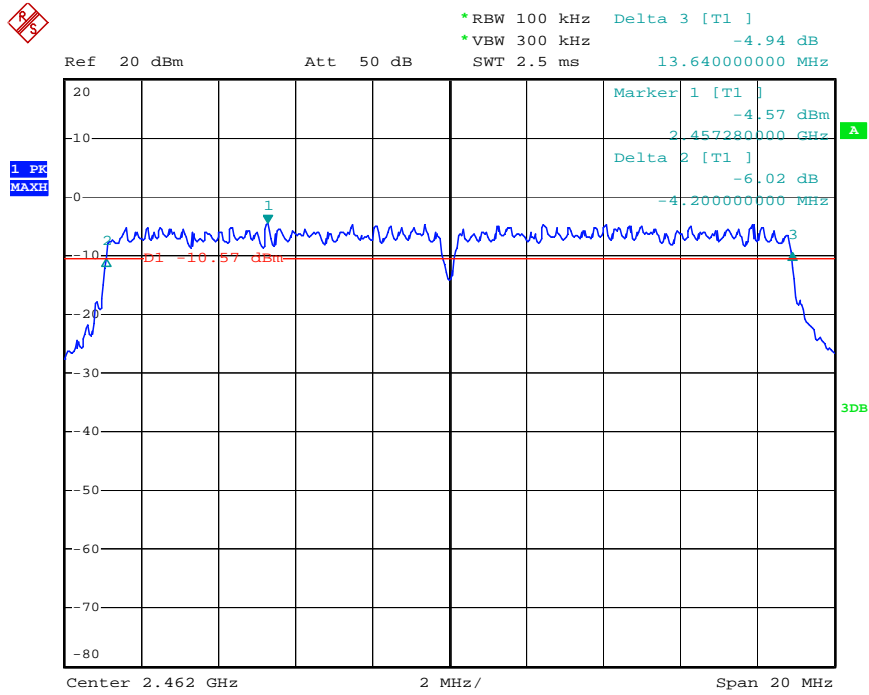

### 802.11n Channel Low 2422MHz (40MHz)

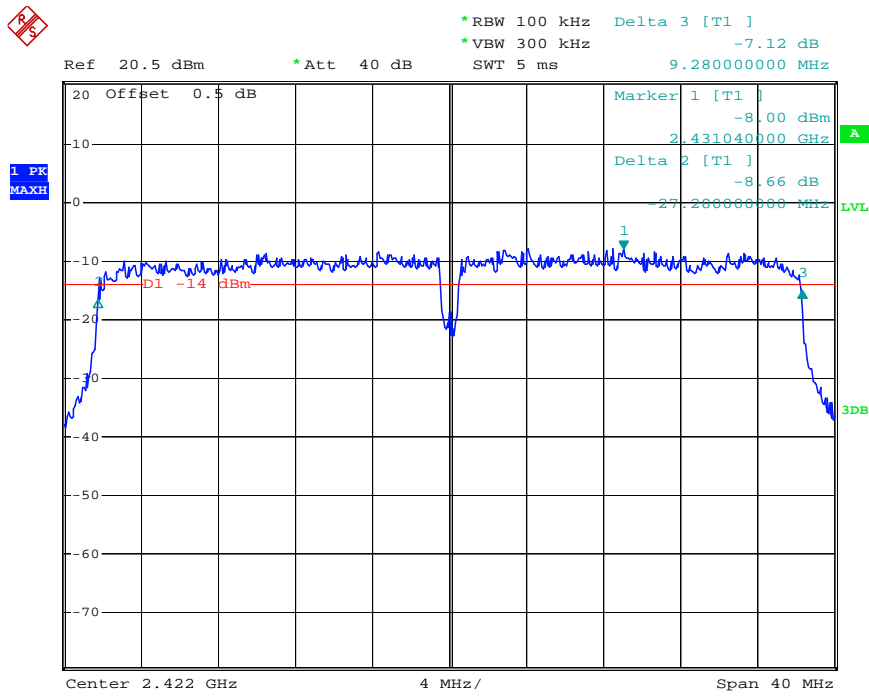

### 802.11n Channel Middle 2437MHz(40MHz)

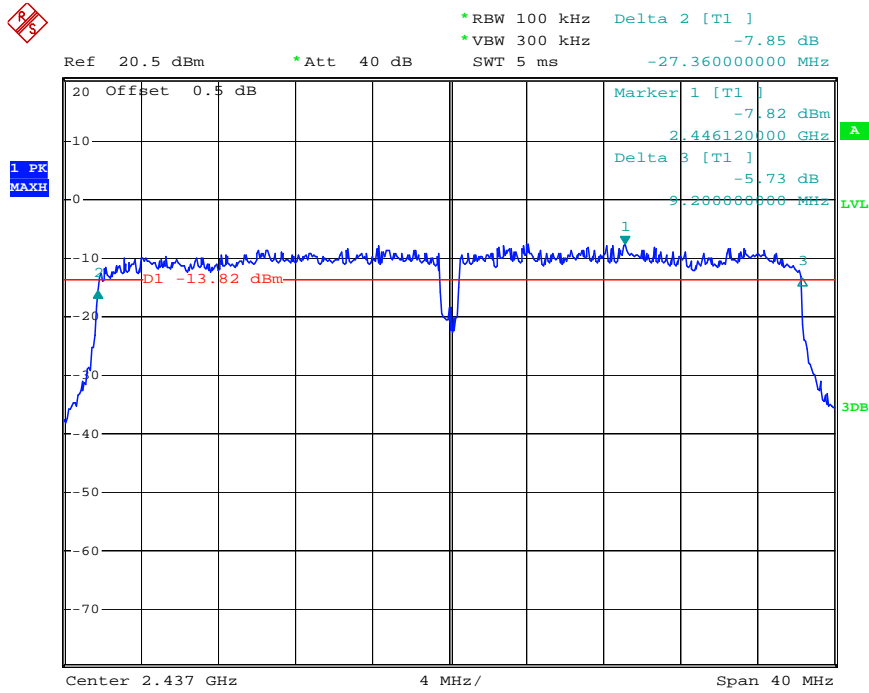

### 802.11n Channel High 2452MHz(40MHz)

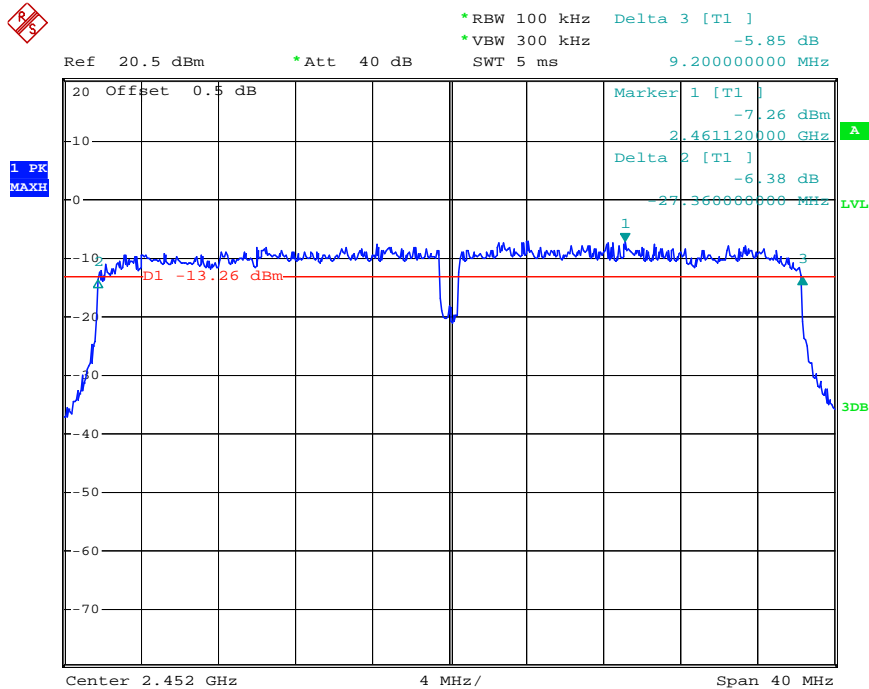

### 20dB Bandwidth 802.11b Channel Low 2412MHz

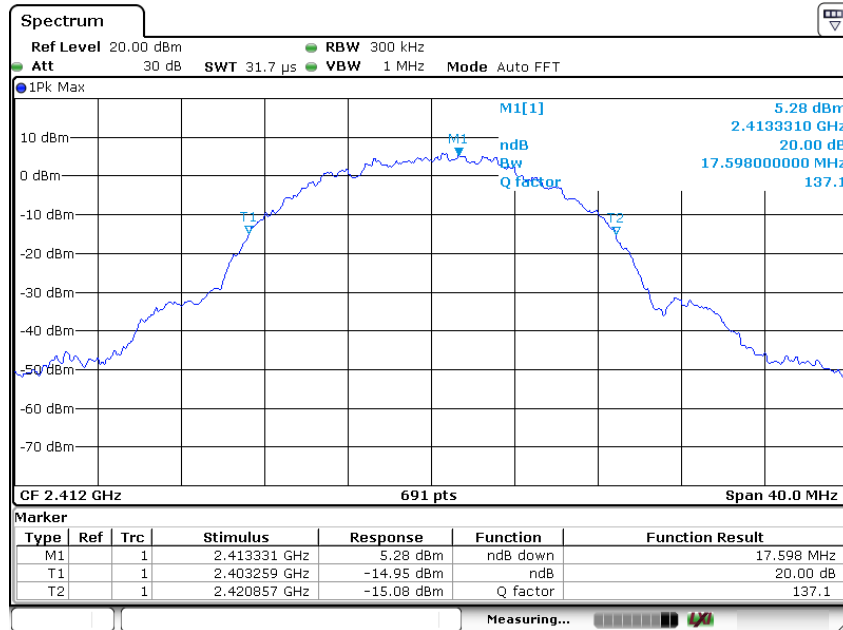

### 802.11b Channel Middle 2437MHz

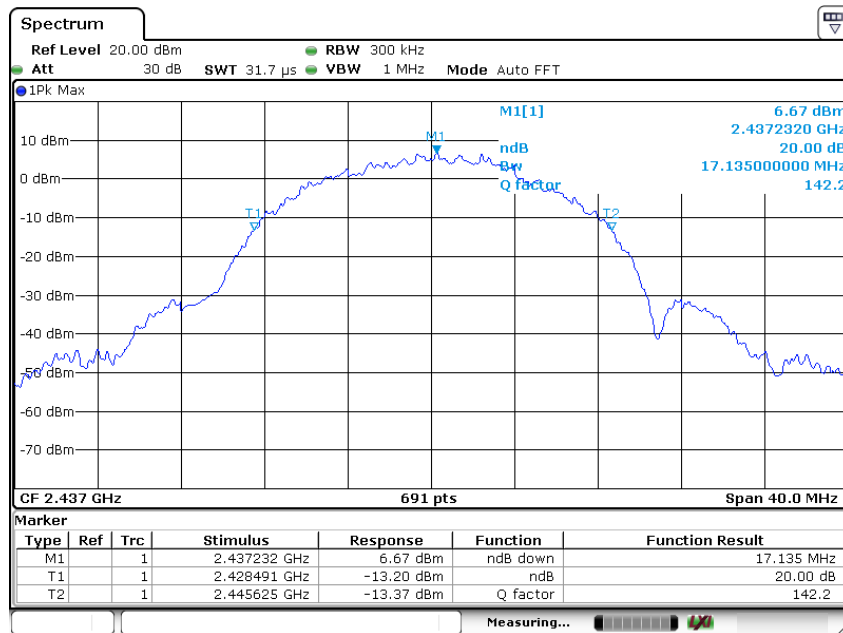

### 802.11b Channel High 2462MHz

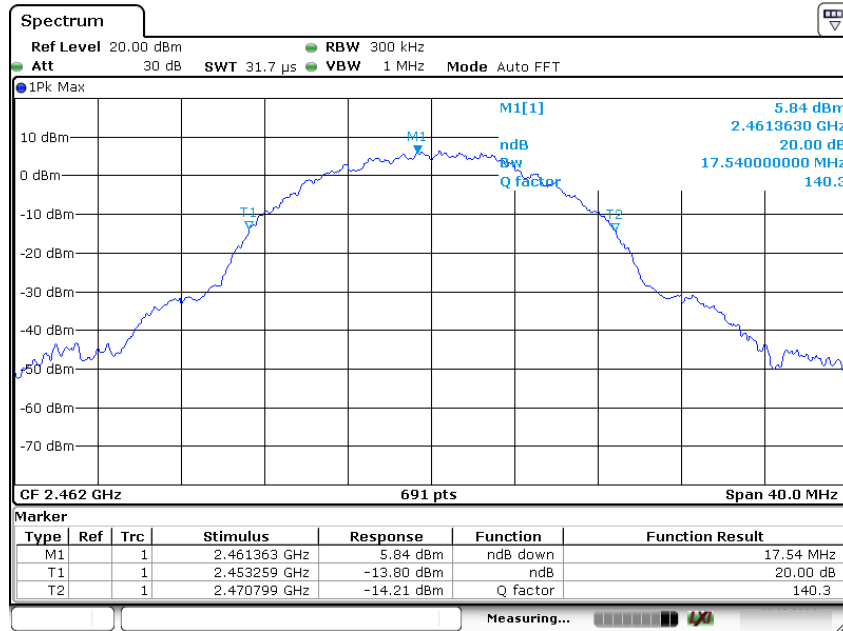

### 802.11g Channel Low 2412MHz

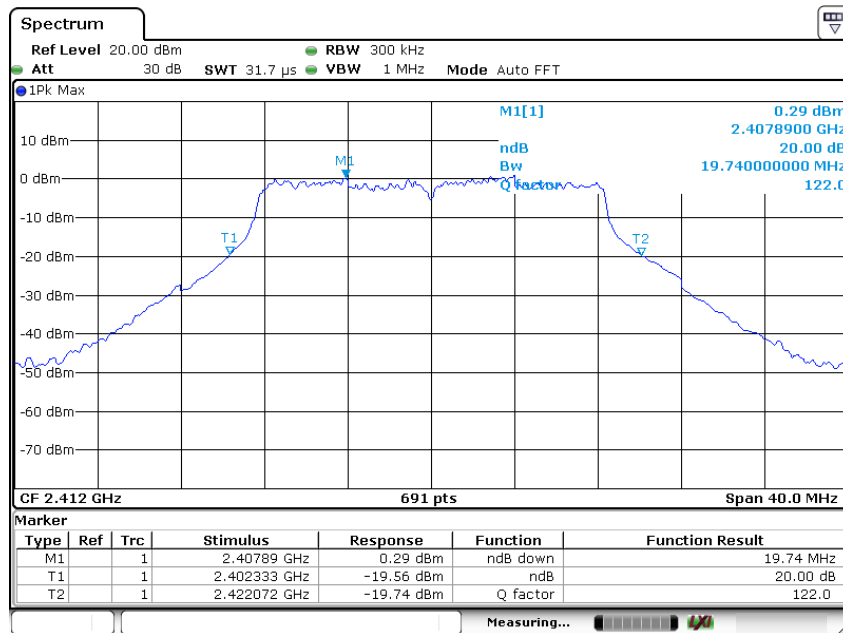

### 802.11g Channel Middle 2437MHz

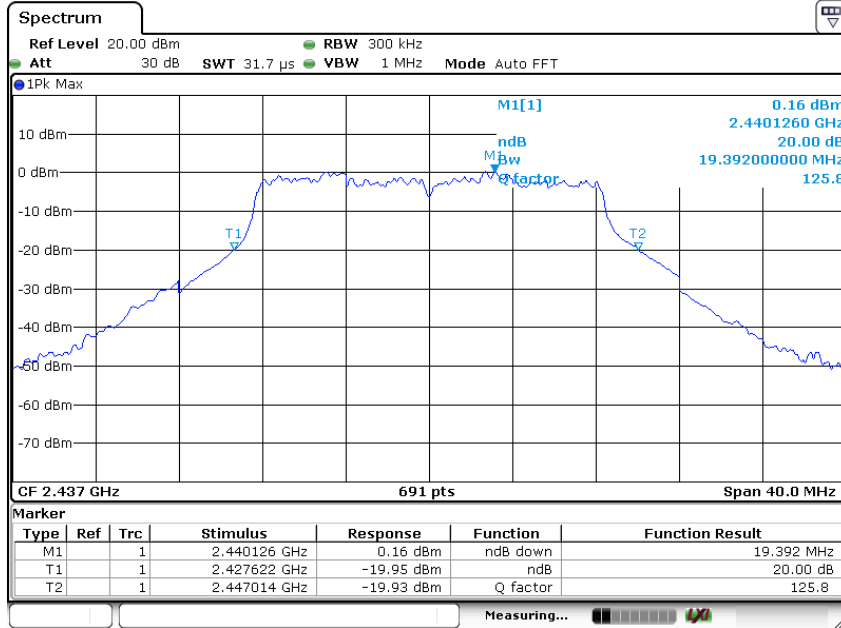

### 802.11g Channel High 2462MHz

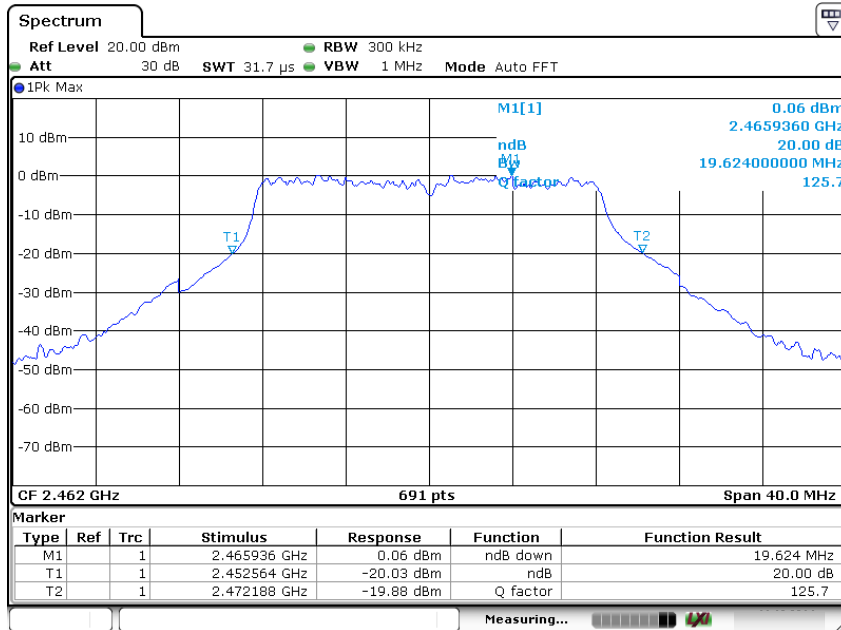

### 802.11n Channel Low 2412MHz (20MHz)

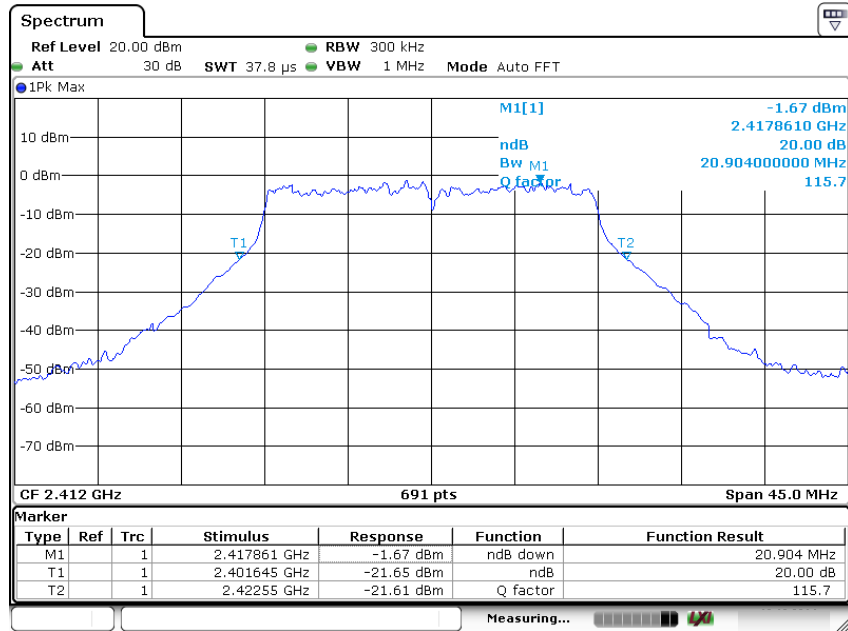

### 802.11n Channel Middle 2437MHz(20MHz)

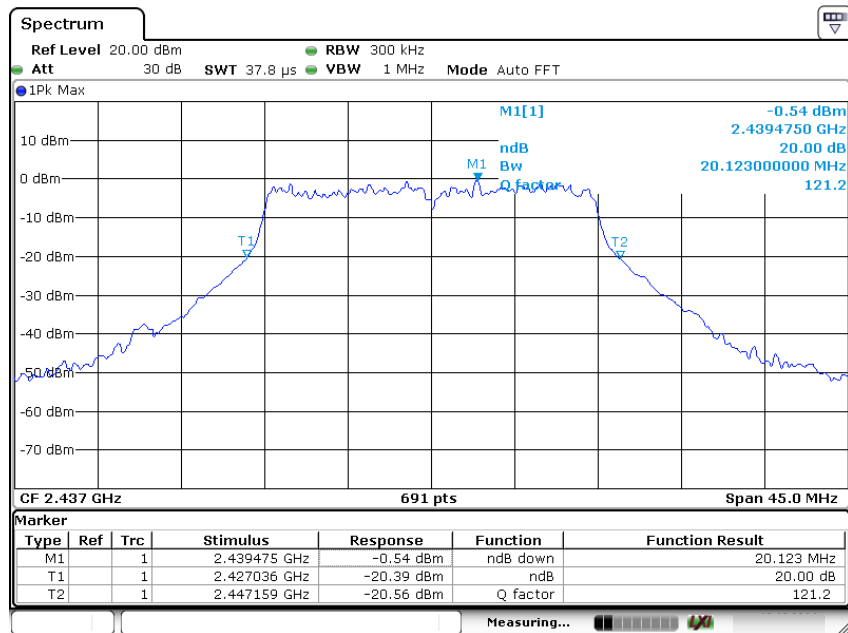

### 802.11n Channel High 2462MHz(20MHz)

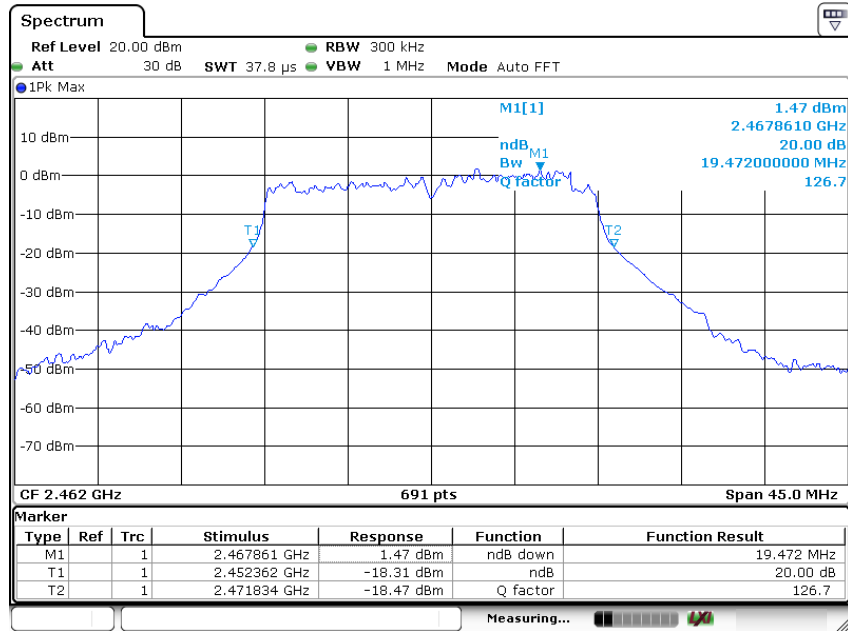

### 802.11n Channel Low 2422MHz (40MHz)

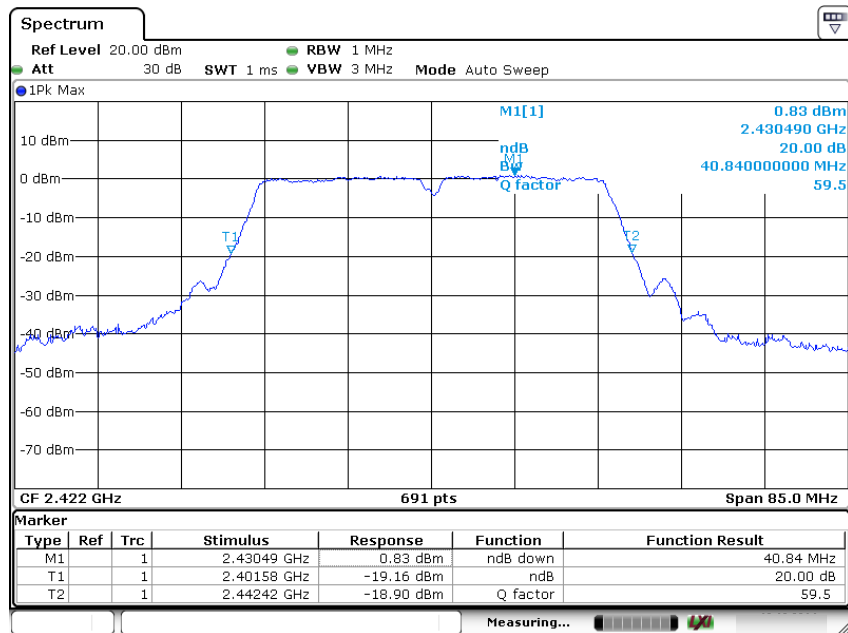

### 802.11n Channel Middle 2437MHz(40MHz)

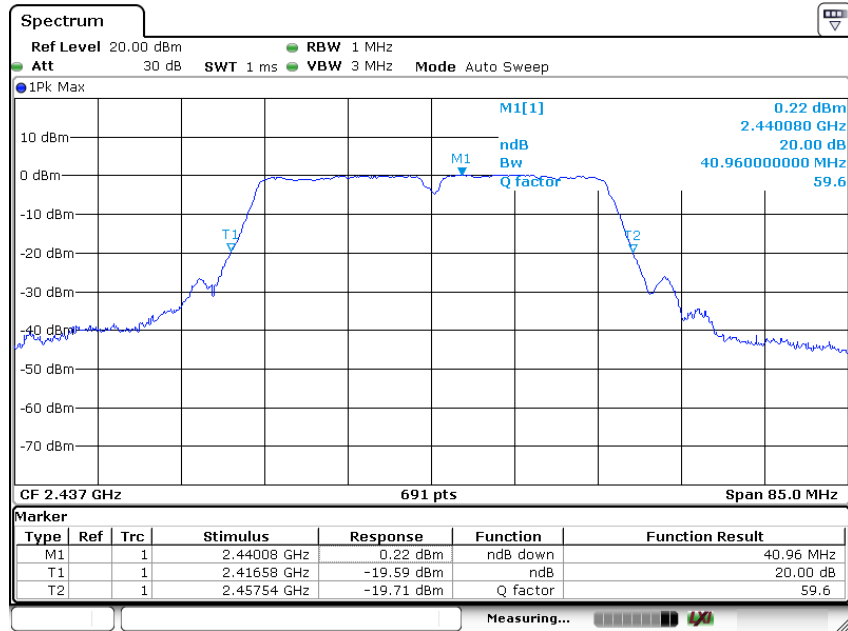

### 802.11n Channel High 2452MHz(40MHz)

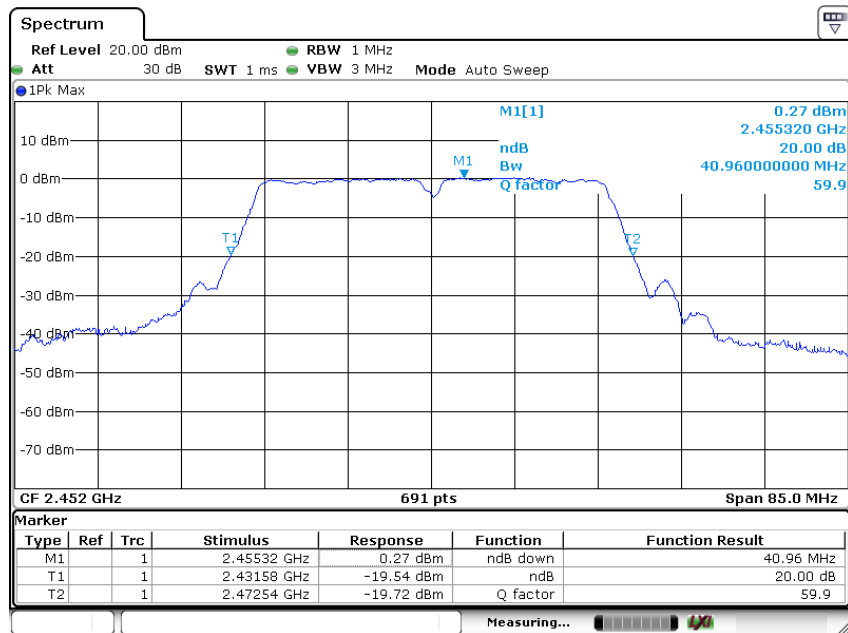



## 7. MAXIMUM CONDUCTED (AVERAGE) OUTPUT POWER

### 7.1. Block Diagram of Test Setup

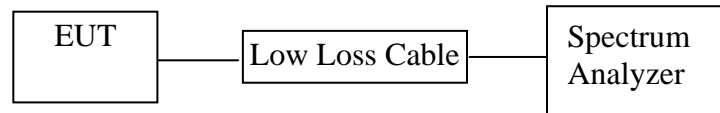

### 7.2. The Requirement For Section 15.247(b)(3)

Section 15.247(b)(3): For systems using digital modulation in the 902-928MHz, 2400-2483.5MHz, and 5725-5850MHz bands: 1 Watt.

### 7.3. EUT Configuration on Measurement

The equipment is installed on the emission Measurement to meet the commission requirements and operating regulations in a manner which tends to maximize its emission characteristics in normal application.

### 7.4. Operating Condition of EUT

7.4.1. Setup the EUT and simulator as shown as Section 7.1.

7.4.2. Turn on the power of all equipment.

7.4.3. Let the EUT work in TX modes measure it. The transmit frequency are 2412-2462 and 2422-2452MHz. We select 2412MHz, 2437MHz, 2462MHz and 2422MHz, 2437MHz, 2452MHz TX frequency to transmit.

### 7.5. Test Procedure

7.5.1. The EUT was tested according to DTS test procedure of Apr 08, 2016

KDB558074 D01 DTS Meas Guidance v03r05 for compliance to

FCC 47CFR 15.247 requirements.

7.5.2. The transmitter output was connected to the spectrum analyzer through a low loss cable.

7.5.3. Set RBW = 1-5% of the OBW, not to exceed 1 MHz, VBW  $\geq$  3 x RBW, Sweep time = auto, Set span to at least 1.5 times the OBW, Detector = RMS.

7.5.4. Measurement the Maximum conducted (average) output power.

### 7.6. Test Result

The test was performed with 802.11b				
Channel	Frequency (MHz)	Ave output power (dBm)	Ave output power (mW)	Limits dBm / W
Low	2412	5.20	3.311	30 dBm / 1 W
Middle	2437	5.14	3.266	30 dBm / 1 W
High	2462	5.26	3.357	30 dBm / 1 W

The test was performed with 802.11g				
Channel	Frequency (MHz)	Ave output power (dBm)	Ave output power (mW)	Limits dBm / W
Low	2412	4.23	2.649	30 dBm / 1 W
Middle	2437	4.12	2.582	30 dBm / 1 W
High	2462	4.46	2.793	30 dBm / 1 W

The test was performed with 802.11n (20MHz)				
Channel	Frequency (MHz)	Ave output power (dBm)	Ave output power (mW)	Limits dBm / W
Low	2412	4.26	2.667	30 dBm / 1 W
Middle	2437	4.92	3.105	30 dBm / 1 W
High	2462	4.63	2.904	30 dBm / 1 W

The test was performed with 802.11n (40MHz)				
Channel	Frequency (MHz)	Ave output power (dBm)	Ave output power (mW)	Limits dBm / W
Low	2422	3.88	2.443	30 dBm / 1 W
Middle	2437	3.82	2.410	30 dBm / 1 W
High	2452	3.83	2.415	30 dBm / 1 W

The spectrum analyzer plots are attached as below.

### 802.11b Channel Low 2412MHz

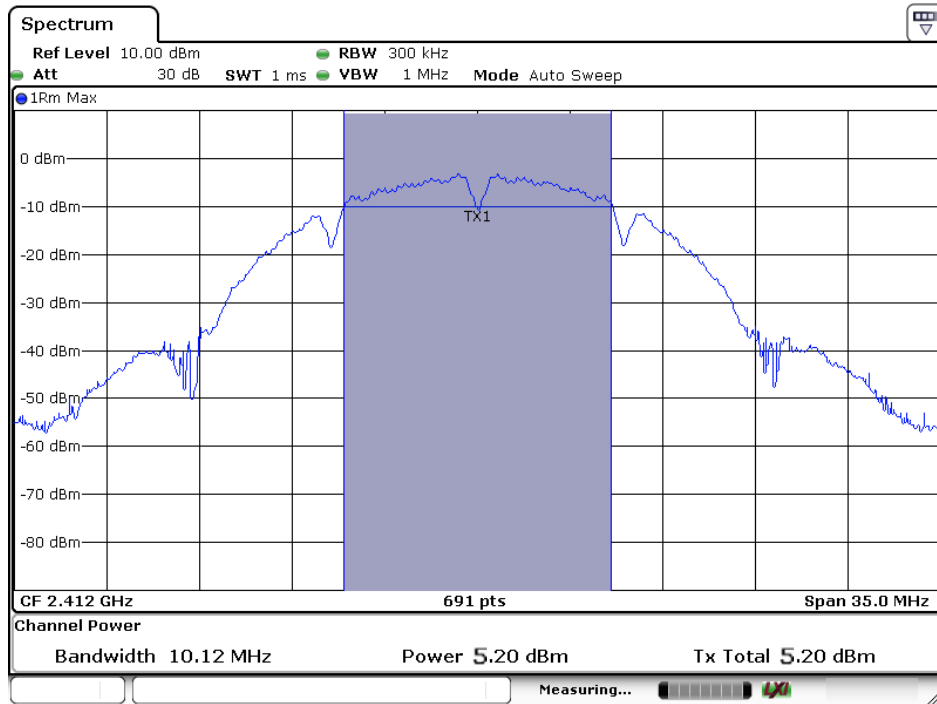

### 802.11b Channel Middle 2437MHz

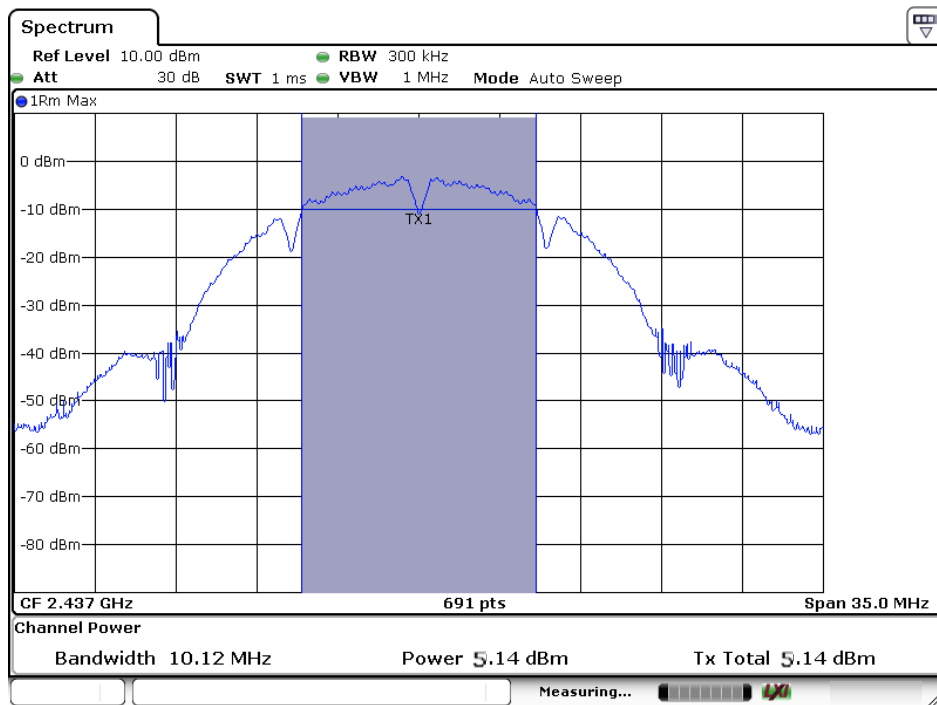

### 802.11b Channel High 2462MHz

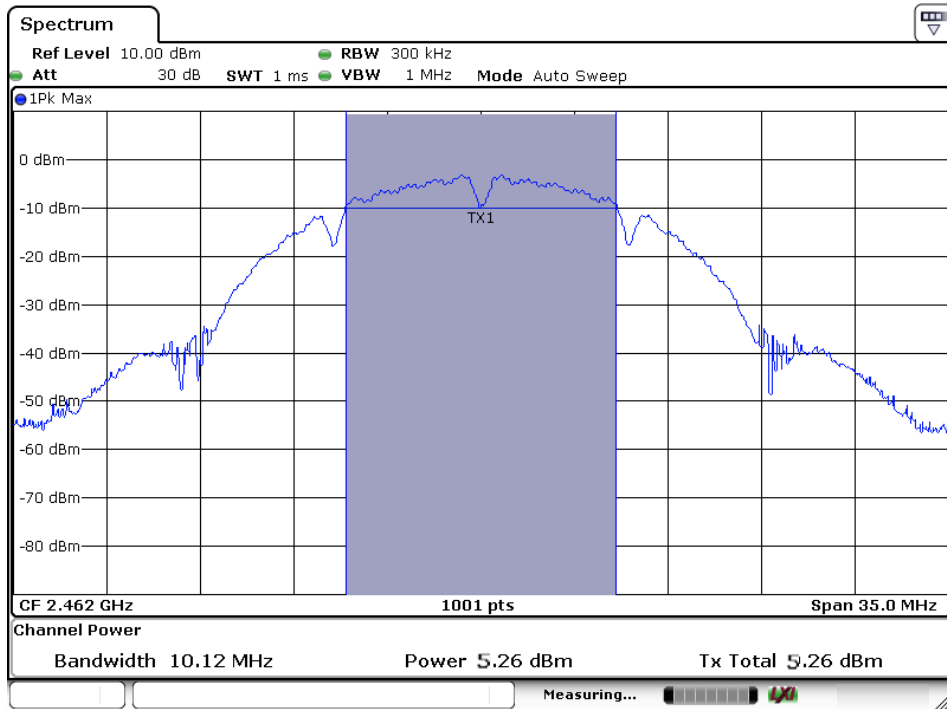

### 802.11g Channel Low 2412MHz

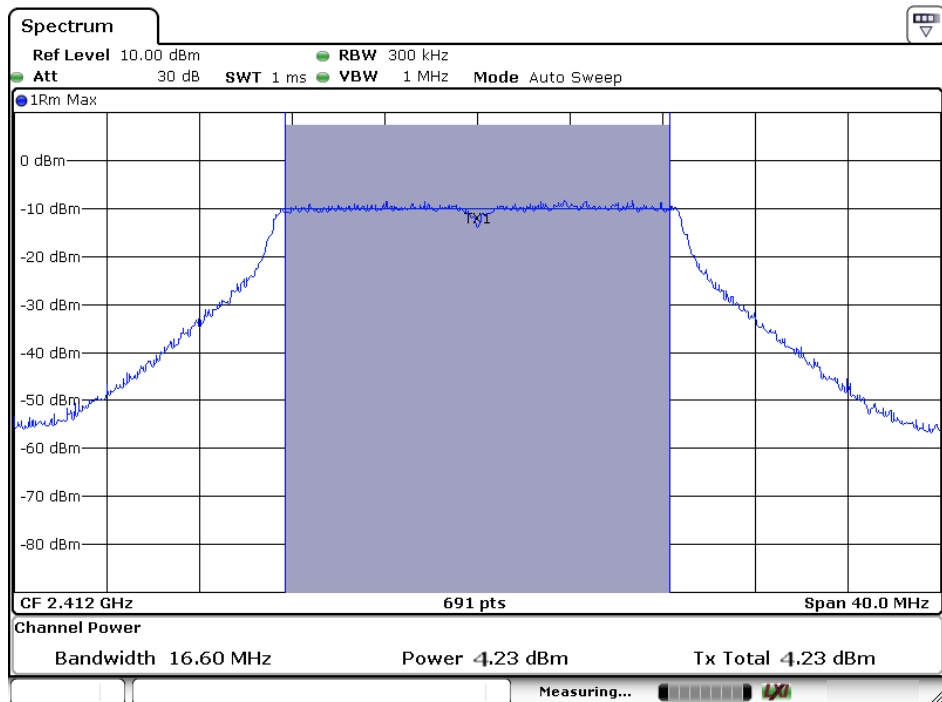

### 802.11g Channel Middle 2437MHz

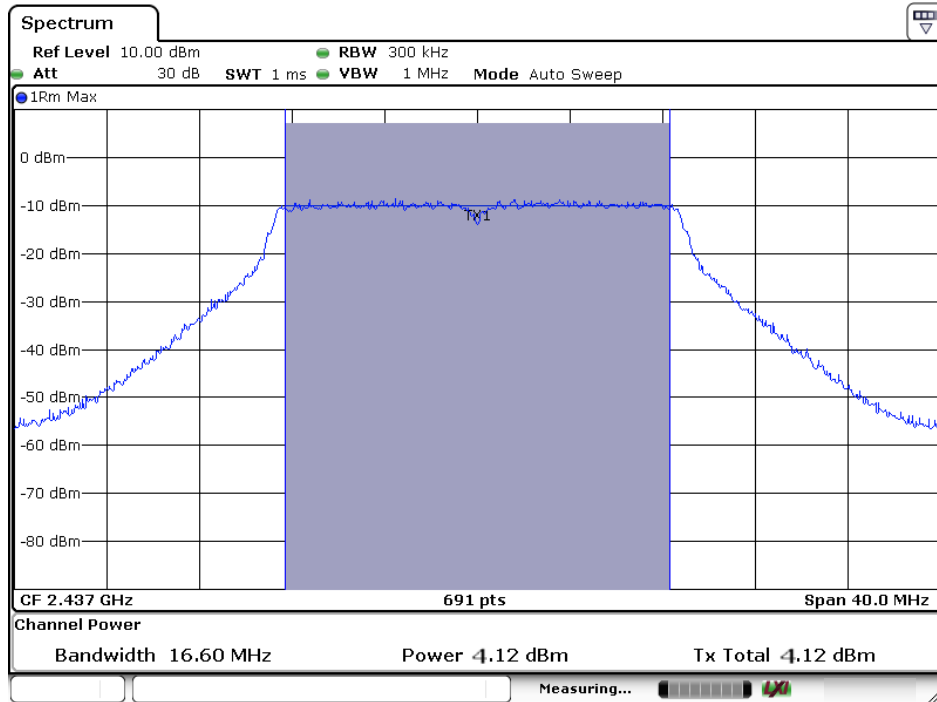

### 802.11g Channel High 2462MHz

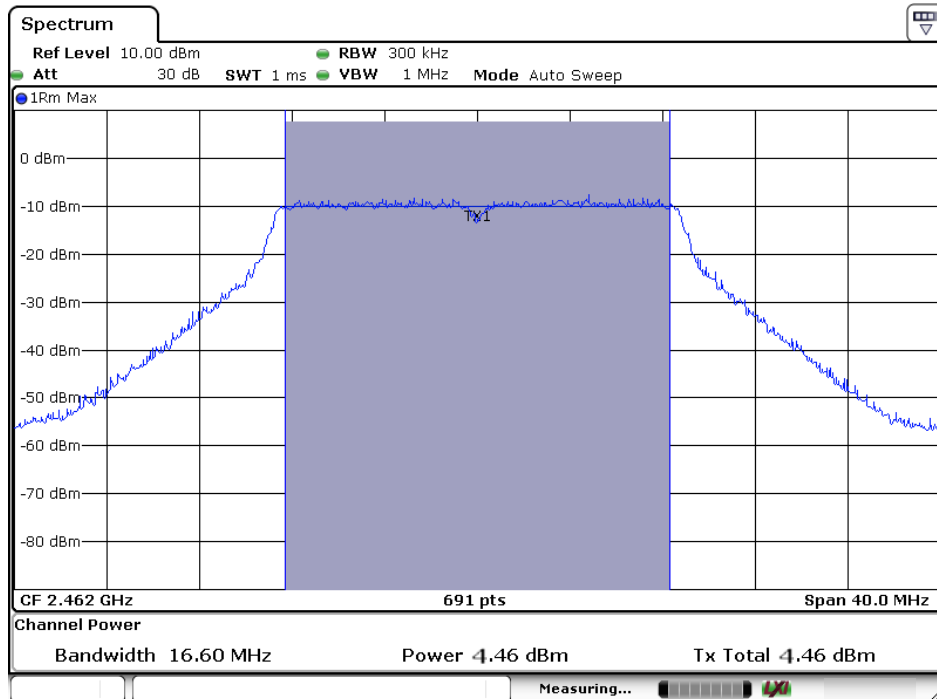

802.11n Channel Low 2412MHz (20MHz)

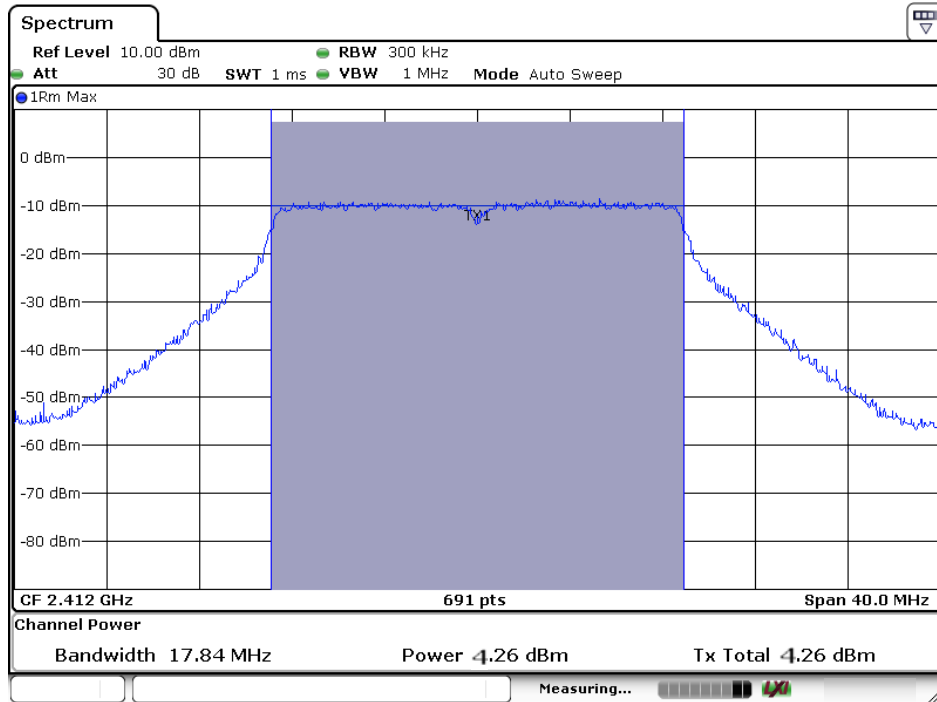

802.11n Channel Middle 2437MHz (20MHz)

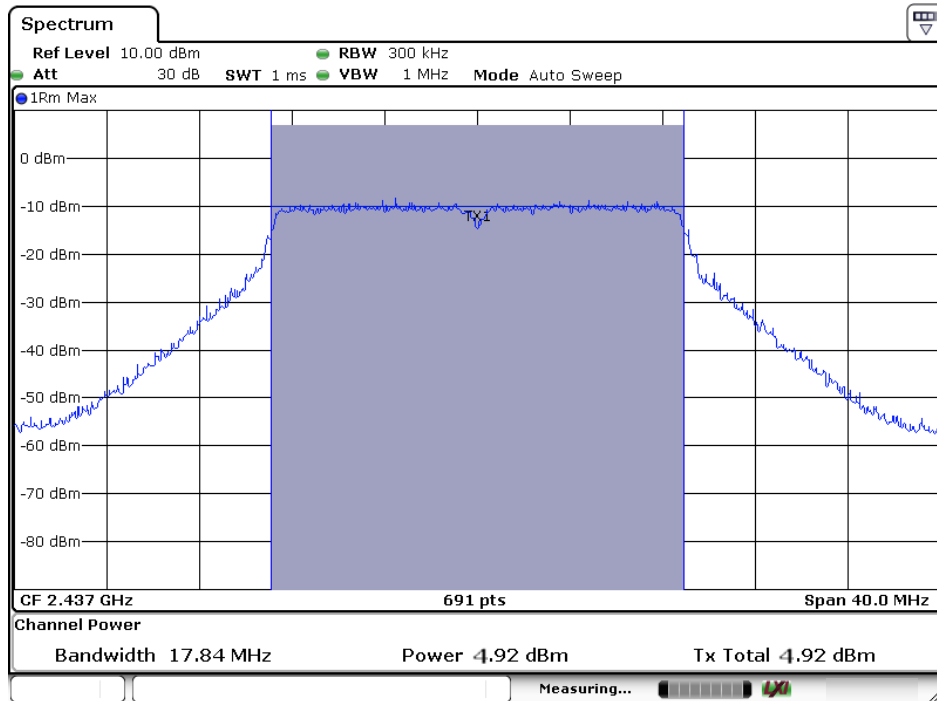

### 802.11n Channel High 2462MHz (20MHz)

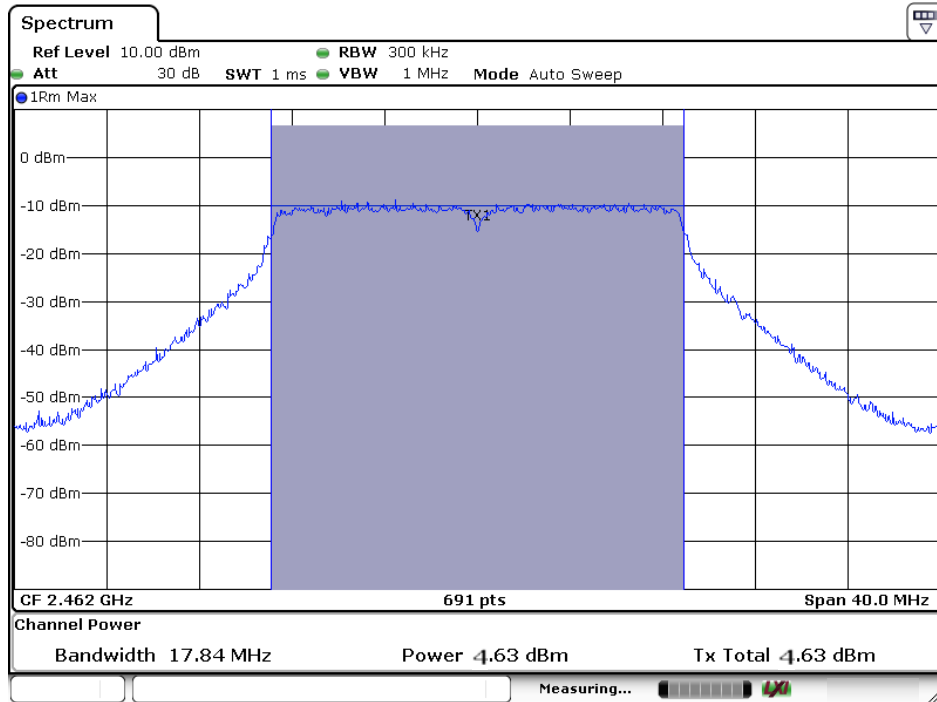

### 802.11n Channel Low 2422MHz (40MHz)

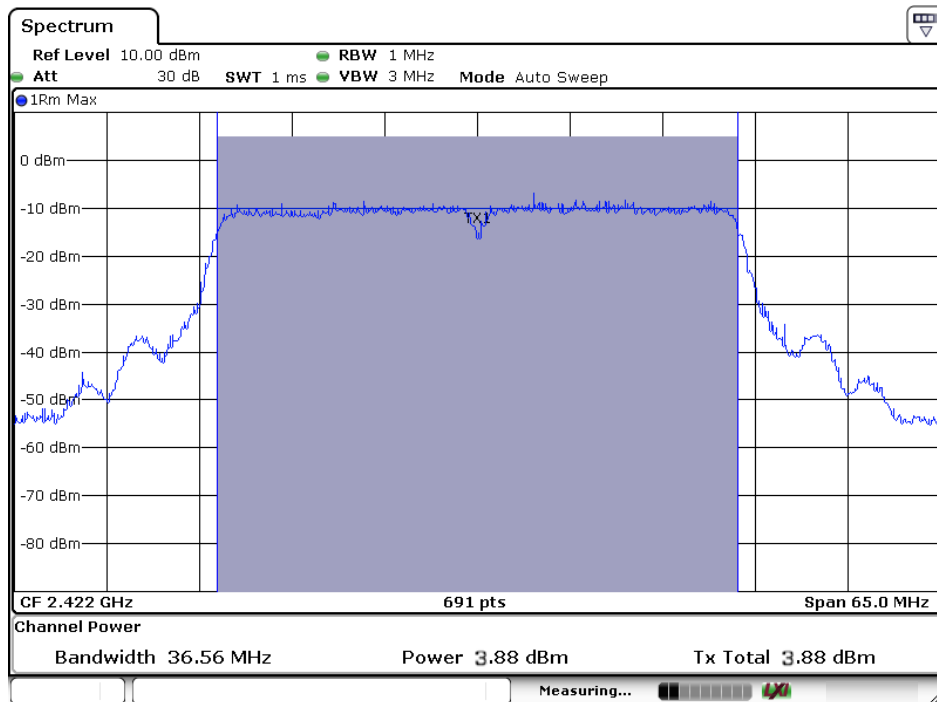

802.11n Channel Middle 2437MHz (40MHz)

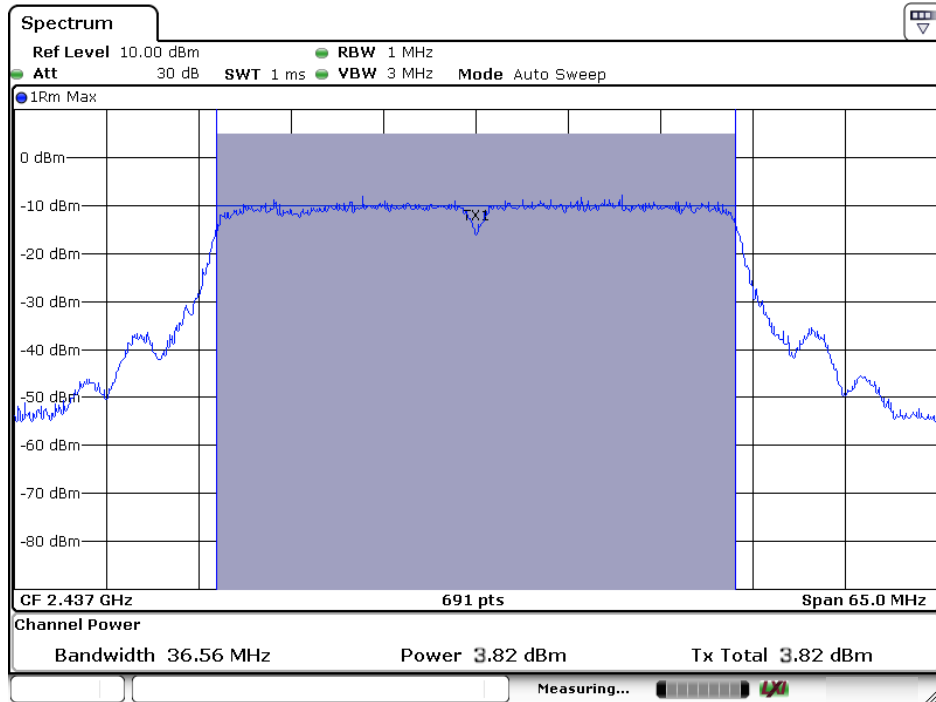

802.11n Channel High 2452MHz (40MHz)

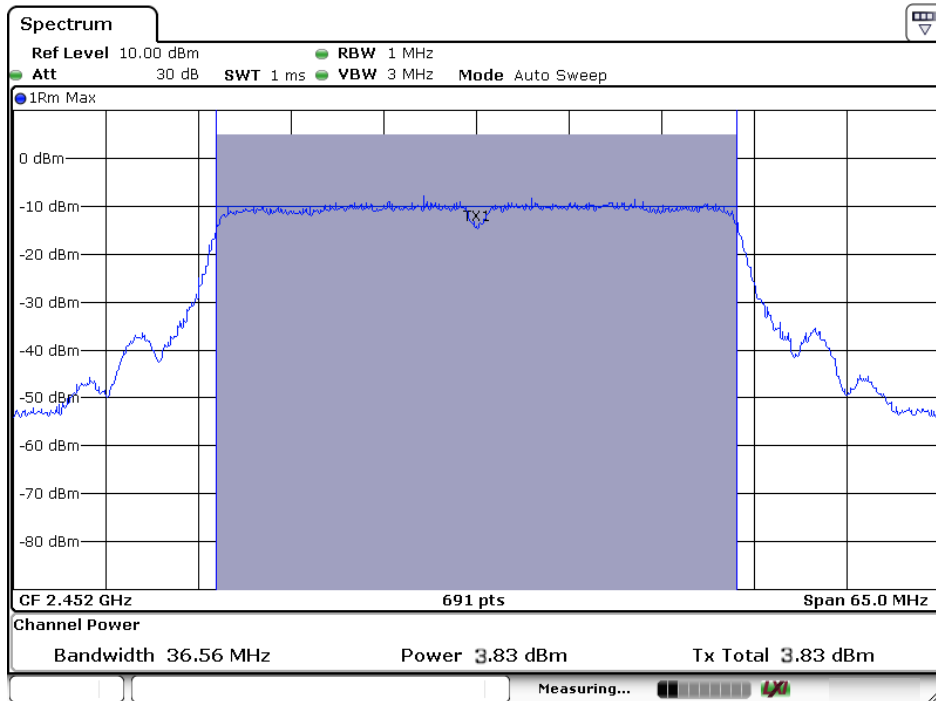



## 8. POWER SPECTRAL DENSITY MEASUREMENT

### 8.1. Block Diagram of Test Setup

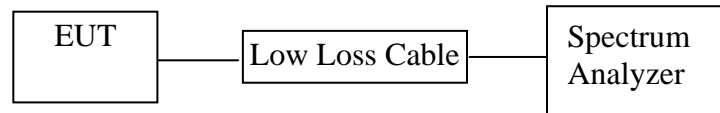

### 8.2. The Requirement For Section 15.247(e)

Section 15.247(e): For digitally modulated systems, the power spectral density conducted from the intentional radiator to the antenna shall not be greater than 8 dBm in any 3 kHz band during any time interval of continuous transmission.

### 8.3. EUT Configuration on Measurement

The equipment are installed on the emission Measurement to meet the commission requirements and operating regulations in a manner which tends to maximize its emission characteristics in normal application.

### 8.4. Operating Condition of EUT

8.4.1. Setup the EUT and simulator as shown as Section 8.1.

8.4.2. Turn on the power of all equipment.

8.4.3. Let the EUT work in TX modes measure it. The transmit frequency are 2412-2462 and 2422-2452MHz. We select 2412MHz, 2437MHz, 2462MHz and 2422MHz, 2437MHz, 2452MHz TX frequency to transmit.

### 8.5. Test Procedure

8.5.1. The transmitter output was connected to the spectrum analyzer through a low loss cable.

8.5.2. Measurement Procedure PKPSD:

This procedure must be used if maximum peak conducted output power was used to demonstrate compliance to the fundamental output power limit, and is optional if the maximum (average) conducted output power was used to demonstrate compliance.

1. Set analyzer center frequency to DTS channel center frequency.
2. Set the span to 1.5 times the DTS channel bandwidth.

3. Set the RBW  $3 \text{ kHz} \leq \text{RBW} \leq 100 \text{ kHz}$ .
4. Set the VBW  $\geq 3 \times \text{RBW}$ .
5. Detector = peak.
6. Sweep time = auto couple.
7. Trace mode = max hold.
8. Allow trace to fully stabilize.
9. Use the peak marker function to determine the maximum amplitude level.
10. If measured value exceeds limit, reduce RBW (no less than 3 kHz) and repeat.

8.5.3. Measurement the maximum power spectral density.

8.6. Test Result

The test was performed with 802.11b			
Channel	Frequency (MHz)	Power Spectral Density (dBm)	Limits (dBm)
Low	2412	-19.03	8 dBm
Middle	2437	-19.15	8 dBm
High	2462	-19.43	8 dBm

The test was performed with 802.11g			
Channel	Frequency (MHz)	Power Spectral Density (dBm)	Limits (dBm)
Low	2412	-26.53	8 dBm
Middle	2437	-26.33	8 dBm
High	2462	-26.41	8 dBm

The test was performed with 802.11n (20MHz)			
Channel	Frequency (MHz)	Power Spectral Density (dBm)	Limits (dBm)
Low	2412	-26.46	8 dBm
Middle	2437	-27.02	8 dBm
High	2462	-26.83	8 dBm

The test was performed with 802.11n (40MHz)			
Channel	Frequency (MHz)	Power Spectral Density (dBm)	Limits (dBm)
Low	2422	-29.86	8 dBm
Middle	2437	-29.69	8 dBm
High	2452	-29.61	8 dBm

The spectrum analyzer plots are attached as below.

### 802.11b Channel Low 2412MHz

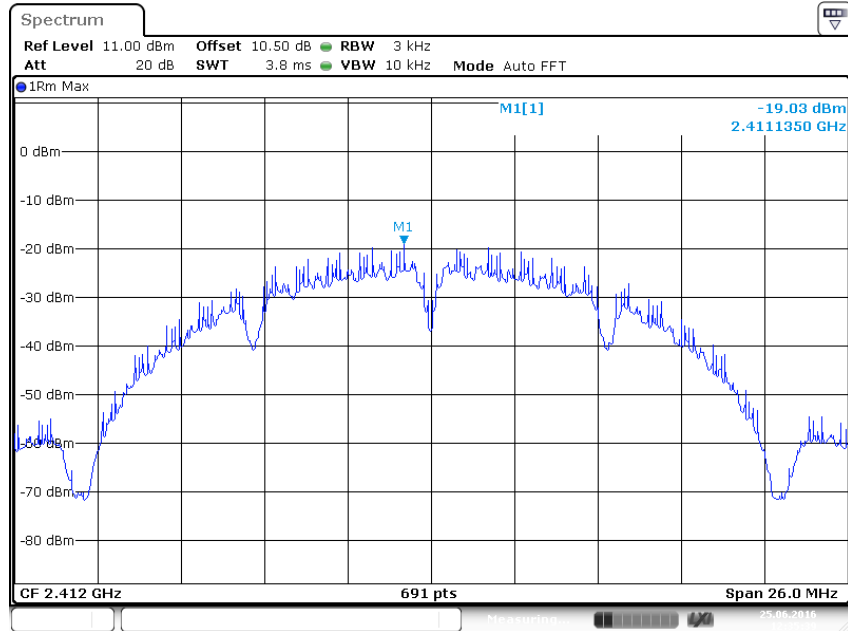

Date: 25.JUN.2016 12:35:40

### 802.11b Channel Middle 2437MHz

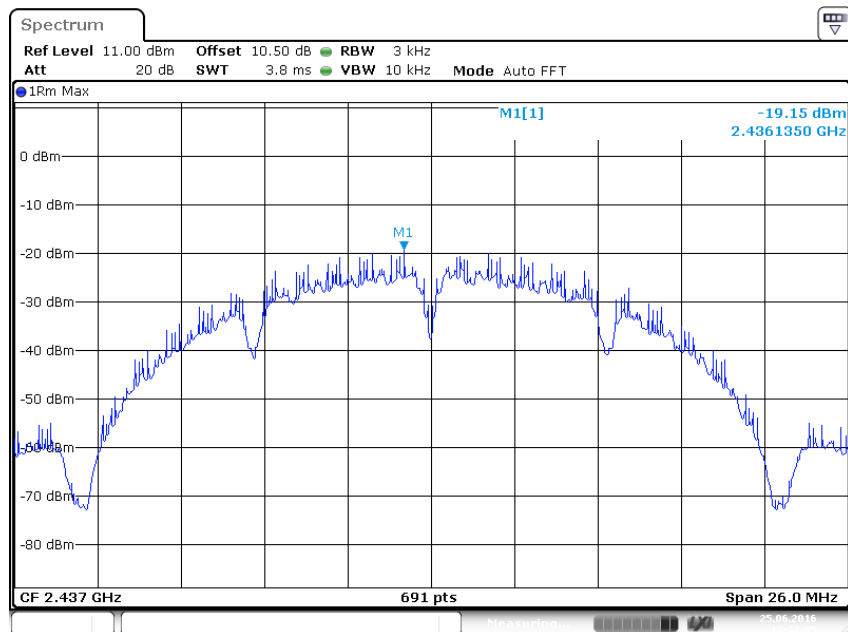

Date: 25.JUN.2016 12:37:05

### 802.11b Channel High 2462MHz

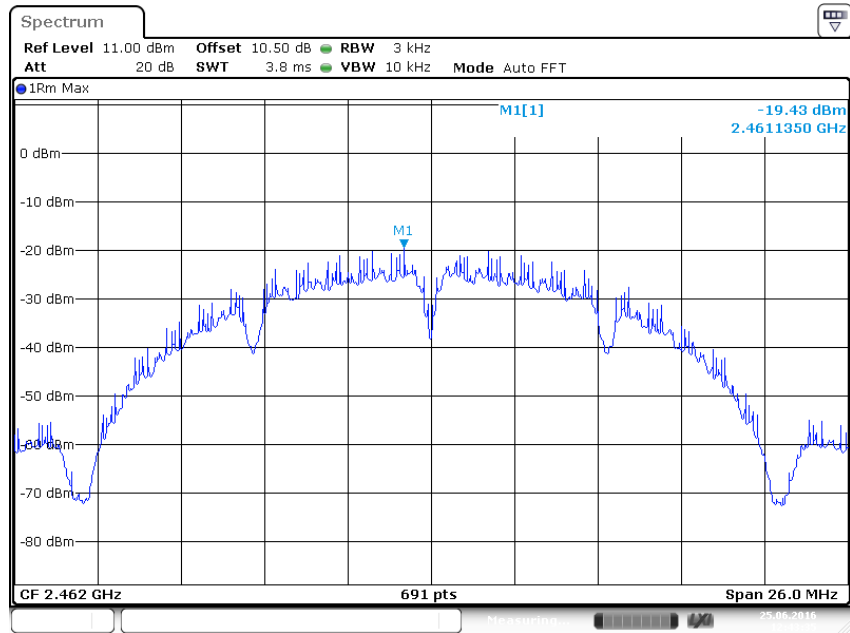

Date: 25.JUN.2016 12:43:36

### 802.11g Channel Low 2412MHz

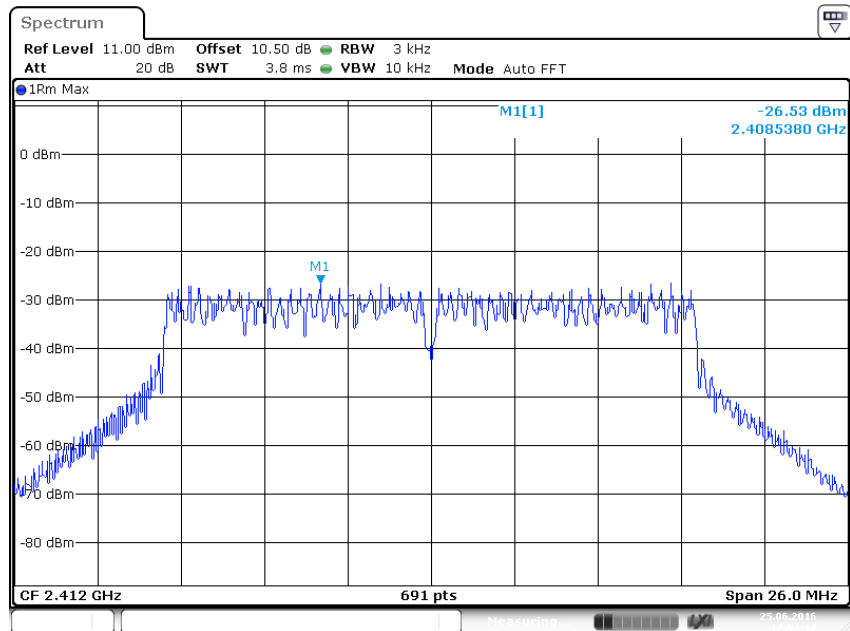

Date: 25.JUN.2016 12:52:17

### 802.11g Channel Middle 2437MHz

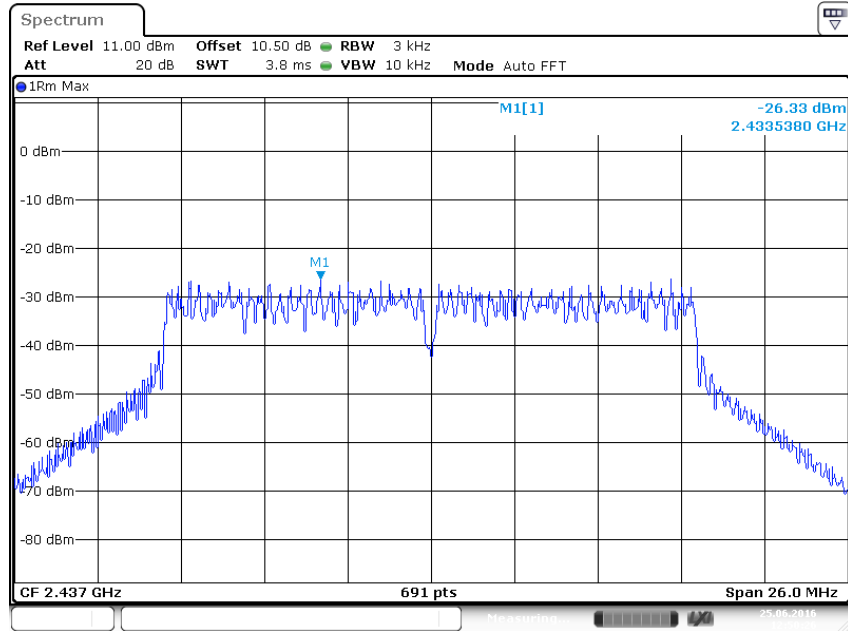

Date: 25.JUN.2016 12:50:26

### 802.11g Channel High 2462MHz

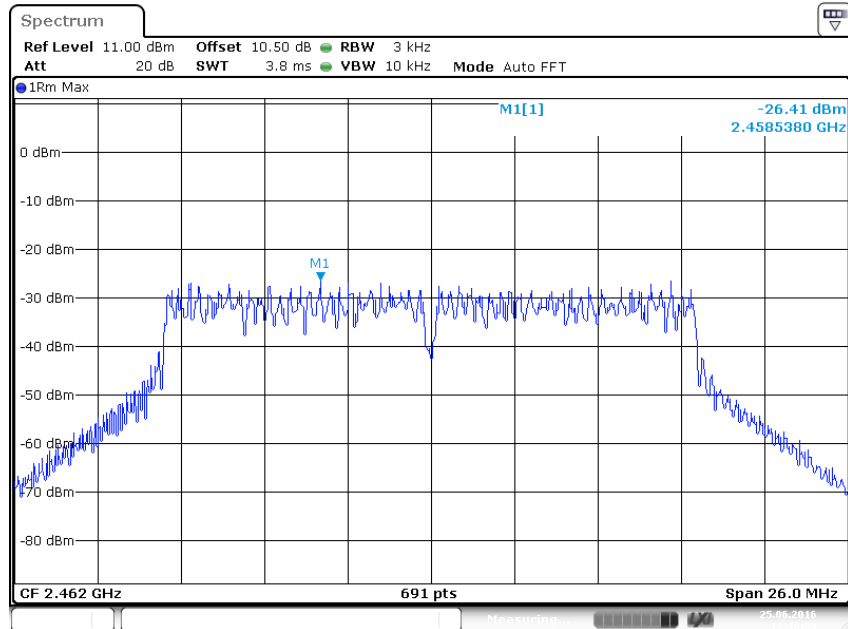

Date: 25.JUN.2016 12:46:59

### 802.11n Channel Low 2412MHz (20MHz)

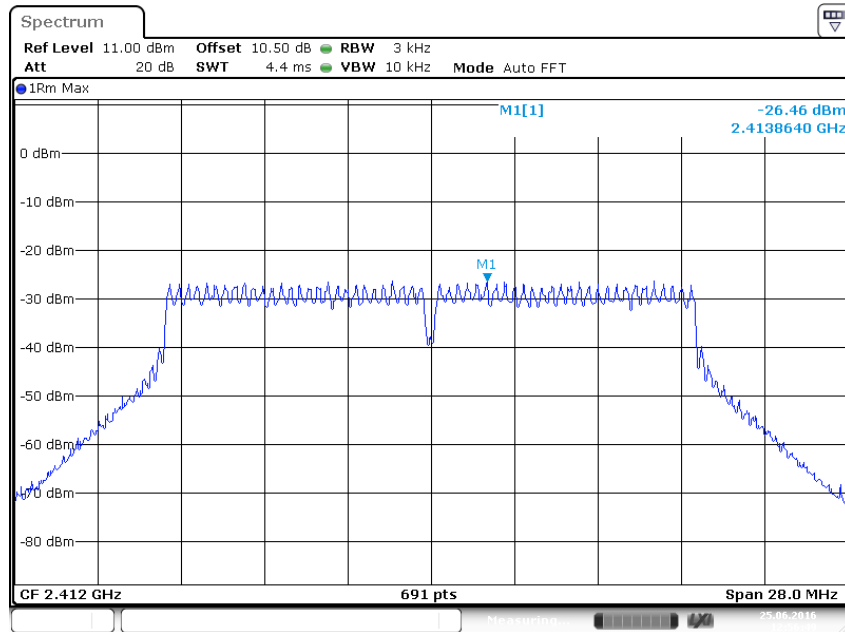

Date: 25.JUN.2016 12:56:49

### 802.11n Channel Middle 2437MHz (20MHz)

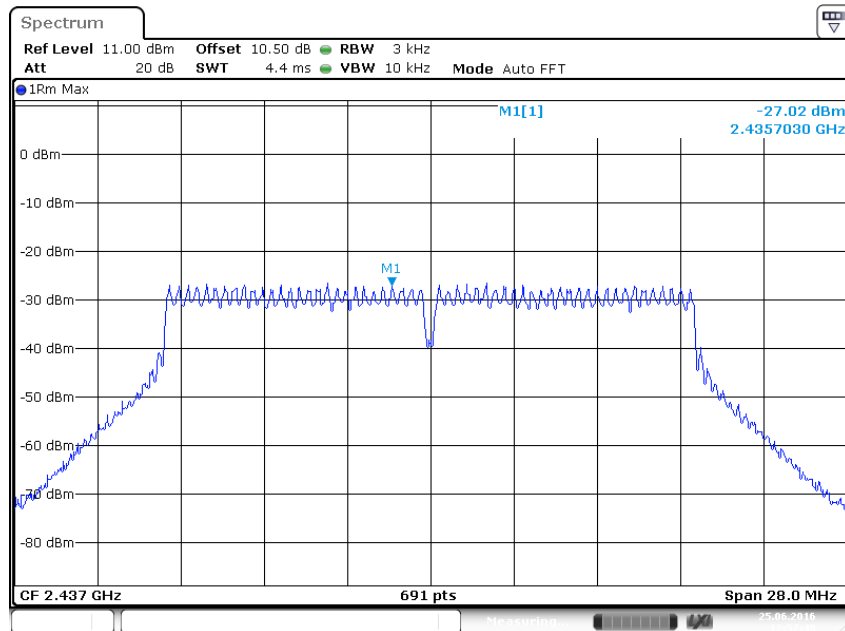

Date: 25.JUN.2016 12:57:49

### 802.11n Channel High 2462MHz(20MHz)

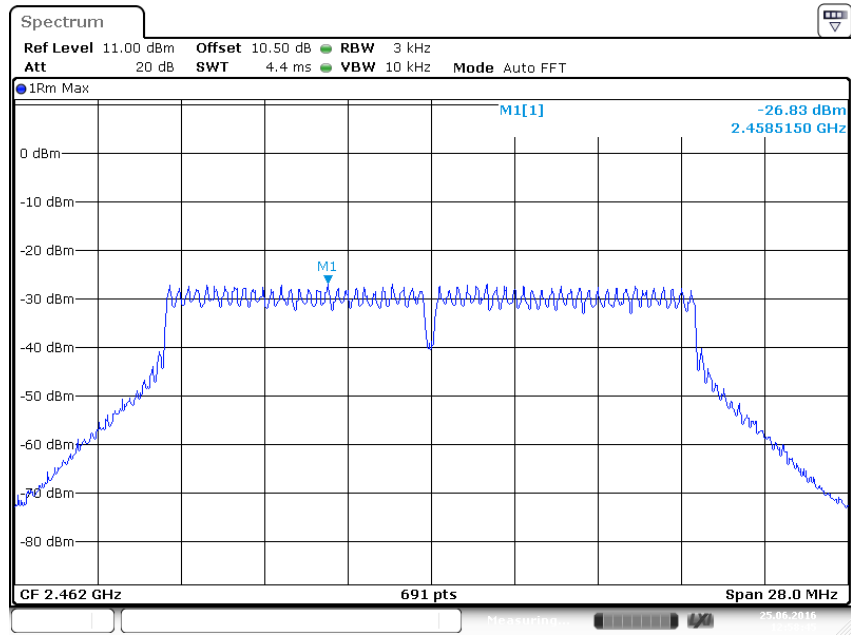

Date: 25.JUN.2016 12:58:45

### 802.11n Channel Low 2422MHz (40MHz)

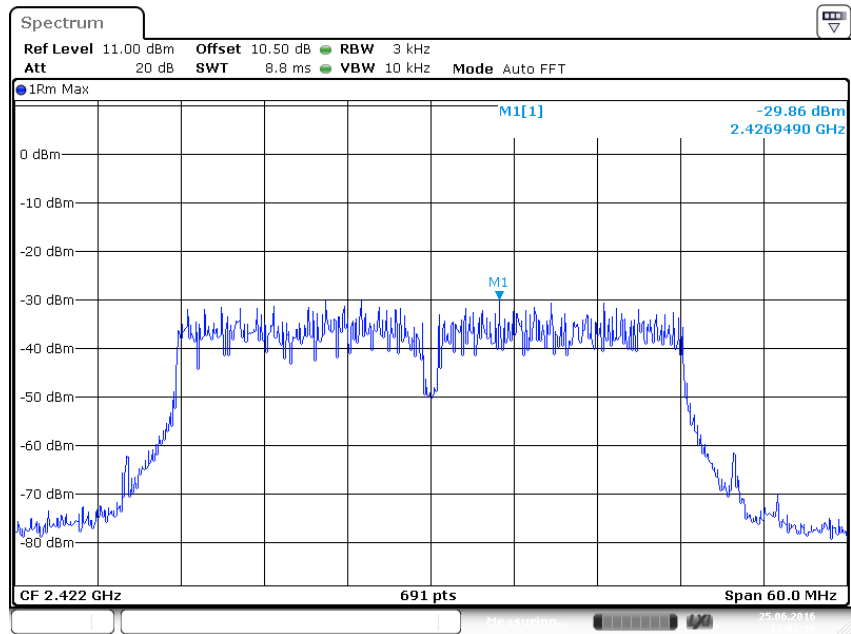

Date: 25.JUN.2016 13:02:16

### 802.11n Channel Middle 2437MHz(40MHz)

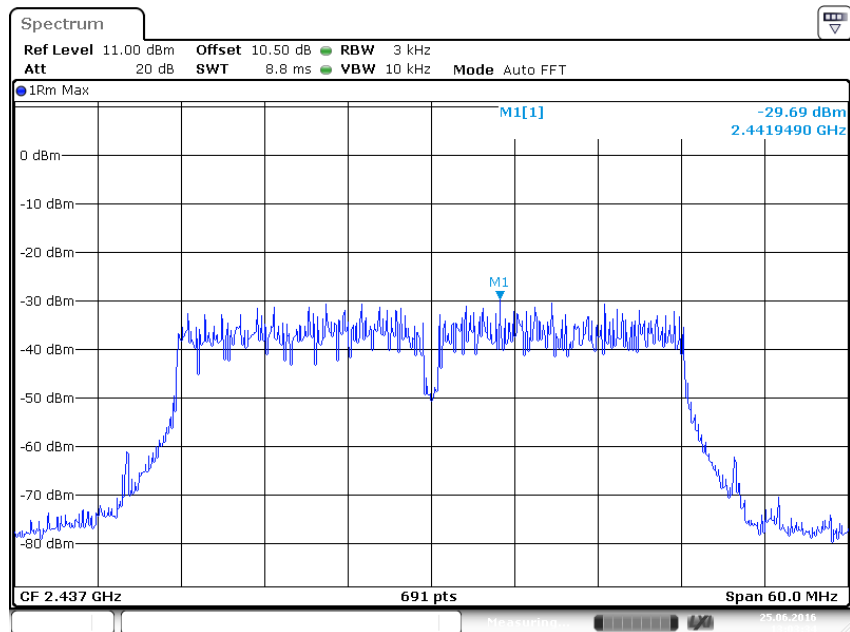

Date: 25.JUN.2016 13:03:34

### 802.11n Channel High 2452MHz(40MHz)

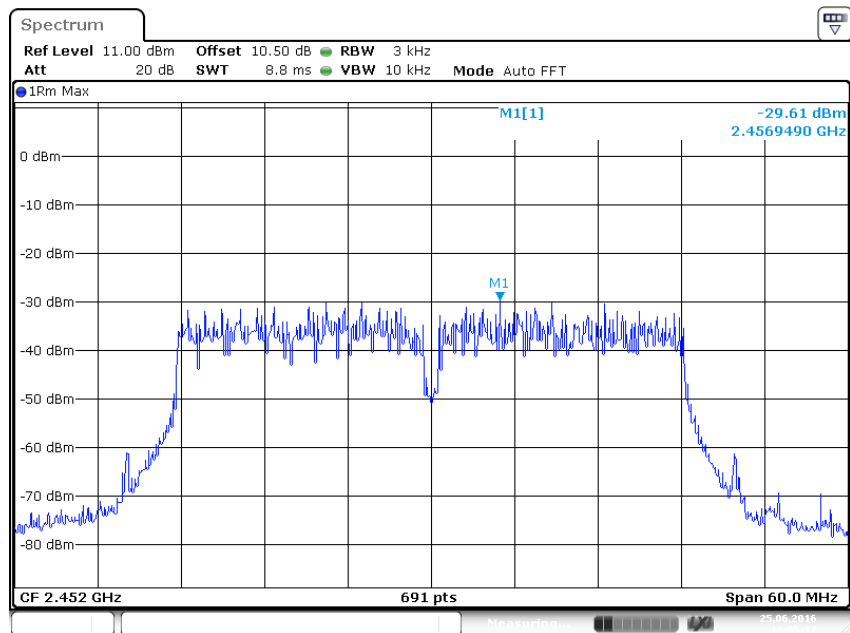

Date: 25.JUN.2016 13:05:17



## 9. BAND EDGE COMPLIANCE TEST

### 9.1. Block Diagram of Test Setup

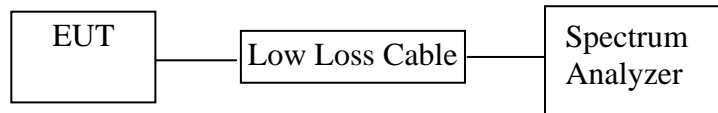

### 9.2. The Requirement For Section 15.247(d)

Section 15.247(d): In any 100 kHz bandwidth outside the frequency band in which the spread spectrum or digitally modulated intentional radiator is operating, the radio frequency power that is produced by the intentional radiator shall be at least 20 dB below that in the 100 kHz bandwidth within the band that contains the highest level of the desired power, based on either an RF conducted or a radiated measurement, provided the transmitter demonstrates compliance with the peak conducted power limits. If the transmitter complies with the conducted power limits based on the use of RMS averaging over a time interval, as permitted under paragraph (b)(3) of this section, the attenuation required under this paragraph shall be 30 dB instead of 20 dB. Attenuation below the general limits specified in Section 15.209(a) is not required. In addition, radiated emissions which fall in the restricted bands, as defined in Section 15.205(a), must also comply with the radiated emission limits specified in Section 15.209(a).

### 9.3. EUT Configuration on Measurement

The equipment are installed on the emission Measurement to meet the commission requirements and operating regulations in a manner which tends to maximize its emission characteristics in normal application.

### 9.4. Operating Condition of EUT

9.4.1. Setup the EUT and simulator as shown as Section 9.1.

9.4.2. Turn on the power of all equipment.

9.4.3. Let the EUT work in TX modes measure it. The transmit frequency are 2412-2462 and 2422-2452MHz MHz. We select 2412MHz, 2462MHz and 2422MHz, 2452MHz TX frequency to transmit.

### 9.5. Test Procedure

Conducted Band Edge:

9.5.1. The transmitter output was connected to the spectrum analyzer via a low loss

cable.

9.5.2. Set RBW of spectrum analyzer to 100kHz and VBW to 300kHz.

Radiate Band Edge:

9.5.3. The EUT is placed on a turntable, which is 0.8m above the ground plane and worked at highest radiated power.

9.5.4. The turntable was rotated for 360 degrees to determine the position of maximum emission level.

9.5.5. EUT is set 3m away from the receiving antenna, which is varied from 1m to 4m to find out the highest emission.

9.5.6. Set the spectrum analyzer in the following setting in order to capture the lower and upper band-edges of the emission:

9.5.7. RBW=1MHz, VBW=1MHz

9.5.8. The band edges was measured and recorded.

## 9.6. Test Result

The test was performed with 802.11b		
Frequency (MHz)	Result of Band Edge (dBc)	Limit of Band Edge (dBc)
2412	43.14	> 20dBc
2462	50.33	> 20dBc

The test was performed with 802.11g		
Frequency (MHz)	Result of Band Edge (dBc)	Limit of Band Edge (dBc)
2412	30.08	> 20dBc
2462	45.56	> 20dBc

The test was performed with 802.11n (20MHz)		
Frequency (MHz)	Result of Band Edge (dBc)	Limit of Band Edge (dBc)
2412	31.26	> 20dBc
2462	44.10	> 20dBc

The test was performed with 802.11n (40MHz)		
Frequency (MHz)	Result of Band Edge (dBc)	Limit of Band Edge (dBc)
2422	34.51	> 20dBc
2452	29.77	> 20dBc

### 802.11b Channel Low 2412MHz

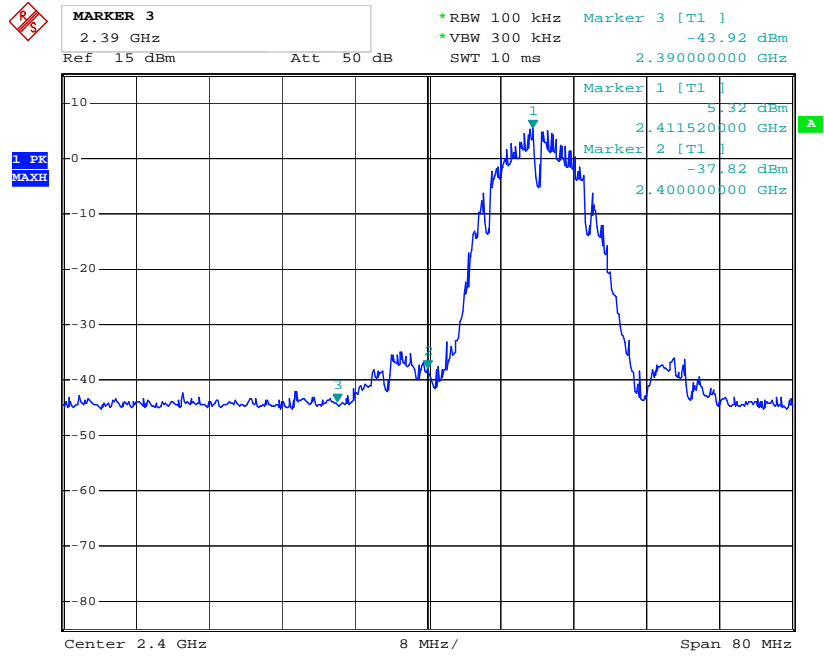

### 802.11b Channel High 2462MHz

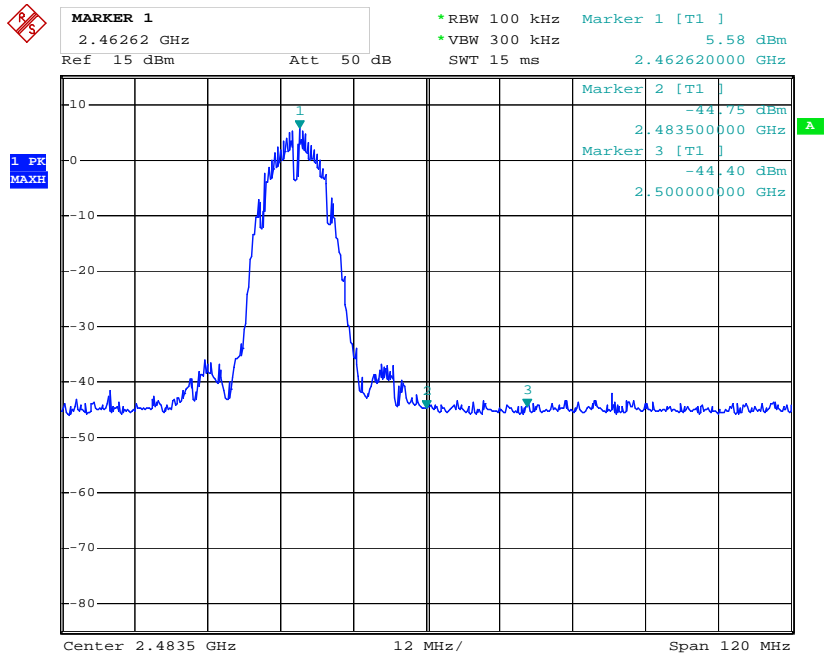

### 802.11g Channel Low 2412MHz

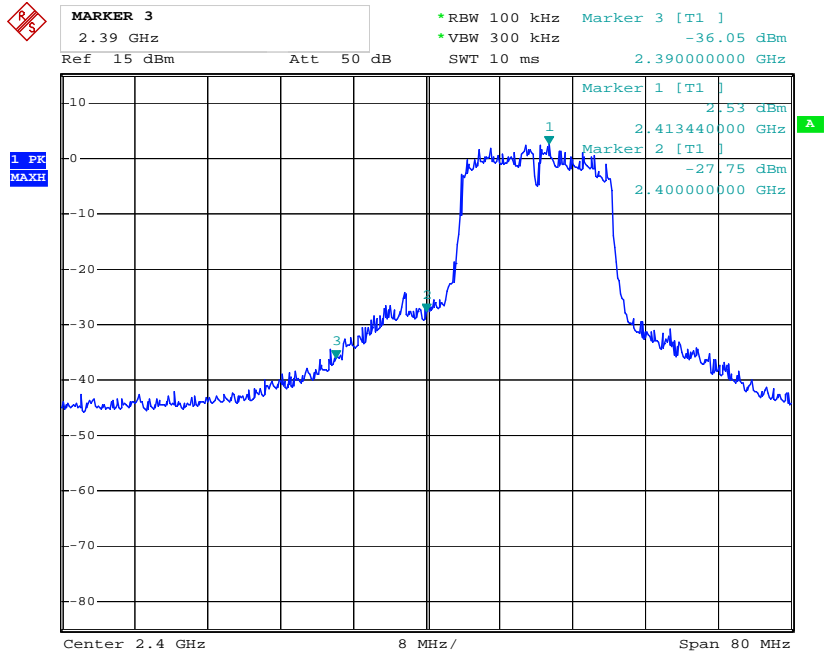

### 802.11g Channel High 2462MHz

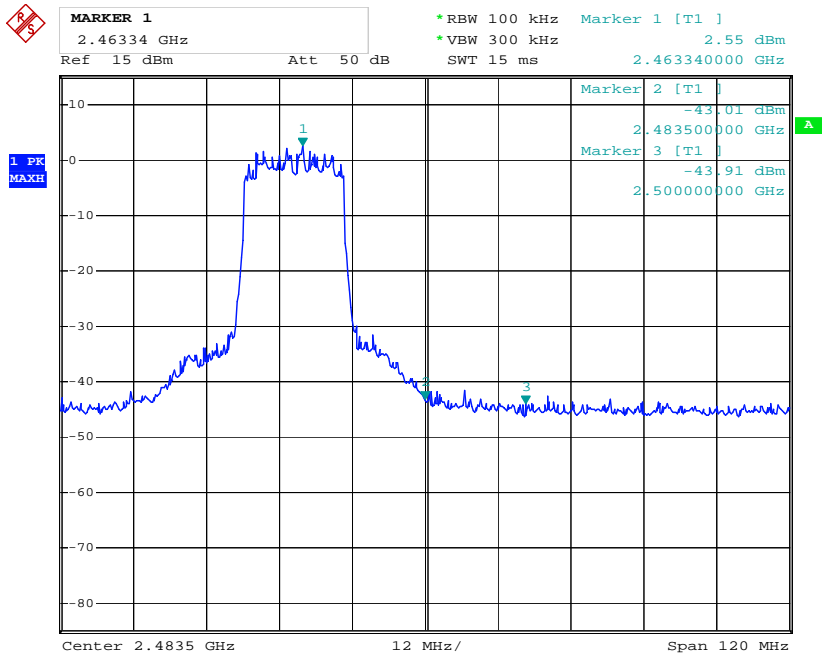

### 802.11n Channel Low 2412MHz (20MHz)

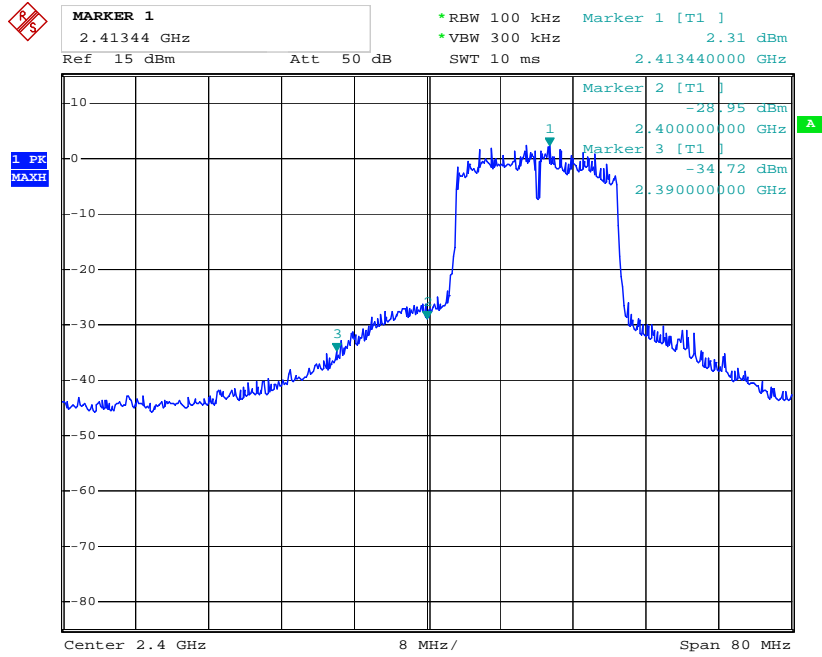

### 802.11n Channel High 2462MHz (20MHz)

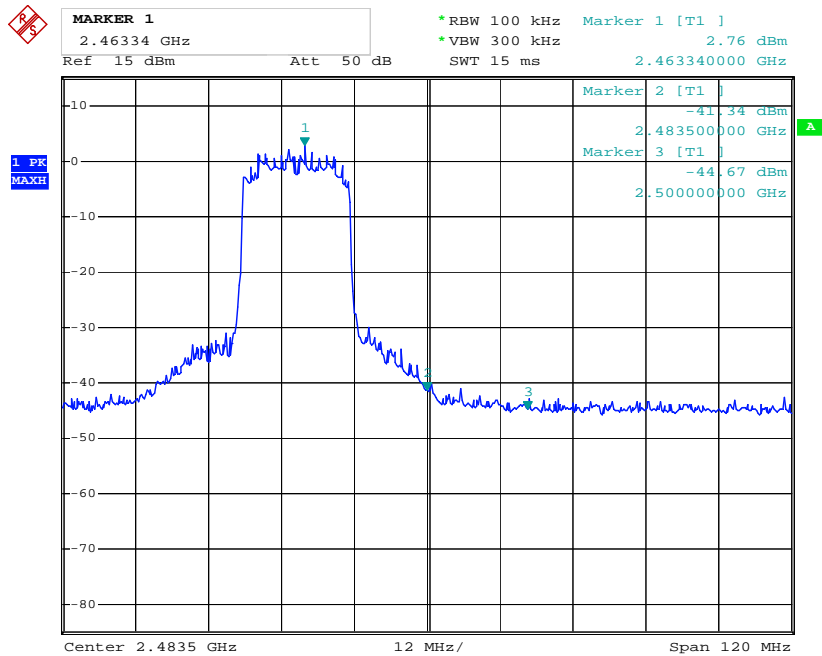

### 802.11n Channel Low 2422MHz (40MHz)

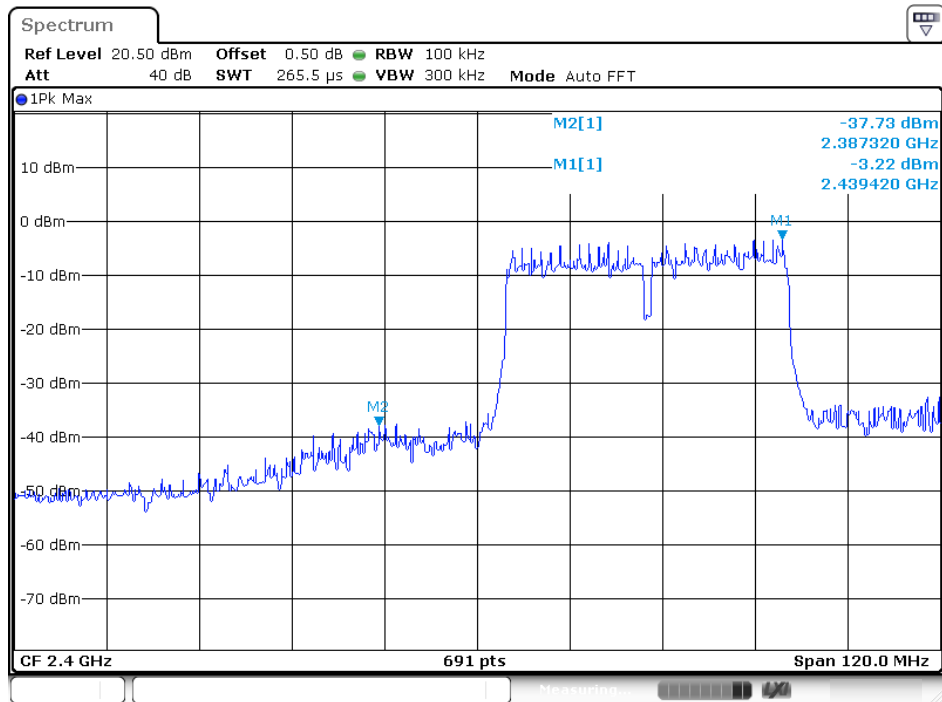

### 802.11n Channel High 2452MHz (40MHz)

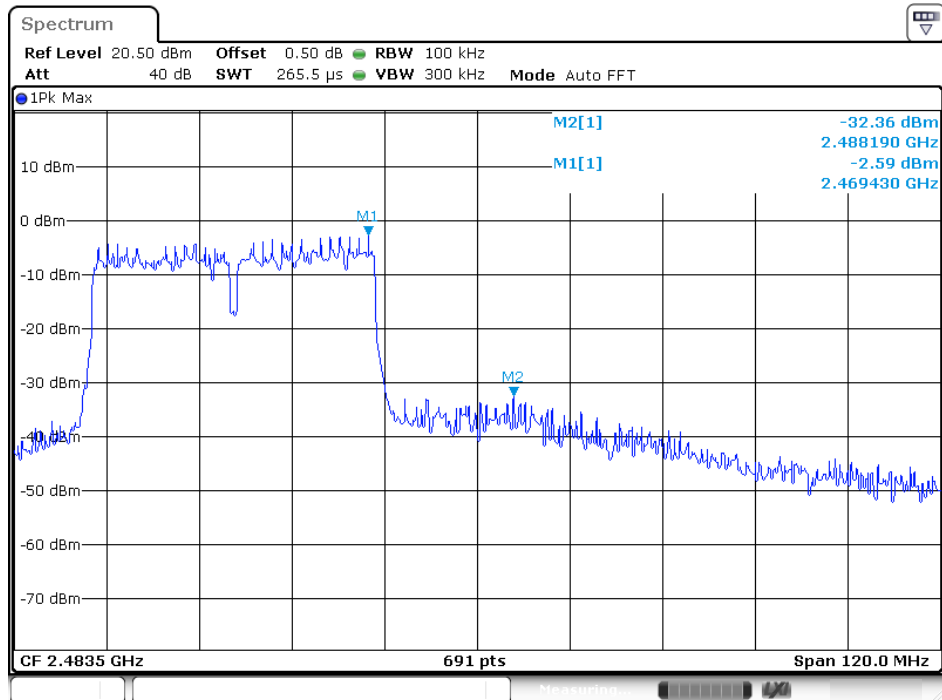

## Radiated Band Edge Result

Note:

1. Emissions attenuated more than 20 dB below the permissible value are not reported.
2. The field strength is calculated by adding the antenna factor, high pass filter loss(if used) and cable loss, and subtracting the amplifier gain(if any)from the measured reading. The basic equation calculation is as follows:  
$$\text{Result} = \text{Reading} + \text{Corrected Factor}$$
3. Display the measurement of peak values.

Test Procedure:

The EUT and its simulators are placed on a turntable, which is 1.5 meter high above ground(Above 1GHz). The turntable can rotate 360 degrees to determine the position of the maximum emission level. EUT is set 3.0 meters away from the receiving antenna, which is mounted on an antenna tower. The antenna can be moved up and down between 1.0 meter and 4 meters to find out the maximum emission level. Broadband antenna (calibrated bi-log antenna) is used as receiving antenna. Both horizontal and vertical polarizations of the antenna are set on measurement. In order to find the maximum emission levels, all of the EUT location must be manipulated according to ANSI C63.10:2013 on radiated emission measurement. The EUT was tested in 3 orthogonal planes.

Let the EUT work in TX modes then measure it.

We select 2412MHz, 2462MHz TX frequency to transmit(802.11b/g/n20 mode).

We select 2422MHz, 2452MHz TX frequency to transmit(802.11n40 mode).

During the radiated emission test, the spectrum analyzer was set with the following configurations:

- 1.The resolution bandwidth of test receiver/spectrum analyzer is 1MHz and video bandwidth is 3MHz for peak measurement with peak detector at frequency above 1GHz.
- 2.The resolution bandwidth of test receiver/spectrum analyzer is 1MHz and video bandwidth is 10Hz for Average measurement with peak detection at frequency above 1GHz.
- 3.All modes of operation were investigated and the worst-case emissions are reported.

Job No.: STAR2016 #2155

Standard: FCC PK

Test item: Radiation Test

Temp.( C)/Hum.(%) 25 C / 55 %

EUT: Media box

Mode: TX Channel 1(802.11b)

Model: X9

Manufacturer: PIPO TECHNOLOGY CO., LTD

Polarization: Horizontal

Power Source: AC 120V/60Hz

Date: 16/06/16/

Time: 10/41/44

Engineer Signature:

Distance: 3m

Note: Report No.:ATE20161167

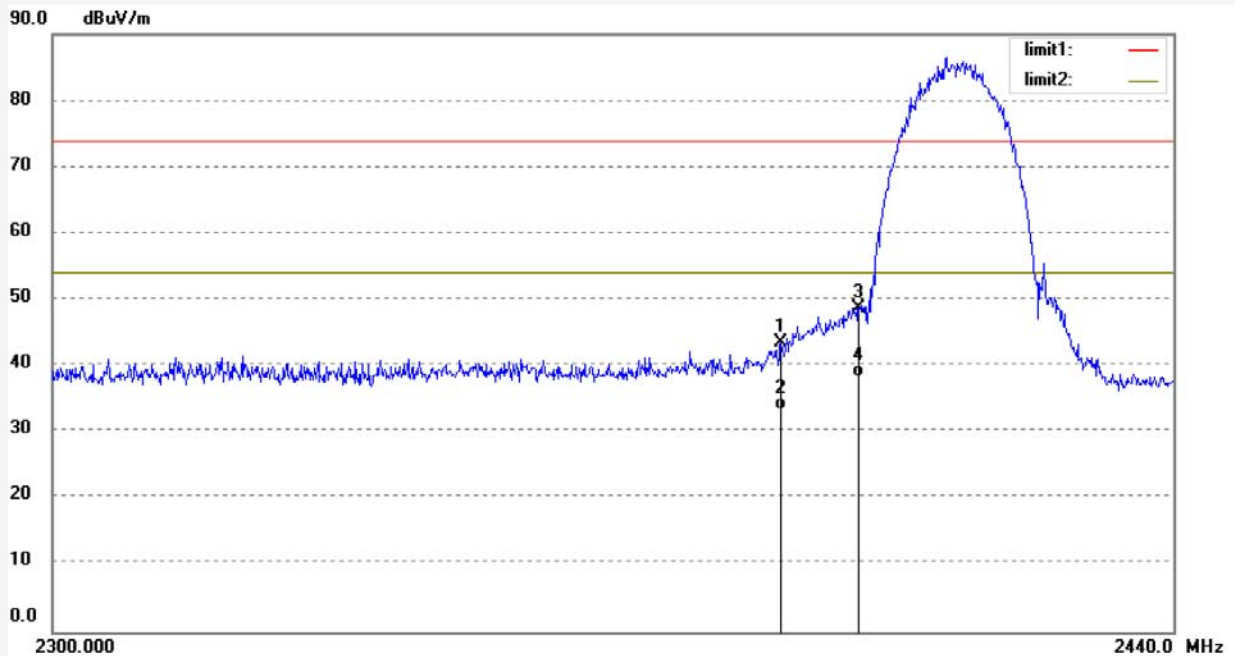

No.	Freq. (MHz)	Reading (dBuV/m)	Factor (dB)	Result (dBuV/m)	Limit (dBuV/m)	Margin (dB)	Detector	Height (cm)	Degree (deg.)	Remark
1	2390.000	49.93	-6.31	43.62	74.00	-30.38	peak			
2	2390.000	39.70	-6.31	33.39	54.00	-20.61	AVG			
3	2400.000	54.89	-6.28	48.61	74.00	-25.39	peak			
4	2400.000	44.58	-6.28	38.30	54.00	-15.70	AVG			

Note: Average measurement with peak detection at No.2&4



Job No.: STAR2016 #2156  
Standard: FCC PK  
Test item: Radiation Test  
Temp.( C)/Hum.(%) 25 C / 55 %  
EUT: Media box  
Mode: TX Channel 1(802.11b)  
Model: X9  
Manufacturer: PIPO TECHNOLOGY CO., LTD

Polarization: Vertical  
Power Source: AC 120V/60Hz  
Date: 16/06/16/  
Time: 10/44/33  
Engineer Signature:  
Distance: 3m

Note: Report No.:ATE20161167

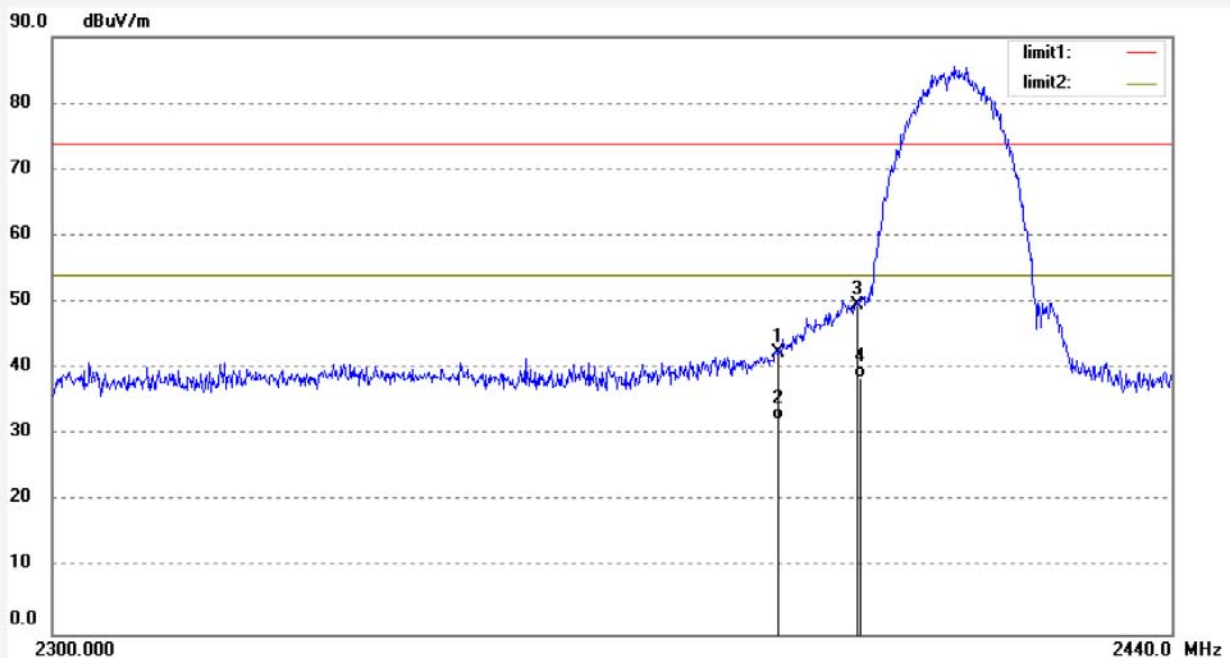

No.	Freq. (MHz)	Reading (dBuV/m)	Factor (dB)	Result (dBuV/m)	Limit (dBuV/m)	Margin (dB)	Detector	Height (cm)	Degree (deg.)	Remark
1	2390.000	48.83	-6.31	42.52	74.00	-31.48	peak			
2	2390.000	38.61	-6.31	32.30	54.00	-21.70	AVG			
3	2400.000	55.90	-6.28	49.62	74.00	-24.38	peak			
4	2400.000	44.86	-6.28	38.58	54.00	-15.42	AVG			

Note: Average measurement with peak detection at No.2&4

Job No.: STAR2016 #2158	Polarization: Horizontal
Standard: FCC PK	Power Source: AC 120V/60Hz
Test item: Radiation Test	Date: 16/06/16/
Temp.( C)/Hum.(%) 25 C / 55 %	Time: 10/53/38
EUT: Media box	Engineer Signature:
Mode: TX Channel 11(802.11b)	Distance: 3m
Model: X9	
Manufacturer: PIPO TECHNOLOGY CO., LTD	

Note: Report No.:ATE20161167

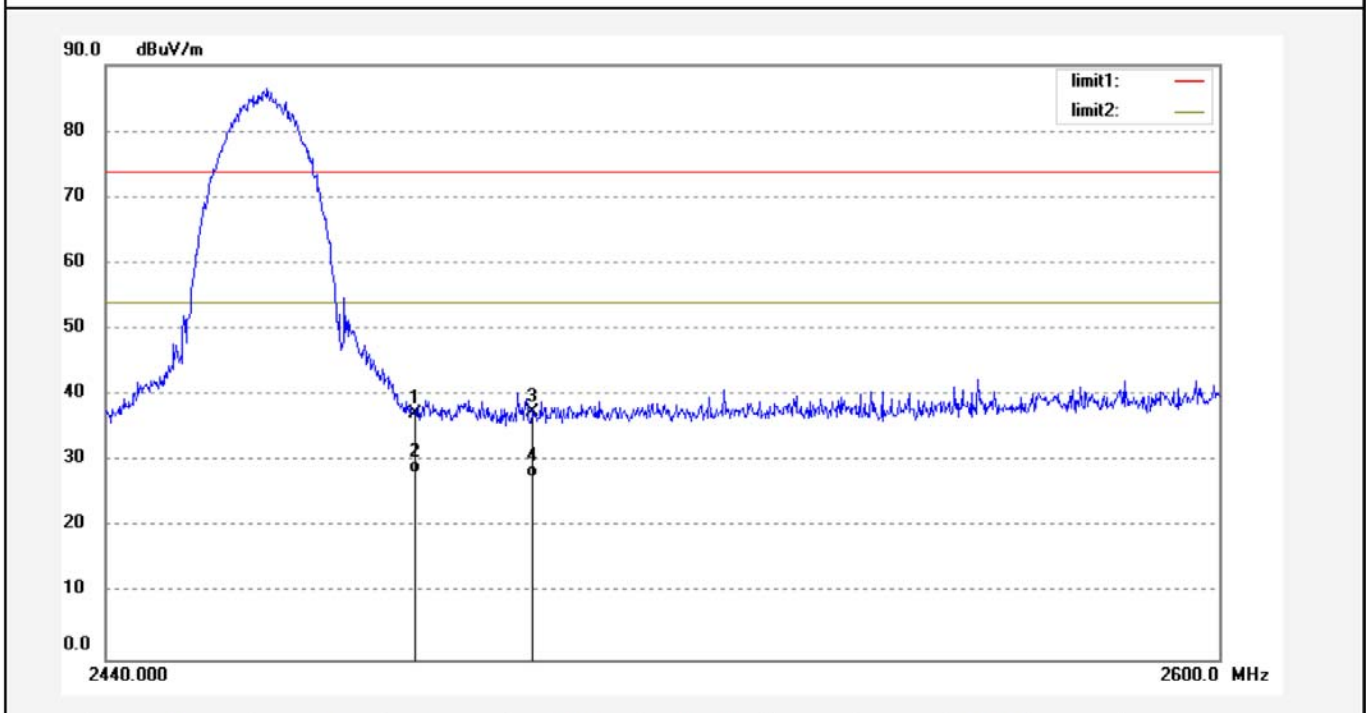

No.	Freq. (MHz)	Reading (dBuV/m)	Factor (dB)	Result (dBuV/m)	Limit (dBuV/m)	Margin (dB)	Detector	Height (cm)	Degree (deg.)	Remark
1	2483.500	43.34	-6.04	37.30	74.00	-36.70	peak			
2	2483.500	34.25	-6.04	28.21	54.00	-25.79	AVG			
3	2500.000	43.53	-6.00	37.53	74.00	-36.47	peak			
4	2500.000	33.67	-6.00	27.67	54.00	-26.33	AVG			

Note: Average measurement with peak detection at No.2&4

Job No.: STAR2016 #2157

Standard: FCC PK

Test item: Radiation Test

Temp.( C)/Hum.(%) 25 C / 55 %

EUT: Media box

Mode: TX Channel 11(802.11b)

Model: X9

Manufacturer: PIPO TECHNOLOGY CO., LTD

Polarization: Vertical

Power Source: AC 120V/60Hz

Date: 16/06/16/

Time: 10/49/32

Engineer Signature:

Distance: 3m

Note: Report No.:ATE20161167

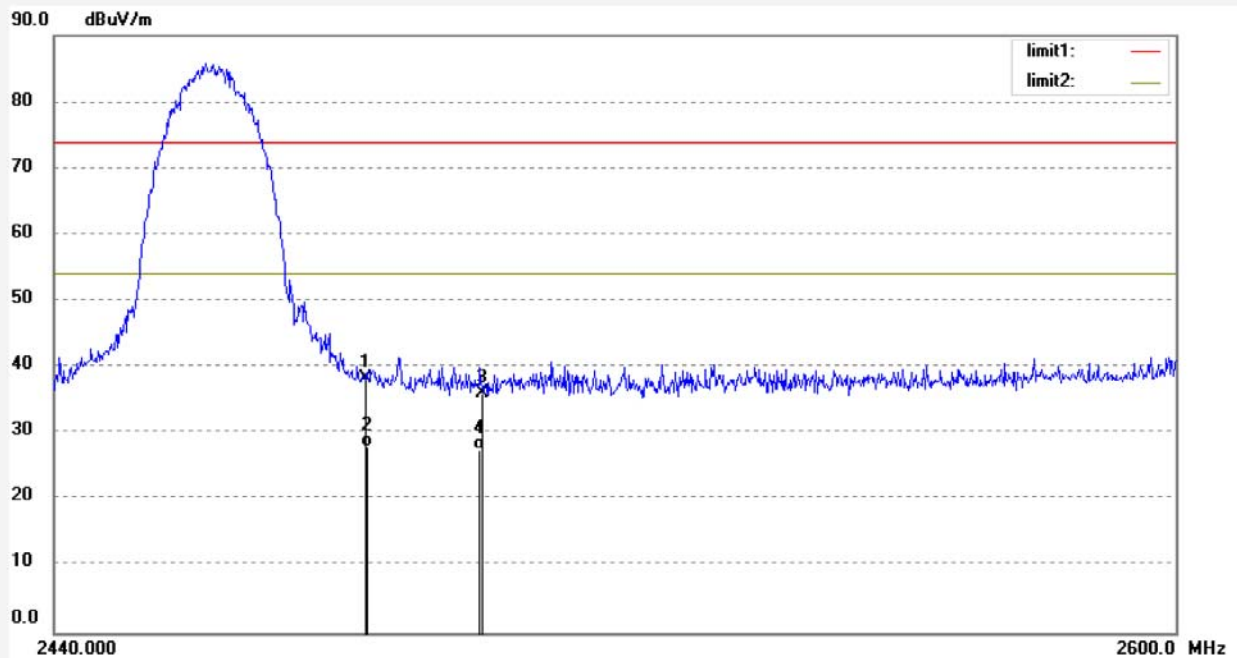

No.	Freq. (MHz)	Reading (dBuV/m)	Factor (dB)	Result (dBuV/m)	Limit (dBuV/m)	Margin (dB)	Detector	Height (cm)	Degree (deg.)	Remark
1	2483.500	44.39	-6.04	38.35	74.00	-35.65	peak			
2	2483.500	34.14	-6.04	28.10	54.00	-25.90	AVG			
3	2500.000	42.04	-6.00	36.04	74.00	-37.96	peak			
4	2500.000	33.67	-6.00	27.67	54.00	-26.33	AVG			

Note: Average measurement with peak detection at No.2&4

Job No.: STAR2016 #2162

Standard: FCC PK

Test item: Radiation Test

Temp.( C)/Hum.(%) 25 C / 55 %

EUT: Media box

Mode: TX Channel 1(802.11g)

Model: X9

Manufacturer: PIPO TECHNOLOGY CO., LTD

Polarization: Horizontal

Power Source: AC 120V/60Hz

Date: 16/06/16/

Time: 11/20/29

Engineer Signature:

Distance: 3m

Note: Report No.:ATE20161167

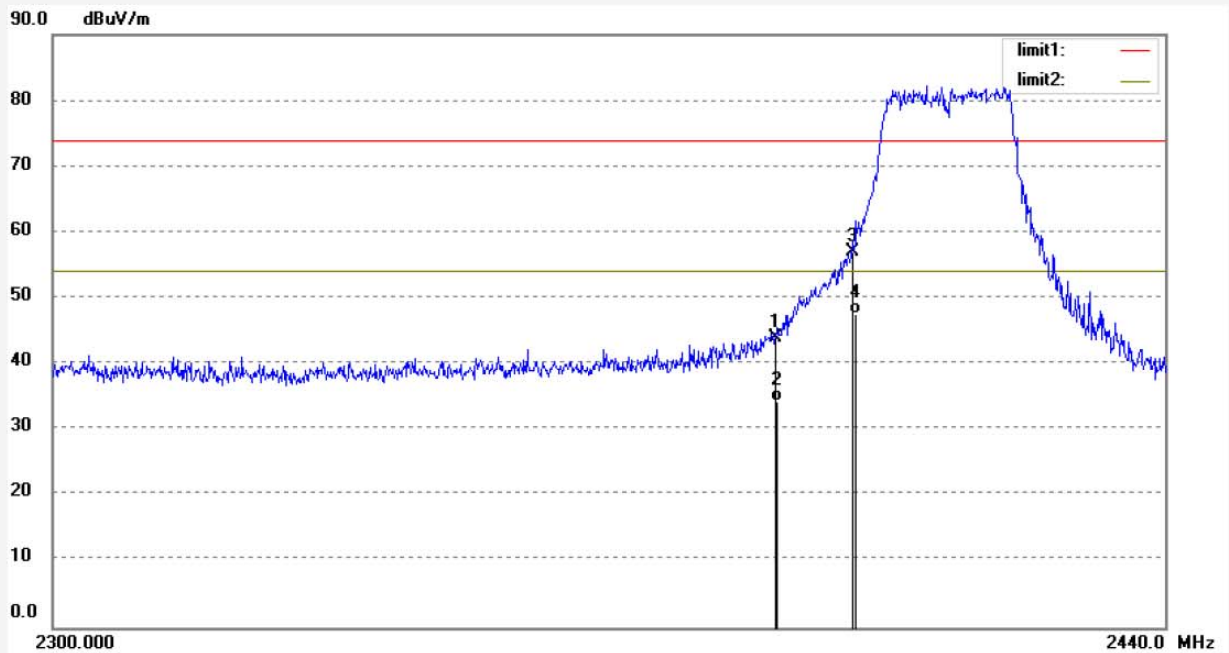

No.	Freq. (MHz)	Reading (dBuV/m)	Factor (dB)	Result (dBuV/m)	Limit (dBuV/m)	Margin (dB)	Detector	Height (cm)	Degree (deg.)	Remark
1	2390.000	50.25	-6.31	43.94	74.00	-30.06	peak			
2	2390.000	40.52	-6.31	34.21	54.00	-19.79	AVG			
3	2400.000	63.34	-6.28	57.06	74.00	-16.94	peak			
4	2400.000	53.83	-6.28	47.55	54.00	-6.45	AVG			

Note: Average measurement with peak detection at No.2&4

Job No.: STAR2016 #2161	Polarization: Vertical
Standard: FCC PK	Power Source: AC 120V/60Hz
Test item: Radiation Test	Date: 16/06/16/
Temp.( C)/Hum.(%) 25 C / 55 %	Time: 11/16/11
EUT: Media box	Engineer Signature:
Mode: TX Channel 1(802.11g)	Distance: 3m
Model: X9	
Manufacturer: PIPO TECHNOLOGY CO., LTD	

Note: Report No.:ATE20161167

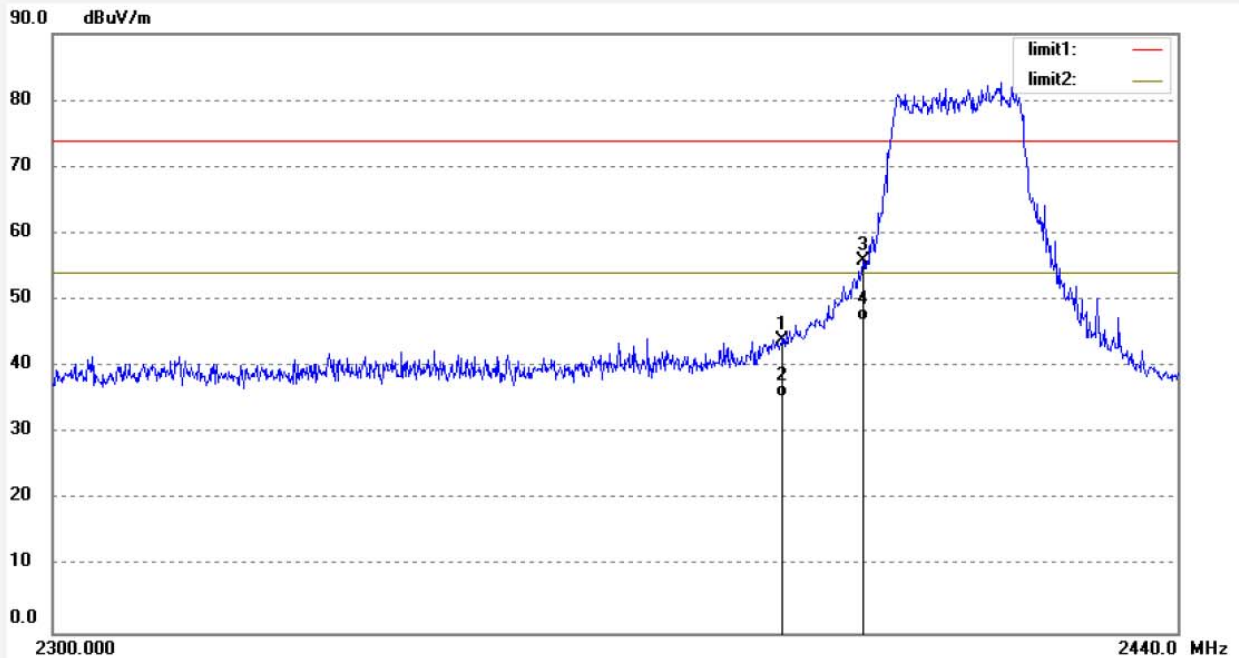

No.	Freq. (MHz)	Reading (dBuV/m)	Factor (dB)	Result (dBuV/m)	Limit (dBuV/m)	Margin (dB)	Detector	Height (cm)	Degree (deg.)	Remark
1	2390.000	50.22	-6.31	43.91	74.00	-30.09	peak			
2	2390.000	41.69	-6.31	35.38	54.00	-18.62	AVG			
3	2400.000	62.27	-6.28	55.99	74.00	-18.01	peak			
4	2400.000	53.30	-6.28	47.02	54.00	-6.98	AVG			

Note: Average measurement with peak detection at No.2&4

Job No.: STAR2016 #2159

Standard: FCC PK

Test item: Radiation Test

Temp.( C)/Hum.(%) 25 C / 55 %

EUT: Media box

Mode: TX Channel 11(802.11g)

Model: X9

Manufacturer: PIPO TECHNOLOGY CO., LTD

Polarization: Horizontal

Power Source: AC 120V/60Hz

Date: 16/06/16/

Time: 10/58/06

Engineer Signature:

Distance: 3m

Note: Report No.:ATE20161167

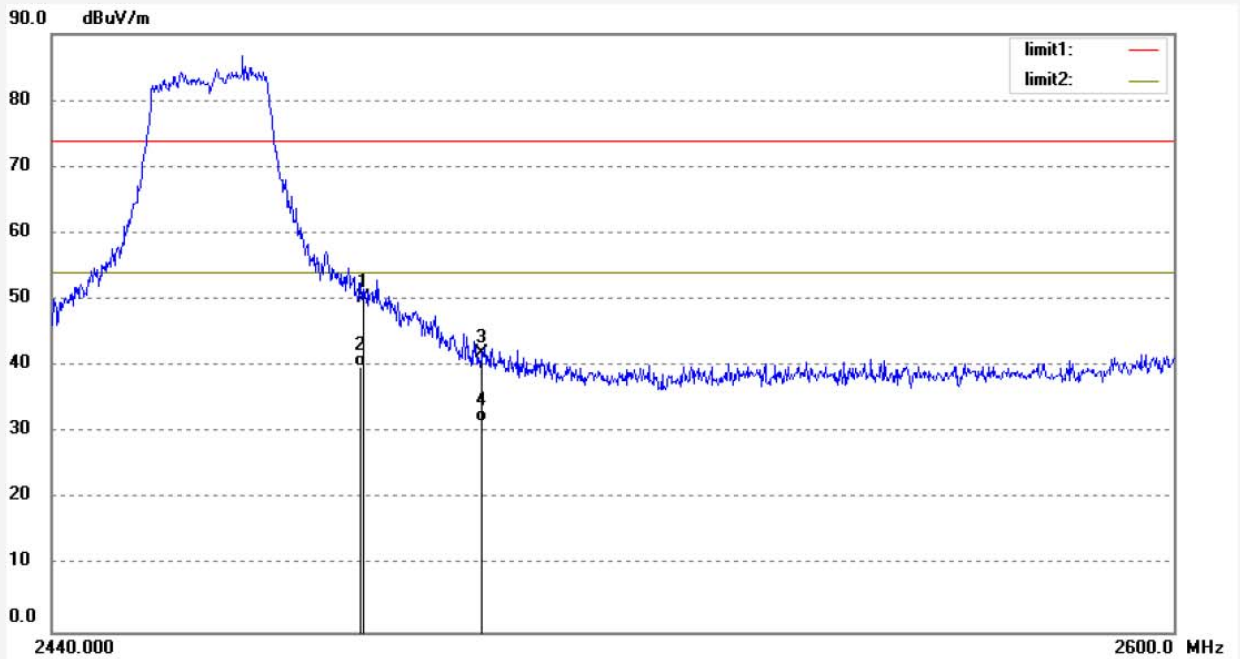

No.	Freq. (MHz)	Reading (dBuV/m)	Factor (dB)	Result (dBuV/m)	Limit (dBuV/m)	Margin (dB)	Detector	Height (cm)	Degree (deg.)	Remark
1	2483.500	56.32	-6.04	50.28	74.00	-23.72	peak			
2	2483.500	46.04	-6.04	40.00	54.00	-14.00	AVG			
3	2500.000	47.96	-6.00	41.96	74.00	-32.04	peak			
4	2500.000	37.51	-6.00	31.51	54.00	-22.49	AVG			

Note: Average measurement with peak detection at No.2&4

Job No.: STAR2016 #2160

Standard: FCC PK

Test item: Radiation Test

Temp.( C)/Hum.(%) 25 C / 55 %

EUT: Media box

Mode: TX Channel 11(802.11g)

Model: X9

Manufacturer: PIPO TECHNOLOGY CO., LTD

Polarization: Vertical

Power Source: AC 120V/60Hz

Date: 16/06/16/

Time: 11/12/47

Engineer Signature:

Distance: 3m

Note: Report No.:ATE20161167

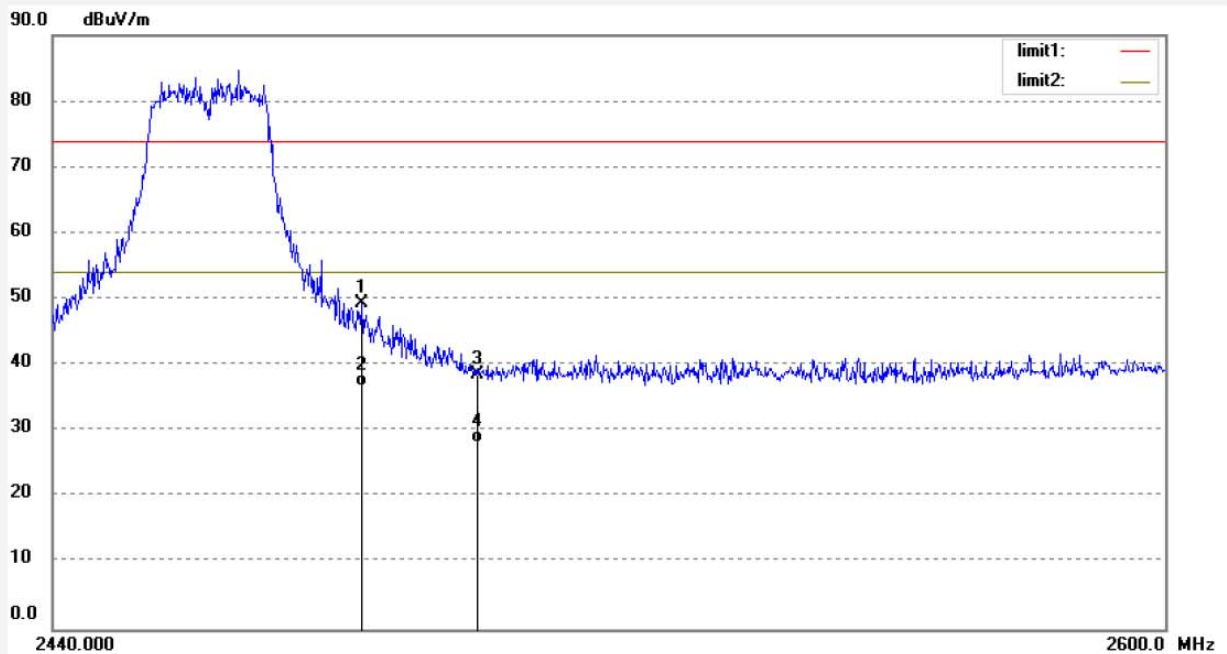

No.	Freq. (MHz)	Reading (dBuV/m)	Factor (dB)	Result (dBuV/m)	Limit (dBuV/m)	Margin (dB)	Detector	Height (cm)	Degree (deg.)	Remark
1	2483.500	55.49	-6.04	49.45	74.00	-24.55	peak			
2	2483.500	42.80	-6.04	36.76	54.00	-17.24	AVG			
3	2500.000	44.56	-6.00	38.56	74.00	-35.44	peak			
4	2500.000	34.26	-6.00	28.26	54.00	-25.74	AVG			

Note: Average measurement with peak detection at No.2&4

Job No.: STAR2016 #2163

Standard: FCC PK

Test item: Radiation Test

Temp.( C)/Hum.(%) 25 C / 55 %

EUT: Media box

Mode: TX Channel 1(802.11n20)

Model: X9

Manufacturer: PIPO TECHNOLOGY CO., LTD

Polarization: Horizontal

Power Source: AC 120V/60Hz

Date: 16/06/16/

Time: 11/24/33

Engineer Signature:

Distance: 3m

Note: Report No.:ATE20161167

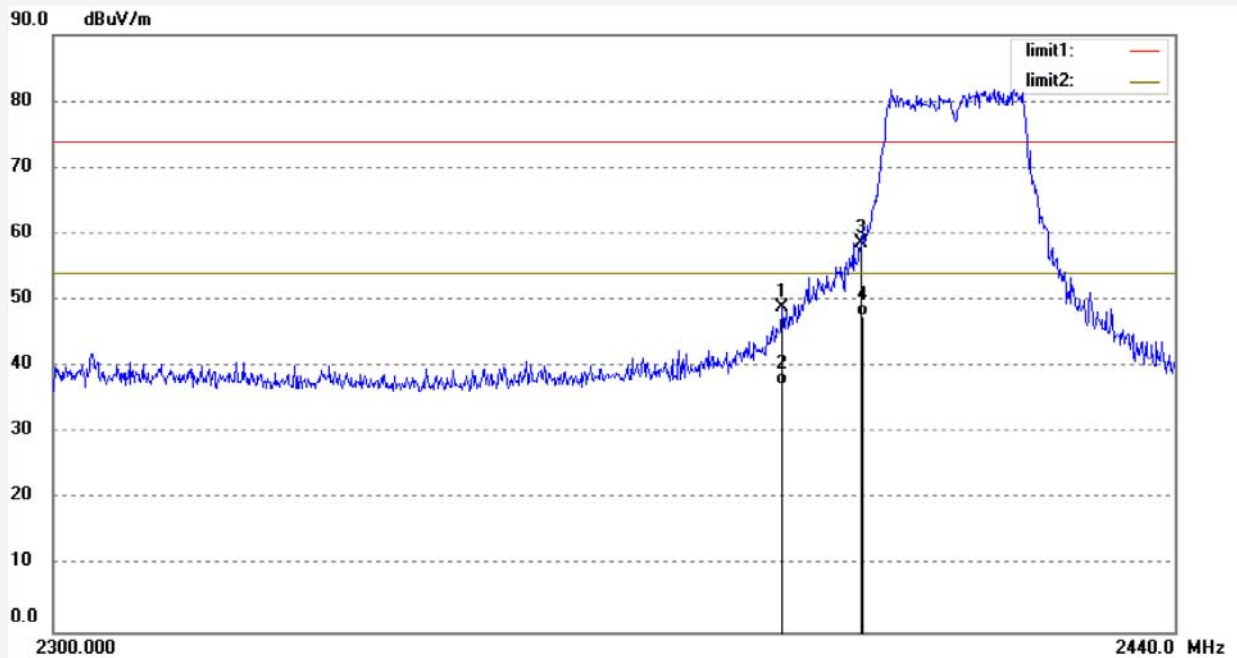

No.	Freq. (MHz)	Reading (dBuV/m)	Factor (dB)	Result (dBuV/m)	Limit (dBuV/m)	Margin (dB)	Detector	Height (cm)	Degree (deg.)	Remark
1	2390.000	55.22	-6.31	48.91	74.00	-25.09	peak			
2	2390.000	43.59	-6.31	37.28	54.00	-16.72	AVG			
3	2400.000	64.98	-6.28	58.70	74.00	-15.30	peak			
4	2400.000	53.89	-6.28	47.61	54.00	-6.39	AVG			

Note: Average measurement with peak detection at No.2&4



Job No.: STAR2016 #2164

Standard: FCC PK

Test item: Radiation Test

Temp.( C)/Hum.(%) 25 C / 55 %

EUT: Media box

Mode: TX Channel 1(802.11n20)

Model: X9

Manufacturer: PIPO TECHNOLOGY CO., LTD

Polarization: Vertical

Power Source: AC 120V/60Hz

Date: 16/06/16/

Time: 11/29/37

Engineer Signature:

Distance: 3m

Note: Report No.:ATE20161167

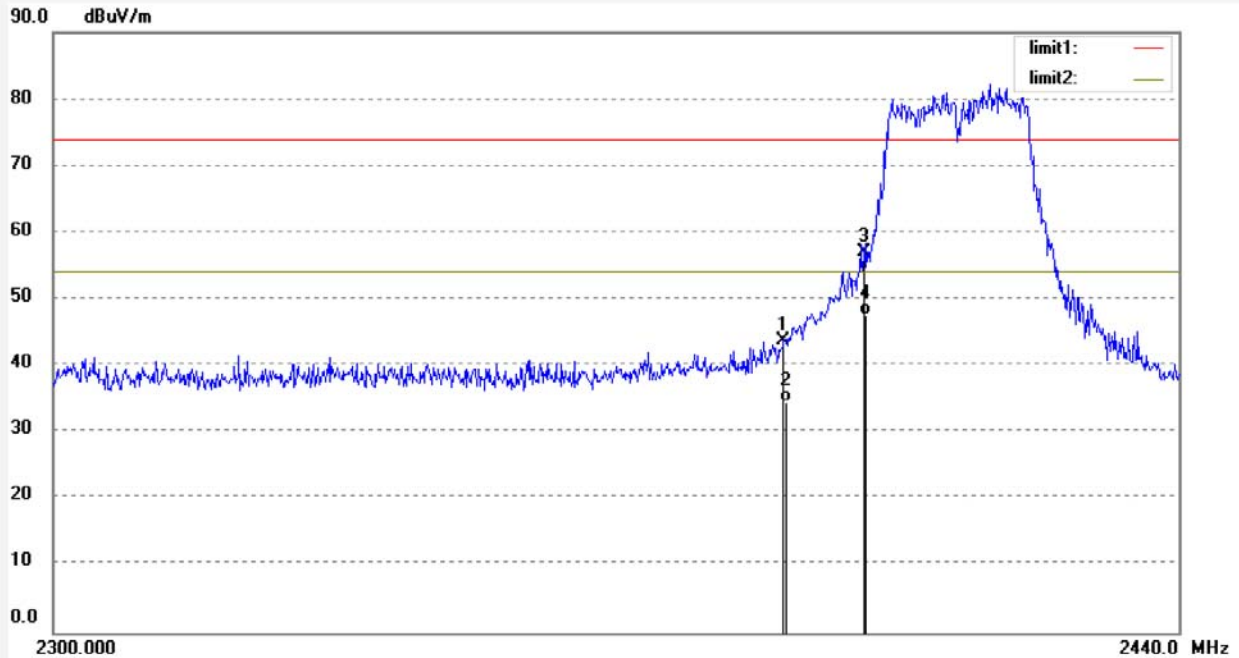

No.	Freq. (MHz)	Reading (dBuV/m)	Factor (dB)	Result (dBuV/m)	Limit (dBuV/m)	Margin (dB)	Detector	Height (cm)	Degree (deg.)	Remark
1	2390.000	50.07	-6.31	43.76	74.00	-30.24	peak			
2	2390.000	40.76	-6.31	34.45	54.00	-19.55	AVG			
3	2400.000	63.32	-6.28	57.04	74.00	-16.96	peak			
4	2400.000	53.88	-6.28	47.60	54.00	-6.40	AVG			

Note: Average measurement with peak detection at No.2&4

Job No.: STAR2016 #2166	Polarization: Horizontal
Standard: FCC PK	Power Source: AC 120V/60Hz
Test item: Radiation Test	Date: 16/06/16/
Temp.( C)/Hum.(%) 25 C / 55 %	Time: 11/38/18
EUT: Media box	Engineer Signature:
Mode: TX Channel 11(802.11n20)	Distance: 3m
Model: X9	
Manufacturer: PIPO TECHNOLOGY CO., LTD	

Note: Report No.:ATE20161167

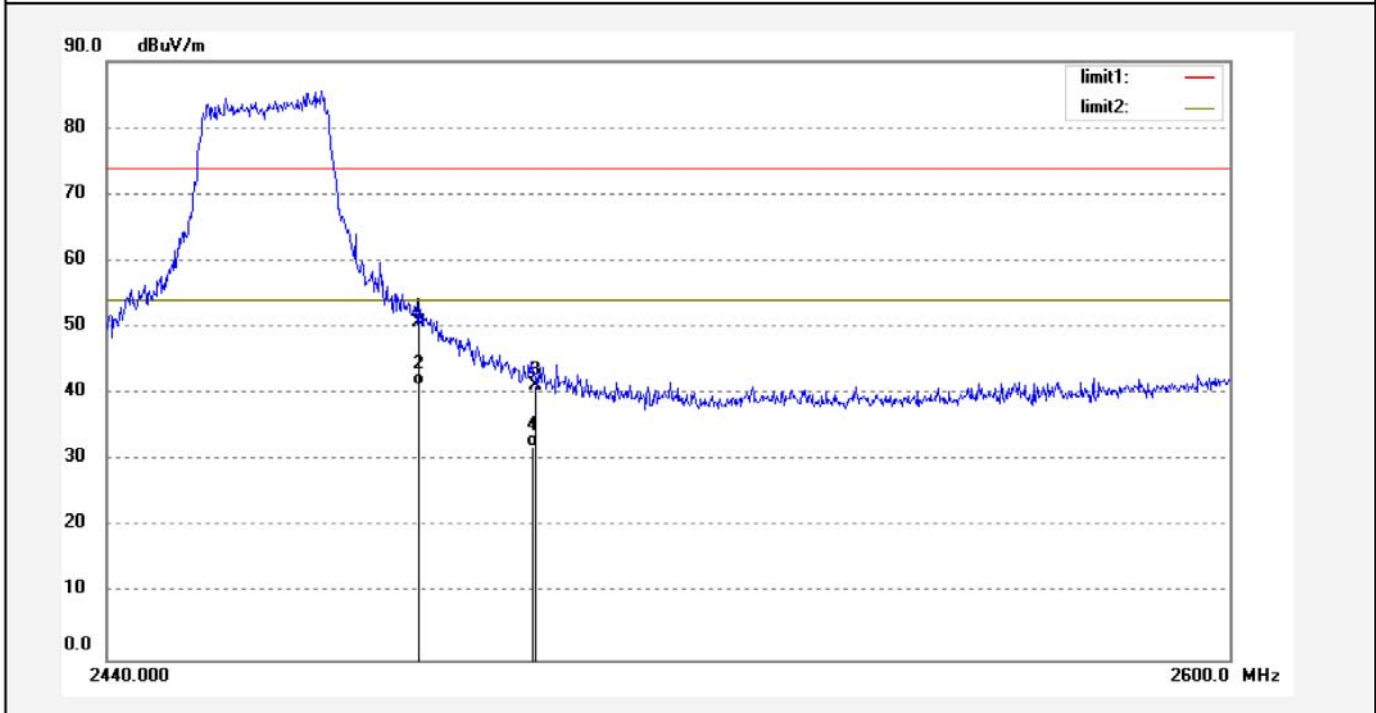

No.	Freq. (MHz)	Reading (dBuV/m)	Factor (dB)	Result (dBuV/m)	Limit (dBuV/m)	Margin (dB)	Detector	Height (cm)	Degree (deg.)	Remark
1	2483.500	56.88	-6.04	50.84	74.00	-23.16	peak			
2	2483.500	47.25	-6.04	41.21	54.00	-12.79	AVG			
3	2500.000	47.36	-6.00	41.36	74.00	-32.64	peak			
4	2500.000	38.15	-6.00	32.15	54.00	-21.85	AVG			

Note: Average measurement with peak detection at No.2&4

Job No.: STAR2016 #2165

Standard: FCC PK

Test item: Radiation Test

Temp.( C)/Hum.(%) 25 C / 55 %

EUT: Media box

Mode: TX Channel 11(802.11n20)

Model: X9

Manufacturer: PIPO TECHNOLOGY CO., LTD

Polarization: Vertical

Power Source: AC 120V/60Hz

Date: 16/06/16/

Time: 11/34/50

Engineer Signature:

Distance: 3m

Note: Report No.:ATE20161167

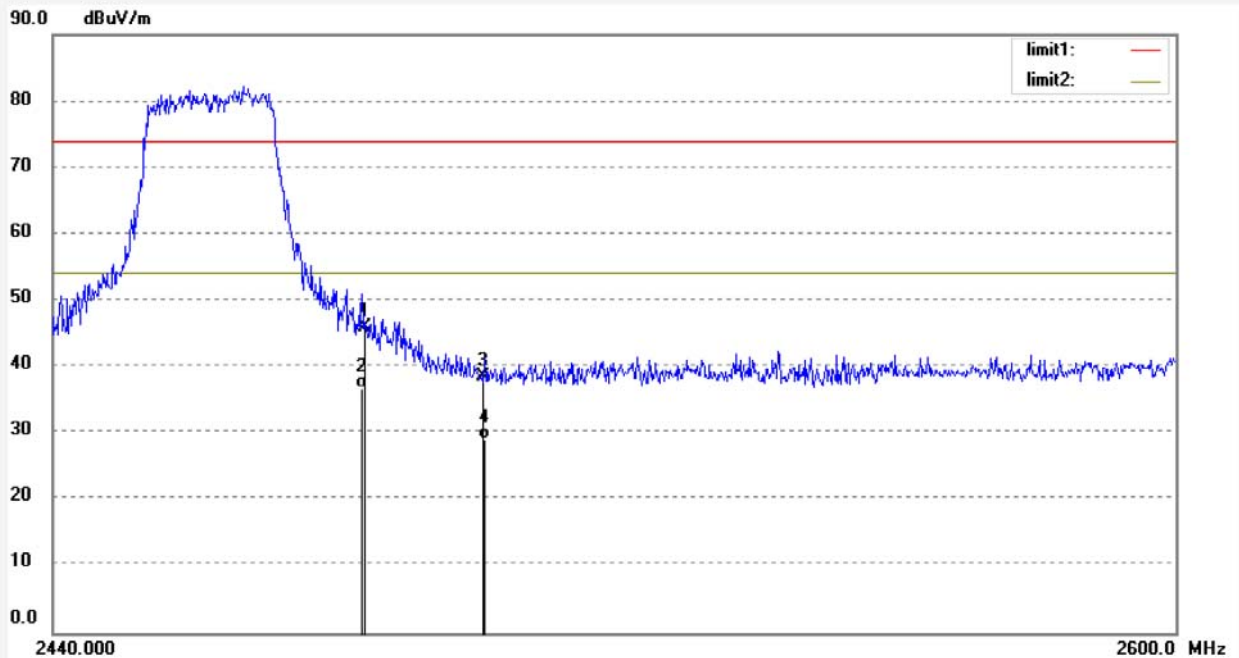

No.	Freq. (MHz)	Reading (dBuV/m)	Factor (dB)	Result (dBuV/m)	Limit (dBuV/m)	Margin (dB)	Detector	Height (cm)	Degree (deg.)	Remark
1	2483.500	52.07	-6.04	46.03	74.00	-27.97	peak			
2	2483.500	42.89	-6.04	36.85	54.00	-17.15	AVG			
3	2500.000	44.48	-6.00	38.48	74.00	-35.52	peak			
4	2500.000	35.10	-6.00	29.10	54.00	-24.90	AVG			

Note: Average measurement with peak detection at No.2&4

Job No.: STAR2016 #2170	Polarization: Horizontal
Standard: FCC PK	Power Source: AC 120V/60Hz
Test item: Radiation Test	Date: 16/06/16/
Temp.( C)/Hum.(%) 25 C / 55 %	Time: 11/56/02
EUT: Media box	Engineer Signature:
Mode: TX Channel 3(802.11n40)	Distance: 3m
Model: X9	
Manufacturer: PIPO TECHNOLOGY CO., LTD	

Note: Report No.:ATE20161167

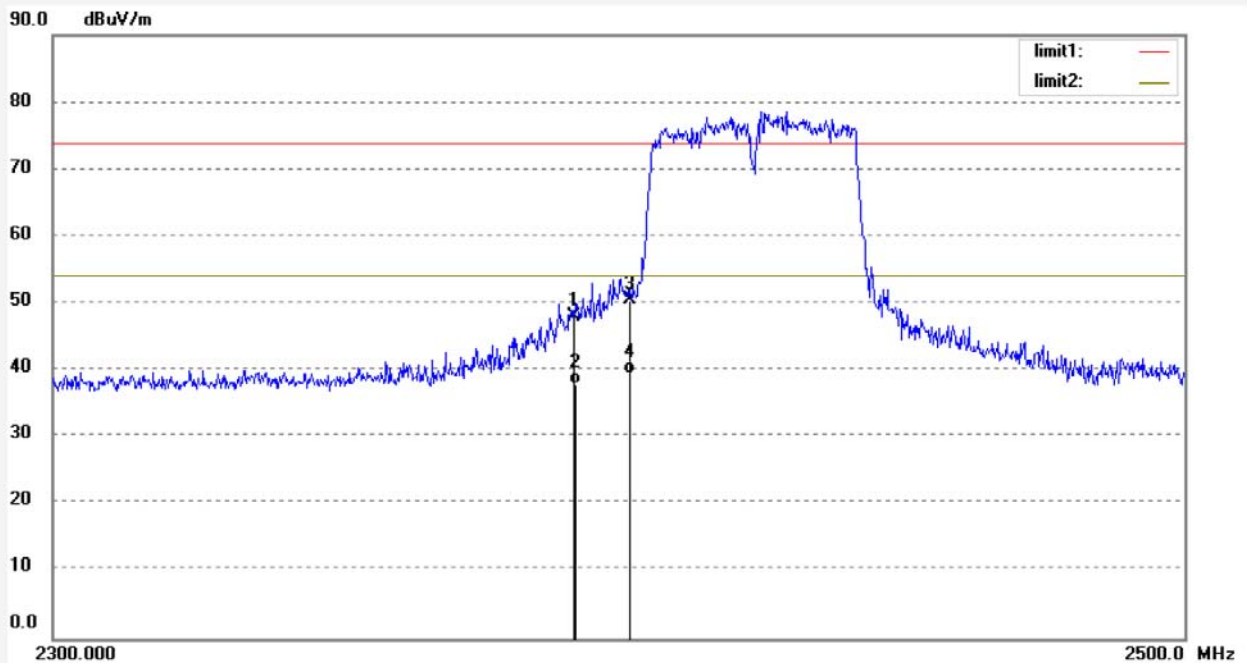

No.	Freq. (MHz)	Reading (dBuV/m)	Factor (dB)	Result (dBuV/m)	Limit (dBuV/m)	Margin (dB)	Detector	Height (cm)	Degree (deg.)	Remark
1	2390.000	54.29	-6.31	47.98	74.00	-26.02	peak			
2	2390.000	44.25	-6.31	37.94	54.00	-16.06	AVG			
3	2400.000	56.82	-6.28	50.54	74.00	-23.46	peak			
4	2400.000	45.78	-6.28	39.50	54.00	-14.50	AVG			

Note: Average measurement with peak detection at No.2&4

Job No.: STAR2016 #2169	Polarization: Vertical
Standard: FCC PK	Power Source: AC 120V/60Hz
Test item: Radiation Test	Date: 16/06/16/
Temp.( C)/Hum.(%) 25 C / 55 %	Time: 11/51/59
EUT: Media box	Engineer Signature:
Mode: TX Channel 3(802.11n40)	Distance: 3m
Model: X9	
Manufacturer: PIPO TECHNOLOGY CO., LTD	

Note: Report No.:ATE20161167

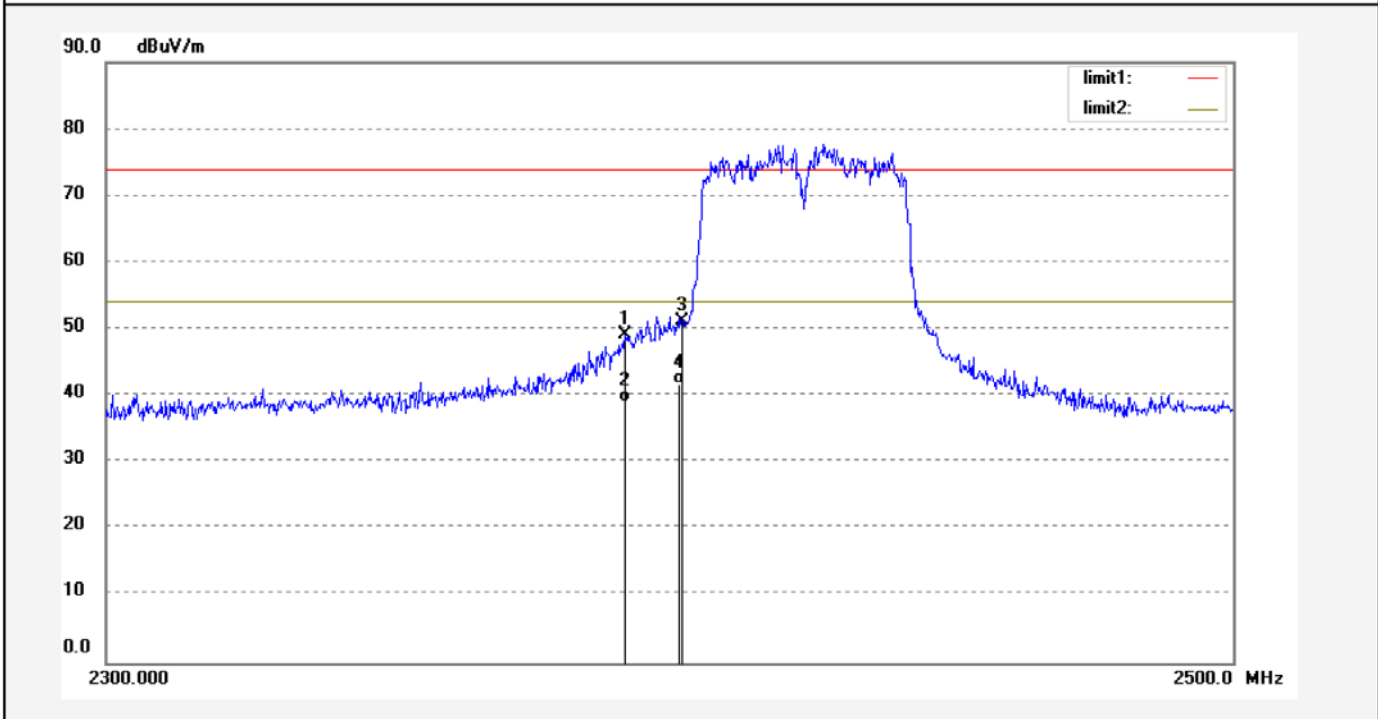

No.	Freq. (MHz)	Reading (dBuV/m)	Factor (dB)	Result (dBuV/m)	Limit (dBuV/m)	Margin (dB)	Detector	Height (cm)	Degree (deg.)	Remark
1	2390.000	55.55	-6.31	49.24	74.00	-24.76	peak			
2	2390.000	45.26	-6.31	38.95	54.00	-15.05	AVG			
3	2400.000	57.57	-6.28	51.29	74.00	-22.71	peak			
4	2400.000	48.02	-6.28	41.74	54.00	-12.26	AVG			

Note: Average measurement with peak detection at No.2&4

Job No.: STAR2016 #2167	Polarization: Horizontal
Standard: FCC PK	Power Source: AC 120V/60Hz
Test item: Radiation Test	Date: 16/06/16/
Temp.( C)/Hum.(%) 25 C / 55 %	Time: 11/42/35
EUT: Media box	Engineer Signature:
Mode: TX Channel 9(802.11n40)	Distance: 3m
Model: X9	
Manufacturer: PIPO TECHNOLOGY CO., LTD	

Note: Report No.:ATE20161167

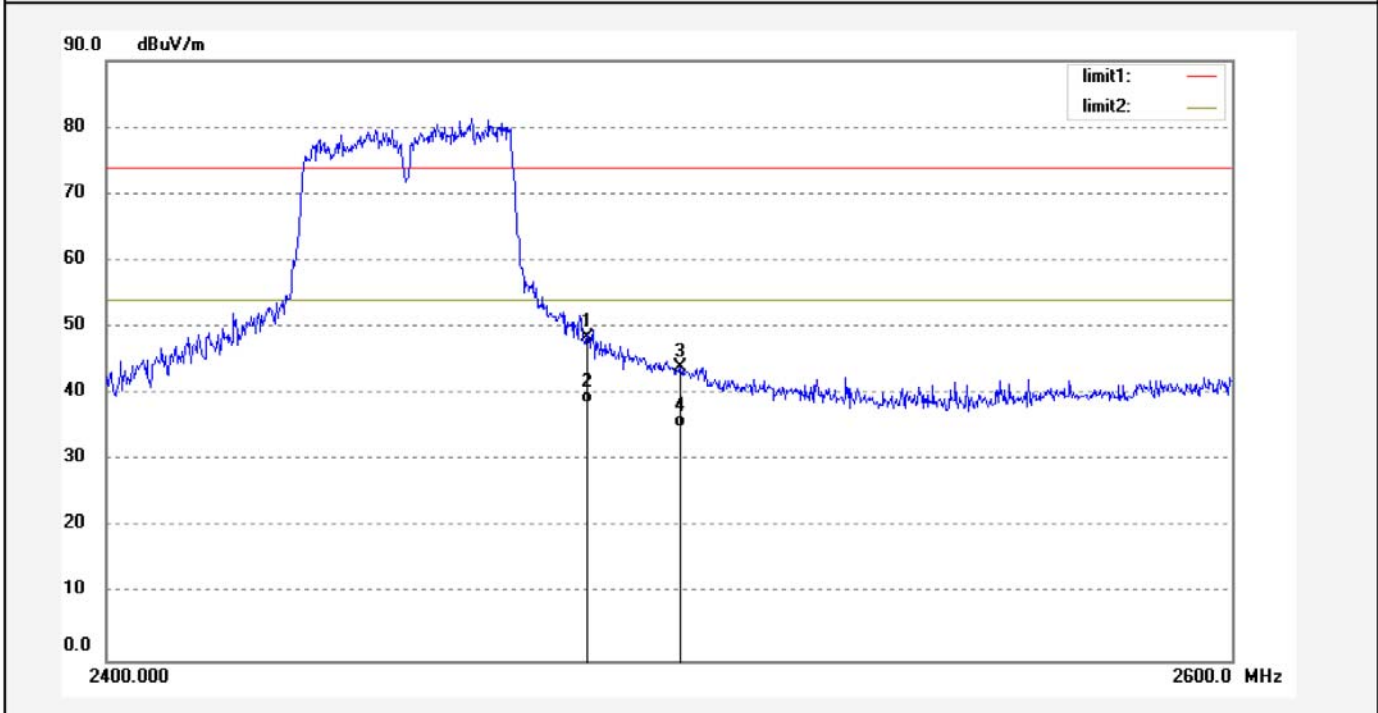

No.	Freq. (MHz)	Reading (dBuV/m)	Factor (dB)	Result (dBuV/m)	Limit (dBuV/m)	Margin (dB)	Detector	Height (cm)	Degree (deg.)	Remark
1	2483.500	54.45	-6.04	48.41	74.00	-25.59	peak			
2	2483.500	44.58	-6.04	38.54	54.00	-15.46	AVG			
3	2500.000	50.07	-6.00	44.07	74.00	-29.93	peak			
4	2500.000	40.89	-6.00	34.89	54.00	-19.11	AVG			

Note: Average measurement with peak detection at No.2&4

Job No.: STAR2016 #2168

Standard: FCC PK

Test item: Radiation Test

Temp.( C)/Hum.(%) 25 C / 55 %

EUT: Media box

Mode: TX Channel 9(802.11n40)

Model: X9

Manufacturer: PIPO TECHNOLOGY CO., LTD

Polarization: Vertical

Power Source: AC 120V/60Hz

Date: 16/06/16/

Time: 11/47/37

Engineer Signature:

Distance: 3m

Note: Report No.:ATE20161167

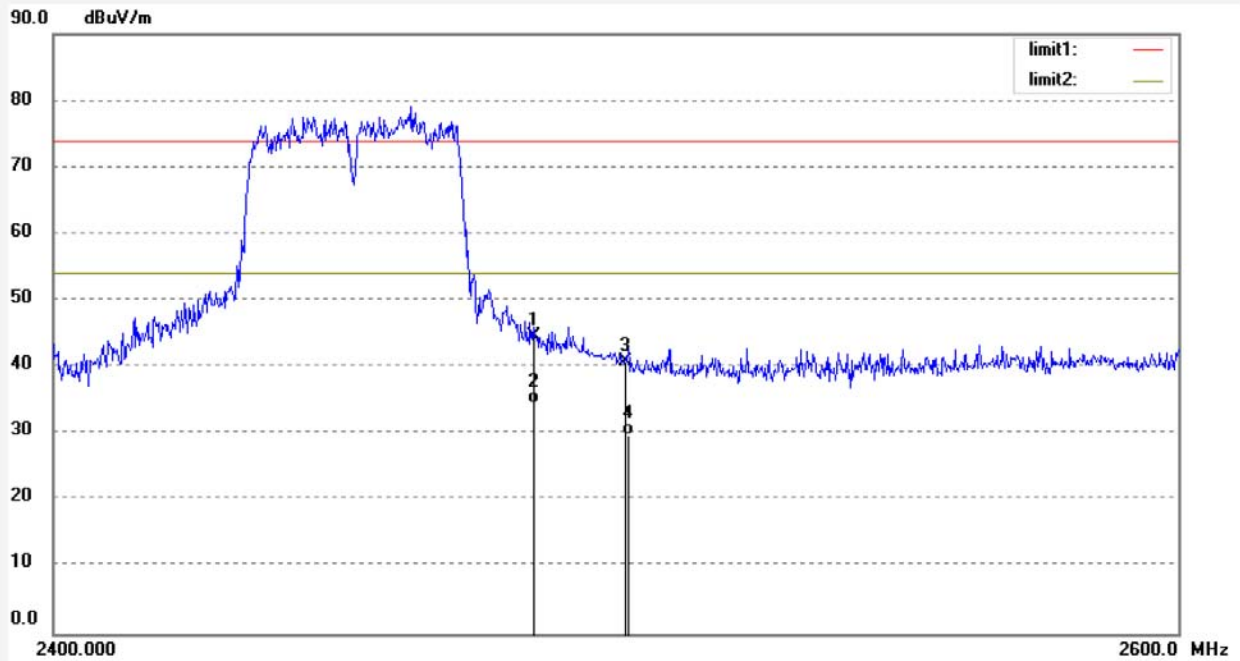

No.	Freq. (MHz)	Reading (dBuV/m)	Factor (dB)	Result (dBuV/m)	Limit (dBuV/m)	Margin (dB)	Detector	Height (cm)	Degree (deg.)	Remark
1	2483.500	50.65	-6.04	44.61	74.00	-29.39	peak			
2	2483.500	40.52	-6.04	34.48	54.00	-19.52	AVG			
3	2500.000	46.92	-6.00	40.92	74.00	-33.08	peak			
4	2500.000	35.79	-6.00	29.79	54.00	-24.21	AVG			

Note: Average measurement with peak detection at No.2&4

## 10. RADIATED SPURIOUS EMISSION TEST

### 10.1. Block Diagram of Test Setup

#### 10.1.1. Block diagram of connection between the EUT and peripherals

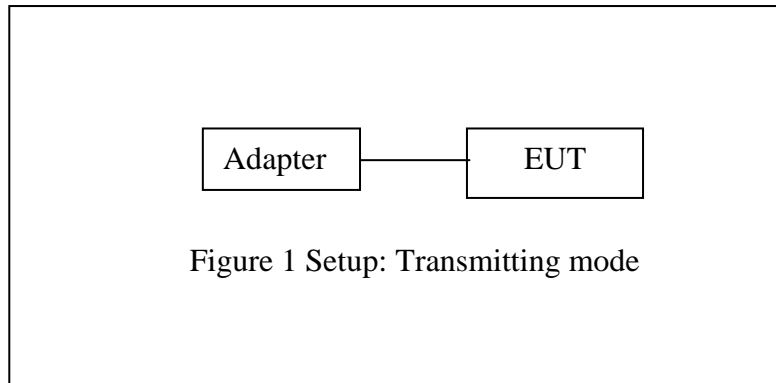

#### 10.1.2. Semi-Anechoic Chamber Test Setup Diagram

(A) Radiated Emission Test Set-Up, Frequency below 30MHz

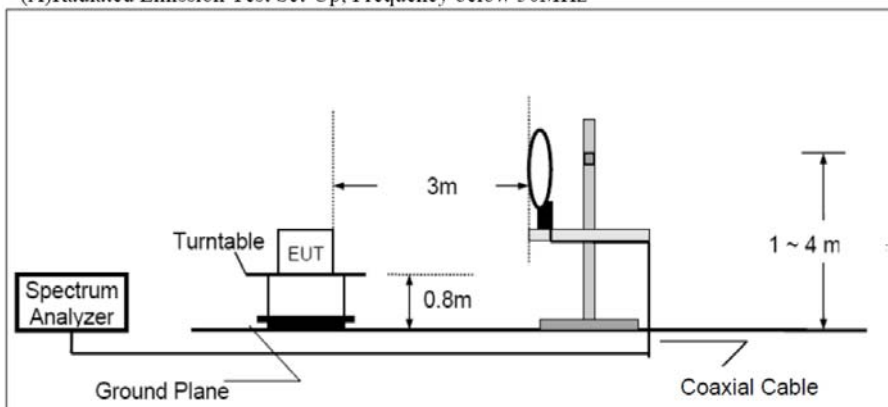

(B) Radiated Emission Test Set-Up, Frequency 30-1000MHz

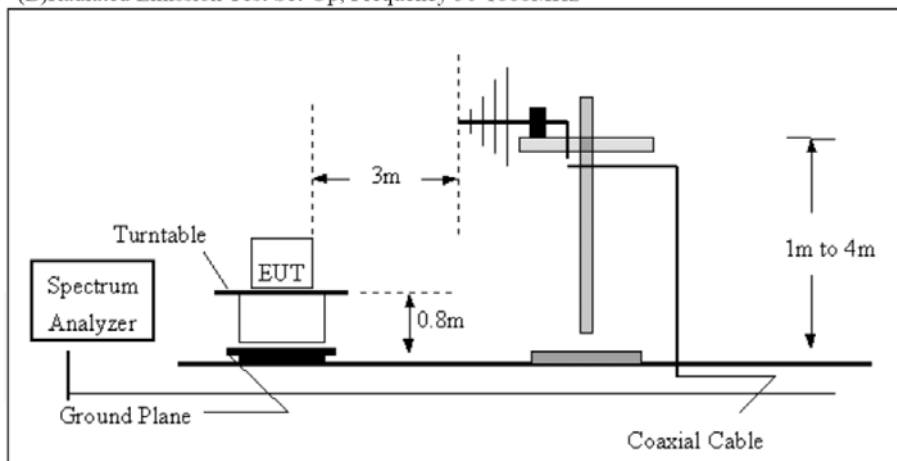



(C) Radiated Emission Test Set-Up, Frequency above 1GHz

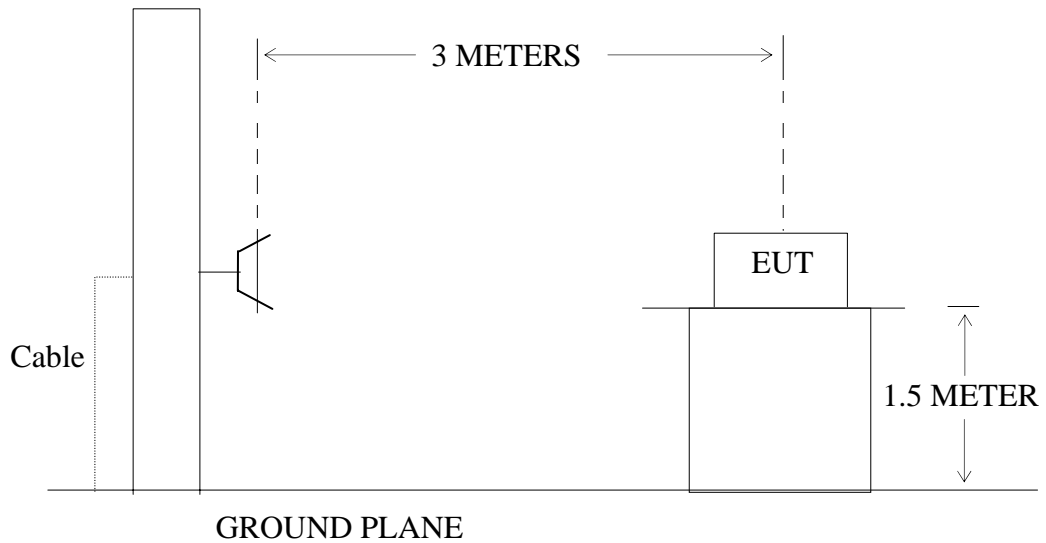

10.2. The Limit For Section 15.247(d)

Section 15.247(d): In any 100 kHz bandwidth outside the frequency band in which the spread spectrum or digitally modulated intentional radiator is operating, the radio frequency power that is produced by the intentional radiator shall be at least 20 dB below that in the 100 kHz bandwidth within the band that contains the highest level of the desired power, based on either an RF conducted or a radiated measurement, provided the transmitter demonstrates compliance with the peak conducted power limits. If the transmitter complies with the conducted power limits based on the use of RMS averaging over a time interval, as permitted under paragraph (b)(3) of this section, the attenuation required under this paragraph shall be 30 dB instead of 20 dB. Attenuation below the general limits specified in Section 15.209(a) is not required. In addition, radiated emissions which fall in the restricted bands, as defined in Section 15.205(a), must also comply with the radiated emission limits specified in Section 15.209(a).

### 10.3.Restricted bands of operation

#### 10.3.1.FCC Part 15.205 Restricted bands of operation

(a) Except as shown in paragraph (d) of this section, Only spurious emissions are permitted in any of the frequency bands listed below:

MHz	MHz	MHz	GHz
0.090-0.110	16.42-16.423	399.9-410	4.5-5.15
<sup>1</sup> 0.495-0.505	16.69475-16.69525	608-614	5.35-5.46
2.1735-2.1905	16.80425-16.80475	960-1240	7.25-7.75
4.125-4.128	25.5-25.67	1300-1427	8.025-8.5
4.17725-4.17775	37.5-38.25	1435-1626.5	9.0-9.2
4.20725-4.20775	73-74.6	1645.5-1646.5	9.3-9.5
6.215-6.218	74.8-75.2	1660-1710	10.6-12.7
6.26775-6.26825	108-121.94	1718.8-1722.2	13.25-13.4
6.31175-6.31225	123-138	2200-2300	14.47-14.5
8.291-8.294	149.9-150.05	2310-2390	15.35-16.2
8.362-8.366	156.52475-156.52525	2483.5-2500	17.7-21.4
8.37625-8.38675	156.7-156.9	2690-2900	22.01-23.12
8.41425-8.41475	162.0125-167.17	3260-3267	23.6-24.0
12.29-12.293	167.72-173.2	3332-3339	31.2-31.8
12.51975-12.52025	240-285	3345.8-3358	36.43-36.5
12.57675-12.57725	322-335.4	3600-4400	( <sup>2</sup> )
13.36-13.41			

<sup>1</sup>Until February 1, 1999, this restricted band shall be 0.490-0.510

<sup>2</sup>Above 38.6

(b) Except as provided in paragraphs (d) and (e), the field strength of emission appearing within these frequency bands shall not exceed the limits shown in Section 15.209. At frequencies equal to or less than 1000MHz, Compliance with the limits in Section 15.209 shall be demonstrated using measurement instrumentation employing a CISPR quasi-peak detector. Above 1000MHz, compliance with the emission limits in Section 15.209 shall be demonstrated based on the average value of the measured emissions. The provisions in Section 15.35 apply to these measurements.

### 10.4.Configuration of EUT on Measurement

The equipment are installed on Radiated Emission Measurement to meet the commission requirements and operating regulations in a manner which tends to maximize its emission characteristics in normal application.

## 10.5. Operating Condition of EUT

10.5.1. Setup the EUT and simulator as shown as Section 10.1.

10.5.2. Turn on the power of all equipment.

10.5.3. Let the EUT work in TX modes measure it. The transmit frequency are 2412-2462 and 2422-2452MHz. We select 2412MHz, 2437MHz, 2462MHz and 2422MHz, 2437MHz, 2452MHz TX frequency to transmit.

## 10.6. Test Procedure

The EUT and its simulators are placed on a turntable, which is 0.8 meter high above ground (Below 1GHz). The EUT and its simulators are placed on a turntable, which is 1.5 meter high above ground (Above 1GHz). The turntable can rotate 360 degrees to determine the position of the maximum emission level. EUT is set 3.0 meters away from the receiving antenna, which is mounted on an antenna tower. The antenna can be moved up and down between 1.0 meter and 4 meters to find out the maximum emission level. Broadband antenna (calibrated bi-log antenna) is used as receiving antenna. Both horizontal and vertical polarizations of the antenna are set on measurement. In order to find the maximum emission levels, all of the EUT location must be manipulated according to ANSI C63.10:2013 on radiated emission measurement. The EUT was tested in 3 orthogonal planes.

The worst-case data rate for this channel to be 1Mbps for 802.11b mode and 6Mbps for 802.11g mode and 150Mbps for 802.11n mode, based on previous with 802.11 WLAN product design architectures.

The frequency range from 30MHz to 25000MHz is checked.

Result = Reading + Corrected Factor

Where Corrected Factor = Antenna Factor + Cable Loss – Amplifier Gain

During the radiated emission test, the spectrum analyzer was set with the following configurations:

1. The resolution bandwidth and video bandwidth of test receiver/spectrum analyzer is 120kHz for Quasi-peak at frequency below 1GHz.
2. The resolution bandwidth of test receiver/spectrum analyzer is 1MHz and video bandwidth is 3MHz for peak measurement with peak detector at frequency above 1GHz.
3. The resolution bandwidth of test receiver/spectrum analyzer is 1MHz and video bandwidth is 10Hz for Average measurement with peak detection at frequency above 1GHz.
4. All modes of operation were investigated and the worst-case emissions are reported.