

APPLICATION CERTIFICATION FCC Part 15C
On Behalf of
PIPO TECHNOLOGY CO., LIMITED

Media box
Model No.: X9

FCC ID: PT7-X9

Prepared for : PIPO TECHNOLOGY CO., LIMITED
Address : Area C, 3F, Bao Yun Da Logistics Centre,
Warehouse Building, Xi Xiang Avenue, Bao An
District, Shenzhen, China.
Prepared by : ACCURATE TECHNOLOGY CO., LTD
Address : F1, Bldg. A&D, Chan Yuan New Material Port,
Keyuan Rd. Science & Industry Park, Nan Shan,
Shenzhen, Guangdong P.R. China
Tel: (0755) 26503290
Fax: (0755) 26503396

Report No. : ATE20161168
Date of Test : Jun 13-27, 2016
Date of Report : Jun 28, 2016

TABLE OF CONTENTS

Description	Page
Test Report Certification	
1. GENERAL INFORMATION	5
1.1. Description of Device (EUT).....	5
1.2. Accessory and Auxiliary Equipment.....	5
1.3. Description of Test Facility	6
1.4. Measurement Uncertainty.....	6
2. MEASURING DEVICE AND TEST EQUIPMENT	7
3. OPERATION OF EUT DURING TESTING	8
3.1. Operating Mode	8
3.2. Configuration and peripherals	8
4. TEST PROCEDURES AND RESULTS	9
5. 20DB BANDWIDTH TEST.....	10
5.1. Block Diagram of Test Setup.....	10
5.2. The Requirement For Section 15.247(a)(1).....	10
5.3. EUT Configuration on Measurement	10
5.4. Operating Condition of EUT	10
5.5. Test Procedure	10
5.6. Test Result	11
6. CARRIER FREQUENCY SEPARATION TEST.....	17
6.1. Block Diagram of Test Setup.....	17
6.2. The Requirement For Section 15.247(a)(1).....	17
6.3. EUT Configuration on Measurement	17
6.4. Operating Condition of EUT	17
6.5. Test Procedure	18
6.6. Test Result	18
7. NUMBER OF HOPPING FREQUENCY TEST	24
7.1. Block Diagram of Test Setup.....	24
7.2. The Requirement For Section 15.247(a)(1)(iii).....	24
7.3. EUT Configuration on Measurement	24
7.4. Operating Condition of EUT	24
7.5. Test Procedure	24
7.6. Test Result	25
8. DWELL TIME TEST	27
8.1. Block Diagram of Test Setup.....	27
8.2. The Requirement For Section 15.247(a)(1)(iii).....	27
8.3. EUT Configuration on Measurement	27
8.4. Operating Condition of EUT	27
8.5. Test Procedure	27
8.6. Test Result	28
9. MAXIMUM PEAK OUTPUT POWER TEST	43
9.1. Block Diagram of Test Setup.....	43
9.2. The Requirement For Section 15.247(b)(1).....	43
9.3. EUT Configuration on Measurement	43
9.4. Operating Condition of EUT	43

9.5.	Test Procedure	43
9.6.	Test Result	44
10.	RADIATED EMISSION TEST	50
10.1.	Block Diagram of Test Setup.....	50
10.2.	The Limit For Section 15.247(d)	51
10.3.	Restricted bands of operation	52
10.4.	Configuration of EUT on Measurement	52
10.5.	Test Procedure	53
10.6.	The Field Strength of Radiation Emission Measurement Results	53
11.	BAND EDGE COMPLIANCE TEST	66
11.1.	Block Diagram of Test Setup.....	66
11.2.	The Requirement For Section 15.247(d)	66
11.3.	EUT Configuration on Measurement	66
11.4.	Operating Condition of EUT	66
11.5.	Test Procedure	67
11.6.	Test Result	67
12.	AC POWER LINE CONDUCTED EMISSION FOR FCC PART 15 SECTION 15.207(A) ..	90
12.1.	Block Diagram of Test Setup.....	90
12.2.	Power Line Conducted Emission Measurement Limits.....	90
12.3.	Configuration of EUT on Measurement	90
12.4.	Operating Condition of EUT	90
12.5.	Test Procedure	91
12.6.	Power Line Conducted Emission Measurement Results	92
13.	ANTENNA REQUIREMENT.....	98
13.1.	The Requirement	98
13.2.	Antenna Construction	98

Test Report Certification

Applicant : PIPO TECHNOLOGY CO., LIMITED
Manufacturer : PIPO TECHNOLOGY CO., LIMITED
EUT Description : Media box
Model No. : X9
Trade Mark : N/A

Measurement Procedure Used:

**FCC Rules and Regulations Part 15 Subpart C Section 15.247: 2015
ANSI C63.10: 2013**

The device described above is tested by ACCURATE TECHNOLOGY CO. LTD to determine the maximum emission levels emanating from the device. The maximum emission levels are compared to the FCC Part 15 Subpart C Section 15.247 limits. The measurement results are contained in this test report and ACCURATE TECHNOLOGY CO. LTD is assumed full responsibility for the accuracy and completeness of these measurements. Also, this report shows that the Equipment Under Test (EUT) is to be technically compliant with the FCC requirements.

This report applies to above tested sample only. This report shall not be reproduced in part without written approval of ACCURATE TECHNOLOGY CO. LTD.

Date of Test : Jun 13-27, 2016
Date of Report: Jun 28, 2016

Prepared by : 
(Mark Chen, Engineer)

Approved & Authorized Signer : 
(Sean Liu, Manager)

1. GENERAL INFORMATION

1.1. Description of Device (EUT)

EUT	:	Media box
Model Number	:	X9
Bluetooth version	:	BT V4.0 Dual Mode This report is for BT classic mode
Frequency Range	:	2402MHz-2480MHz
Number of Channels	:	40 for BT V4.0 LE 79 for BT classic mode
Antenna Gain	:	2dBi
Antenna type	:	External Antenna
Power Supply	:	AC 100-240V~50/60Hz
Adapter	:	Model:KA1433-1202400JP Input: 100-240V~50/60Hz 1.0A Max Out: 12V/2400mA
Modulation mode	:	GFSK for BT V4.0 LE GFSK, $\pi/4$ DQPSK, 8DPSK for BT classic mode
Applicant Address	:	PIPO TECHNOLOGY CO., LIMITED Area C, 3F, Bao Yun Da Logistics Centre, Warehouse Building, Xi Xiang Avenue, Bao An District, Shenzhen, China.
Manufacuter Address	:	PIPO TECHNOLOGY CO., LIMITED Area C, 3F, Bao Yun Da Logistics Centre, Warehouse Building, Xi Xiang Avenue, Bao An District, Shenzhen, China.
Date of sample received	:	Jun 13, 2016
Date of Test	:	Jun 13-27, 2016

1.2. Accessory and Auxiliary Equipment

N/A

1.3. Description of Test Facility

EMC Lab : Accredited by TUV Rheinland Shenzhen

Listed by FCC
The Registration Number is 752051

Listed by Industry Canada
The Registration Number is 5077A-2

Accredited by China National Accreditation Committee
for Laboratories
The Certificate Registration Number is L3193

Name of Firm : ACCURATE TECHNOLOGY CO. LTD
Site Location : F1, Bldg. A, Changyuan New Material Port, Keyuan Rd.
Science & Industry Park, Nanshan, Shenzhen, Guangdong
P.R. China

1.4. Measurement Uncertainty

Conducted Emission Expanded Uncertainty = 2.23dB, k=2

Radiated emission expanded uncertainty
(9kHz-30MHz) = 3.08dB, k=2

Radiated emission expanded uncertainty
(30MHz-1000MHz) = 4.42dB, k=2

Radiated emission expanded uncertainty
(Above 1GHz) = 4.06dB, k=2

2. MEASURING DEVICE AND TEST EQUIPMENT

Table 1: List of Test and Measurement Equipment

Kind of equipment	Manufacturer	Type	S/N	Calibrated dates	Calibrated until
EMI Test Receiver	Rohde&Schwarz	ESCS30	100307	Jan. 9, 2016	1 Year
EMI Test Receiver	Rohde&Schwarz	ESPI3	101526/003	Jan. 9, 2016	1 Year
Spectrum Analyzer	Agilent	E7405A	MY45115511	Jan. 9, 2016	1 Year
Pre-Amplifier	Rohde&Schwarz	CBLU118354 0-01	3791	Jan. 9, 2016	1 Year
Loop Antenna	Schwarzbeck	FMZB1516	1516131	Jan. 14, 2016	1 Year
Bilog Antenna	Schwarzbeck	VULB9163	9163-323	Jan. 14, 2016	1 Year
Horn Antenna	Schwarzbeck	BBHA9120D	9120D-655	Jan. 14, 2016	1 Year
Horn Antenna	Schwarzbeck	BBHA9170	9170-359	Jan. 14, 2016	1 Year
LISN	Rohde&Schwarz	ESH3-Z5	100305	Jan. 9, 2016	1 Year
LISN	Schwarzbeck	NSLK8126	8126431	Jan. 9, 2016	1 Year
Highpass Filter	Wainwright Instruments	WHKX3.6/18 G-10SS	N/A	Jan. 9, 2016	1 Year
Band Reject Filter	Wainwright Instruments	WRCG2400/2 485-2375/2510 -60/11SS	N/A	Jan. 9, 2016	1 Year

3. OPERATION OF EUT DURING TESTING

3.1. Operating Mode

The mode is used: Transmitting mode

Low Channel: 2402MHz

Middle Channel: 2441MHz

High Channel: 2480MHz

Hopping

3.2. Configuration and peripherals

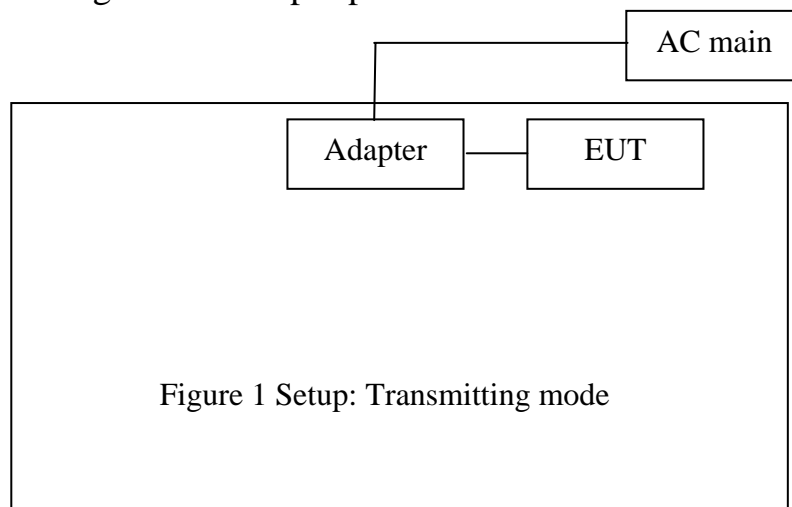

4. TEST PROCEDURES AND RESULTS

FCC Rules	Description of Test	Result
Section 15.207	Conducted Emission Test	Compliant
Section 15.247(a)(1)	20dB Bandwidth Test	Compliant
Section 15.247(a)(1)	Carrier Frequency Separation Test	Compliant
Section 15.247(a)(1)(iii)	Number Of Hopping Frequency Test	Compliant
Section 15.247(a)(1)(iii)	Dwell Time Test	Compliant
Section 15.247(b)(1)	Maximum Peak Output Power Test	Compliant
Section 15.247(d) Section 15.209	Radiated Emission Test	Compliant
Section 15.247(d)	Band Edge Compliance Test	Compliant
Section 15.203	Antenna Requirement	Compliant

5. 20DB BANDWIDTH TEST

5.1. Block Diagram of Test Setup

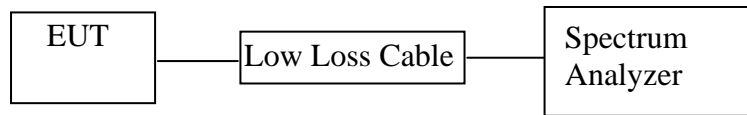

(EUT: Media box)

5.2. The Requirement For Section 15.247(a)(1)

Section 15.247(a)(1): Frequency hopping systems shall have hopping channel carrier frequencies separated by a minimum of 25 kHz or the 20 dB bandwidth of the hopping channel, whichever is greater.

5.3. EUT Configuration on Measurement

The equipment are installed on the emission measurement to meet the commission requirements and operating regulations in a manner which tends to maximize its emission characteristics in normal application.

5.4. Operating Condition of EUT

5.4.1. Setup the EUT and simulator as shown as Section 5.1.

5.4.2. Turn on the power of all equipment.

5.4.3. Let the EUT work in TX (Hopping off) modes measure it. The transmit frequency are 2402-2480MHz. We select 2402MHz, 2441MHz, and 2480MHz TX frequency to transmit.

5.5. Test Procedure

5.5.1. The transmitter output was connected to the spectrum analyzer through a low loss cable.

5.5.2. Set RBW of spectrum analyzer to 30 kHz and VBW to 100 kHz.

5.5.3. The 20dB bandwidth is defined as the total spectrum the power of which is higher than peak power minus 20dB.

5.6. Test Result

Channel	Frequency (MHz)	GFSK 20dB Bandwidth (MHz)	$\Pi/4$ -DQPSK 20dB Bandwidth (MHz)	8DPSK 20dB Bandwidth (MHz)	Result
Low	2402	0.708	1.116	1.160	Pass
Middle	2441	0.704	1.116	1.164	Pass
High	2480	0.704	1.112	1.164	Pass

The spectrum analyzer plots are attached as below.

GFSK Mode

Low channel

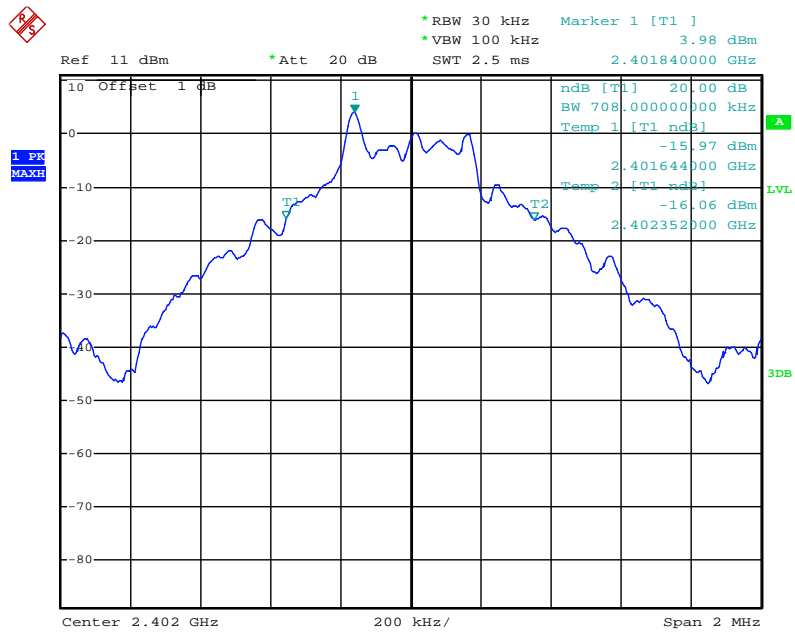

Middle channel

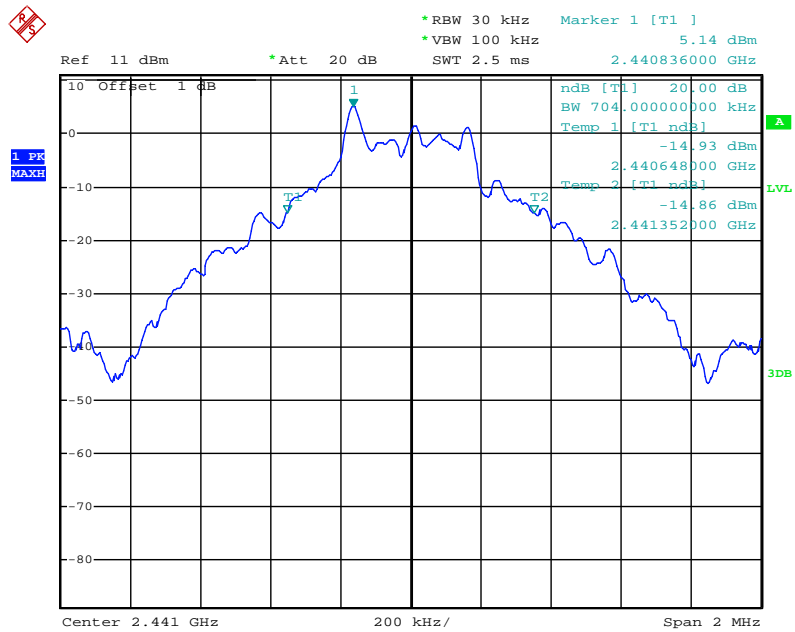

High channel

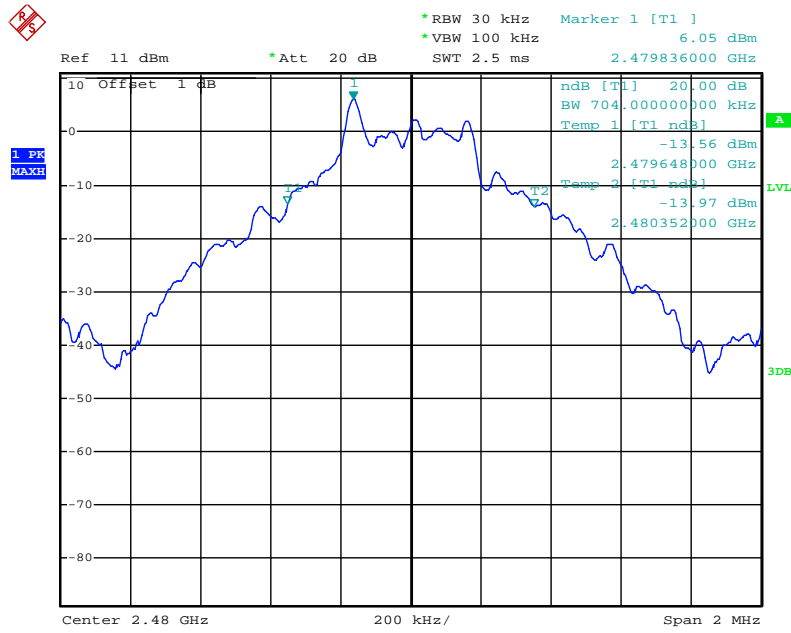

Π/4-DQPSK Mode

Low channel

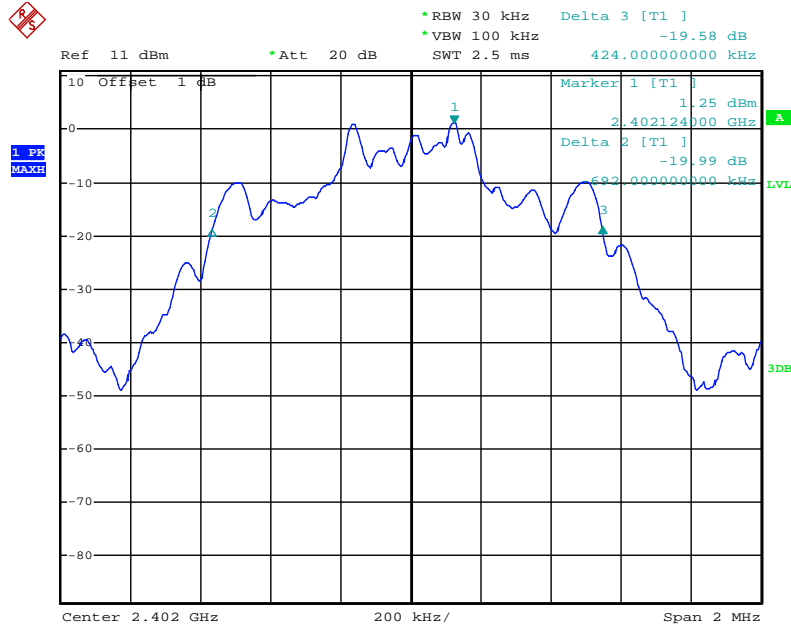

Middle channel

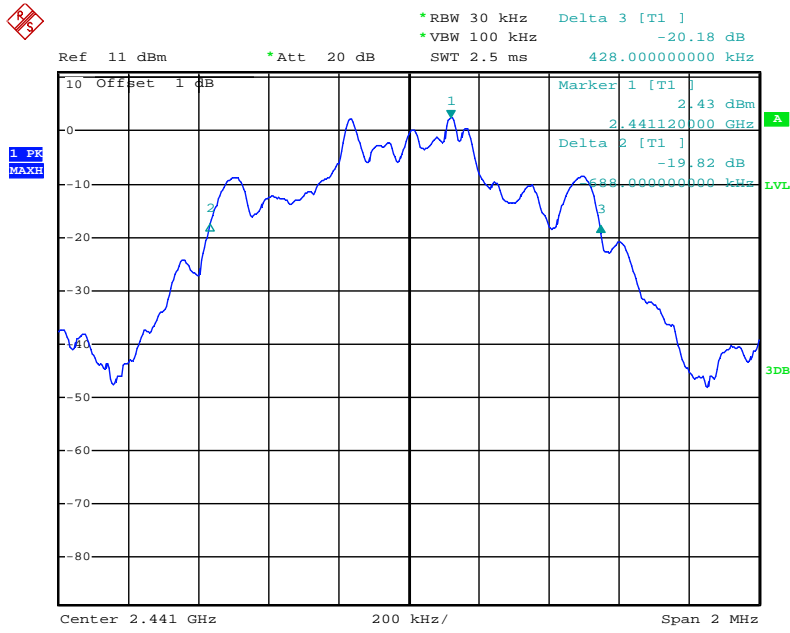

High channel

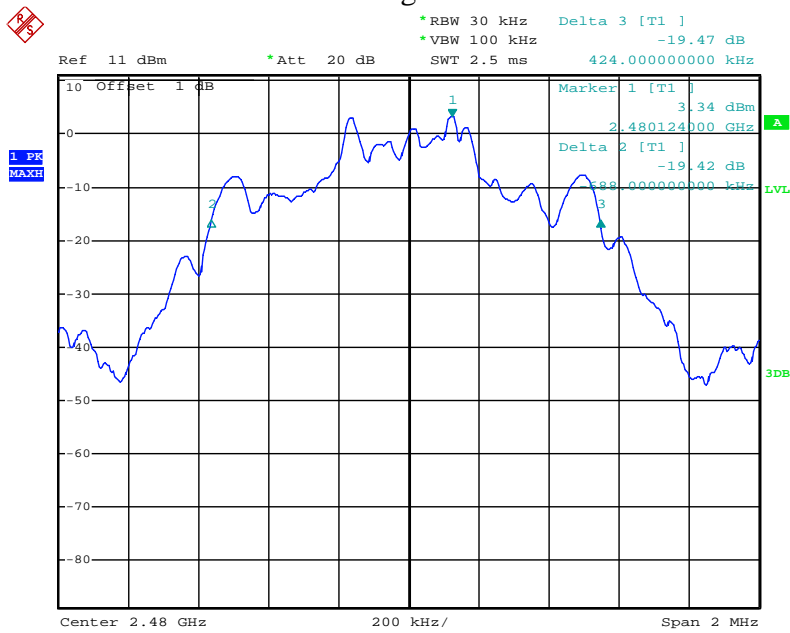

8DPSK Mode

Low channel

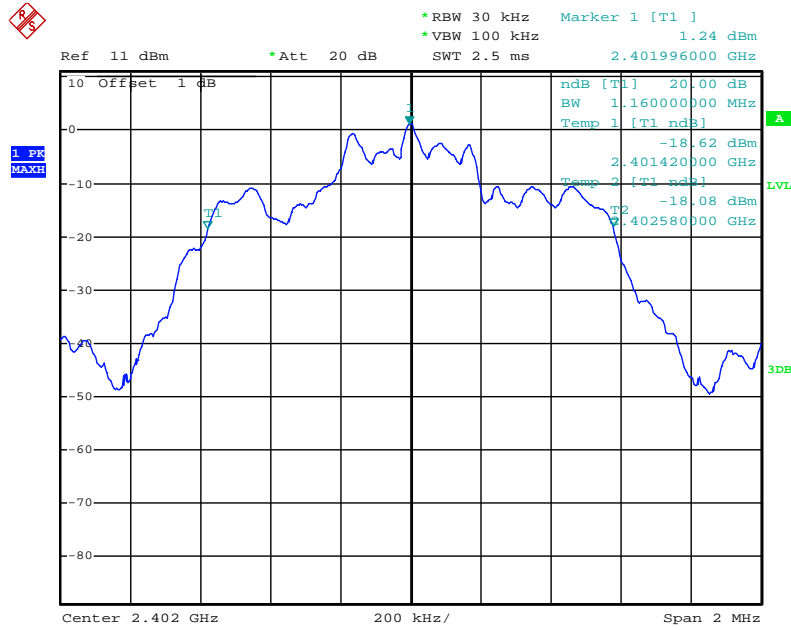

Middle channel

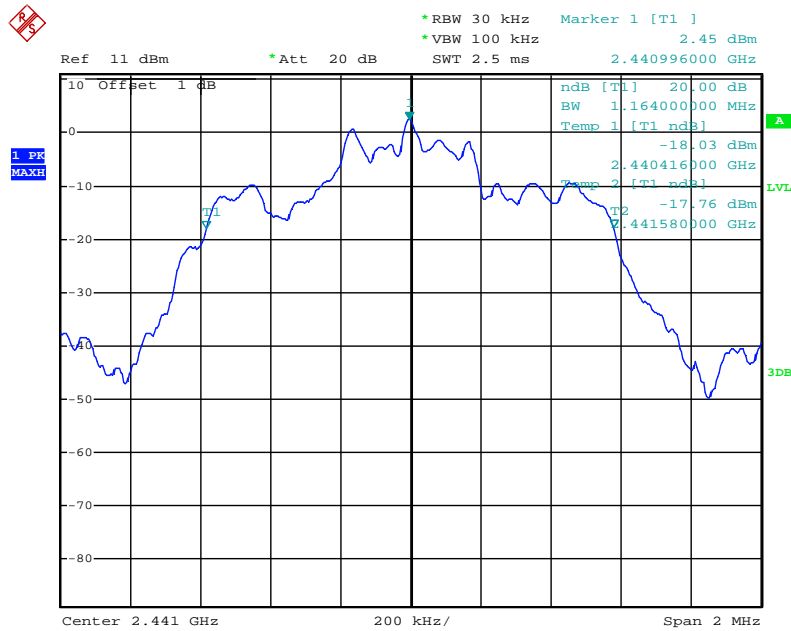

High channel

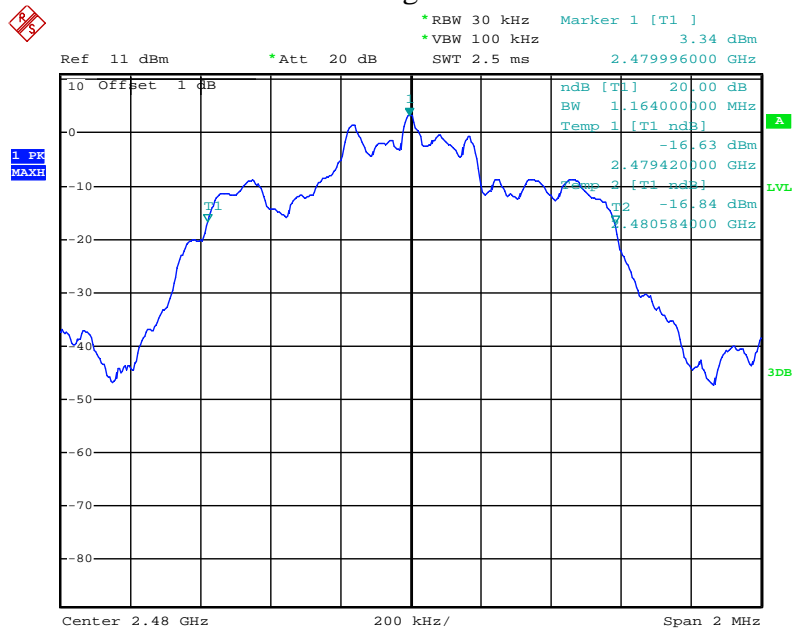

6. CARRIER FREQUENCY SEPARATION TEST

6.1. Block Diagram of Test Setup



(EUT: Media box)

6.2. The Requirement For Section 15.247(a)(1)

Section 15.247(a)(1): Frequency hopping systems shall have hopping channel carrier frequencies separated by a minimum of 25 kHz or the 20 dB bandwidth of the hopping channel, whichever is greater. Alternatively, frequency hopping systems operating in the 2400-2483.5 MHz band may have hopping channel carrier frequencies that are separated by 25 kHz or two-thirds of the 20 dB bandwidth of the hopping channel, whichever is greater, provided the systems operate with an output power no greater than 125 mW. The system shall hop to channel frequencies that are selected at the system hopping rate from a pseudorandomly ordered list of hopping frequencies. Each frequency must be used equally on the average by each transmitter. The system receivers shall have input bandwidths that match the hopping channel bandwidths of their corresponding transmitters and shall shift frequencies in synchronization with the transmitted signals.

6.3. EUT Configuration on Measurement

The equipment are installed on the emission measurement to meet the commission requirements and operating regulations in a manner which tends to maximize its emission characteristics in normal application.

6.4. Operating Condition of EUT

6.4.1. Setup the EUT and simulator as shown as Section 6.1.

6.4.2. Turn on the power of all equipment.

6.4.3. Let the EUT work in TX (Hopping on) modes measure it. The transmit frequency are 2402-2480MHz. We select 2402MHz, 2441MHz, and 2480MHz TX frequency to transmit.

6.5. Test Procedure

6.5.1. The transmitter output was connected to the spectrum analyzer through a low loss cable.

6.5.2. Set RBW of spectrum analyzer to 30 kHz and VBW to 100 kHz. Adjust Span to 2 MHz.

6.5.3. Set the adjacent channel of the EUT maxhold another trace.

6.5.4. Measurement the channel separation

6.6. Test Result

GFSK

Channel	Frequency (MHz)	Channel Separation(MHz)	Limit (MHz)	Result
Low	2402	1.000	0.708	PASS
	2403			
Middle	2440	1.000	0.704	PASS
	2441			
High	2479	1.000	0.704	PASS
	2480			

Π/4-DQPSK

Channel	Frequency (MHz)	Channel Separation(MHz)	Limit (MHz)	Result
Low	2402	1.002	0.744	PASS
	2403			
Middle	2440	1.002	0.744	PASS
	2441			
High	2479	1.002	0.741	PASS
	2480			

8DPSK

Channel	Frequency (MHz)	Channel Separation(MHz)	Limit (MHz)	Result
Low	2402	1.000	0.744	PASS
	2403			
Middle	2440	1.002	0.776	PASS
	2441			
High	2479	1.002	0.776	PASS
	2480			

The spectrum analyzer plots are attached as below.

GFSK Mode

Low channel

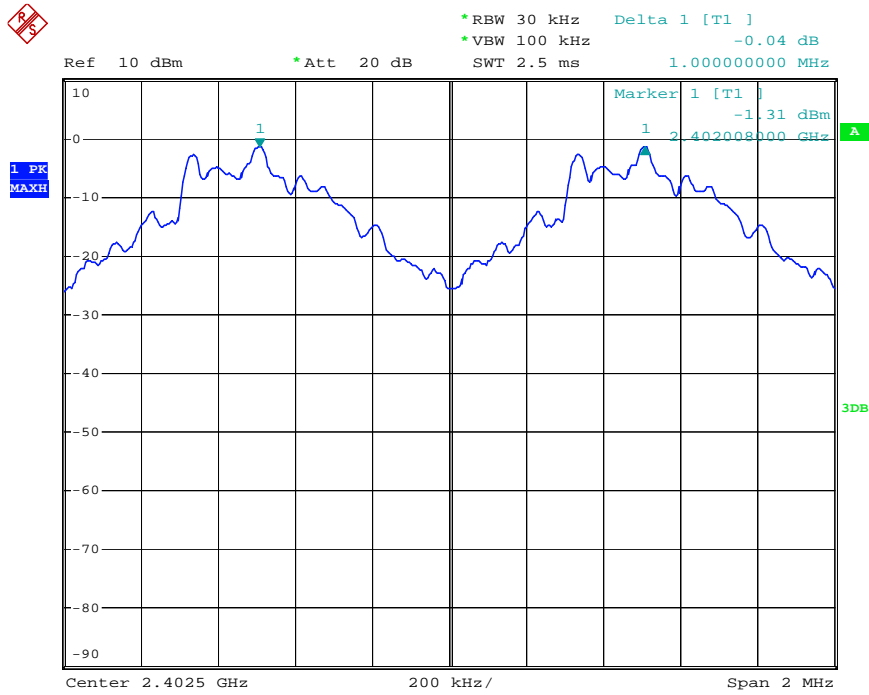

Middle channel

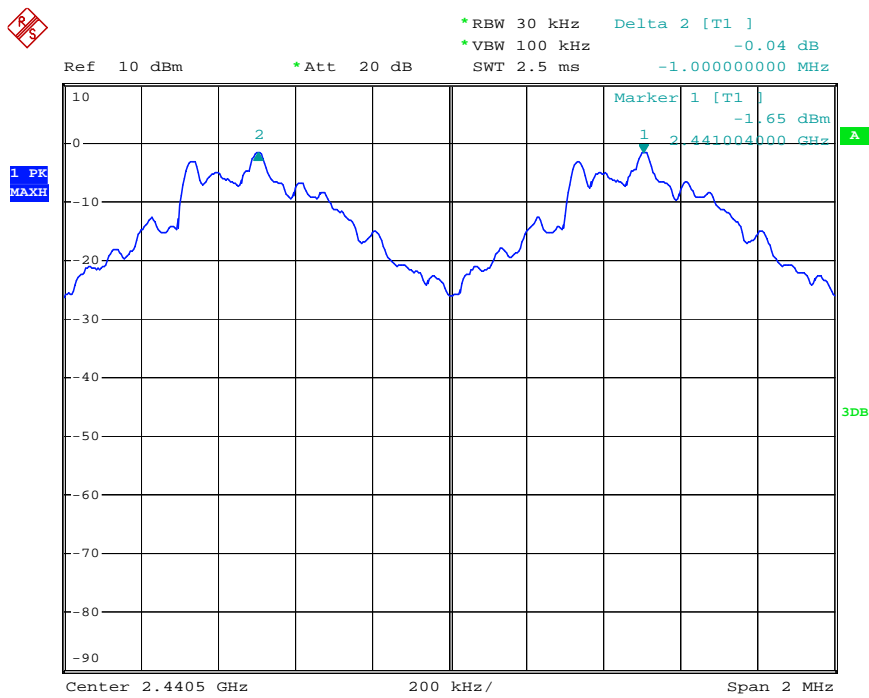

High channel

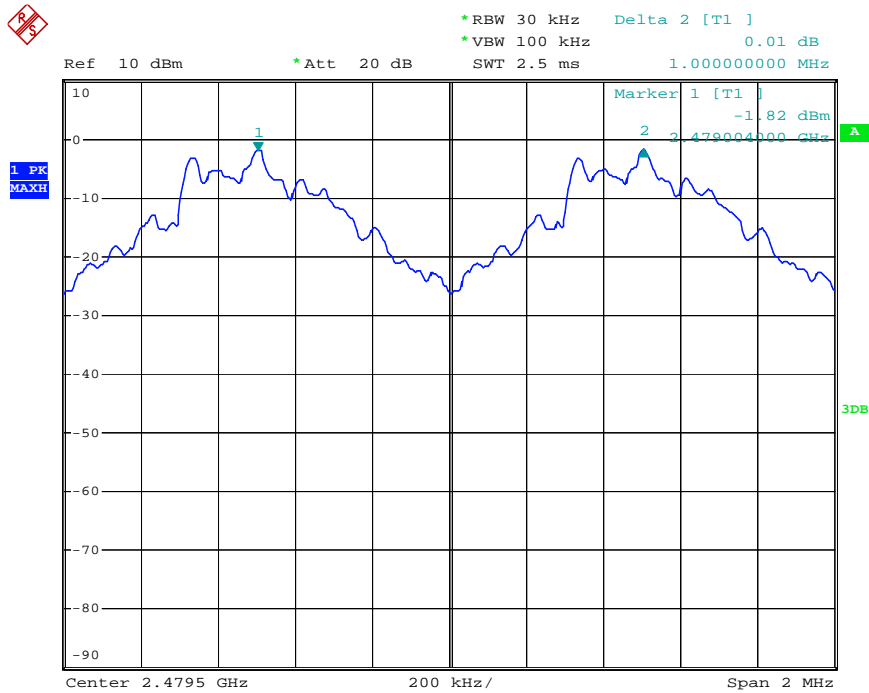

Π/4-DQPSK Mode

Low channel

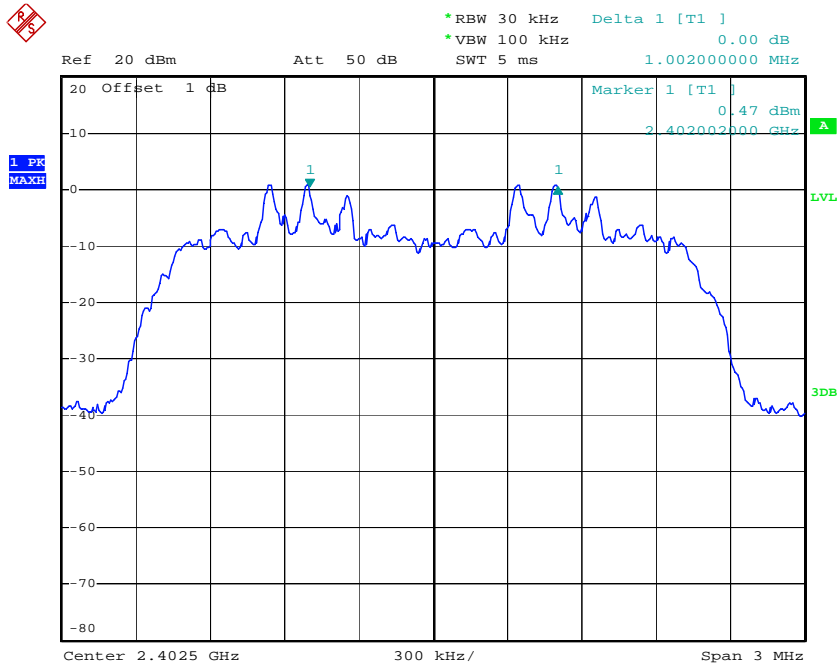

Middle channel

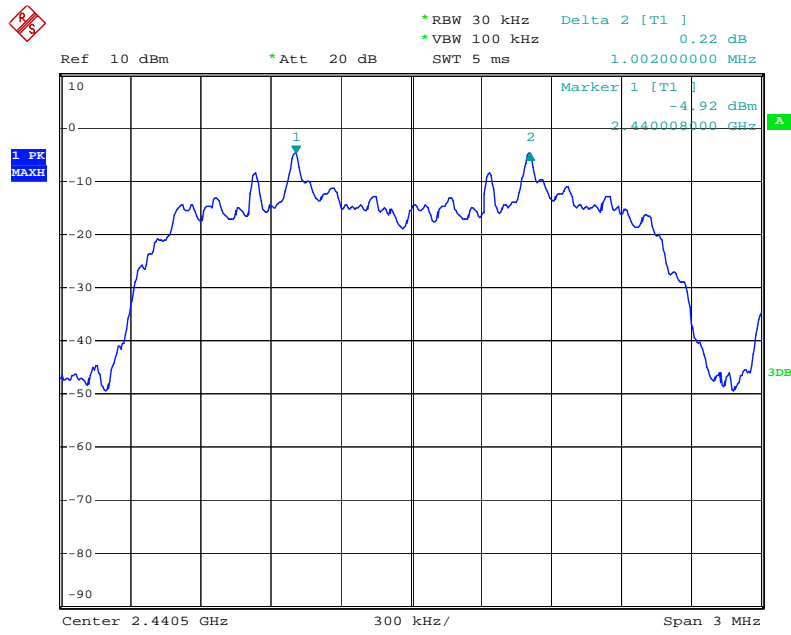

High channel

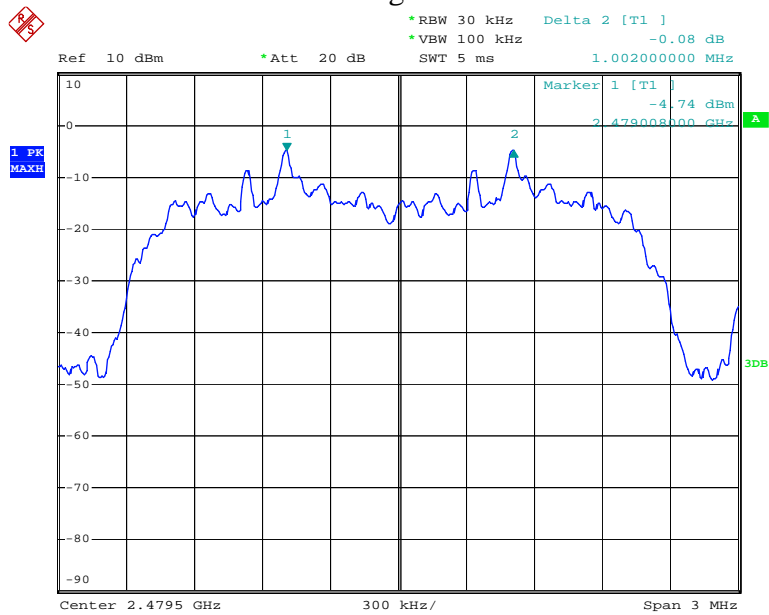

8DPSK Mode

Low channel

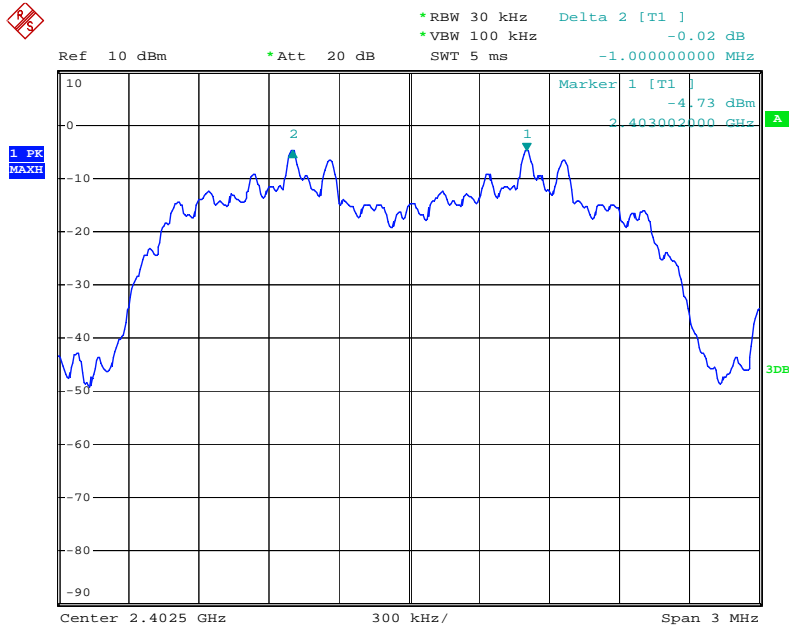

Middle channel

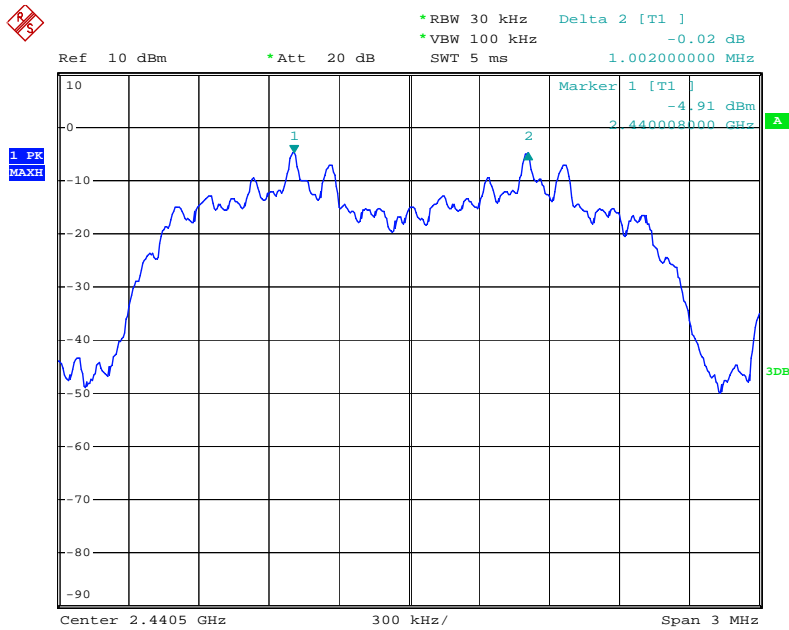

High channel

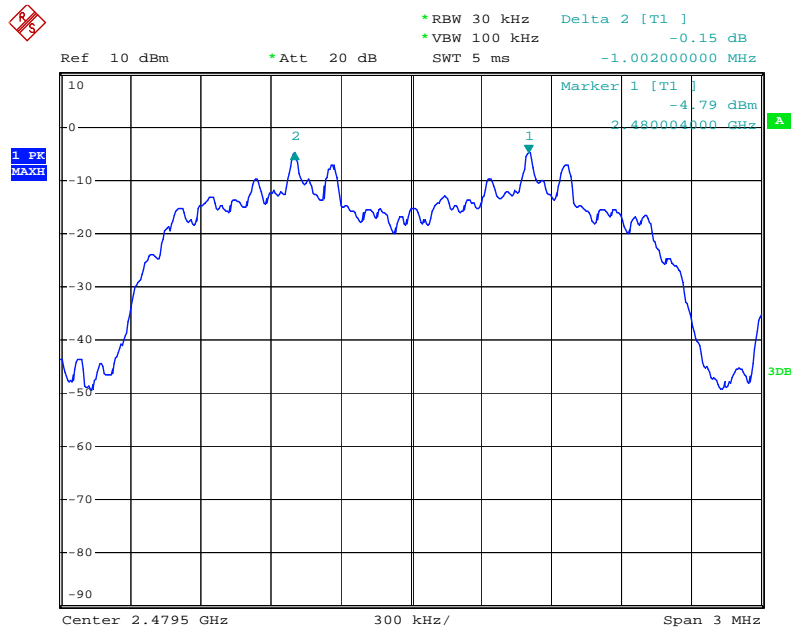

7. NUMBER OF HOPPING FREQUENCY TEST

7.1. Block Diagram of Test Setup

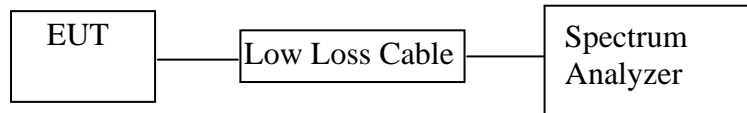

(EUT: Media box)

7.2. The Requirement For Section 15.247(a)(1)(iii)

Section 15.247(a)(1)(iii): Frequency hopping systems in the 2400-2483.5 MHz band shall use at least 15 channels.

7.3. EUT Configuration on Measurement

The equipment are installed on the emission measurement to meet the commission requirements and operating regulations in a manner which tends to maximize its emission characteristics in normal application.

7.4. Operating Condition of EUT

7.4.1. Setup the EUT and simulator as shown as Section 7.1.

7.4.2. Turn on the power of all equipment.

7.4.3. Let the EUT work in TX (Hopping on) modes measure it.

7.5. Test Procedure

7.5.1. The transmitter output was connected to the spectrum analyzer through a low loss cable.

7.5.2. Set the spectrum analyzer as Span=83.5MHz, RBW=100 kHz, VBW=300 kHz.

7.5.3. Max hold, view and count how many channel in the band.

7.6. Test Result

Total number of hopping channel	Measurement result(CH)	Limit(CH)
		79

The spectrum analyzer plots are attached as below.

Number of hopping channels(GFSK)

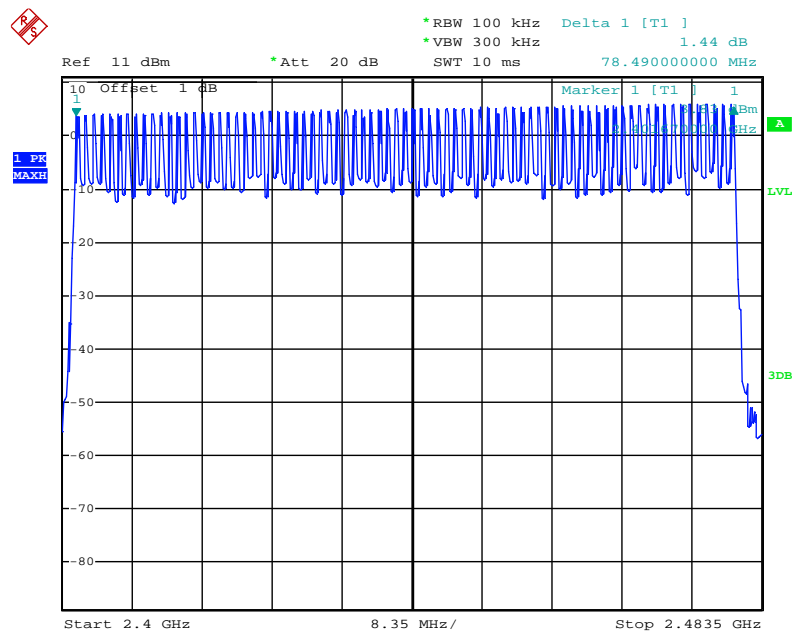

Number of hopping channels($\Pi/4$ -DQPSK)

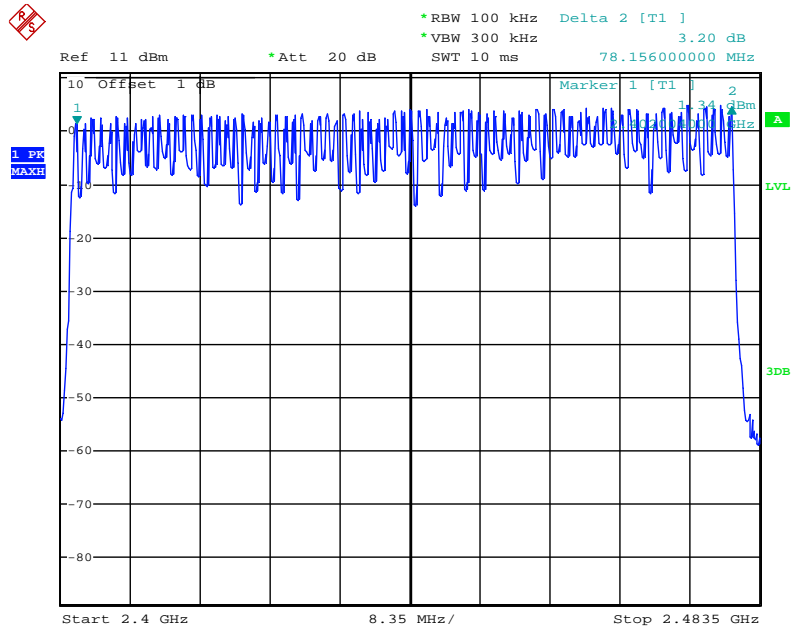

Number of hopping channels(8DPSK)

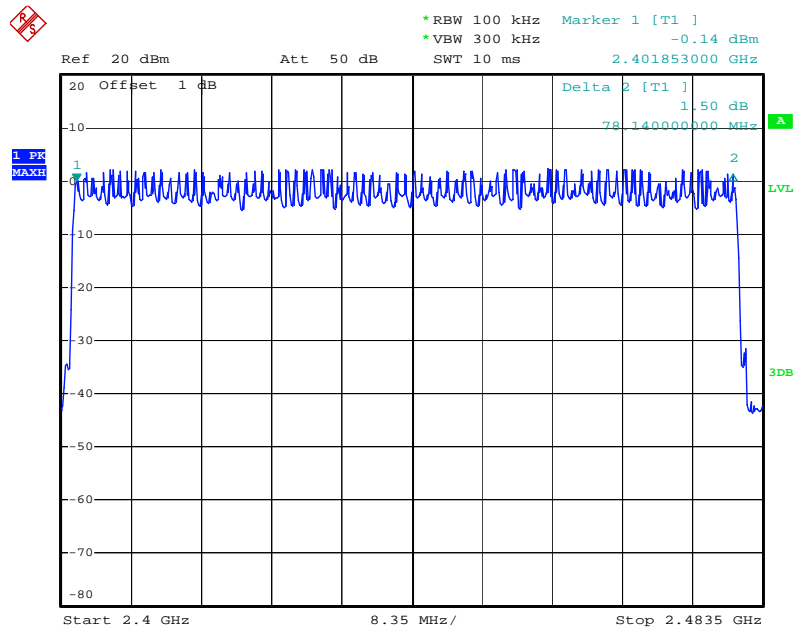

8. DWELL TIME TEST

8.1. Block Diagram of Test Setup

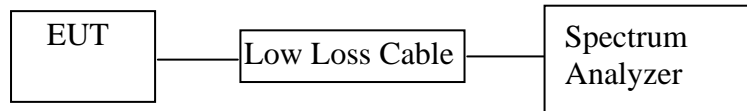

(EUT: Media box)

8.2. The Requirement For Section 15.247(a)(1)(iii)

Section 15.247(a)(1)(iii): Frequency hopping systems in the 2400-2483.5 MHz band shall use at least 15 channels. The average time of occupancy on any channel shall not be greater than 0.4 seconds within a period of 0.4 seconds multiplied by the number of hopping channels employed. Frequency hopping systems may avoid or suppress transmissions on a particular hopping frequency provided that a minimum of 15 channels are used.

8.3. EUT Configuration on Measurement

The equipment are installed on the emission measurement to meet the commission requirements and operating regulations in a manner which tends to maximize its emission characteristics in normal application.

8.4. Operating Condition of EUT

8.4.1. Setup the EUT and simulator as shown as Section 8.1.

8.4.2. Turn on the power of all equipment.

8.4.3. Let the EUT work in TX (Hopping on) modes measure it. The transmit frequency are 2402-2480MHz. We select 2402MHz, 2441MHz, and 2480MHz TX frequency to transmit.

8.5. Test Procedure

8.5.1. The transmitter output was connected to the spectrum analyzer through a low loss cable.

8.5.2. Set center frequency of spectrum analyzer = operating frequency.

8.5.3. Set the spectrum analyzer as RBW=1MHz, VBW=3MHz, Span=0Hz, Adjust Sweep=5ms, 10ms, 15ms. Get the pulse time.

8.5.4.Repeat above procedures until all frequency measured were complete.

8.6.Test Result

GFSK Mode

Mode	Channel Frequency (MHz)	Pulse Time (ms)	Dwell Time (ms)	Limit (ms)
DH1	2402	0.415	132.80	400
	2441	0.410	131.20	400
	2480	0.415	132.80	400
A period transmit time = $0.4 \times 79 = 31.6$ Dwell time = pulse time $\times (1600/(2*79)) \times 31.6$				
DH3	2402	1.680	268.80	400
	2441	1.695	271.20	400
	2480	1.680	268.80	400
A period transmit time = $0.4 \times 79 = 31.6$ Dwell time = pulse time $\times (1600/(4*79)) \times 31.6$				
DH5	2402	2.960	315.73	400
	2441	2.960	315.73	400
	2480	2.960	315.73	400
A period transmit time = $0.4 \times 79 = 31.6$ Dwell time = pulse time $\times (1600/(6*79)) \times 31.6$				

$\Pi/4$ -DQPSK

Mode	Channel Frequency (MHz)	Pulse Time (ms)	Dwell Time (ms)	Limit (ms)
2DH1	2402	0.415	132.80	400
	2441	0.420	134.40	400
	2480	0.420	134.40	400
A period transmit time = $0.4 \times 79 = 31.6$ Dwell time = pulse time $\times (1600/(2*79)) \times 31.6$				
2DH3	2402	1.695	271.20	400
	2441	1.695	271.20	400
	2480	1.695	271.20	400
A period transmit time = $0.4 \times 79 = 31.6$ Dwell time = pulse time $\times (1600/(4*79)) \times 31.6$				
2DH5	2402	2.960	315.73	400
	2441	2.960	315.73	400
	2480	2.960	315.73	400
A period transmit time = $0.4 \times 79 = 31.6$ Dwell time = pulse time $\times (1600/(6*79)) \times 31.6$				

8DPSK Mode

Mode	Channel Frequency (MHz)	Pulse Time (ms)	Dwell Time (ms)	Limit (ms)
3DH1	2402	0.420	134.40	400
	2441	0.420	134.40	400
	2480	0.420	134.40	400
A period transmit time = $0.4 \times 79 = 31.6$ Dwell time = pulse time $\times (1600/(2*79)) \times 31.6$				
3DH3	2402	1.680	268.80	400
	2441	1.680	268.80	400
	2480	1.695	271.20	400
A period transmit time = $0.4 \times 79 = 31.6$ Dwell time = pulse time $\times (1600/(4*79)) \times 31.6$				
3DH5	2402	2.960	315.73	400
	2441	2.960	315.73	400
	2480	2.960	315.73	400
A period transmit time = $0.4 \times 79 = 31.6$ Dwell time = pulse time $\times (1600/(6*79)) \times 31.6$				

The spectrum analyzer plots are attached as below.

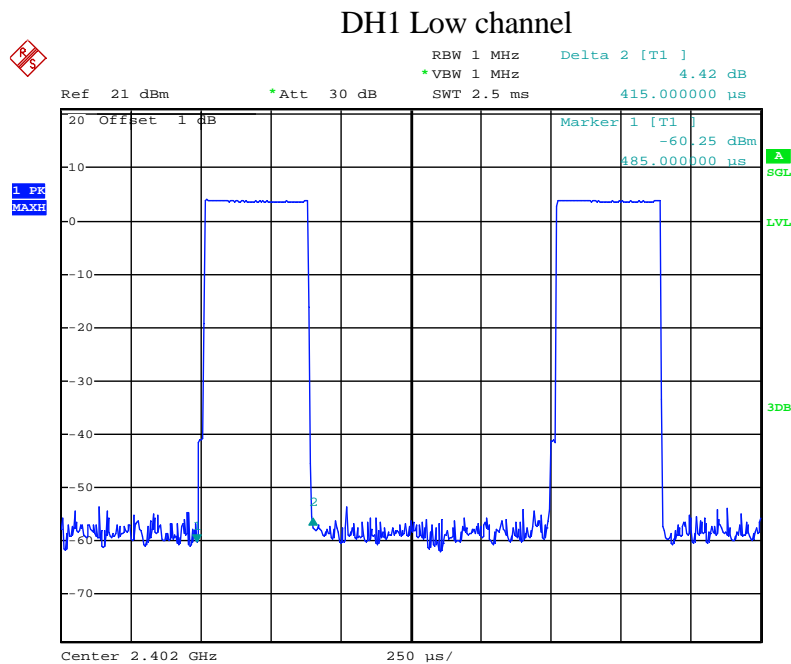

DH1 Middle channel

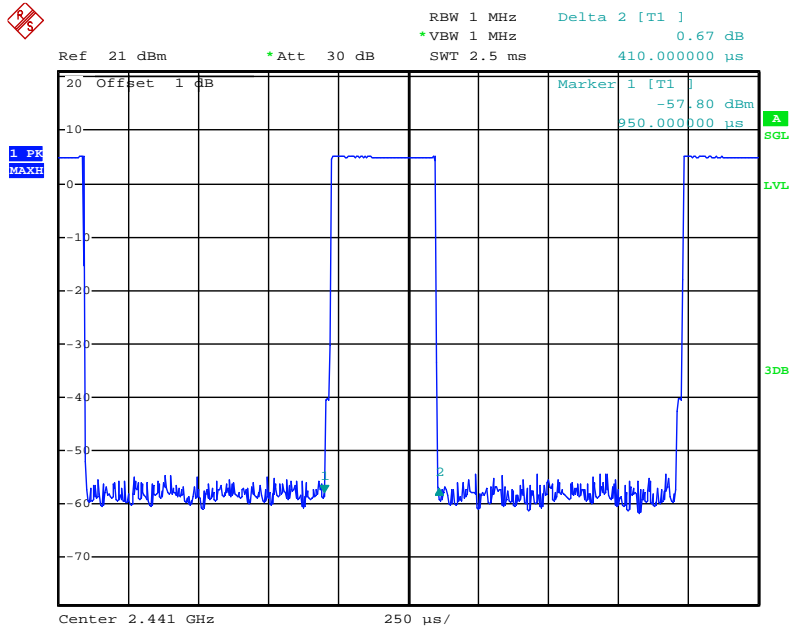

DH1 High channel

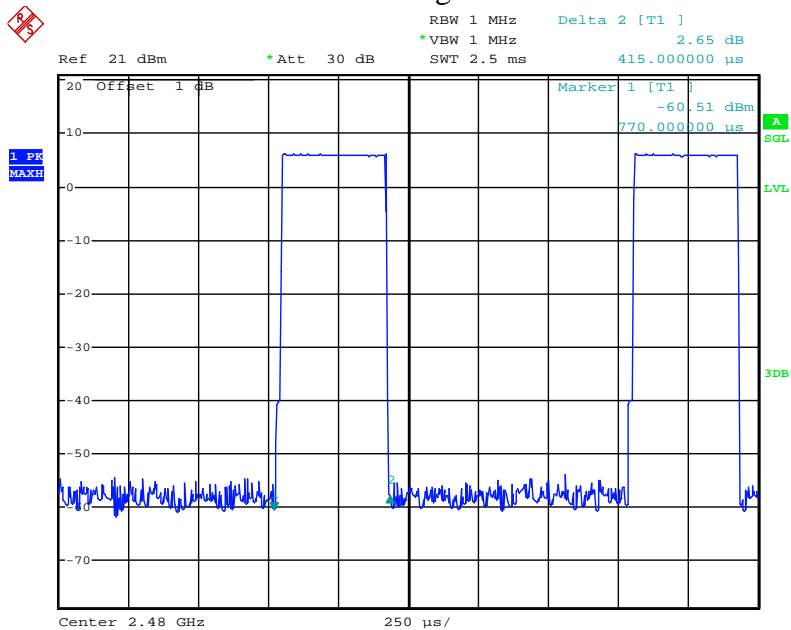

DH3 Low channel

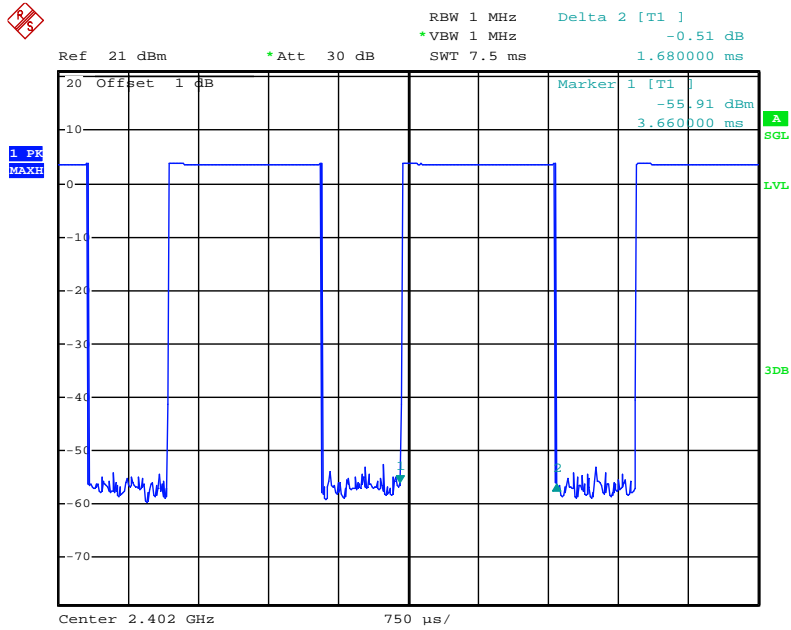

DH3 Middle channel

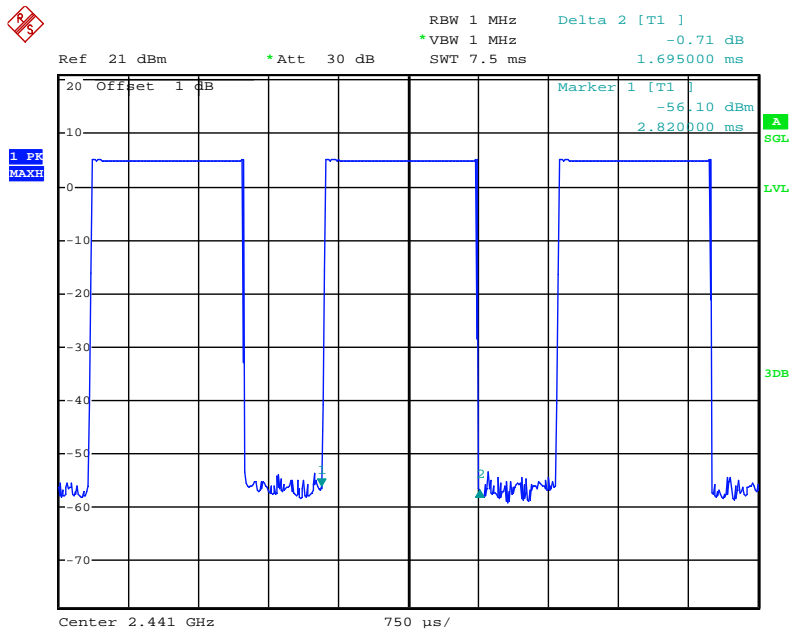

DH3 High channel

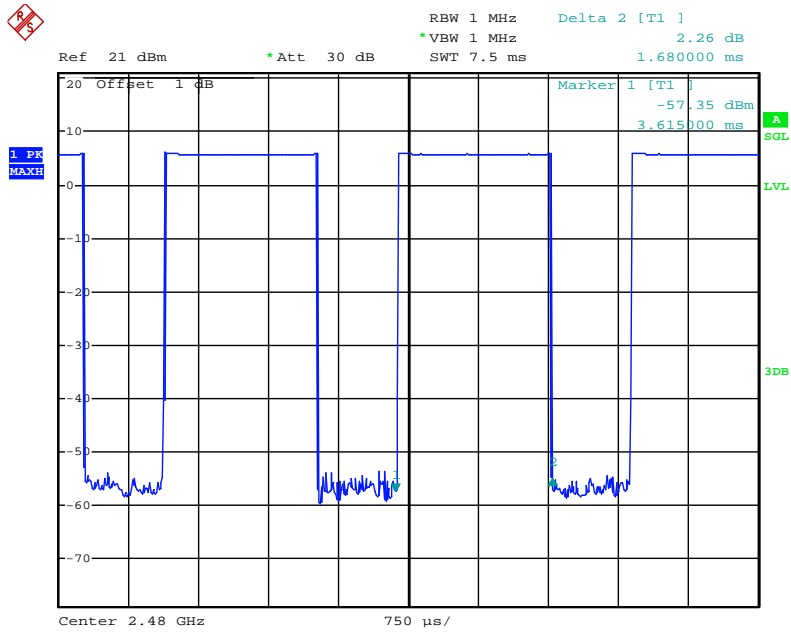

DH5 Low channel

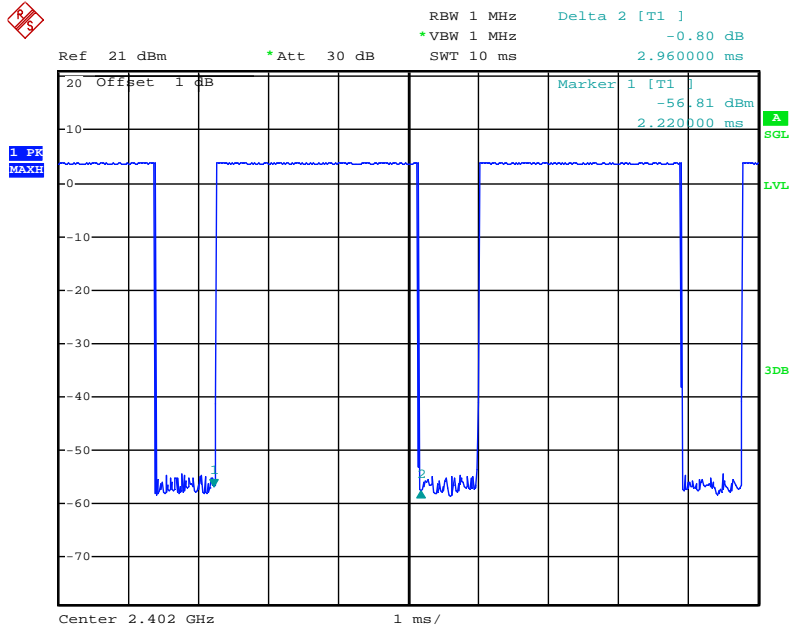

DH5 Middle channel

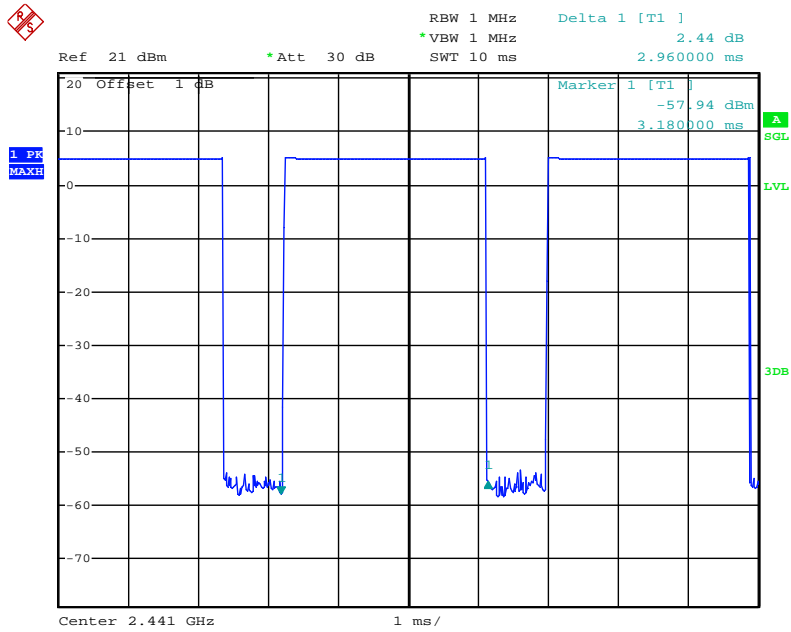

DH5 High channel

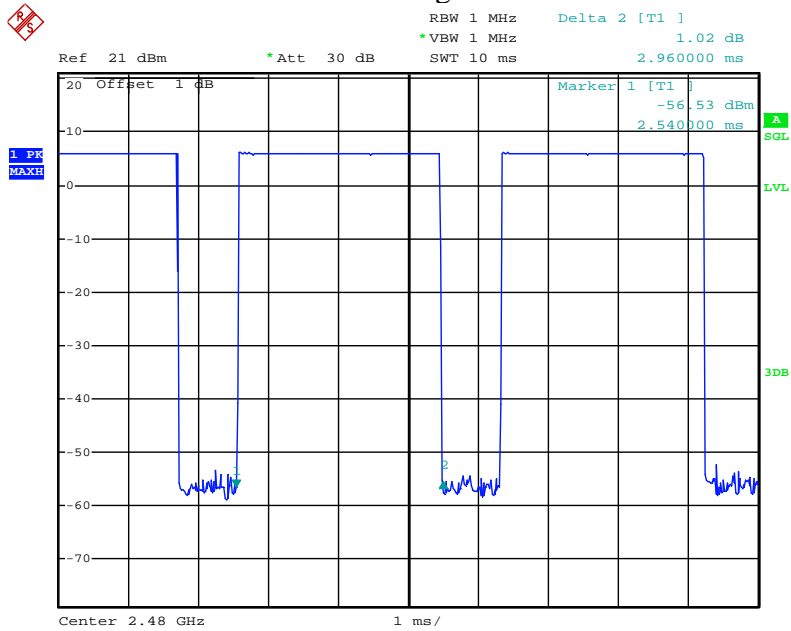

Mode 2: $\pi/4$ DQPSK Mode

2DH1 Low channel

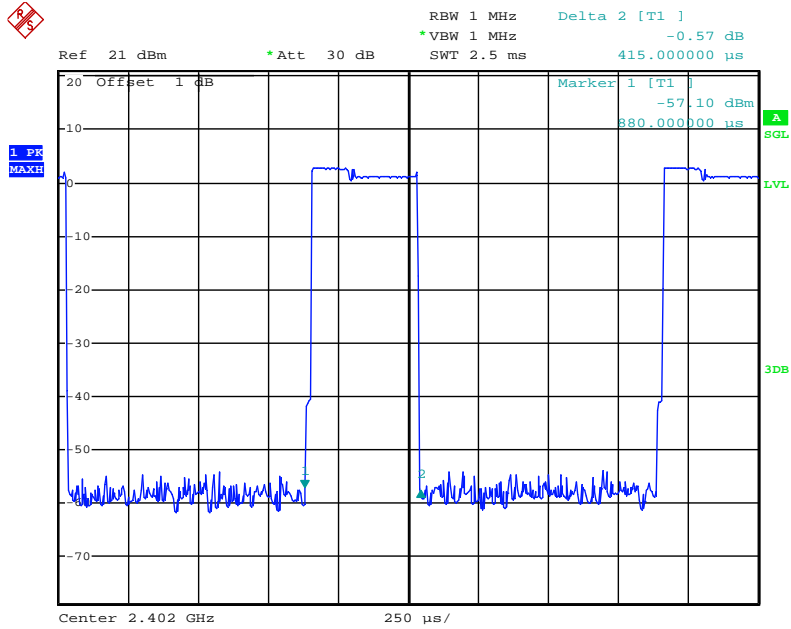

2DH1 Middle channel

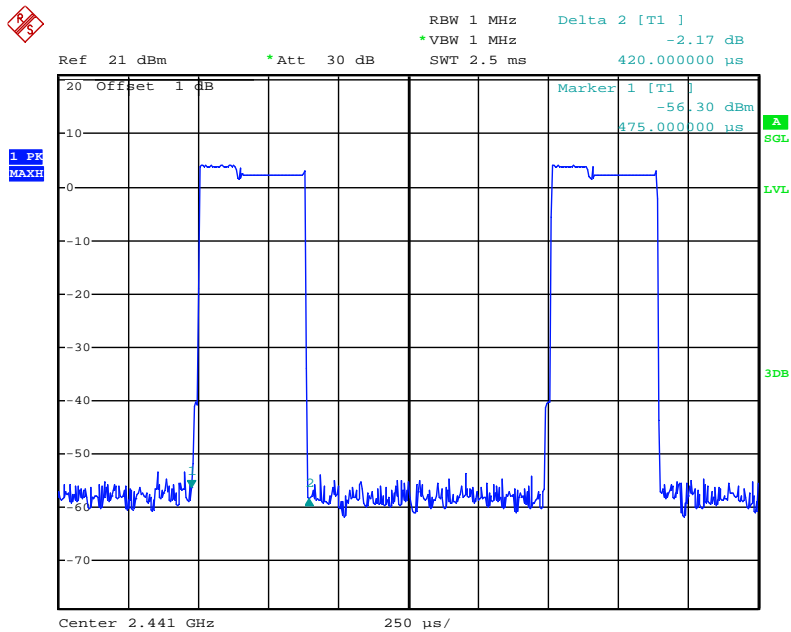

2DH1 High channel

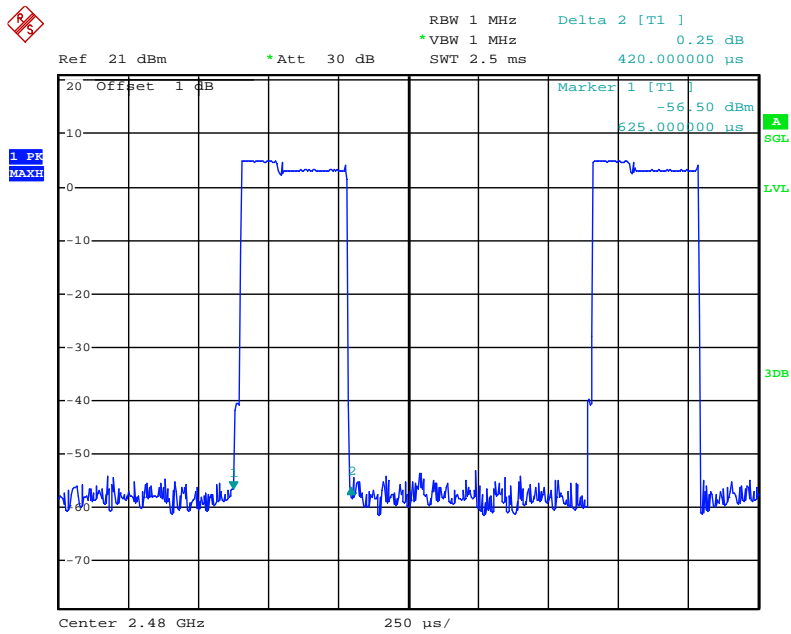

2DH3 Low channel

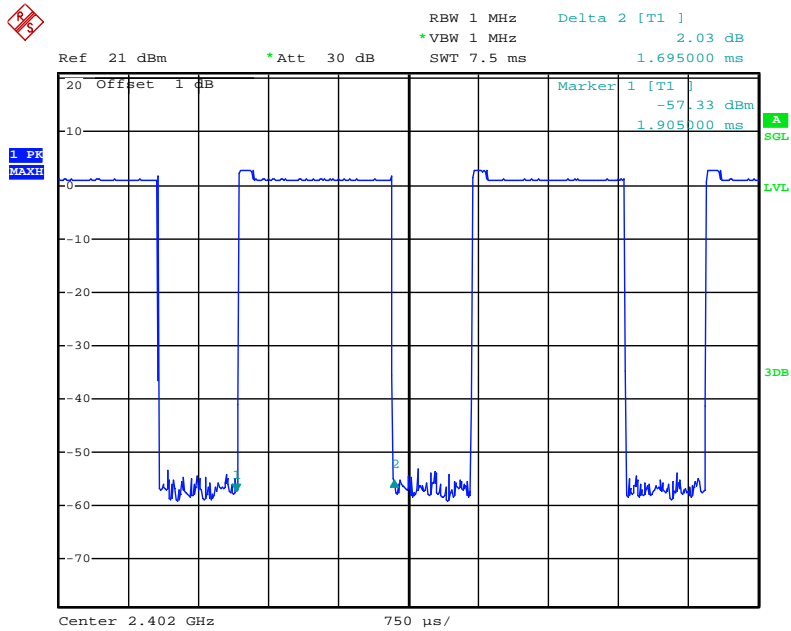

2DH3 Middle channel

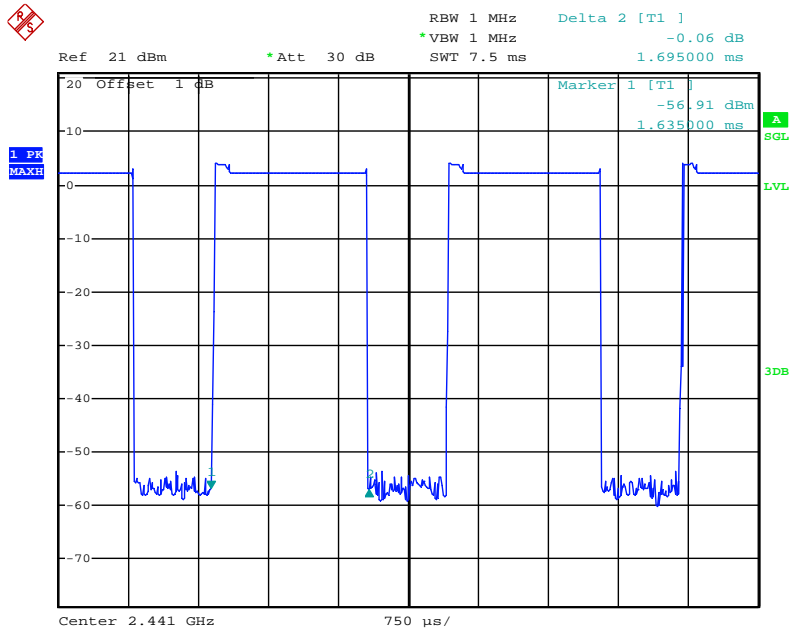

2DH3 High channel

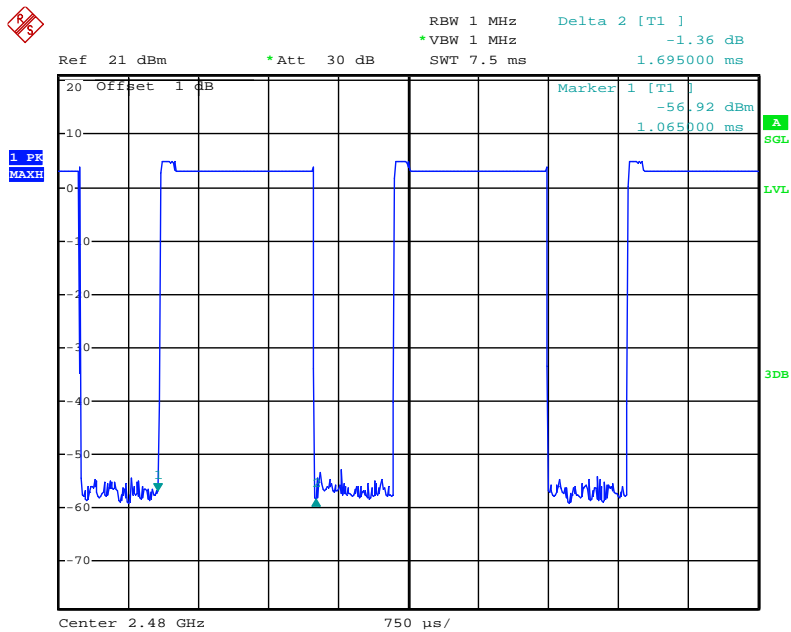

2DH5 Low channel

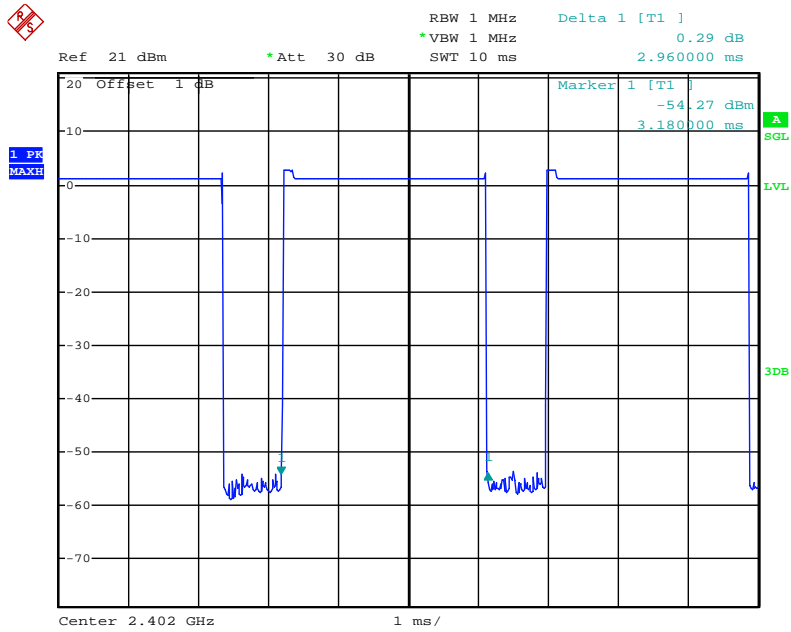

2DH5 Middle channel

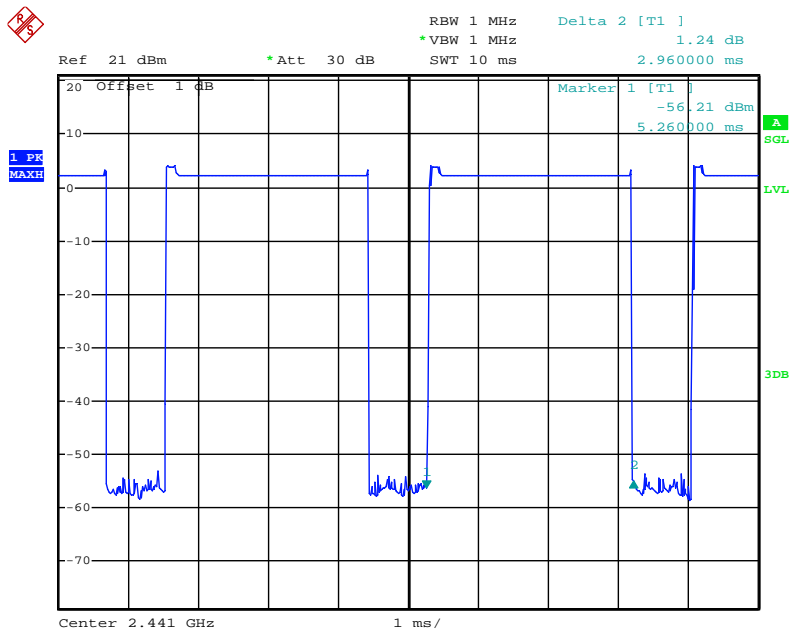

2DH5 High channel

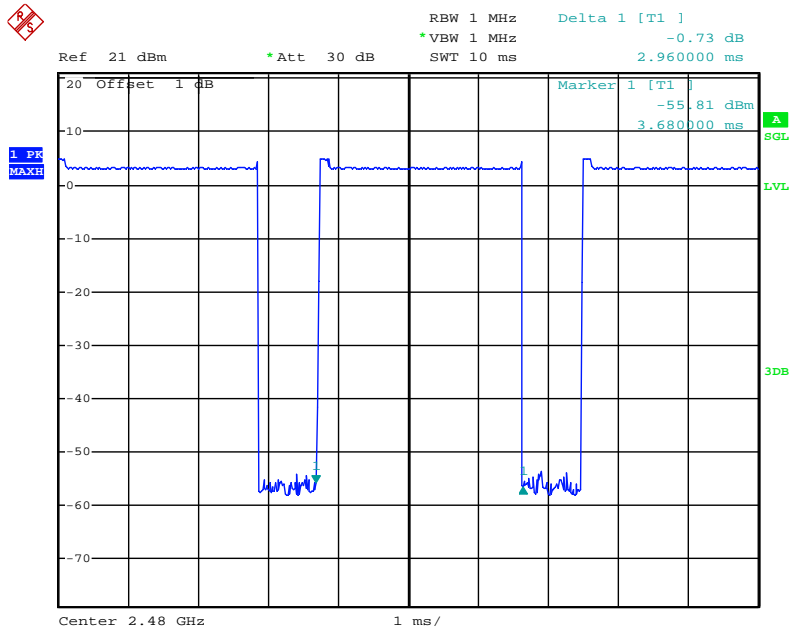

Mode 3: 8DPSK Mode

3DH1 Low channel

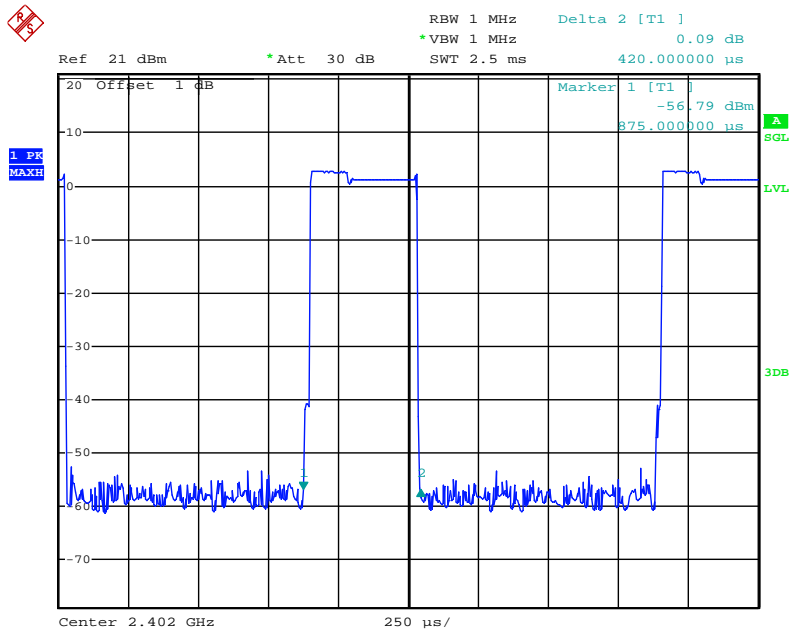

3DH1 Middle channel

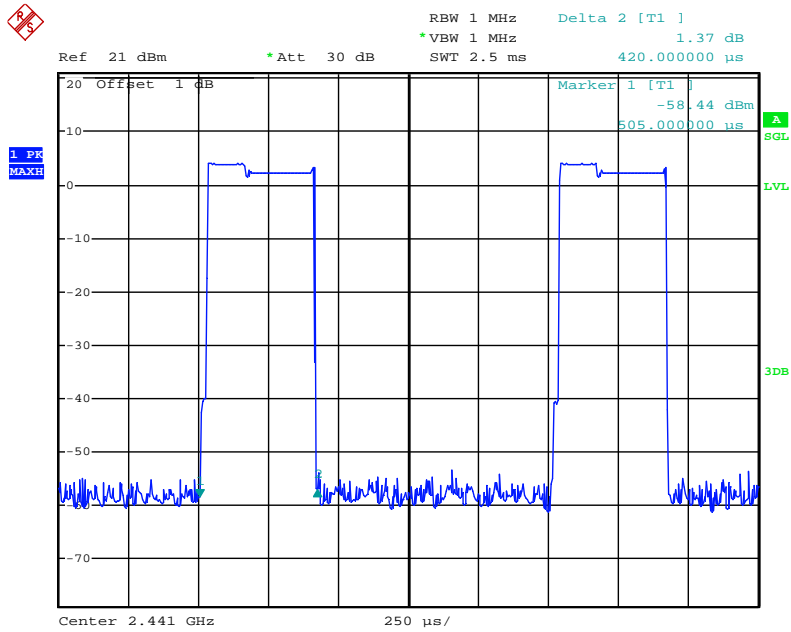

3DH1 High channel

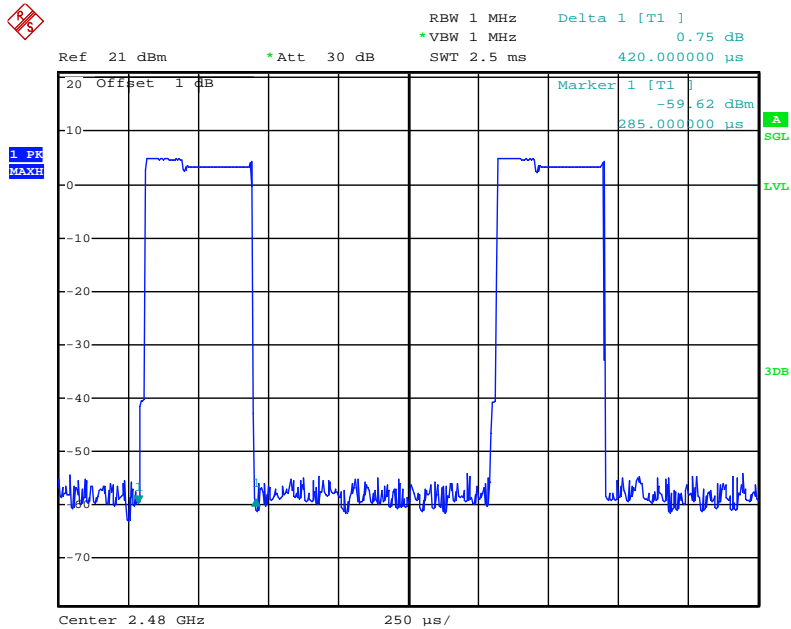

3DH3 Low channel

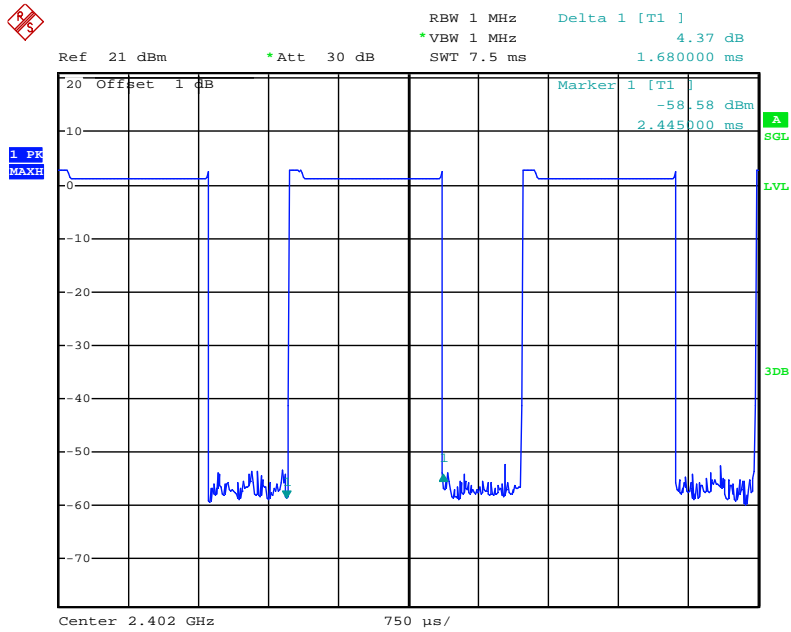

3DH3 Middle channel

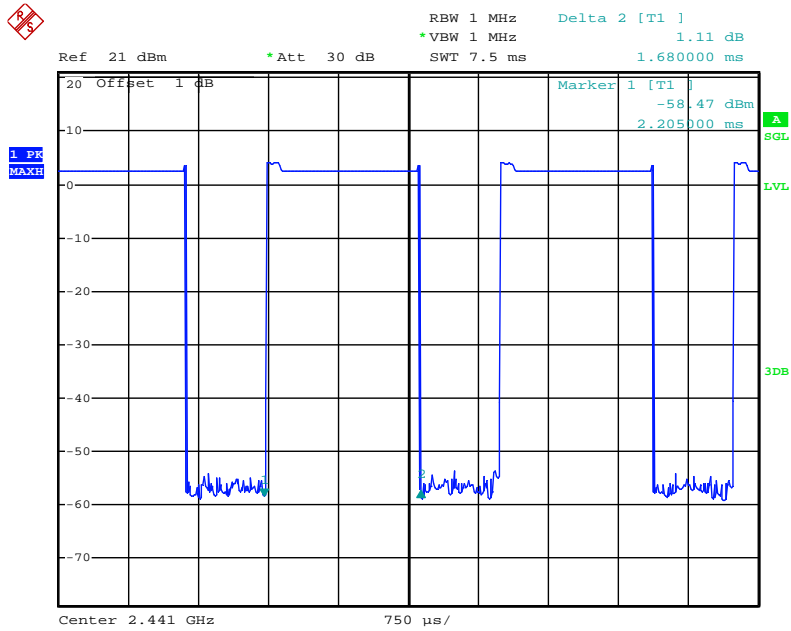

3DH3 High channel

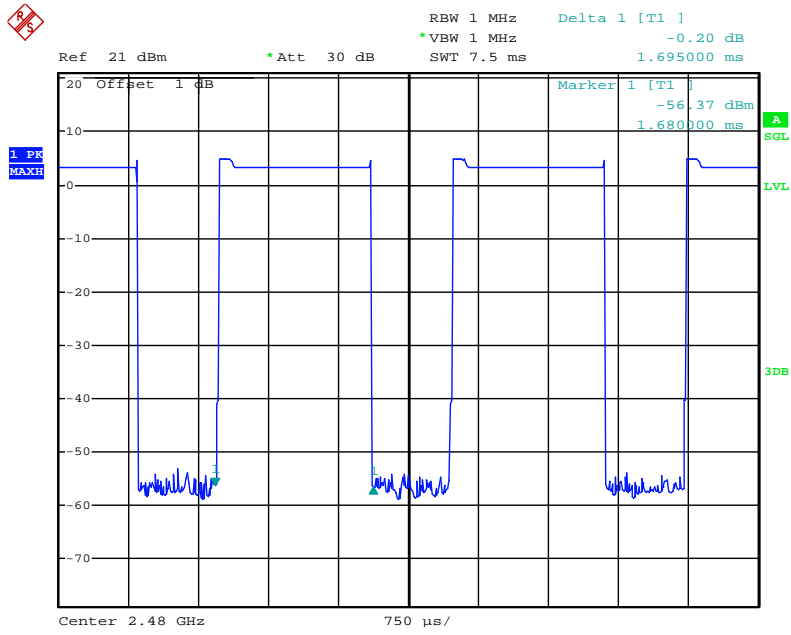

3DH5 Low channel

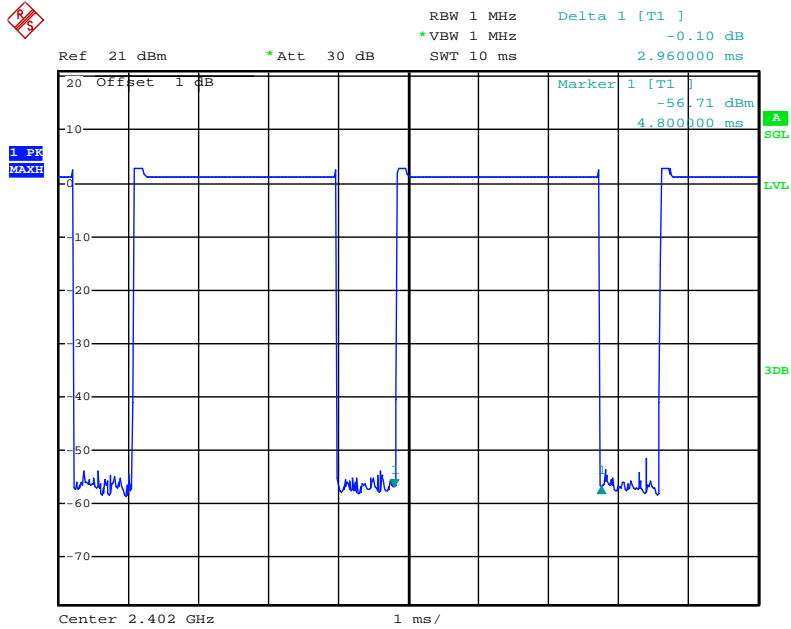

3DH5 Middle channel

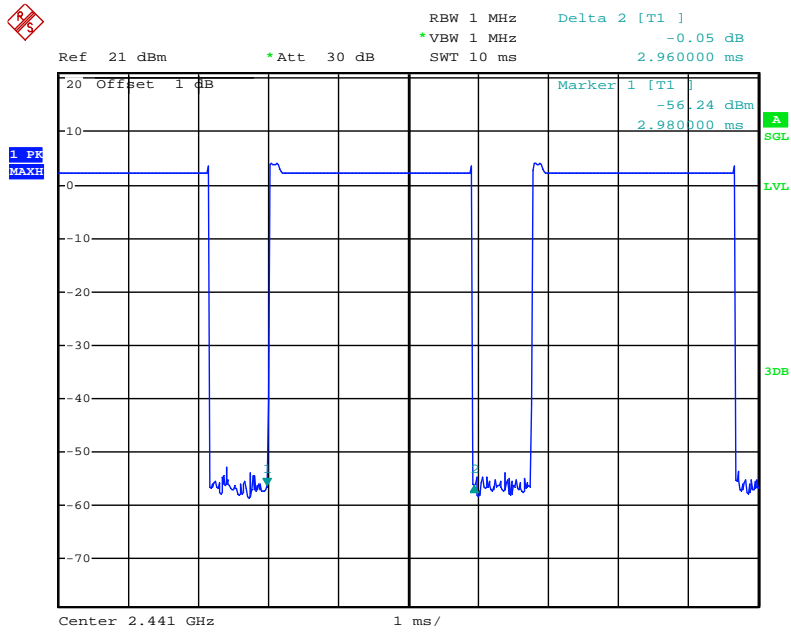

3DH5 High channel

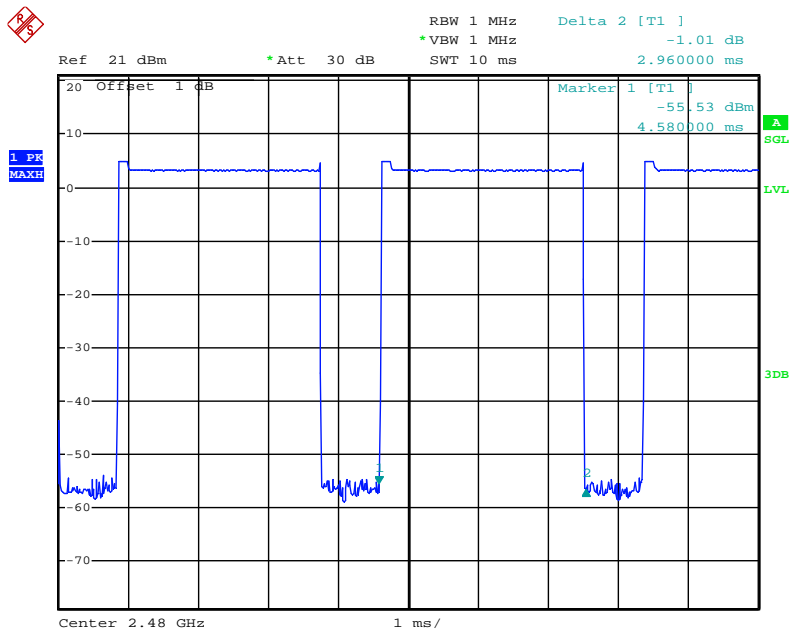

9. MAXIMUM PEAK OUTPUT POWER TEST

9.1. Block Diagram of Test Setup

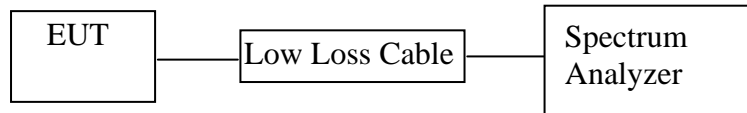

(EUT: Media box)

9.2. The Requirement For Section 15.247(b)(1)

Section 15.247(b)(1): For frequency hopping systems operating in the 2400-2483.5 MHz band employing at least 75 non-overlapping hopping channels, and all frequency hopping systems in the 5725-5850 MHz band: 1 watt. For all other frequency hopping systems in the 2400-2483.5 MHz band: 0.125 watts.

9.3. EUT Configuration on Measurement

The equipment are installed on the emission Measurement to meet the commission requirements and operating regulations in a manner which tends to maximize its emission characteristics in normal application.

9.4. Operating Condition of EUT

9.4.1. Setup the EUT and simulator as shown as Section 9.1.

9.4.2. Turn on the power of all equipment.

9.4.3. Let the EUT work in TX (Hopping off) modes measure it. The transmit frequency are 2402-2480MHz. We select 2402MHz, 2441MHz, and 2480MHz TX frequency to transmit.

9.5. Test Procedure

9.5.1. The transmitter output was connected to the spectrum analyzer through a low loss cable.

9.5.2. Set RBW of spectrum analyzer to 1MHz and VBW to 3MHz for GFSK mode

9.5.3. Set RBW of spectrum analyzer to 3MHz and VBW to 3MHz for other mode

9.5.4. Measurement the maximum peak output power.

9.6. Test Result

GFSK Mode

Channel	Frequency (MHz)	Peak Output Power(dBm)	Peak Output Power(mW)	Limits dBm / W
Low	2402	3.61	2.30	30/1.0
Middle	2441	2.48	1.77	30/1.0
High	2480	2.43	1.75	30/1.0

Π/4-DQPSK Mode

Channel	Frequency (MHz)	Peak Output Power(dBm)	Peak Output Power(mW)	Limits dBm / W
Low	2402	2.33	1.71	21 / 0.125
Middle	2441	1.64	1.46	21 / 0.125
High	2480	2.43	1.75	21 / 0.125

8DPSK Mode

Channel	Frequency (MHz)	Peak Output Power(dBm)	Peak Output Power(mW)	Limits dBm / W
Low	2402	2.42	1.75	21 / 0.125
Middle	2441	1.72	1.49	21 / 0.125
High	2480	3.53	2.25	21 / 0.125

The spectrum analyzer plots are attached as below.

GFSK Mode

Low channel

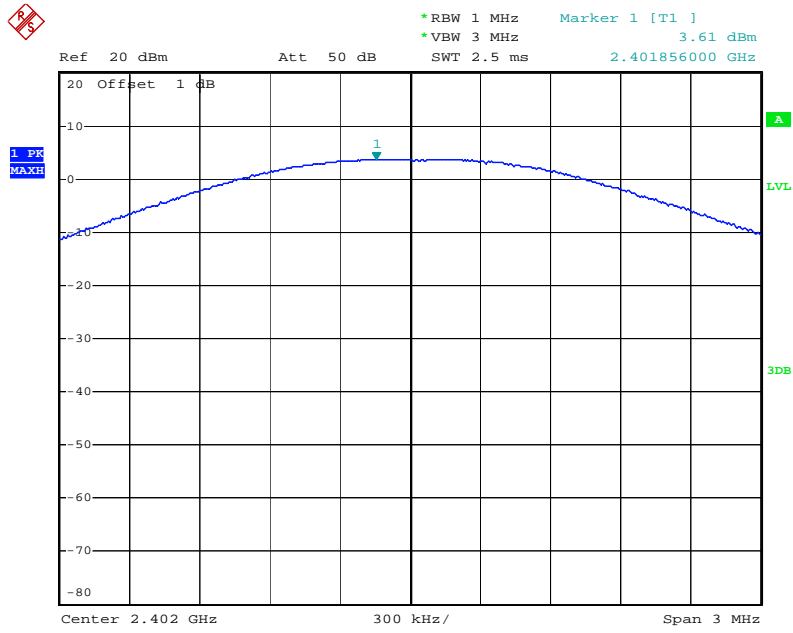

Middle channel

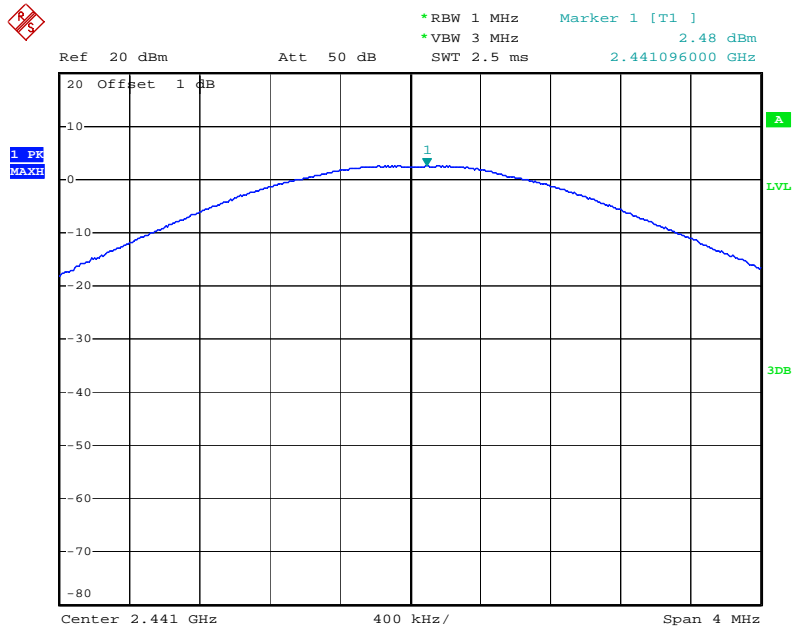

High channel

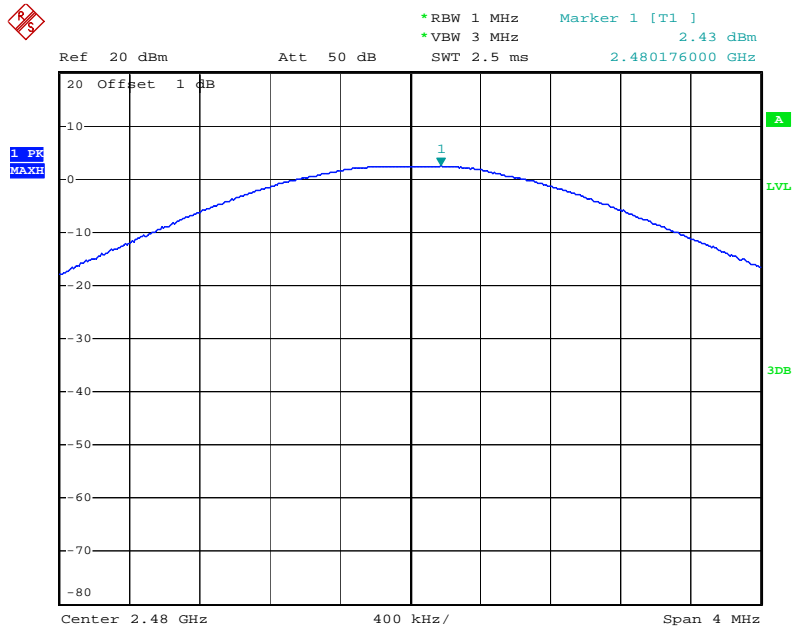

Π/4-DQPSK Mode

Low channel

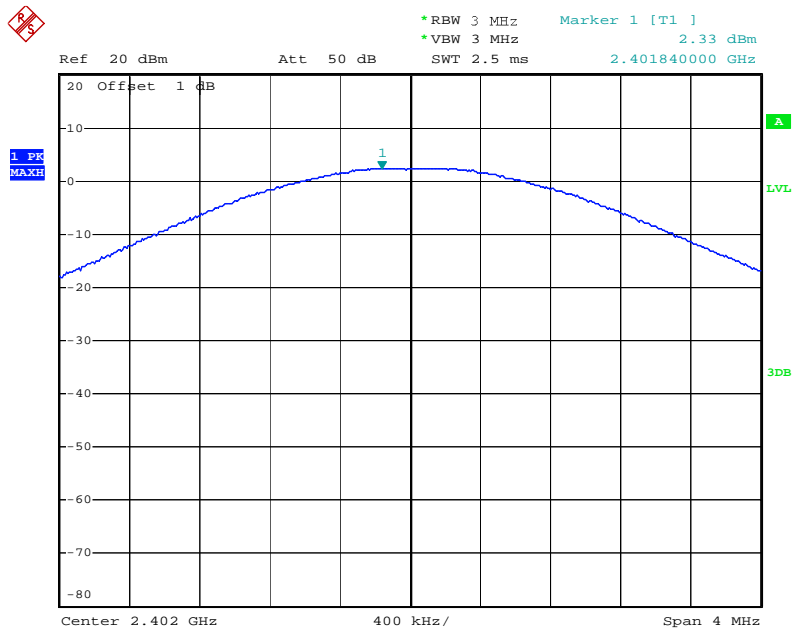

Middle channel

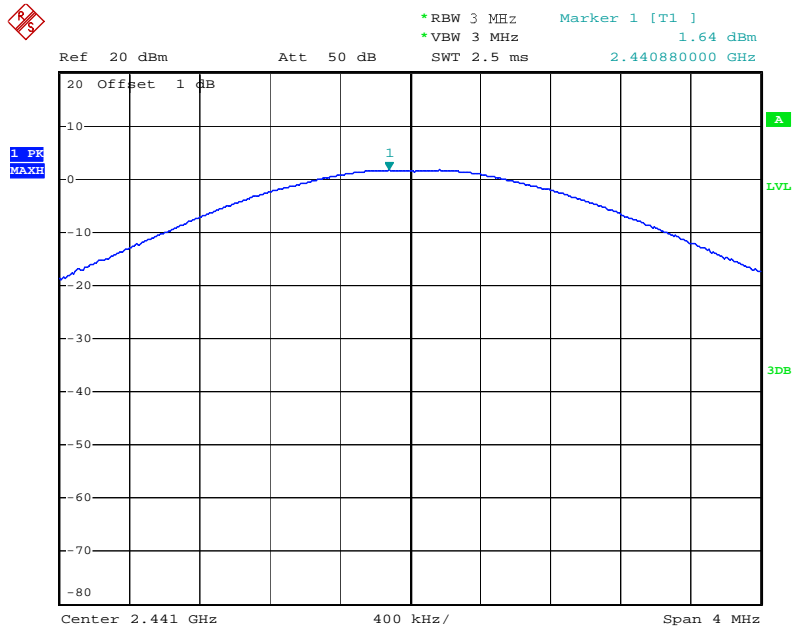

High channel

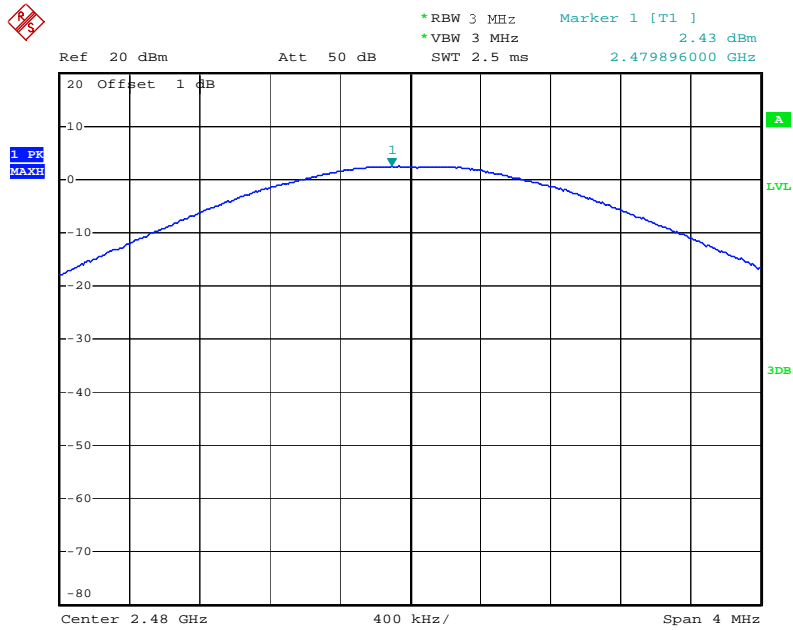

8DPSK Mode

Low channel

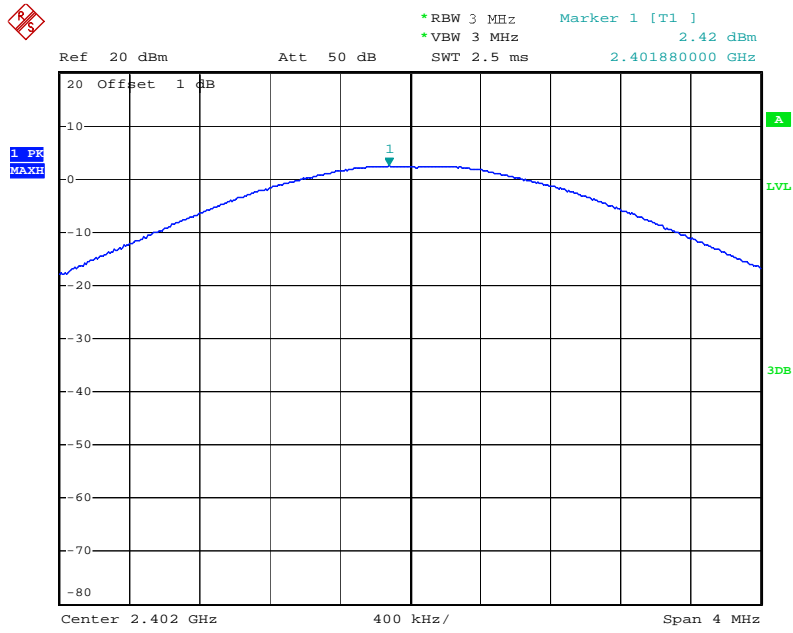

Middle channel

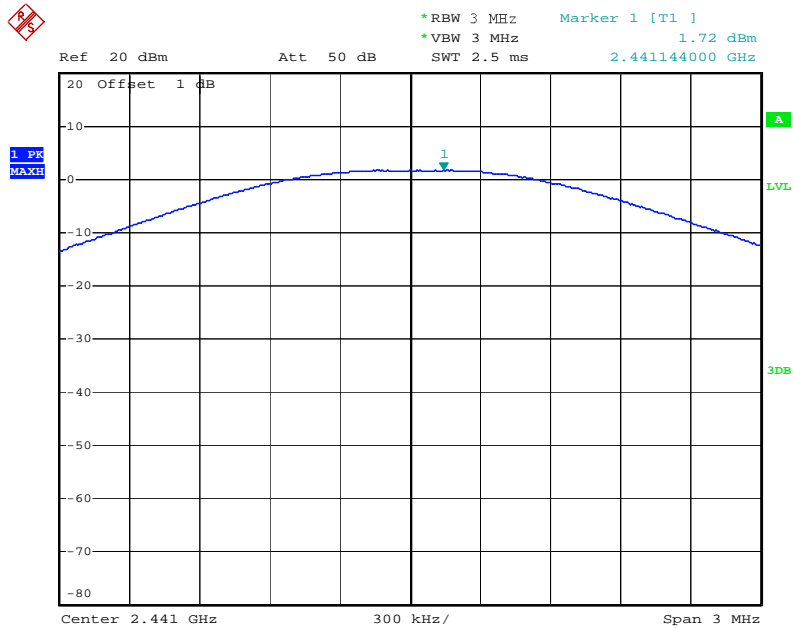

High channel

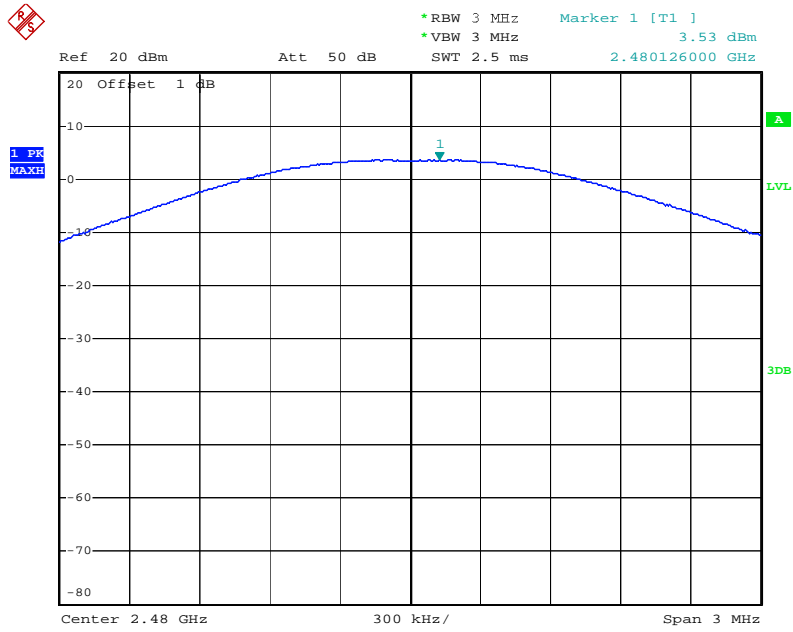

10. RADIATED EMISSION TEST

10.1. Block Diagram of Test Setup

10.1.1. Block diagram of connection between the EUT and peripherals

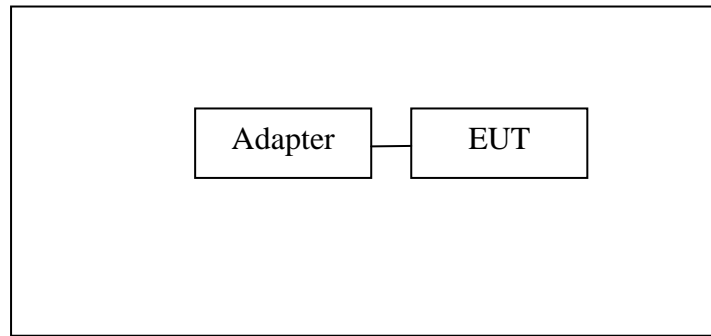

Setup: Transmitting mode

(EUT: Media box)

10.1.2. Semi-Anechoic Chamber Test Setup Diagram

(A) Radiated Emission Test Set-Up, Frequency below 30MHz

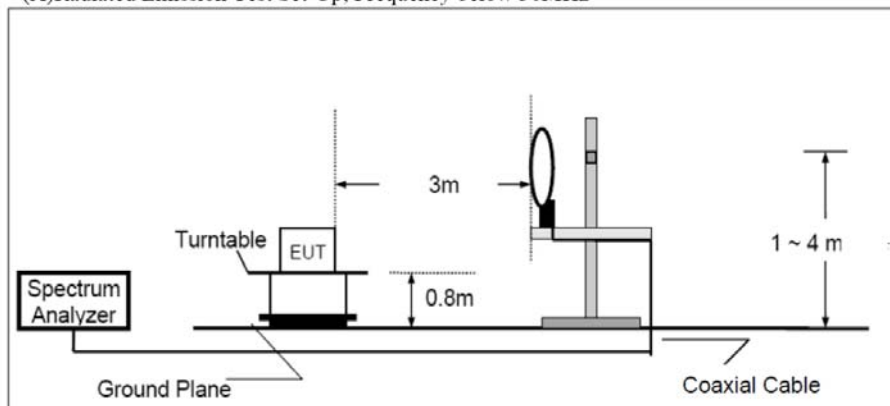

(B) Radiated Emission Test Set-Up, Frequency 30-1000MHz

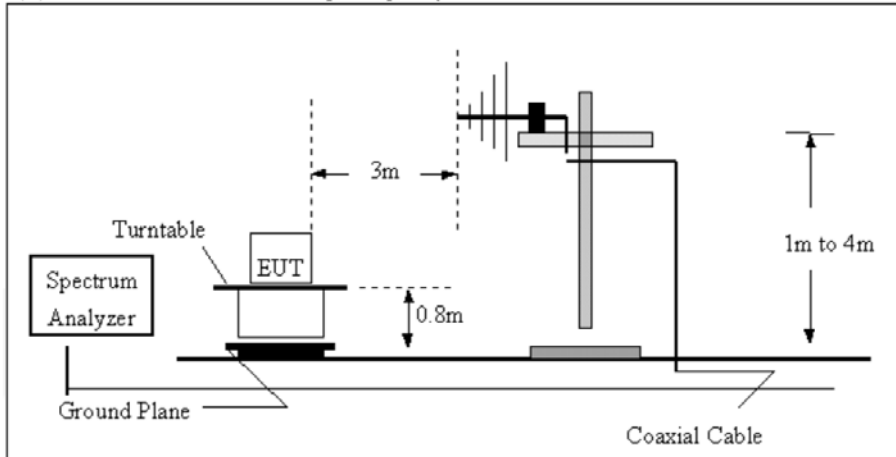

(C) Radiated Emission Test Set-Up, Frequency above 1GHz

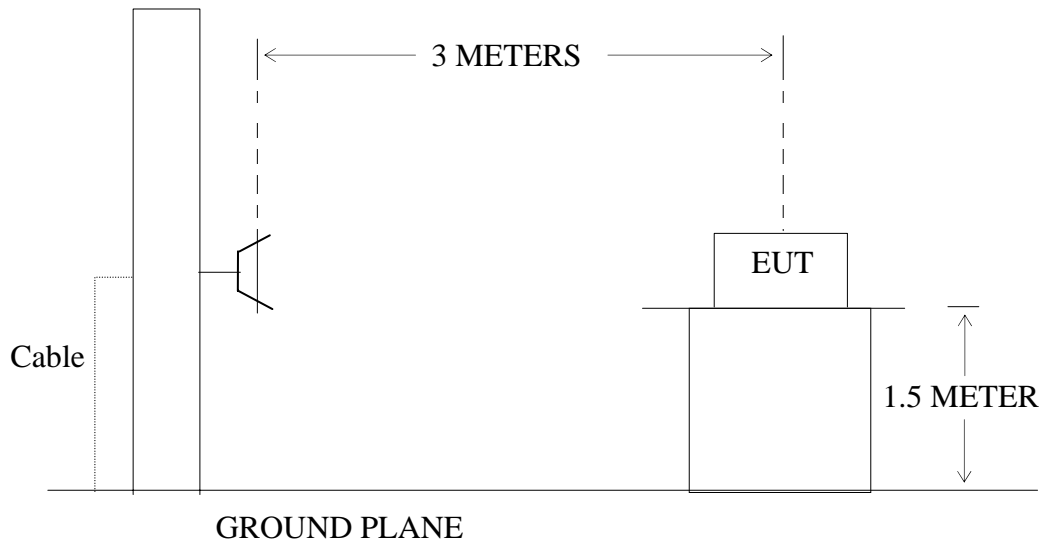

10.2. The Limit For Section 15.247(d)

Section 15.247(d): In any 100 kHz bandwidth outside the frequency band in which the spread spectrum or digitally modulated intentional radiator is operating, the radio frequency power that is produced by the intentional radiator shall be at least 20 dB below that in the 100 kHz bandwidth within the band that contains the highest level of the desired power, based on either an RF conducted or a radiated measurement, provided the transmitter demonstrates compliance with the peak conducted power limits. If the transmitter complies with the conducted power limits based on the use of RMS averaging over a time interval, as permitted under paragraph (b)(3) of this section, the attenuation required under this paragraph shall be 30 dB instead of 20 dB. Attenuation below the general limits specified in Section 15.209(a) is not required. In addition, radiated emissions which fall in the restricted bands, as defined in Section 15.205(a), must also comply with the radiated emission limits specified in Section 15.209(a).

10.3.Restricted bands of operation

10.3.1.FCC Part 15.205 Restricted bands of operation

(a) Except as shown in paragraph (d) of this section, Only spurious emissions are permitted in any of the frequency bands listed below:

MHz	MHz	MHz	GHz
0.090-0.110	16.42-16.423	399.9-410	4.5-5.15
¹ 0.495-0.505	16.69475-16.69525	608-614	5.35-5.46
2.1735-2.1905	16.80425-16.80475	960-1240	7.25-7.75
4.125-4.128	25.5-25.67	1300-1427	8.025-8.5
4.17725-4.17775	37.5-38.25	1435-1626.5	9.0-9.2
4.20725-4.20775	73-74.6	1645.5-1646.5	9.3-9.5
6.215-6.218	74.8-75.2	1660-1710	10.6-12.7
6.26775-6.26825	108-121.94	1718.8-1722.2	13.25-13.4
6.31175-6.31225	123-138	2200-2300	14.47-14.5
8.291-8.294	149.9-150.05	2310-2390	15.35-16.2
8.362-8.366	156.52475-156.52525	2483.5-2500	17.7-21.4
8.37625-8.38675	156.7-156.9	2690-2900	22.01-23.12
8.41425-8.41475	162.0125-167.17	3260-3267	23.6-24.0
12.29-12.293	167.72-173.2	3332-3339	31.2-31.8
12.51975-12.52025	240-285	3345.8-3358	36.43-36.5
12.57675-12.57725	322-335.4	3600-4400	(²)
13.36-13.41			

¹Until February 1, 1999, this restricted band shall be 0.490-0.510

²Above 38.6

(b) Except as provided in paragraphs (d) and (e), the field strength of emission appearing within these frequency bands shall not exceed the limits shown in Section 15.209. At frequencies equal to or less than 1000MHz, Compliance with the limits in Section 15.209 shall be demonstrated using measurement instrumentation employing a CISPR quasi-peak detector. Above 1000MHz, compliance with the emission limits in Section 15.209 shall be demonstrated based on the average value of the measured emissions. The provisions in Section 15.35 apply to these measurements.

10.4.Configuration of EUT on Measurement

The equipment is installed on Radiated Emission Measurement to meet the commission requirements and operating regulations in a manner which tends to maximize its emission characteristics in normal application.

10.5. Test Procedure

The EUT and its simulators are placed on a turntable, which is 0.8 meter high above ground (Below 1GHz). The EUT and its simulators are placed on a turntable, which is 1.5 meter high above ground (Above 1GHz). The turntable can rotate 360 degrees to determine the position of the maximum emission level. EUT is set 3.0 meters away from the receiving antenna, which is mounted on an antenna tower. The antenna can be moved up and down between 1.0 meter and 4 meters to find out the maximum emission level. Broadband antenna (calibrated bi-log antenna) is used as receiving antenna. Both horizontal and vertical polarizations of the antenna are set on measurement. In order to find the maximum emission levels, all of the EUT location must be manipulated according to ANSI C63.10:2013 on radiated emission measurement. The EUT was tested in 3 orthogonal planes.

During the radiated emission test, the spectrum analyzer was set with the following configurations:

1. The resolution bandwidth and video bandwidth of test receiver/spectrum analyzer is 120kHz for Quasi-peak at frequency below 1GHz.
2. The resolution bandwidth of test receiver/spectrum analyzer is 1MHz and video bandwidth is 3MHz for peak measurement with peak detector at frequency above 1GHz.
3. The resolution bandwidth of test receiver/spectrum analyzer is 1MHz and video bandwidth is 10Hz for Average measurement with peak detection at frequency above 1GHz.
4. All modes of operation were investigated and the worst-case emissions are reported.

10.6. The Field Strength of Radiation Emission Measurement Results

Note:

1. We tested GFSK mode, $\pi/4$ -DQPSK Mode & 8QPSK mode and recorded the worst case data

(GFSK mode) for all test mode.

2. The test frequency is from 30MHz to 25GHz, The 18-25GHz emissions are not reported, because the levels are too low against the limit.

Below 1GHz(X9)



ACCURATE TECHNOLOGY CO., LTD.

F1,Bldg,A,Changyuan New Material Port Keyuan Rd,
Science & Industry Park,Nanshan Shenzhen,P.R.China

Site: 1# Chamber

Tel:+86-0755-26503290

Fax:+86-0755-26503396

Job No.: STAR2016 #1193

Standard: FCC Class B 3M Radiated

Test item: Radiation Test

Temp.(C)/Hum.(%) 25 C / 55 %

EUT: Media box

Mode: TX 2402MHz

Model: X9

Manufacturer: PIPO TECHNOLOGY CO., LTD

Polarization: Horizontal

Power Source: AC 120V/60Hz

Date: 16/06/15/

Time: 10/51/04

Engineer Signature: star

Distance: 3m

Note: Report No.:ATE20161168



No.	Freq. (MHz)	Reading (dBuV/m)	Factor (dB)	Result (dBuV/m)	Limit (dBuV/m)	Margin (dB)	Detector	Height (cm)	Degree (deg.)	Remark
1	215.3616	54.87	-18.43	36.44	43.50	-7.06	QP			
2	247.8594	59.78	-18.19	41.59	46.00	-4.41	QP			
3	427.2919	56.02	-13.59	42.43	46.00	-3.57	QP			



ACCURATE TECHNOLOGY CO., LTD.

F1,Bldg,A,Changyuan New Material Port Keyuan Rd,
Science & Industry Park,Nanshan Shenzhen,P.R.China

Site: 1# Chamber
Tel:+86-0755-26503290
Fax:+86-0755-26503396

Job No.: STAR2016 #1192
Standard: FCC Class B 3M Radiated
Test item: Radiation Test
Temp.(C)/Hum.(%) 25 C / 55 %
EUT: Media box
Mode: TX 2402MHz
Model: X9
Manufacturer: PIPO TECHNOLOGY CO., LTD

Polarization: Vertical
Power Source: AC 120V/60Hz
Date: 16/06/15/
Time: 10/49/31
Engineer Signature: star
Distance: 3m

Note: Report No.:ATE20161168

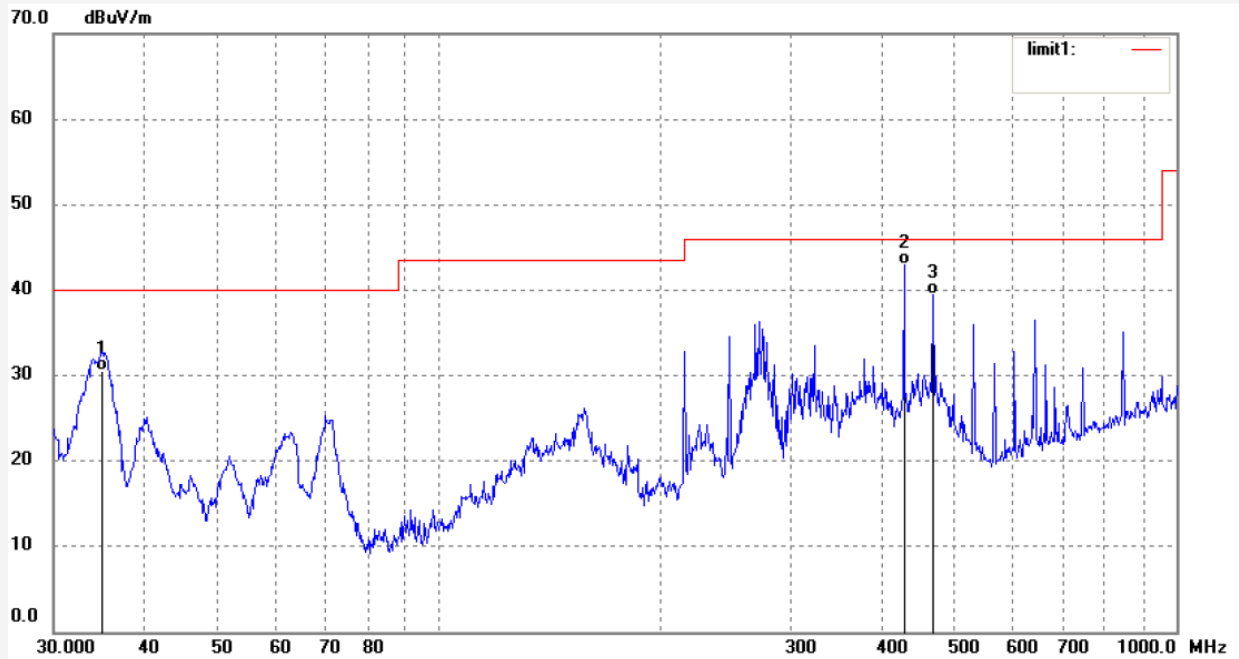

No.	Freq. (MHz)	Reading (dBuV/m)	Factor (dB)	Result (dBuV/m)	Limit (dBuV/m)	Margin (dB)	Detector	Height (cm)	Degree (deg.)	Remark
1	34.8928	48.07	-17.49	30.58	40.00	-9.42	QP			
2	427.2919	56.62	-13.59	43.03	46.00	-2.97	QP			
3	468.1650	52.05	-12.60	39.45	46.00	-6.55	QP			



ACCURATE TECHNOLOGY CO., LTD.

F1,Bldg,A,Changyuan New Material Port Keyuan Rd,
Science & Industry Park,Nanshan Shenzhen,P.R.China

Site: 1# Chamber
Tel:+86-0755-26503290
Fax:+86-0755-26503396

Job No.: STAR2016 #1194	Polarization: Horizontal
Standard: FCC Class B 3M Radiated	Power Source: AC 120V/60Hz
Test item: Radiation Test	Date: 16/06/15/
Temp.(C)/Hum.(%) 25 C / 55 %	Time: 10/52/52
EUT: Media box	Engineer Signature: star
Mode: TX 2441MHz	Distance: 3m
Model: X9	
Manufacturer: PIPO TECHNOLOGY CO., LTD	

Note: Report No.:ATE20161168

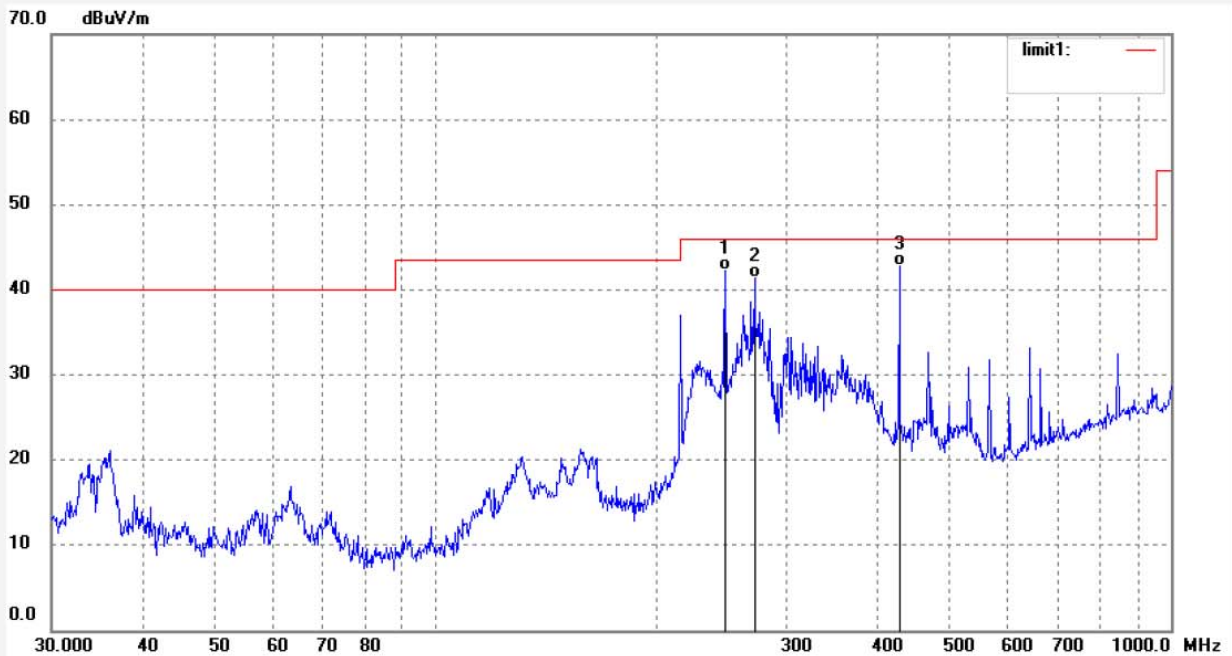

No.	Freq. (MHz)	Reading (dBuV/m)	Factor (dB)	Result (dBuV/m)	Limit (dBuV/m)	Margin (dB)	Detector	Height (cm)	Degree (deg.)	Remark
1	247.8595	60.48	-18.19	42.29	46.00	-3.71	QP			
2	271.5687	58.51	-17.09	41.42	46.00	-4.58	QP			
3	427.2920	56.34	-13.59	42.75	46.00	-3.25	QP			



ACCURATE TECHNOLOGY CO., LTD.

F1,Bldg,A,Changyuan New Material Port Keyuan Rd,
Science & Industry Park,Nanshan Shenzhen,P.R.China

Site: 1# Chamber
Tel:+86-0755-26503290
Fax:+86-0755-26503396

Job No.: STAR2016 #1195

Polarization: Vertical

Standard: FCC Class B 3M Radiated

Power Source: AC 120V/60Hz

Test item: Radiation Test

Date: 16/06/15/

Temp.(C)/Hum.(%) 25 C / 55 %

Time: 10/53/49

EUT: Media box

Engineer Signature: star

Mode: TX 2441MHz

Distance: 3m

Model: X9

Manufacturer: PIPO TECHNOLOGY CO., LTD

Note: Report No.:ATE20161168

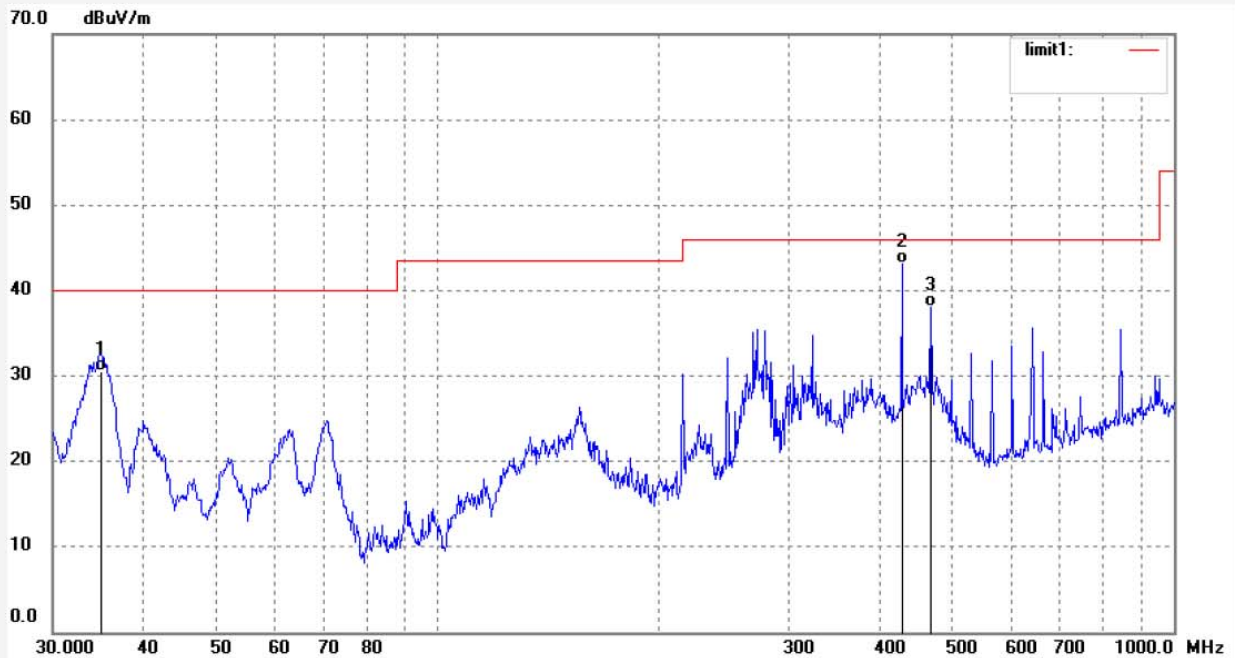

No.	Freq. (MHz)	Reading (dBuV/m)	Factor (dB)	Result (dBuV/m)	Limit (dBuV/m)	Margin (dB)	Detector	Height (cm)	Degree (deg.)	Remark
1	34.8928	48.00	-17.49	30.51	40.00	-9.49	QP			
2	427.2919	56.65	-13.59	43.06	46.00	-2.94	QP			
3	468.1650	50.58	-12.60	37.98	46.00	-8.02	QP			



ACCURATE TECHNOLOGY CO., LTD.

F1,Bldg,A,Changyuan New Material Port Keyuan Rd,
Science & Industry Park,Nanshan Shenzhen,P.R.China

Site: 1# Chamber
Tel:+86-0755-26503290
Fax:+86-0755-26503396

Job No.: STAR2016 #1197

Standard: FCC Class B 3M Radiated

Test item: Radiation Test

Temp.(C)/Hum.(%) 25 C / 55 %

EUT: Media box

Mode: TX 2480MHz

Model: X9

Manufacturer: PIPO TECHNOLOGY CO., LTD

Polarization: Horizontal

Power Source: AC 120V/60Hz

Date: 16/06/15/

Time: 10/55/42

Engineer Signature: star

Distance: 3m

Note: Report No.:ATE20161168



No.	Freq. (MHz)	Reading (dBuV/m)	Factor (dB)	Result (dBuV/m)	Limit (dBuV/m)	Margin (dB)	Detector	Height (cm)	Degree (deg.)	Remark
1	247.8594	60.50	-18.19	42.31	46.00	-3.69	QP			
2	268.7212	58.56	-17.16	41.40	46.00	-4.60	QP			
3	427.2919	56.79	-13.59	43.20	46.00	-2.80	QP			



ACCURATE TECHNOLOGY CO., LTD.

F1,Bldg.A,Changyuan New Material Port Keyuan Rd,
Science & Industry Park,Nanshan Shenzhen,P.R.China

Site: 1# Chamber
Tel:+86-0755-26503290
Fax:+86-0755-26503396

Job No.: STAR2016 #1196
Standard: FCC Class B 3M Radiated
Test item: Radiation Test
Temp.(C)/Hum.(%) 25 C / 55 %
EUT: Media box
Mode: TX 2480MHz
Model: X9
Manufacturer: PIPO TECHNOLOGY CO., LTD

Polarization: Vertical
Power Source: AC 120V/60Hz
Date: 16/06/15/
Time: 10/54/26
Engineer Signature: star
Distance: 3m

Note: Report No.:ATE20161168

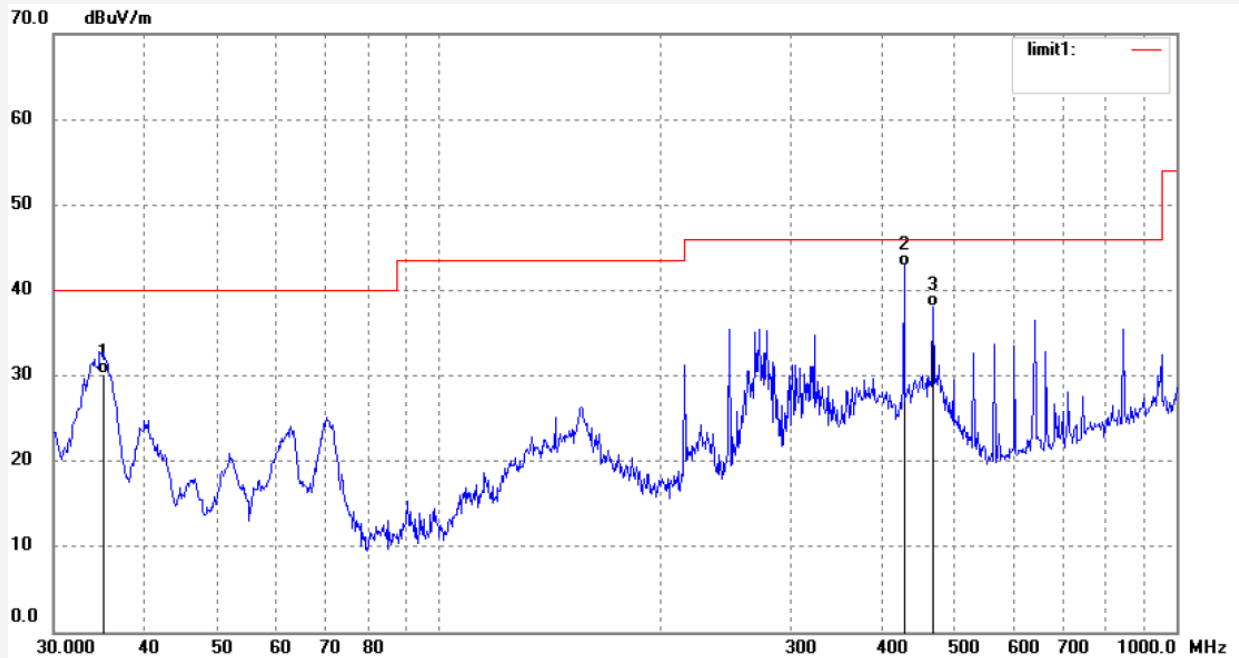

No.	Freq. (MHz)	Reading (dBuV/m)	Factor (dB)	Result (dBuV/m)	Limit (dBuV/m)	Margin (dB)	Detector	Height (cm)	Degree (deg.)	Remark
1	35.0157	47.68	-17.51	30.17	40.00	-9.83	QP			
2	427.2919	56.44	-13.59	42.85	46.00	-3.15	QP			
3	468.1650	50.58	-12.60	37.98	46.00	-8.02	QP			

Above 1GHz

ACCURATE TECHNOLOGY CO., LTD.

 F1,Bldg,A,Changyuan New Material Port Keyuan Rd,
 Science & Industry Park,Nanshan Shenzhen,P.R.China

Site: 1# Chamber

Tel:+86-0755-26503290

Fax:+86-0755-26503396

Job No.: STAR2016 #1211

Standard: FCC Class B 3M Radiated

Test item: Radiation Test

Temp.(C)/Hum.(%) 25 C / 55 %

EUT: Media box

Mode: TX 2402MHz

Model: X9

Manufacturer: PIPO TECHNOLOGY CO., LTD

Polarization: Horizontal

Power Source: AC 120V/60Hz

Date: 16/06/15/

Time: 11/17/29

Engineer Signature: star

Distance: 3m

Note: Report No.:ATE20161168

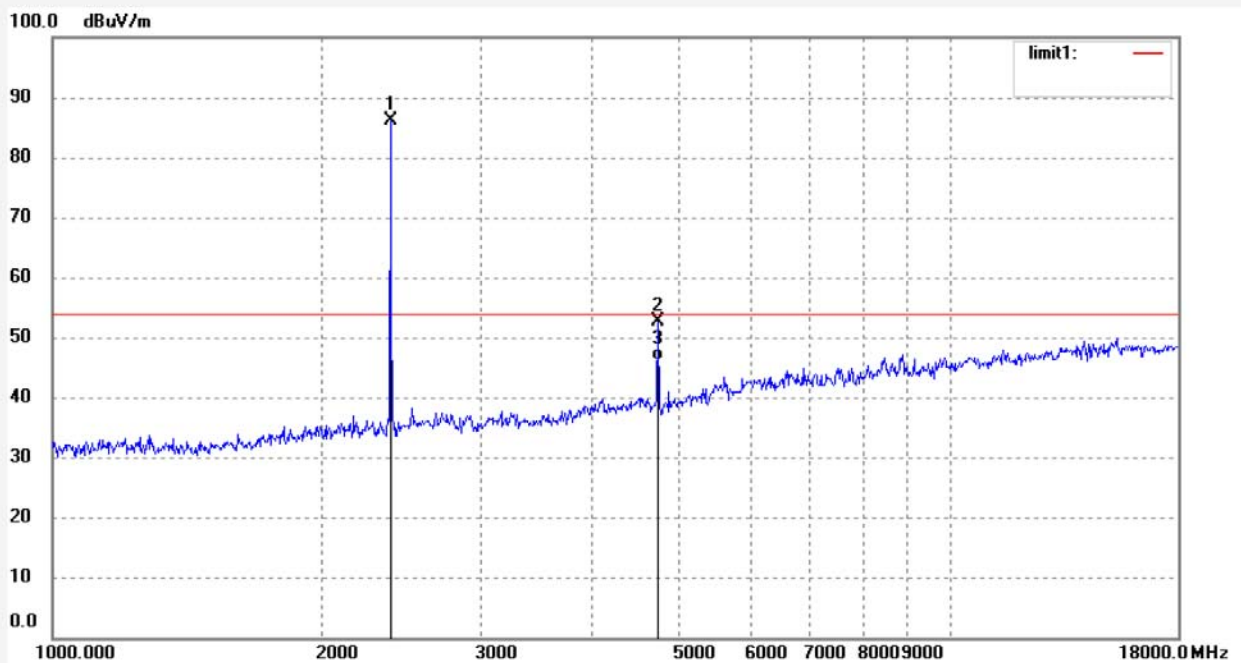

No.	Freq. (MHz)	Reading (dBuV/m)	Factor (dB)	Result (dBuV/m)	Limit (dBuV/m)	Margin (dB)	Detector	Height (cm)	Degree (deg.)	Remark
1	2402.000	93.83	-7.67	86.16			peak			
2	4804.000	54.42	-1.77	52.65	74.00	-21.35	peak			
3	4804.000	48.00	-1.77	46.23	54.00	-7.77	AVG			

Note: Average measurement with peak detection at No.3



ACCURATE TECHNOLOGY CO., LTD.

F1,Bldg.A,Changyuan New Material Port Keyuan Rd,
Science & Industry Park,Nanshan Shenzhen,P.R.China

Site: 1# Chamber
Tel:+86-0755-26503290
Fax:+86-0755-26503396

Job No.: STAR2016 #1210	Polarization: Vertical
Standard: FCC Class B 3M Radiated	Power Source: AC 120V/60Hz
Test item: Radiation Test	Date: 16/06/15/
Temp.(C)/Hum.(%) 25 C / 55 %	Time: 11/16/16
EUT: Media box	Engineer Signature: star
Mode: TX 2402MHz	Distance: 3m
Model: X9	
Manufacturer: PIPO TECHNOLOGY CO., LTD	

Note: Report No.:ATE20161168

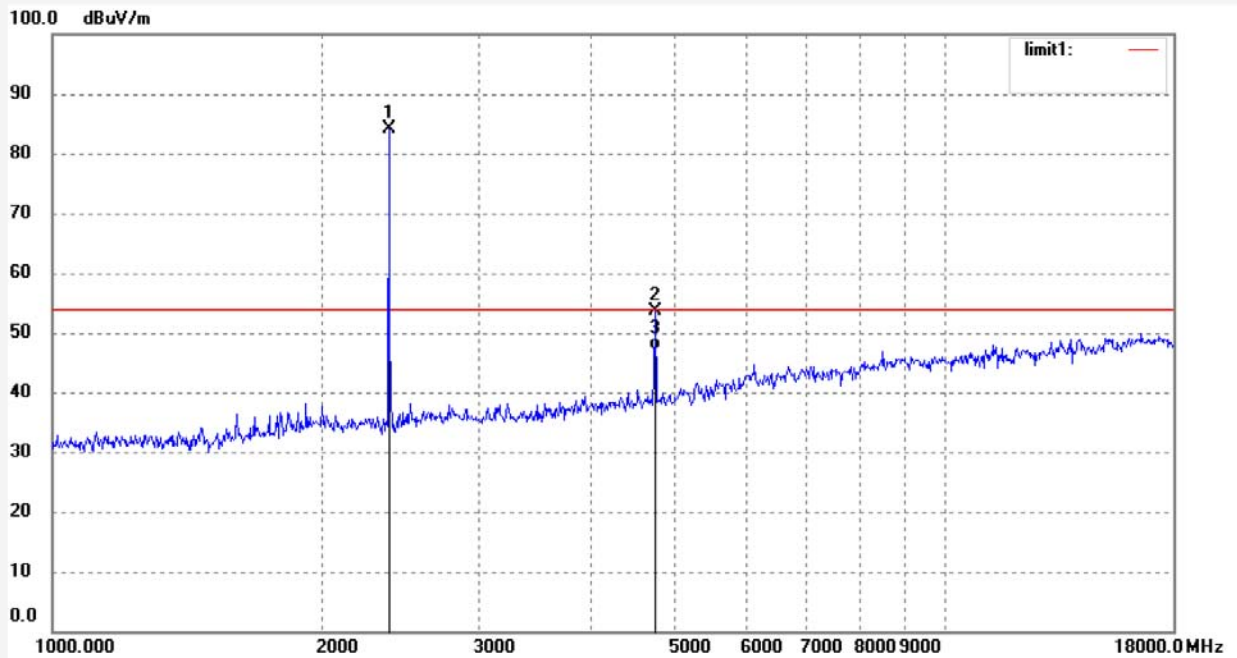

No.	Freq. (MHz)	Reading (dBuV/m)	Factor (dB)	Result (dBuV/m)	Limit (dBuV/m)	Margin (dB)	Detector	Height (cm)	Degree (deg.)	Remark
1	2402.000	91.70	-7.67	84.03			peak			
2	4804.000	55.44	-1.77	53.67	74.00	-20.33	peak			
3	4804.000	48.90	-1.77	47.13	54.00	-6.87	AVG			

Note: Average measurement with peak detection at No.3

ACCURATE TECHNOLOGY CO., LTD.

 F1,Bldg,A,Changyuan New Material Port Keyuan Rd,
 Science & Industry Park,Nanshan Shenzhen,P.R.China

Site: 1# Chamber

Tel:+86-0755-26503290

Fax:+86-0755-26503396

Job No.: STAR2016 #1212

Standard: FCC Class B 3M Radiated

Test item: Radiation Test

Temp.(C)/Hum.(%) 25 C / 55 %

EUT: Media box

Mode: TX 2441MHz

Model: X9

Manufacturer: PIPO TECHNOLOGY CO., LTD

Polarization: Horizontal

Power Source: AC 120V/60Hz

Date: 16/06/15/

Time: 11/19/23

Engineer Signature: star

Distance: 3m

Note: Report No.:ATE20161168

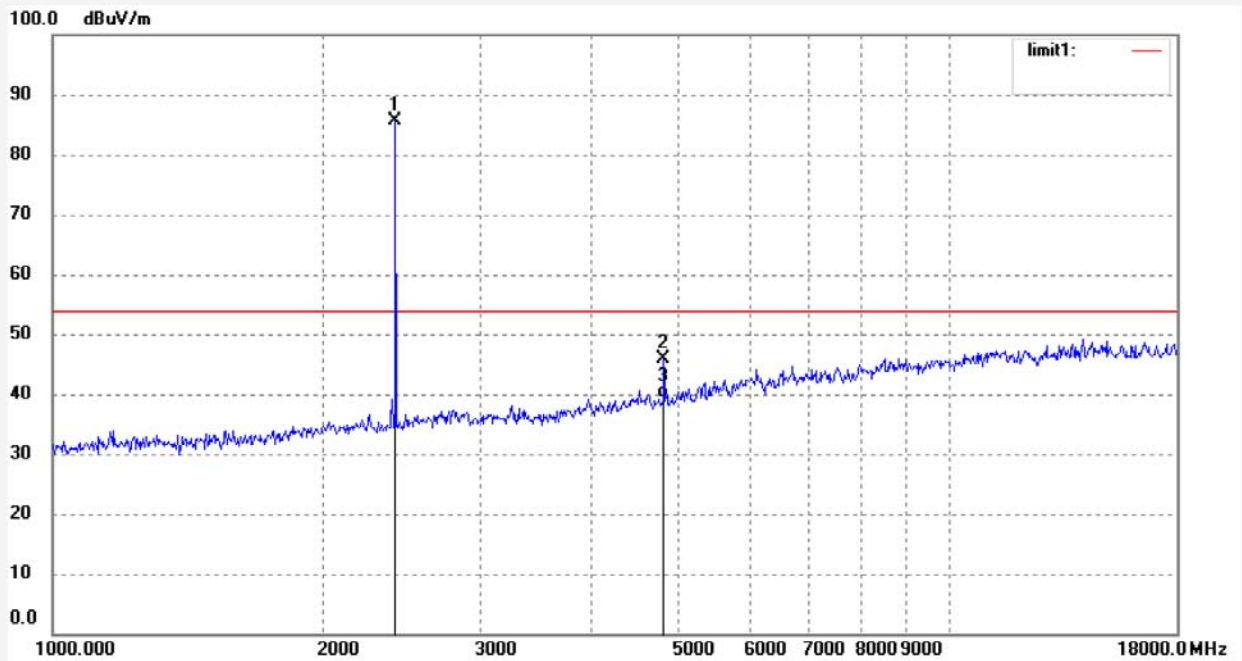

No.	Freq. (MHz)	Reading (dBuV/m)	Factor (dB)	Result (dBuV/m)	Limit (dBuV/m)	Margin (dB)	Detector	Height (cm)	Degree (deg.)	Remark
1	2441.000	93.11	-7.56	85.55			peak			
2	4882.000	47.40	-1.50	45.90	74.00	-28.10	peak			
3	4882.000	40.78	-1.50	39.28	54.00	-14.72	AVG			

Note: Average measurement with peak detection at No.3

Job No.: STAR2016 #1213

Standard: FCC Class B 3M Radiated

Test item: Radiation Test

Temp.(C)/Hum.(%) 25 C / 55 %

EUT: Media box

Mode: TX 2441MHz

Model: X9

Manufacturer: PIPO TECHNOLOGY CO., LTD

Polarization: Vertical

Power Source: AC 120V/60Hz

Date: 16/06/15/

Time: 11/20/14

Engineer Signature: star

Distance: 3m

Note: Report No.:ATE20161168

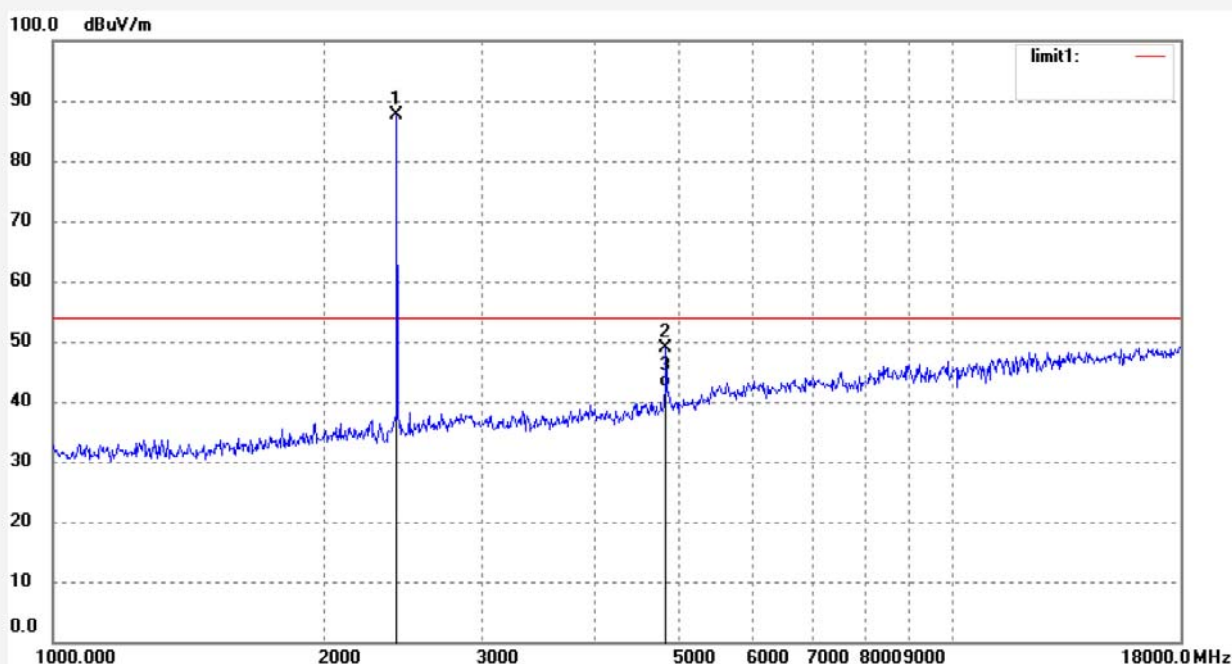

No.	Freq. (MHz)	Reading (dBuV/m)	Factor (dB)	Result (dBuV/m)	Limit (dBuV/m)	Margin (dB)	Detector	Height (cm)	Degree (deg.)	Remark
1	2441.000	95.14	-7.56	87.58	114.00	26.42	peak			
2	4882.000	50.26	-1.50	48.76	74.00	-25.24	peak			
3	4882.000	43.89	-1.50	42.39	54.00	-11.61	AVG			

Note: Average measurement with peak detection at No.3

Job No.: STAR2016 #1215

Standard: FCC Class B 3M Radiated

Test item: Radiation Test

Temp.(C)/Hum.(%) 25 C / 55 %

EUT: Media box

Mode: TX 2480MHz

Model: X9

Manufacturer: PIPO TECHNOLOGY CO., LTD

Polarization: Horizontal

Power Source: AC 120V/60Hz

Date: 16/06/15/

Time: 11/24/05

Engineer Signature: star

Distance: 3m

Note: Report No.:ATE20161168

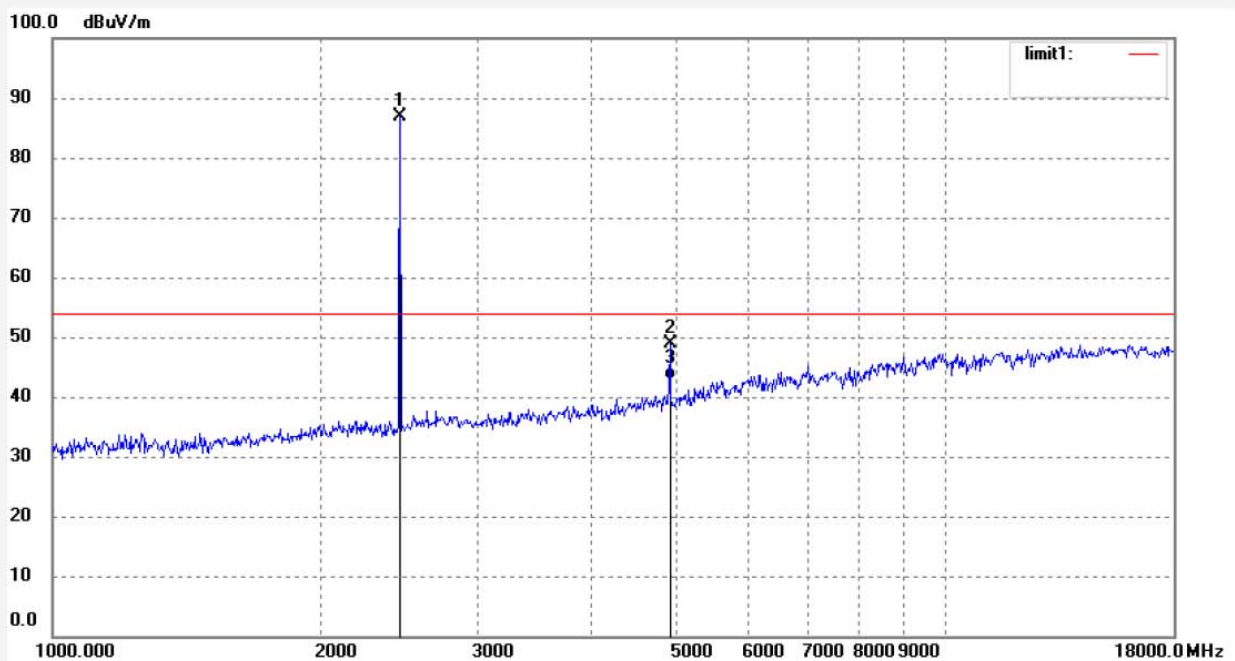

No.	Freq. (MHz)	Reading (dBuV/m)	Factor (dB)	Result (dBuV/m)	Limit (dBuV/m)	Margin (dB)	Detector	Height (cm)	Degree (deg.)	Remark
1	2480.000	94.29	-7.47	86.82	114.00	-27.18	peak			
2	4914.444	50.08	-1.17	48.91	74.00	-25.09	peak			
3	4914.444	44.17	-1.17	43.00	54.00	-11.00	AVG			

Note: Average measurement with peak detection at No.3

Job No.: STAR2016 #1214	Polarization: Vertical
Standard: FCC Class B 3M Radiated	Power Source: AC 120V/60Hz
Test item: Radiation Test	Date: 16/06/15/
Temp.(C)/Hum.(%) 25 C / 55 %	Time: 11/23/17
EUT: Media box	Engineer Signature: star
Mode: TX 2480MHz	Distance: 3m
Model: X9	
Manufacturer: PIPO TECHNOLOGY CO., LTD	

Note: Report No.:ATE20161168

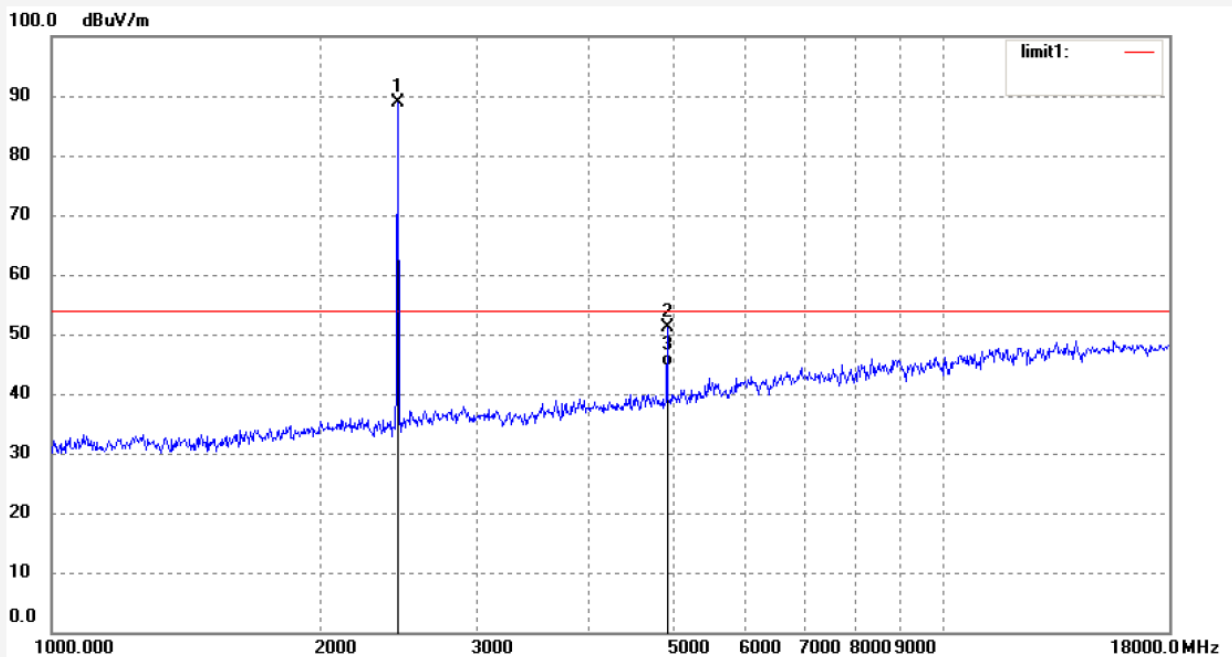

No.	Freq. (MHz)	Reading (dBuV/m)	Factor (dB)	Result (dBuV/m)	Limit (dBuV/m)	Margin (dB)	Detector	Height (cm)	Degree (deg.)	Remark
1	2480.000	96.29	-7.47	88.82	111.00	25.18	peak			
2	4960.000	52.23	-1.17	51.06	74.00	-22.94	peak			
3	4960.000	45.68	-1.17	44.51	54.00	-9.49	AVG			

Note: Average measurement with peak detection at No.3

11. BAND EDGE COMPLIANCE TEST

11.1. Block Diagram of Test Setup

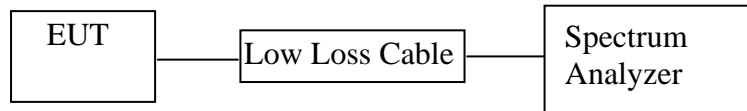

(EUT: Media box)

11.2. The Requirement For Section 15.247(d)

Section 15.247(d): In any 100 kHz bandwidth outside the frequency band in which the spread spectrum or digitally modulated intentional radiator is operating, the radio frequency power that is produced by the intentional radiator shall be at least 20 dB below that in the 100 kHz bandwidth within the band that contains the highest level of the desired power, based on either an RF conducted or a radiated measurement, provided the transmitter demonstrates compliance with the peak conducted power limits. If the transmitter complies with the conducted power limits based on the use of RMS averaging over a time interval, as permitted under paragraph (b)(3) of this section, the attenuation required under this paragraph shall be 30 dB instead of 20 dB. Attenuation below the general limits specified in Section 15.209(a) is not required. In addition, radiated emissions which fall in the restricted bands, as defined in Section 15.205(a), must also comply with the radiated emission limits specified in Section 15.209(a).

11.3. EUT Configuration on Measurement

The equipment are installed on the emission Measurement to meet the commission requirements and operating regulations in a manner which tends to maximize its emission characteristics in normal application.

11.4. Operating Condition of EUT

11.4.1. Setup the EUT and simulator as shown as Section 11.1.

11.4.2. Turn on the power of all equipment.

11.4.3. Let the EUT work in TX (Hopping off, Hopping on) modes measure it. The transmit frequency are 2402-2480MHz. We select 2402MHz, 2480MHz TX frequency to transmit.

11.5. Test Procedure

11.5.1. The transmitter output was connected to the spectrum analyzer via a low loss cable.

11.5.2. Set RBW of spectrum analyzer to 100 kHz and VBW to 300 kHz with convenient frequency span including 100 kHz bandwidth from band edge.

11.5.3. The band edges was measured and recorded.

11.6. Test Result

Frequency (MHz)	Result of Band Edge (dBc)	Limit of Band Edge (dBc)
GFSK		
2400.00	38.67	> 20dBc
2484.45	47.17	> 20dBc
Π/4-DQPSK Mode		
2400.00	49.49	> 20dBc
2483.50	43.41	> 20dBc
8QPSK		
2400.00	49.25	> 20dBc
2483.50	43.41	> 20dBc

GFSK

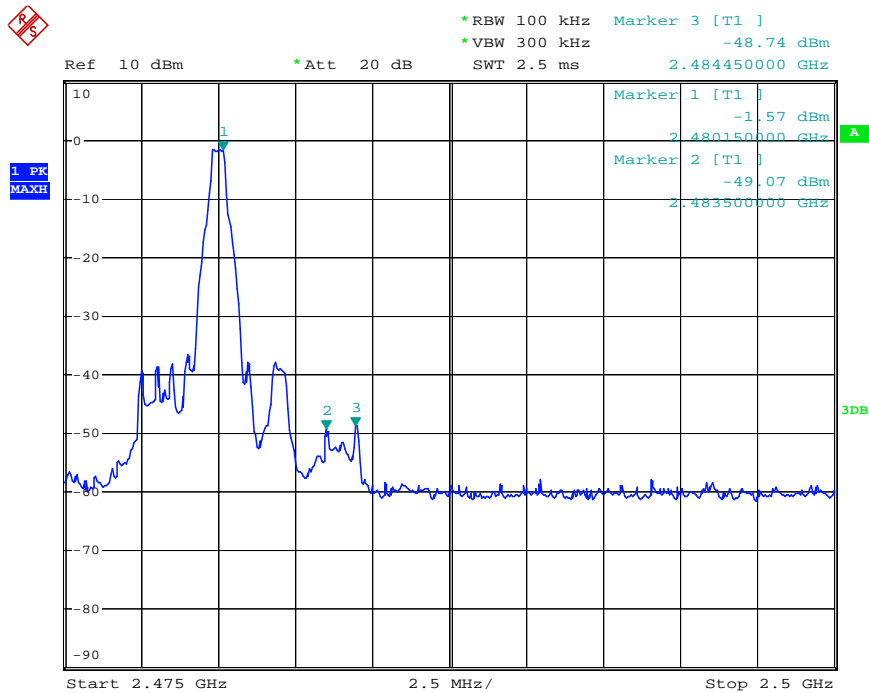
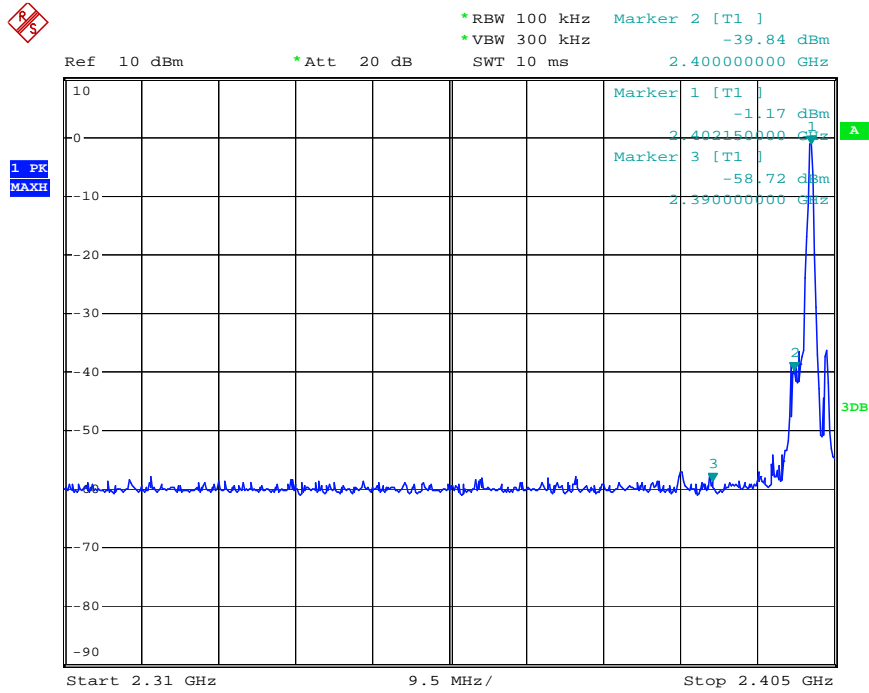

Π/4-DQPSK Mode

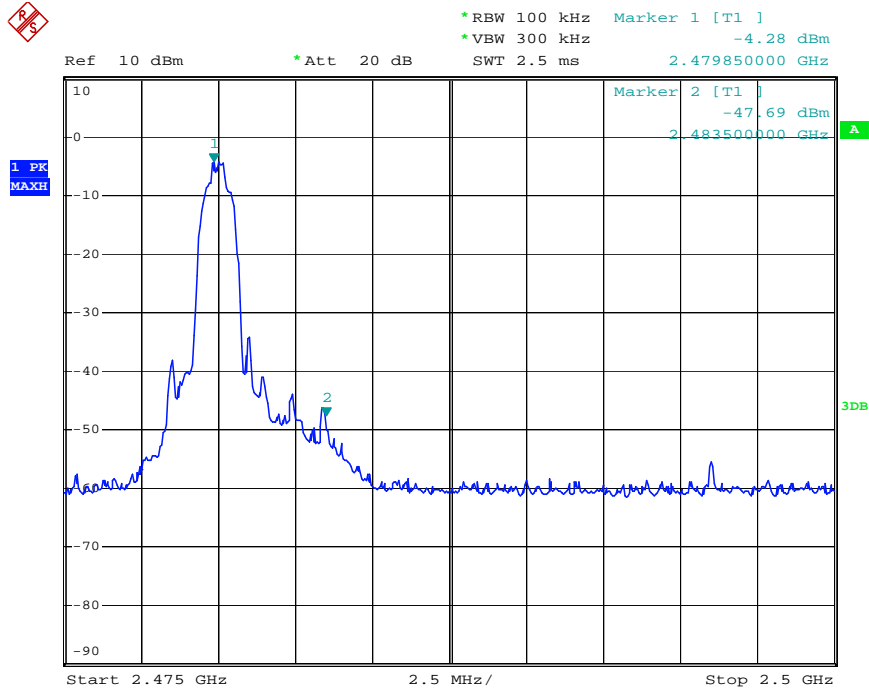
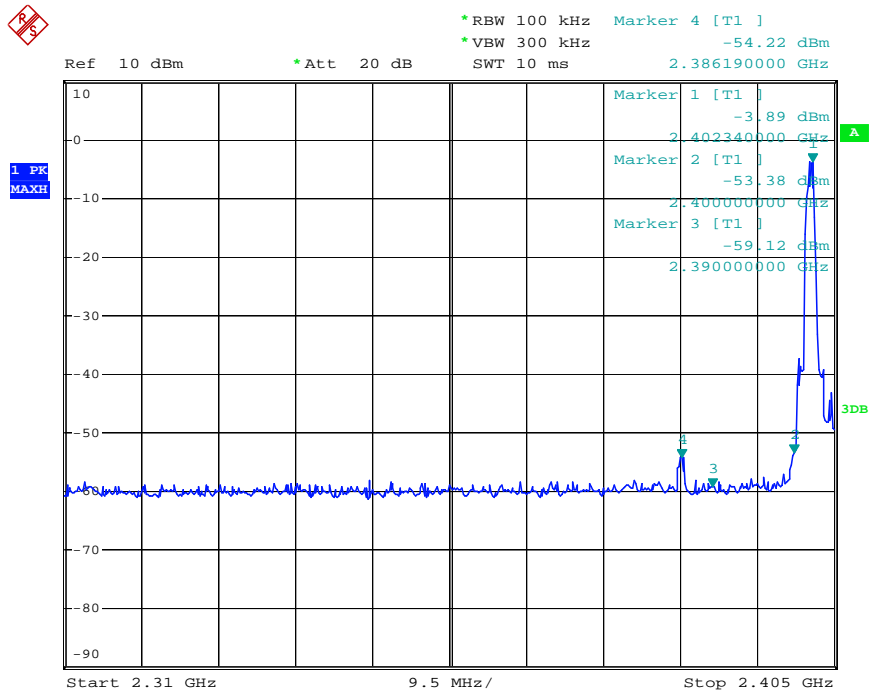

8DPSK

