



A D T

# FCC SAR Test Report

Report No. : SA120530C07A

Applicant : SILICON POWER COMPUTER & COMMUNICATION INC.

Address : 7F, NO. 106, ZHOUI ST., NEIHU DISTRICT, TAIPEI CITY 114, TAIWAN

Product : USB3.0 Wifi Hard Drive

FCC ID : PRS-WHD

Brand : Silicon Power

Model No. : Sky Share H10

Standards : FCC 47 CFR Part 2 (2.1093) / IEEE C95.1:1991 / IEEE 1528:2003  
 FCC OET Bulletin 65 Supplement C (Edition 01-01)  
 KDB 248227 D01 v01r02 / KDB 941225 D07 v01

Date of Testing : Sep. 17, 2012 ~ Sep. 18, 2012

**CERTIFICATION:** The above equipment have been tested by **Bureau Veritas Consumer Products Services (H.K.) Ltd., Taoyuan Branch - Taiwan HwaYa Lab**, and found compliance with the requirement of the above standards. The test record, data evaluation & Equipment Under Test (EUT) configurations represented herein are true and accurate accounts of the measurements of the sample's SAR characteristics under the conditions specified in this report. It should not be reproduced except in full, without the written approval of our laboratory. The client should not use it to claim product certification, approval, or endorsement by TAF or any government agencies.

Prepared By :   
 Ivy Lin / Specialist

Approved By :   
 Roy Wu / Manager



This report is for your exclusive use. Any copying or replication of this report to or for any other person or entity, or use of our name or trademark, is permitted only with our prior written permission. This report sets forth our findings solely with respect to the test samples identified herein. The results set forth in this report are not indicative or representative of the quality or characteristics of the lot from which a test sample was taken or any similar or identical product unless specifically and expressly noted. Our report includes all of the tests requested by you and the results thereof based upon the information that you provided to us. You have 60 days from date of issuance of this report to notify us of any material error or omission caused by our negligence, provided, however, that such notice shall be in writing and shall specifically address the issue you wish to raise. A failure to raise such issue within the prescribed time shall constitute your unqualified acceptance of the completeness of this report, the tests conducted and the correctness of the report contents. Unless specific mention, the uncertainty of measurement has been explicitly taken into account to declare the compliance or non-compliance to the specification.



# Table of Contents

- Release Control Record ..... 3
- 1. Summary of Maximum SAR Value ..... 4
- 2. Description of Equipment Under Test ..... 5
- 3. SAR Measurement System ..... 6
  - 3.1 Definition of Specific Absorption Rate (SAR)..... 6
  - 3.2 SPEAG DASY System ..... 6
    - 3.2.1 Robot..... 7
    - 3.2.2 Probes..... 8
    - 3.2.3 Data Acquisition Electronics (DAE) ..... 8
    - 3.2.4 Phantoms ..... 9
    - 3.2.5 Device Holder..... 10
    - 3.2.6 System Validation Dipoles ..... 10
    - 3.2.7 Tissue Simulating Liquids..... 11
  - 3.3 SAR System Verification ..... 12
  - 3.4 SAR Measurement Procedure ..... 13
    - 3.4.1 Area & Zoom Scan Procedure ..... 13
    - 3.4.2 Volume Scan Procedure..... 13
    - 3.4.3 Power Drift Monitoring..... 13
    - 3.4.4 Spatial Peak SAR Evaluation ..... 14
    - 3.4.5 SAR Averaged Methods ..... 14
- 4. SAR Measurement Evaluation ..... 15
  - 4.1 EUT Configuration and Setting..... 15
  - 4.2 EUT Testing Position ..... 15
  - 4.3 Tissue Verification ..... 15
  - 4.4 System Verification..... 15
  - 4.5 Conducted Power Results..... 16
  - 4.6 SAR Testing Results..... 16
    - 4.6.1 SAR Results for Body..... 16
- 5. Calibration of Test Equipment..... 17
- 6. Measurement Uncertainty ..... 18
- 7. Information on the Testing Laboratories ..... 20

Appendix A. SAR Plots of System Verification

Appendix B. SAR Plots of SAR Measurement

Appendix C. Calibration Certificate for Probe and Dipole

Appendix D. Photographs of EUT and Setup



## Release Control Record

Issue No.	Reason for Change	Date Issued
R01	Original release	Sep. 20, 2012



## 1. Summary of Maximum SAR Value

Mode / Band	Test Position	SAR-1g (W/kg)
WLAN 2.4GHz	Body (0.5 cm Gap)	0.227

**Note:**

1. The SAR limit (**1.6 W/kg**) for general population/uncontrolled exposure is specified in FCC 47 CFR part 2 (2.1093) and ANSI/IEEE C95.1-1991.

## 2. Description of Equipment Under Test

<b>EUT Type</b>	USB3.0 Wifi Hard Drive
<b>FCC ID</b>	PRS-WHD
<b>Brand Name</b>	Silicon Power
<b>Model Name</b>	Sky Share H10
<b>Tx Frequency Bands (Unit: MHz)</b>	WLAN : 2400 ~ 2483.5
<b>Uplink Modulations</b>	802.11b : DSSS 802.11g/n : OFDM
<b>Maximum AVG Conducted Power (Unit: dBm)</b>	802.11b : 14.61 802.11g : 14.93 802.11n HT20 : 16.40 802.11n HT40 : 16.34
<b>Antenna Type</b>	Printed Antenna
<b>EUT Stage</b>	Identical Prototype

**Note:**

1. The above EUT information is declared by manufacturer and for more detailed features description please refers to the manufacturer's specifications or User's Manual.

**List of Accessory:**

<b>AC Adapter</b>	<b>Brand Name</b>	SWITCHING POWER SUPPLY
	<b>Model Name</b>	GS2U-012-0502000-LB
	<b>Power Rating</b>	I/P: 100-240Vac, 50/60Hz, 0.5A; O/P: 5Vdc, 2000mA
	<b>DC Power Cord Type</b>	meter shielded cable without ferrite core
<b>USB Cable</b>	<b>Brand Name</b>	
	<b>Model Name</b>	
	<b>Signal Line Type</b>	1 meter shielded cable with 2 ferrite cores
<b>USB Cable</b>	<b>Brand Name</b>	
	<b>Model Name</b>	
	<b>Signal Line Type</b>	0.5 meter shielded cable without ferrite core

### **3. SAR Measurement System**

#### **3.1 Definition of Specific Absorption Rate (SAR)**

SAR is related to the rate at which energy is absorbed per unit mass in an object exposed to a radio field. The SAR distribution in a biological body is complicated and is usually carried out by experimental techniques or numerical modeling. The standard recommends limits for two tiers of groups, occupational/controlled and general population/uncontrolled, based on a person's awareness and ability to exercise control over his or her exposure. In general, occupational/controlled exposure limits are higher than the limits for general population/uncontrolled.

The SAR definition is the time derivative (rate) of the incremental energy (dW) absorbed by (dissipated in) an incremental mass (dm) contained in a volume element (dv) of a given density ( $\rho$ ). The equation description is as below:

$$\text{SAR} = \frac{d}{dt} \left( \frac{dW}{dm} \right) = \frac{d}{dt} \left( \frac{dW}{\rho dv} \right)$$

SAR is expressed in units of Watts per kilogram (W/kg)

SAR measurement can be related to the electrical field in the tissue by

$$\text{SAR} = \frac{\sigma |E|^2}{\rho}$$

Where:  $\sigma$  is the conductivity of the tissue,  $\rho$  is the mass density of the tissue and E is the RMS electrical field strength.

#### **3.2 SPEAG DASY System**

DASY system consists of high precision robot, probe alignment sensor, phantom, robot controller, controlled measurement server and near-field probe. The robot includes six axes that can move to the precision position of the DASY4/5 software defined. The DASY software can define the area that is detected by the probe. The robot is connected to controlled box. Controlled measurement server is connected to the controlled robot box. The DAE includes amplifier, signal multiplexing, AD converter, offset measurement and surface detection. It is connected to the Electro-optical coupler (ECO). The ECO performs the conversion from the optical into digital electric signal of the DAE and transfers data to the PC.

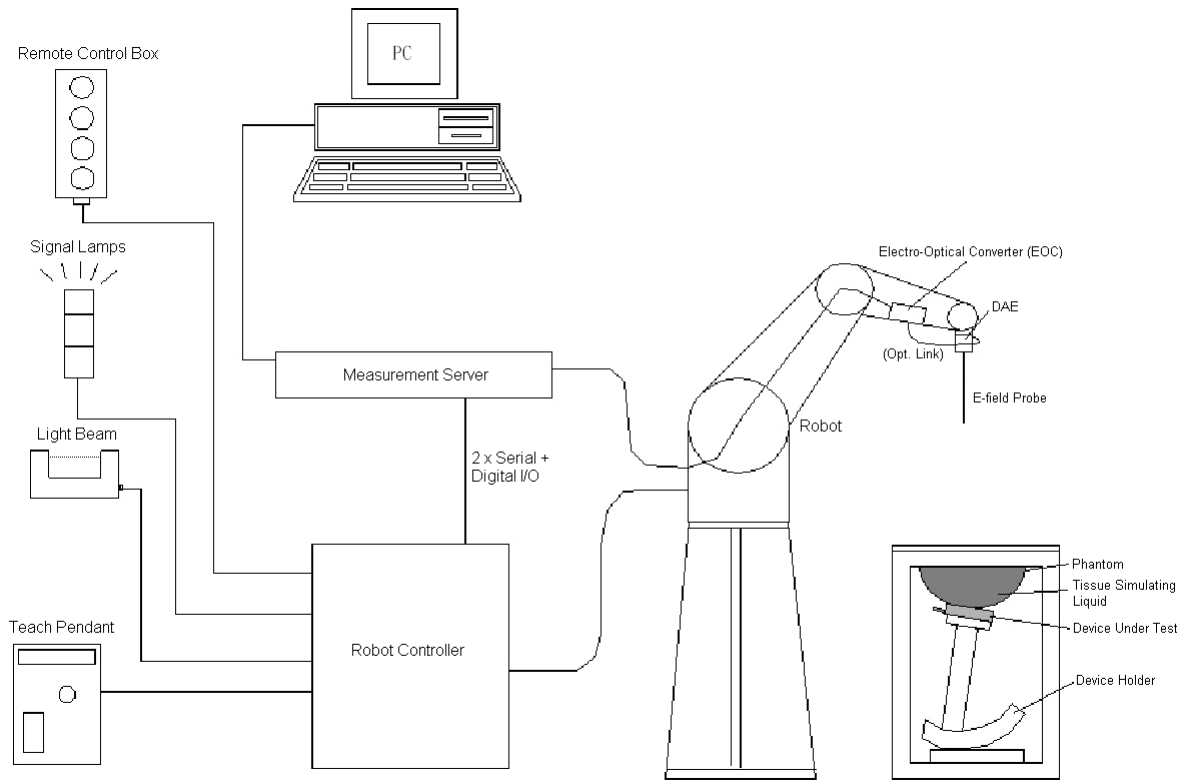

Fig-3.1 DASY System Setup

### 3.2.1 Robot

The DASY system uses the high precision robots from Stäubli SA (France). For the 6-axis controller system, the robot controller version (DASY4: CS7MB; DASY5: CS8c) from Stäubli is used. The Stäubli robot series have many features that are important for our application:

- High precision (repeatability  $\pm 0.035$  mm)
- High reliability (industrial design)
- Jerk-free straight movements
- Low ELF interference (the closed metallic construction shields against motor control fields)



Fig-3.2 DASY4





Fig-3.3 DASY5

# FCC SAR Test Report

## 3.2.2 Probes

The SAR measurement is conducted with the dosimetric probe. The probe is specially designed and calibrated for use in liquid with high permittivity. The dosimetric probe has special calibration in liquid at different frequency.

<b>Model</b>	EX3DV4	
<b>Construction</b>	Symmetrical design with triangular core. Built-in shielding against static charges. PEEK enclosure material (resistant to organic solvents, e.g., DGBE).	
<b>Frequency</b>	10 MHz to 6 GHz Linearity: $\pm 0.2$ dB	
<b>Directivity</b>	$\pm 0.3$ dB in HSL (rotation around probe axis) $\pm 0.5$ dB in tissue material (rotation normal to probe axis)	
<b>Dynamic Range</b>	10 $\mu$ W/g to 100 mW/g Linearity: $\pm 0.2$ dB (noise: typically $< 1$ $\mu$ W/g)	
<b>Dimensions</b>	Overall length: 337 mm (Tip: 20 mm) Tip diameter: 2.5 mm (Body: 12 mm) Typical distance from probe tip to dipole centers: 1 mm	

<b>Model</b>	ES3DV3	
<b>Construction</b>	Symmetrical design with triangular core. Interleaved sensors. Built-in shielding against static charges. PEEK enclosure material (resistant to organic solvents, e.g., DGBE).	
<b>Frequency</b>	10 MHz to 4 GHz Linearity: $\pm 0.2$ dB	
<b>Directivity</b>	$\pm 0.2$ dB in HSL (rotation around probe axis) $\pm 0.3$ dB in tissue material (rotation normal to probe axis)	
<b>Dynamic Range</b>	5 $\mu$ W/g to 100 mW/g Linearity: $\pm 0.2$ dB	
<b>Dimensions</b>	Overall length: 337 mm (Tip: 20 mm) Tip diameter: 3.9 mm (Body: 12 mm) Distance from probe tip to dipole centers: 2.0 mm	

## 3.2.3 Data Acquisition Electronics (DAE)

<b>Model</b>	DAE3, DAE4	
<b>Construction</b>	Signal amplifier, multiplexer, A/D converter and control logic. Serial optical link for communication with DASY4/5 embedded system (fully remote controlled). Two step probe touch detector for mechanical surface detection and emergency robot stop.	
<b>Measurement Range</b>	-100 to +300 mV (16 bit resolution and two range settings: 4mV, 400mV)	
<b>Input Offset Voltage</b>	$< 5$ $\mu$ V (with auto zero)	
<b>Input Bias Current</b>	$< 50$ fA	
<b>Dimensions</b>	60 x 60 x 68 mm	



# FCC SAR Test Report

## 3.2.4 Phantoms

<b>Model</b>	Twin SAM	
<b>Construction</b>	The shell corresponds to the specifications of the Specific Anthropomorphic Mannequin (SAM) phantom defined in IEEE 1528 and IEC 62209-1. It enables the dosimetric evaluation of left and right hand phone usage as well as body mounted usage at the flat phantom region. A cover prevents evaporation of the liquid. Reference markings on the phantom allow the complete setup of all predefined phantom positions and measurement grids by teaching three points with the robot.	
<b>Material</b>	Vinylester, glass fiber reinforced (VE-GF)	
<b>Shell Thickness</b>	2 ± 0.2 mm (6 ± 0.2 mm at ear point)	
<b>Dimensions</b>	Length: 1000 mm Width: 500 mm Height: adjustable feet	
<b>Filling Volume</b>	approx. 25 liters	

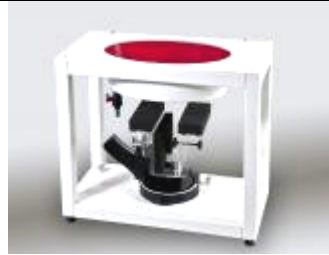
<b>Model</b>	ELI	
<b>Construction</b>	Phantom for compliance testing of handheld and body-mounted wireless devices in the frequency range of 30 MHz to 6 GHz. ELI is fully compatible with the IEC 62209-2 standard and all known tissue simulating liquids. ELI has been optimized regarding its performance and can be integrated into our standard phantom tables. A cover prevents evaporation of the liquid. Reference markings on the phantom allow installation of the complete setup, including all predefined phantom positions and measurement grids, by teaching three points. The phantom is compatible with all SPEAG dosimetric probes and dipoles.	
<b>Material</b>	Vinylester, glass fiber reinforced (VE-GF)	
<b>Shell Thickness</b>	2.0 ± 0.2 mm (bottom plate)	
<b>Dimensions</b>	Major axis: 600 mm Minor axis: 400 mm	
<b>Filling Volume</b>	approx. 30 liters	

# FCC SAR Test Report

## 3.2.5 Device Holder

<b>Model</b>	Mounting Device	
<b>Construction</b>	In combination with the Twin SAM Phantom or ELI4, the Mounting Device enables the rotation of the mounted transmitter device in spherical coordinates. Rotation point is the ear opening point. Transmitter devices can be easily and accurately positioned according to IEC, IEEE, FCC or other specifications. The device holder can be locked for positioning at different phantom sections (left head, right head, flat).	
<b>Material</b>	POM	

<b>Model</b>	Laptop Extensions Kit	
<b>Construction</b>	Simple but effective and easy-to-use extension for Mounting Device that facilitates the testing of larger devices according to IEC 62209-2 (e.g., laptops, cameras, etc.). It is lightweight and fits easily on the upper part of the Mounting Device in place of the phone positioner.	
<b>Material</b>	POM, Acrylic glass, Foam	

## 3.2.6 System Validation Dipoles

<b>Model</b>	D-Serial	
<b>Construction</b>	Symmetrical dipole with 1/4 balun. Enables measurement of feed point impedance with NWA. Matched for use near flat phantoms filled with tissue simulating solutions.	
<b>Frequency</b>	750 MHz to 5800 MHz	
<b>Return Loss</b>	> 20 dB	
<b>Power Capability</b>	> 100 W (f < 1GHz), > 40 W (f > 1GHz)	

# FCC SAR Test Report

## 3.2.7 Tissue Simulating Liquids

For SAR measurement of the field distribution inside the phantom, the phantom must be filled with homogeneous tissue simulating liquid to a depth of at least 15 cm. For head SAR testing, the liquid height from the ear reference point (ERP) of the phantom to the liquid top surface is larger than 15 cm. For body SAR testing, the liquid height from the center of the flat phantom to the liquid top surface is larger than 15 cm. The nominal dielectric values of the tissue simulating liquids in the phantom and the tolerance of 5% are listed in Table-3.1.

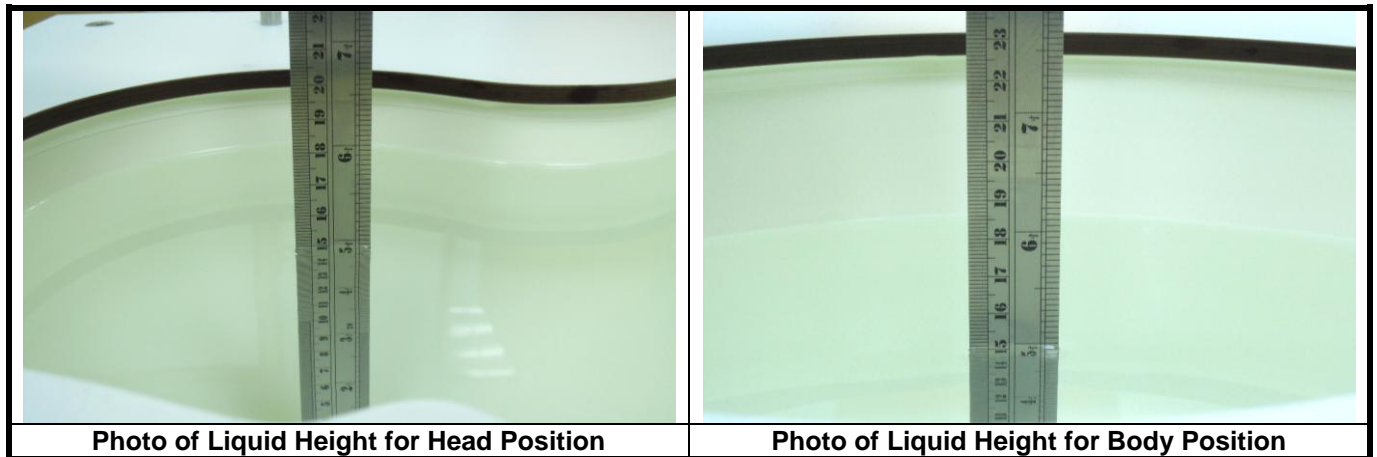

The dielectric properties of the head tissue simulating liquids are defined in IEEE 1528 and FCC OET 65 Supplement C Appendix C. For the body tissue simulating liquids, the dielectric properties are defined in FCC OET 65 Supplement C Appendix C. The dielectric properties of the tissue simulating liquids were verified prior to the SAR evaluation using an Agilent 85070D Dielectric Probe Kit and an Agilent Network Analyzer.

**Table-3.1 Targets of Tissue Simulating Liquid**

Frequency (MHz)	Target Permittivity	Range of $\pm 5\%$	Target Conductivity	Range of $\pm 5\%$
2450	52.7	50.1 ~ 55.3	1.95	1.85 ~ 2.05

The following table gives the recipes for tissue simulating liquids.

**Table-3.2 Recipes of Tissue Simulating Liquid**

Tissue Type	Bactericide	DGBE	HEC	NaCl	Sucrose	Triton X-100	Water	Diethylene Glycol Mono-hexylether
B2450	-	31.4	-	0.1	-	-	68.5	-

### 3.3 SAR System Verification

The system check verifies that the system operates within its specifications. It is performed daily or before every SAR measurement. The system check uses normal SAR measurements in the flat section of the phantom with a matched dipole at a specified distance. The system verification setup is shown as below.

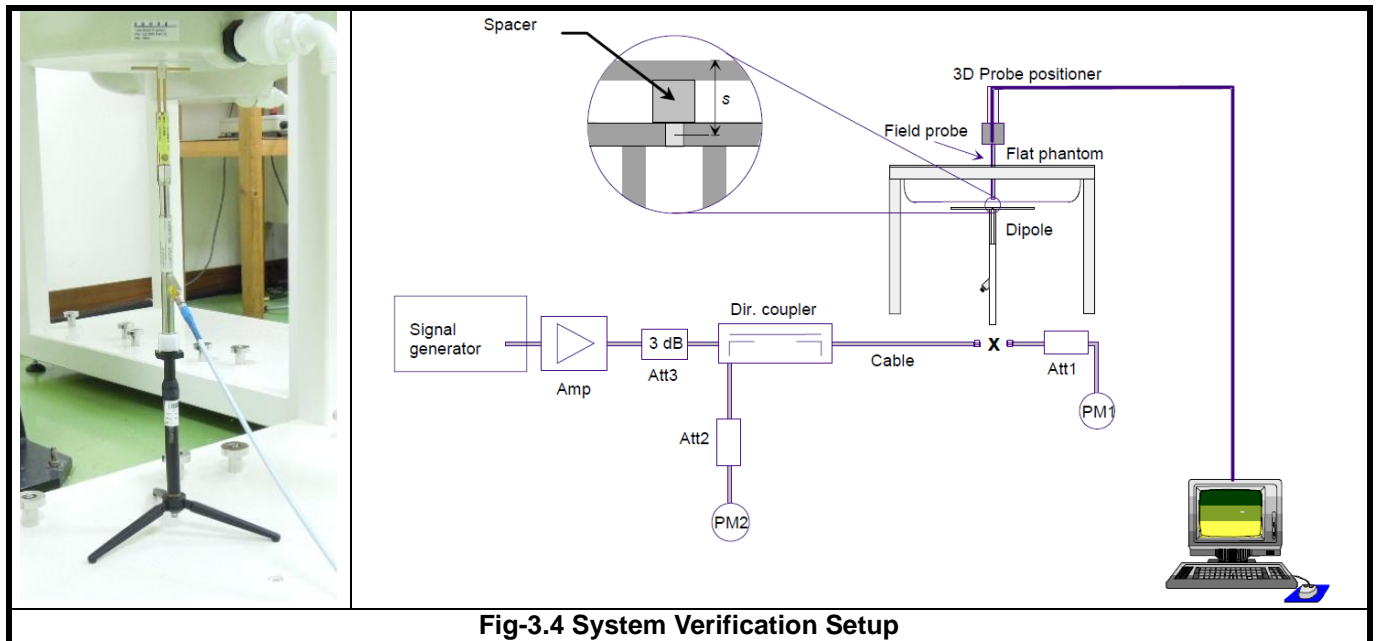

**Fig-3.4 System Verification Setup**

The validation dipole is placed beneath the flat phantom with the specific spacer in place. The distance spacer is touch the phantom surface with a light pressure at the reference marking and be oriented parallel to the long side of the phantom. The power meter PM1 measures the forward power at the location of the system check dipole connector. The signal generator is adjusted for the desired forward power (250 mW is used for 700 MHz to 3 GHz, 100 mW is used for 3.5 GHz to 6 GHz) at the dipole connector and the power meter PM2 is read at that level. After connecting the cable to the dipole, the signal generator is readjusted for the same reading at power meter PM2.

After system check testing, the SAR result will be normalized to 1W forward input power and compared with the reference SAR value derived from validation dipole certificate report. The deviation of system check should be within 10 %.

## FCC SAR Test Report

### **3.4 SAR Measurement Procedure**

According to the SAR test standard, the recommended procedure for assessing the peak spatial-average SAR value consists of the following steps:

- (a) Power reference measurement
- (b) Area scan
- (c) Zoom scan
- (d) Power drift measurement

The SAR measurement procedures for each of test conditions are as follows:

- (a) Make EUT to transmit maximum output power
- (b) Measure conducted output power through RF cable
- (c) Place the EUT in the specific position of phantom
- (d) Perform SAR testing steps on the DASY system
- (e) Record the SAR value

#### **3.4.1 Area & Zoom Scan Procedure**

First Area Scan is used to locate the approximate location(s) of the local peak SAR value(s). The measurement grid within an Area Scan is defined by the grid extent, grid step size and grid offset. Next, in order to determine the EM field distribution in a three-dimensional spatial extension, Zoom Scan is required. The Zoom Scan measures 5x5x7 points with step size 8, 8 and 5 mm for below 3 GHz, and 7x7x9 points with step size 4, 4 and 2.5 mm for above 5 GHz. The Zoom Scan is performed around the highest E-field value to determine the averaged SAR-distribution over 10 g.

#### **3.4.2 Volume Scan Procedure**

The volume scan is used for assess overlapping SAR distributions for antennas transmitting in different frequency bands. It is equivalent to an oversized zoom scan used in standalone measurements. The measurement volume will be used to enclose all the simultaneous transmitting antennas. For antennas transmitting simultaneously in different frequency bands, the volume scan is measured separately in each frequency band. In order to sum correctly to compute the 1g aggregate SAR, the EUT remain in the same test position for all measurements and all volume scan use the same spatial resolution and grid spacing. When all volume scan were completed, the software, SEMCAD postprocessor can combine and subsequently superpose these measurement data to calculating the multiband SAR.

#### **3.4.3 Power Drift Monitoring**

All SAR testing is under the EUT install full charged battery and transmit maximum output power. In DASY measurement software, the power reference measurement and power drift measurement procedures are used for monitoring the power drift of EUT during SAR test. Both these procedures measure the field at a specified reference position before and after the SAR testing. The software will calculate the field difference in dB. If the power drift more than 5%, the SAR will be retested.

## FCC SAR Test Report

---

### 3.4.4 Spatial Peak SAR Evaluation

The procedure for spatial peak SAR evaluation has been implemented according to the test standard. It can be conducted for 1g and 10g, as well as for user-specific masses. The DASY software includes all numerical procedures necessary to evaluate the spatial peak SAR value.

The base for the evaluation is a "cube" measurement. The measured volume must include the 1g and 10g cubes with the highest averaged SAR values. For that purpose, the center of the measured volume is aligned to the interpolated peak SAR value of a previously performed area scan.

The entire evaluation of the spatial peak values is performed within the post-processing engine (SEMCAD). The system always gives the maximum values for the 1g and 10g cubes. The algorithm to find the cube with highest averaged SAR is divided into the following stages:

- (a) Extraction of the measured data (grid and values) from the Zoom Scan
- (b) Calculation of the SAR value at every measurement point based on all stored data (A/D values and measurement parameters)
- (c) Generation of a high-resolution mesh within the measured volume
- (d) Interpolation of all measured values from the measurement grid to the high-resolution grid
- (e) Extrapolation of the entire 3-D field distribution to the phantom surface over the distance from sensor to surface
- (f) Calculation of the averaged SAR within masses of 1g and 10g

### 3.4.5 SAR Averaged Methods

In DASY, the interpolation and extrapolation are both based on the modified Quadratic Shepard's method. The interpolation scheme combines a least-square fitted function method and a weighted average method which are the two basic types of computational interpolation and approximation.

Extrapolation routines are used to obtain SAR values between the lowest measurement points and the inner phantom surface. The extrapolation distance is determined by the surface detection distance and the probe sensor offset. The uncertainty increases with the extrapolation distance. To keep the uncertainty within 1% for the 1 g and 10 g cubes, the extrapolation distance should not be larger than 5 mm.

## 4. SAR Measurement Evaluation

### 4.1 EUT Configuration and Setting

For WLAN SAR testing, the EUT has installed WLAN engineering testing software which can provide continuous transmitting RF signal. This RF signal utilized in SAR measurement has almost 100% duty cycle. The data rates for WLAN SAR testing were set in 1 Mbps for 802.11b, 6 Mbps for 802.11g, and MCS0 for 802.11n due to the highest RF output power.

### 4.2 EUT Testing Position

The SAR test mode has got opinion from FCC through KDB 276471. This device is tested using KDB 941225 D07. The body SAR was tested under 0.5 cm for the surfaces / slide edges where a transmitting antenna is within 2.5 cm from the edge. Since the SAR is required for antenna located within 2.5 cm from edge, SAR testing for each antenna is listed as below.

Ant-0 : Front Face, Rear Face, Top Side

Ant-0 + 1 : Front Face, Rear Face, Right Side, Top Side

### 4.3 Tissue Verification

The measuring results for tissue simulating liquid are shown as below.

Tissue Type	Frequency (MHz)	Liquid Temp. (°C)	Measured Conductivity ( $\sigma$ )	Measured Permittivity ( $\epsilon_r$ )	Target Conductivity ( $\sigma$ )	Target Permittivity ( $\epsilon_r$ )	Conductivity Deviation (%)	Permittivity Deviation (%)	Test Date
B2450	2450	21.7	2.03	52.8	1.95	52.7	4.10	0.19	Sep. 17, 2012
B2450	2450	21.1	2.00	52.4	1.95	52.7	2.56	-0.57	Sep. 18, 2012

**Note:**

The dielectric properties of the tissue simulating liquid must be measured within 24 hours before the SAR testing and within  $\pm 5\%$  of the target values. Liquid temperature during the SAR testing must be within  $\pm 2$  °C.

### 4.4 System Verification

The measuring results for system check are shown as below.

Test Date	Frequency (MHz)	1W Target SAR-1g (W/kg)	Measured SAR-1g (W/kg)	Normalized to 1W SAR-1g (W/kg)	Deviation (%)	Dipole S/N	Probe S/N	DAE S/N
Sep. 17, 2012	2450	50.00	12.5	50.00	0.00	737	3864	1277
Sep. 18, 2012	2450	50.00	12.4	49.60	-0.80	737	3864	1277

**Note:**

Comparing to the reference SAR value provided by SPEAG, the validation data should be within its specification of 10 %. The result indicates the system check can meet the variation criterion and the plots can be referred to Appendix A of this report.



### 4.5 Conducted Power Results

The measuring conducted power (Unit: dBm) are shown as below.

Band	802.11b			802.11g		
Channel	1	6	11	1	6	11
Frequency (MHz)	2412	2437	2462	2412	2437	2462
Average Power (Ant 0)	14.61	12.75	12.39	14.93	14.53	14.91

Band	802.11n (HT20)			802.11n (HT40)		
Channel	1	6	11	3	6	9
Frequency (MHz)	2412	2437	2462	2422	2437	2452
Average Power (Ant 0 + 1)	16.40	16.33	16.20	14.89	16.34	14.71

### 4.6 SAR Testing Results

#### 4.6.1 SAR Results for Body

Plot No.	Band	Mode	Test Position	Separation Distance (cm)	Channel	Tx Antenna	SAR-1g (W/kg)
1	802.11b	-	Front Face	0.5	1	0	0.016
2	802.11b	-	Rear Face	0.5	1	0	0.102
3	802.11b	-	Top Side	0.5	1	0	0.086
4	802.11g	-	Rear Face	0.5	1	0	0.132
5	802.11n	HT20	Front Face	0.5	1	1	0.038
6	802.11n	HT20	Rear Face	0.5	1	1	<b>0.227</b>
9	802.11n	HT20	Right Side	0.5	1	1	0.193
8	802.11n	HT20	Top Side	0.5	1	1	0.147

**Note:**

1. SAR is performed on the highest power channel. When the SAR value of highest power channel is less than 0.8 W/kg, SAR testing for optional channel is not required.

Test Engineer : Sam Onn





## 5. Calibration of Test Equipment

Equipment	Manufacturer	Model	SN	Cal. Date	Cal. Interval
System Validation Kit	SPEAG	D2450V2	737	Jan. 24, 2012	Annual
Dosimetric E-Field Probe	SPEAG	EX3DV4	3864	Jul. 19, 2012	Annual
Data Acquisition Electronics	SPEAG	DAE4	1277	Jul. 19, 2012	Annual
SAM Phantom	SPEAG	QD000P40CD	TP-1652	N/A	N/A
ELI Phantom	SPEAG	QDOVA001B	TP-1039	N/A	N/A
ENA Series Network Analyzer	Agilent	E5071C	MY46214281	May 14, 2012	Annual
MXG Analog Signal Generator	Agilent	N5181A	MY50143868	May 06, 2012	Annual
Power Meter	Anritsu	ML2495A	1218009	May 07, 2012	Annual
Power Sensor	Anritsu	MA2411B	1207252	May 07, 2012	Annual
EXA Spectrum Analyzer	Agilent	N9010A	MY52100136	Apr. 23, 2012	Annual
Dielectric Probe Kit	Agilent	85070D	E2-020018	May 14, 2012	Annual
Thermometer	YFE	YF-160A	110600361	Feb. 21, 2012	Annual
Directional Coupler	Woken	0110A05602O-10	11122702	Apr. 19, 2012	Annual
Power Amplifier	AR	5S1G4	0339656	Apr. 23, 2012	Annual
Attenuator	Woken	00800A1G01L-03	N/A	Apr. 19, 2012	Annual

## 6. Measurement Uncertainty

Error Description	Uncertainty Value (±%)	Probability Distribution	Divisor	Ci (1g)	Standard Uncertainty (1g)	Vi
<b>Measurement System</b>						
Probe Calibration	6.0	Normal	1	1	± 6.0 %	∞
Axial Isotropy	4.7	Rectangular	√3	0.7	± 1.9 %	∞
Hemispherical Isotropy	9.6	Rectangular	√3	0.7	± 3.9 %	∞
Boundary Effects	1.0	Rectangular	√3	1	± 0.6 %	∞
Linearity	4.7	Rectangular	√3	1	± 2.7 %	∞
System Detection Limits	1.0	Rectangular	√3	1	± 0.6 %	∞
Readout Electronics	0.6	Normal	1	1	± 0.6 %	∞
Response Time	0.0	Rectangular	√3	1	± 0.0 %	∞
Integration Time	1.7	Rectangular	√3	1	± 1.0 %	∞
RF Ambient Noise	3.0	Rectangular	√3	1	± 1.7 %	∞
RF Ambient Reflections	3.0	Rectangular	√3	1	± 1.7 %	∞
Probe Positioner	0.5	Rectangular	√3	1	± 0.3 %	∞
Probe Positioning	2.9	Rectangular	√3	1	± 1.7 %	∞
Max. SAR Eval.	2.3	Rectangular	√3	1	± 1.3 %	∞
<b>Test Sample Related</b>						
Device Positioning	3.9	Normal	1	1	± 3.9 %	31
Device Holder	2.7	Normal	1	1	± 2.7 %	19
Power Drift	5.0	Rectangular	√3	1	± 2.9 %	∞
<b>Phantom and Setup</b>						
Phantom Uncertainty	4.0	Rectangular	√3	1	± 2.3 %	∞
Liquid Conductivity (Target)	5.0	Rectangular	√3	0.64	± 1.8 %	∞
Liquid Conductivity (Meas.)	5.0	Normal	1	0.64	± 3.2 %	29
Liquid Permittivity (Target)	5.0	Rectangular	√3	0.6	± 1.7 %	∞
Liquid Permittivity (Meas.)	5.0	Normal	1	0.6	± 3.0 %	29
<b>Combined Standard Uncertainty</b>					± 11.7 %	
<b>Expanded Uncertainty (K=2)</b>					<b>± 23.4 %</b>	

Uncertainty budget for frequency range 300 MHz to 3 GHz



# FCC SAR Test Report

A D T

Error Description	Uncertainty Value (±%)	Probability Distribution	Divisor	Ci (1g)	Standard Uncertainty (1g)	Vi
<b>Measurement System</b>						
Probe Calibration	6.55	Normal	1	1	± 6.55 %	∞
Axial Isotropy	4.7	Rectangular	√3	0.7	± 1.9 %	∞
Hemispherical Isotropy	9.6	Rectangular	√3	0.7	± 3.9 %	∞
Boundary Effects	2.0	Rectangular	√3	1	± 1.2 %	∞
Linearity	4.7	Rectangular	√3	1	± 2.7 %	∞
System Detection Limits	1.0	Rectangular	√3	1	± 0.6 %	∞
Readout Electronics	0.3	Normal	1	1	± 0.3 %	∞
Response Time	0.8	Rectangular	√3	1	± 0.5 %	∞
Integration Time	2.6	Rectangular	√3	1	± 1.5 %	∞
RF Ambient Noise	3.0	Rectangular	√3	1	± 1.7 %	∞
RF Ambient Reflections	3.0	Rectangular	√3	1	± 1.7 %	∞
Probe Positioner	0.8	Rectangular	√3	1	± 0.5 %	∞
Probe Positioning	9.9	Rectangular	√3	1	± 5.7 %	∞
Max. SAR Eval.	4.0	Rectangular	√3	1	± 2.3 %	∞
<b>Test Sample Related</b>						
Device Positioning	3.9	Normal	1	1	± 3.9 %	31
Device Holder	2.7	Normal	1	1	± 2.7 %	19
Power Drift	5.0	Rectangular	√3	1	± 2.9 %	∞
<b>Phantom and Setup</b>						
Phantom Uncertainty	4.0	Rectangular	√3	1	± 2.3 %	∞
Liquid Conductivity (Target)	5.0	Rectangular	√3	0.64	± 1.8 %	∞
Liquid Conductivity (Meas.)	5.0	Normal	1	0.64	± 3.2 %	30
Liquid Permittivity (Target)	5.0	Rectangular	√3	0.6	± 1.7 %	∞
Liquid Permittivity (Meas.)	5.0	Normal	1	0.6	± 3.0 %	30
<b>Combined Standard Uncertainty</b>					± 13.4 %	
<b>Expanded Uncertainty (K=2)</b>					<b>± 26.8 %</b>	

## Uncertainty budget for frequency range 3 GHz to 6 GHz



## **7. Information on the Testing Laboratories**

We, Bureau Veritas Consumer Products Services (H.K.) Ltd., Taoyuan Branch, were founded in 1988 to provide our best service in EMC, Radio, Telecom and Safety consultation. Our laboratories are accredited and approved according to ISO/IEC 17025.

Copies of accreditation and authorization certificates of our laboratories obtained from approval agencies can be downloaded from our web site. If you have any comments, please feel free to contact us at the following:

**Taiwan HwaYa EMC/RF/Safety/Telecom Lab:**

Add: No. 19, Hwa Ya 2nd Rd, Wen Hwa Vil., Kwei Shan Hsiang, Taoyuan Hsien 333, Taiwan, R.O.C.

Tel: 886-3-318-3232

Fax: 886-3-327-0892

**Taiwan LinKo EMC/RF Lab:**

Add: No. 47, 14th Ling, Chia Pau Vil., Linkou Dist., New Taipei City 244, Taiwan, R.O.C.

Tel: 886-2-2605-2180

Fax: 886-2-2605-1924

**Taiwan HsinChu EMC/RF Lab:**

Add: No. 81-1, Lu Liao Keng, 9<sup>th</sup> Ling, Wu Lung Vil., Chiung Lin Township, Hsinchu County 307, Taiwan, R.O.C.

Tel: 886-3-593-5343

Fax: 886-3-593-5342

**Email:** [service.adt@tw.bureauveritas.com](mailto:service.adt@tw.bureauveritas.com)

**Web Site:** [www.bureauveritas-adt.com](http://www.bureauveritas-adt.com)

The road map of all our labs can be found in our web site also.

---END---



## **Appendix A. SAR Plots of System Verification**

The plots for system verification are shown as follows.

## System Check\_B2450\_120917

**DUT: Dipole 2450 MHz; Type: D2450V2; SN: 737**

Communication System: CW; Frequency: 2450 MHz; Duty Cycle: 1:1

Medium: B2450\_0917 Medium parameters used:  $f = 2450$  MHz;  $\sigma = 2.03$  mho/m;  $\epsilon_r = 52.8$ ;  $\rho = 1000$  kg/m<sup>3</sup>

Ambient Temperature : 22.4 °C ; Liquid Temperature : 21.7 °C

DASY4 Configuration:

- Probe: EX3DV4 - SN3864; ConvF(7.49, 7.49, 7.49); Calibrated: 2012/07/19
- Sensor-Surface: 2mm (Mechanical Surface Detection)
- Electronics: DAE4 Sn1277; Calibrated: 2012/07/19
- Phantom: SAM Phantom\_Left; Type: SAM V4.0; Serial: TP 1652
- Measurement SW: DASY4, V4.7 Build 80; Postprocessing SW: SEMCAD, V1.8 Build 186

**Pin=250mW/Area Scan (61x61x1):** Measurement grid: dx=15mm, dy=15mm

Maximum value of SAR (interpolated) = 19.9 mW/g

**Pin=250mW/Zoom Scan (5x5x7)/Cube 0:** Measurement grid: dx=8mm, dy=8mm, dz=5mm

Reference Value = 98.3 V/m; Power Drift = -0.020 dB

Peak SAR (extrapolated) = 26.2 W/kg

**SAR(1 g) = 12.5 mW/g; SAR(10 g) = 5.78 mW/g**

Maximum value of SAR (measured) = 18.8 mW/g

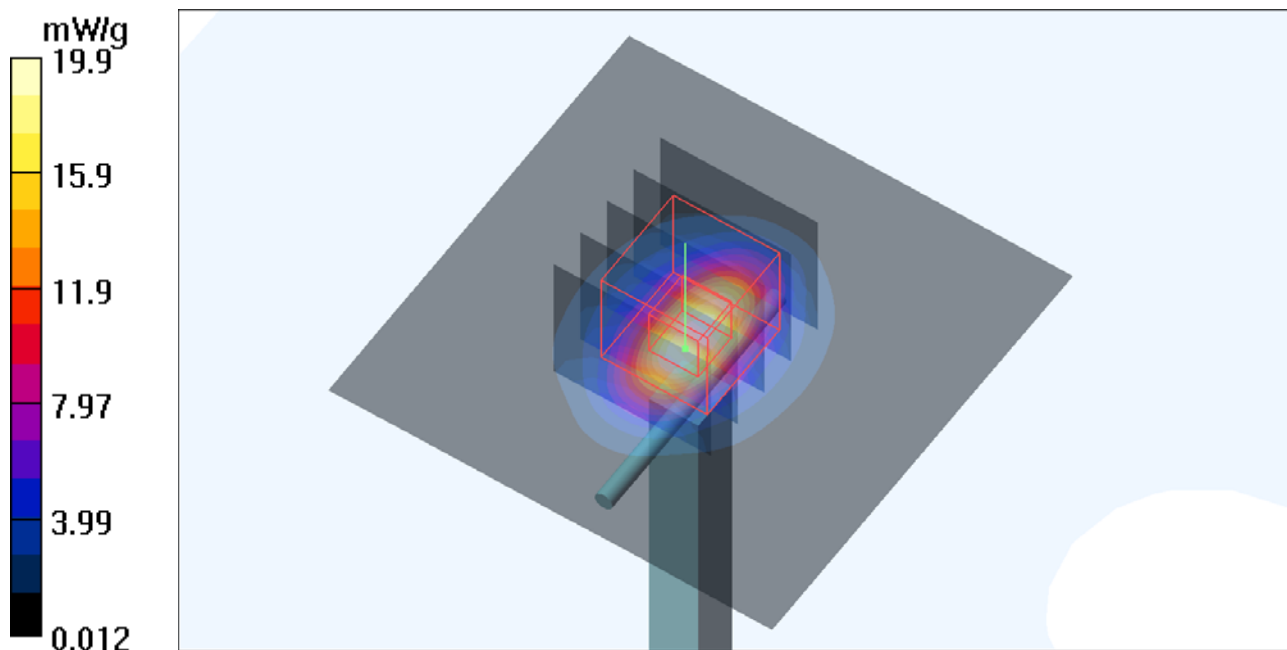

## System Check\_B2450\_120918

**DUT: Dipole 2450 MHz; Type: D2450V2; SN: 737**

Communication System: CW; Frequency: 2450 MHz; Duty Cycle: 1:1

Medium: B2450\_0918 Medium parameters used:  $f = 2450$  MHz;  $\sigma = 2$  mho/m;  $\epsilon_r = 52.4$ ;  $\rho = 1000$  kg/m<sup>3</sup>

Ambient Temperature : 22.1 °C; Liquid Temperature : 21.1 °C

DASY4 Configuration:

- Probe: EX3DV4 - SN3864; ConvF(7.49, 7.49, 7.49); Calibrated: 2012/07/19
- Sensor-Surface: 2mm (Mechanical Surface Detection)
- Electronics: DAE4 Sn1277; Calibrated: 2012/07/19
- Phantom: Flat Phantom ELI4.0; Type: QDOVA001BA; Serial: SN:1039
- Measurement SW: DASY4, V4.7 Build 80; Postprocessing SW: SEMCAD, V1.8 Build 186

**Pin=250mW/Area Scan (61x61x1):** Measurement grid: dx=15mm, dy=15mm

Maximum value of SAR (interpolated) = 19.6 mW/g

**Pin=250mW/Zoom Scan (5x5x7)/Cube 0:** Measurement grid: dx=8mm, dy=8mm, dz=5mm

Reference Value = 98.3 V/m; Power Drift = -0.020 dB

Peak SAR (extrapolated) = 25.8 W/kg

**SAR(1 g) = 12.4 mW/g; SAR(10 g) = 5.7 mW/g**

Maximum value of SAR (measured) = 18.5 mW/g

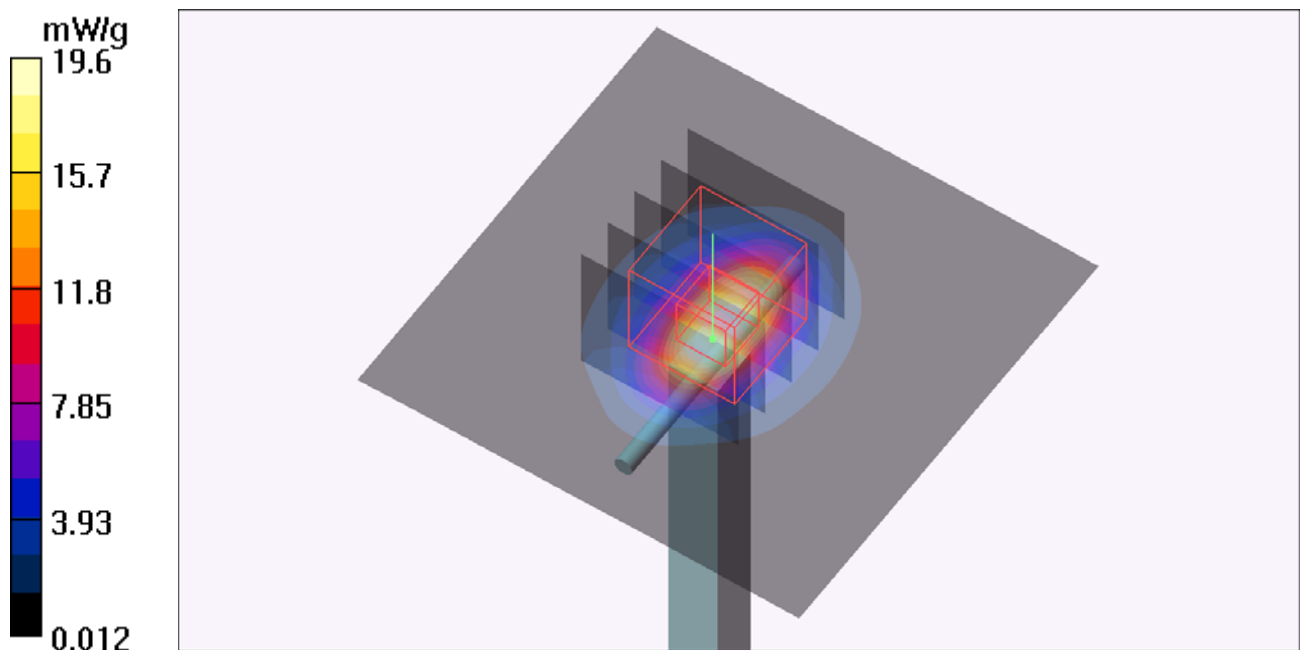



## **Appendix B. SAR Plots of SAR Measurement**

The plots for SAR measurement are shown as follows.



### P01 802.11b\_Front Face\_0.5 cm\_Ch1\_ANT 0

**DUT: 120821C27**

Communication System: 802.11b; Frequency: 2412 MHz; Duty Cycle: 1:1

Medium: B2450\_0917 Medium parameters used:  $f = 2412$  MHz;  $\sigma = 1.97$  mho/m;  $\epsilon_r = 52.9$ ;  $\rho = 1000$  kg/m<sup>3</sup>

Ambient Temperature : 22.4 °C ; Liquid Temperature : 21.7 °C

DASY4 Configuration:

- Probe: EX3DV4 - SN3864; ConvF(7.49, 7.49, 7.49); Calibrated: 2012/07/19
- Sensor-Surface: 2mm (Mechanical Surface Detection)
- Electronics: DAE4 Sn1277; Calibrated: 2012/07/19
- Phantom: SAM Phantom\_Left; Type: SAM V4.0; Serial: TP 1652
- Measurement SW: DASY4, V4.7 Build 80; Postprocessing SW: SEMCAD, V1.8 Build 186

**Ch1/Area Scan (51x91x1):** Measurement grid: dx=20mm, dy=20mm

Maximum value of SAR (interpolated) = 0.030 mW/g

**Ch1/Zoom Scan (5x5x7)/Cube 0:** Measurement grid: dx=8mm, dy=8mm, dz=5mm

Reference Value = 0.750 V/m; Power Drift = 0.12 dB

Peak SAR (extrapolated) = 0.038 W/kg

**SAR(1 g) = 0.016 mW/g; SAR(10 g) = 0.00611 mW/g**

Maximum value of SAR (measured) = 0.026 mW/g

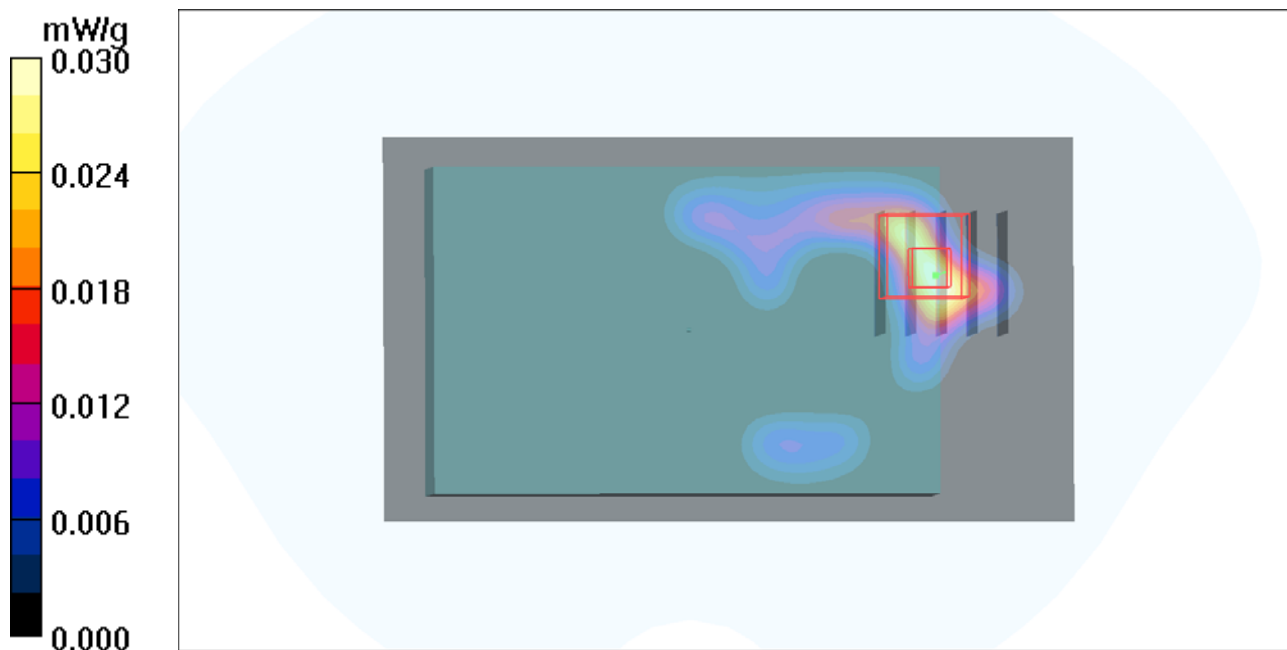

### P02 802.11b\_Rear Face\_0.5 cm\_Ch1\_ANT 0

**DUT: 120821C27**

Communication System: 802.11b; Frequency: 2412 MHz; Duty Cycle: 1:1

Medium: B2450\_0917 Medium parameters used:  $f = 2412$  MHz;  $\sigma = 1.97$  mho/m;  $\epsilon_r = 52.9$ ;  $\rho = 1000$  kg/m<sup>3</sup>

Ambient Temperature : 22.4 °C ; Liquid Temperature : 21.7 °C

DASY4 Configuration:

- Probe: EX3DV4 - SN3864; ConvF(7.49, 7.49, 7.49); Calibrated: 2012/07/19
- Sensor-Surface: 2mm (Mechanical Surface Detection)
- Electronics: DAE4 Sn1277; Calibrated: 2012/07/19
- Phantom: SAM Phantom\_Left; Type: SAM V4.0; Serial: TP 1652
- Measurement SW: DASY4, V4.7 Build 80; Postprocessing SW: SEMCAD, V1.8 Build 186

**Ch1/Area Scan (51x91x1):** Measurement grid: dx=20mm, dy=20mm

Maximum value of SAR (interpolated) = 0.387 mW/g

**Ch1/Zoom Scan (5x5x7)/Cube 0:** Measurement grid: dx=8mm, dy=8mm, dz=5mm

Reference Value = 1.75 V/m; Power Drift = 0.135 dB

Peak SAR (extrapolated) = 0.224 W/kg

**SAR(1 g) = 0.102 mW/g; SAR(10 g) = 0.047 mW/g**

Maximum value of SAR (measured) = 0.150 mW/g

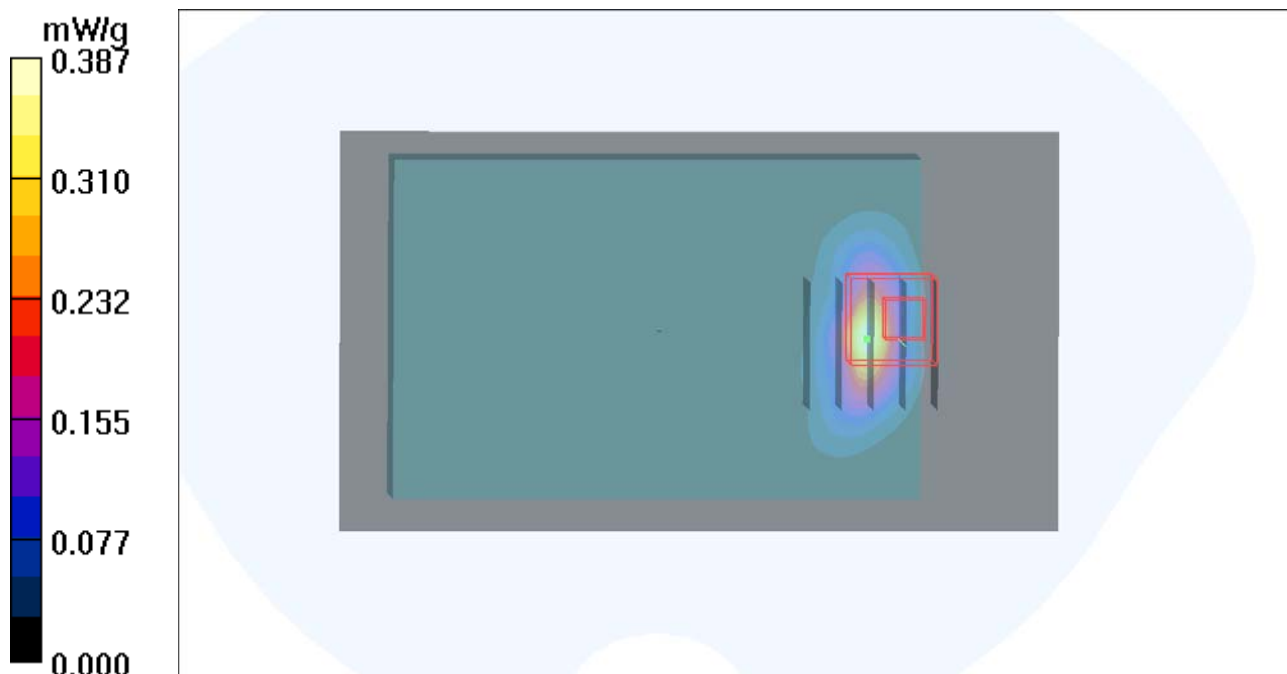

### P03 802.11b\_Top Side\_0.5 cm\_Ch1\_ANT 0

**DUT: 120821C27**

Communication System: 802.11b; Frequency: 2412 MHz; Duty Cycle: 1:1

Medium: B2450\_0917 Medium parameters used:  $f = 2412$  MHz;  $\sigma = 1.97$  mho/m;  $\epsilon_r = 52.9$ ;  $\rho = 1000$  kg/m<sup>3</sup>

Ambient Temperature : 22.4 °C ; Liquid Temperature : 21.7 °C

DASY4 Configuration:

- Probe: EX3DV4 - SN3864; ConvF(7.49, 7.49, 7.49); Calibrated: 2012/07/19
- Sensor-Surface: 2mm (Mechanical Surface Detection)
- Electronics: DAE4 Sn1277; Calibrated: 2012/07/19
- Phantom: SAM Phantom\_Left; Type: SAM V4.0; Serial: TP 1652
- Measurement SW: DASY4, V4.7 Build 80; Postprocessing SW: SEMCAD, V1.8 Build 186

**Ch1/Area Scan (41x51x1):** Measurement grid: dx=20mm, dy=20mm

Maximum value of SAR (interpolated) = 0.115 mW/g

**Ch1/Zoom Scan (5x5x7)/Cube 0:** Measurement grid: dx=8mm, dy=8mm, dz=5mm

Reference Value = 4.71 V/m; Power Drift = 0.155 dB

Peak SAR (extrapolated) = 0.179 W/kg

**SAR(1 g) = 0.086 mW/g; SAR(10 g) = 0.040 mW/g**

Maximum value of SAR (measured) = 0.138 mW/g

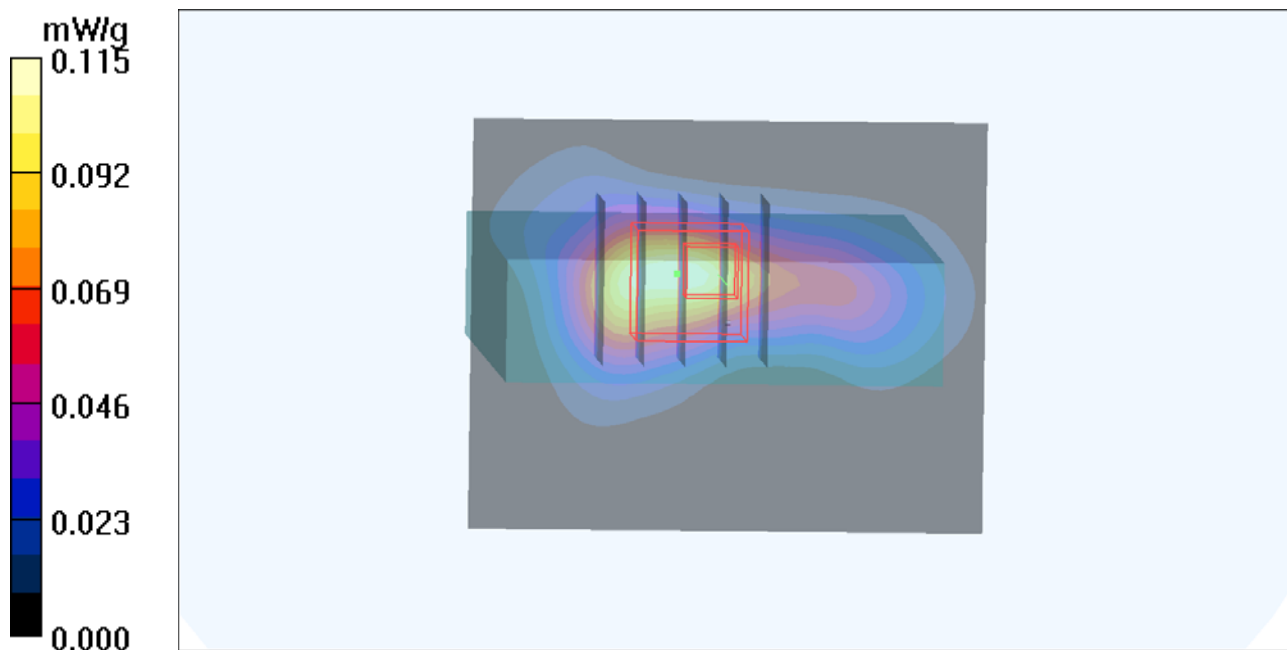

### P04 802.11g\_Rear Face\_0.5 cm\_Ch1\_ANT 0

**DUT: 120821C27**

Communication System: WLAN\_2.4G; Frequency: 2412 MHz; Duty Cycle: 1:1

Medium: B2450\_0917 Medium parameters used:  $f = 2412$  MHz;  $\sigma = 1.97$  mho/m;  $\epsilon_r = 52.9$ ;  $\rho = 1000$  kg/m<sup>3</sup>

Ambient Temperature : 22.4 °C ; Liquid Temperature : 21.7 °C

DASY4 Configuration:

- Probe: EX3DV4 - SN3864; ConvF(7.49, 7.49, 7.49); Calibrated: 2012/07/19
- Sensor-Surface: 2mm (Mechanical Surface Detection)
- Electronics: DAE4 Sn1277; Calibrated: 2012/07/19
- Phantom: SAM Phantom\_Left; Type: SAM V4.0; Serial: TP 1652
- Measurement SW: DASY4, V4.7 Build 80; Postprocessing SW: SEMCAD, V1.8 Build 186

**Ch1/Area Scan (51x81x1):** Measurement grid: dx=20mm, dy=20mm

Maximum value of SAR (interpolated) = 0.321 mW/g

**Ch1/Zoom Scan (5x5x7)/Cube 0:** Measurement grid: dx=8mm, dy=8mm, dz=5mm

Reference Value = 1.90 V/m; Power Drift = -0.125 dB

Peak SAR (extrapolated) = 0.300 W/kg

**SAR(1 g) = 0.132 mW/g; SAR(10 g) = 0.062 mW/g**

Maximum value of SAR (measured) = 0.203 mW/g

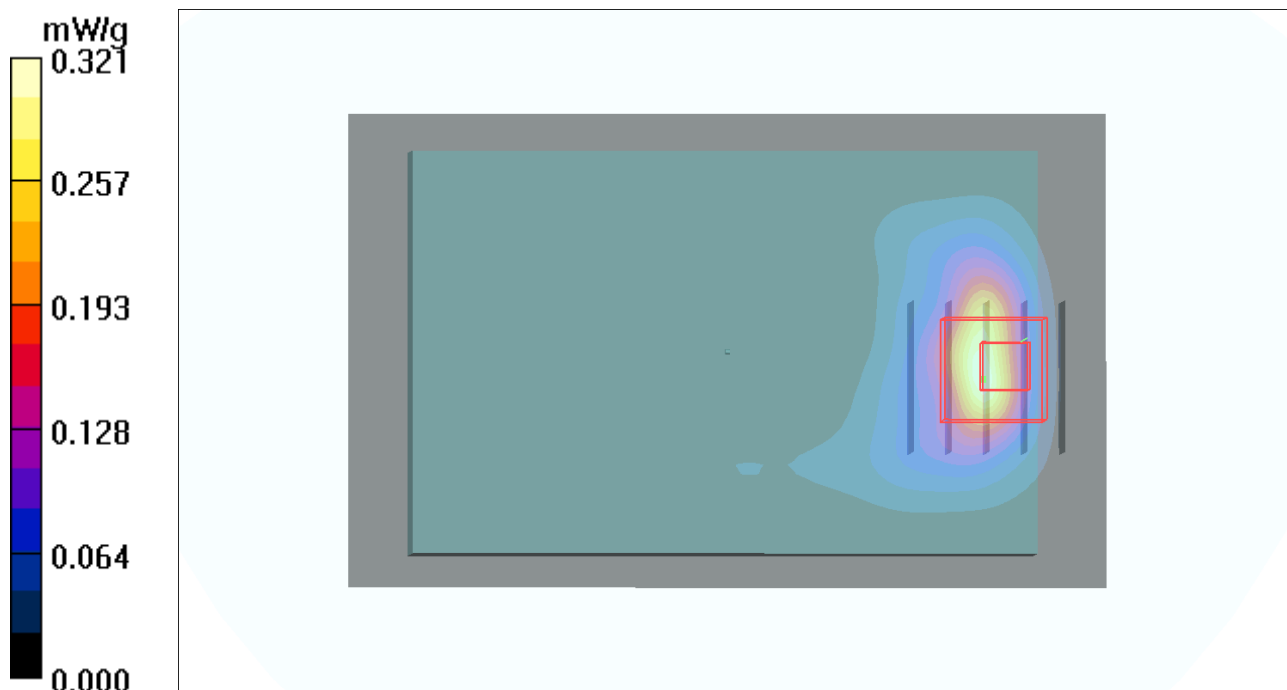

### P05 802.11n\_HT20\_Front Face\_0.5 cm\_Ch01\_ANT 0+1

**DUT: 120821C27**

Communication System: WLAN\_2.4G; Frequency: 2412 MHz; Duty Cycle: 1:1

Medium: B2450\_0917 Medium parameters used:  $f = 2412$  MHz;  $\sigma = 1.97$  mho/m;  $\epsilon_r = 52.9$ ;  $\rho = 1000$  kg/m<sup>3</sup>

Ambient Temperature : 22.4 °C ; Liquid Temperature : 21.7 °C

DASY4 Configuration:

- Probe: EX3DV4 - SN3864; ConvF(7.49, 7.49, 7.49); Calibrated: 2012/07/19
- Sensor-Surface: 2mm (Mechanical Surface Detection)
- Electronics: DAE4 Sn1277; Calibrated: 2012/07/19
- Phantom: SAM Phantom\_Left; Type: SAM V4.0; Serial: TP 1652
- Measurement SW: DASY4, V4.7 Build 80; Postprocessing SW: SEMCAD, V1.8 Build 186

**Ch01/Area Scan (51x81x1):** Measurement grid: dx=20mm, dy=20mm

Maximum value of SAR (interpolated) = 0.068 mW/g

**Ch01/Zoom Scan (5x5x7)/Cube 0:** Measurement grid: dx=8mm, dy=8mm, dz=5mm

Reference Value = 3.56 V/m; Power Drift = -0.113 dB

Peak SAR (extrapolated) = 0.075 W/kg

**SAR(1 g) = 0.038 mW/g; SAR(10 g) = 0.019 mW/g**

Maximum value of SAR (measured) = 0.057 mW/g

**Ch01/Zoom Scan (5x5x7)/Cube 1:** Measurement grid: dx=8mm, dy=8mm, dz=5mm

Reference Value = 3.56 V/m; Power Drift = -0.113 dB

Peak SAR (extrapolated) = 0.057 W/kg

**SAR(1 g) = 0.034 mW/g; SAR(10 g) = 0.016 mW/g**

Maximum value of SAR (measured) = 0.049 mW/g

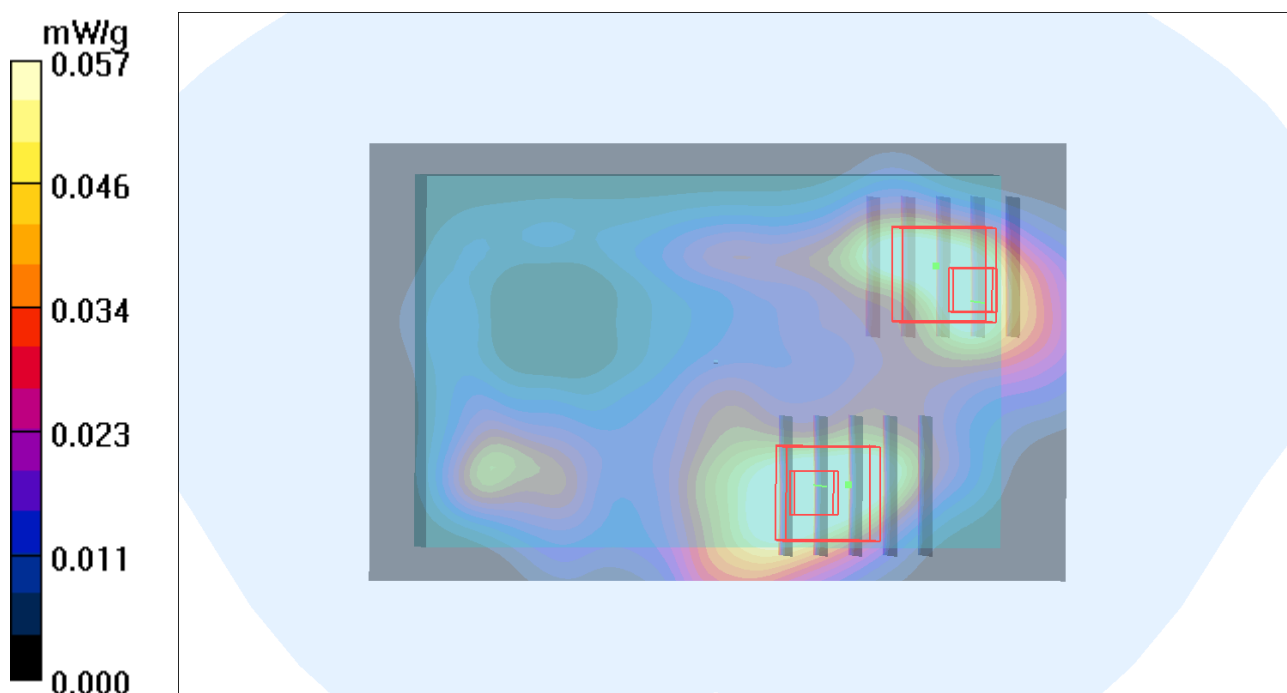

### P06 802.11n\_HT20\_Rear Face\_0.5 cm\_Ch01\_ANT 0+1

**DUT: 120821C27**

Communication System: WLAN\_2.4G; Frequency: 2412 MHz; Duty Cycle: 1:1

Medium: B2450\_0917 Medium parameters used:  $f = 2412$  MHz;  $\sigma = 1.97$  mho/m;  $\epsilon_r = 52.9$ ;  $\rho = 1000$  kg/m<sup>3</sup>

Ambient Temperature : 22.4 °C ; Liquid Temperature : 21.7 °C

DASY4 Configuration:

- Probe: EX3DV4 - SN3864; ConvF(7.49, 7.49, 7.49); Calibrated: 2012/07/19
- Sensor-Surface: 2mm (Mechanical Surface Detection)
- Electronics: DAE4 Sn1277; Calibrated: 2012/07/19
- Phantom: SAM Phantom\_Left; Type: SAM V4.0; Serial: TP 1652
- Measurement SW: DASY4, V4.7 Build 80; Postprocessing SW: SEMCAD, V1.8 Build 186

**Ch01/Area Scan (51x81x1):** Measurement grid: dx=20mm, dy=20mm

Maximum value of SAR (interpolated) = 0.392 mW/g

**Ch01/Zoom Scan (5x5x7)/Cube 1:** Measurement grid: dx=8mm, dy=8mm, dz=5mm

Reference Value = 8.48 V/m; Power Drift = -0.148 dB

Peak SAR (extrapolated) = 0.550 W/kg

**SAR(1 g) = 0.227 mW/g; SAR(10 g) = 0.103 mW/g**

Maximum value of SAR (measured) = 0.375 mW/g

**Ch01/Zoom Scan (5x5x7)/Cube 0:** Measurement grid: dx=8mm, dy=8mm, dz=5mm

Reference Value = 8.48 V/m; Power Drift = -0.148 dB

Peak SAR (extrapolated) = 0.423 W/kg

**SAR(1 g) = 0.188 mW/g; SAR(10 g) = 0.089 mW/g**

Maximum value of SAR (measured) = 0.288 mW/g

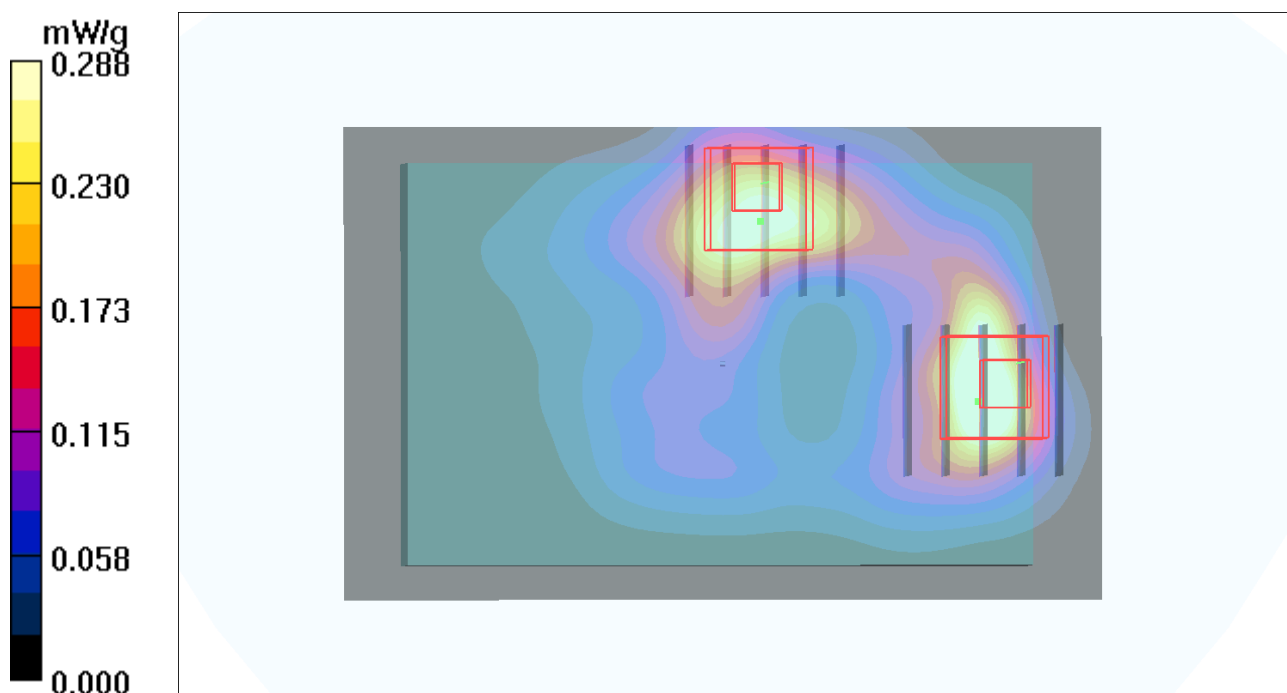

# 1g/10g Averaged SAR

SAR; Zoom Scan: Value Along Z, X=3, Y=2

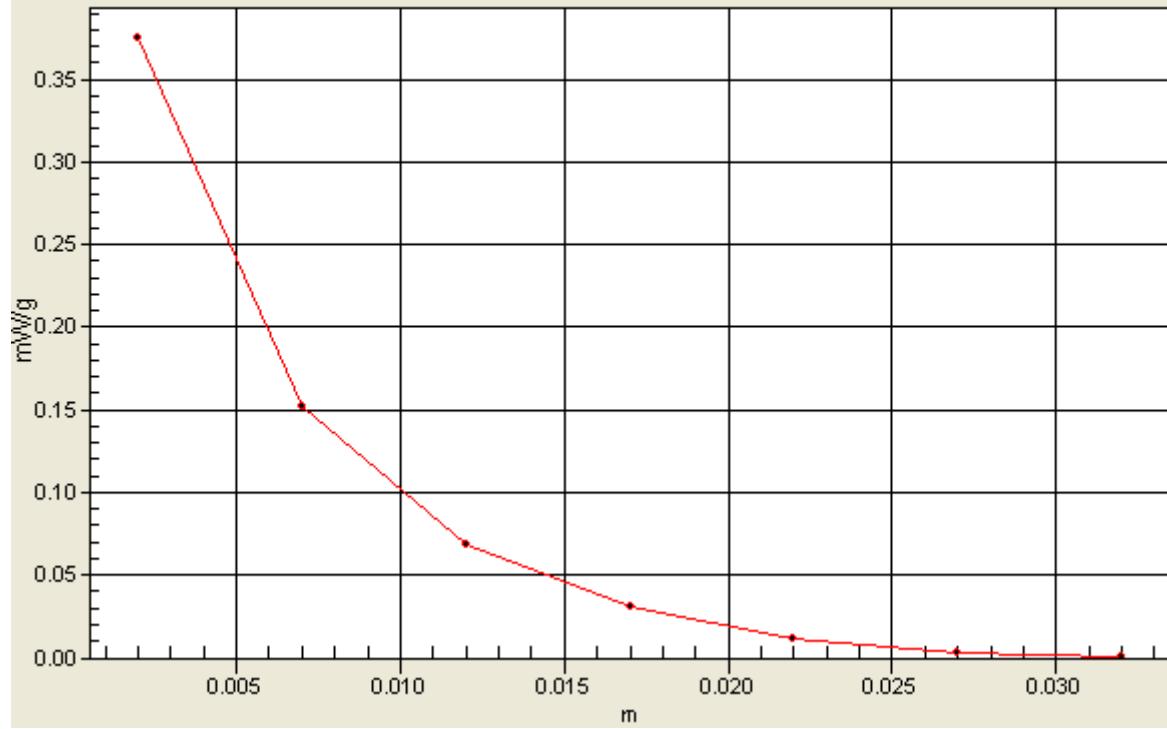

### P09 802.11n\_HT20\_Right Side\_0.5 cm\_Ch01\_ANT 0+1

**DUT: 120821C27**

Communication System: WLAN\_2.4G; Frequency: 2412 MHz; Duty Cycle: 1:1

Medium: B2450\_0918 Medium parameters used:  $f = 2412$  MHz;  $\sigma = 1.95$  mho/m;  $\epsilon_r = 52.4$ ;  $\rho = 1000$  kg/m<sup>3</sup>

Ambient Temperature : 22.1 °C ; Liquid Temperature : 21.1 °C

DASY4 Configuration:

- Probe: EX3DV4 - SN3864; ConvF(7.49, 7.49, 7.49); Calibrated: 2012/07/19
- Sensor-Surface: 2mm (Mechanical Surface Detection)
- Electronics: DAE4 Sn1277; Calibrated: 2012/07/19
- Phantom: Flat Phantom ELI4.0; Type: QDOVA001BA; Serial: SN:1039
- Measurement SW: DASY4, V4.7 Build 80; Postprocessing SW: SEMCAD, V1.8 Build 186

**Ch01/Area Scan (41x81x1):** Measurement grid: dx=20mm, dy=20mm

Maximum value of SAR (interpolated) = 0.215 mW/g

**Ch01/Zoom Scan (5x5x7)/Cube 0:** Measurement grid: dx=8mm, dy=8mm, dz=5mm

Reference Value = 9.42 V/m; Power Drift = -0.176 dB

Peak SAR (extrapolated) = 0.461 W/kg

**SAR(1 g) = 0.193 mW/g; SAR(10 g) = 0.083 mW/g**

Maximum value of SAR (measured) = 0.332 mW/g

**Ch01/Zoom Scan (5x5x7)/Cube 1:** Measurement grid: dx=8mm, dy=8mm, dz=5mm

Reference Value = 9.42 V/m; Power Drift = -0.176 dB

Peak SAR (extrapolated) = 0.218 W/kg

**SAR(1 g) = 0.110 mW/g; SAR(10 g) = 0.055 mW/g**

Maximum value of SAR (measured) = 0.158 mW/g

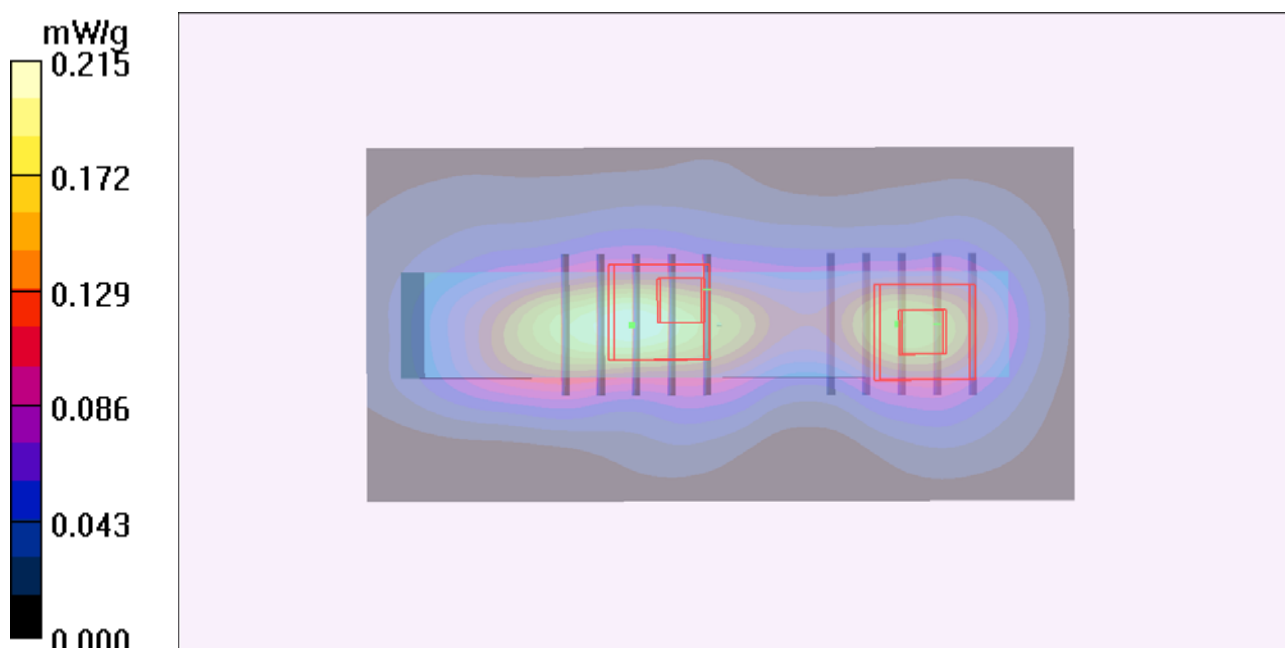



### P08 802.11n\_HT20\_Top Side\_0.5 cm\_Ch01\_ANT 0+1

**DUT: 120821C27**

Communication System: WLAN\_2.4G; Frequency: 2412 MHz; Duty Cycle: 1:1

Medium: B2450\_0917 Medium parameters used:  $f = 2412$  MHz;  $\sigma = 1.97$  mho/m;  $\epsilon_r = 52.9$ ;  $\rho = 1000$  kg/m<sup>3</sup>

Ambient Temperature : 22.4 °C ; Liquid Temperature : 21.7 °C

DASY4 Configuration:

- Probe: EX3DV4 - SN3864; ConvF(7.49, 7.49, 7.49); Calibrated: 2012/07/19
- Sensor-Surface: 2mm (Mechanical Surface Detection)
- Electronics: DAE4 Sn1277; Calibrated: 2012/07/19
- Phantom: SAM Phantom\_Left; Type: SAM V4.0; Serial: TP 1652
- Measurement SW: DASY4, V4.7 Build 80; Postprocessing SW: SEMCAD, V1.8 Build 186

**Ch01/Area Scan (41x61x1):** Measurement grid: dx=20mm, dy=20mm

Maximum value of SAR (interpolated) = 0.173 mW/g

**Ch01/Zoom Scan (5x5x7)/Cube 0:** Measurement grid: dx=8mm, dy=8mm, dz=5mm

Reference Value = 6.23 V/m; Power Drift = -0.069 dB

Peak SAR (extrapolated) = 0.303 W/kg

**SAR(1 g) = 0.147 mW/g; SAR(10 g) = 0.071 mW/g**

Maximum value of SAR (measured) = 0.205 mW/g

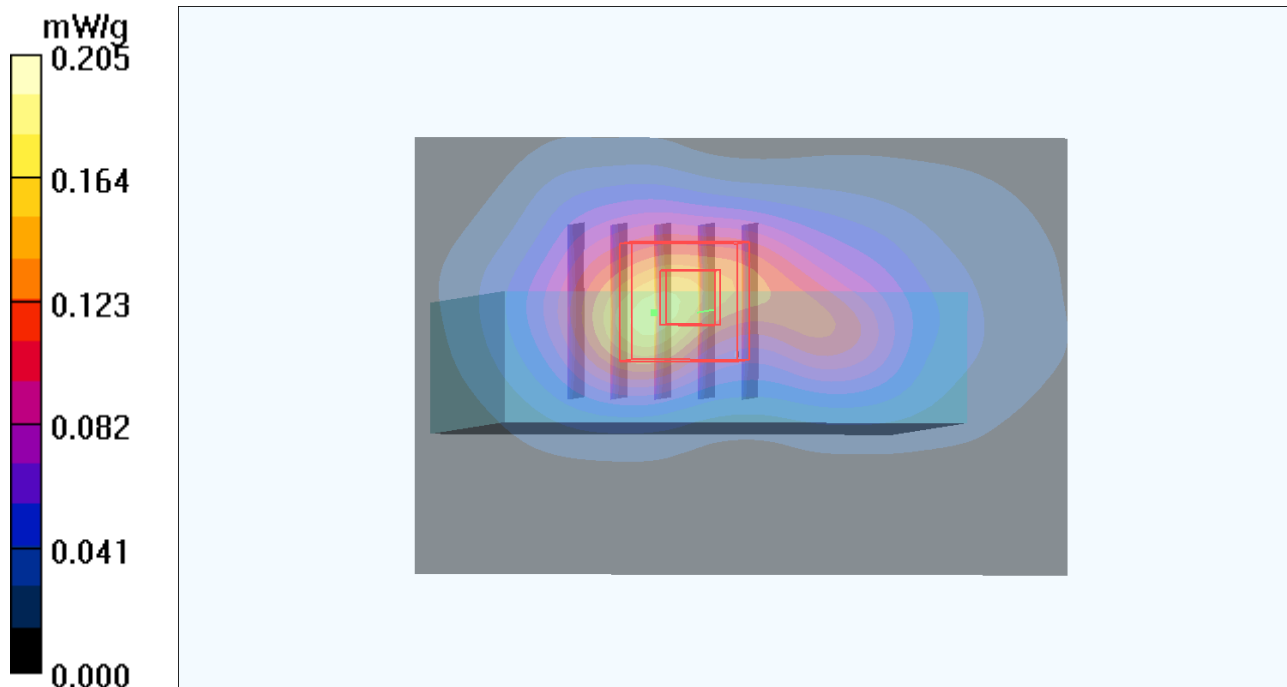



## **Appendix C. Calibration Certificate for Probe and Dipole**

The SPEAG calibration certificates are shown as follows.



Accredited by the Swiss Accreditation Service (SAS)  
The Swiss Accreditation Service is one of the signatories to the EA  
Multilateral Agreement for the recognition of calibration certificates

Accreditation No.: **SCS 108**

Client **B.V.ADT (Auden)**

Certificate No: **D2450V2-737\_Jan12**

## CALIBRATION CERTIFICATE

Object **D2450V2 - SN: 737**

Calibration procedure(s) **QA CAL-05.v8  
Calibration procedure for dipole validation kits above 700 MHz**

Calibration date: **January 24, 2012**

This calibration certificate documents the traceability to national standards, which realize the physical units of measurements (SI).  
The measurements and the uncertainties with confidence probability are given on the following pages and are part of the certificate.

All calibrations have been conducted in the closed laboratory facility: environment temperature ( $22 \pm 3$ )°C and humidity < 70%.

Calibration Equipment used (M&TE critical for calibration)

Primary Standards	ID #	Cal Date (Certificate No.)	Scheduled Calibration
Power meter EPM-442A	GB37480704	05-Oct-11 (No. 217-01451)	Oct-12
Power sensor HP 8481A	US37292783	05-Oct-11 (No. 217-01451)	Oct-12
Reference 20 dB Attenuator	SN: 5086 (20g)	29-Mar-11 (No. 217-01368)	Apr-12
Type-N mismatch combination	SN: 5047.2 / 06327	29-Mar-11 (No. 217-01371)	Apr-12
Reference Probe ES3DV3	SN: 3205	30-Dec-11 (No. ES3-3205_Dec11)	Dec-12
DAE4	SN: 601	04-Jul-11 (No. DAE4-601_Jul11)	Jul-12
Secondary Standards	ID #	Check Date (in house)	Scheduled Check
Power sensor HP 8481A	MY41092317	18-Oct-02 (in house check Oct-11)	In house check: Oct-13
RF generator R&S SMT-06	100005	04-Aug-99 (in house check Oct-11)	In house check: Oct-13
Network Analyzer HP 8753E	US37390585 S4206	18-Oct-01 (in house check Oct-11)	In house check: Oct-12

	Name	Function	Signature
Calibrated by:	Israe El-Naouq	Laboratory Technician	
Approved by:	Katja Pokovic	Technical Manager	

Issued: January 24, 2012

This calibration certificate shall not be reproduced except in full without written approval of the laboratory.



Accredited by the Swiss Accreditation Service (SAS)  
The Swiss Accreditation Service is one of the signatories to the EA  
Multilateral Agreement for the recognition of calibration certificates

Accreditation No.: **SCS 108**

**Glossary:**

TSL	tissue simulating liquid
ConvF	sensitivity in TSL / NORM x,y,z
N/A	not applicable or not measured

**Calibration is Performed According to the Following Standards:**

- IEEE Std 1528-2003, "IEEE Recommended Practice for Determining the Peak Spatial-Averaged Specific Absorption Rate (SAR) in the Human Head from Wireless Communications Devices: Measurement Techniques", December 2003
- IEC 62209-1, "Procedure to measure the Specific Absorption Rate (SAR) for hand-held devices used in close proximity to the ear (frequency range of 300 MHz to 3 GHz)", February 2005
- Federal Communications Commission Office of Engineering & Technology (FCC OET), "Evaluating Compliance with FCC Guidelines for Human Exposure to Radiofrequency Electromagnetic Fields; Additional Information for Evaluating Compliance of Mobile and Portable Devices with FCC Limits for Human Exposure to Radiofrequency Emissions", Supplement C (Edition 01-01) to Bulletin 65

**Additional Documentation:**

- DASY4/5 System Handbook

**Methods Applied and Interpretation of Parameters:**

- Measurement Conditions:* Further details are available from the Validation Report at the end of the certificate. All figures stated in the certificate are valid at the frequency indicated.
- Antenna Parameters with TSL:* The dipole is mounted with the spacer to position its feed point exactly below the center marking of the flat phantom section, with the arms oriented parallel to the body axis.
- Feed Point Impedance and Return Loss:* These parameters are measured with the dipole positioned under the liquid filled phantom. The impedance stated is transformed from the measurement at the SMA connector to the feed point. The Return Loss ensures low reflected power. No uncertainty required.
- Electrical Delay:* One-way delay between the SMA connector and the antenna feed point. No uncertainty required.
- SAR measured:* SAR measured at the stated antenna input power.
- SAR normalized:* SAR as measured, normalized to an input power of 1 W at the antenna connector.
- SAR for nominal TSL parameters:* The measured TSL parameters are used to calculate the nominal SAR result.

## Measurement Conditions

DASY system configuration, as far as not given on page 1.

DASY Version	DASY5	V52.8.0
Extrapolation	Advanced Extrapolation	
Phantom	Modular Flat Phantom	
Distance Dipole Center - TSL	10 mm	with Spacer
Zoom Scan Resolution	dx, dy, dz = 5 mm	
Frequency	2450 MHz $\pm$ 1 MHz	

## Head TSL parameters

The following parameters and calculations were applied.

	Temperature	Permittivity	Conductivity
Nominal Head TSL parameters	22.0 °C	39.2	1.80 mho/m
Measured Head TSL parameters	(22.0 $\pm$ 0.2) °C	39.2 $\pm$ 6 %	1.85 mho/m $\pm$ 6 %
Head TSL temperature change during test	< 0.5 °C	----	----

## SAR result with Head TSL

SAR averaged over 1 cm <sup>3</sup> (1 g) of Head TSL	Condition	
SAR measured	250 mW input power	13.4 mW / g
SAR for nominal Head TSL parameters	normalized to 1W	<b>52.9 mW / g <math>\pm</math> 17.0 % (k=2)</b>

SAR averaged over 10 cm <sup>3</sup> (10 g) of Head TSL	condition	
SAR measured	250 mW input power	6.18 mW / g
SAR for nominal Head TSL parameters	normalized to 1W	<b>24.5 mW / g <math>\pm</math> 16.5 % (k=2)</b>

## Body TSL parameters

The following parameters and calculations were applied.

	Temperature	Permittivity	Conductivity
Nominal Body TSL parameters	22.0 °C	52.7	1.95 mho/m
Measured Body TSL parameters	(22.0 $\pm$ 0.2) °C	50.6 $\pm$ 6 %	2.01 mho/m $\pm$ 6 %
Body TSL temperature change during test	< 0.5 °C	----	----

## SAR result with Body TSL

SAR averaged over 1 cm <sup>3</sup> (1 g) of Body TSL	Condition	
SAR measured	250 mW input power	12.8 mW / g
SAR for nominal Body TSL parameters	normalized to 1W	<b>50.0 mW / g <math>\pm</math> 17.0 % (k=2)</b>

SAR averaged over 10 cm <sup>3</sup> (10 g) of Body TSL	condition	
SAR measured	250 mW input power	5.91 mW / g
SAR for nominal Body TSL parameters	normalized to 1W	<b>23.3 mW / g <math>\pm</math> 16.5 % (k=2)</b>

## Appendix

### Antenna Parameters with Head TSL

Impedance, transformed to feed point	54.3 $\Omega$ + 4.3 j $\Omega$
Return Loss	- 24.7 dB

### Antenna Parameters with Body TSL

Impedance, transformed to feed point	50.6 $\Omega$ + 5.3 j $\Omega$
Return Loss	- 25.6 dB

### General Antenna Parameters and Design

Electrical Delay (one direction)	1.161 ns
----------------------------------	----------

After long term use with 100W radiated power, only a slight warming of the dipole near the feedpoint can be measured.

The dipole is made of standard semirigid coaxial cable. The center conductor of the feeding line is directly connected to the second arm of the dipole. The antenna is therefore short-circuited for DC-signals. On some of the dipoles, small end caps are added to the dipole arms in order to improve matching when loaded according to the position as explained in the "Measurement Conditions" paragraph. The SAR data are not affected by this change. The overall dipole length is still according to the Standard.

No excessive force must be applied to the dipole arms, because they might bend or the soldered connections near the feedpoint may be damaged.

### Additional EUT Data

Manufactured by	SPEAG
Manufactured on	August 26, 2003

## DASY5 Validation Report for Head TSL

Date: 24.01.2012

Test Laboratory: SPEAG, Zurich, Switzerland

**DUT: Dipole 2450 MHz; Type: D2450V2; Serial: D2450V2 - SN: 737**

Communication System: CW; Frequency: 2450 MHz

Medium parameters used:  $f = 2450$  MHz;  $\sigma = 1.85$  mho/m;  $\epsilon_r = 39.2$ ;  $\rho = 1000$  kg/m<sup>3</sup>

Phantom section: Flat Section

Measurement Standard: DASY5 (IEEE/IEC/ANSI C63.19-2007)

DASY52 Configuration:

- Probe: ES3DV3 - SN3205; ConvF(4.45, 4.45, 4.45); Calibrated: 30.12.2011
- Sensor-Surface: 3mm (Mechanical Surface Detection)
- Electronics: DAE4 Sn601; Calibrated: 04.07.2011
- Phantom: Flat Phantom 5.0 (front); Type: QD000P50AA; Serial: 1001
- DASY52 52.8.0(692); SEMCAD X 14.6.4(4989)

### **Dipole Calibration for Head Tissue/Pin=250 mW, d=10mm/Zoom Scan (7x7x7)/Cube 0:**

Measurement grid: dx=5mm, dy=5mm, dz=5mm

Reference Value = 99.933 V/m; Power Drift = 0.08 dB

Peak SAR (extrapolated) = 27.6400

**SAR(1 g) = 13.4 mW/g; SAR(10 g) = 6.18 mW/g**

Maximum value of SAR (measured) = 17.183 mW/g

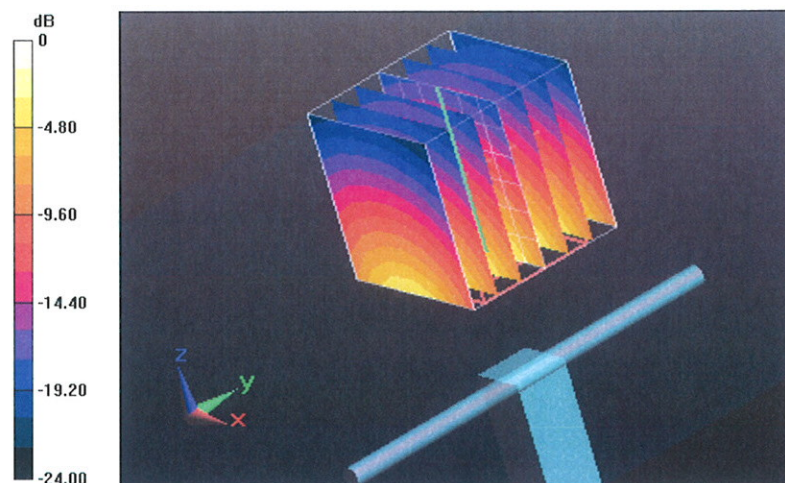

0 dB = 17.180mW/g = 24.70 dB mW/g

# Impedance Measurement Plot for Head TSL

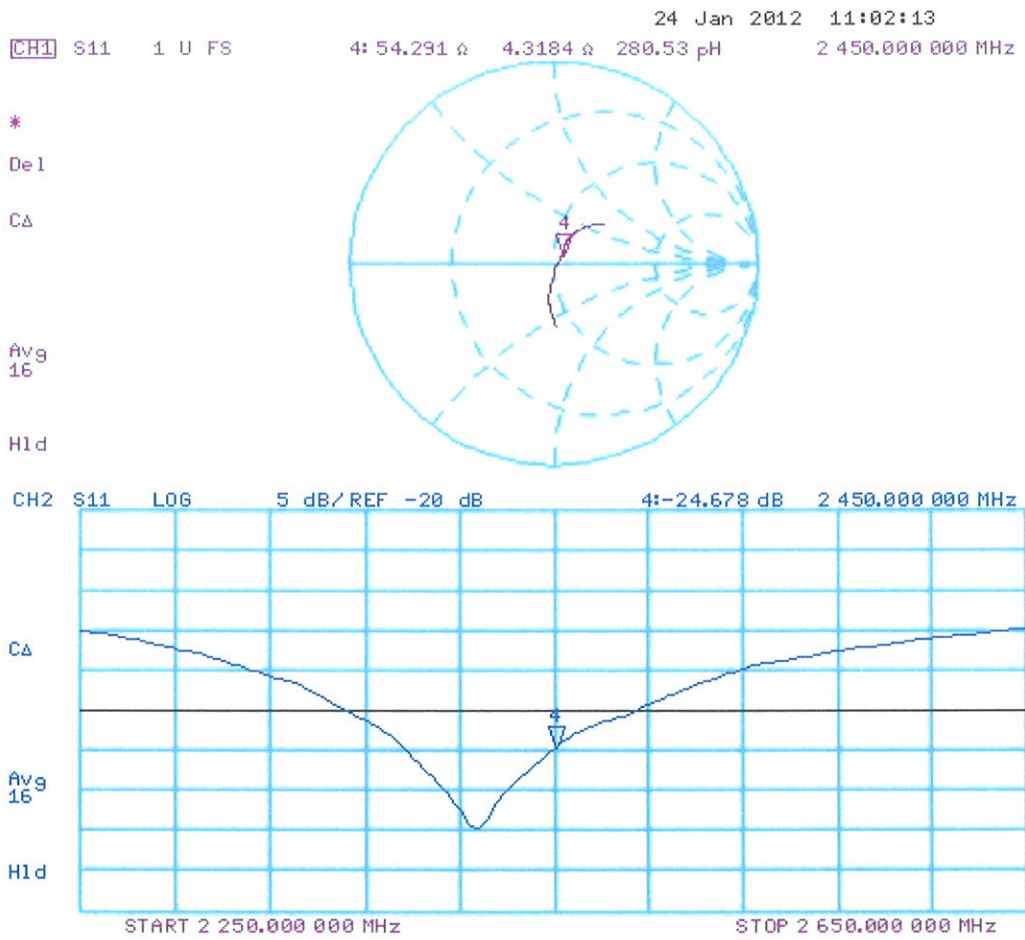



# DASY5 Validation Report for Body TSL

Date: 23.01.2012

Test Laboratory: SPEAG, Zurich, Switzerland

**DUT: Dipole 2450 MHz; Type: D2450V2; Serial: D2450V2 - SN: 737**

Communication System: CW; Frequency: 2450 MHz

Medium parameters used:  $f = 2450$  MHz;  $\sigma = 2.01$  mho/m;  $\epsilon_r = 50.6$ ;  $\rho = 1000$  kg/m<sup>3</sup>

Phantom section: Flat Section

Measurement Standard: DASY5 (IEEE/IEC/ANSI C63.19-2007)

DASY52 Configuration:

- Probe: ES3DV3 - SN3205; ConvF(4.26, 4.26, 4.26); Calibrated: 30.12.2011
- Sensor-Surface: 3mm (Mechanical Surface Detection)
- Electronics: DAE4 Sn601; Calibrated: 04.07.2011
- Phantom: Flat Phantom 5.0 (back); Type: QD000P50AA; Serial: 1002
- DASY52 52.8.0(692); SEMCAD X 14.6.4(4989)

## Dipole Calibration for Body Tissue/Pin=250 mW, d=10mm/Zoom Scan (7x7x7)/Cube 0:

Measurement grid: dx=5mm, dy=5mm, dz=5mm

Reference Value = 94.889 V/m; Power Drift = 0.03 dB

Peak SAR (extrapolated) = 26.6520

**SAR(1 g) = 12.8 mW/g; SAR(10 g) = 5.91 mW/g**

Maximum value of SAR (measured) = 17.026 mW/g

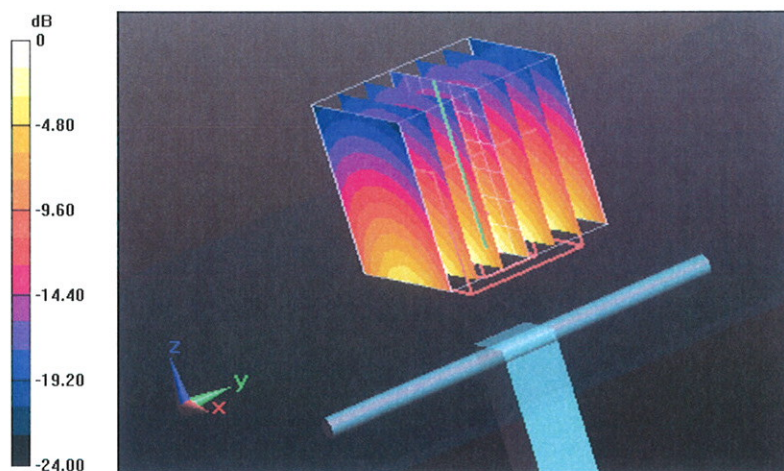

0 dB = 17.030mW/g = 24.62 dB mW/g

# Impedance Measurement Plot for Body TSL

23 Jan 2012 11:06:18

CH1 S11 1 U FS 3: 50.611  $\Omega$  5.2559  $\Omega$  341.43  $\mu\text{H}$  2 450.000 000 MHz

\*  
De l  
Ca

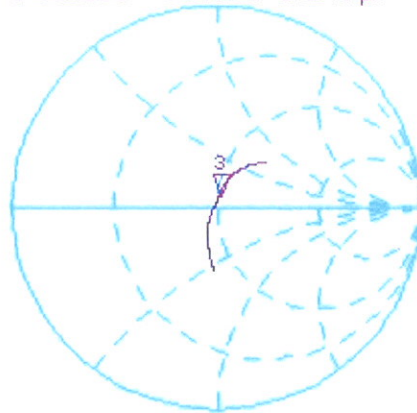

Avg  
16

H1 d

CH2 S11 LOG 5 dB/REF -20 dB 3:-25.587 dB 2 450.000 000 MHz

Ca

Avg  
16

H1 d

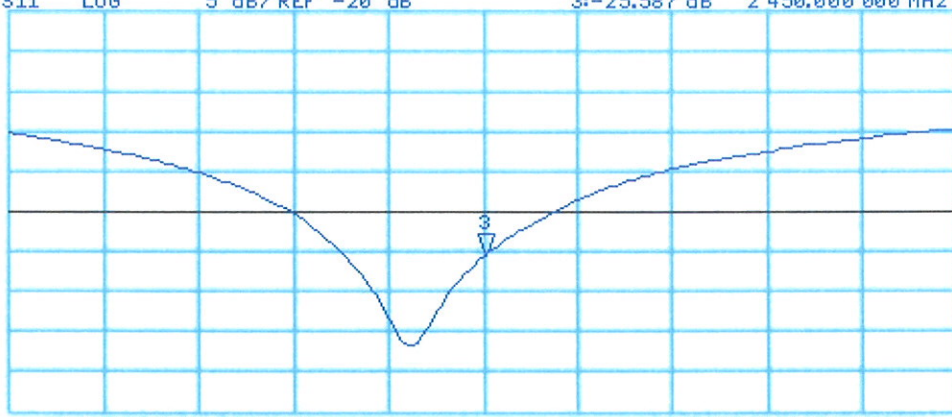

START 2 250.000 000 MHz

STOP 2 650.000 000 MHz



Accredited by the Swiss Accreditation Service (SAS)  
The Swiss Accreditation Service is one of the signatories to the EA  
Multilateral Agreement for the recognition of calibration certificates

Accreditation No.: **SCS 108**

Client **B.V. ADT (Auden)**

Certificate No: **EX3-3864\_Jul12**

## CALIBRATION CERTIFICATE

Object **EX3DV4 - SN:3864**

Calibration procedure(s) **QA CAL-01.v8, QA CAL-23.v4, QA CAL-25.v4  
Calibration procedure for dosimetric E-field probes**



Calibration date: **July 19, 2012**

This calibration certificate documents the traceability to national standards, which realize the physical units of measurements (SI).  
The measurements and the uncertainties with confidence probability are given on the following pages and are part of the certificate.

All calibrations have been conducted in the closed laboratory facility: environment temperature (22 ± 3)°C and humidity < 70%.

Calibration Equipment used (M&TE critical for calibration)

Primary Standards	ID	Cal Date (Certificate No.)	Scheduled Calibration
Power meter E4419B	GB41293874	29-Mar-12 (No. 217-01508)	Apr-13
Power sensor E4412A	MY41498087	29-Mar-12 (No. 217-01508)	Apr-13
Reference 3 dB Attenuator	SN: S5054 (3c)	27-Mar-12 (No. 217-01531)	Apr-13
Reference 20 dB Attenuator	SN: S5086 (20b)	27-Mar-12 (No. 217-01529)	Apr-13
Reference 30 dB Attenuator	SN: S5129 (30b)	27-Mar-12 (No. 217-01532)	Apr-13
Reference Probe ES3DV2	SN: 3013	29-Dec-11 (No. ES3-3013_Dec11)	Dec-12
DAE4	SN: 660	20-Jun-12 (No. DAE4-660_Jun12)	Jun-13
Secondary Standards	ID	Check Date (in house)	Scheduled Check
RF generator HP 8648C	US3642U01700	4-Aug-99 (in house check Apr-11)	In house check: Apr-13
Network Analyzer HP 8753E	US37390585	18-Oct-01 (in house check Oct-11)	In house check: Oct-12

Calibrated by:	Name <b>Jeton Kastrat</b>	Function <b>Laboratory Technician</b>	Signature 
Approved by:	Name <b>Katja Pokovic</b>	Function <b>Technical Manager</b>	

Issued: July 20, 2012

This calibration certificate shall not be reproduced except in full without written approval of the laboratory.



Accredited by the Swiss Accreditation Service (SAS)

Accreditation No.: **SCS 108**

The Swiss Accreditation Service is one of the signatories to the EA  
Multilateral Agreement for the recognition of calibration certificates

### Glossary:

TSL	tissue simulating liquid
NORM <sub>x,y,z</sub>	sensitivity in free space
ConvF	sensitivity in TSL / NORM <sub>x,y,z</sub>
DCP	diode compression point
CF	crest factor (1/duty_cycle) of the RF signal
A, B, C	modulation dependent linearization parameters
Polarization $\varphi$	$\varphi$ rotation around probe axis
Polarization $\vartheta$	$\vartheta$ rotation around an axis that is in the plane normal to probe axis (at measurement center), i.e., $\vartheta = 0$ is normal to probe axis

### Calibration is Performed According to the Following Standards:

- IEEE Std 1528-2003, "IEEE Recommended Practice for Determining the Peak Spatial-Averaged Specific Absorption Rate (SAR) in the Human Head from Wireless Communications Devices: Measurement Techniques", December 2003
- IEC 62209-1, "Procedure to measure the Specific Absorption Rate (SAR) for hand-held devices used in close proximity to the ear (frequency range of 300 MHz to 3 GHz)", February 2005

### Methods Applied and Interpretation of Parameters:

- NORM<sub>x,y,z</sub>**: Assessed for E-field polarization  $\vartheta = 0$  ( $f \leq 900$  MHz in TEM-cell;  $f > 1800$  MHz: R22 waveguide). NORM<sub>x,y,z</sub> are only intermediate values, i.e., the uncertainties of NORM<sub>x,y,z</sub> does not affect the E<sup>2</sup>-field uncertainty inside TSL (see below *ConvF*).
- NORM(f)<sub>x,y,z</sub>** = NORM<sub>x,y,z</sub> \* *frequency\_response* (see Frequency Response Chart). This linearization is implemented in DASY4 software versions later than 4.2. The uncertainty of the frequency response is included in the stated uncertainty of *ConvF*.
- DCP<sub>x,y,z</sub>**: DCP are numerical linearization parameters assessed based on the data of power sweep with CW signal (no uncertainty required). DCP does not depend on frequency nor media.
- PAR**: PAR is the Peak to Average Ratio that is not calibrated but determined based on the signal characteristics
- A<sub>x,y,z</sub>; B<sub>x,y,z</sub>; C<sub>x,y,z</sub>; VR<sub>x,y,z</sub>**: A, B, C are numerical linearization parameters assessed based on the data of power sweep for specific modulation signal. The parameters do not depend on frequency nor media. VR is the maximum calibration range expressed in RMS voltage across the diode.
- ConvF and Boundary Effect Parameters**: Assessed in flat phantom using E-field (or Temperature Transfer Standard for  $f \leq 800$  MHz) and inside waveguide using analytical field distributions based on power measurements for  $f > 800$  MHz. The same setups are used for assessment of the parameters applied for boundary compensation (alpha, depth) of which typical uncertainty values are given. These parameters are used in DASY4 software to improve probe accuracy close to the boundary. The sensitivity in TSL corresponds to NORM<sub>x,y,z</sub> \* *ConvF* whereby the uncertainty corresponds to that given for *ConvF*. A frequency dependent *ConvF* is used in DASY version 4.4 and higher which allows extending the validity from  $\pm 50$  MHz to  $\pm 100$  MHz.
- Spherical isotropy (3D deviation from isotropy)**: in a field of low gradients realized using a flat phantom exposed by a patch antenna.
- Sensor Offset**: The sensor offset corresponds to the offset of virtual measurement center from the probe tip (on probe axis). No tolerance required.

# Probe EX3DV4

## SN:3864

Manufactured: February 2, 2012  
Calibrated: July 19, 2012

**Calibrated for DASY/EASY Systems**  
(Note: non-compatible with DASY2 system!)

## DASY/EASY - Parameters of Probe: EX3DV4 - SN:3864

### Basic Calibration Parameters

	Sensor X	Sensor Y	Sensor Z	Unc (k=2)
Norm ( $\mu\text{V}/(\text{V}/\text{m})^2$ ) <sup>A</sup>	0.47	0.44	0.49	$\pm 10.1 \%$
DCP (mV) <sup>B</sup>	97.6	98.0	97.9	

### Modulation Calibration Parameters

UID	Communication System Name	PAR		A dB	B dB	C dB	VR mV	Unc <sup>E</sup> (k=2)
0	CW	0.00	X	0.00	0.00	1.00	154.8	$\pm 4.1 \%$
			Y	0.00	0.00	1.00	146.9	
			Z	0.00	0.00	1.00	162.0	

The reported uncertainty of measurement is stated as the standard uncertainty of measurement multiplied by the coverage factor  $k=2$ , which for a normal distribution corresponds to a coverage probability of approximately 95%.

<sup>A</sup> The uncertainties of NormX,Y,Z do not affect the  $E^2$ -field uncertainty inside TSL (see Pages 5 and 6).

<sup>B</sup> Numerical linearization parameter: uncertainty not required.

<sup>E</sup> Uncertainty is determined using the max. deviation from linear response applying rectangular distribution and is expressed for the square of the field value.

## DASY/EASY - Parameters of Probe: EX3DV4 - SN:3864

### Calibration Parameter Determined in Head Tissue Simulating Media

f (MHz) <sup>C</sup>	Relative Permittivity <sup>F</sup>	Conductivity (S/m) <sup>F</sup>	ConvF X	ConvF Y	ConvF Z	Alpha	Depth (mm)	Unct. (k=2)
835	41.5	0.90	9.80	9.80	9.80	0.58	0.65	± 12.0 %
1750	40.1	1.37	8.56	8.56	8.56	0.43	0.82	± 12.0 %
1900	40.0	1.40	8.13	8.13	8.13	0.42	0.79	± 12.0 %
2450	39.2	1.80	7.28	7.28	7.28	0.43	0.80	± 12.0 %

<sup>C</sup> Frequency validity of ± 100 MHz only applies for DASY v4.4 and higher (see Page 2), else it is restricted to ± 50 MHz. The uncertainty is the RSS of the ConvF uncertainty at calibration frequency and the uncertainty for the indicated frequency band.

<sup>F</sup> At frequencies below 3 GHz, the validity of tissue parameters ( $\epsilon$  and  $\sigma$ ) can be relaxed to ± 10% if liquid compensation formula is applied to measured SAR values. At frequencies above 3 GHz, the validity of tissue parameters ( $\epsilon$  and  $\sigma$ ) is restricted to ± 5%. The uncertainty is the RSS of the ConvF uncertainty for indicated target tissue parameters.

## DASY/EASY - Parameters of Probe: EX3DV4 - SN:3864

### Calibration Parameter Determined in Body Tissue Simulating Media

f (MHz) <sup>C</sup>	Relative Permittivity <sup>F</sup>	Conductivity (S/m) <sup>F</sup>	ConvF X	ConvF Y	ConvF Z	Alpha	Depth (mm)	Unct. (k=2)
835	55.2	0.97	9.94	9.94	9.94	0.58	0.72	± 12.0 %
1750	53.4	1.49	8.45	8.45	8.45	0.41	0.87	± 12.0 %
1900	53.3	1.52	7.88	7.88	7.88	0.48	0.77	± 12.0 %
2450	52.7	1.95	7.49	7.49	7.49	0.80	0.50	± 12.0 %

<sup>C</sup> Frequency validity of ± 100 MHz only applies for DASY v4.4 and higher (see Page 2), else it is restricted to ± 50 MHz. The uncertainty is the RSS of the ConvF uncertainty at calibration frequency and the uncertainty for the indicated frequency band.

<sup>F</sup> At frequencies below 3 GHz, the validity of tissue parameters ( $\epsilon$  and  $\sigma$ ) can be relaxed to ± 10% if liquid compensation formula is applied to measured SAR values. At frequencies above 3 GHz, the validity of tissue parameters ( $\epsilon$  and  $\sigma$ ) is restricted to ± 5%. The uncertainty is the RSS of the ConvF uncertainty for indicated target tissue parameters.



### Frequency Response of E-Field (TEM-Cell:ifi110 EXX, Waveguide: R22)

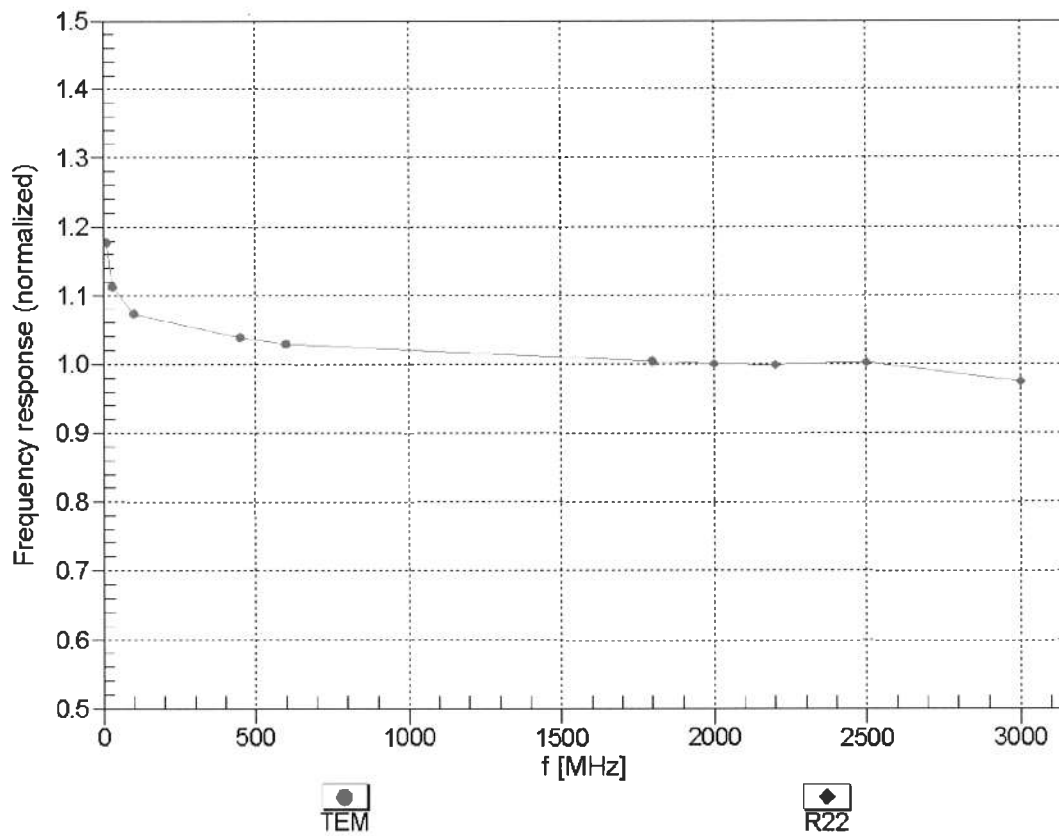

Uncertainty of Frequency Response of E-field:  $\pm 6.3\%$  (k=2)

### Receiving Pattern ( $\phi$ ), $\theta = 0^\circ$

f=600 MHz,TEM

f=1800 MHz,R22

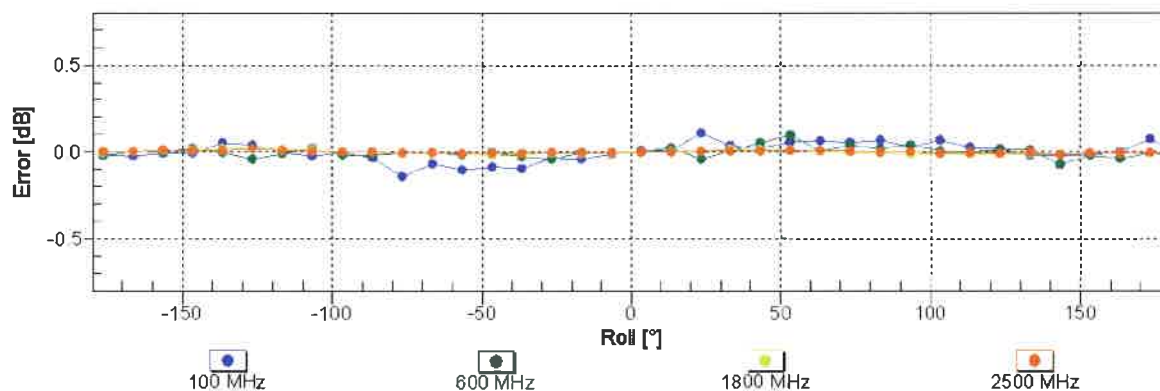
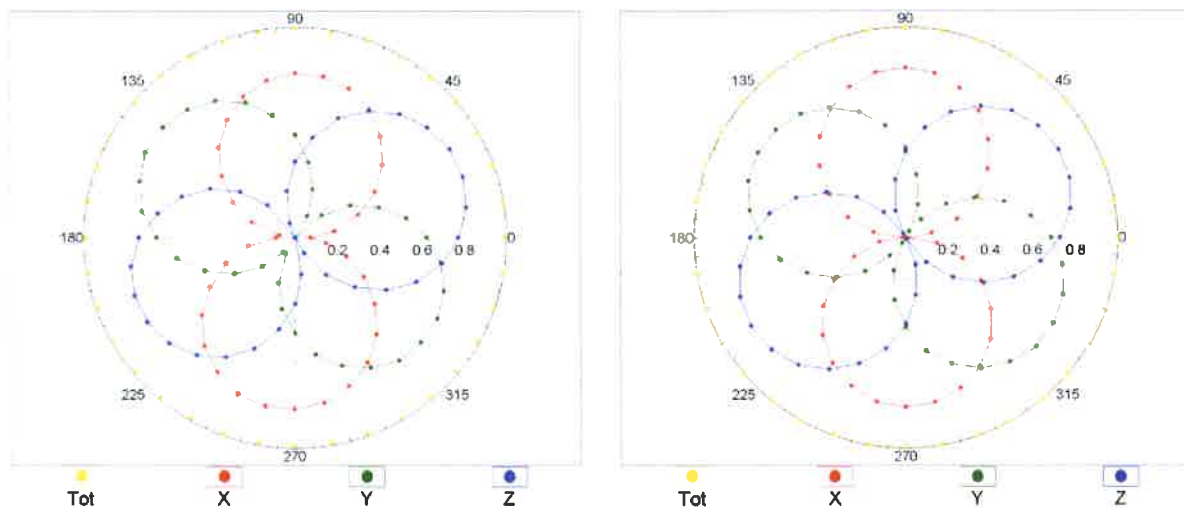

**Uncertainty of Axial Isotropy Assessment:  $\pm 0.5\%$  (k=2)**

### Dynamic Range f(SAR<sub>head</sub>) (TEM cell , f = 900 MHz)

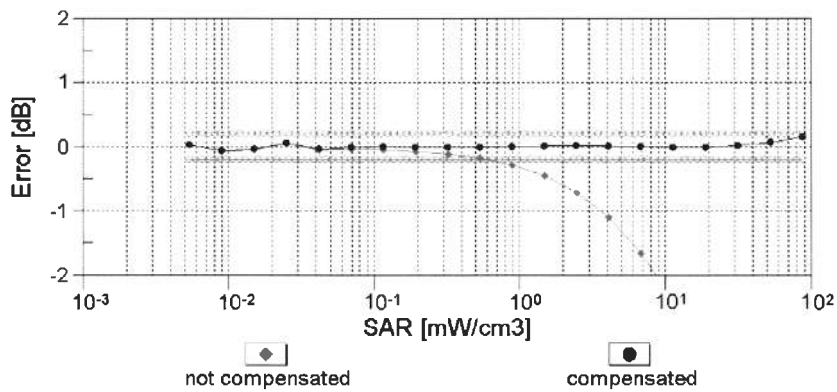
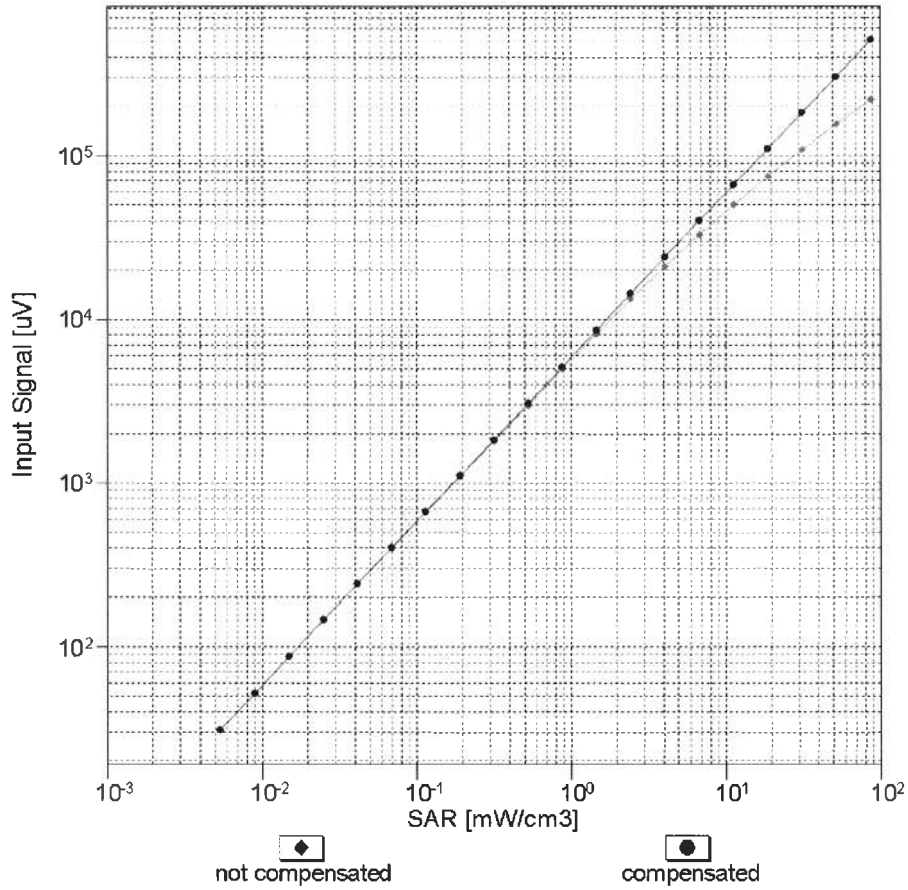

Uncertainty of Linearity Assessment: ± 0.6% (k=2)

# Conversion Factor Assessment

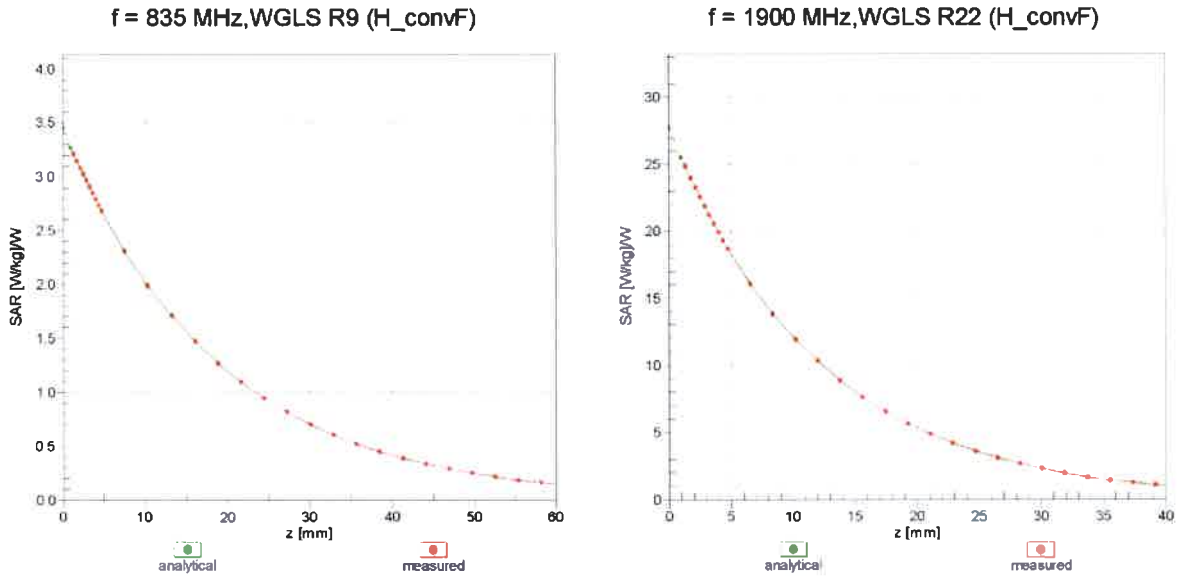

## Deviation from Isotropy in Liquid Error ( $\phi, \vartheta$ ), f = 900 MHz

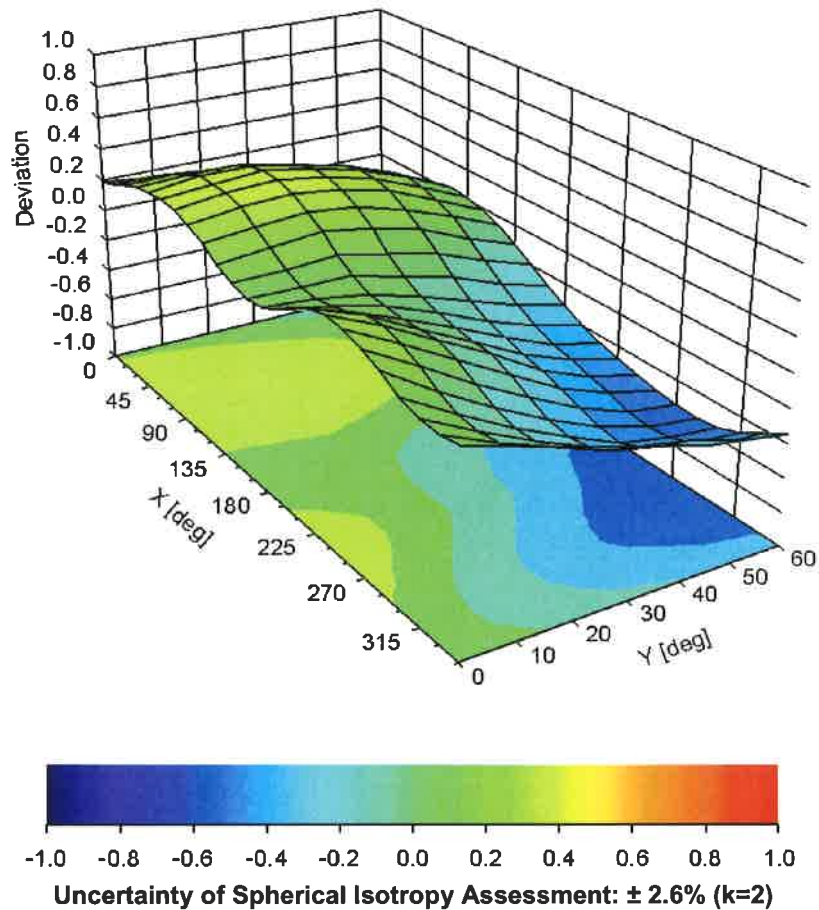

## DASY/EASY - Parameters of Probe: EX3DV4 - SN:3864

### Other Probe Parameters

Sensor Arrangement	Triangular
Connector Angle (°)	63.3
Mechanical Surface Detection Mode	enabled
Optical Surface Detection Mode	disabled
Probe Overall Length	337 mm
Probe Body Diameter	10 mm
Tip Length	9 mm
Tip Diameter	2.5 mm
Probe Tip to Sensor X Calibration Point	1 mm
Probe Tip to Sensor Y Calibration Point	1 mm
Probe Tip to Sensor Z Calibration Point	1 mm
Recommended Measurement Distance from Surface	2 mm