

High Channel (5 240 MHz)

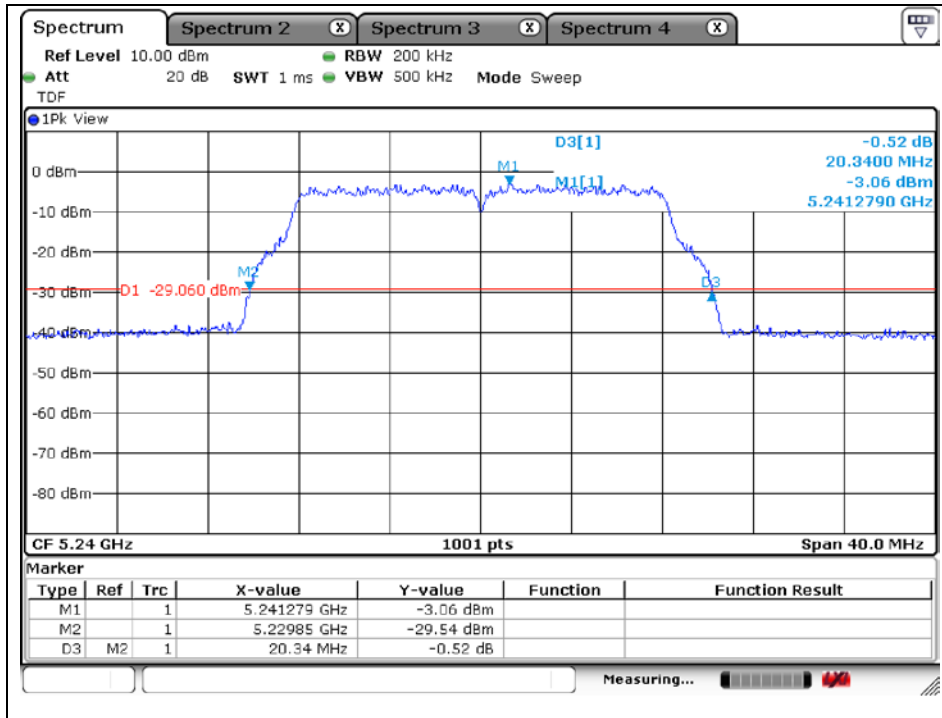

802.11a (Band 2A)

Low Channel (5 260 MHz)

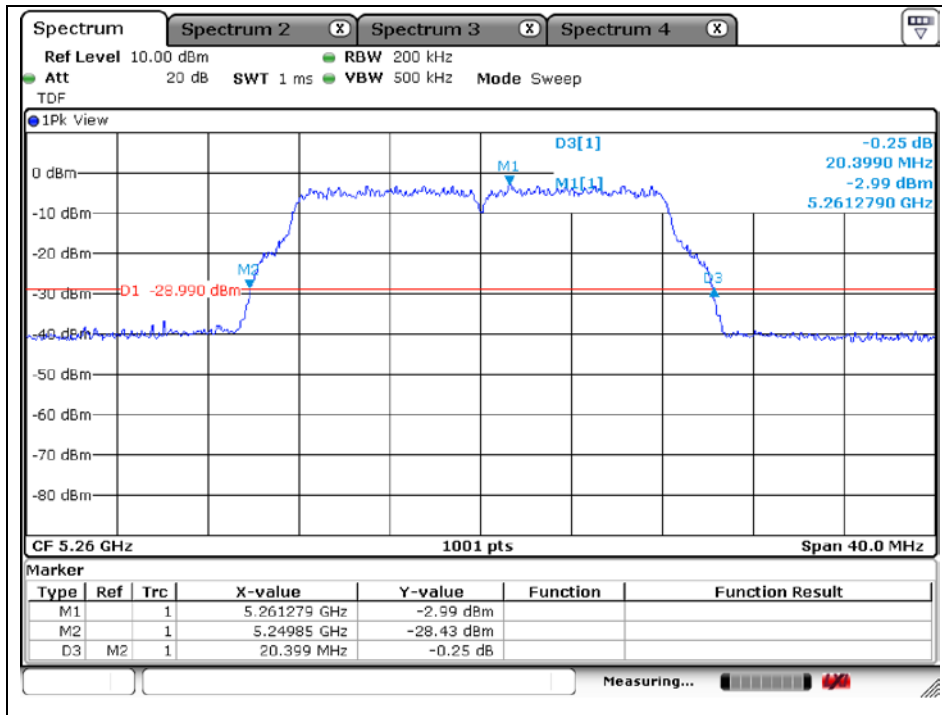

The results shown in this test report refer only to the sample(s) tested unless otherwise stated. This test report cannot be reproduced, except in full, without prior written permission of the Company.

Middle Channel (5 280 MHz)

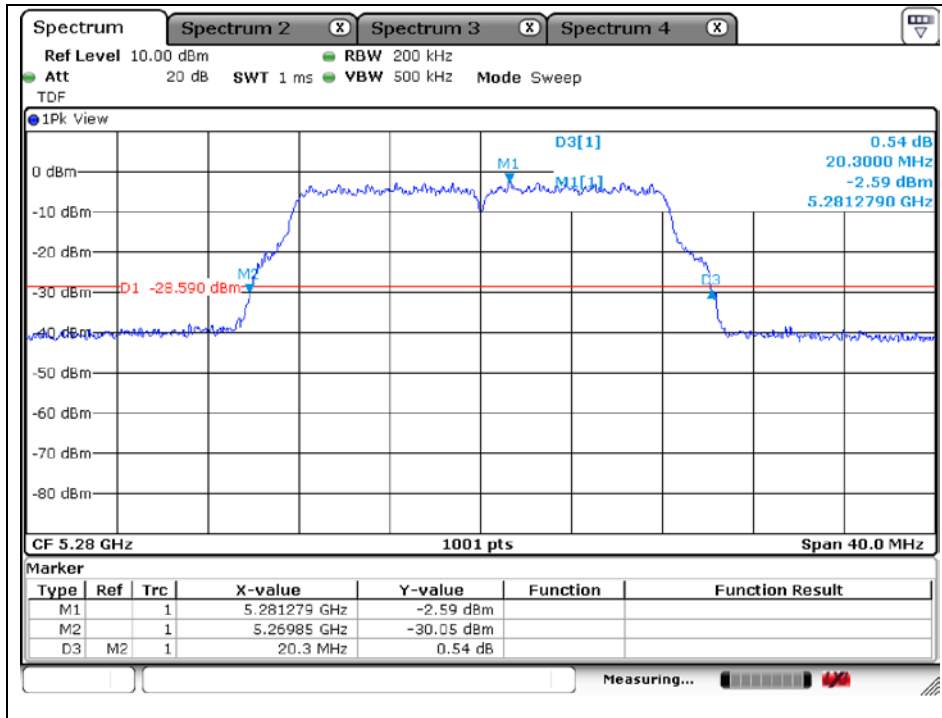

High Channel (5 320 MHz)

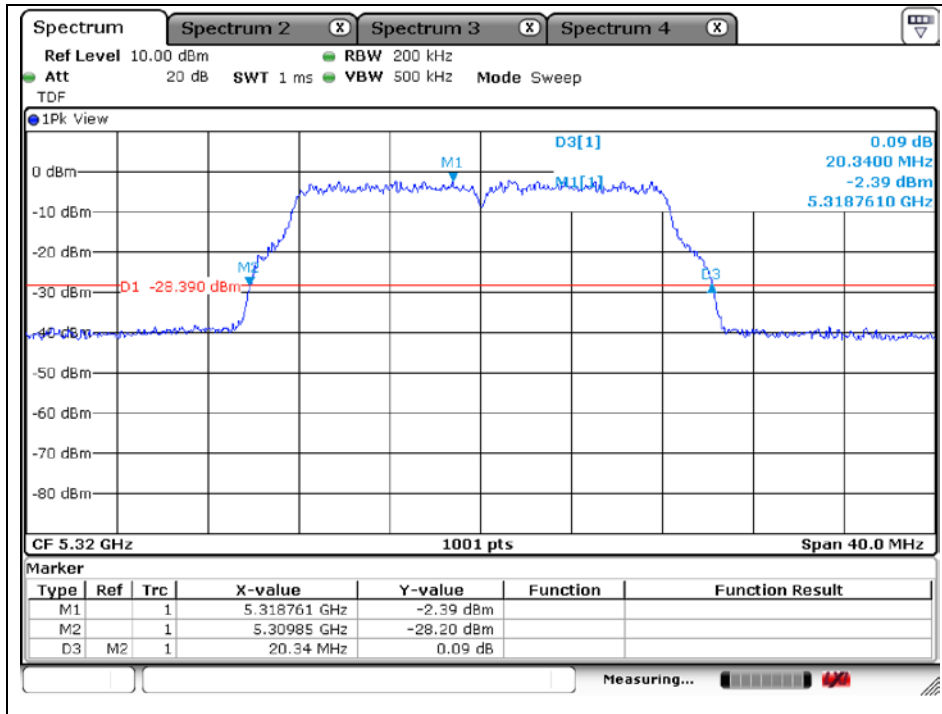

The results shown in this test report refer only to the sample(s) tested unless otherwise stated. This test report cannot be reproduced, except in full, without prior written permission of the Company.

**802.11a (Band 2C)**

Low Channel (5 500 MHz)

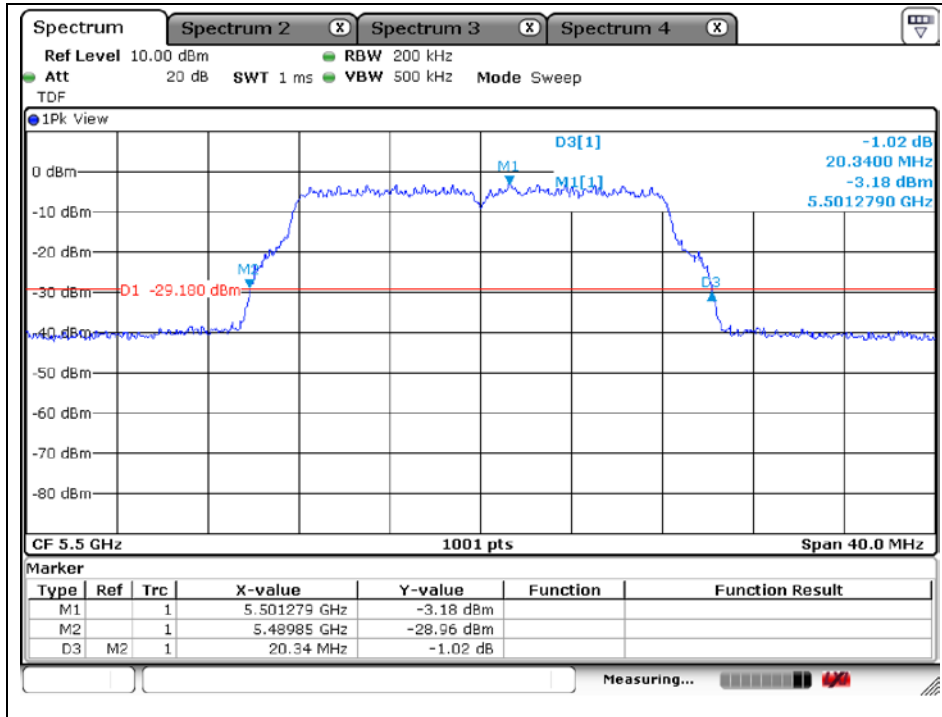

Middle Channel (5 580 MHz)

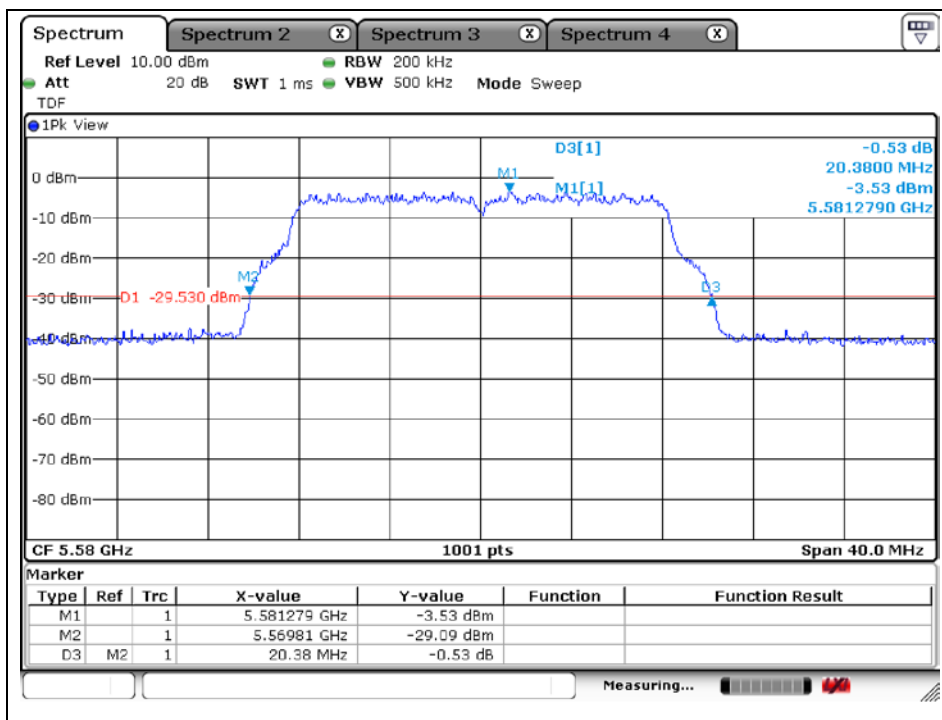

The results shown in this test report refer only to the sample(s) tested unless otherwise stated. This test report cannot be reproduced, except in full, without prior written permission of the Company.

High Channel (5 720 MHz)

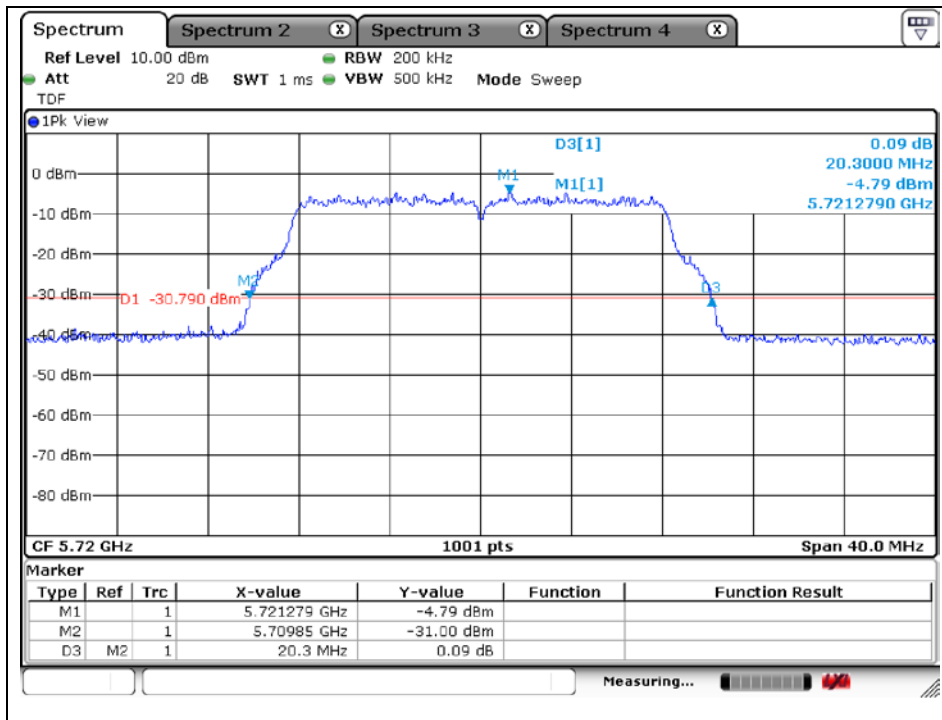

802.11a (Band 3)

Low Channel (5 745 MHz)

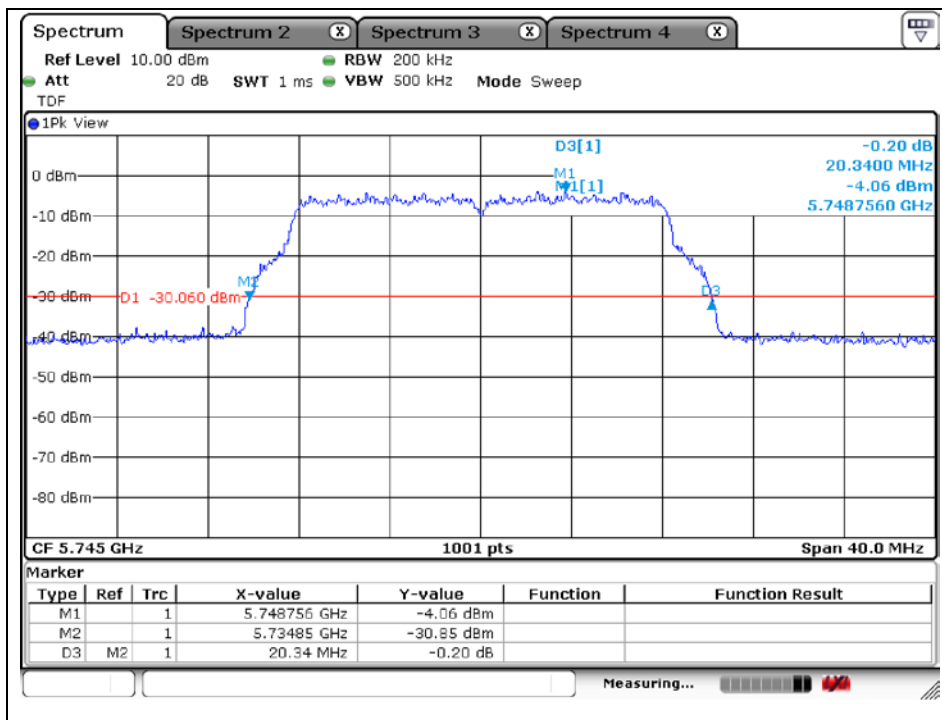

The results shown in this test report refer only to the sample(s) tested unless otherwise stated. This test report cannot be reproduced, except in full, without prior written permission of the Company.

Middle Channel (5 785 MHz)

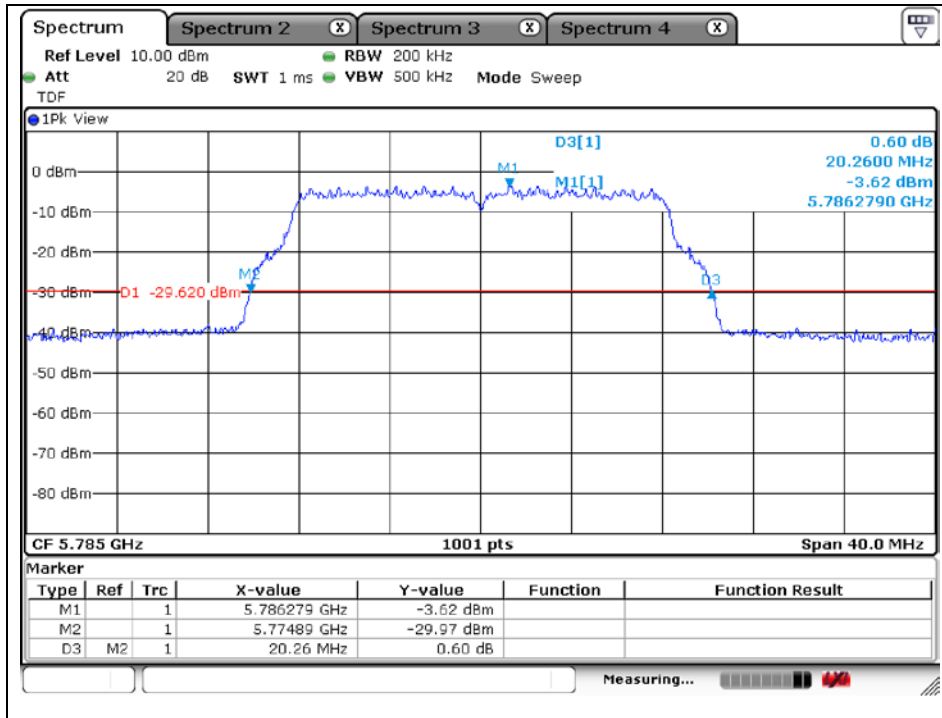

High Channel (5 825 MHz)

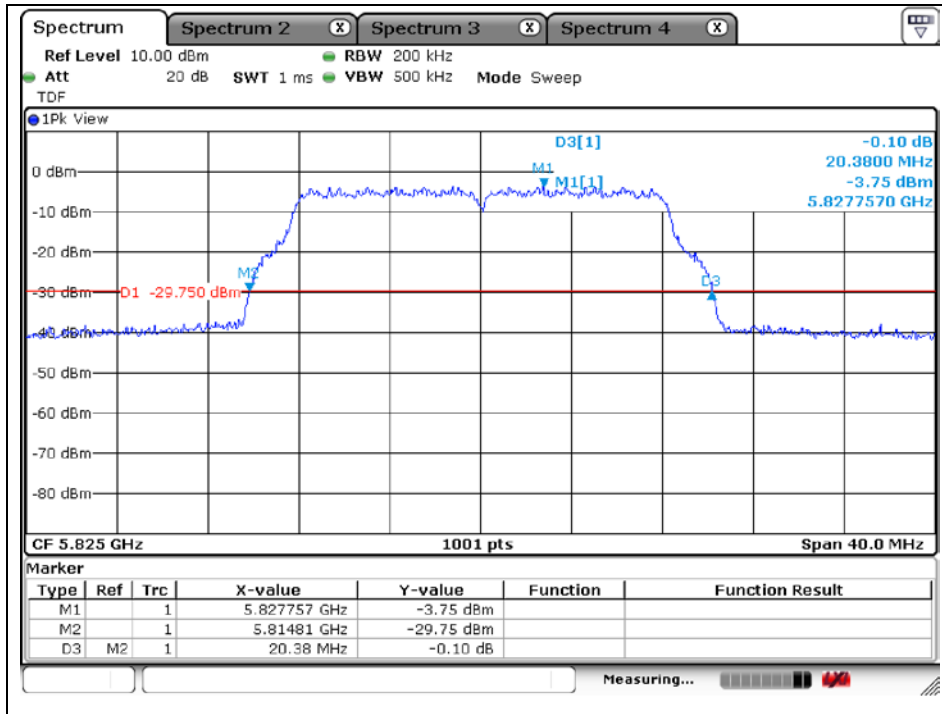

The results shown in this test report refer only to the sample(s) tested unless otherwise stated. This test report cannot be reproduced, except in full, without prior written permission of the Company.

## 802.11n\_HT20 (Band 1)

Low Channel (5 180 MHz)

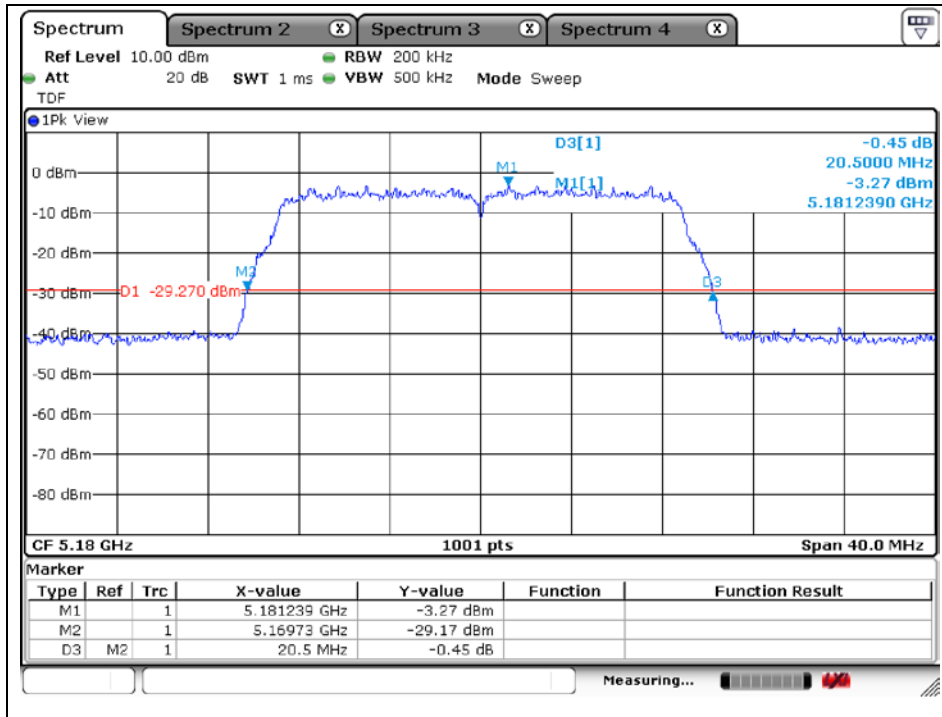

Middle Channel (5 200 MHz)

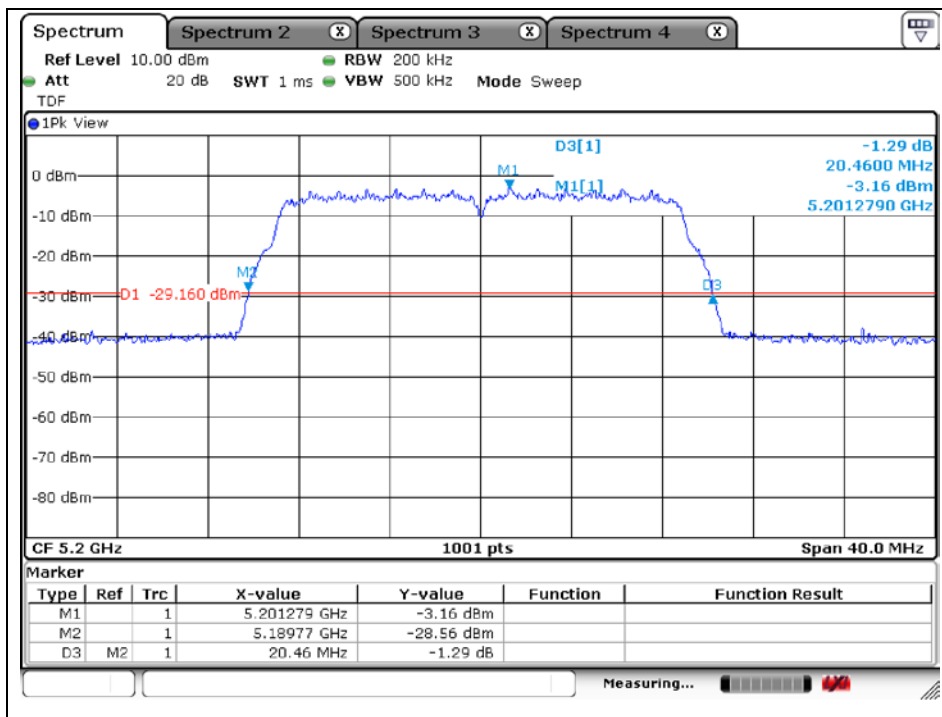

The results shown in this test report refer only to the sample(s) tested unless otherwise stated. This test report cannot be reproduced, except in full, without prior written permission of the Company.

High Channel (5 240 MHz)

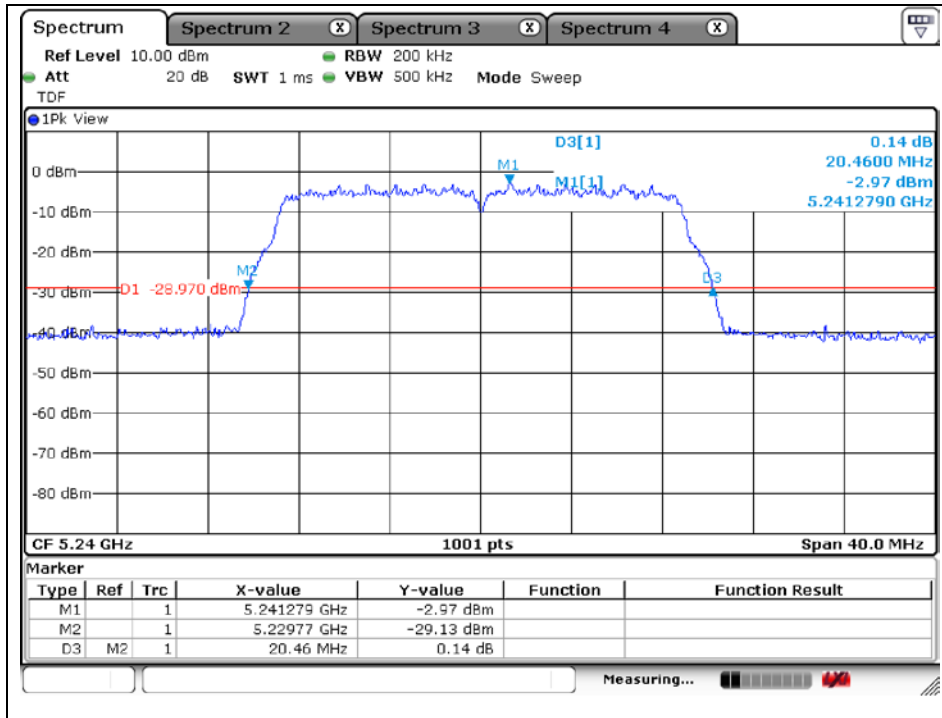

802.11n\_HT20 (Band 2A)

Low Channel (5 260 MHz)

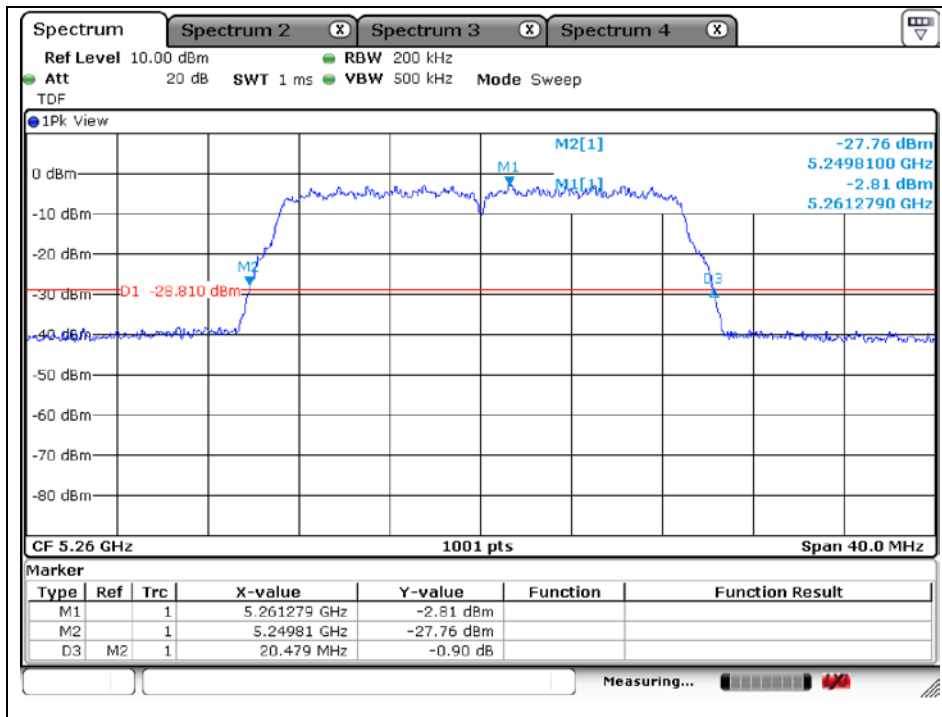

The results shown in this test report refer only to the sample(s) tested unless otherwise stated. This test report cannot be reproduced, except in full, without prior written permission of the Company.

Middle Channel (5 280 MHz)

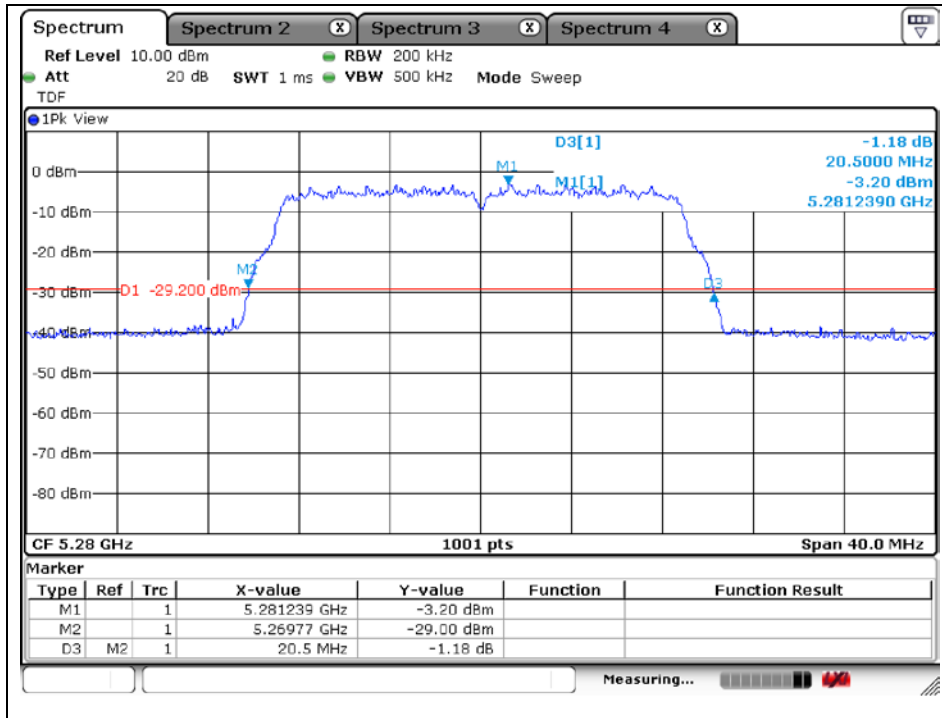

High Channel (5 320 MHz)

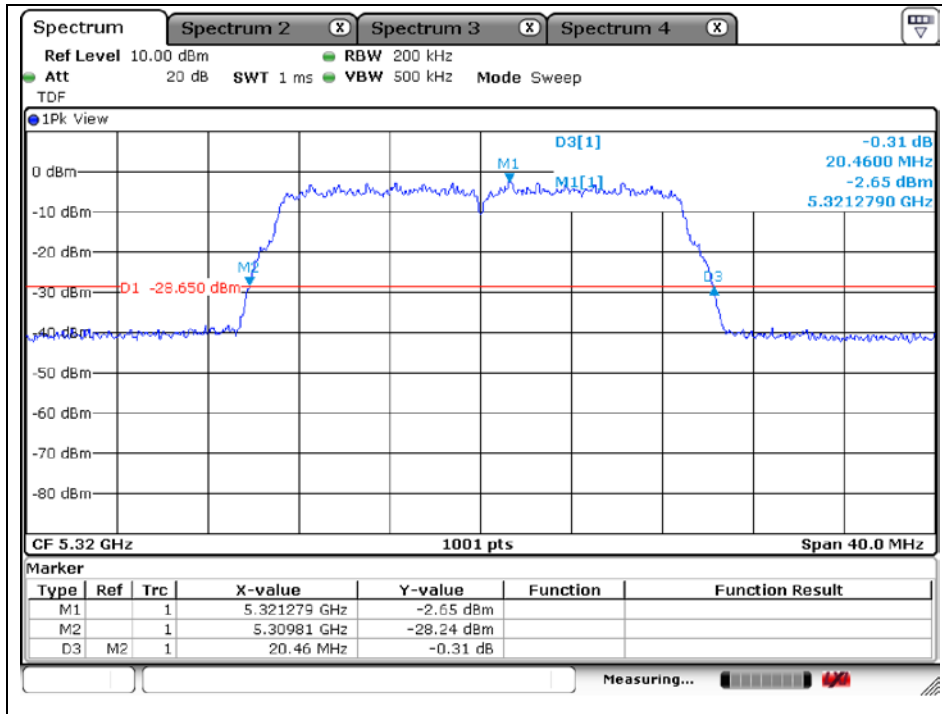

The results shown in this test report refer only to the sample(s) tested unless otherwise stated. This test report cannot be reproduced, except in full, without prior written permission of the Company.



**802.11n\_HT20 (Band 2C)**

Low Channel (5 500 MHz)

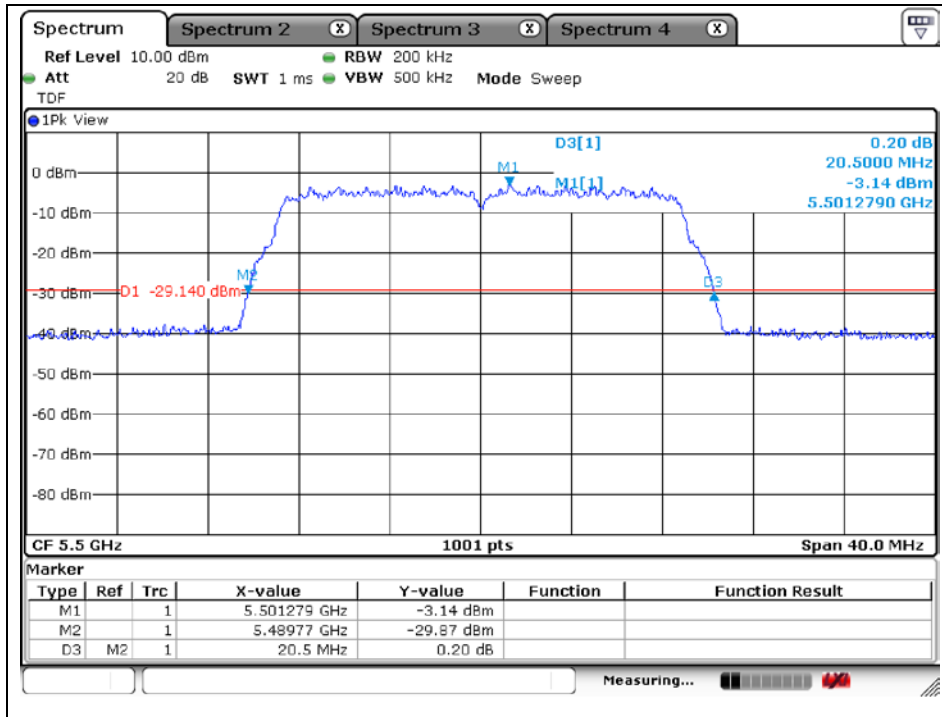

Middle Channel (5 580 MHz)

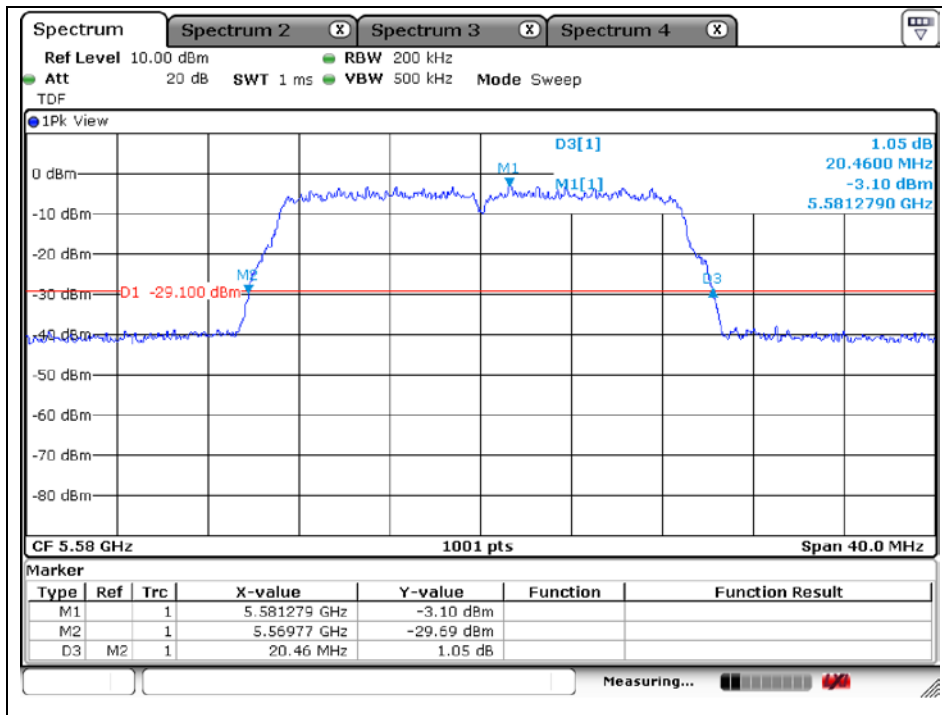

The results shown in this test report refer only to the sample(s) tested unless otherwise stated. This test report cannot be reproduced, except in full, without prior written permission of the Company.

High Channel (5 720 MHz)

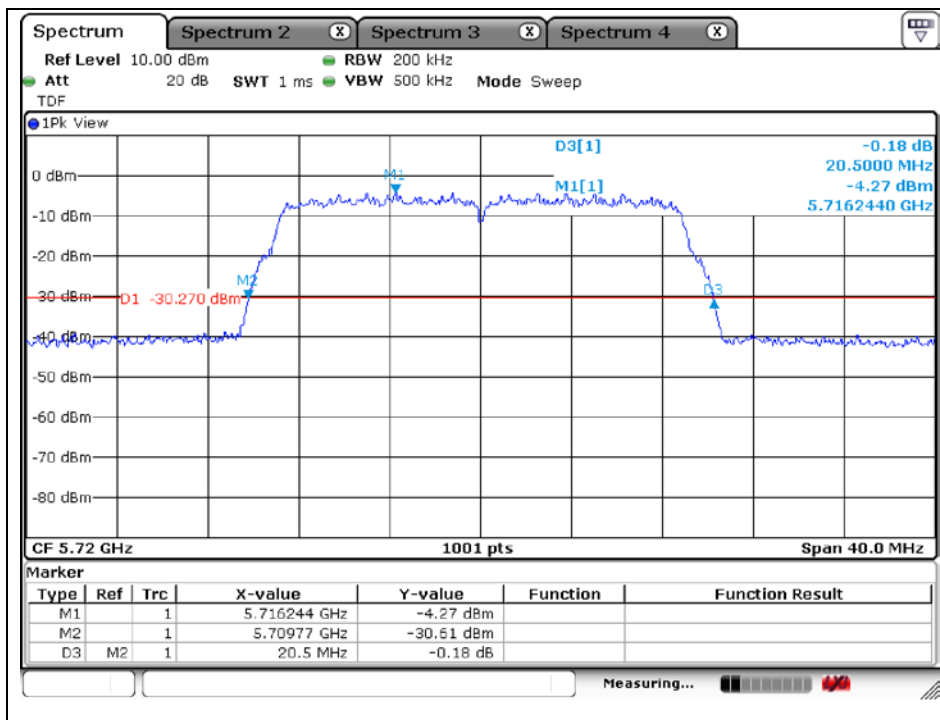

802.11n\_HT20 (Band 3)

Low Channel (5 745 MHz)

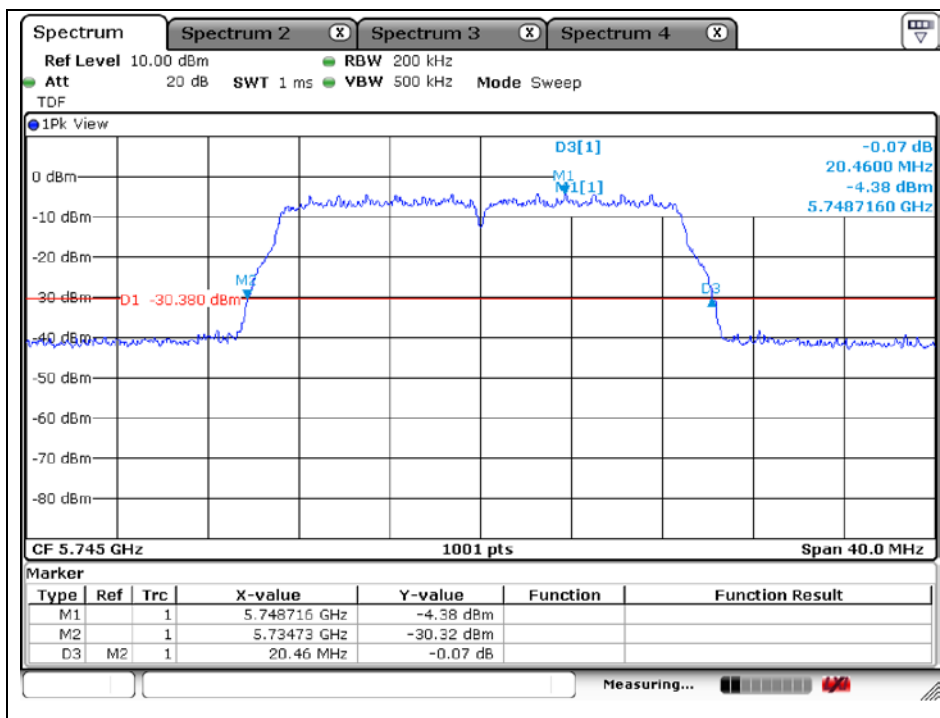

The results shown in this test report refer only to the sample(s) tested unless otherwise stated. This test report cannot be reproduced, except in full, without prior written permission of the Company.

Middle Channel (5 785 MHz)

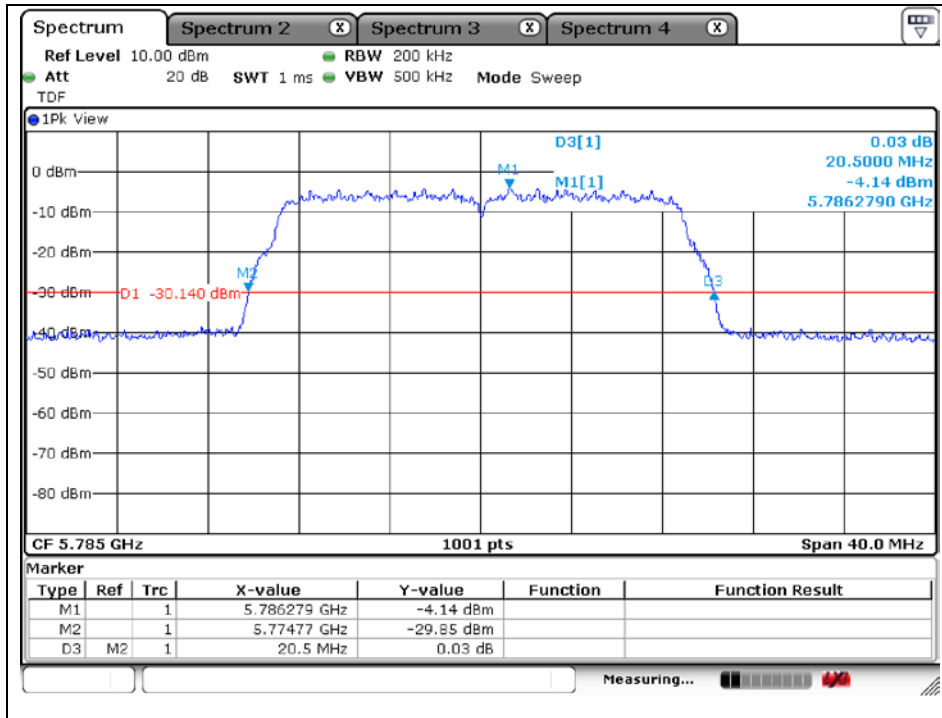

High Channel (5 825 MHz)

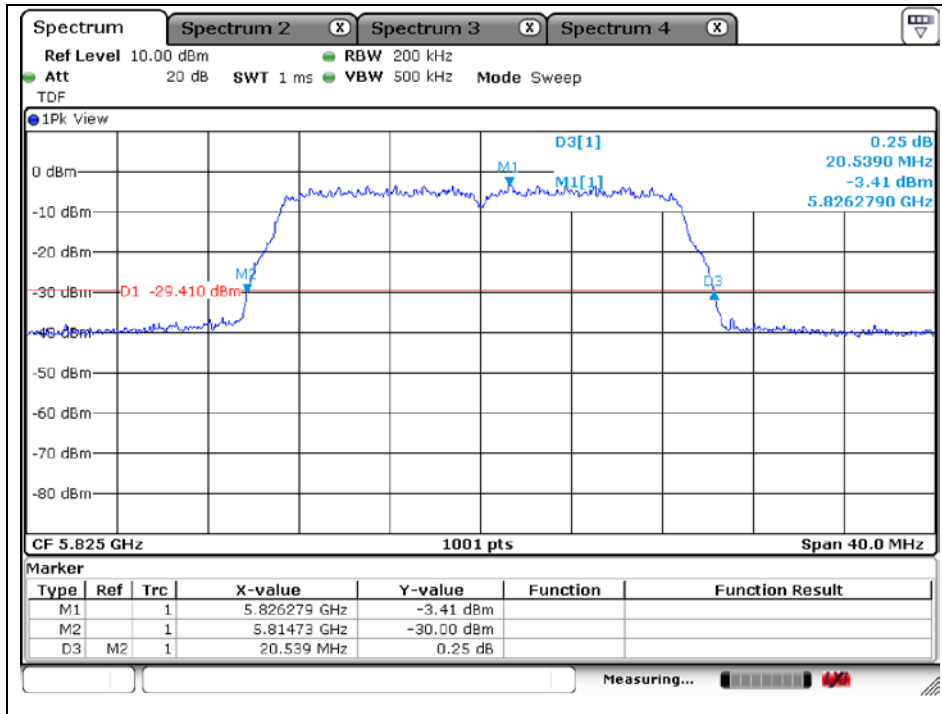

The results shown in this test report refer only to the sample(s) tested unless otherwise stated. This test report cannot be reproduced, except in full, without prior written permission of the Company.

### Band-crossing channels

#### 802.11a (5 720 MHz)

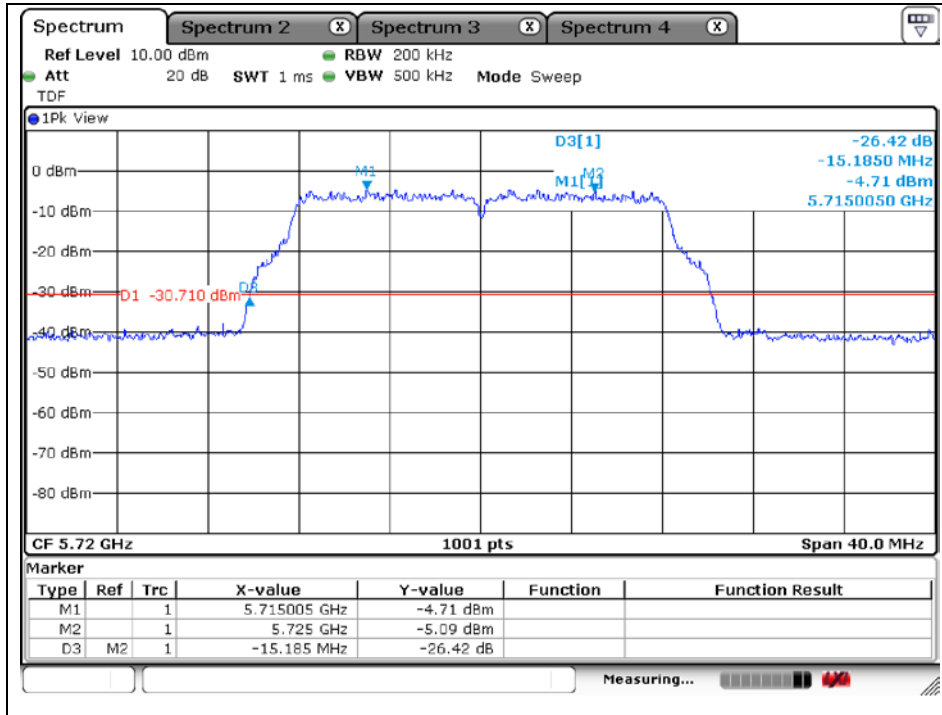

#### 802.11n\_HT20 (5 720 MHz)

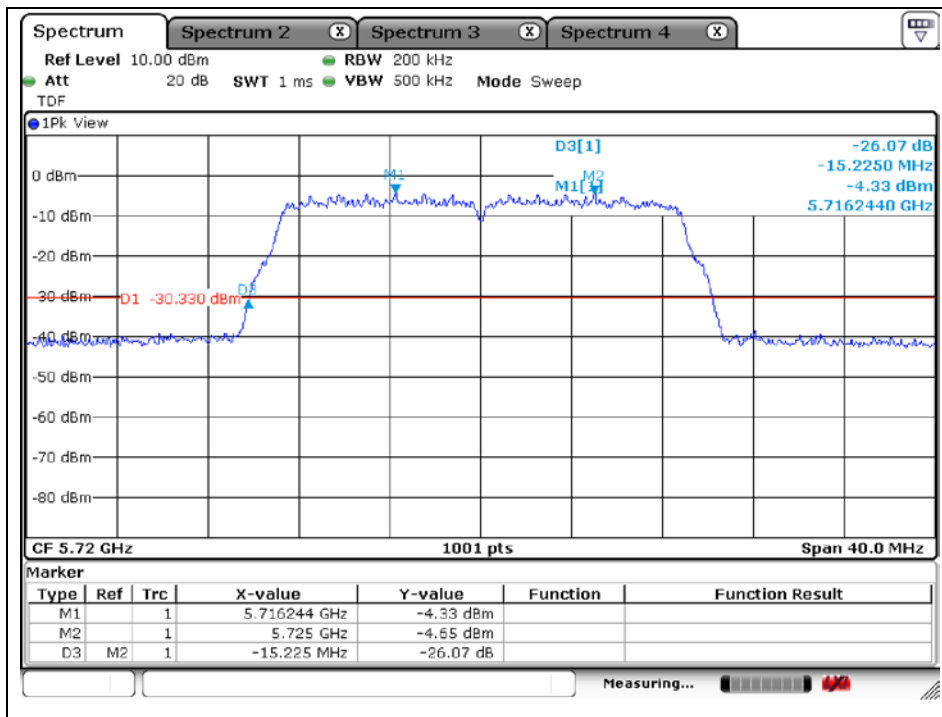

The results shown in this test report refer only to the sample(s) tested unless otherwise stated. This test report cannot be reproduced, except in full, without prior written permission of the Company.

**99 % Bandwidth**

**802.11a (Band 1)**

High Channel (5 240 MHz)

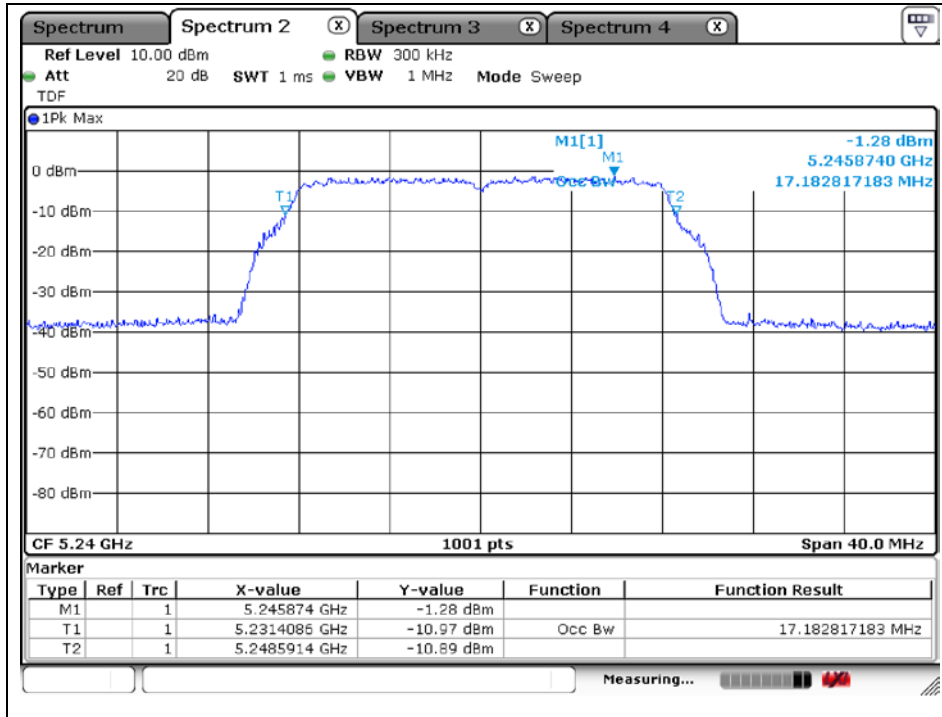

**802.11n\_HT20 (Band 1)**

High Channel (5 240 MHz)

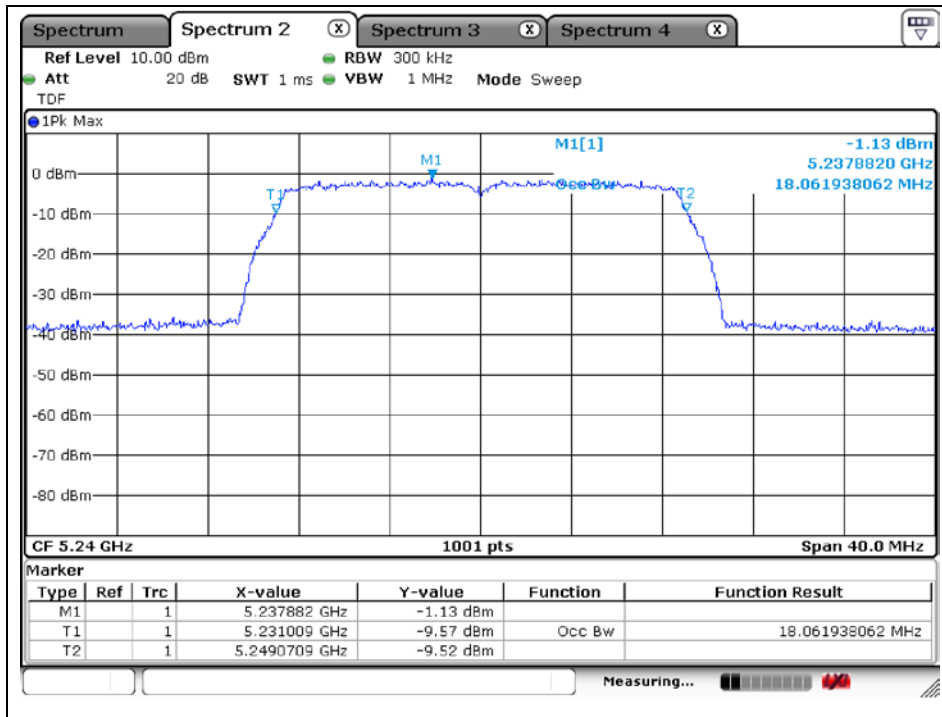

The results shown in this test report refer only to the sample(s) tested unless otherwise stated. This test report cannot be reproduced, except in full, without prior written permission of the Company.

## 4. 6 dB bandwidth

### 4.1. Test setup



### 4.2. Limit

Within the 5.725 – 5.85 GHz band, the minimum 6 dB bandwidth of U-NII devices shall be at least 500 kHz.

### 4.3. Test procedure

All data rates and modes were investigated for this test. The full data for the worst case data rate are reported in this section.

1. This measurement settings are specified in section C.2 of KDB 789033\_D02 v01r02.
2. Set RBW : 100 kHz.
3. Set the video bandwidth (VBW)  $\geq 3 \times$  RBW.
4. Detector = Peak.
5. Trace mode = max hold.
6. Sweep = auto couple.
7. Allow the trace to stabilize.
8. Measure the maximum width of the emission that is constrained by the frequencies associated with the two outermost amplitude points (upper and lower frequencies) that are attenuated by 6 dB relative to the maximum level measured in the fundamental emission.
9. In case of band crossing channels 144, the measurement is complied with section D of KDB 644545\_D03 v01.

*The results shown in this test report refer only to the sample(s) tested unless otherwise stated. This test report cannot be reproduced, except in full, without prior written permission of the Company.*

**SGS Korea Co., Ltd. (Gunpo Laboratory)** 4, LS-ro 182beon-gil, Gunpo-si, Gyeonggi-do, Korea, 15807 <http://www.sgsgroup.kr>

#### 4.4. Test result

Ambient temperature : (23 ± 1) °C  
 Relative humidity : 47 % R.H.

Band	Mode	Frequency (MHz)	Ch.	Data Rate	6 dB Bandwidth (MHz)	Minimum Bandwidth (kHz)
U-NII 3	11a	5 745	149	6 Mbps	16.38	500
		5 785	157	6 Mbps	16.34	500
		5 825	165	6 Mbps	16.34	500
	11n_HT20	5 745	149	MCS0	17.58	500
		5 785	157	MCS0	17.58	500
		5 825	165	MCS0	17.58	500
U-NII 3 (Band-Crossing channels)	11a	5 720	144	6 Mbps	3.19	500
	11n_HT20	5 720	144	MCS0	3.79	500

*The results shown in this test report refer only to the sample(s) tested unless otherwise stated. This test report cannot be reproduced, except in full, without prior written permission of the Company.*

### 802.11a (Band 3)

#### Low Channel (5 745 MHz)

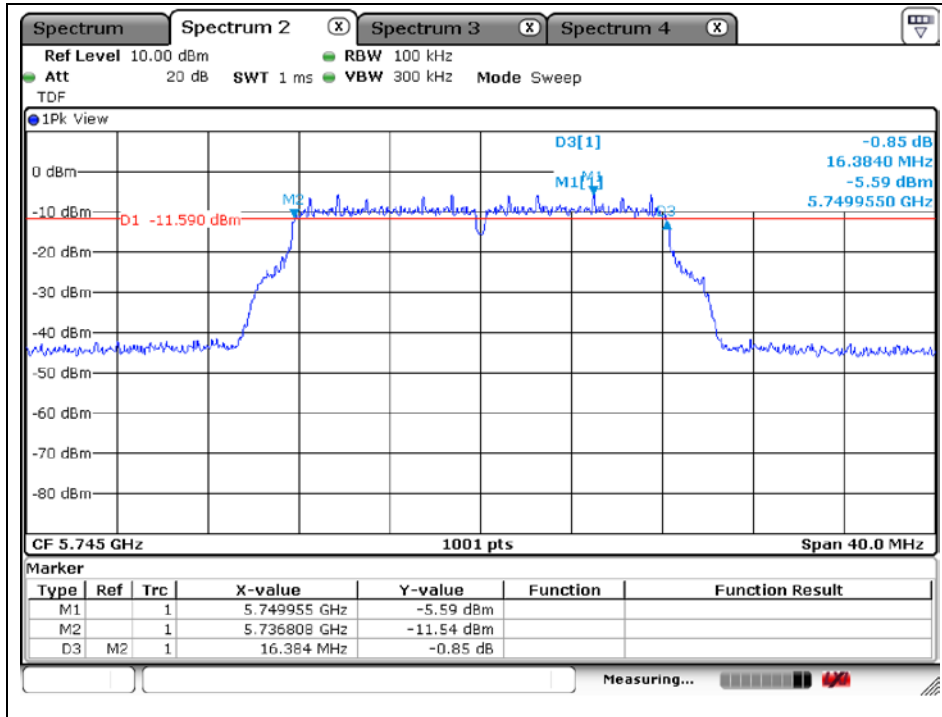

#### Middle Channel (5 785 MHz)

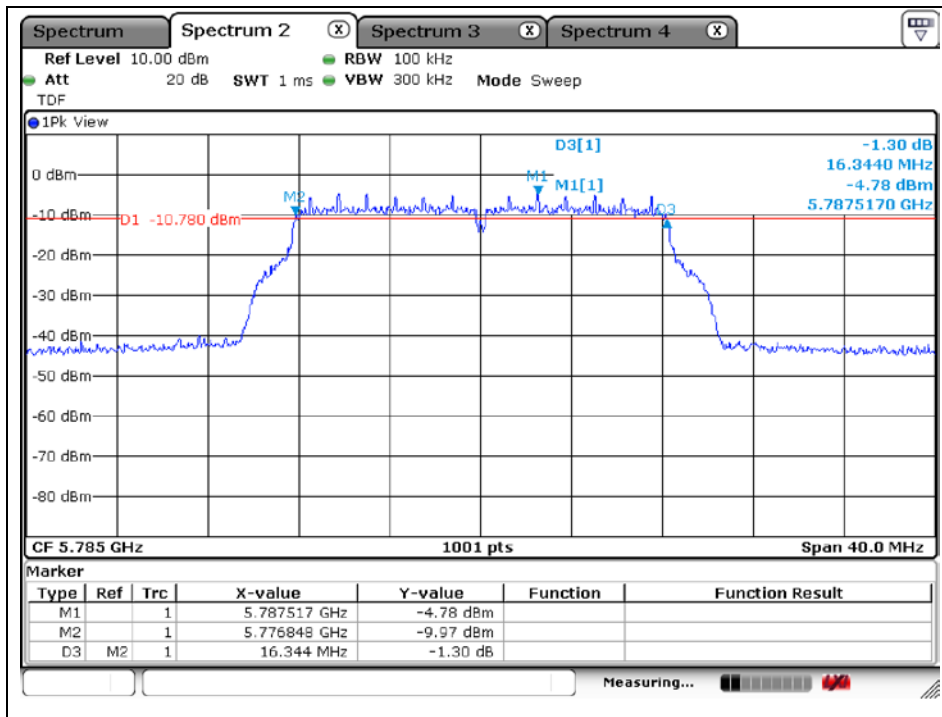

The results shown in this test report refer only to the sample(s) tested unless otherwise stated. This test report cannot be reproduced, except in full, without prior written permission of the Company.



High Channel (5 825 MHz)

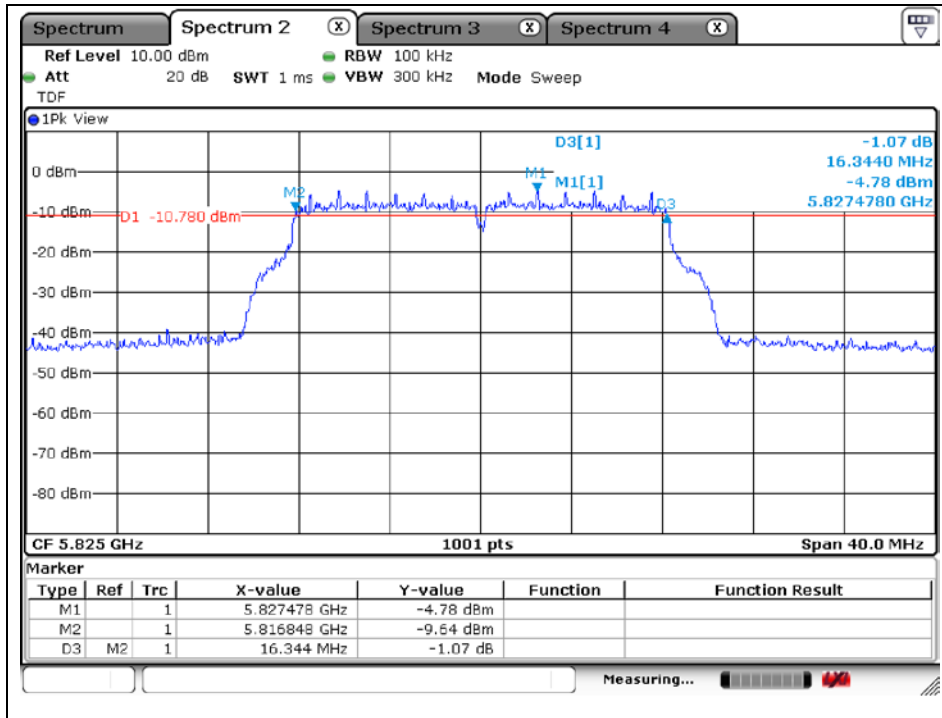

802.11n\_HT20 (Band 3)

Low Channel (5 745 MHz)

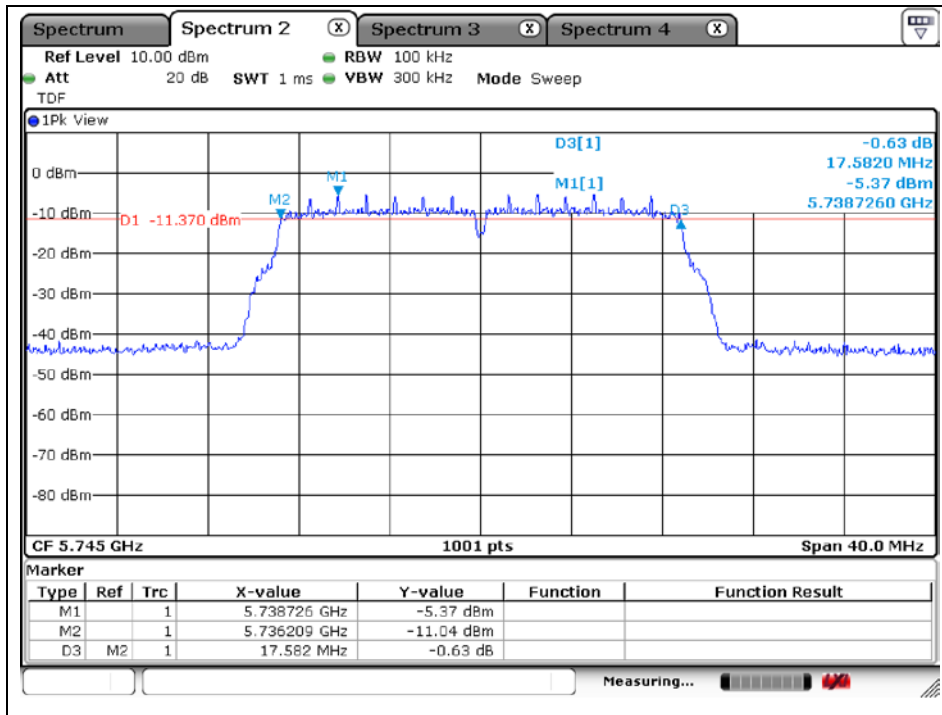

The results shown in this test report refer only to the sample(s) tested unless otherwise stated. This test report cannot be reproduced, except in full, without prior written permission of the Company.

Middle Channel (5 785 MHz)

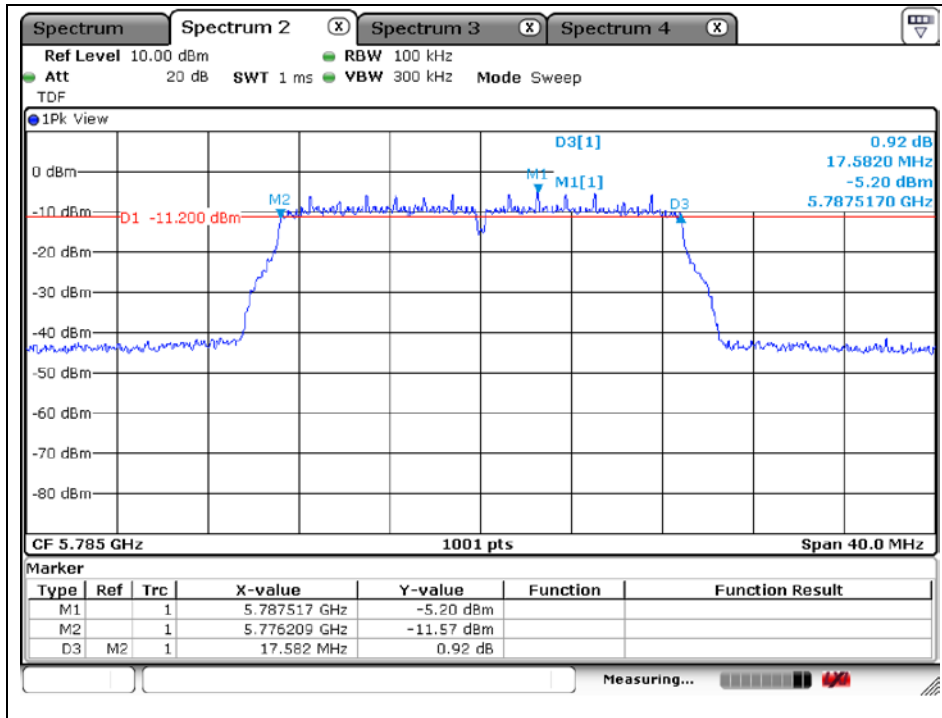

High Channel (5 825 MHz)

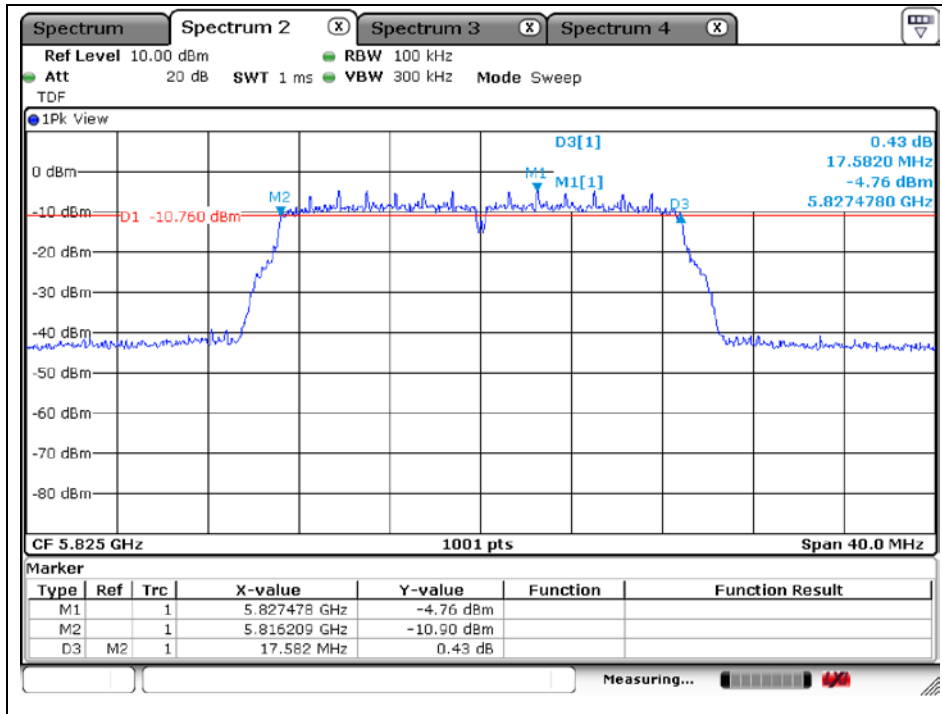

The results shown in this test report refer only to the sample(s) tested unless otherwise stated. This test report cannot be reproduced, except in full, without prior written permission of the Company.

### Band-crossing channels

#### 802.11a (5 720 MHz)

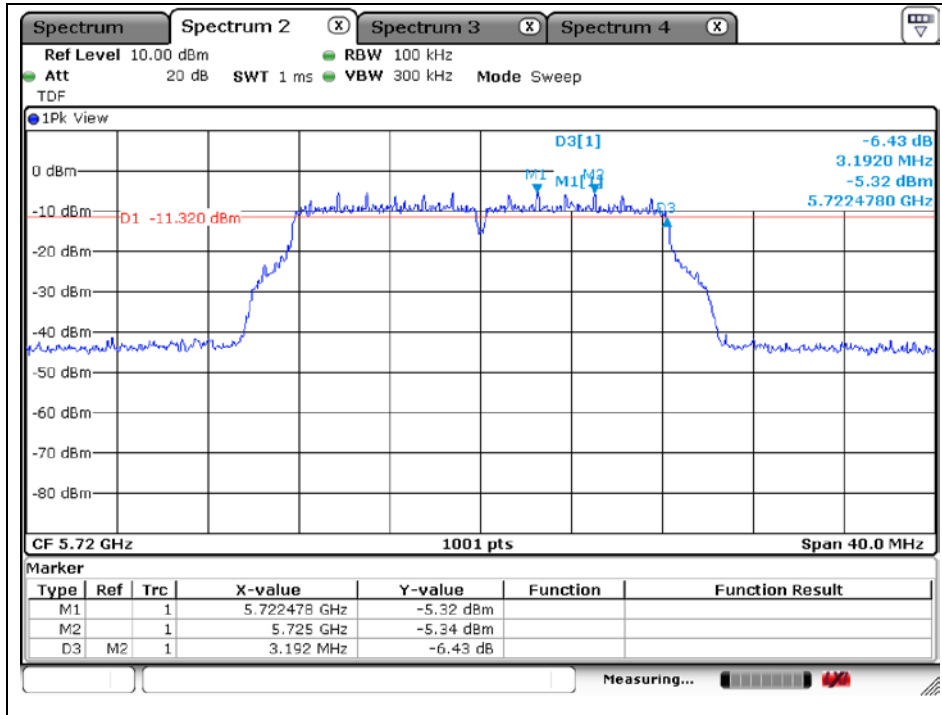

#### 802.11n\_HT20 (5 720 MHz)

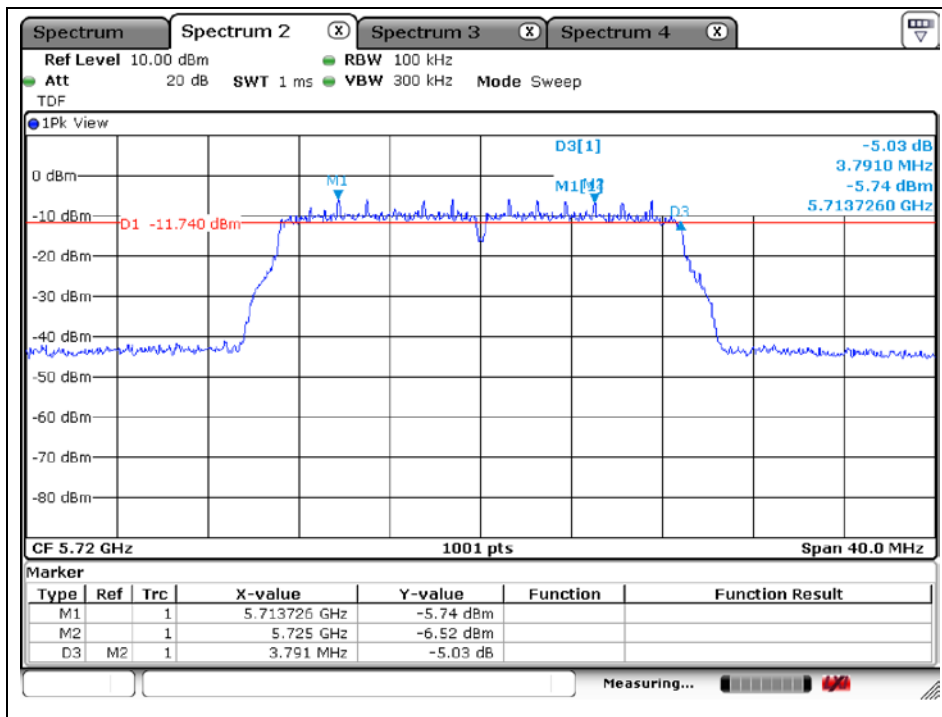

The results shown in this test report refer only to the sample(s) tested unless otherwise stated. This test report cannot be reproduced, except in full, without prior written permission of the Company.

## 5. Maximum Conducted Output Power

### 5.1. Test setup

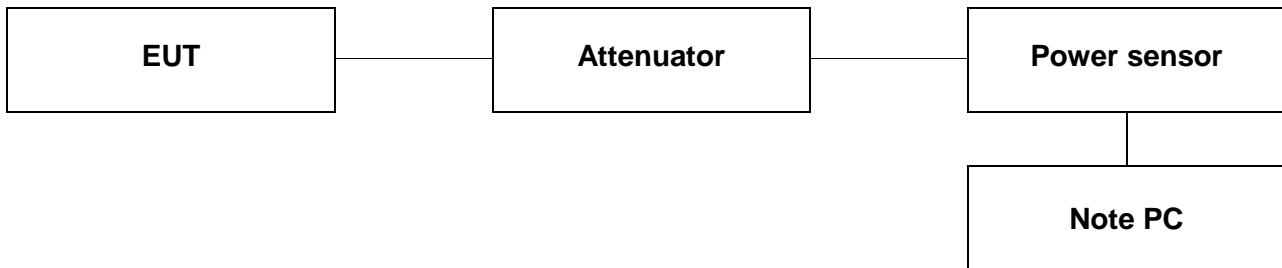

### 5.2. Limit

#### FCC 15.407 (a)(1)(iv)

For client devices in the 5.15-5.25 GHz band, the maximum conducted output power over the frequency band of operation shall not exceed 250 mW provided the maximum antenna gain does not exceed 6 dB i. In addition, the maximum power spectral density shall not exceed 11 dB m in any 1 megahertz band. If transmitting antennas of directional gain greater than 6 dB i are used, both the maximum conducted output power and the maximum power spectral density shall be reduced by the amount in dB that the directional gain of the antenna exceeds 6 dB i.

#### (a)(2)

For the 5.25-5.35 GHz and 5.47-5.725 GHz bands, the maximum conducted output power over the frequency bands of operation shall not exceed the lesser of 250 mW or 11 dB m 10 log B, where B is the 26 dB emission bandwidth in megahertz. In addition, the maximum power spectral density shall not exceed 11 dB m in any 1 megahertz band. If transmitting antennas of directional gain greater than 6 dB i are used, both the maximum conducted output power and the maximum power spectral density shall be reduced by the amount in dB that the directional gain of the antenna exceeds 6 dB i.

#### (a)(3)

For the band 5.725-5.85 GHz, the maximum conducted output power over the frequency band of operation shall not exceed 1 W. In addition, the maximum power spectral density shall not exceed 30 dB m in any 500-kHz band. If transmitting antennas of directional gain greater than 6 dB i are used, both the maximum conducted output power and the maximum power spectral density shall be reduced by the amount in dB that the directional gain of the antenna exceeds 6 dB i. However, fixed point-to point U-NII devices operating in this band may employ transmitting antennas with directional gain greater than 6 dB i without any corresponding reduction in transmitter conducted power. Fixed, point-to-point operations exclude the use of point-to-multipoint systems, omnidirectional applications, and multiple collocated transmitters transmitting the same information. The operator of the U-NII device, or if the equipment is professionally installed, the installer, is responsible for ensuring that systems employing high gain directional antennas are used exclusively for fixed, point-to-point operations.

*The results shown in this test report refer only to the sample(s) tested unless otherwise stated. This test report cannot be reproduced, except in full, without prior written permission of the Company.*

**SGS Korea Co., Ltd. (Gunpo Laboratory)** 4, LS-ro 182beon-gil, Gunpo-si, Gyeonggi-do, Korea, 15807 <http://www.sgsgroup.kr>

RTT5041-20(2015.10.01)(3)

Tel. +82 31 428 5700 / Fax. +82 31 427 2370

A4(210 mm x 297 mm)

---

### 5.3. Test procedure

1. This measurement settings are specified in section E.3.a of KDB 789033\_D02 v01r02.
2. Measurements may be performed using a wideband RF power meter with a thermocouple detector or equivalent if all of the conditions listed below are satisfied.
  - The EUT is configured to transmit continuously or to transmit with a consistent duty cycle.
  - At all times when the EUT is transmitting, it must be transmitting at its maximum power control level.
  - The integration period of the power meter exceeds the repetition period of the transmitted signal by at least a factor of five.
3. If the transmitter does not transmit continuously, measure the duty cycle,  $x$ , of the transmitter output signal as described in section II.B.
4. Measure the average power of the transmitter. This measurement is an average over both the on and off periods of the transmitter.
5. Adjust the measurement in dBm by adding  $10 \log(1/x)$  where  $x$  is the duty cycle (e.g.,  $10 \log(1/0.25)$  if the duty cycle is 25 percent).
6. In case of band crossing channels 144, the measurement is complied with section E.2.d of KDB 789033\_D02 v01r02 and section D of KDB 644545\_D03 v01.

---

*The results shown in this test report refer only to the sample(s) tested unless otherwise stated. This test report cannot be reproduced, except in full, without prior written permission of the Company.*

### 5.4. Test result

Ambient temperature : (23 ± 1) °C

Relative humidity : 47 % R.H.

#### - 11a

Band	Frequency (MHz)	Conducted Power (dB m)			
		Data Rate [Mbps]	Average Power (dB m)	Duty Correction Factor (dB)	Average Power Result (dB m)
U-NII 1	5 180	6	10.18	0.04	10.22
	5 200	6	10.28	0.04	10.32
	5 240	6	10.82	0.04	<b>10.86</b>
U-NII 2A	5 260	6	11.16	0.04	11.20
	5 280	6	11.22	0.04	11.26
	5 320	6	11.48	0.04	<b>11.52</b>
U-NII 2C	5 500	6	11.02	0.04	<b>11.06</b>
	5 580	6	10.53	0.04	10.57
	5 720	6	9.62	0.04	9.66
U-NII 3	5 745	6	9.52	0.04	<b>9.56</b>
	5 785	6	8.93	0.04	8.97
	5 825	6	8.63	0.04	8.67

Band	Conducted Power Limit (dB m)					
	Frequency (MHz)	Fixed Limit (dB m)	26 dB BW (MHz)	11+10LogB (dB m)	Antenna gain (dB i)	Limit (dB m)
U-NII 1	5 180	23.98				
	5 200	23.98				
	5 240	23.98				
U-NII 2A	5 260	23.98	20.40	24.10	3.50	23.98
	5 280	23.98	20.30	24.07	3.50	23.98
	5 320	23.98	20.34	24.08	3.50	23.98
U-NII 2C	5 500	23.98	20.34	24.08	3.34	23.98
	5 580	23.98	20.38	24.09	3.34	23.98
	5 720	23.98	20.30	24.07	3.34	23.98
U-NII 3	5 745	30				
	5 785	30				
	5 825	30				

The results shown in this test report refer only to the sample(s) tested unless otherwise stated. This test report cannot be reproduced, except in full, without prior written permission of the Company.

SGS Korea Co., Ltd. (Gunpo Laboratory) 4, LS-ro 182beon-gil, Gunpo-si, Gyeonggi-do, Korea, 15807 <http://www.sgsgroup.kr>

**- 11n\_HT20**

Band	Frequency (MHz)	Conducted Power (dB m)			
		Data Rate [Mbps]	Average Power (dB m)	Duty Correction Factor (dB)	Average Power Result (dB m)
U-NII 1	5 180	MCS0	9.58	0.04	9.62
	5 200	MCS0	9.76	0.04	9.80
	5 240	MCS0	10.01	0.04	<b>10.05</b>
U-NII 2A	5 260	MCS0	10.29	0.04	10.33
	5 280	MCS0	10.36	0.04	10.40
	5 320	MCS0	10.61	0.04	<b>10.65</b>
U-NII 2C	5 500	MCS0	10.11	0.04	<b>10.15</b>
	5 580	MCS0	9.72	0.04	9.76
	5 720	MCS0	9.65	0.04	9.69
U-NII 3	5 745	MCS0	8.63	0.04	<b>8.67</b>
	5 785	MCS0	8.00	0.04	8.04
	5 825	MCS0	7.87	0.04	7.91

Band	Conducted Power Limit (dB m)					
	Frequency (MHz)	Fixed Limit (dB m)	26 dB BW (MHz)	11+10LogB (dB m)	Antenna gain (dB i)	Limit (dB m)
U-NII 1	5 180	23.98				
	5 200	23.98				
	5 240	23.98				
U-NII 2A	5 260	23.98	20.48	24.11	3.50	23.98
	5 280	23.98	20.50	24.12	3.50	23.98
	5 320	23.98	20.46	24.11	3.50	23.98
U-NII 2C	5 500	23.98	20.50	24.12	3.34	23.98
	5 580	23.98	20.46	24.11	3.34	23.98
	5 720	23.98	20.50	24.12	3.34	23.98
U-NII 3	5 745	30				
	5 785	30				
	5 825	30				

The results shown in this test report refer only to the sample(s) tested unless otherwise stated. This test report cannot be reproduced, except in full, without prior written permission of the Company.

**-Band-crossing channels**

Band	Mode	Frequency (MHz)	Mea. Average (dB m)	Duty Correction Factor (dB)	Result (dB m)	Limit (dB m)
U-NII 2C	11a	5 720	4.63	0.04	4.67	22.82
U-NII 3			-1.96	0.04	-1.92	30
U-NII 2C	11n_HT20	5 720	4.62	0.04	4.66	22.83
U-NII 3			-1.46	0.04	-1.42	30

Band	Mode	Conducted Power Limit (dB m)					
		Frequency (MHz)	Fixed Limit (dB m)	26 dB BW (MHz)	11+10LogB (dB m)	Antenna gain (dB i)	Limit (dB m)
U-NII 2C	11a	5 720	23.98	15.19	22.82	3.34	22.82
U-NII 3							
U-NII 2C	11n_HT20	5 720	23.98	15.23	22.83	3.34	22.83
U-NII 3							

Remark:

1. Result (dB m) = Average Power(dB m) + Correction factor (dB)

The results shown in this test report refer only to the sample(s) tested unless otherwise stated. This test report cannot be reproduced, except in full, without prior written permission of the Company.



### Band-crossing channels

#### 802.11a (5 720 MHz)

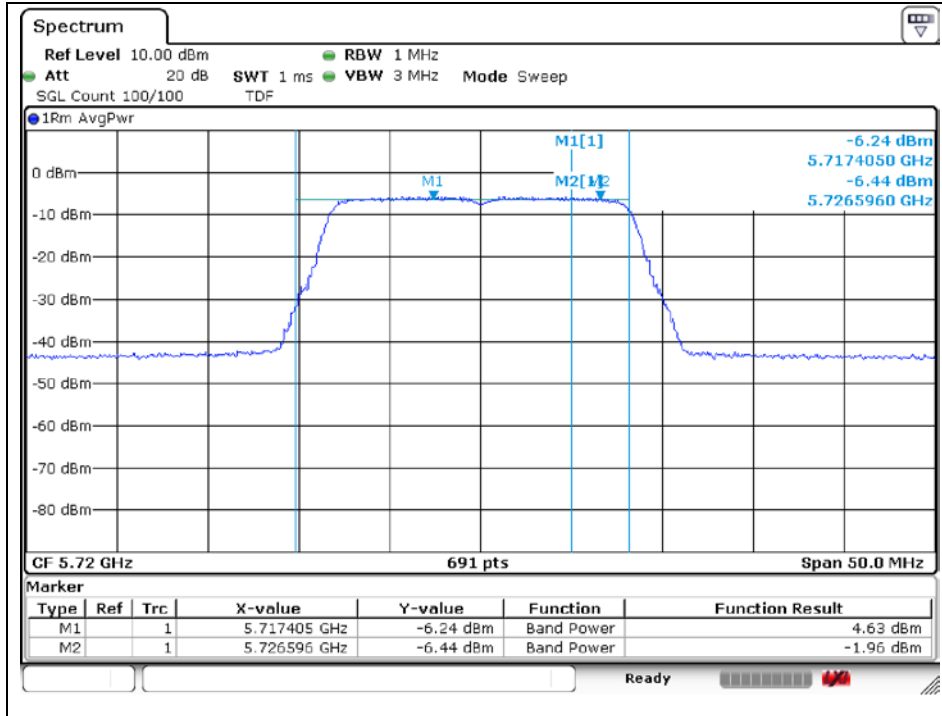

#### 802.11n\_HT20 (5 720 MHz)

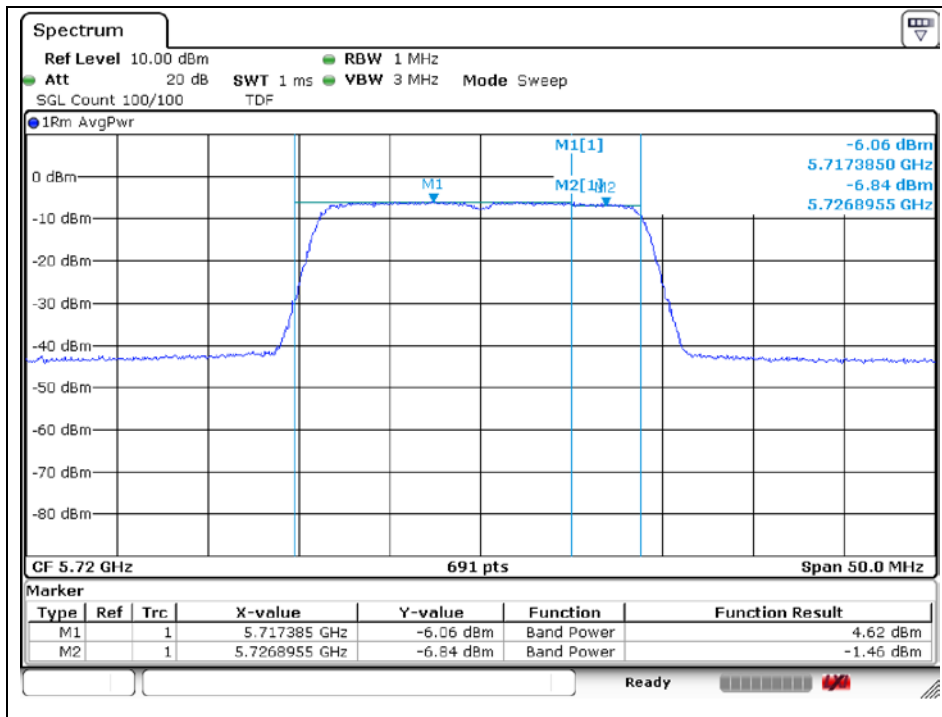

The results shown in this test report refer only to the sample(s) tested unless otherwise stated. This test report cannot be reproduced, except in full, without prior written permission of the Company.

## 6. Peak Power Spectral Density

### 6.1. Test setup



### 6.2. Limit

#### FCC 15.407 (a)(1)(iv)

For client devices in the 5.15-5.25 GHz band, the maximum conducted output power over the frequency band of operation shall not exceed 250 mW provided the maximum antenna gain does not exceed 6 dBi. In addition, the maximum power spectral density shall not exceed 11 dBm in any 1 megahertz band. If transmitting antennas of directional gain greater than 6 dBi are used, both the maximum conducted output power and the maximum power spectral density shall be reduced by the amount in dB that the directional gain of the antenna exceeds 6 dBi.

#### (a)(2)

For the 5.25-5.35 GHz and 5.47-5.725 GHz bands, the maximum conducted output power over the frequency bands of operation shall not exceed the lesser of 250 mW or  $11 \text{ dBm} + 10 \log B$ , where B is the 26 dB emission bandwidth in megahertz. In addition, the maximum power spectral density shall not exceed 11 dBm in any 1 megahertz band. If transmitting antennas of directional gain greater than 6 dBi are used, both the maximum conducted output power and the maximum power spectral density shall be reduced by the amount in dB that the directional gain of the antenna exceeds 6 dBi.

#### (a)(3)

For the band 5.725-5.85 GHz, the maximum conducted output power over the frequency band of operation shall not exceed 1 W. In addition, the maximum power spectral density shall not exceed 30 dBm in any 500-kHz band. If transmitting antennas of directional gain greater than 6 dBi are used, both the maximum conducted output power and the maximum power spectral density shall be reduced by the amount in dB that the directional gain of the antenna exceeds 6 dBi. However, fixed point-to-point U-NII devices operating in this band may employ transmitting antennas with directional gain greater than 6 dBi without any corresponding reduction in transmitter conducted power. Fixed, point-to-point operations exclude the use of point-to-multipoint systems, omnidirectional applications, and multiple collocated transmitters transmitting the same information. The operator of the U-NII device, or if the equipment is professionally installed, the installer, is responsible for ensuring that systems employing high gain directional antennas are used exclusively for fixed, point-to-point operations.

*The results shown in this test report refer only to the sample(s) tested unless otherwise stated. This test report cannot be reproduced, except in full, without prior written permission of the Company.*

SGS Korea Co., Ltd. (Gunpo Laboratory) 4, LS-ro 182beon-gil, Gunpo-si, Gyeonggi-do, Korea, 15807 <http://www.sgsgroup.kr>

### 6.3. Test procedure

All data rates and modes were investigated for this test. The full data for the worst case data rate are reported in this section.

1. This measurement settings are specified in section F of KDB 789033\_D02 v01r02.
2. Create an average power spectrum for the EUT operating mode being tested by following the instructions in section II.E.2. for measuring maximum conducted output power using a spectrum analyzer or EMI receiver: select the appropriate test method (SA-1, SA-2, SA-3, or alternatives to each) and apply it up to, but not including, the step labeled, "Compute power...". (This procedure is required even if the maximum conducted output power measurement was performed using a power meter, method PM.)
3. Use the peak search function on the instrument to find the peak of the spectrum and record its value.
4. Make the following adjustments to the peak value of the spectrum, if applicable:
  - a) **If Method SA-2 or SA-2 Alternative was used, add  $10 \log(1/x)$ , where  $x$  is the duty cycle, to the peak of the spectrum.**
  - b) If Method SA-3 Alternative was used and the linear mode was used in step II.E.2.g)(viii), add 1 dB to the final result to compensate for the difference between linear averaging and power averaging.
5. The result is the Maximum PSD over 1 MHz reference bandwidth.
6. For devices operating in the bands 5.15-5.25 GHz, 5.25-5.35 GHz, and 5.47-5.725 GHz, the above procedures make use of 1 MHz RBW to satisfy directly the 1 MHz reference bandwidth specified in § 15.407(a)(5). For devices operating in the band 5.725-5.85 GHz, the rules specify a measurement bandwidth of 500 kHz. Many spectrum analyzers do not have 500 kHz RBW, thus a narrower RBW may need to be used. The rules permit the use of a RBWs less than 1 MHz, or 500 kHz, "provided that the measured power is integrated over the full reference bandwidth" to show the total power over the specified measurement bandwidth (*i.e.*, 1 MHz, or 500 kHz). If measurements are performed using a reduced resolution bandwidth (< 1 MHz, or < 500 kHz) and integrated over 1 MHz, or 500 kHz bandwidth, the following adjustments to the procedures apply:
  - a) Set  $RBW \geq 1/T$ , where  $T$  is defined in section II.B.1.a).
  - b) Set  $VBW \geq 3 RBW$ .
  - c) If measurement bandwidth of Maximum PSD is specified in 500 kHz, add  $10 \log(500 \text{ kHz}/RBW)$  to the measured result, whereas RBW (< 500 kHz) is the reduced resolution bandwidth of the spectrum analyzer set during measurement.
  - d) If measurement bandwidth of Maximum PSD is specified in 1 MHz, add  $10 \log(1 \text{ MHz}/RBW)$  to the measured result, whereas RBW (< 1 MHz) is the reduced resolution bandwidth of spectrum analyzer set during measurement.
  - e) Care must be taken to ensure that the measurements are performed during a period of continuous transmission or are corrected upward for duty cycle.Note: As a practical matter, it is recommended to use reduced RBW of 100 kHz for the sections 5.c) and 5.d) above, since RBW = 100 kHz is available on nearly all spectrum analyzers.
7. In case of band crossing channels 144, the measurement is complied with section D of KDB 644545\_D03 v01.

*The results shown in this test report refer only to the sample(s) tested unless otherwise stated. This test report cannot be reproduced, except in full, without prior written permission of the Company.*

## 6.4. Test result

Ambient temperature : (23 ± 1) °C

Relative humidity : 47 % R.H.

Band	Mode	Frequency (MHz)	Ch.	Data Rate	Measured PPSS (dB m)	Duty Factor (dB)	Final PPSS (dB m)	Limit (dB m/1 MHz)
U-NII 1	11a	5 180	36	6 Mbps	-4.55	0.04	-4.51	11
		5 200	44	6 Mbps	-3.56	0.04	-3.52	11
		5 240	48	6 Mbps	-4.31	0.04	-4.27	11
	11n_HT20	5 180	36	MCS0	-3.96	0.04	-3.92	11
		5 200	44	MCS0	-3.82	0.04	-3.78	11
		5 240	48	MCS0	-4.30	0.04	-4.26	11
U-NII 2A	11a	5 260	52	6 Mbps	-3.89	0.04	-3.85	11
		5 280	60	6 Mbps	-3.93	0.04	-3.89	11
		5 320	64	6 Mbps	-3.45	0.04	-3.41	11
	11n_HT20	5 260	52	MCS0	-4.59	0.04	-4.55	11
		5 280	60	MCS0	-3.66	0.04	-3.62	11
		5 320	64	MCS0	-3.66	0.04	-3.62	11
U-NII 2C	11a	5 500	134	6 Mbps	-4.55	0.04	-4.51	11
		5 580	106	6 Mbps	-4.05	0.04	-4.01	11
		5 720	144	6 Mbps	-6.32	0.04	-6.28	11
	11n_HT20	5 500	100	MCS0	-4.03	0.04	-3.99	11
		5 580	116	MCS0	-4.34	0.04	-4.30	11
		5 720	144	MCS0	-5.62	0.04	-5.58	11

Band	Mode	Frequency (MHz)	Ch.	Data Rate	Measured PPSS (dB m)	Duty Factor (dB)	Final PPSS (dB m)	Limit (dB m/500 kHz)
U-NII 3	11a	5 745	149	6 Mbps	-8.71	0.04	-8.67	30
		5 785	157	6 Mbps	-7.74	0.04	-7.70	30
		5 825	165	6 Mbps	-7.32	0.04	-7.28	30
	11n_HT20	5 745	149	MCS0	-8.54	0.04	-8.50	30
		5 785	157	MCS0	-7.99	0.04	-7.95	30
		5 825	165	MCS0	-7.92	0.04	-7.88	30

### - Band-crossing channels.

Band	Mode	Frequency (MHz)	Ch.	Data Rate	Measured PPSS (dB m)	Duty Factor (dB)	Final PPSS (dB m)	Limit (dBm/500 kHz)
U-NII 3 (Band-crossing channel)	11a	5 720	144	6 Mbps	-8.23	0.04	-8.19	30
	11n_HT20	5 720	144	MCS0	-8.94	0.04	-8.90	30

Note : Final PPSS (dB m) = Measured PPSS (dB m) + Duty Factor (dB)

The results shown in this test report refer only to the sample(s) tested unless otherwise stated. This test report cannot be reproduced, except in full, without prior written permission of the Company.

**802.11a (Band 1)**

Low Channel (5 180 MHz)

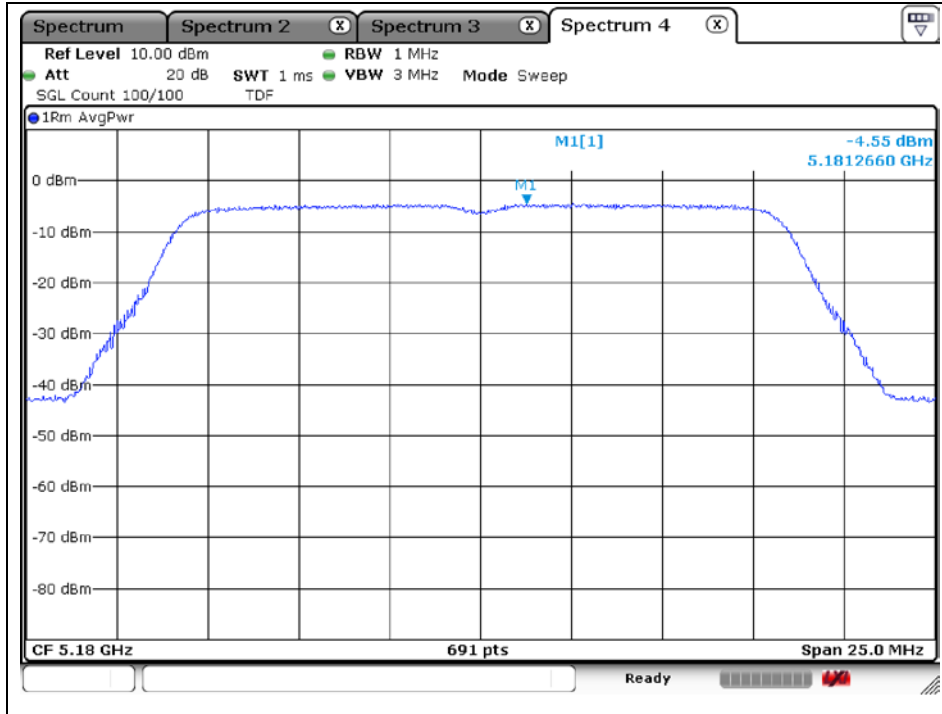

Middle Channel (5 200 MHz)

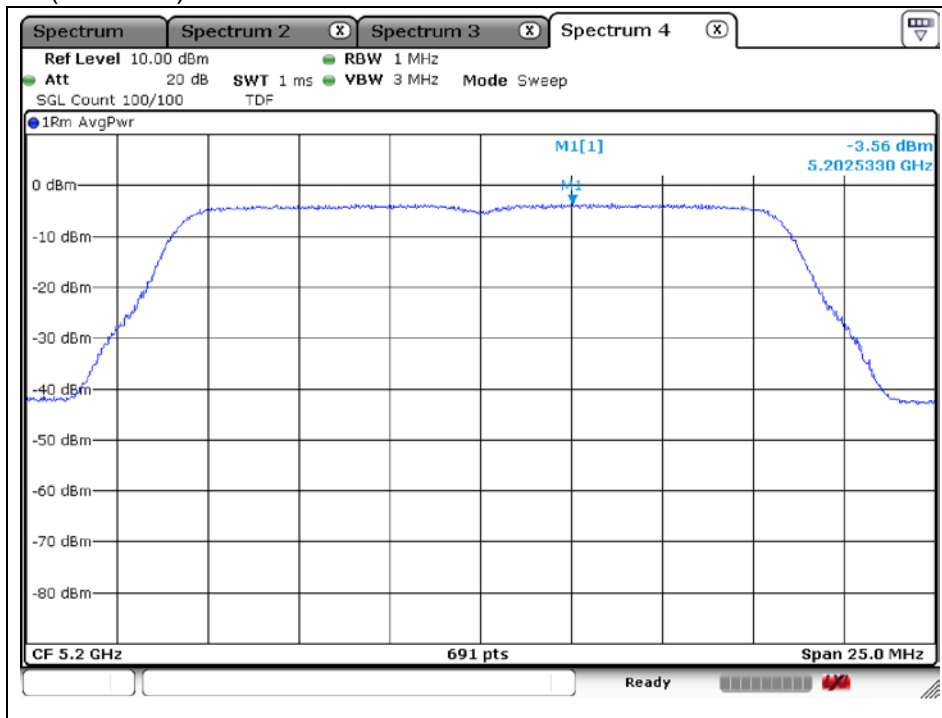

The results shown in this test report refer only to the sample(s) tested unless otherwise stated. This test report cannot be reproduced, except in full, without prior written permission of the Company.

High Channel (5 240 MHz)

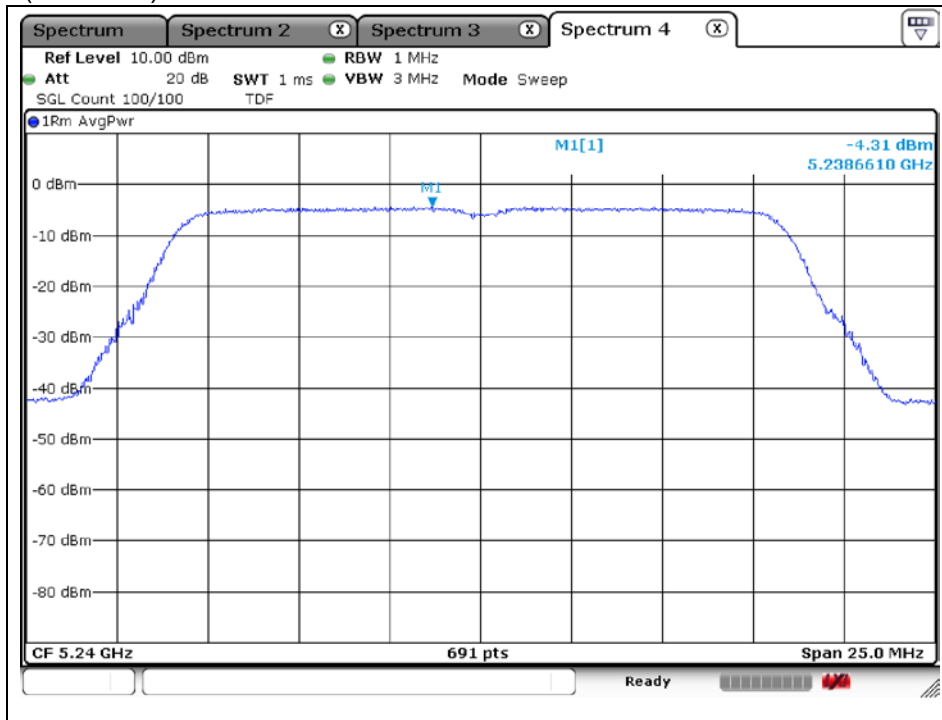

802.11a (Band 2A)

Low Channel (5 260 MHz)

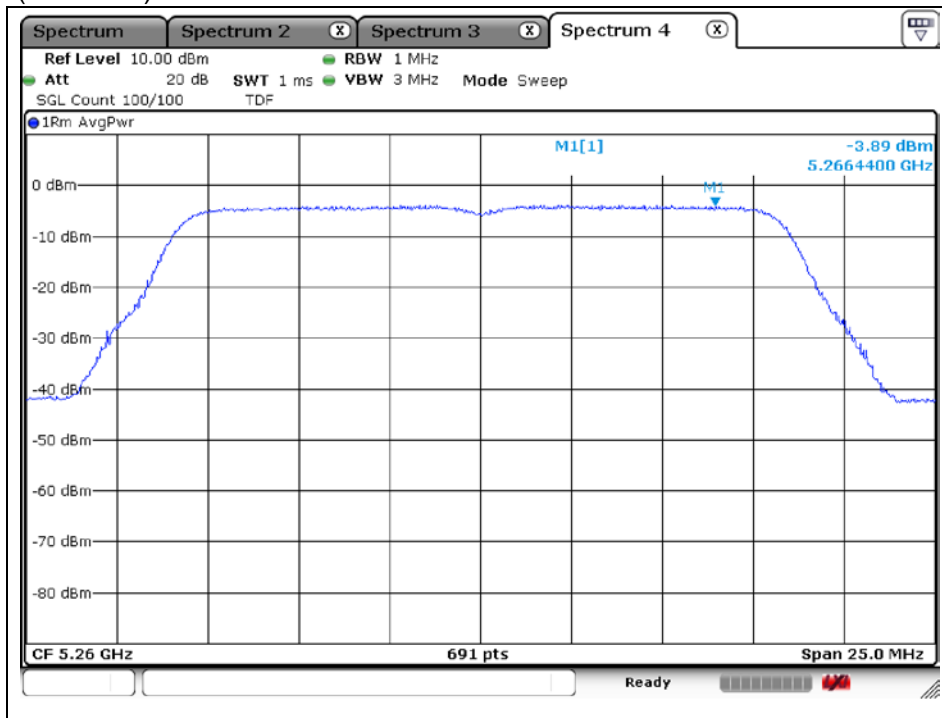

The results shown in this test report refer only to the sample(s) tested unless otherwise stated. This test report cannot be reproduced, except in full, without prior written permission of the Company.

Middle Channel (5 280 MHz)

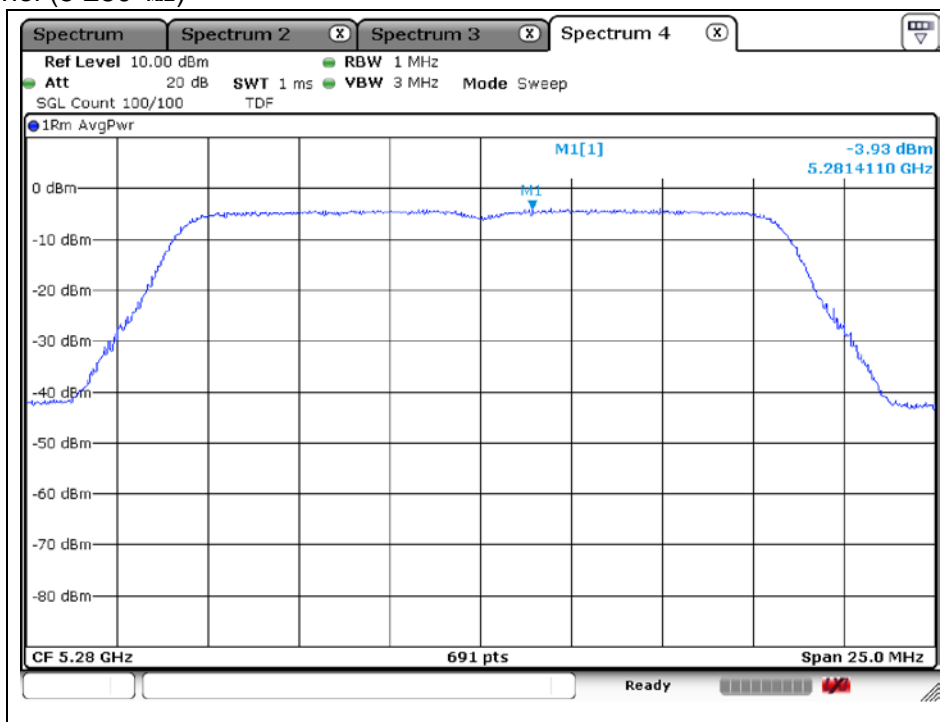

High Channel (5 320 MHz)

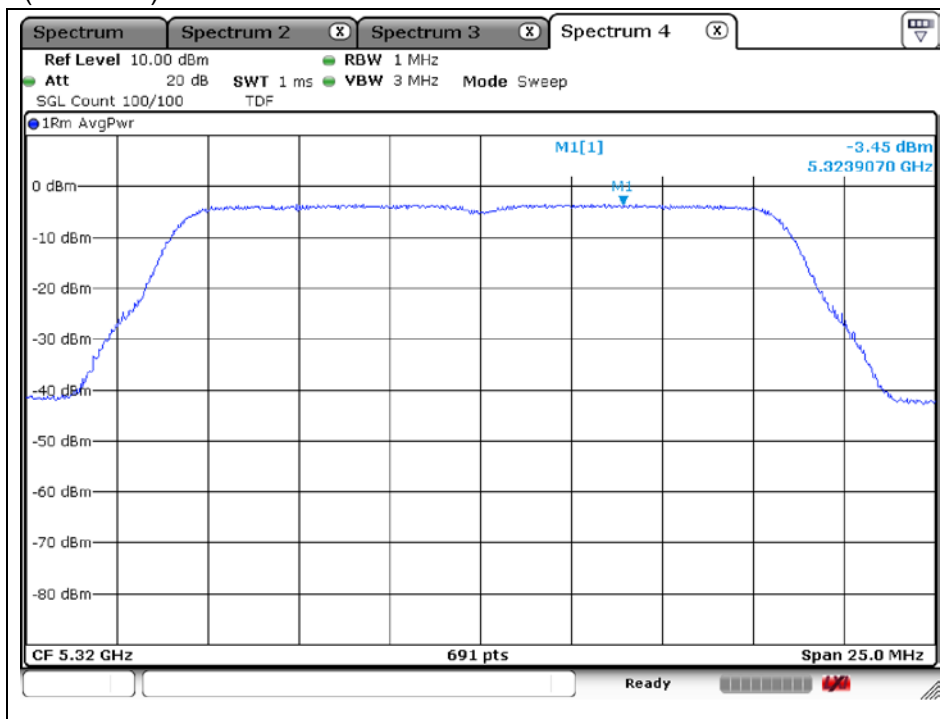

The results shown in this test report refer only to the sample(s) tested unless otherwise stated. This test report cannot be reproduced, except in full, without prior written permission of the Company.

### 802.11a (Band 2C)

#### Low Channel (5 500 MHz)

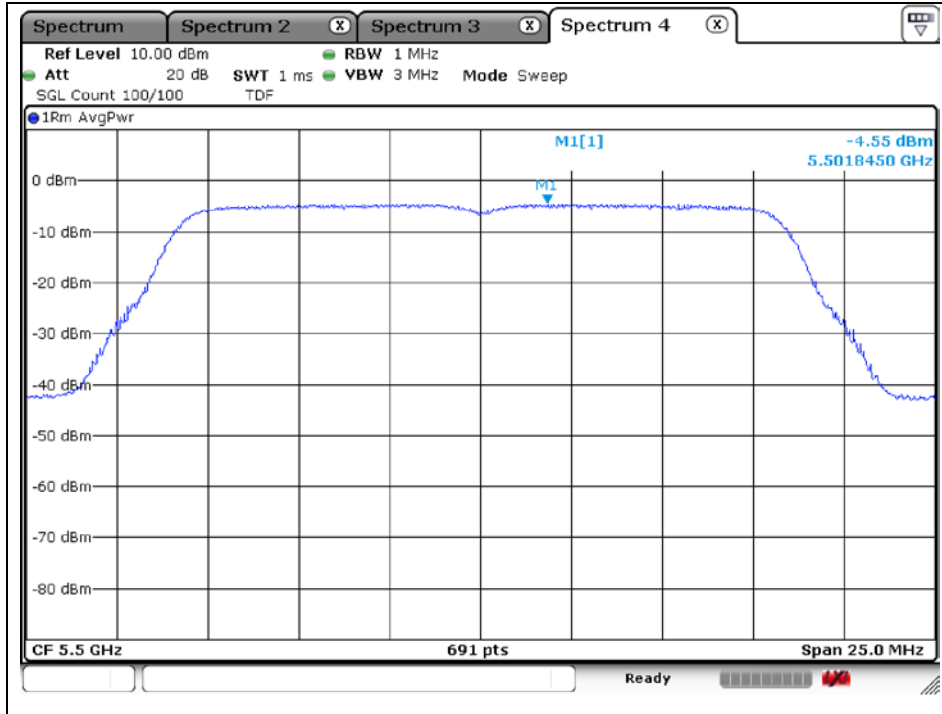

#### Middle Channel (5 580 MHz)

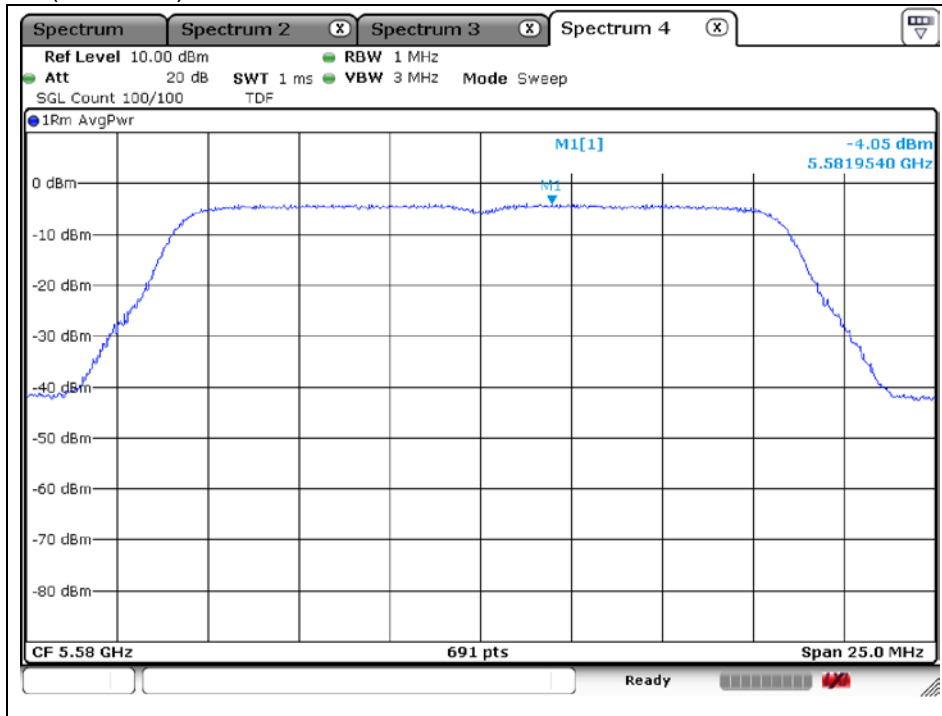

The results shown in this test report refer only to the sample(s) tested unless otherwise stated. This test report cannot be reproduced, except in full, without prior written permission of the Company.



High Channel (5 720 MHz)

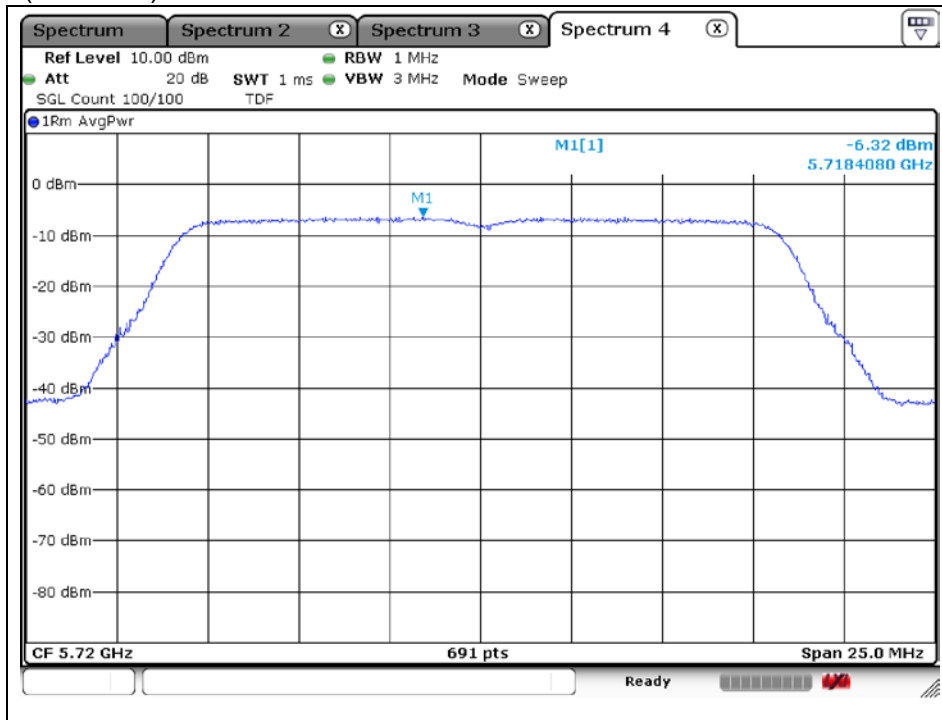

802.11a (Band 3)

Low Channel (5 745 MHz)

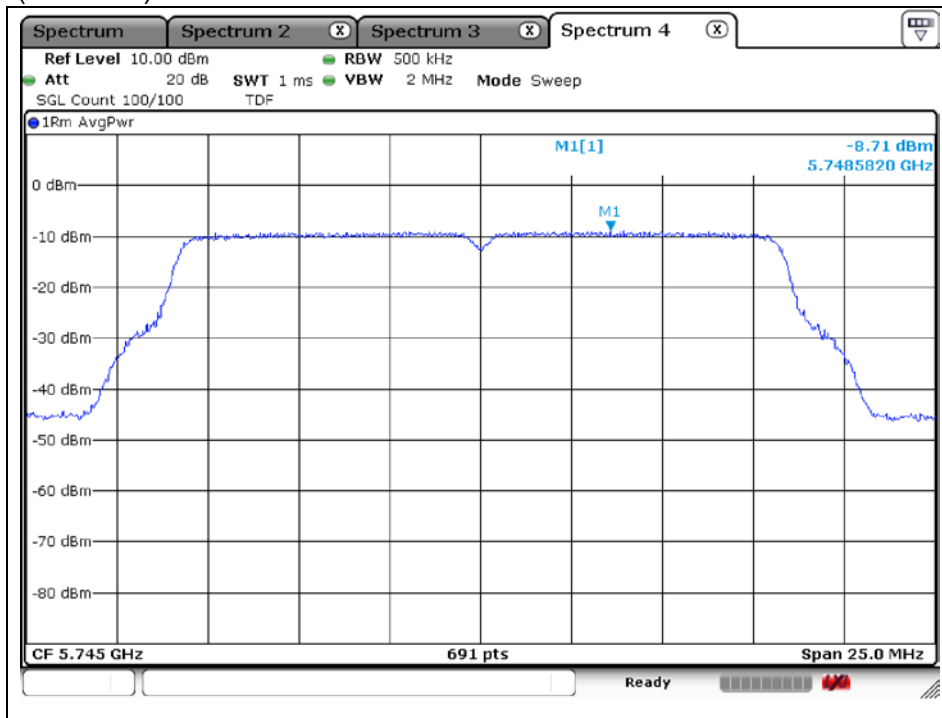

The results shown in this test report refer only to the sample(s) tested unless otherwise stated. This test report cannot be reproduced, except in full, without prior written permission of the Company.

Middle Channel (5 785 MHz)

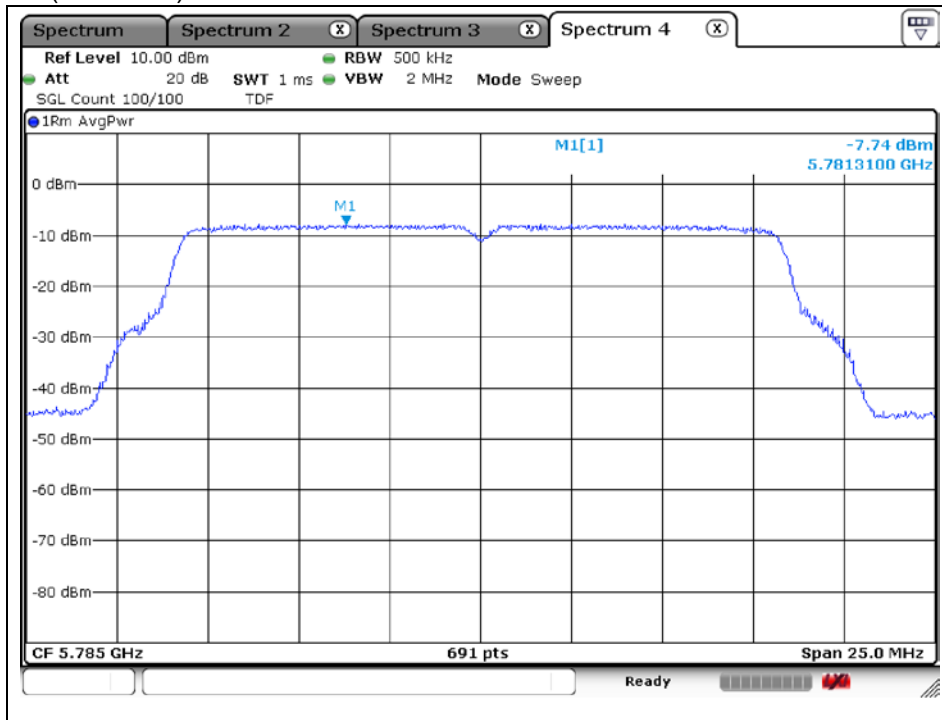

High Channel (5 825 MHz)

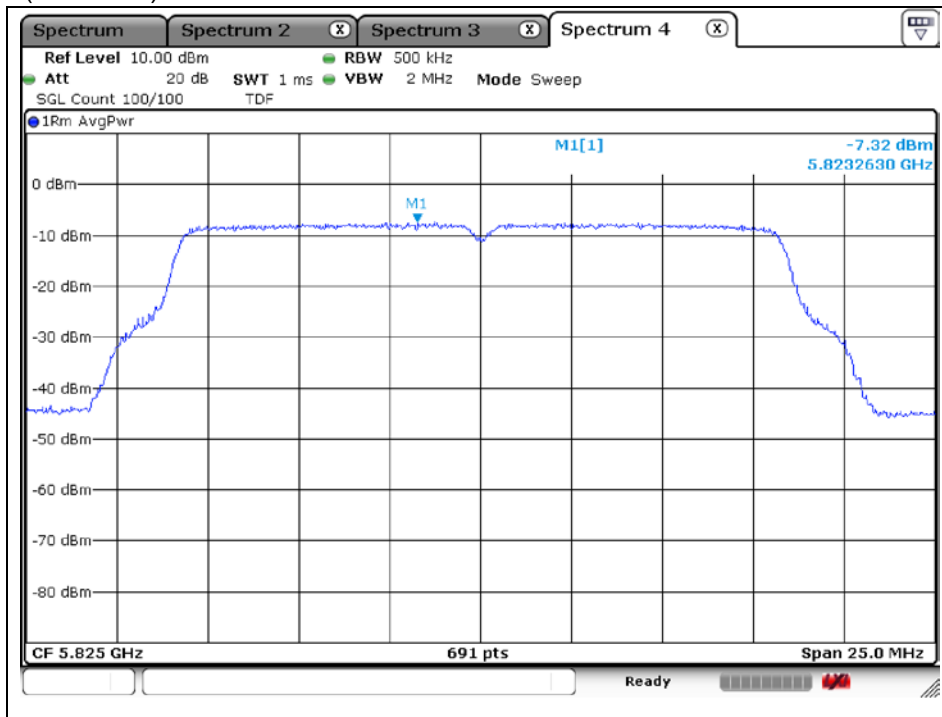

The results shown in this test report refer only to the sample(s) tested unless otherwise stated. This test report cannot be reproduced, except in full, without prior written permission of the Company.

**802.11n\_HT20 (Band 1)**

Low Channel (5 180 MHz)

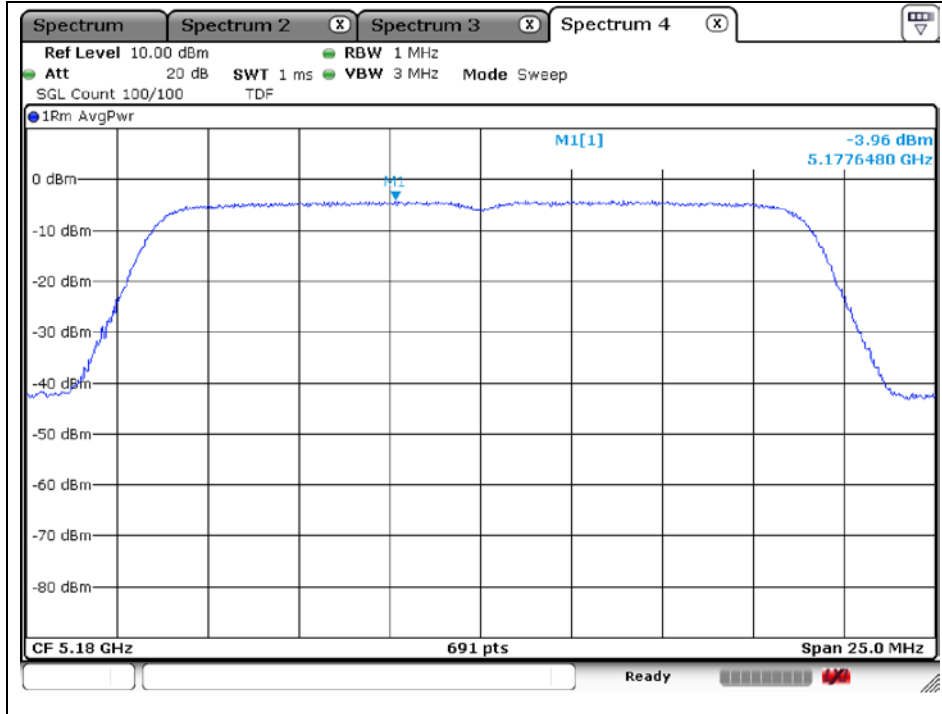

Middle Channel (5 200 MHz)

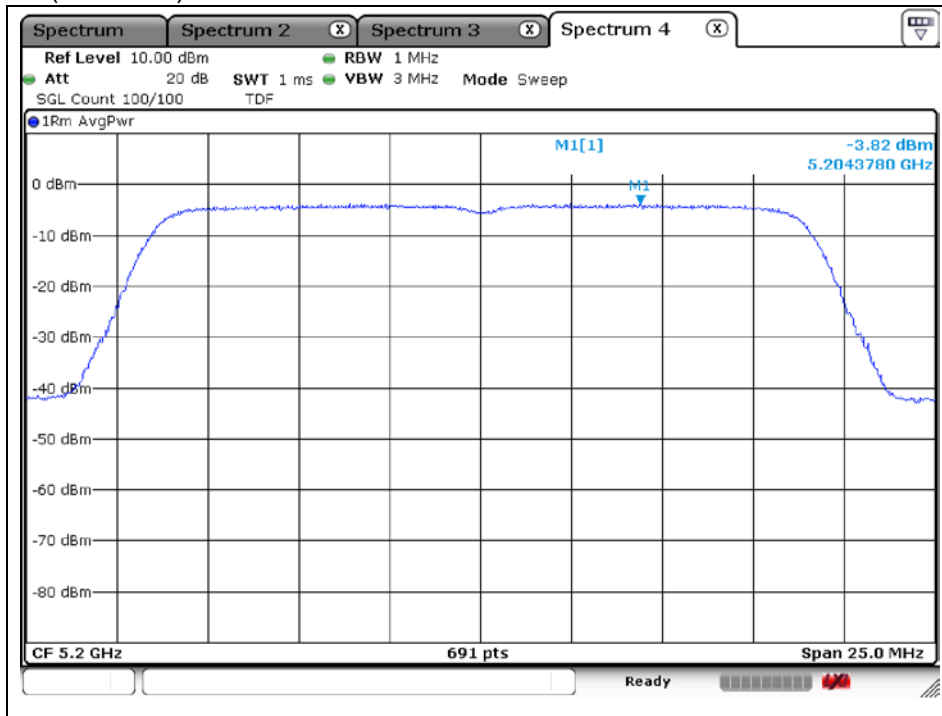

The results shown in this test report refer only to the sample(s) tested unless otherwise stated. This test report cannot be reproduced, except in full, without prior written permission of the Company.

High Channel (5 240 MHz)

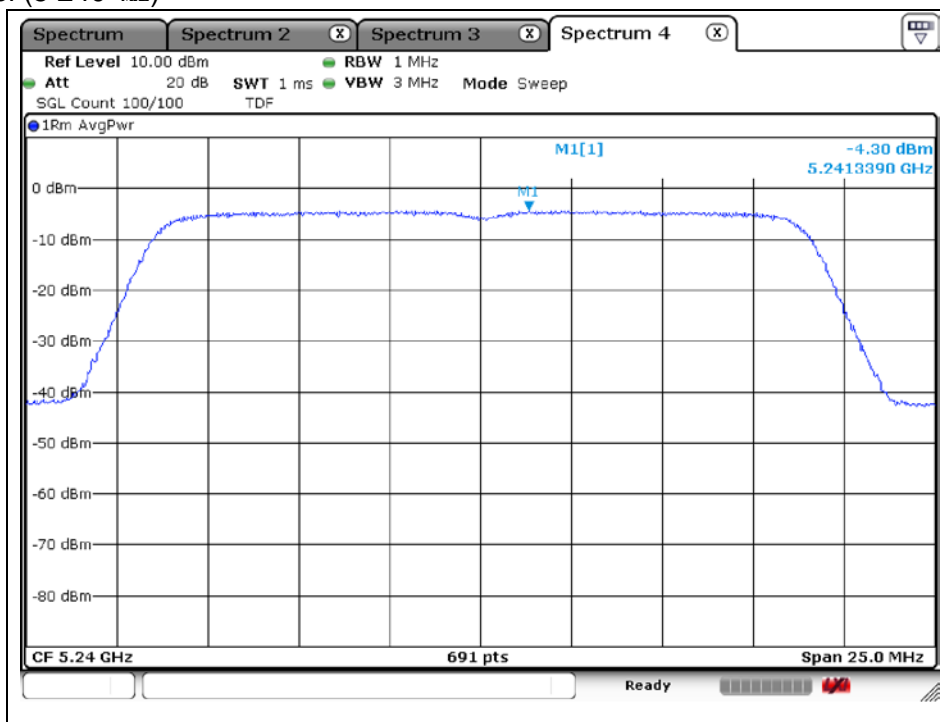

802.11n\_HT20 (Band 2A)

Low Channel (5 260 MHz)

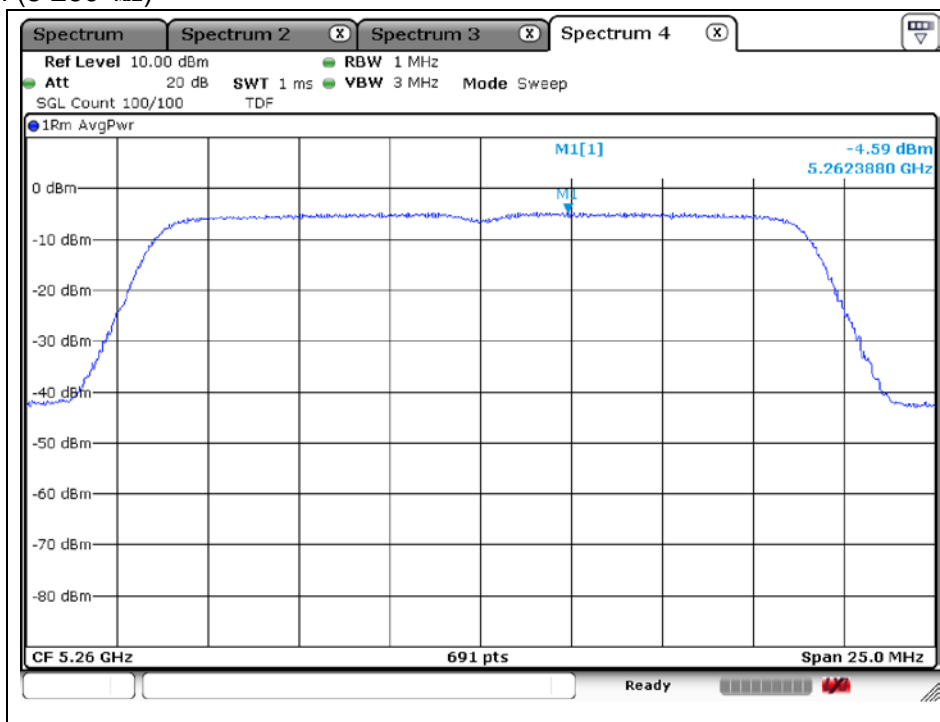

The results shown in this test report refer only to the sample(s) tested unless otherwise stated. This test report cannot be reproduced, except in full, without prior written permission of the Company.

Middle Channel (5 280 MHz)

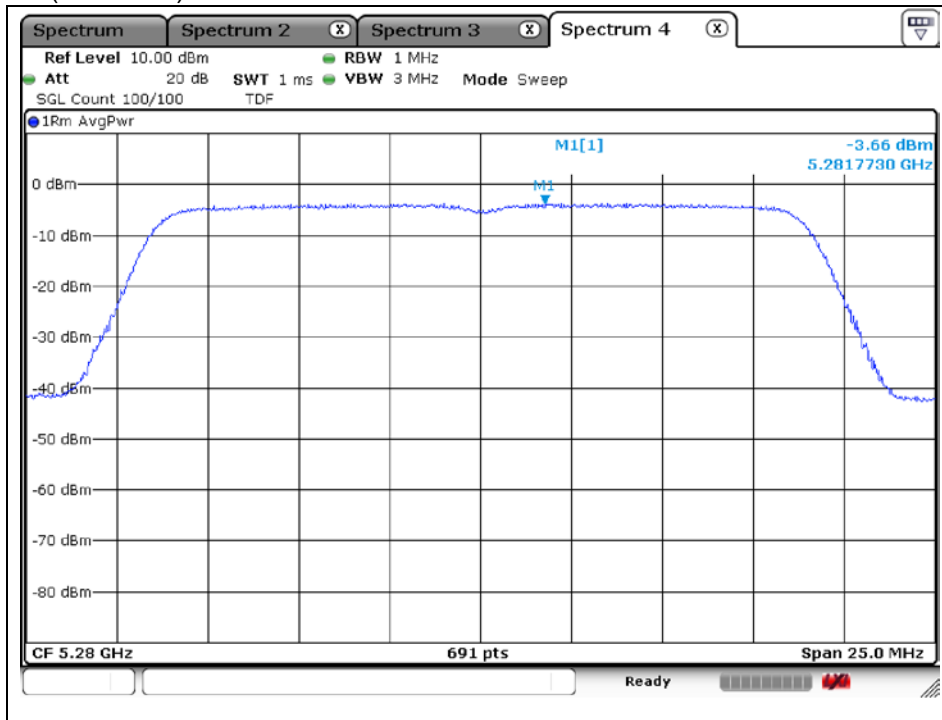

High Channel (5 320 MHz)

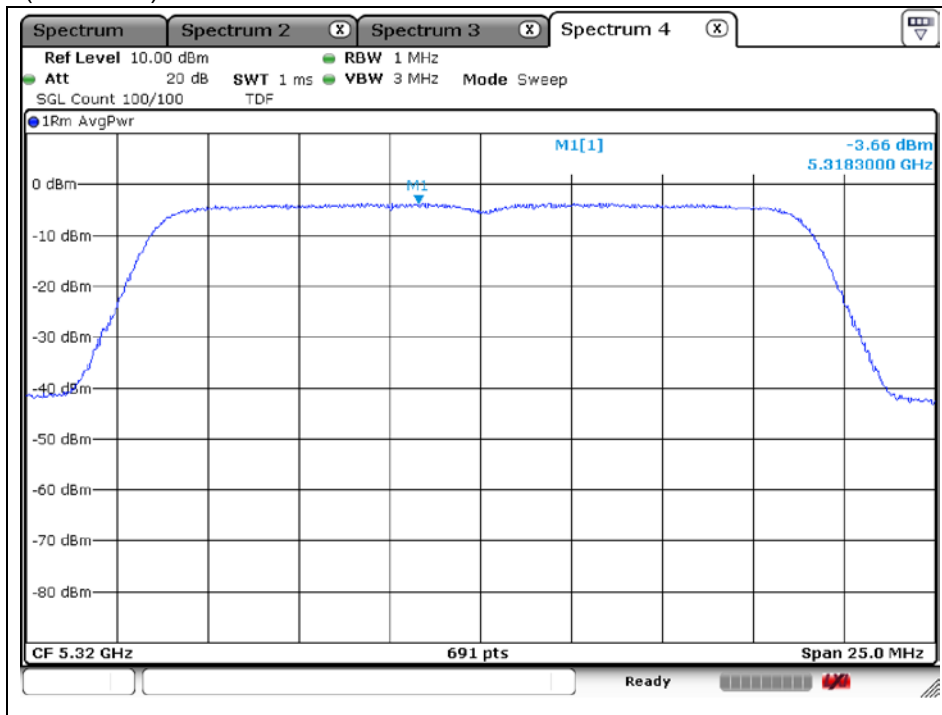

The results shown in this test report refer only to the sample(s) tested unless otherwise stated. This test report cannot be reproduced, except in full, without prior written permission of the Company.

**802.11n\_HT20 (Band 2C)**

Low Channel (5 500 MHz)

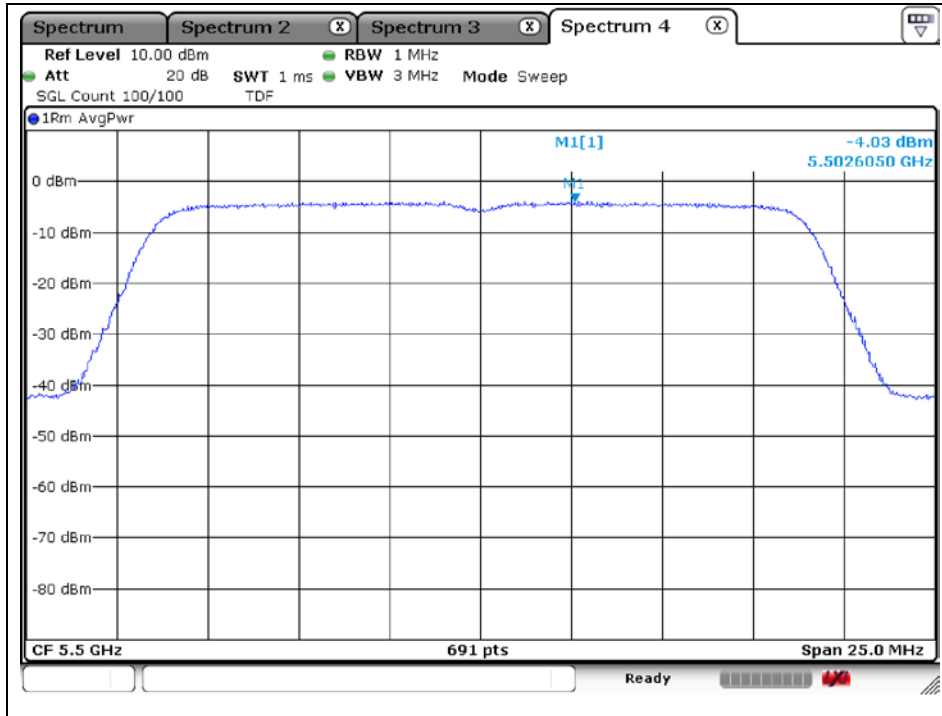

Middle Channel (5 580 MHz)

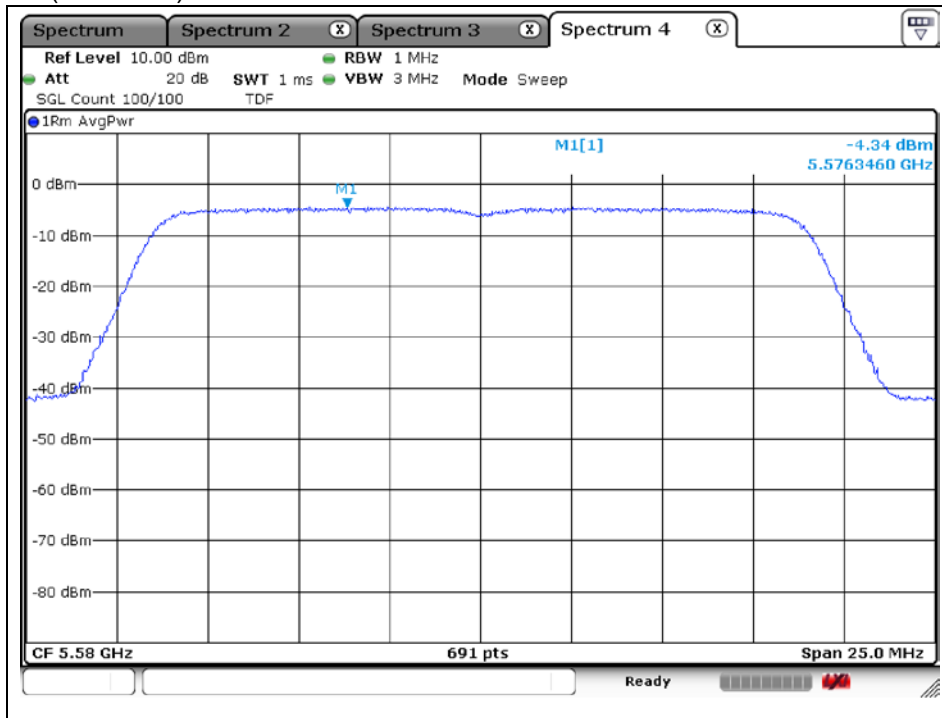

The results shown in this test report refer only to the sample(s) tested unless otherwise stated. This test report cannot be reproduced, except in full, without prior written permission of the Company.

### High Channel (5 720 MHz)

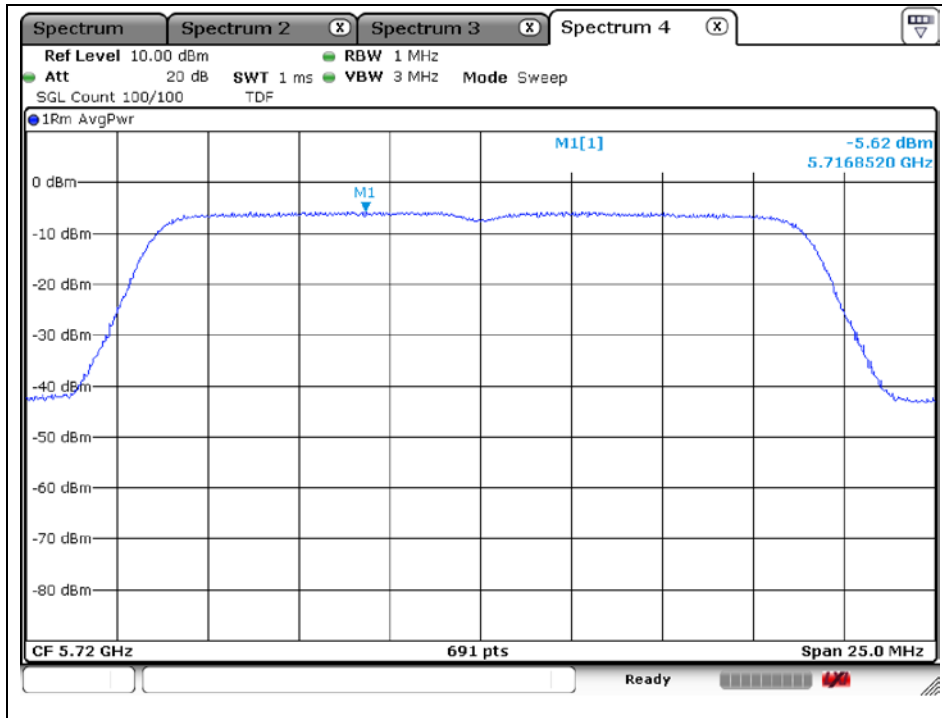

### 802.11n\_HT20 (Band 3)

### Low Channel (5 745 MHz)

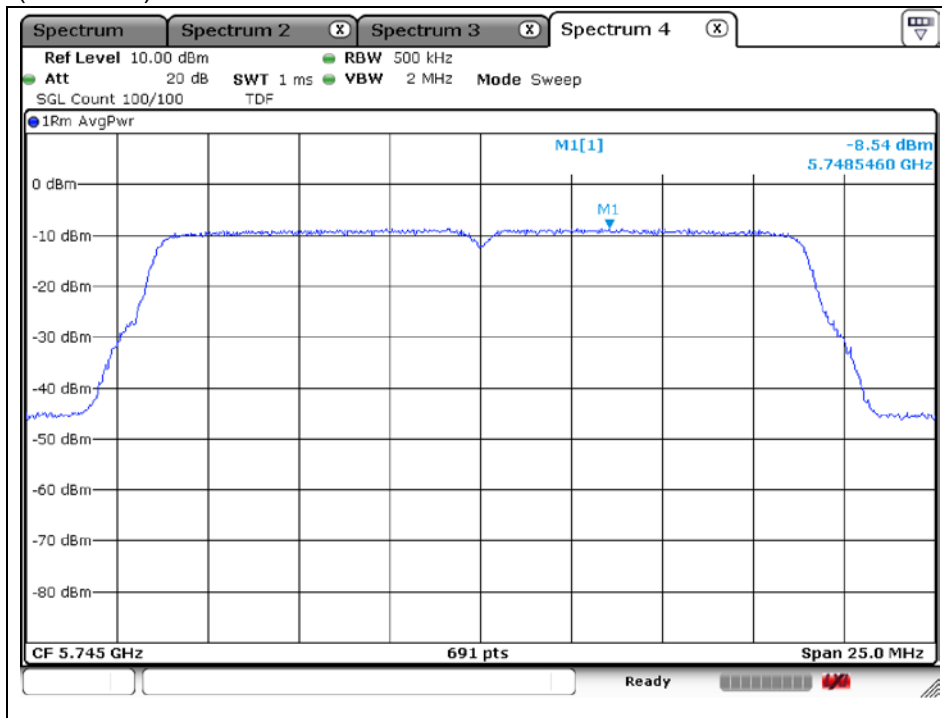

The results shown in this test report refer only to the sample(s) tested unless otherwise stated. This test report cannot be reproduced, except in full, without prior written permission of the Company.

Middle Channel (5 785 MHz)

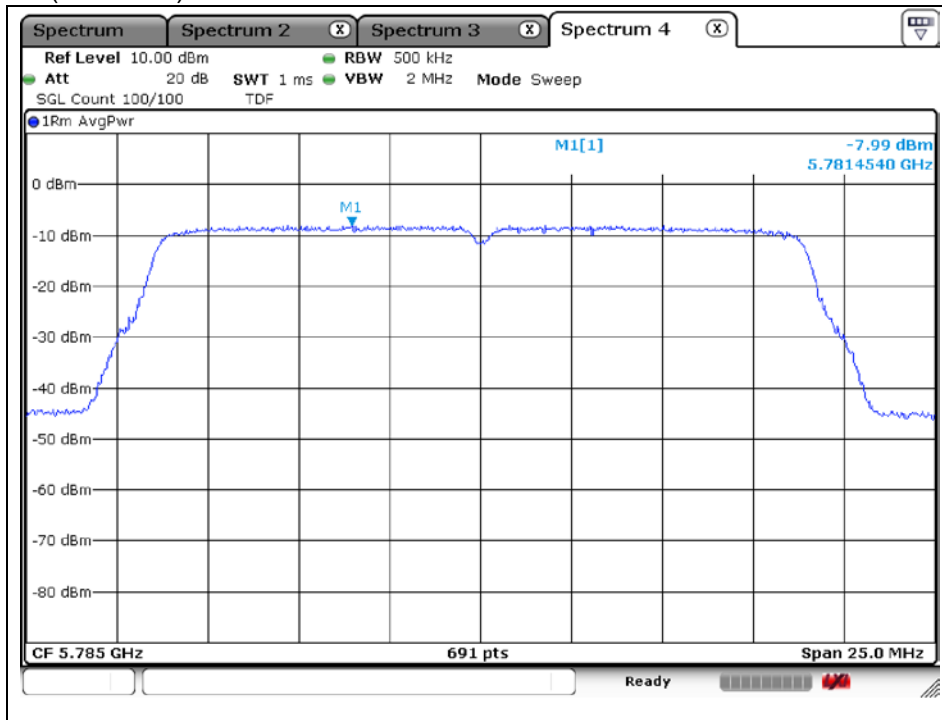

High Channel (5 825 MHz)

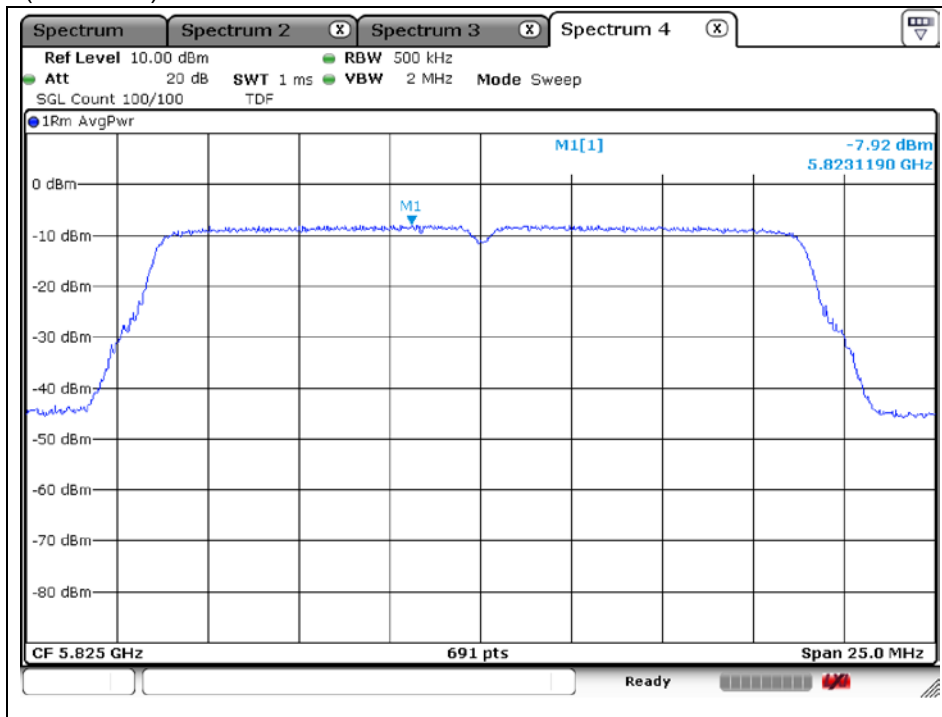

The results shown in this test report refer only to the sample(s) tested unless otherwise stated. This test report cannot be reproduced, except in full, without prior written permission of the Company.



### Band-crossing channels

#### 802.11a (5 720 MHz)

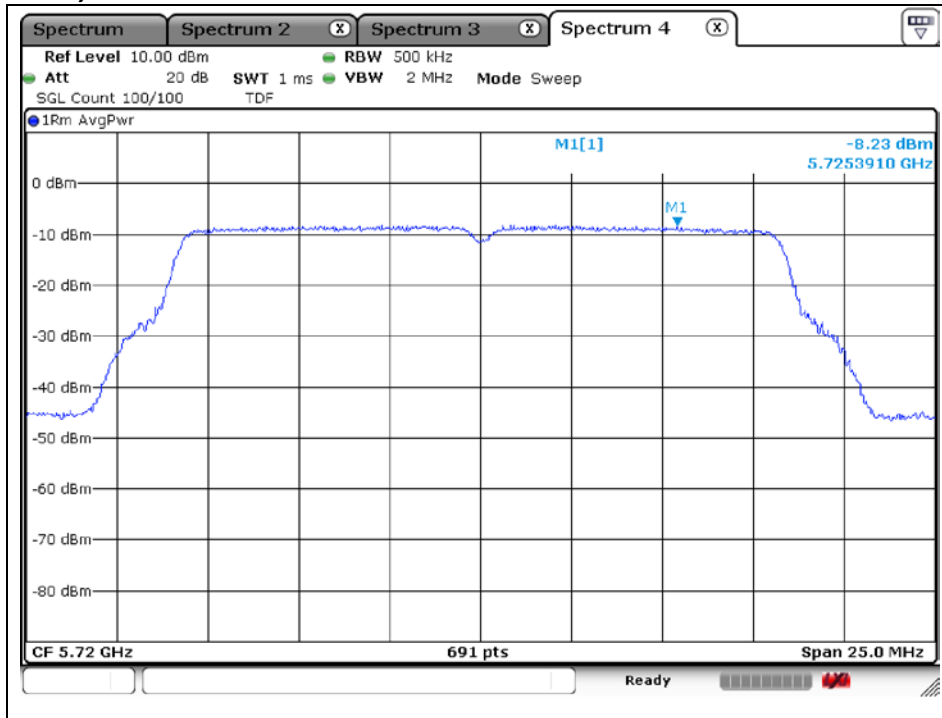

#### 802.11n\_HT20 (5 720 MHz)

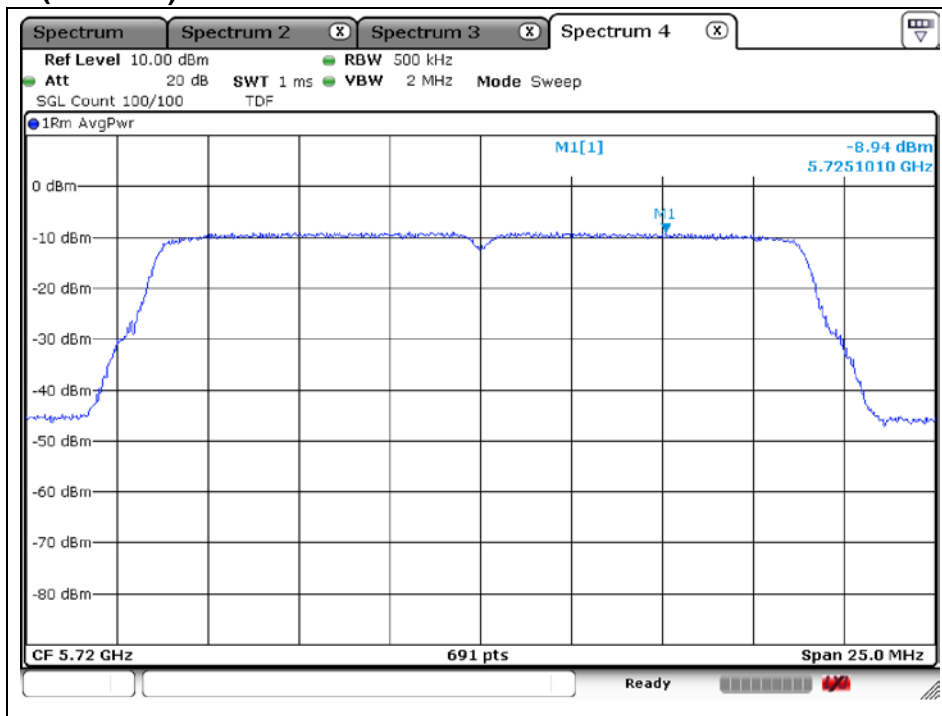

The results shown in this test report refer only to the sample(s) tested unless otherwise stated. This test report cannot be reproduced, except in full, without prior written permission of the Company.

## 7. AC Power Line Conducted Emissions

### 7.1. Test Setup

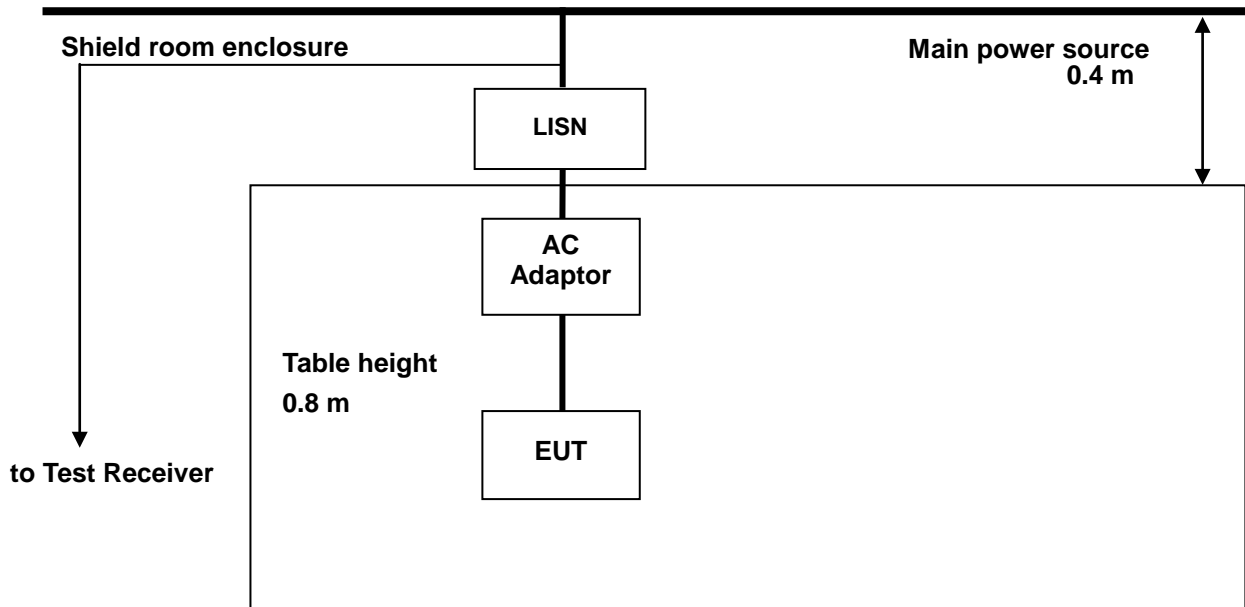

### 7.2. Limit

According to §15.207(a) for an intentional radiator that is designed to be connected to the public utility (AC) power line, the radio frequency voltage that is conducted back onto the AC power line on any frequency or frequencies, within the band 150 kHz to 30 MHz, shall not exceed the limits in the following table, as measured using a 50  $\mu$ H / 50 ohm line impedance stabilization network (LISN).

Compliance with the provision of this paragraph shall be on the measurement of the radio frequency voltage between each power line and ground at the power terminal. The lower value applies at the boundary between the frequency ranges.

Frequency of Emission (MHz)	Conducted limit (dB $\mu$ V)	
	Quasi-peak	Average
0.15 – 0.50	66 - 56*	56 - 46*
0.50 – 5.00	56	46
5.00 – 30.0	60	50

\* Decreases with the logarithm of the frequency.

The results shown in this test report refer only to the sample(s) tested unless otherwise stated. This test report cannot be reproduced, except in full, without prior written permission of the Company.

SGS Korea Co., Ltd. (Gunpo Laboratory) 4, LS-ro 182beon-gil, Gunpo-si, Gyeonggi-do, Korea, 15807 <http://www.sgsgroup.kr>

---

### 7.3. Test Procedures

All data rates and modes were investigated for this test. The full data for the worst case data rate are reported in this section.

AC line conducted emissions from the EUT were measured according to the dictates of ANSI C63.10-2013

1. The test procedure is performed in a 6.5 m × 3.6 m × 3.6 m (L × W × H) shielded room. The EUT along with its peripherals were placed on a 1.0 m (W) × 1.5 m (L) and 0.8 m in height wooden table and the EUT was adjusted to maintain a 0.4 meter space from a vertical reference plane.
2. The EUT was connected to power mains through a line impedance stabilization network (LISN) which provides 50 ohm coupling impedance for measuring instrument and the chassis ground was bounded to the horizontal ground plane of shielded room.
3. The excess power cable between the EUT and the LISN was bundled. All connecting cables of EUT were moved to find the maximum emission.

---

*The results shown in this test report refer only to the sample(s) tested unless otherwise stated. This test report cannot be reproduced, except in full, without prior written permission of the Company.*

**SGS Korea Co., Ltd. (Gunpo Laboratory)** 4, LS-ro 182beon-gil, Gunpo-si, Gyeonggi-do, Korea, 15807 <http://www.sgsgroup.kr>

## 7.4. Test Results

The following table shows the highest levels of conducted emissions on both phase of Hot and Neutral line

Ambient temperature : (23 ± 1) °C  
 Relative humidity : 47 % R.H.  
  
 Frequency range : 0.15 MHz – 30 MHz  
 Measured Bandwidth : 9 kHz

FREQ. (MHz)	LEVEL(dB $\mu$ V)		LINE	LIMIT(dB $\mu$ V)		MARGIN(dB)	
	Q-Peak	Average		Q-Peak	Average	Q-Peak	Average
0.46	42.20	24.60	Neutral	56.69	46.69	14.49	22.09
1.19	26.50	15.70	Neutral	56.00	46.00	29.50	30.30
2.65	29.10	16.30	Neutral	56.00	46.00	26.90	29.70
7.78	29.90	20.60	Neutral	60.00	50.00	30.10	29.40
11.70	30.00	24.40	Neutral	60.00	50.00	30.00	25.60
18.10	29.20	23.50	Neutral	60.00	50.00	30.80	26.50
0.40	43.00	30.60	Hot	57.85	47.85	14.85	17.25
1.26	30.70	16.30	Hot	56.00	46.00	25.30	29.70
3.04	30.70	16.30	Hot	56.00	46.00	25.30	29.70
6.51	22.90	15.00	Hot	60.00	50.00	37.10	35.00
12.02	36.80	31.50	Hot	60.00	50.00	23.20	18.50
23.92	31.20	25.30	Hot	60.00	50.00	28.80	24.70

Remark;

- Line ( H ): Hot, Line ( N ): Neutral
- All channel of operation were investigated and the worst-case emissions were reported using **11a (Band 2A) / 6 Mbps / Low channel**
- Traces shown in plot mad using a peak detector and average detector
- The limit for Class B device(s) from 150 kHz to 30 MHz are specified in Section of the Title 47 CFR.
- Deviations to the Specifications: None.

*The results shown in this test report refer only to the sample(s) tested unless otherwise stated. This test report cannot be reproduced, except in full, without prior written permission of the Company.*

Test mode: (Neutral)

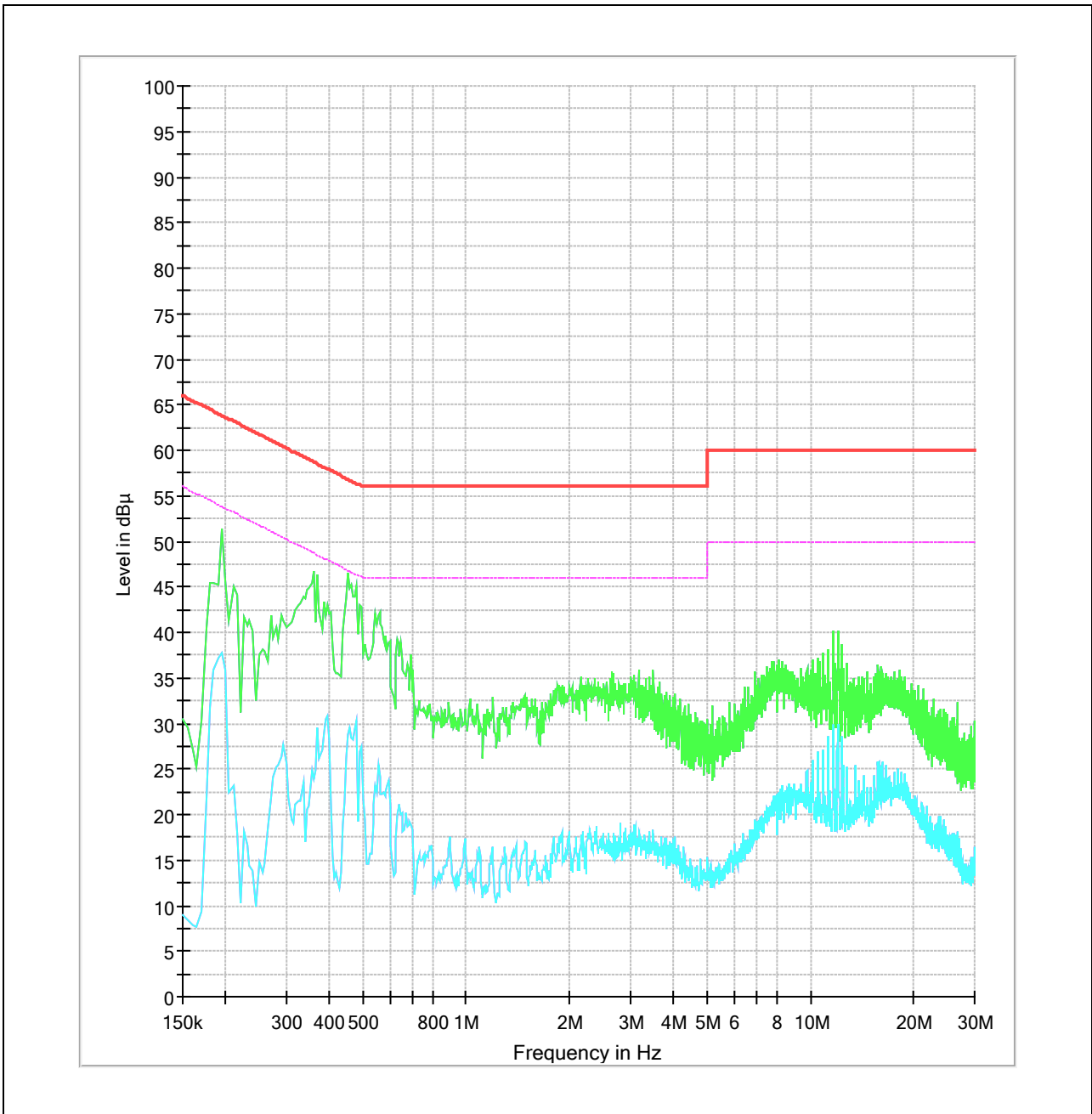

The results shown in this test report refer only to the sample(s) tested unless otherwise stated. This test report cannot be reproduced, except in full, without prior written permission of the Company.

Test mode: (Hot)

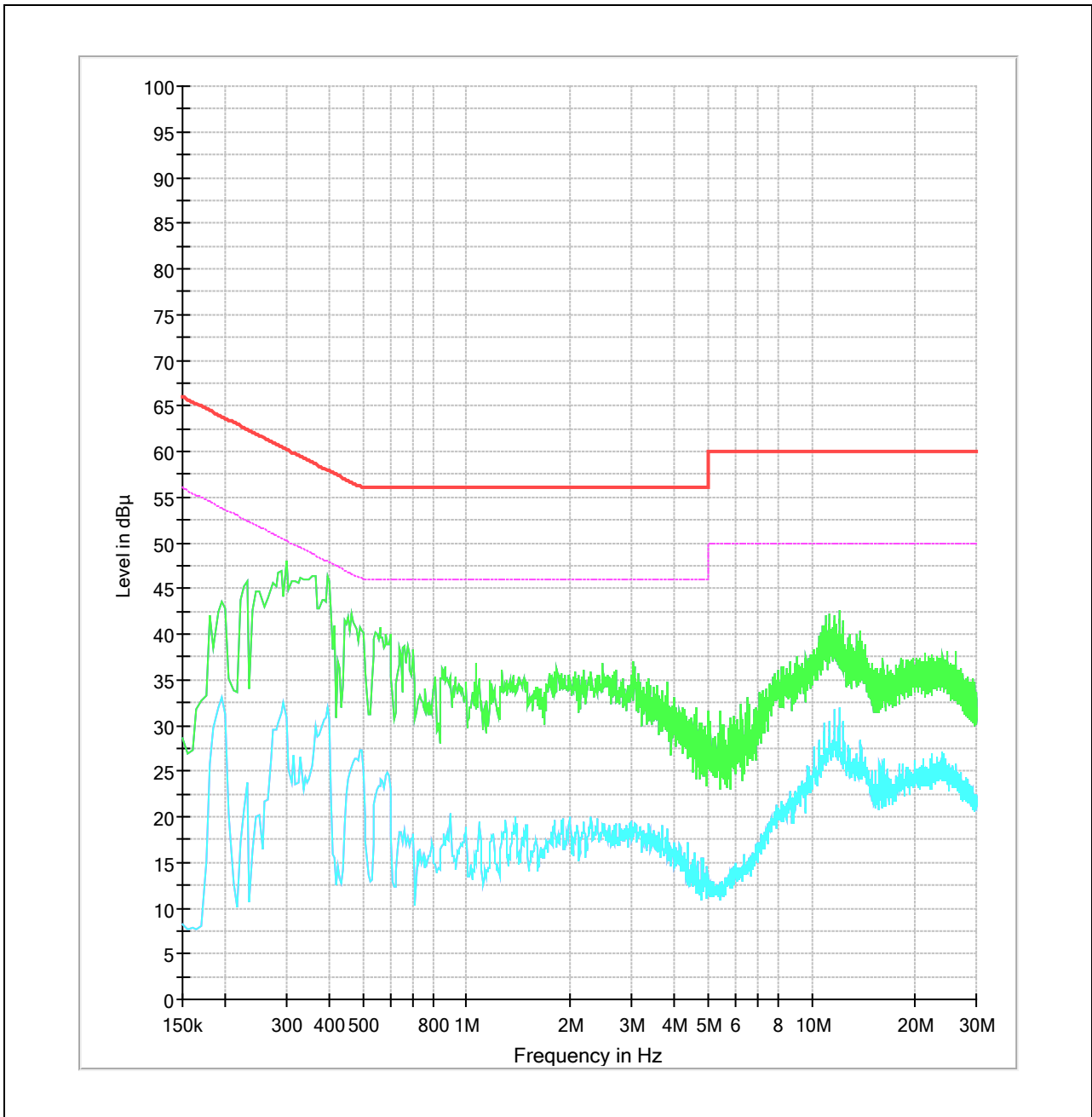

The results shown in this test report refer only to the sample(s) tested unless otherwise stated. This test report cannot be reproduced, except in full, without prior written permission of the Company.

SGS Korea Co., Ltd. (Gunpo Laboratory) 4, LS-ro 182beon-gil, Gunpo-si, Gyeonggi-do, Korea, 15807 <http://www.sgsgroup.kr>

## 8. Antenna Requirement

### 8.1. Standard Applicable

For intentional device, according to FCC 47 CFR Section §15.203, an intentional radiator shall be designed to ensure that no antenna other than that furnished by the responsible party shall be used with the device. And according to FCC 47 CFR Section §15.407 (a) if transmitting antennas of directional gain greater than 6 dB i are used, the power shall be reduced by the amount in dB that the gain of the antenna exceeds 6 dB i.

### 8.2. Antenna Connected Construction

Antenna used in this product is PCB antenna and peak max gain of antenna as below.

<b>Band</b>	5 180 MHz – 5 320 MHz	5 500 MHz – 5 720 MHz	5 745 MHz – 5 825 MHz
<b>Mode</b>	11a/n_HT20		
<b>Gain</b>	3.50 dB i	3.34 dB i	3.01 dB i

*The results shown in this test report refer only to the sample(s) tested unless otherwise stated. This test report cannot be reproduced, except in full, without prior written permission of the Company.*

**SGS Korea Co., Ltd. (Gunpo Laboratory)** 4, LS-ro 182beon-gil, Gunpo-si, Gyeonggi-do, Korea, 15807 <http://www.sgsgroup.kr>