

FCC TEST REPORT

REPORT NO. : RF961018L05

MODEL NO. : MRC (refer to item 3.1 for more details)

RECEIVED : Oct. 17, 2007

TESTED : Oct. 17 ~ Oct. 19, 2007

ISSUED : Oct. 22, 2007

APPLICANT : Acrox Technologies Co., Ltd

ADDRESS : 8F, No. 437, Rui Guang RD., Nei Hu Dist., Taipei
114, Taiwan, R.O.C.

ISSUED BY : Advance Data Technology Corporation

LAB ADDRESS : No. 47, 14th Ling, Chia Pau Tsuen, Lin Kou
Hsiang 244, Taipei Hsien, Taiwan, R.O.C.

TEST LOCATION : No. 19, Hwa Ya 2nd Rd., Wen Hwa Tsuen, Kwei
Shan Hsiang, Taoyuan Hsien 333, Taiwan, R.O.C.

This test report consists of 31 pages in total. It may be duplicated completely for legal use with the approval of the applicant. It should not be reproduced except in full, without the written approval of our laboratory. The client should not use it to claim product endorsement by TAF, A2LA or any government agencies. The test results in the report only apply to the tested sample.



Table of Contents

1.	CERTIFICATION	3
2.	SUMMARY OF TEST RESULTS	4
2.1	MEASUREMENT UNCERTAINTY	4
3.	GENERAL INFORMATION.....	5
3.1	GENERAL DESCRIPTION OF EUT	5
3.2	DESCRIPTION OF TEST MODES.....	6
3.2.1	CONFIGURATION OF SYSTEM UNDER TEST	6
3.2.2	TEST MODE APPLICABILITY AND TESTED CHANNEL DETAIL.....	7
3.3	GENERAL DESCRIPTION OF APPLIED STANDARDS	8
3.4	DESCRIPTION OF SUPPORT UNITS	8
4.	TEST TYPES AND RESULTS	9
4.1	RADIATED EMISSION MEASUREMENT	9
4.1.1	LIMITS OF RADIATED EMISSION MEASUREMENT.....	9
4.1.2	TEST INSTRUMENTS	10
4.1.3	TEST PROCEDURES	11
4.1.4	DEVIATION FROM TEST STANDARD	11
4.1.5	TEST SETUP	12
4.1.6	EUT OPERATING CONDITIONS	12
4.1.7	TEST RESULTS	13
4.2	CONDUCTED EMISSION MEASUREMENT	21
4.2.1	LIMITS OF CONDUCTED EMISSION MEASUREMENT.....	21
4.2.2	TEST INSTRUMENTS	21
4.2.3	TEST PROCEDURES	22
4.2.4	DEVIATION FROM TEST STANDARD	22
4.2.5	TEST SETUP	23
4.2.6	EUT OPERATING CONDITIONS	23
4.2.7	TEST RESULTS	24
4.3	BAND EDGES MEASUREMENT	26
4.3.1	LIMITS OF BAND EDGES MEASUREMENT	26
4.3.2	TEST INSTRUMENTS	26
4.3.3	TEST PROCEDURE	26
4.3.4	DEVIATION FROM TEST STANDARD	26
4.3.5	EUT OPERATING CONDITION	26
4.3.6	TEST RESULTS	26
5.	PHOTOGRAPHS OF THE TEST CONFIGURATION.....	29
6.	INFORMATION ON THE TESTING LABORATORIES	30
7.	APPENDIX A - MODIFICATIONS RECORDERS FOR ENGINEERING CHANGES TO THE EUT BY THE LAB.....	31



1. CERTIFICATION

PRODUCT: Presenter Receiver

MODEL: MRC (refer to item 3.1 for more details)

BRAND: ACROX (refer to item 3.1 for more details)

APPLICANT: Acrox Technologies Co., Ltd

TESTED: Oct. 17 ~ Oct. 19, 2007

TEST SAMPLE: ENGINEERING SAMPLE

STANDARDS: **FCC Part 15, Subpart C (Section 15.249)**

ANSI C63.4-2003

The above equipment (model: MRC) have been tested by **Advance Data Technology Corporation**, and found compliance with the requirement of the above standards. The test record, data evaluation & Equipment Under Test (EUT) configurations represented herein are true and accurate accounts of the measurements of the sample's EMC characteristics under the conditions specified in this report.

PREPARED BY : Rennie Wang , **DATE:** Oct. 22, 2007
Rennie Wang / Senior Specialist

TECHNICAL ACCEPTANCE : Long Chen , **DATE:** Oct. 22, 2007
Responsible for RF Long Chen / Senior Engineer

APPROVED BY : Gary Chang , **DATE:** Oct. 22, 2007
Gary Chang / Assistant Manager

2. SUMMARY OF TEST RESULTS

The EUT has been tested according to the following specifications:

APPLIED STANDARD: FCC Part 15, Subpart C (Section 15.249)			
STANDARD PARAGRAPH	TEST TYPE	RESULT	REMARK
15.207	Conducted Emission Test	PASS	Minimum passing margin is -14.27dB at 0.170MHz
15.209 15.249 15.249 (d)	Radiated Emission Test Band Edge Measurement Limit: 50dB less than the peak value of fundamental frequency or meet radiated emission limit in section 15.209	PASS	Minimum passing margin is -6.60dB at 2399.00MHz

2.1 MEASUREMENT UNCERTAINTY

Where relevant, the following measurement uncertainty levels have been estimated for tests performed on the EUT as specified in CISPR 16-4-2:

MEASUREMENT	FREQUENCY	UNCERTAINTY
Conducted emissions	9kHz~30MHz	2.44 dB
	30MHz ~ 200MHz	3.19 dB
Radiated emissions	200MHz ~1000MHz	3.21 dB
	1GHz ~ 18GHz	2.26 dB
	18GHz ~ 40GHz	1.94 dB

This uncertainty represents an expanded uncertainty expressed at approximately the 95% confidence level using a coverage factor of k=2.

3. GENERAL INFORMATION

3.1 GENERAL DESCRIPTION OF EUT

EUT	Presenter Receiver
MODEL NO.	MRC (refer to NOTE for more details)
FCC ID	PRDPRERECEI001
POWER SUPPLY	5Vdc from host equipment
MODULATION TYPE	FSK
FREQUENCY RANGE	2406 ~ 2478 MHz
NUMBER OF CHANNEL	46
ANTENNA TYPE	Wired antenna
DATA CABLE	NA
I/O PORT	USB
ACCESSORY DEVICE	NA

NOTE:

1. The models as below are identical to each other except for their model and brand name due to marketing requirement.

BRAND NAME	MODEL NAME
ACROX	MRC
TARGUS	AMP08

2. The above EUT information was declared by manufacturer and for more detailed features description, please refer to the manufacturer's specifications or User's Manual.

3.2 DESCRIPTION OF TEST MODES

46 channels are provided to this EUT:

Channel	Freq. (MHz)	Channel	Freq. (MHz)	Channel	Freq. (MHz)
1	2406.00	17	2431.60	33	2457.20
2	2407.60	18	2433.20	34	2458.80
3	2409.20	19	2434.80	35	2460.40
4	2410.80	20	2436.40	36	2462.00
5	2412.40	21	2438.00	37	2463.60
6	2414.00	22	2439.60	38	2465.20
7	2415.60	23	2441.20	39	2466.80
8	2417.20	24	2442.80	40	2468.40
9	2418.80	25	2444.40	41	2470.00
10	2420.40	26	2446.00	42	2471.60
11	2422.00	27	2447.60	43	2473.20
12	2423.60	28	2449.20	44	2474.80
13	2425.20	29	2450.80	45	2476.40
14	2426.80	30	2452.40	46	2478.00
15	2428.40	31	2454.00		
16	2430.00	32	2455.60		

3.2.1 CONFIGURATION OF SYSTEM UNDER TEST

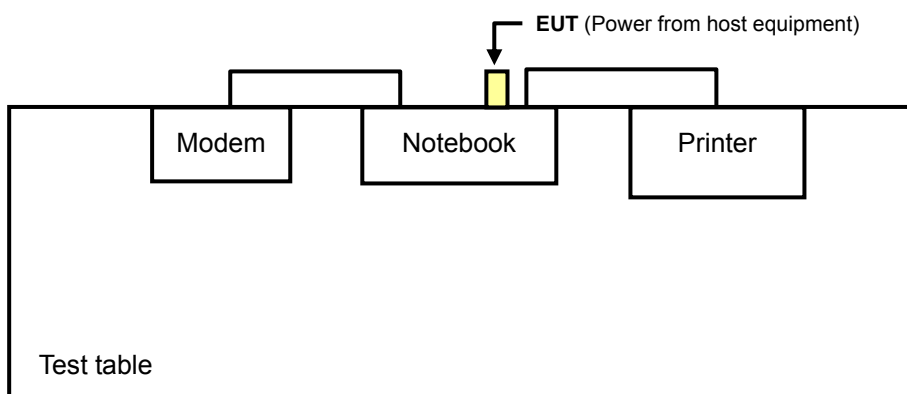

3.2.2 TEST MODE APPLICABILITY AND TESTED CHANNEL DETAIL

EUT CONFIGURE MODE	APPLICABLE TO				DESCRIPTION
	RE \geq 1G	RE<1G	PLC	BM	
-	√	√	√	√	-

Where **PLC**:: Power Line Conducted Emission

RE<1G: Radiated Emission below 1GHz

RE \geq 1G: Radiated Emission above 1GHz

BM: Bandedge Measurement

RADIATED EMISSION TEST (ABOVE 1 GHz):

- Pre-Scan has been conducted to determine the worst-case mode from all possible combinations between available modulations and antenna ports (if EUT with antenna diversity architecture).
- Following channel(s) was (were) selected for the final test as listed below.

AVAILABLE CHANNEL	TESTED CHANNEL	MODULATION TYPE
1 to 46	1, 22, 46	FSK

RADIATED EMISSION TEST (BELOW 1 GHz):

- Pre-Scan has been conducted to determine the worst-case mode from all possible combinations between available modulations and antenna ports (if EUT with antenna diversity architecture).
- Following channel(s) was (were) selected for the final test as listed below.

AVAILABLE CHANNEL	TESTED CHANNEL	MODULATION TYPE
1 to 46	1	FSK

POWER LINE CONDUCTED EMISSION TEST:

- Pre-Scan has been conducted to determine the worst-case mode from all possible combinations between available modulations and antenna ports (if EUT with antenna diversity architecture).
- Following channel(s) was (were) selected for the final test as listed below.

AVAILABLE CHANNEL	TESTED CHANNEL	MODULATION TYPE
1 to 46	1	FSK

BANDEDGE MEASUREMENT:

- Pre-Scan has been conducted to determine the worst-case mode from all possible combinations between available modulations and antenna ports (if EUT with antenna diversity architecture).
- Following channel(s) was (were) selected for the final test as listed below.

AVAILABLE CHANNEL	TESTED CHANNEL	MODULATION TYPE
1 to 46	1, 46	FSK



3.3 GENERAL DESCRIPTION OF APPLIED STANDARDS

The EUT is a RF Product. According to the specifications of the manufacturer, it must comply with the requirements of the following standards:

FCC Part 15, Subpart C (Section 15.249)

ANSI C63.4-2003

All test items have been performed and recorded as per the above standards.

NOTE: The EUT is also considered as a kind of computer peripheral, because the connection to computer is necessary for typical use. It has been verified to comply with the requirements of FCC Part 15, Subpart B, Class B (DoC). The test report has been issued separately.

3.4 DESCRIPTION OF SUPPORT UNITS

The EUT has been tested as an independent unit together with other necessary accessories or support units. The following support units or accessories were used to form a representative test configuration during the tests.

NO.	PRODUCT	BRAND	MODEL NO.	SERIAL NO.	FCC ID
1	NOTEBOOK COMPUTER	DELL	PP05L	9954115984	E2K24CLNS
2	PRINTER	EPSON	LQ-300+	DCGY047265	FCC DoC Approved
3	MODEM	ACEEX	1414V/3	0401008248	IFAXDM1414

NO.	SIGNAL CABLE DESCRIPTION OF THE ABOVE SUPPORT UNITS
1	NA
2	1.8m braid shielded wire , DB25 connector , w/o core.
3	1.2m braid shielded wire , DB25 & DB9 connector , w/o core.

NOTE: All power cords of the above support units are non shielded (1.8m).

4. TEST TYPES AND RESULTS

4.1 RADIATED EMISSION MEASUREMENT

4.1.1 LIMITS OF RADIATED EMISSION MEASUREMENT

Emissions radiated outside of the specified bands, shall be according to the general radiated limits in 15.209, 15.249 as following:

15.209 Limit		
Frequencies (MHz)	Field strength (microvolts/meter)	Measurement distance (meters)
0.009 ~ 0.490	2400/F(kHz)	300
0.490 ~ 1.705	24000/F(kHz)	30
1.705 ~ 30.0	30	30
30 ~ 88	100	3
88 ~ 216	150	3
216 ~ 960	200	3
Above 960	500	3
15.249 Limit		
Fundamental Frequency	Field Strength of Fundamental (millivolts/meter)	Field Strength of Harmonics (microvolts/meter)
902 ~ 928 MHz	50	500
2400 ~ 2483.5 MHz	50	500
5725 ~ 5875 MHz	50	500
24 ~ 24.25 GHz	250	2500

NOTE:

1. The lower limit shall apply at the transition frequencies.
2. Emission level (dBuV/m) = 20 log Emission level (uV/m).
3. As shown in 15.35(b), for frequencies above 1000MHz, the field strength limits are based on average detector, however, the peak field strength of any emission shall not exceed the maximum permitted average limits, specified above by more than 20dB under any condition of modulation.



4.1.2 TEST INSTRUMENTS

DESCRIPTION & MANUFACTURER	MODEL NO.	SERIAL NO.	CALIBRATED UNTIL
Test Receiver ROHDE & SCHWARZ	ESI7	838496/016	Dec. 29, 2007
Spectrum Analyzer ROHDE & SCHWARZ	FSP40	100039	Dec. 01, 2007
BILOG Antenna SCHWARZBECK	VULB9168	9168-155	Jan. 04, 2008
HORN Antenna SCHWARZBECK	BBHA 9120D	9120D-405	Dec. 18, 2007
HORN Antenna SCHWARZBECK	BBHA 9170	BBHA9170242	Jan. 16, 2008
Preamplifier Agilent	8449B	3008A1960	Oct. 30, 2007
Preamplifier Agilent	8447D	2944A10631	Oct. 30, 2007
RF signal cable HUBER+SUHNNER	SUCOFLEX 104	230128/4	Nov. 14, 2007
RF signal cable HUBER+SUHNNER	SUCOFLEX 104	233233/4	Nov. 14, 2007
Software ADT.	ADT_Radiated_V7.6	NA	NA
Antenna Tower inn-co GmbH	MA 4000	010303	NA
Antenna Tower Controller inn-co GmbH	CO2000	019303	NA
Turn Table ADT.	TT100.	TT93021704	NA
Turn Table Controller ADT.	SC100.	SC93021704	NA

- NOTE:**
1. The calibration interval of the above test instruments is 12 months and the calibrations are traceable to NML/ROC and NIST/USA.
 2. The test was performed in HwaYa Chamber 4.
 3. The horn antenna and HP preamplifier (model: 8449B) are used only for the measurement of emission frequency above 1GHz if tested.
 4. The IC Site Registration No. is IC3789B-4.

4.1.3 TEST PROCEDURES

- a. The EUT was placed on the top of a rotating table 0.8 meters above the ground at a 3 meter semi-anechoic chamber. The table was rotated 360 degrees to determine the position of the highest radiation.
- b. The EUT was set 3 meters away from the interference-receiving antenna, which was mounted on the top of a variable-height antenna tower.
- c. The antenna is a broadband antenna, and its height is varied from one meter to four meters above the ground to determine the maximum value of the field strength. Both horizontal and vertical polarizations of the antenna are set to make the measurement.
- d. For each suspected emission, the EUT was arranged to its worst case and then the antenna was tuned to heights from 1 meter to 4 meters and the rotatable table was turned from 0 degrees to 360 degrees to find the maximum reading.
- e. The test-receiver system was set to Peak Detect Function and Specified Bandwidth with Maximum Hold Mode.
- f. If the emission level of the EUT in peak mode was lower than the limit specified, then testing could be stopped and the peak values of the EUT would be reported. Otherwise the emissions would be re-tested one by one using peak, quasi-peak or average method as specified and then reported in a data sheet.

NOTE:

1. The resolution bandwidth and video bandwidth of test receiver/spectrum analyzer is 120kHz for Quasi-peak detection at frequency below 1GHz.
2. The resolution bandwidth of test receiver/spectrum analyzer is 1 MHz and video bandwidth is 3MHz for Peak detection at frequency above 1GHz.
3. All modes of operation were investigated and the worst-case emissions are reported.

4.1.4 DEVIATION FROM TEST STANDARD

No deviation.

4.1.5 TEST SETUP

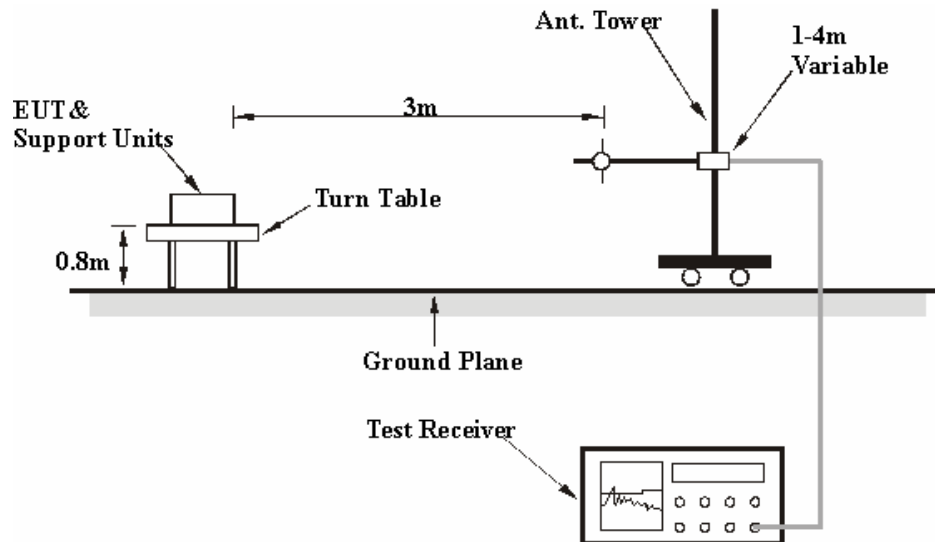

For the actual test configuration, please refer to the attached file (Test Setup Photo).

4.1.6 EUT OPERATING CONDITIONS

Set the EUT under transmission condition continuously at specific channel frequency.

4.1.7 TEST RESULTS

ABOVE 1GHz WORST-CASE DATA

EUT TEST CONDITION		MEASUREMENT DETAIL	
CHANNEL	Channel 1	FREQUENCY RANGE	1 ~ 25GHz
MODULATION TYPE	FSK	DETECTOR FUNCTION	Peak (PK) Average (AV)
ENVIRONMENTAL CONDITIONS	25deg. C, 65%RH, 991hPa	TESTED BY	Brad Wu

ANTENNA POLARITY & TEST DISTANCE: HORIZONTAL AT 3 m								
No.	Freq. (MHz)	Emission Level (dBuV/m)	Limit (dBuV/m)	Margin (dB)	Antenna Height (m)	Table Angle (Degree)	Raw Value (dBuV)	Correction Factor (dB/m)
1	2390.00	62.36 PK	74.00	-11.64	1.44 H	22	30.12	32.24
2	2390.00	44.44 AV	54.00	-9.56	1.44 H	22	12.20	32.24
3	2399.00	67.40 PK	74.00	-6.60	1.44 H	22	35.12	32.28
4	2399.00	44.68 AV	54.00	-9.32	1.44 H	22	12.40	32.28
5	*2406.00	98.61 PK	114.00	-15.39	1.44 H	22	66.31	32.30
6	*2406.00	73.76 AV	94.00	-20.24	1.44 H	22	41.46	32.30
7	4812.00	53.96 PK	74.00	-20.04	1.00 H	178	15.87	38.09
8	4812.00	29.11 AV	54.00	-24.89	1.00 H	178	-8.98	38.09

- REMARKS:**
1. Emission level (dBuV/m) = Raw Value (dBuV) + Correction Factor (dB/m).
 2. Correction Factor (dB/m) = Antenna Factor (dB/m) + Cable Factor (dB).
 3. The other emission levels were very low against the limit.
 4. Margin value = Emission level – Limit value.
 5. “ * ” : Fundamental frequency
 6. The average value of fundamental frequency is: Average = Peak value + 20log(Duty cycle) Where the duty factor is calculated from following formula:

$$20\log(\text{Duty cycle}) = 20\log \frac{5.72 \text{ ms}}{100 \text{ ms}} = -24.85\text{dB}$$

Please see page 19 for plotted duty



EUT TEST CONDITION		MEASUREMENT DETAIL	
CHANNEL	Channel 1	FREQUENCY RANGE	1 ~ 25GHz
MODULATION TYPE	FSK	DETECTOR FUNCTION	Peak (PK) Average (AV)
ENVIRONMENTAL CONDITIONS	25deg. C, 65%RH, 991hPa	TESTED BY	Brad Wu

ANTENNA POLARITY & TEST DISTANCE: VERTICAL AT 3 m								
No.	Freq. (MHz)	Emission Level (dBuV/m)	Limit (dBuV/m)	Margin (dB)	Antenna Height (m)	Table Angle (Degree)	Raw Value (dBuV)	Correction Factor (dB/m)
1	2390.00	60.14 PK	74.00	-13.86	1.23 V	352	27.90	32.24
2	2390.00	44.47 AV	54.00	-9.53	1.23 V	352	12.23	32.24
3	2399.00	66.78 PK	74.00	-7.22	1.23 V	351	34.50	32.28
4	2399.00	44.51 AV	54.00	-9.49	1.23 V	351	12.23	32.28
5	*2406.00	96.55 PK	114.00	-17.45	1.23 V	351	64.25	32.30
6	*2406.00	71.70 AV	94.00	-22.30	1.23 V	351	39.40	32.30
7	4812.00	55.35 PK	74.00	-18.65	1.00 V	202	17.26	38.09
8	4812.00	30.50 AV	54.00	-23.50	1.00 V	202	-7.59	38.09

- REMARKS:**
1. Emission level (dBuV/m) = Raw Value (dBuV) + Correction Factor (dB/m).
 2. Correction Factor (dB/m) = Antenna Factor (dB/m) + Cable Factor (dB).
 3. The other emission levels were very low against the limit.
 4. Margin value = Emission level – Limit value.
 5. “ * ” : Fundamental frequency
 6. The average value of fundamental frequency is: Average = Peak value + 20log(Duty cycle) Where the duty factor is calculated from following formula:

$$20\log(\text{Duty cycle}) = 20\log \frac{5.72 \text{ ms}}{100 \text{ ms}} = -24.85\text{dB}$$

Please see page 19 for plotted duty



EUT TEST CONDITION		MEASUREMENT DETAIL	
CHANNEL	Channel 22	FREQUENCY RANGE	1 ~ 25GHz
MODULATION TYPE	FSK	DETECTOR FUNCTION	Peak (PK) Average (AV)
ENVIRONMENTAL CONDITIONS	25deg. C, 65%RH, 991hPa	TESTED BY	Brad Wu

ANTENNA POLARITY & TEST DISTANCE: HORIZONTAL AT 3 m								
No.	Freq. (MHz)	Emission Level (dBuV/m)	Limit (dBuV/m)	Margin (dB)	Antenna Height (m)	Table Angle (Degree)	Raw Value (dBuV)	Correction Factor (dB/m)
1	*2439.00	98.37 PK	114.00	-15.63	1.38 H	24	65.96	32.41
2	*2439.00	73.52 AV	94.00	-20.48	1.38 H	24	41.11	32.41
3	4878.00	54.12 PK	74.00	-19.88	1.38 H	24	15.78	38.34
4	4878.00	29.27 AV	54.00	-24.73	1.38 H	24	-9.07	38.34

- REMARKS:**
1. Emission level (dBuV/m) = Raw Value (dBuV) + Correction Factor (dB/m).
 2. Correction Factor (dB/m) = Antenna Factor (dB/m) + Cable Factor (dB).
 3. The other emission levels were very low against the limit.
 4. Margin value = Emission level – Limit value.
 5. “ * ” : Fundamental frequency
 6. The average value of fundamental frequency is: Average = Peak value + 20log(Duty cycle) Where the duty factor is calculated from following formula:

$$20\log(\text{Duty cycle}) = 20\log \frac{5.72 \text{ ms}}{100 \text{ ms}} = -24.85\text{dB}$$

Please see page 19 for plotted duty



EUT TEST CONDITION		MEASUREMENT DETAIL	
CHANNEL	Channel 22	FREQUENCY RANGE	1 ~ 25GHz
MODULATION TYPE	FSK	DETECTOR FUNCTION	Peak (PK) Average (AV)
ENVIRONMENTAL CONDITIONS	25deg. C, 65%RH, 991hPa	TESTED BY	Brad Wu

ANTENNA POLARITY & TEST DISTANCE: VERTICAL AT 3 m								
No.	Freq. (MHz)	Emission Level (dBuV/m)	Limit (dBuV/m)	Margin (dB)	Antenna Height (m)	Table Angle (Degree)	Raw Value (dBuV)	Correction Factor (dB/m)
1	*2439.00	96.23 PK	114.00	-17.77	1.23 V	350	63.82	32.41
2	*2439.00	71.38 AV	94.00	-22.62	1.23 V	350	38.97	32.41
3	4874.00	55.21 PK	74.00	-18.79	1.02 V	243	16.89	38.32
4	4874.00	30.36 AV	54.00	-23.64	1.02 V	243	-7.96	38.32

- REMARKS:**
1. Emission level (dBuV/m) = Raw Value (dBuV) + Correction Factor (dB/m).
 2. Correction Factor (dB/m) = Antenna Factor (dB/m) + Cable Factor (dB).
 3. The other emission levels were very low against the limit.
 4. Margin value = Emission level – Limit value.
 5. “ * “ : Fundamental frequency
 6. The average value of fundamental frequency is: Average = Peak value + 20log(Duty cycle) Where the duty factor is calculated from following formula:

$$20\log(\text{Duty cycle}) = 20\log \frac{5.72 \text{ ms}}{100 \text{ ms}} = -24.85\text{dB}$$

Please see page 19 for plotted duty



EUT TEST CONDITION		MEASUREMENT DETAIL	
CHANNEL	Channel 46	FREQUENCY RANGE	1 ~ 25GHz
MODULATION TYPE	FSK	DETECTOR FUNCTION	Peak (PK) Average (AV)
ENVIRONMENTAL CONDITIONS	25deg. C, 65%RH, 991hPa	TESTED BY	Brad Wu

ANTENNA POLARITY & TEST DISTANCE: HORIZONTAL AT 3 m								
No.	Freq. (MHz)	Emission Level (dBuV/m)	Limit (dBuV/m)	Margin (dB)	Antenna Height (m)	Table Angle (Degree)	Raw Value (dBuV)	Correction Factor (dB/m)
1	*2478.00	98.67 PK	114.00	-15.33	1.41 H	23	66.13	32.54
2	*2478.00	73.82 AV	94.00	-20.18	1.41 H	23	41.28	32.54
3	2483.50	66.78 PK	74.00	-7.22	1.41 H	23	34.22	32.56
4	2483.50	43.82 AV	54.00	-10.18	1.41 H	23	11.26	32.56
5	4956.00	54.22 PK	74.00	-19.78	1.01 H	56	15.71	38.51
6	4956.00	29.37 AV	54.00	-24.63	1.01 H	56	-9.14	38.51

- REMARKS:**
1. Emission level (dBuV/m) = Raw Value (dBuV) + Correction Factor (dB/m).
 2. Correction Factor (dB/m) = Antenna Factor (dB/m) + Cable Factor (dB).
 3. The other emission levels were very low against the limit.
 4. Margin value = Emission level – Limit value.
 5. “ * “ : Fundamental frequency
 6. The average value of fundamental frequency is: Average = Peak value + 20log(Duty cycle) Where the duty factor is calculated from following formula:

$$20\log(\text{Duty cycle}) = 20\log \frac{5.72 \text{ ms}}{100 \text{ ms}} = -24.85\text{dB}$$

Please see page 19 for plotted duty



EUT TEST CONDITION		MEASUREMENT DETAIL	
CHANNEL	Channel 46	FREQUENCY RANGE	1 ~ 25GHz
MODULATION TYPE	FSK	DETECTOR FUNCTION	Peak (PK) Average (AV)
ENVIRONMENTAL CONDITIONS	25deg. C, 65%RH, 991hPa	TESTED BY	Brad Wu

ANTENNA POLARITY & TEST DISTANCE: VERTICAL AT 3 m								
No.	Freq. (MHz)	Emission Level (dBuV/m)	Limit (dBuV/m)	Margin (dB)	Antenna Height (m)	Table Angle (Degree)	Raw Value (dBuV)	Correction Factor (dB/m)
1	*2478.00	96.25 PK	114.00	-17.75	1.22 V	350	63.71	32.54
2	*2478.00	71.40 AV	94.00	-22.60	1.22 V	350	38.86	32.54
3	2483.50	64.89 PK	74.00	-9.11	1.22 V	350	32.33	32.56
4	2483.50	42.86 AV	54.00	-11.14	1.22 V	350	10.30	32.56
5	4956.00	55.16 PK	74.00	-18.84	1.03 V	346	16.65	38.51
6	4956.00	30.31 AV	54.00	-23.69	1.03 V	346	-8.20	38.51

- REMARKS:**
1. Emission level (dBuV/m) = Raw Value (dBuV) + Correction Factor (dB/m).
 2. Correction Factor (dB/m) = Antenna Factor (dB/m) + Cable Factor (dB).
 3. The other emission levels were very low against the limit.
 4. Margin value = Emission level – Limit value.
 5. “ * “ : Fundamental frequency
 6. The average value of fundamental frequency is: Average = Peak value + 20log(Duty cycle) Where the duty factor is calculated from following formula:

$$20\log(\text{Duty cycle}) = 20\log \frac{5.72 \text{ ms}}{100 \text{ ms}} = -24.85\text{dB}$$

Please see page 19 for plotted duty

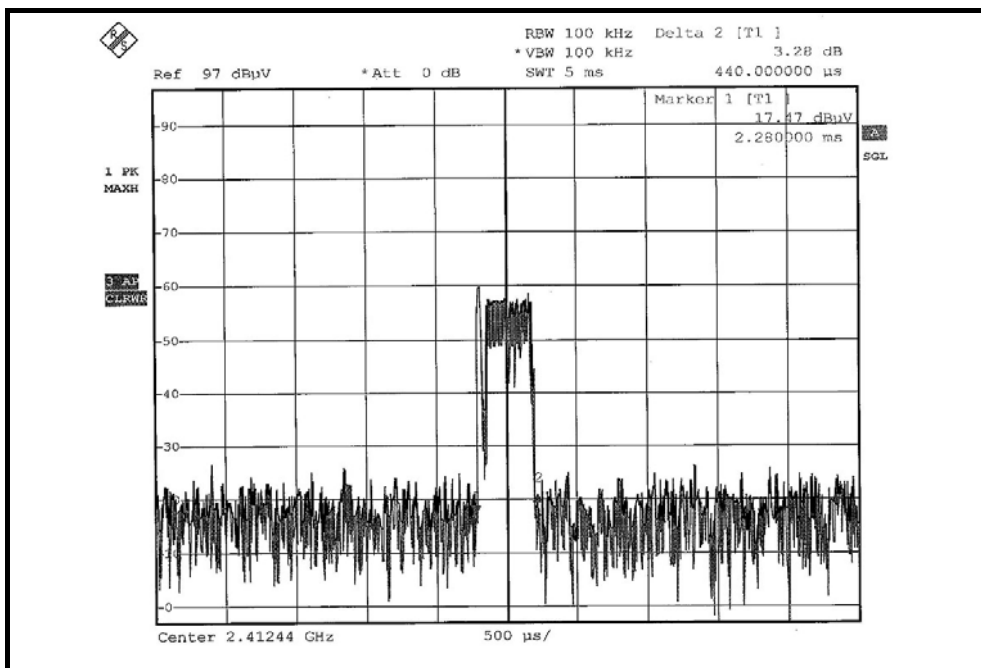
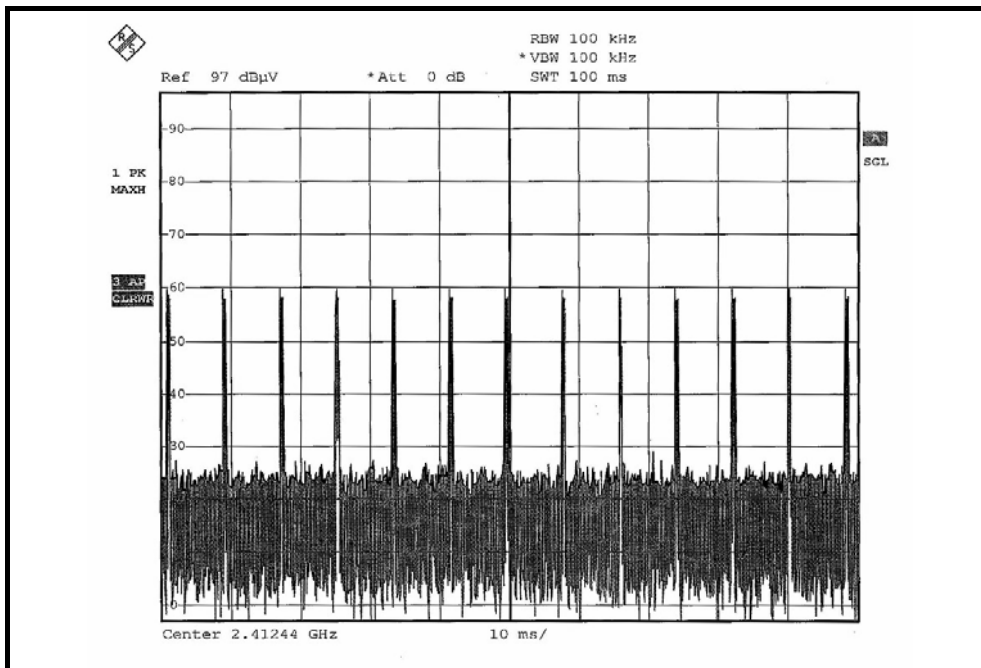

$$20\log(\text{Duty cycle}) = 20\log \frac{0.44 \cdot 13 \text{ ms}}{100 \text{ ms}} = -24.85\text{dB}$$



RADIATED WORST-CASE DATA: BELOW 1GHz

EUT TEST CONDITION		MEASUREMENT DETAIL	
CHANNEL	Channel 1	FREQUENCY RANGE	Below 1000MHz
MODULATION TYPE	FSK	DETECTOR FUNCTION	Quasi-Peak
ENVIRONMENTAL CONDITIONS	25deg. C, 65%RH, 991hPa	TESTED BY	Brad Wu

ANTENNA POLARITY & TEST DISTANCE: HORIZONTAL AT 3 M								
No.	Freq. (MHz)	Emission Level (dBuV/m)	Limit (dBuV/m)	Margin (dB)	Antenna Height (m)	Table Angle (Degree)	Raw Value (dBuV)	Correction Factor (dB/m)
1	105.73	24.90 QP	43.50	-18.60	1.50 H	241	14.01	10.89
2	179.61	27.33 QP	43.50	-16.17	2.00 H	304	14.30	13.03
3	465.42	31.89 QP	46.00	-14.11	2.00 H	190	12.22	19.67
4	603.47	33.65 QP	46.00	-12.35	1.50 H	34	11.11	22.54
5	733.73	32.55 QP	46.00	-13.45	2.00 H	277	7.38	25.18
6	864.00	36.60 QP	46.00	-9.40	2.00 H	286	9.46	27.14

ANTENNA POLARITY & TEST DISTANCE: VERTICAL AT 3 M								
No.	Freq. (MHz)	Emission Level (dBuV/m)	Limit (dBuV/m)	Margin (dB)	Antenna Height (m)	Table Angle (Degree)	Raw Value (dBuV)	Correction Factor (dB/m)
1	148.50	27.95 QP	43.50	-15.55	1.00 V	211	13.88	14.07
2	463.48	31.80 QP	46.00	-14.20	1.00 V	280	12.16	19.64
3	663.74	30.93 QP	46.00	-15.07	1.50 V	274	7.17	23.76
4	733.73	32.94 QP	46.00	-13.06	1.50 V	304	7.76	25.18
5	862.06	36.26 QP	46.00	-9.74	1.50 V	22	9.15	27.11
6	933.99	36.81 QP	46.00	-9.19	1.00 V	217	8.73	28.09

- REMARKS:**
1. Emission level(dBuV/m)=Raw Value(dBuV) + Correction Factor(dB/m)
 2. Correction Factor(dB/m) = Antenna Factor (dB/m) + Cable Factor (dB)
 3. The other emission levels were very low against the limit.
 4. Margin value = Emission level – Limit value.

4.2 CONDUCTED EMISSION MEASUREMENT

4.2.1 LIMITS OF CONDUCTED EMISSION MEASUREMENT

FREQUENCY OF EMISSION (MHz)	CONDUCTED LIMIT (dB μ V)	
	Quasi-peak	Average
0.15 ~ 0.5	66 to 56	56 to 46
0.5 ~ 5	56	46
5 ~ 30	60	50

- NOTE:**
1. The lower limit shall apply at the transition frequencies.
 2. The limit decreases in line with the logarithm of the frequency in the range of 0.15 to 0.50 MHz.
 3. All emanations from a class A/B digital device or system, including any network of conductors and apparatus connected thereto, shall not exceed the level of field strengths specified above.

4.2.2 TEST INSTRUMENTS

DESCRIPTION & MANUFACTURER	MODEL NO.	SERIAL NO.	CALIBRATED UNTIL
Test Receiver ROHDE & SCHWARZ	ESCS30	100289	Dec. 08, 2007
RF signal cable Woken	5D-FB	Cable-HYCO3-01	Jan. 06, 2008
LISN ROHDE & SCHWARZ	ESH2-Z5	100100	Jan. 08, 2008
LISN ROHDE & SCHWARZ	ESH3-Z5	100311	Jan. 16, 2008
Software ADT	ADT_Cond_V3	NA	NA

- NOTE:**
1. The calibration interval of the above test instruments is 12 months and the calibrations are traceable to NML/ROC and NIST/USA.
 2. The test was performed in HwaYa Shielded Room 2.
 3. The VCCI Site Registration No. is C-2047.

4.2.3 TEST PROCEDURES

- a. The EUT was placed 0.4 meters from the conducting wall of the shielded room with EUT being connected to the power mains through a line impedance stabilization network (LISN). Other support units were connected to the power mains through another LISN. The two LISNs provide 50 ohm/ 50uH of coupling impedance for the measuring instrument.
- b. Both lines of the power mains connected to the EUT were checked for maximum conducted interference.
- c. The frequency range from 150kHz to 30MHz was searched. Emission levels under (Limit - 20dB) was not recorded.

NOTE: All modes of operation were investigated and the worst-case emissions are reported.

4.2.4 DEVIATION FROM TEST STANDARD

No deviation.

4.2.5 TEST SETUP

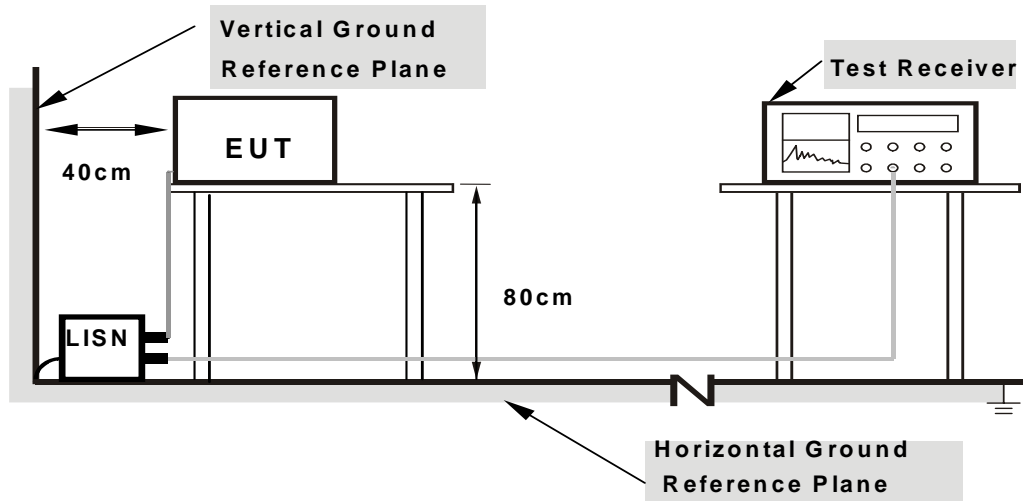

- Note:**
1. Support units were connected to second LISN.
 2. Both of LISNs (AMN) are 80 cm from EUT and at least 80 cm from other units and other metal planes

For the actual test configuration, please refer to the attached file (Test Setup Photo).

4.2.6 EUT OPERATING CONDITIONS

Same as 4.1.6

4.2.7 TEST RESULTS

CONDUCTED WORST-CASE DATA

EUT TEST CONDITION		MEASUREMENT DETAIL	
CHANNEL	Channel 1	PHASE	Line 1
MODULATION TYPE	FSK	6dB BANDWIDTH	9 kHz
		ENVIRONMENTAL CONDITIONS	20deg. C, 60%RH, 981hPa
TESTED BY	Match Tsui	INPUT POWER (SYSTEM)	120Vac, 60 Hz

No	Freq. [MHz]	Corr. Factor (dB)	Reading Value [dB (uV)]		Emission Level [dB (uV)]		Limit [dB (uV)]		Margin (dB)	
			Q.P.	AV.	Q.P.	AV.	Q.P.	AV.	Q.P.	AV.
			1	0.170	0.10	50.61	-	50.71	-	64.98
2	0.228	0.10	42.31	-	42.41	-	62.52	52.52	-20.11	-
3	0.396	0.10	35.07	-	35.17	-	57.93	47.93	-22.76	-
4	2.091	0.22	33.01	-	33.23	-	56.00	46.00	-22.77	-
5	3.902	0.28	37.72	-	38.00	-	56.00	46.00	-18.00	-
6	9.836	0.33	27.19	-	27.52	-	60.00	50.00	-32.48	-

- REMARKS:**
1. Q.P. and AV. are abbreviations of quasi-peak and average individually.
 2. "-": The Quasi-peak reading value also meets average limit and measurement with the average detector is unnecessary.
 3. The emission levels of other frequencies were very low against the limit.
 4. Margin value = Emission level - Limit value
 5. Correction factor = Insertion loss + Cable loss
 6. Emission Level = Correction Factor + Reading Value.

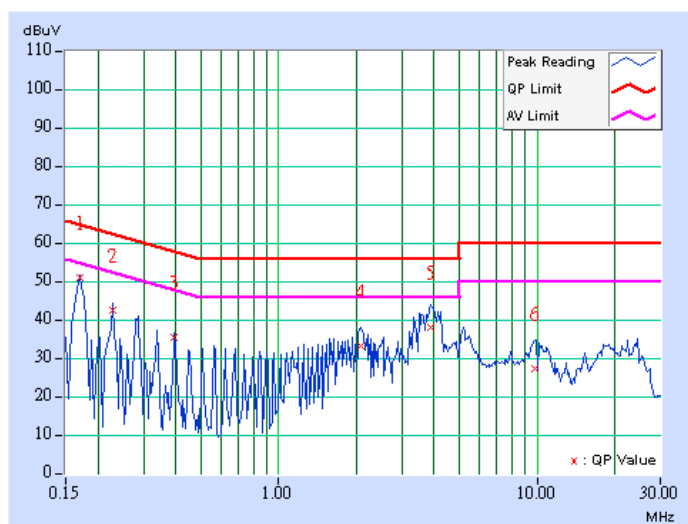

EUT TEST CONDITION		MEASUREMENT DETAIL	
CHANNEL	Channel 1	PHASE	Line 2
MODULATION TYPE	FSK	6dB BANDWIDTH	9 kHz
		ENVIRONMENTAL CONDITIONS	20deg. C, 60%RH, 981hPa
TESTED BY	Match Tsui	INPUT POWER (SYSTEM)	120Vac, 60 Hz

No	Freq. [MHz]	Corr.	Reading Value		Emission Level		Limit		Margin	
		Factor	[dB (uV)]		[dB (uV)]		[dB (uV)]		(dB)	
		(dB)	Q.P.	AV.	Q.P.	AV.	Q.P.	AV.	Q.P.	AV.
1	0.170	0.10	50.35	-	50.45	-	64.98	54.98	-14.53	-
2	0.228	0.10	42.53	-	42.63	-	62.52	52.52	-19.89	-
3	0.338	0.10	35.11	-	35.21	-	59.26	49.26	-24.05	-
4	1.926	0.22	34.45	-	34.67	-	56.00	46.00	-21.33	-
5	3.957	0.28	38.74	-	39.02	-	56.00	46.00	-16.98	-
6	10.465	0.43	32.47	-	32.90	-	60.00	50.00	-27.10	-

- REMARKS:**
1. Q.P. and AV. are abbreviations of quasi-peak and average individually.
 2. "-": The Quasi-peak reading value also meets average limit and measurement with the average detector is unnecessary.
 3. The emission levels of other frequencies were very low against the limit.
 4. Margin value = Emission level - Limit value
 5. Correction factor = Insertion loss + Cable loss
 6. Emission Level = Correction Factor + Reading Value.

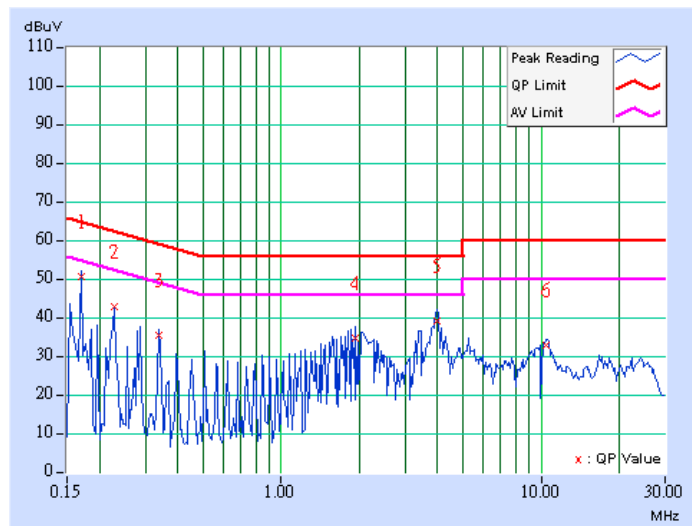



4.3 BAND EDGES MEASUREMENT

4.3.1 LIMITS OF BAND EDGES MEASUREMENT

Below -50dB of the highest emission level of operating band (in 100kHz Resolution Bandwidth).

4.3.2 TEST INSTRUMENTS

DESCRIPTION & MANUFACTURER	MODEL NO.	SERIAL NO.	CALIBRATED UNTIL
SPECTRUM ANALYZER	FSP40	100040	Jun. 28, 2008

NOTE: The calibration interval of the above test instruments is 12 months and the calibrations are traceable to NML/ROC and NIST/USA.

4.3.3 TEST PROCEDURE

The transmitter output was connected to the spectrum analyzer via a low lose cable. Set both RBW and VBW of spectrum analyzer to 100 kHz and 100 kHz with suitable frequency span including 100 MHz bandwidth from band edge. The band edges was measured and recorded.

The spectrum plots are attached on the following pages.

4.3.4 DEVIATION FROM TEST STANDARD

No deviation.

4.3.5 EUT OPERATING CONDITION

The software provided by client to enable the EUT under transmission condition continuously at lowest, middle and highest channel frequencies individually.

4.3.6 TEST RESULTS

The spectrum plots are attached on the following 4 images. D1 line indicates the highest level, and D2 line indicates the 50dB offset below D1. It shows compliance with the requirement in part 15.249 (d).

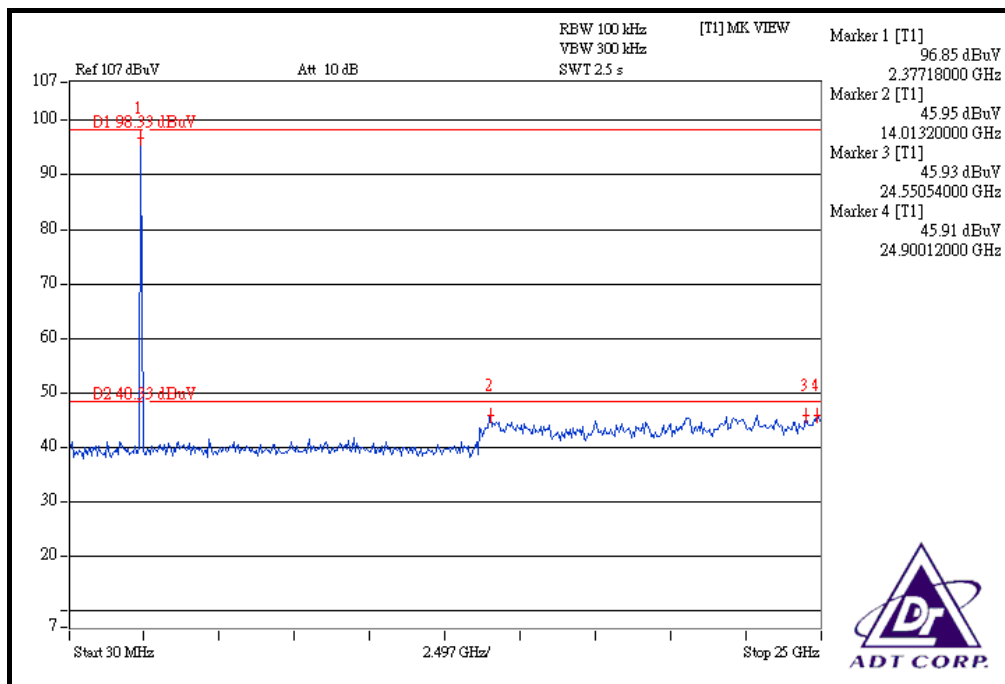
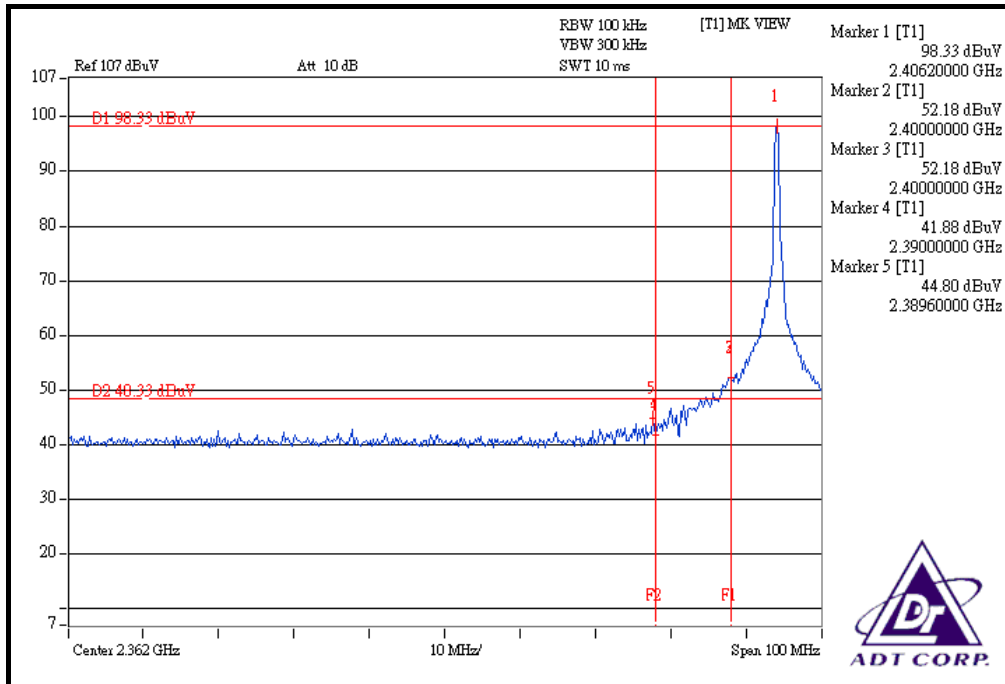

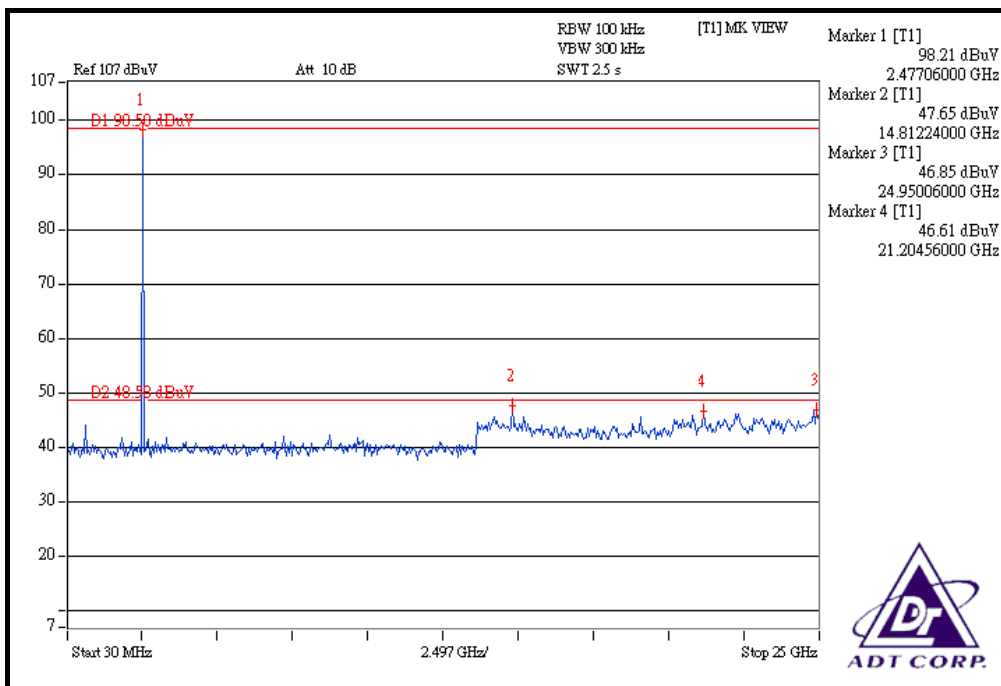
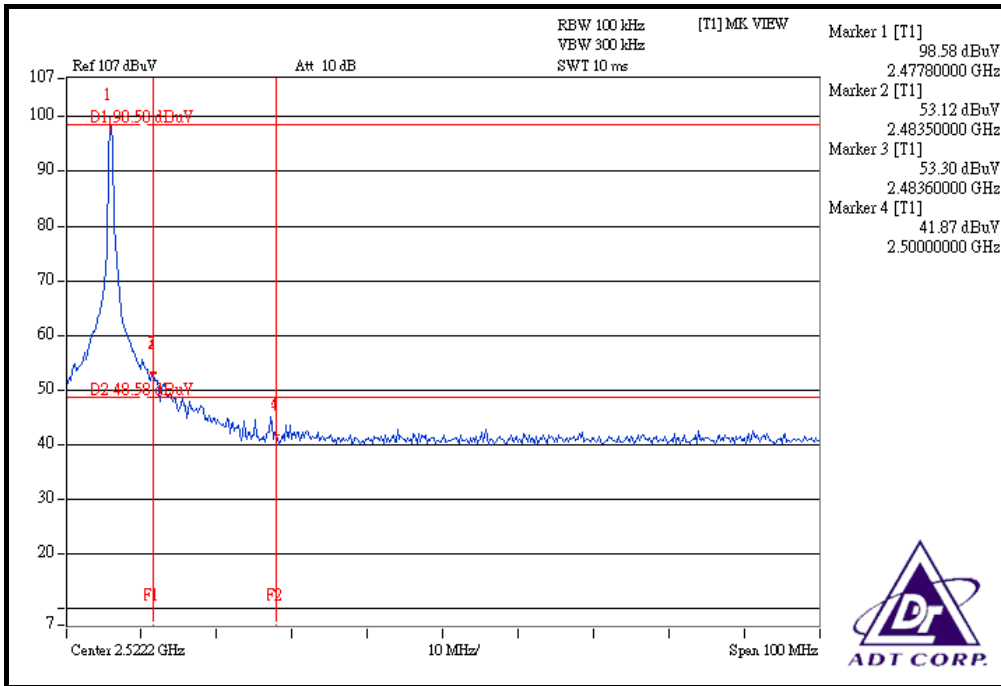



5. PHOTOGRAPHS OF THE TEST CONFIGURATION

Please refer to the attached file (Test Setup Photo).



6. INFORMATION ON THE TESTING LABORATORIES

We, ADT Corp., were founded in 1988 to provide our best service in EMC, Radio, Telecom and Safety consultation. Our laboratories are accredited and approved by the following approval agencies according to ISO/IEC 17025.

USA	FCC, UL, A2LA
Germany	TUV Rheinland
Japan	VCCI
Norway	NEMKO
Canada	INDUSTRY CANADA , CSA
R.O.C.	TAF, BSMI, NCC
Netherlands	Telefication
Singapore	GOST-ASIA(MOU)
Russia	CERTIS(MOU)

Copies of accreditation certificates of our laboratories obtained from approval agencies can be downloaded from our web site: www.adt.com.tw/index.5/phtml. If you have any comments, please feel free to contact us at the following:

Linko EMC/RF Lab

Tel: 886-2-26052180
Fax: 886-2-26051924

Hsin Chu EMC/RF Lab

Tel: 886-3-5935343
Fax: 886-3-5935342

Hwa Ya EMC/RF/Safety Telecom Lab

Tel: 886-3-3183232
Fax: 886-3-3185050

Web Site: www.adt.com.tw

The address and road map of all our labs can be found in our web site also



7. APPENDIX A - MODIFICATIONS RECORDERS FOR ENGINEERING CHANGES TO THE EUT BY THE LAB

No any modifications are made to the EUT by the lab during the test.