

2.4G Multimedia Keyboard & Mouse

USER'S GUIDE

Ver.:1.00

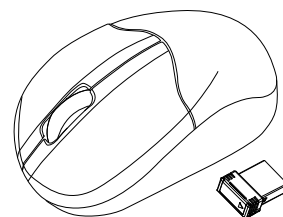
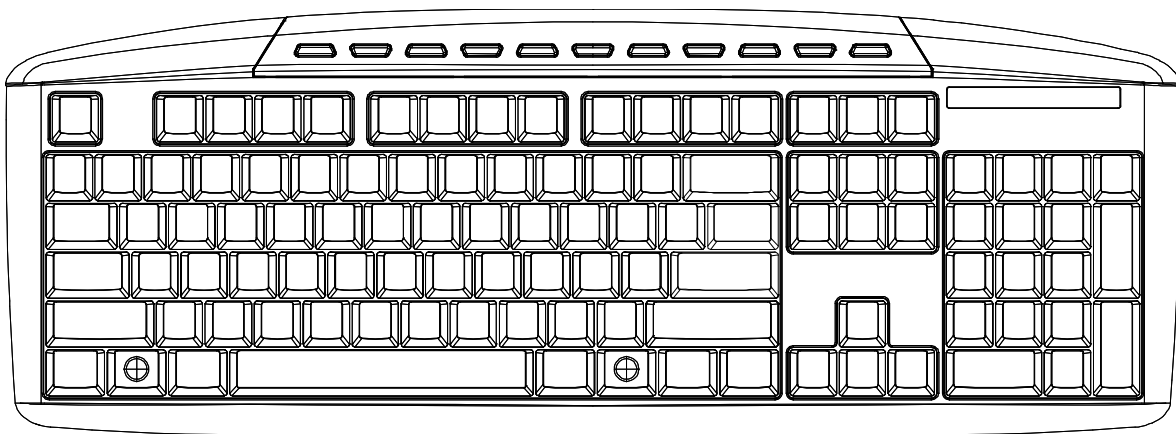

CAUTION: To use this product properly, please read the user's guide before installation

Federal Communication Commission Interference Statement

This equipment has been tested and found to comply with the limits for a Class B digital device, pursuant to Part 15 of the FCC Rules. These limits are designed to provide reasonable protection against harmful interference in a residential installation. This equipment generates, uses and can radiate radio frequency energy and, if not installed and used in accordance with the instructions, may cause harmful interference to radio communications. However, there is no guarantee that interference will not occur in a particular installation. If this equipment does cause harmful interference to radio or television reception, which can be determined by turning the equipment off and on, the user is encouraged to try to correct the interference by one of the following measures:

- Reorient or relocate the receiving antenna.
- Increase the separation between the equipment and receiver.
- Connect the equipment into an outlet on a circuit different from that to which the receiver is connected.
- Consult the dealer or an experienced radio/TV technician for help.

FCC Caution: Any changes or modifications not expressly approved by the party responsible for compliance could void the user's authority to operate this equipment.

This device complies with Part 15 of the FCC Rules. Operation is subject to the following two conditions: (1) This device may not cause harmful interference, and (2) this device must accept any interference received, including interference that may cause undesired operation.

Functional Introduction

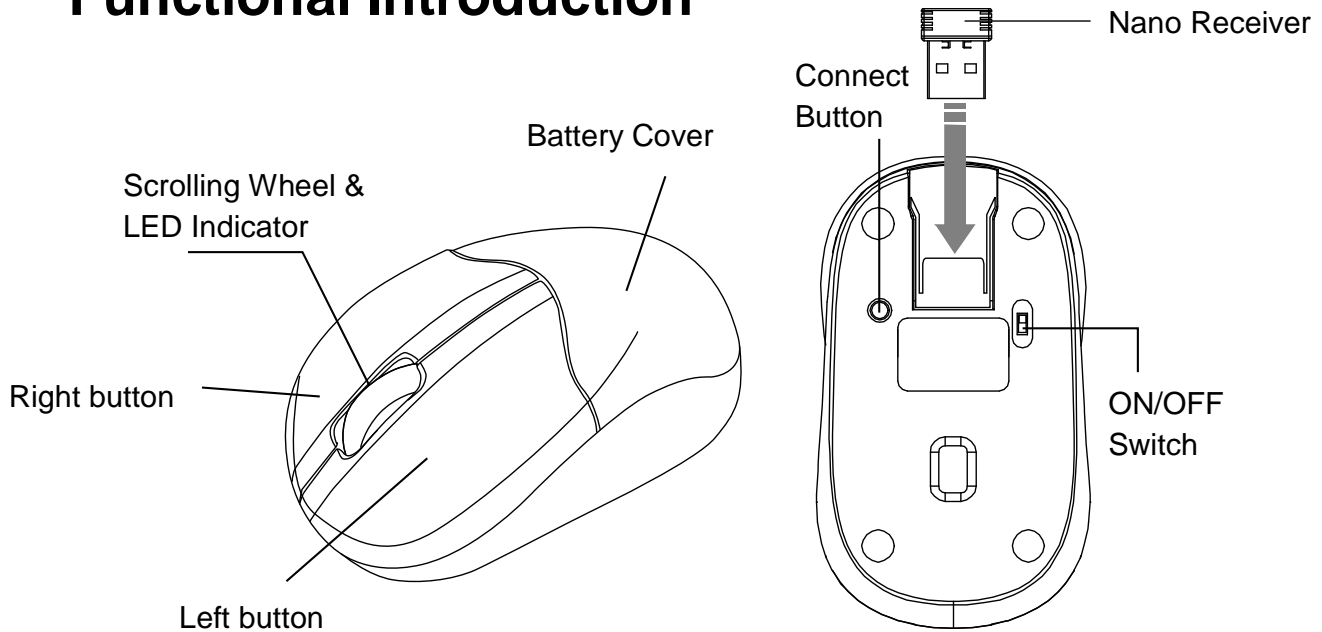

Battery and Power Management:

Step 1: Pull the battery cover backward.

Step 2: Insert the batteries as shown inside the battery compartment.

Step 3: Replace the cover.

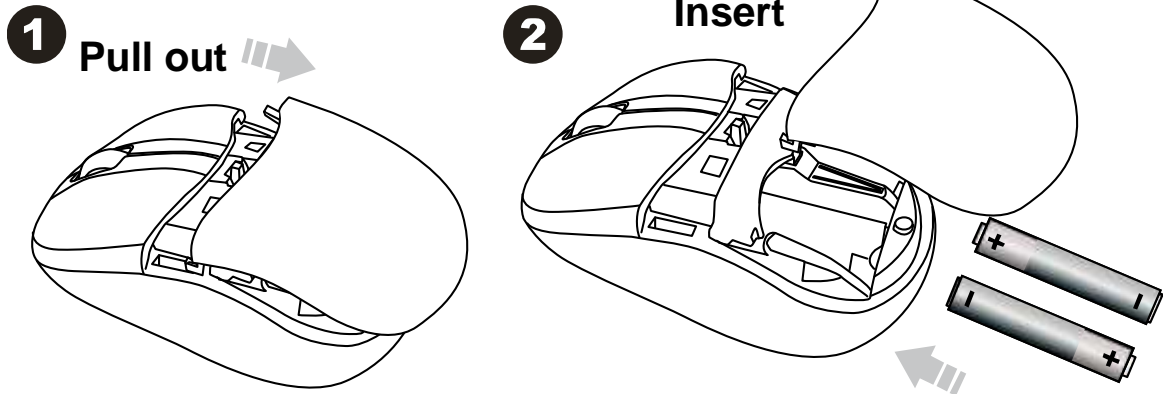

For Extra usage hours, use two AA batteries instead of two AAA Batteries.









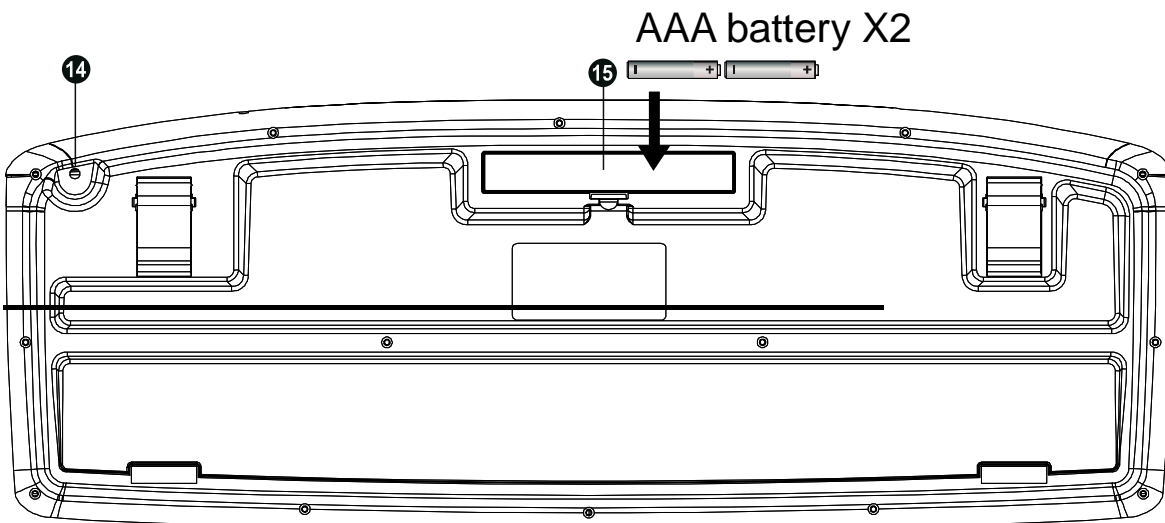
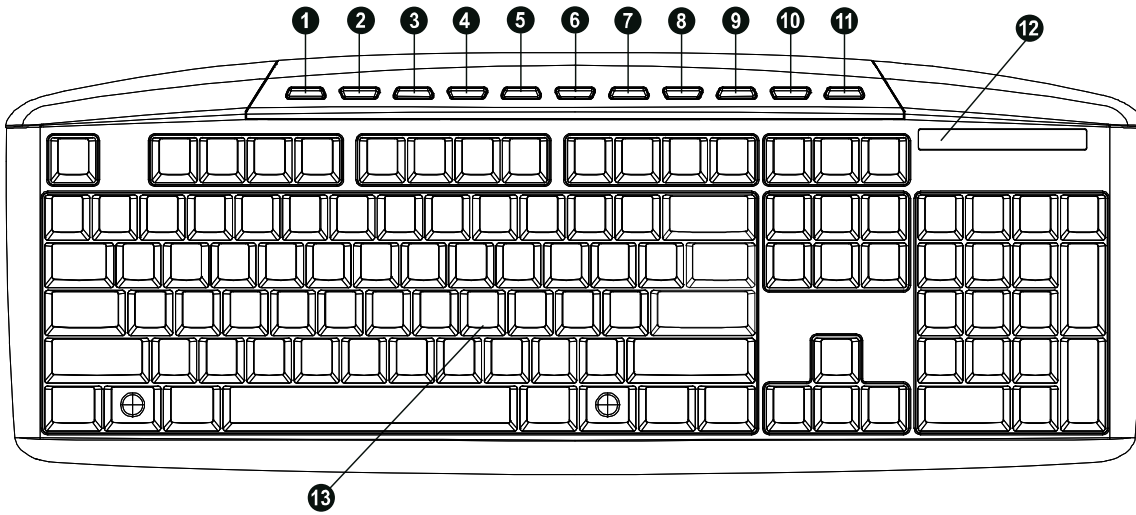

****Warning:**

*Please insert the battery with the correct position according to the instruction labeled on the mouse.

Keyboard Buttons

Media Player Hot Keys



Media Player Hot Keys			
1.		Outlook(E-mail)→Default	Start the default e-mail program
2.		Homepage(www/e)	Start the default Web browser and loads the home Web page
3.		Web Stop	Stop loading the current page
4.		Search	Open the Internet Explorer Search panel
5.		My Favorites	Start my favorites
6.		Mute	Mute (turns off) the computer's sound
7.		Volume down (Voice-)	Decrease the computer's sound volume.
8.		Volume up (Voice+)	Increase the computer's sound volume.
9.		Play/Pause	Switch between playing and pausing media
10.		Calculator	Start Microsoft Calculator
11.		My Computer	My Computer
12.	LED Indicator		Low Battery & Pairing Indicator
13.	104 standard-Keys		
14.	Connect Button		
15.	Battery Cover		

Setup the Connection between the Receiver and the Mouse, Keyboard.

1. Plug the RF receiver into the USB port of your computer.

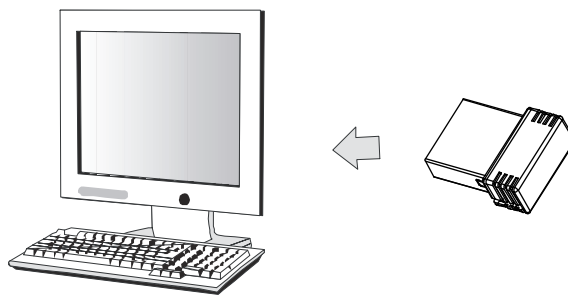

2. Insert the batteries into the mouse and keyboard, then follow the steps below.

3. If the mouse or the keyboard is not working, please put them into pair mode.

4. Pairing: Re-plug the receiver into the USB port of your computer, then press connect button of the moue and keyboard. If the mouse or keyboard does not work after 10 seconds, pair them again. (The receiver has auto pairing function).
5. When the batteries' power of the keyboard is low, the Low Power indicator will start to blink.

LED Indicator

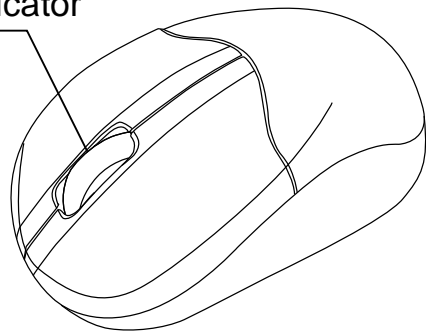

***Mouse Indicator**

LED is on 3 sec.

Power ON



LED Blinks 3 times

During Pairing



Low Battery Warning will blink 10 times when turn on.

LED indicator

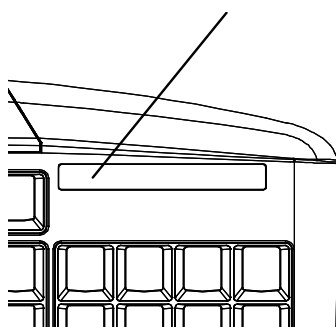

***Keyboard Indicator**

Red LED is on for 10 sec.

Power ON



Red LED Blinks for 10 sec.

Low Battery Warning



Red LED Blinking

Pairing (LED OFF when paired or failed after 10 sec.)