



**FCC 47 CFR PART 15 SUBPART C**

**TEST REPORT**

**For**

**Wireless dongle**

**Model Number / Trade Name:**

**AMW50R / TARGUS,**

**MRZ / ACROX**

*Issued to*

**Acrox Technologies Co., Ltd.**

**8F, No. 437, Rui Guang Rd., Nei Hu Dist., Taipei 114, Taiwan, R.O.C.**

*Issued by*



**Compliance Certification Services Inc.**

**No. 11, Wu-Gong 6<sup>th</sup> Rd., Wugu Industrial Park,**

**Taipei Hsien 248, Taiwan (R.O.C.)**

**<http://www.ccsrf.com>**

**[service@ccsrf.com](mailto:service@ccsrf.com)**



---

***Note:** This report shall not be reproduced except in full, without the written approval of Compliance Certification Services Inc. This document may be altered or revised by Compliance Certification Services Inc. personnel only, and shall be noted in the revision section of the document.*



## TABLE OF CONTENTS

1. TEST RESULT CERTIFICATION.....	3
2. EUT DESCRIPTION.....	4
3. TEST METHODOLOGY .....	5
3.1 EUT CONFIGURATION .....	5
3.2 EUT EXERCISE.....	5
3.3 GENERAL TEST PROCEDURES.....	5
3.4 FCC PART 15.205 RESTRICTED BANDS OF OPERATIONS .....	6
3.5 DESCRIPTION OF TEST MODES .....	6
4. INSTRUMENT CALIBRATION.....	7
4.1 MEASURING INSTRUMENT CALIBRATION .....	7
4.2 MEASUREMENT EQUIPMENT USED .....	7
4.3 MEASUREMENT UNCERTAINTY .....	8
5. FACILITIES AND ACCREDITATIONS .....	9
5.1 FACILITIES .....	9
5.2 EQUIPMENT.....	9
5.3 TABLE OF ACCREDITATIONS AND LISTINGS.....	10
6. SETUP OF EQUIPMENT UNDER TEST .....	11
6.1 SETUP CONFIGURATION OF EUT.....	11
6.2 SUPPORT EQUIPMENT .....	11
7. FCC PART 15.249 REQUIREMENTS.....	12
7.1 20 DB BANDWIDTH.....	12
7.2 BAND EDGES MEASUREMENT .....	15
7.3 SPURIOUS EMISSION .....	20
7.4 POWERLINE CONDUCTED EMISSIONS .....	28
APPENDIX I PHOTOGRAPHS OF TEST SETUP .....	31
APPENDIX 1 - PHOTOGRAPHS OF EUT	



# 1. TEST RESULT CERTIFICATION

**Applicant:** Acrox Technologies Co., Ltd.  
8F, No. 437, Rui Guang Rd., Nei Hu Dist.,  
Taipei 114, Taiwan, R.O.C.

**Equipment Under Test:** Wireless dongle

**Model Number / Trade Name:** AMW50R / TARGUS, MRZ / ACROX

**Date of Test:** April 29 ~ May 20, 2010

APPLICABLE STANDARDS	
STANDARD	TEST RESULT
FCC 47 CFR Part 15 Subpart C	No non-compliance noted

## We hereby certify that:

The above equipment was tested by Compliance Certification Services Inc. The test data, data evaluation, test procedures, and equipment configurations shown in this report were made in accordance with the procedures given in **ANSI C63.4: 2003** and the energy emitted by the sample EUT tested as described in this report is in compliance with the requirements emission limits of FCC Rules Part 15.207, 15.209 and 15.249.

The test results of this report relate only to the tested sample identified in this report.

*Approved by:*

*Reviewed by:*

\_\_\_\_\_  
Rex Lai  
Section Manager  
Compliance Certification Services Inc.

\_\_\_\_\_  
Gina Lo  
Section Manager  
Compliance Certification Services Inc.



## 2. EUT DESCRIPTION

<b>Product</b>	Wireless dongle
<b>Model / Brand:</b>	AMW50R / TARGUS, MRZ / ACROX
<b>Model Discrepancy</b>	All the specification and layout are identical except they come with different model numbers for marketing purposes.
<b>Power Supply</b>	Power form host device.
<b>Frequency Range</b>	2403~2471 MHz
<b>Frequency Number</b>	69 Channels
<b>Modulation Technique</b>	GFSK
<b>Antenna Gain</b>	-5.91 dBi
<b>Antenna Designation</b>	PCB Antenna

**Remark:**

1. *The sample selected for test was production product and was provided by manufacturer.*
2. *This submittal(s) (test report) is intended for FCC ID: **PRDMUWIRTRE03** filing to comply with Section 15.107, 15.109, 15.207, 15.209, 15.249 (FCC Part 15, Subpart C Rules.)*



### **3. TEST METHODOLOGY**

The tests documented in this report were performed in accordance with ANSI C63.4: 2003 and FCC CFR 47 Part 15.207, 15.209 and 15.249.

#### **3.1 EUT CONFIGURATION**

The EUT configuration for testing is installed on RF field strength measurement to meet the Commissions requirement and operating in a manner that intends to maximize its emission characteristics in a continuous normal application.

#### **3.2 EUT EXERCISE**

The EUT was operated in the engineering mode to fix the TX frequency that was for the purpose of the measurements.

According to its specifications, the EUT must comply with the requirements of the Section 15.207, 15.209, 15.249 under the FCC Rules Part 15 Subpart C.

#### **3.3 GENERAL TEST PROCEDURES**

##### **Conducted Emissions**

The EUT is placed on the turntable, which is 0.8 m above ground plane. According to the requirements in Section 13.1.4.1 of ANSI C63.4: 2003 Conducted emissions from the EUT measured in the frequency range between 0.15 MHz and 30MHz using CISPR Quasi-peak and average detector modes.

##### **Radiated Emissions**

The EUT is placed on a turn table, which is 0.8 m above ground plane. The turntable shall rotate 360 degrees to determine the position of maximum emission level. EUT is set 3m away from the receiving antenna, which varied from 1m to 4m to find out the highest emission. And also, each emission was to be maximized by changing the polarization of receiving antenna both horizontal and vertical. In order to find out the maximum emissions, exploratory radiated emission measurements were made according to the requirements in Section 13.1.4.1 of ANSI C63.4: 2003.



### 3.4 FCC PART 15.205 RESTRICTED BANDS OF OPERATIONS

(a) Except as shown in paragraph (d) of this section, only spurious emissions are permitted in any of the frequency bands listed below:

MHz	MHz	MHz	GHz
0.090 - 0.110	16.42 - 16.423	399.9 - 410	4.5 - 5.15
<sup>1</sup> 0.495 - 0.505	16.69475 - 16.69525	608 - 614	5.35 - 5.46
2.1735 - 2.1905	16.80425 - 16.80475	960 - 1240	7.25 - 7.75
4.125 - 4.128	25.5 - 25.67	1300 - 1427	8.025 - 8.5
4.17725 - 4.17775	37.5 - 38.25	1435 - 1626.5	9.0 - 9.2
4.20725 - 4.20775	73 - 74.6	1645.5 - 1646.5	9.3 - 9.5
6.215 - 6.218	74.8 - 75.2	1660 - 1710	10.6 - 12.7
6.26775 - 6.26825	108 - 121.94	1718.8 - 1722.2	13.25 - 13.4
6.31175 - 6.31225	123 - 138	2200 - 2300	14.47 - 14.5
8.291 - 8.294	149.9 - 150.05	2310 - 2390	15.35 - 16.2
8.362 - 8.366	156.52475 -	2483.5 - 2500	17.7 - 21.4
8.37625 - 8.38675	156.52525	2655 - 2900	22.01 - 23.12
8.41425 - 8.41475	156.7 - 156.9	3260 - 3267	23.6 - 24.0
12.29 - 12.293	162.0125 - 167.17	3332 - 3339	31.2 - 31.8
12.51975 - 12.52025	167.72 - 173.2	3345.8 - 3358	36.43 - 36.5
12.57675 - 12.57725	240 - 285	3600 - 4400	( <sup>2</sup> )
13.36 - 13.41	322 - 335.4		

<sup>1</sup> Until February 1, 1999, this restricted band shall be 0.490-0.510 MHz.

<sup>2</sup> Above 38.6

(b) Except as provided in paragraphs (d) and (e), the field strength of emissions appearing within these frequency bands shall not exceed the limits shown in Section 15.209. At frequencies equal to or less than 1000 MHz, compliance with the limits in Section 15.209 shall be demonstrated using measurement instrumentation employing a CISPR quasi-peak detector. Above 1000 MHz, compliance with the emission limits in Section 15.209 shall be demonstrated based on the average value of the measured emissions. The provisions in Section 15.35 apply to these measurements.

### 3.5 DESCRIPTION OF TEST MODES

The EUT (model: AMW50R) had been tested under operating condition.

After verification, all tests were carried out with the worst case test modes as shown below except radiated spurious emission below 1GHz, which worst case was in normal link mode only, and powerline conducted emission below 30MHz, which worst case was in normal link mode

Channel Low (2403MHz), Channel Mid (2432MHz) and Channel High (2471MHz) were chosen for full testing.

The field strength of spurious emission was measured in the following position: EUT stand-up position (Z mode), lie-down position (X, Y mode). The worst emission was found in lie-down position (X axis) and the worst case was recorded.



## 4. INSTRUMENT CALIBRATION

### 4.1 MEASURING INSTRUMENT CALIBRATION

The measuring equipment, which was utilized in performing the tests documented herein, has been calibrated in accordance with the manufacturer's recommendations for utilizing calibration equipment, which is traceable to recognized national standards.

### 4.2 MEASUREMENT EQUIPMENT USED

#### Equipment Used for Emissions Measurement

*Remark: Each piece of equipment is scheduled for calibration once a year.*

Conducted Emissions Test Site				
Name of Equipment	Manufacturer	Model	Serial Number	Calibration Due
Spectrum Analyzer	Agilent	E4446A	MY43360131	03/03/2011

3M Semi Anechoic Chamber				
Name of Equipment	Manufacturer	Model	Serial Number	Calibration Due
Spectrum Analyzer	Agilent	E4446A	US42510252	10/26/2010
EMI Test Receiver	R&S	ESCI	100064	02/04/2011
Pre-Amplifier	Mini-Circuits	ZFL-1000LN	SF350700823	01/13/2011
Pre-Amplifier	MITEQ	AFS44-00102650-42-10P-44	1415367	11/20/2010
Bilog Antenna	Sunol Sciences	JB3	A030105	09/11/2010
Horn Antenna	EMCO	3117	00055165	12/07/2010
Loop Antenna	EMCO	6502	8905/2356	05/27/2011
Turn Table	CCS	CC-T-1F	N/A	N.C.R
Antenna Tower	CCS	CC-A-1F	N/A	N.C.R
Controller	CCS	CC-C-1F	N/A	N.C.R
Site NSA	CCS	N/A	N/A	12/31/2010
Test S/W	EZ-EMC (CCS-3A1RE)			

Powerline Conducted Emissions Test Site				
Name of Equipment	Manufacturer	Model	Serial Number	Calibration Due
EMI Test Receiver	R&S	ESHS30	828144/003	12/06/2010
LISN	EMCO	3825/2	9106-1809	05/02/2011
LISN	SCHAFFNER	NNB 41	03/10013	12/03/2010
Test S/W	CCS-3A1-CE			



### 4.3 MEASUREMENT UNCERTAINTY

PARAMETER	UNCERTAINTY
Powerline Conducted Emission	+/- 1.6202
3M Semi Anechoic Chamber / 30M~200M	+/- 4.0606
3M Semi Anechoic Chamber / 200M~1000M	+/- 3.9979
3M Semi Anechoic Chamber / 1G~8G	+/- 2.5790
3M Semi Anechoic Chamber / 8G~18G	+/- 2.5928
3M Semi Anechoic Chamber / 18G~26G	+/- 2.7212
3M Semi Anechoic Chamber / 26G~40G	+/- 2.9520

**Remark:** This uncertainty represents an expanded uncertainty expressed at approximately the 95% confidence level using a coverage factor of  $k=2$ .





## 5. FACILITIES AND ACCREDITATIONS

### 5.1 FACILITIES

All measurement facilities used to collect the measurement data are located at

No. 199, Chunghsen Road, Hsintien City, Auerbach / Opf GERMANY

Tel: 886-2-2217-0894 / Fax: 886-2-2217-1029

No.11, Wugong 6th Rd., Wugu Industrial Park, Taipei Hsien 248, Taiwan

Tel: 886-2-2299-9720 / Fax: 886-2-2298-4045

No.81-1, Lane 210, Bade 2nd Rd., Luchu Hsiang, Taoyuan Hsien 338, Taiwan

Tel: 886-3-324-0332 / Fax: 886-3-324-5235

The sites are constructed in conformance with the requirements of ANSI C63.7, ANSI C63.4 and CISPR Publication 22.

### 5.2 EQUIPMENT



Radiated emissions are measured with one or more of the following types of linearly polarized antennas: tuned dipole, biconical, log periodic, bi-log, and/or ridged waveguide, horn. Spectrum analyzers with pre-selectors and quasi-peak detectors are used to perform radiated measurements.

Conducted emissions are measured with Line Impedance Stabilization Networks and EMI Test Receivers.

Calibrated wideband preamplifiers, coaxial cables, and coaxial attenuators are also used for making measurements.

All receiving equipment conforms to CISPR Publication 16-1, "Radio Interference Measuring Apparatus and Measurement Methods."

### 5.3 TABLE OF ACCREDITATIONS AND LISTINGS

Country	Agency	Scope of Accreditation	Logo
USA	FCC	3M Semi Anechoic Chamber (FCC MRA: TW1039) to perform FCC Part 15 measurements	 FCC MRA: TW1039
Taiwan	TAF	LP0002, RTTE01, FCC Method-47 CFR Part 15 Subpart C, D, E, RSS-210, RSS-310 IDA TS SRD, AS/NZS 4268, AS/NZS 4771, TS 12.1 & 12.2, ETSI EN 300 440-1, ETSI EN 300 440-2, ETSI EN 300 328, ETSI EN 300 220-1, ETSI EN 300 220-2, ETSI EN 301 893, ETSI EN 301 489-1/3/7/17 FCC OET Bulletin 65 + Supplement C, EN 50360, EN 50361, EN 50371, RSS 102, EN 50383, EN 50385, EN 50392, IEC 62209, CNS 14958-1, CNS 14959 FCC Method -47 CFR Part 15 Subpart B IEC / EN 61000-3-2, IEC / EN 61000-3-3, IEC / EN 61000-4-2/3/4/5/6/8/11	
Canada	Industry Canada	3M Semi Anechoic Chamber (IC 2324G-1 / IC 2324G-2) to perform	 IC 2324G-1 IC 2324G-2

\* No part of this report may be used to claim or imply product endorsement by A2LA or any agency of the US Government.



## 6. SETUP OF EQUIPMENT UNDER TEST

### 6.1 SETUP CONFIGURATION OF EUT

See test photographs attached in Appendix I for the actual connections between EUT and support equipment.

### 6.2 SUPPORT EQUIPMENT

No	Device Type	Brand	Model	Series No.	FCC ID	Data Cable	Power Cord
1.	Notebook PC	DELL	PP10L	71G6Q1S	FCC DoC	N/A	AC I/P: Unshielded, 1.8m DC O/P: Unshielded, 1.8m with a core
2.	Wireless Mouse	ACROX	N/A	N/A	OXM000017	N/A	N/A
3.	LCD Monitor	DELL	2407WFPb	CN-0FC255-46633 -675-22TJS	FCC DoC	Shielded, 1.8m with 2 cores	Unshielded, 1.8m
4.	320GB 2.5" HDD	Seagate	9ZA2MG-500	2GE3NHH0	FCC DoC	Shielded, 1.8m	N/A
5.	Test Kit	N/A	N/A	N/A	N/A	N/A	N/A

**Remark:**

1. All the equipment/cables were placed in the worst-case configuration to maximize the emission during the test.
2. Grounding was established in accordance with the manufacturer's requirements and conditions for the intended use.

## 7. FCC PART 15.249 REQUIREMENTS

### 7.1 20 DB BANDWIDTH

#### LIMIT

None; for reporting purposes only.

#### Test Configuration

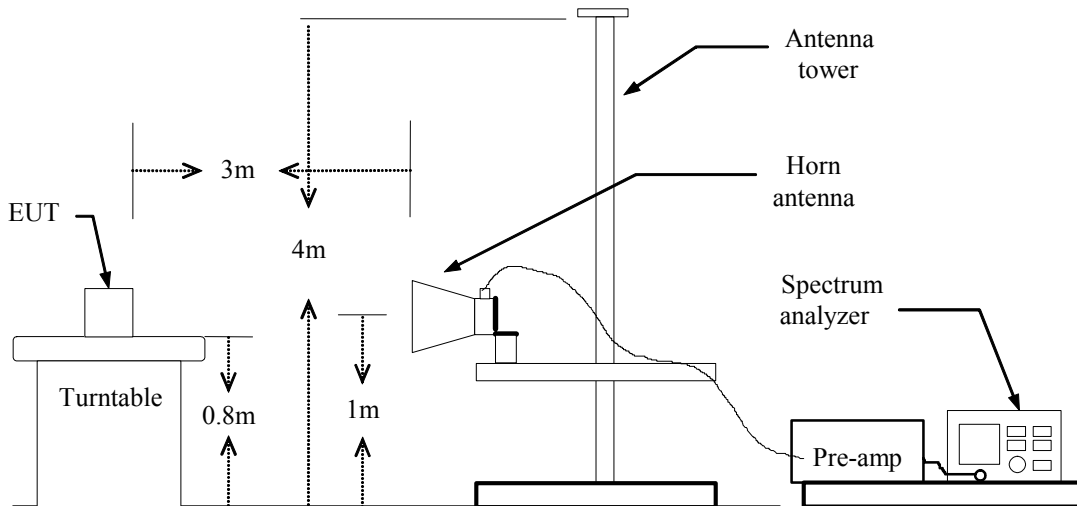

#### TEST PROCEDURE

1. Place the EUT on the table and set it in the transmitting mode.
2. Remove the antenna from the EUT and then connect a low loss RF cable from the antenna port to the spectrum analyzer.
3. Set the spectrum analyzer as RBW=51kHz, VBW = 160kHz, Span = 5MHz, Sweep = auto.
4. Mark the peak frequency and 20dB (upper and lower) frequency.
5. Repeat until all the rest channels are investigated.

#### TEST RESULTS

*No non-compliance noted*

#### Test Data

Channel	Frequency (MHz)	20dB Bandwidth (MHz)
Low	2403	2.425
Mid	2432	1.425
High	2471	1.400



### Test Plot

#### CH Low

Agilent 00:05:41 May 20, 2010

R T

Δ Mkr2 2.425 MHz  
-2.69 dB

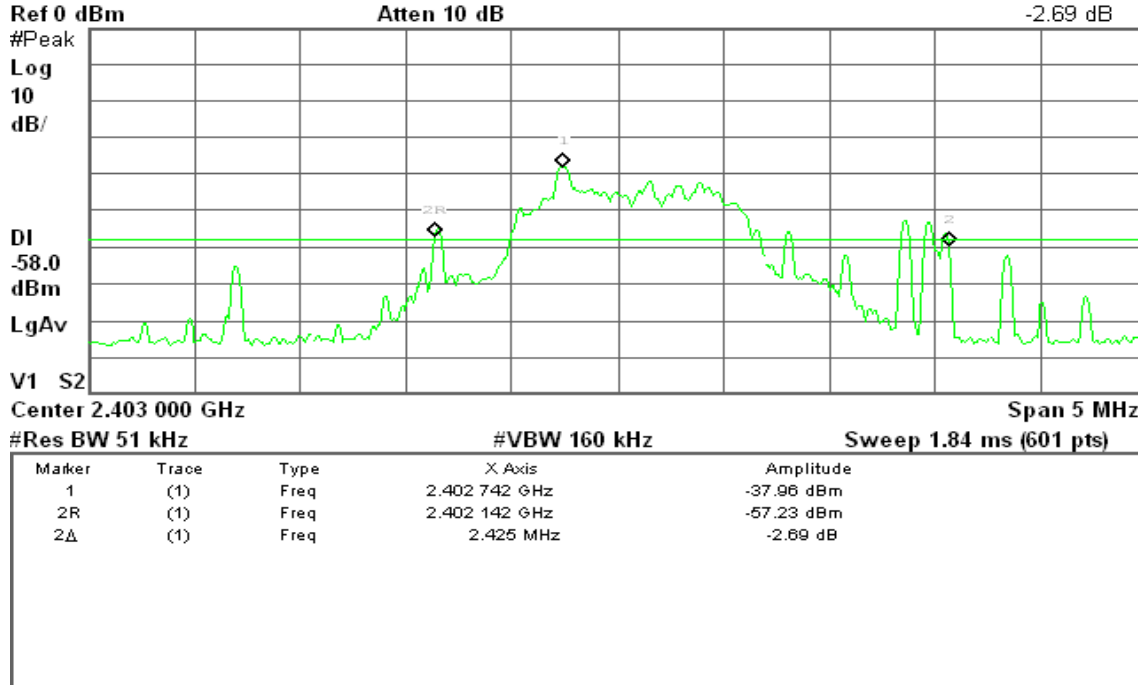

#### CH Mid

Agilent 00:06:56 May 20, 2010

R T

Δ Mkr2 1.425 MHz  
-0.95 dB

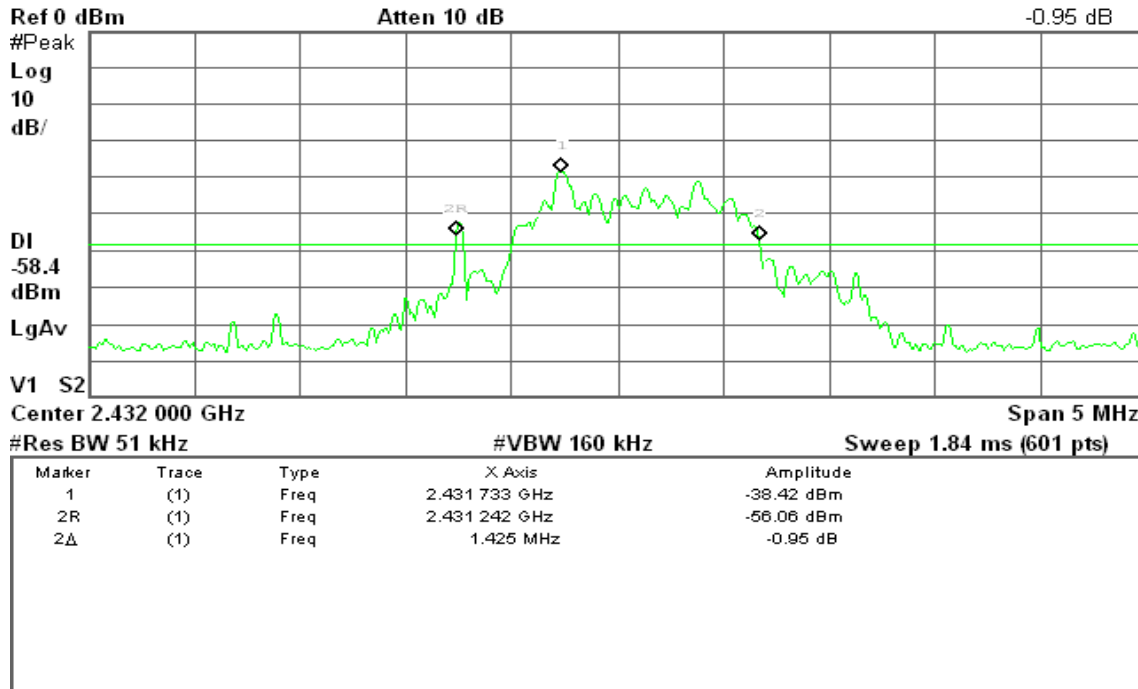



### CH High

Agilent 00:11:05 May 20, 2010

R T

Δ Mkr2 1.400 MHz

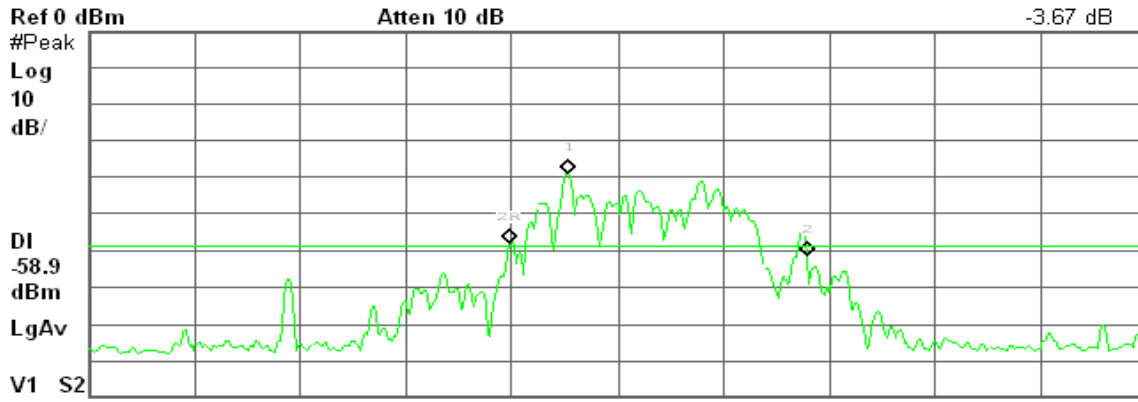

Marker	Trace	Type	X Axis	Amplitude
1	(1)	Freq	2.470 767 GHz	-38.94 dBm
2R	(1)	Freq	2.470 492 GHz	-67.94 dBm
2Δ	(1)	Freq	1.400 MHz	-3.67 dB

## 7.2 BAND EDGES MEASUREMENT

### LIMIT

1. In the above emission table, the tighter limit applies at the band edges.

Frequency (MHz)	Field Strength ( $\mu\text{V}/\text{m}$ at 3-meter)	Field Strength ( $\text{dB}\mu\text{V}/\text{m}$ at 3-meter)
30-88	100	40
88-216	150	43.5
216-960	200	46
Above 960	500	54

2. As shown in Section 15.35(b), for frequencies above 1000 MHz, the above field strength limits in paragraphs (a) and (b) of this section are based on average limits. However, the peak field strength of any emission shall not exceed the maximum permitted average limits specified above by more than 20 dB under any condition of modulation. For point-to-point operation under paragraph (b) of this section, the peak field strength shall not exceed 2500 millivolts/meter at 3 meters along the antenna azimuth.

### Test Configuration

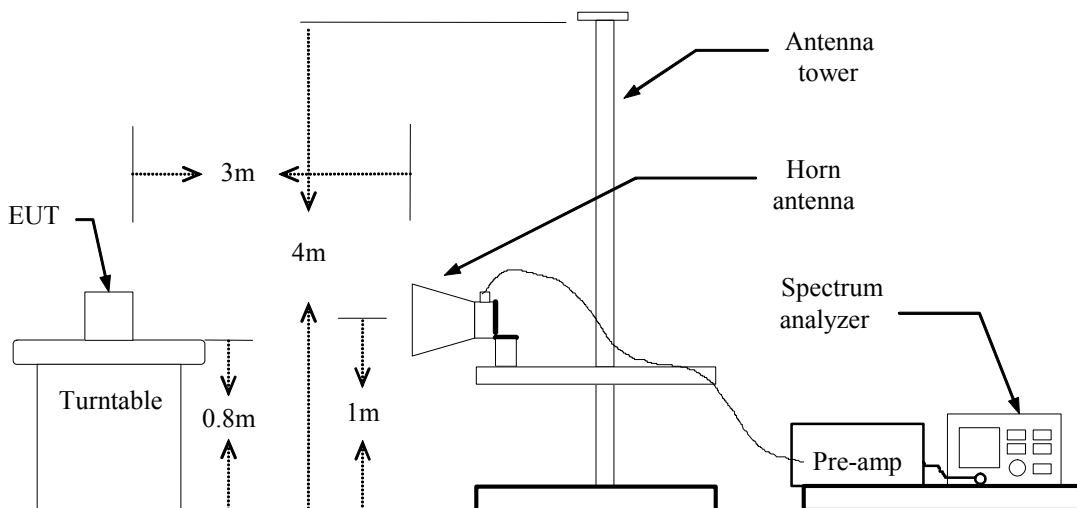

### TEST PROCEDURE

1. The EUT is placed on a turntable, which is 0.8m above the ground plane.
2. The turntable shall be rotated for 360 degrees to determine the position of maximum emission level.
3. EUT is set 3m away from the receiving antenna, which is varied from 1m to 4m to find out the highest emission.
4. Set the spectrum analyzer in the following setting in order to capture the lower and upper band-edges of the emission:
  - (a) PEAK: RBW=VBW=1MHz / Sweep=AUTO
  - (b) AVERAGE: RBW=1MHz / VBW=10Hz / Sweep=AUTO
5. Repeat the procedures until all the PEAK and AVERAGE versus POLARIZATION are measured.

### TEST RESULTS

Refer to attach spectrum analyzer data chart.



Band Edges (CH Low)

Detector mode: Peak

Polarity: Vertical

Agilent 22:04:37 May 19, 2010

R T

Mkr1 2.390 0 GHz  
53.40 dBµV

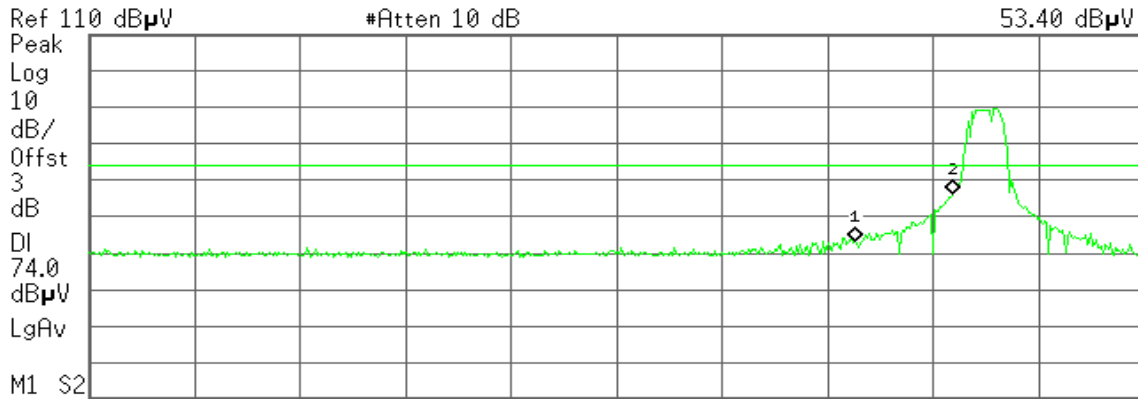

Start 2.310 0 GHz Stop 2.420 0 GHz  
#Res BW 1 MHz #VBW 1 MHz #Sweep 100 ms (601 pts)

Marker	Trace	Type	X Axis	Amplitude
1	(1)	Freq	2.390 0 GHz	53.40 dBµU
2	(1)	Freq	2.400 0 GHz	66.26 dBµU

Detector mode: Average

Polarity: Vertical

Agilent 22:05:55 May 19, 2010

R T

Mkr1 2.390 0 GHz  
36.85 dBµV

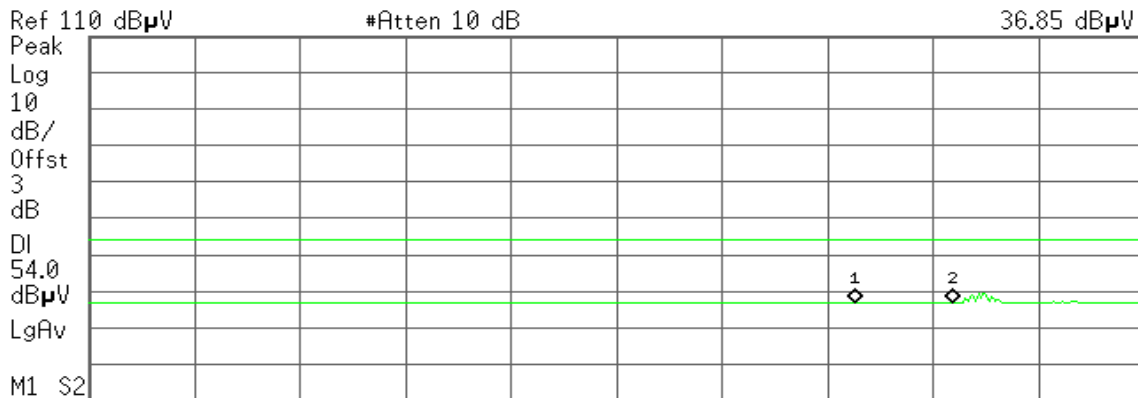

Start 2.310 0 GHz Stop 2.420 0 GHz  
#Res BW 1 MHz #VBW 10 Hz Sweep 8.577 s (601 pts)

Marker	Trace	Type	X Axis	Amplitude
1	(1)	Freq	2.390 0 GHz	36.85 dBµU
2	(1)	Freq	2.400 0 GHz	36.83 dBµU





Detector mode: Peak

Polarity: Horizontal

Agilent 22:17:03 May 19, 2010

T

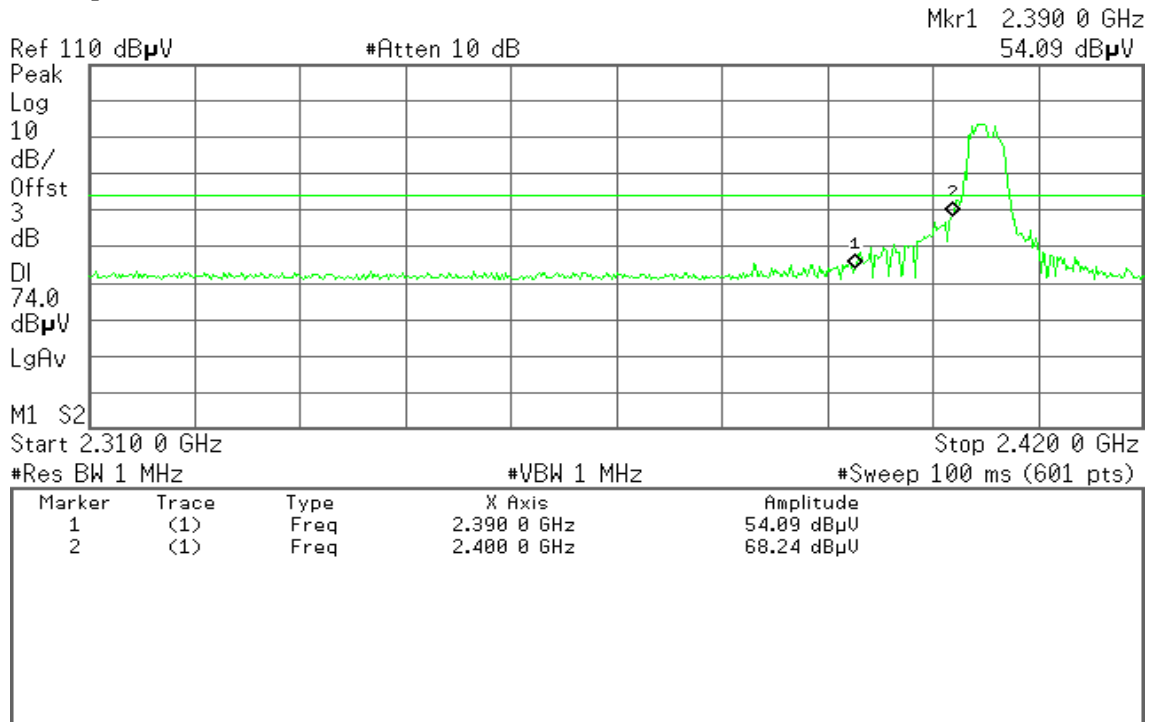

Detector mode: Average

Polarity: Horizontal

Agilent 22:17:56 May 19, 2010

T

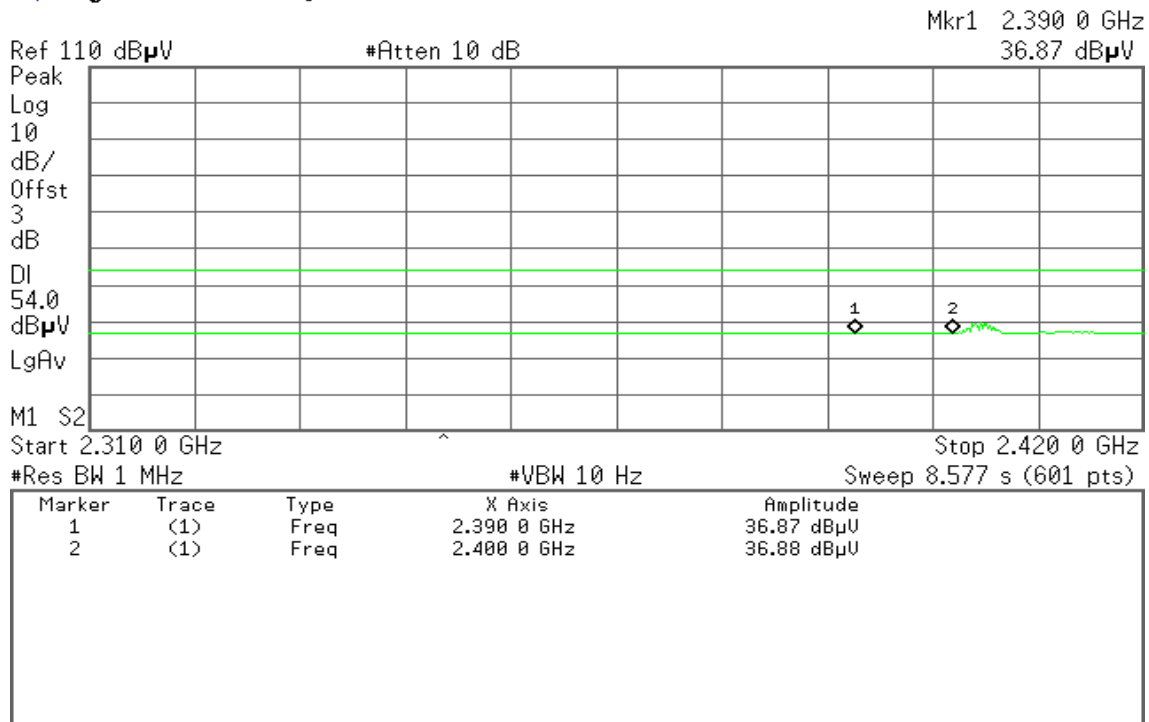



### Band Edges (CH High)

Detector mode: Peak

Polarity: Vertical

Agilent 22:42:16 May 19, 2010

T

Mkr1 2.483 50 GHz  
50.38 dBμV

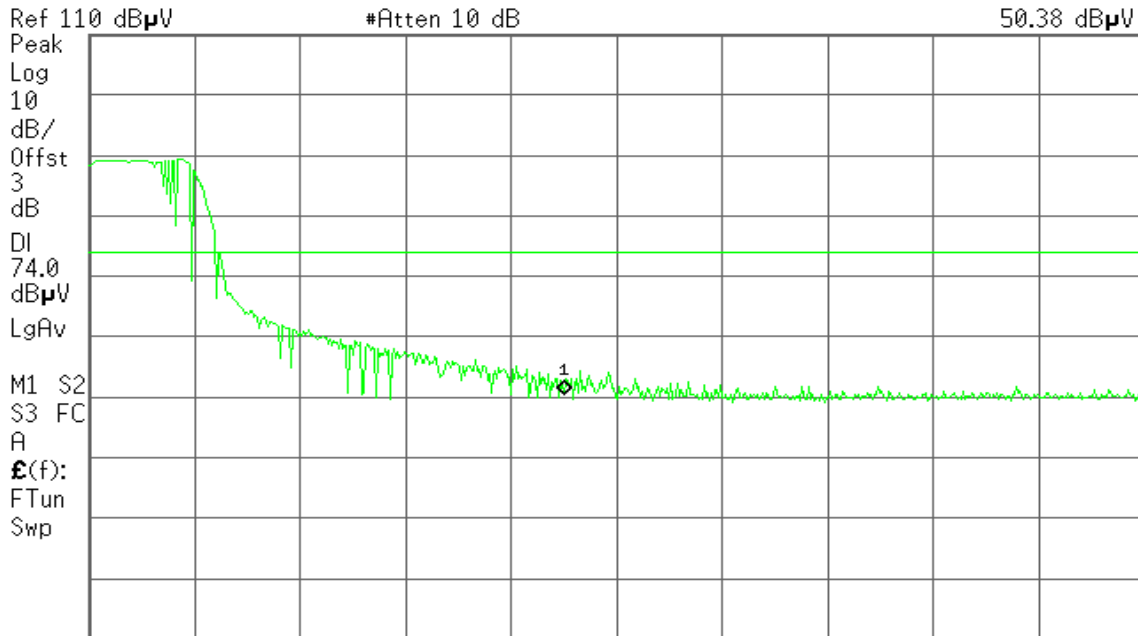

Start 2.470 00 GHz Stop 2.500 00 GHz  
#Res BW 1 MHz #VBW 1 MHz #Sweep 100 ms (601 pts)

Detector mode: Average

Polarity: Vertical

Agilent 22:42:48 May 19, 2010

T

Mkr1 2.483 50 GHz  
37.10 dBμV



Start 2.470 00 GHz Stop 2.500 00 GHz  
#Res BW 1 MHz #VBW 10 Hz Sweep 2.339 s (601 pts)



Detector mode: Peak

Polarity: Horizontal

Agilent 22:53:54 May 19, 2010

T

Mkr1 2.483 50 GHz  
54.66 dBμV

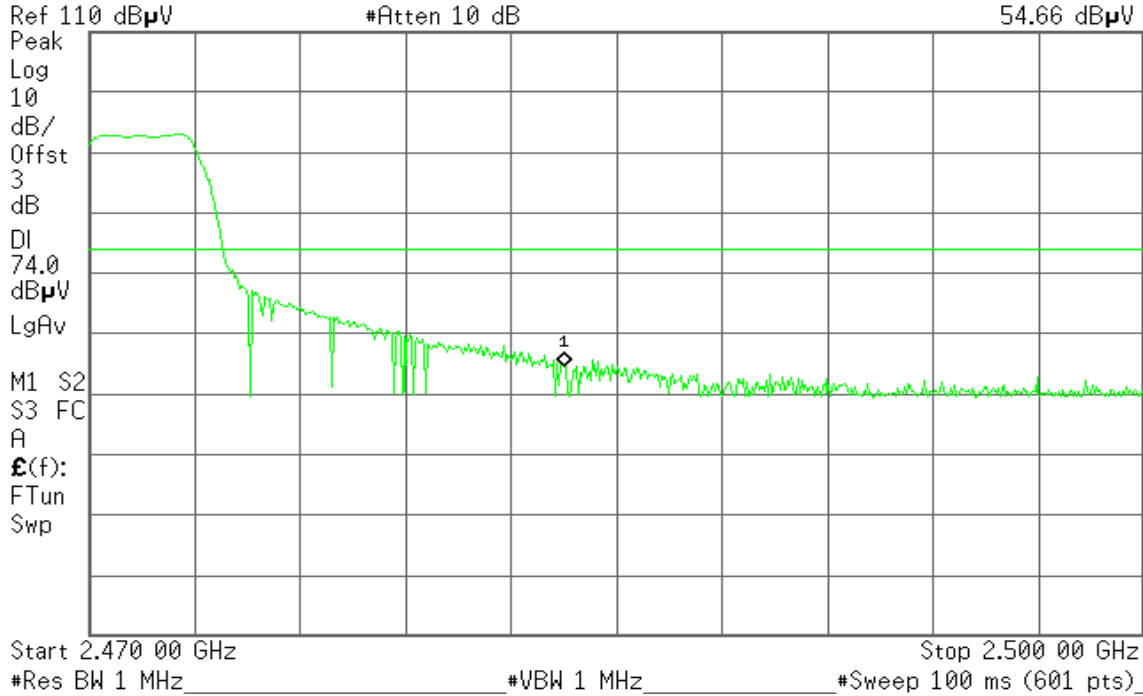

Detector mode: Average

Polarity: Horizontal

Agilent 22:54:45 May 19, 2010

T

Mkr1 2.483 50 GHz  
37.07 dBμV

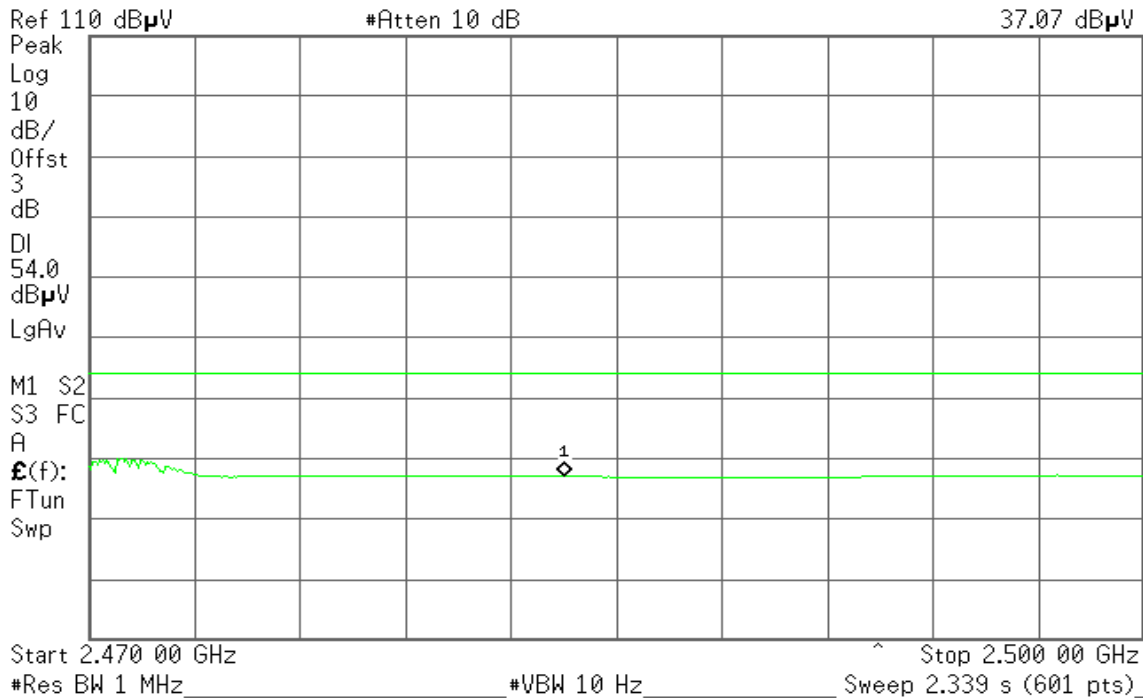



### 7.3 SPURIOUS EMISSION

#### LIMIT

1. In the section 15.249(a):

Except as provided in paragraph (b) of this section, the field strength of emissions from intentional radiators operated within these frequency bands shall comply with the following:

Fundamental Frequency (MHz)	Field Strength of Fundamental Field Strength (mV/m)	Field Strength of Harmonics (µV/m)
902-928 MHz	50	500
2400 - 2483.5 MHz	50	500
5725 - 5875 MHz	50	500
24.0 - 24.25 GHz	250	2500

2. Except as provided elsewhere in this Subpart, the emissions from an intentional radiator shall not exceed the field strength levels specified in the following table:

Frequency (MHz)	Field Strength (µV/m)	Measurement Distance (m)
30-88	100*	3
88-216	150*	3
216-960	200*	3
Above 960	500	3

*Remark: Except as provided in paragraph (g), fundamental emissions from intentional radiators operating under this Section shall not be located in the frequency bands 54-72 MHz, 76-88 MHz, 174-216 MHz or 470-806 MHz. However, operation within these frequency bands is permitted under other sections of this Part, e.g., Sections 15.231 and 15.241.*

3. In the above emission table, the tighter limit applies at the band edges.

Frequency (MHz)	Field Strength (µV/m at 3-meter)	Field Strength (dBµV/m at 3-meter)
30-88	100	40
88-216	150	43.5
216-960	200	46
Above 960	500	54

### Test Configuration

9kHz ~ 30MHz

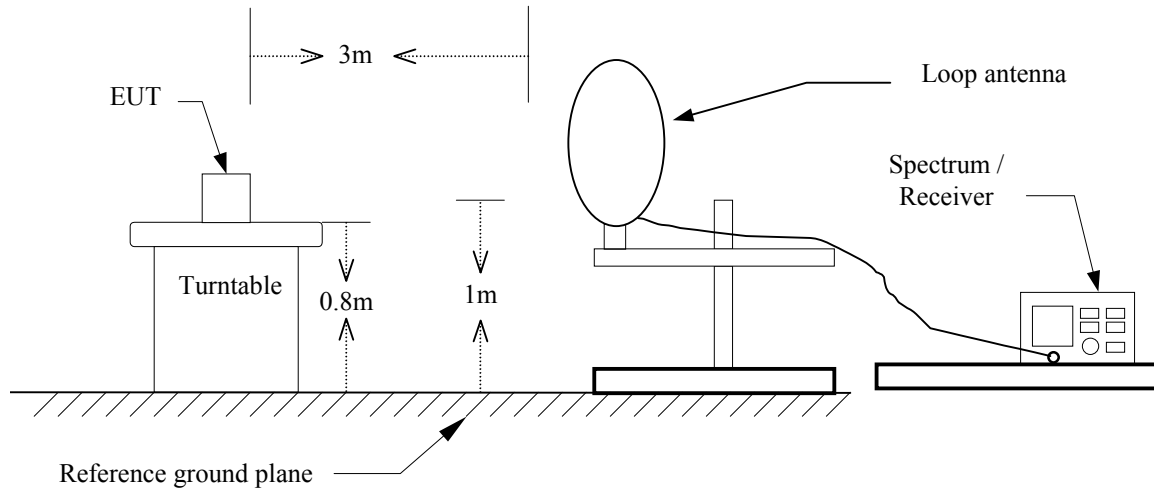

30MHz ~ 1GHz

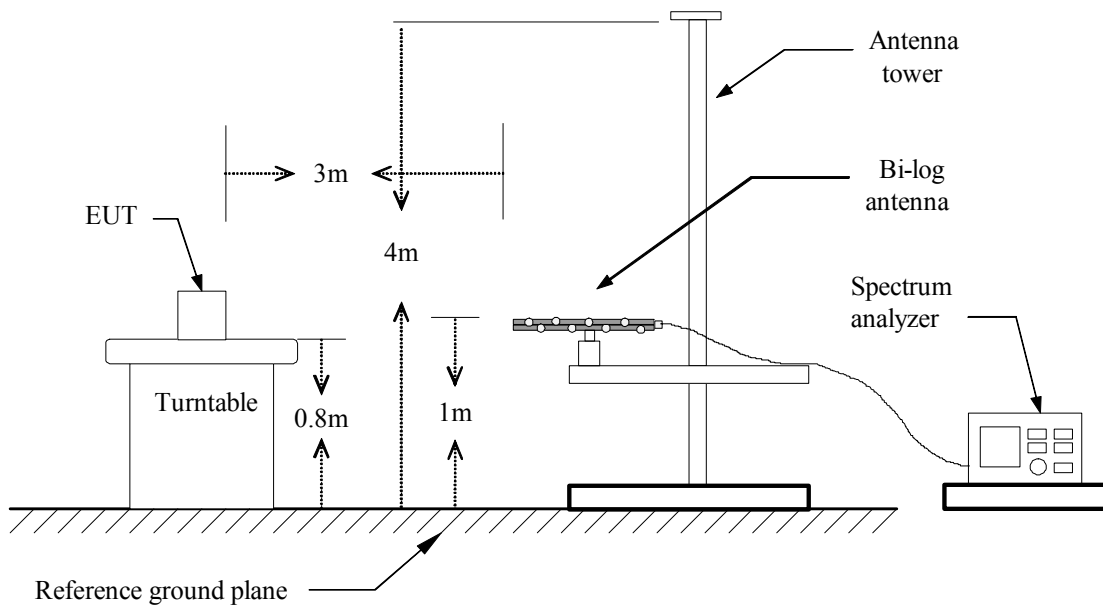

Above 1 GHz

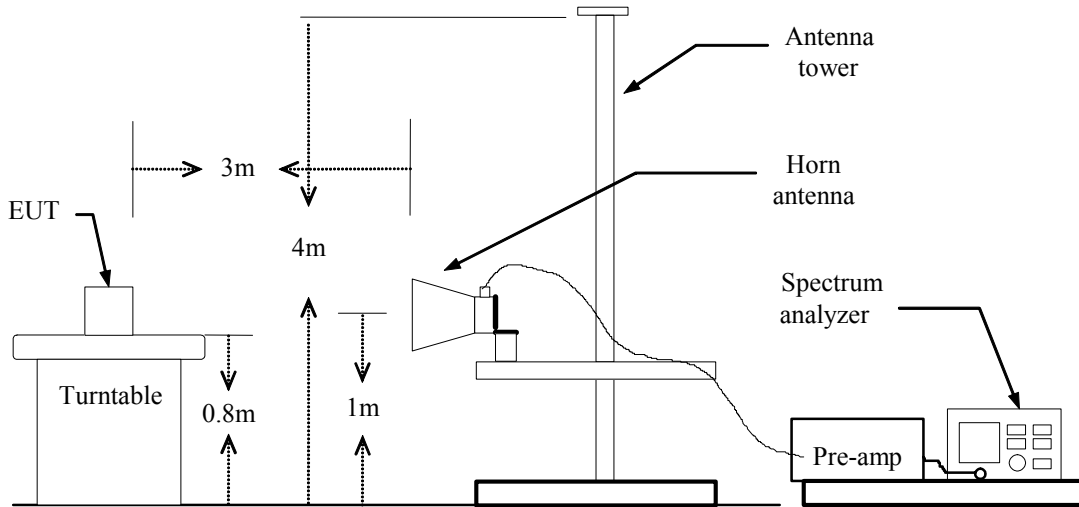



## **TEST PROCEDURE**

1. The EUT is placed on a turntable, which is 0.8m above ground plane.
2. The turntable shall be rotated for 360 degrees to determine the position of maximum emission level.
3. EUT is set 3m away from the receiving antenna, which is varied from 1m to 4m to find out the highest emissions.
4. Maximum procedure was performed on the six highest emissions to ensure EUT compliance.
5. And also, each emission was to be maximized by changing the polarization of receiving antenna both horizontal and vertical.
6. Set the spectrum analyzer in the following setting as:  
Below 1GHz:  
RBW=100kHz / VBW=300kHz / Sweep=AUTO  
Above 1GHz:  
(a) PEAK: RBW=VBW=1MHz / Sweep=AUTO  
(b) AVERAGE: RBW=1MHz / VBW=10Hz / Sweep=AUTO
7. Repeat above procedures until the measurements for all frequencies are complete.

**Below 1 GHz****Operation Mode:** Normal Link**Test Date:** May 19, 2010**Temperature:** 25°C**Tested by:** Mark Yang**Humidity:** 50% RH**Polarity:** Ver. / Hor.

Frequency (MHz)	Ant. Pol. (H/V)	Detector Mode (PK/QP)	Reading (dBuV)	Correction Factor (dB/m)	Result (dBuV/m)	Limit 3m (dBuV/m)	Margin (dB)
296.75	V	Peak	35.81	-9.27	26.54	46.00	-19.46
351.72	V	Peak	31.80	-8.02	23.78	46.00	-22.22
384.05	V	Peak	31.07	-7.40	23.67	46.00	-22.33
405.07	V	Peak	31.16	-6.97	24.20	46.00	-21.80
647.57	V	Peak	30.85	-2.95	27.90	46.00	-18.10
728.40	V	Peak	30.46	-2.13	28.33	46.00	-17.67
348.48	H	Peak	37.53	-8.09	29.45	46.00	-16.55
359.80	H	Peak	37.30	-7.86	29.44	46.00	-16.56
372.73	H	Peak	40.91	-7.61	33.29	46.00	-12.71
384.05	H	Peak	41.85	-7.40	34.46	46.00	-11.54
395.37	H	Peak	38.87	-7.18	31.69	46.00	-14.31
432.55	H	Peak	34.09	-6.29	27.80	46.00	-18.20

**Remark:**

1. No emission found between lowest internal used/generated frequency to 30MHz (9kHz~30MHz).
2. Radiated emissions measured were made with an instrument using peak/quasi-peak detector mode.
3. Quasi-peak test would be performed if the peak result were greater than the quasi-peak limit or as required by the applicant.
4. Measurements above show only up to 6 maximum emissions noted, or would be lesser; with " N/A " remark, if no specific emissions from the EUT are recorded (ie: margin>20dB from the applicable limit) and considered that's already beyond the background noise floor.
5. Margin (dB) = Remark result (dBuV/m) – Quasi-peak limit (dBuV/m).





**Above 1 GHz**

**Operation Mode:** Tx / CH Low

**Test Date:** May 19, 2010

**Temperature:** 25°C

**Tested by:** Mark Yang

**Humidity:** 50% RH

**Polarity:** Ver. / Hor.

Freq. (MHz)	Ant. Pol H/V	Peak Reading (dBuV)	AV Reading (dBuV)	Ant. / CL CF (dB)	Result		Peak Limit (dBuV/m)	AV Limit (dBuV/m)	Margin (dB)	Remark
					Peak (dBuV/m)	AV (dBuV/m)				
2403.33	V	92.64	42.55	-2.95	89.69	39.60	114.00	94.00	-54.4	AVG
1276.67	V	54.61	---	-9.13	45.48	---	74.00	54.00	-8.52	Peak
4808.33	V	60.09	36.90	1.18	61.28	38.08	74.00	54.00	-15.92	AVG
N/A										
2403.33	H	93.62	42.66	-2.95	90.67	39.71	114.00	94.00	-54.29	AVG
1273.33	H	54.88	---	-9.14	45.75	---	74.00	54.00	-8.25	Peak
4808.33	H	59.10	36.73	1.18	60.28	37.91	74.00	54.00	-16.09	AVG
N/A										

**Remark:**

1. Measuring frequencies from 1 GHz to the 10th harmonic of highest fundamental frequency.
2. Radiated emissions measured in frequency above 1000MHz were made with an instrument using peak/average detector mode.
3. Average test would be performed if the peak result were greater than the average limit or as required by the applicant.
4. Data of measurement within this frequency range shown " --- " in the table above means the reading of emissions are attenuated more than 20dB below the permissible limits or the field strength is too small to be measured.
5. Measurements above show only up to 6 maximum emissions noted, or would be lesser; with " N/A " remark, if no specific emissions from the EUT are recorded (ie: margin>20dB from the applicable limit) and considered that's already beyond the background noise floor.
6. Margin (dB) = Remark result (dBuV/m) – Average limit (dBuV/m). Peak detector mode and average detector mode of the emission shown in Result column.



**Operation Mode:** Tx / CH Mid

**Test Date:** May 19, 2010

**Temperature:** 25°C

**Tested by:** Mark Yang

**Humidity:** 50% RH

**Polarity:** Ver. / Hor.

Freq. (MHz)	Ant. Pol H/V	Peak Reading (dBuV)	AV Reading (dBuV)	Ant. / CL CF (dB)	Result		Peak Limit (dBuV/m)	AV Limit (dBuV/m)	Margin (dB)	Remark
					Peak (dBuV/m)	AV (dBuV/m)				
2432.00	V	92.02	42.32	-2.86	89.16	39.46	114.00	94.00	-54.54	AVG
1623.33	V	53.94	---	-7.62	46.32	---	74.00	54.00	-7.68	Peak
4866.67	V	61.94	36.67	1.16	63.10	37.83	74.00	54.00	-16.17	AVG
N/A										
2432.00	H	95.47	42.51	-2.86	92.61	39.65	114.00	94.00	-54.35	AVG
1226.67	H	54.72	---	-9.21	45.51	---	74.00	54.00	-8.49	Peak
4866.67	H	55.67	36.95	1.16	56.83	38.11	74.00	54.00	-15.89	AVG
N/A										

**Remark:**

1. Measuring frequencies from 1 GHz to the 10th harmonic of highest fundamental frequency.
2. Radiated emissions measured in frequency above 1000MHz were made with an instrument using peak/average detector mode.
3. Average test would be performed if the peak result were greater than the average limit or as required by the applicant.
4. Data of measurement within this frequency range shown " --- " in the table above means the reading of emissions are attenuated more than 20dB below the permissible limits or the field strength is too small to be measured.
5. Measurements above show only up to 6 maximum emissions noted, or would be lesser, with " N/A " remark, if no specific emissions from the EUT are recorded (ie: margin > 20dB from the applicable limit) and considered that's already beyond the background noise floor.
6. Margin (dB) = Remark result (dBuV/m) – Average limit (dBuV/m). Peak detector mode and average detector mode of the emission shown in Result column.



Operation Mode: Tx / CH High

Test Date: May 19, 2010

Temperature: 25°C

Tested by: Mark Yang

Humidity: 50% RH

Polarity: Ver. / Hor.

Freq. (MHz)	Ant. Pol H/V	Peak Reading (dBuV)	AV Reading (dBuV)	Ant. / CL CF (dB)	Result		Peak Limit (dBuV/m)	AV Limit (dBuV/m)	Margin (dB)	Remark
					Peak (dBuV/m)	AV (dBuV/m)				
2471.00	V	91.76	42.50	-2.75	89.01	39.75	114.00	94.00	-54.25	AVG
1486.67	V	55.43	---	-8.78	46.65	---	74.00	54.00	-7.35	Peak
4941.67	V	58.30	37.02	1.14	59.44	38.16	74.00	54.00	-15.84	AVG
N/A										
2471.00	H	95.50	42.71	-2.75	92.75	39.96	114.00	94.00	-54.04	AVG
1256.67	H	55.17	---	-9.16	46.00	---	74.00	54.00	-8.00	Peak
4941.67	H	65.18	36.96	1.14	66.32	38.10	74.00	54.00	-15.90	AVG
N/A										

Remark:

1. Measuring frequencies from 1 GHz to the 10th harmonic of highest fundamental frequency.
2. Radiated emissions measured in frequency above 1000MHz were made with an instrument using peak/average detector mode.
3. Average test would be performed if the peak result were greater than the average limit or as required by the applicant.
4. Data of measurement within this frequency range shown " --- " in the table above means the reading of emissions are attenuated more than 20dB below the permissible limits or the field strength is too small to be measured.
5. Measurements above show only up to 6 maximum emissions noted, or would be lesser; with " N/A " remark, if no specific emissions from the EUT are recorded (ie: margin > 20dB from the applicable limit) and considered that's already beyond the background noise floor.
6. Margin (dB) = Remark result (dBuV/m) – Average limit (dBuV/m). Peak detector mode and average detector mode of the emission shown in Result column.



## 7.4 POWERLINE CONDUCTED EMISSIONS

### LIMIT

According to §15.207(a), except as shown in paragraphs (b) and (c) of this section, for an intentional radiator that is designed to be connected to the public utility (AC) power line, the radio frequency voltage that is conducted back onto the AC power line on any frequency or frequencies within the band 150 kHz to 30 MHz shall not exceed the limits in the following table, as measured using a 50  $\mu$ H/50 ohms line impedance stabilization network (LISN). Compliance with the provisions of this paragraph shall be based on the measurement of the radio frequency voltage between each power line and ground at the power terminal. The lower limit applies at the boundary between the frequency ranges.

Frequency Range (MHz)	Limits (dB $\mu$ V)	
	Quasi-peak	Average
0.15 to 0.50	66 to 56*	56 to 46*
0.50 to 5	56	46
5 to 30	60	50

\* Decreases with the logarithm of the frequency.

### Test Configuration

See test photographs attached in Appendix I for the actual connections between EUT and support equipment.

### TEST PROCEDURE

1. The EUT was placed on a table, which is 0.8m above ground plane.
2. Maximum procedure was performed on the six highest emissions to ensure EUT compliance.
3. Repeat above procedures until all frequency measured were complete.



### TEST RESULTS

The initial step in collecting conducted data is a spectrum analyzer peak scan of the measurement range. Significant peaks are then marked as shown on the following data page, and these signals are then quasi-peaked.

#### Test Data

Operation Mode: Normal Link

Test Date: 2010/4/29

Temperature: 26°C

Tested by: Lawrence Lee

Humidity: 60% RH

Freq. (MHz)	QP Reading (dBuV)	AV Reading (dBuV)	Corr. factor (dB)	QP Result (dBuV)	AV Result (dBuV)	QP Limit (dBuV)	AV Limit (dBuV)	QP Margin (dB)	AV Margin (dB)	Note
0.1700	52.60	44.10	0.20	52.80	44.30	64.96	54.96	-12.16	-10.66	L1
0.2250	46.03	37.53	0.17	46.20	37.70	62.63	52.63	-16.43	-14.93	L1
0.2850	41.05	33.85	0.15	41.20	34.00	60.67	50.67	-19.47	-16.67	L1
0.3400	37.88	30.78	0.12	38.00	30.90	59.20	49.20	-21.20	-18.30	L1
3.4200	32.30	18.20	0.10	32.40	18.30	56.00	46.00	-23.60	-27.70	L1
3.8700	41.49	28.09	0.11	41.60	28.20	56.00	46.00	-14.40	-17.80	L1
0.1700	51.97	43.27	0.23	52.20	43.50	64.96	54.96	-12.76	-11.46	L2
0.2250	43.41	36.41	0.19	43.60	36.60	62.63	52.63	-19.03	-16.03	L2
0.2850	38.93	32.33	0.17	39.10	32.50	60.67	50.67	-21.57	-18.17	L2
0.3400	34.66	29.56	0.14	34.80	29.70	59.20	49.20	-24.40	-19.50	L2
1.9900	34.32	29.22	0.08	34.40	29.30	56.00	46.00	-21.60	-16.70	L2
3.8600	43.35	31.15	0.15	43.50	31.30	56.00	46.00	-12.50	-14.70	L2

#### Remark:

1. Measuring frequencies from 0.15 MHz to 30MHz.
2. The emissions measured in frequency range from 0.15 MHz to 30MHz were made with an instrument using Quasi-peak detector and average detector.
3. The IF bandwidth of SPN between 0.15MHz to 30MHz was 10kHz; the IF bandwidth of Test Receiver between 0.15MHz to 30MHz was 9kHz;
4. L1 = Line One (Live Line) / L2 = Line Two (Neutral Line)
5. "-" means Quasi-peak reading value also meets average limit and measurement with the average detector is unnecessary.



**Test Plots**

**Conducted emissions (Line 1)**

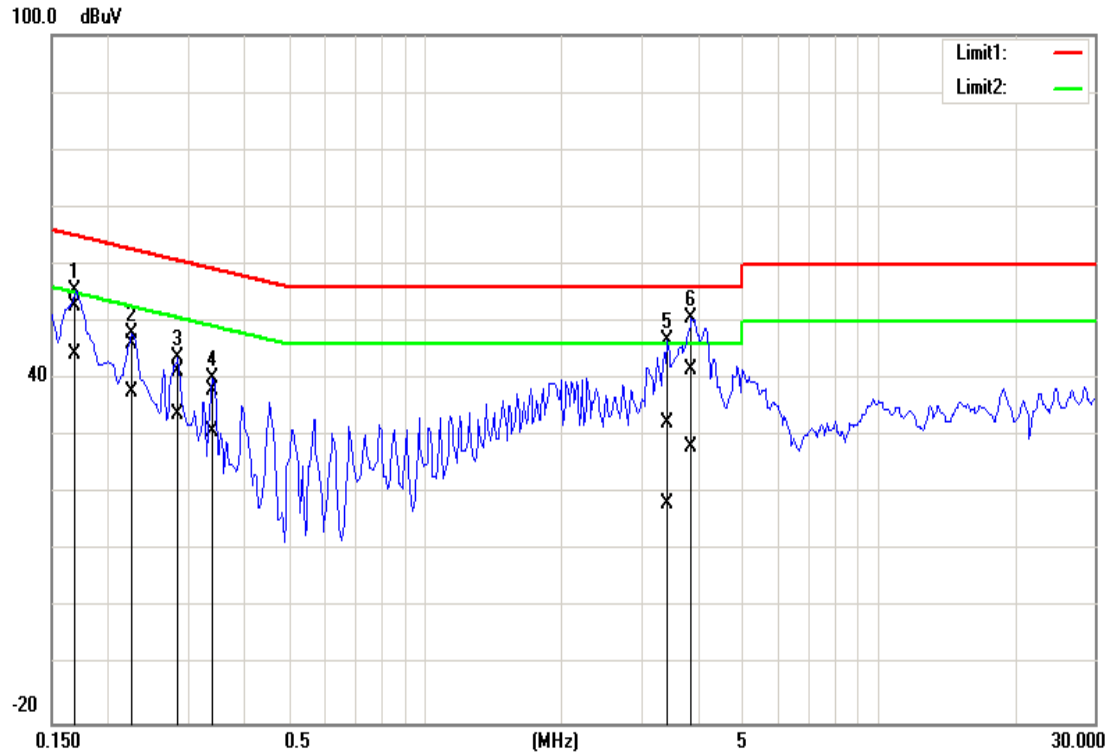

**Conducted emissions (Line 2)**

