



FCC ID: PRDMU90
Report No.: T200901D14-A-RP

IC: 6180A-GPC

Page: 1 / 45
Rev.: 02

FCC 47 CFR PART 15 SUBPART C

&

INDUSTRY CANADA RSS-210

TEST REPORT

For

Wireless mouse

Model: AA-MR1D5

Trade Name: SAMSUNG

Issued to

Acrox Technologies Co. Ltd.
4F., No.89, Minshan St., Neihu Dist., Taipei 114 Taiwan, R.O.C.

Issued by

Compliance Certification Services Inc.
Wugu Laboratory
No.11, Wugong 6th Rd., Wugu Dist.,
New Taipei City, Taiwan. (R.O.C.)
Issued Date: December 9, 2020

Unless otherwise stated the results shown in this test report refer only to the sample(s) tested and such sample(s) are retained for 90 days only.
除非另有說明，此報告結果僅對測試之樣品負責，同時此樣品僅保留90天。本報告未經本公司書面許可，不可部份複製。

This document is issued by the Company subject to its General Conditions of Service printed overleaf, available on request or accessible at <http://www.sgs.com.tw/Terms-and-Conditions> and, for electronic format documents, subject to Terms and Conditions for Electronic Documents at <http://www.sgs.com.tw/Terms-and-Conditions>. Attention is drawn to the limitation of liability, indemnification and jurisdiction issues defined therein. Any holder of this document is advised that information contained hereon reflects the Company's findings at the time of its intervention only and within the limits of client's instruction, if any. The Company's sole responsibility is to its Client and this document does not exonerate parties to a transaction from exercising all their rights and obligations under the transaction documents. This document cannot be reproduced, except in full, without prior written approval of the Company. Any unauthorized alteration, forgery or falsification of the content or appearance of this document is unlawful and offenders may be prosecuted to the fullest extent of the law.

Revision History

Rev.	Issue Date	Revisions	Effect Page	Revised By
00	November 3, 2020	Initial Issue	ALL	Allison Chen
01	November 20, 2020	See the following Note Rev.(01)	P.5-6, P.10-11, P.15-17, P.24	Allison Chen
02	December 9, 2020	See the following Note Rev.(02)	P.5, P.41-45, A-2	Allison Chen

Note:

Rev.(01)

1. Added channel frequency table in section 3.
2. Added ISED Restricted bands of operations in section 4.4.
3. Remove Receiver ID in section 7.2 and conducted test data.
4. Modify Harmonic Limit for peak at 3m and IC Limit table in section 8.1.
5. Modify title and IC Limit table in section 8.2.

Rev.(02)

1. Added 20dB Bandwidth & OBW 99% test data and photo in section 2 & 8.4.
2. Added “—End of Test Report —”.

Report No.: T200901D14-A-RP

TABLE OF CONTENTS

1. TEST RESULT CERTIFICATION	4
2. TEST SUMMARY	5
3. EUT DESCRIPTION.....	6
4. TEST METHODOLOGY.....	7
4.1 EUT CONFIGURATION	7
4.2 DESCRIPTION OF TEST MODES.....	7
4.3 THE WORST MODE OF MEASUREMENT	8
4.4 FCC PART 15.205 & RSS GEN SECTION 8.10 RESTRICTED BANDS OF OPERATIONS.....	9
5. INSTRUMENT CALIBRATION	12
5.1 MEASURING INSTRUMENT CALIBRATION	12
5.2 MEASUREMENT EQUIPMENT USED	12
5.3 MEASUREMENT UNCERTAINTY	13
6. FACILITIES AND ACCREDITATIONS	14
6.1 FACILITIES	14
6.2 EQUIPMENT	14
7. SETUP OF EQUIPMENT UNDER TEST	15
7.1 SETUP CONFIGURATION OF EUT	15
7.2 SUPPORT EQUIPMENT.....	15
8. FCC PART 15.249 & RSS-210 REQUIREMENTS	16
8.1 BAND EDGES AND FUNDAMENTAL MEASUREMENT	16
8.2 RADIATED EMISSION.....	24
8.3 POWERLINE CONDUCTED EMISSIONS	39
8.4 20DB BANDWIDTH AND OCCUPIED BANDWIDTH(99%)	41
APPENDIX A PHOTOGRAPHS OF TEST SETUP	A-1
APPENDIX 1 - PHOTOGRAPHS OF EUT	

Report No.: T200901D14-A-RP

1. TEST RESULT CERTIFICATION

Applicant: Acrox Technologies Co. Ltd.
4F., No.89, Minshan St., Neihu Dist., Taipei 114 Taiwan,
R.O.C.

Manufacturer: Acrox Technologies Co. Ltd.
4F., No.89, Minshan St., Neihu Dist., Taipei 114 Taiwan,
R.O.C.

Equipment Under Test: Wireless mouse

Trade Name: SAMSUNG

Model Number: AA-MR1D5

Date of Test: September 23 ~ October 5, 2020

APPLICABLE STANDARDS	
STANDARD	TEST RESULT
FCC 47 CFR Part 15 Subpart C & RSS-210 Issue 10	No non-compliance noted
Statements of Conformity	
Determination of compliance is based on the results of the compliance measurement, not taking into account measurement instrumentation uncertainty.	

We hereby certify that:

The test Result was tested by Compliance Certification Services Inc. The test data, data evaluation, test procedures, and equipment configurations shown in this report were given in ANSI C63.10: 2013 and compliance standards.

The test results of this report relate only to the tested sample (EUT) identified in this report. The test Report of full or partial shall not copy. Without written approval of CCS. Inc. The sample selected for test was production product and was provided by manufacturer.

Approved by:



Kevin Tsai
Deputy Manager
Compliance Certification Services Inc.

2. TEST SUMMARY

FCC Standard Section	IC Standard Section	Report Section	Test Item	Result
15.203	RSS-GEN §8.3	3	Antenna Requirement	Pass
15.209 15.249(a)	RSS-210 §B.10	8.1	Band Edge and Fundamental measurement	Pass
15.249(a)	RSS-210 §B.10	8.2	Radiated emission	Pass
15.207(a)	RSS-GEN §8.8	8.3	Powerline Conducted Emission	N/A
2.1049	-	8.4	20dB Bandwidth	Pass
-	RSS-GEN §6.6	8.4	Occupied Bandwidth (99%)	Pass

Report No.: T200901D14-A-RP

3. EUT DESCRIPTION

Product	Wireless mouse																																																																												
Trade Name	SAMSUNG																																																																												
Model Number	AA-MR1D5																																																																												
Model Discrepancy	N/A																																																																												
Received Date	September 1, 2020																																																																												
Power Supply	Power from battery.																																																																												
Modulation Technique	GFSK																																																																												
Antenna Specification	PCB Antenna / Gain: -1.5561dBi																																																																												
Frequency Range	<table border="1"> <thead> <tr> <th colspan="4">2408 ~ 2474MHz</th> </tr> <tr> <th>Channel</th> <th>Frequency (MHz)</th> <th>Channel</th> <th>Frequency (MHz)</th> </tr> </thead> <tbody> <tr><td>1</td><td>2408</td><td>18</td><td>2442</td></tr> <tr><td>2</td><td>2410</td><td>19</td><td>2444</td></tr> <tr><td>3</td><td>2412</td><td>20</td><td>2446</td></tr> <tr><td>4</td><td>2414</td><td>21</td><td>2448</td></tr> <tr><td>5</td><td>2416</td><td>22</td><td>2450</td></tr> <tr><td>6</td><td>2418</td><td>23</td><td>2452</td></tr> <tr><td>7</td><td>2420</td><td>24</td><td>2454</td></tr> <tr><td>8</td><td>2422</td><td>25</td><td>2456</td></tr> <tr><td>9</td><td>2424</td><td>26</td><td>2458</td></tr> <tr><td>10</td><td>2426</td><td>27</td><td>2460</td></tr> <tr><td>11</td><td>2428</td><td>28</td><td>2462</td></tr> <tr><td>12</td><td>2430</td><td>29</td><td>2464</td></tr> <tr><td>13</td><td>2432</td><td>30</td><td>2466</td></tr> <tr><td>14</td><td>2434</td><td>31</td><td>2468</td></tr> <tr><td>15</td><td>2436</td><td>32</td><td>2470</td></tr> <tr><td>16</td><td>2438</td><td>33</td><td>2472</td></tr> <tr><td>17</td><td>2440</td><td>34</td><td>2474</td></tr> </tbody> </table>	2408 ~ 2474MHz				Channel	Frequency (MHz)	Channel	Frequency (MHz)	1	2408	18	2442	2	2410	19	2444	3	2412	20	2446	4	2414	21	2448	5	2416	22	2450	6	2418	23	2452	7	2420	24	2454	8	2422	25	2456	9	2424	26	2458	10	2426	27	2460	11	2428	28	2462	12	2430	29	2464	13	2432	30	2466	14	2434	31	2468	15	2436	32	2470	16	2438	33	2472	17	2440	34	2474
2408 ~ 2474MHz																																																																													
Channel	Frequency (MHz)	Channel	Frequency (MHz)																																																																										
1	2408	18	2442																																																																										
2	2410	19	2444																																																																										
3	2412	20	2446																																																																										
4	2414	21	2448																																																																										
5	2416	22	2450																																																																										
6	2418	23	2452																																																																										
7	2420	24	2454																																																																										
8	2422	25	2456																																																																										
9	2424	26	2458																																																																										
10	2426	27	2460																																																																										
11	2428	28	2462																																																																										
12	2430	29	2464																																																																										
13	2432	30	2466																																																																										
14	2434	31	2468																																																																										
15	2436	32	2470																																																																										
16	2438	33	2472																																																																										
17	2440	34	2474																																																																										
H/W Version	V1.0																																																																												
S/W Version	V1.0																																																																												
EUT serial #	CN57BA9607416BDV8JN8H0009																																																																												

Remark:

1. The sample selected for test was production product and was provided by manufacturer.
2. Disclaimer: Antenna information is provided by the applicant, test results of this report are applicable to the sample EUT received.

Report No.: T200901D14-A-RP

4. TEST METHODOLOGY

The test methodology, setups and results comply with all requirements in accordance with ANSI C63.10:2013, FCC Part 2, FCC Part 15.249.

The tests documented in this report were performed in accordance with IC RSS-210, IC RSS-Gen, IC RSS-102, IC RSS-212, and ANSI C63.10:2013

This submittal(s) (test report) is intended for IC Certification with Industry Canada RSS-210.

4.1 EUT CONFIGURATION

The EUT configuration for testing is installed on RF field strength measurement to meet the Commissions requirement and operating in a manner that intends to maximize its emission characteristics in a continuous normal application.

4.2 DESCRIPTION OF TEST MODES

The EUT (model: AA-MR1D5) had been tested under operating condition.

Channel Low (2408MHz), Channel Mid (2440MHz), Channel High (2474MHz) were chosen for full testing.

Report No.: T200901D14-A-RP

4.3 THE WORST MODE OF MEASUREMENT

Radiated Emission Measurement Above 1G	
Test Condition	Radiated Emission Above 1G
Power supply Mode	Mode 1: EUT power by Battery
Worst Mode	<input checked="" type="checkbox"/> Mode 1 <input type="checkbox"/> Mode 2 <input type="checkbox"/> Mode 3 <input type="checkbox"/> Mode 4
Worst Position	<input type="checkbox"/> Placed in fixed position.
	<input checked="" type="checkbox"/> Placed in fixed position at X-Plane (E2-Plane)

Radiated Emission Measurement Below 1G	
Test Condition	Radiated Emission Below 1G
Power supply Mode	Mode 1: EUT power by Battery
Worst Mode	<input checked="" type="checkbox"/> Mode 1 <input type="checkbox"/> Mode 2 <input type="checkbox"/> Mode 3 <input type="checkbox"/> Mode 4

Remark:

1. The worst mode was record in this test report.
2. EUT pre-scanned in axis X and two polarity, for radiated measurement. The worst case(X-Plane) were recorded in this report

Report No.: T200901D14-A-RP

4.4 FCC PART 15.205 & RSS GEN SECTION 8.10 RESTRICTED BANDS OF OPERATIONS

According to §15.205 Restricted bands of operation,

- (a) Except as shown in paragraph (d) of this section, only spurious emissions are permitted in any of the frequency bands listed below:

MHz	MHz	MHz	GHz
0.090 - 0.110	16.42 - 16.423	399.9 - 410	4.5 - 5.15
¹ 0.495 - 0.505	16.69475 - 16.69525	608 - 614	5.35 - 5.46
2.1735 - 2.1905	16.80425 - 16.80475	960 - 1240	7.25 - 7.75
4.125 - 4.128	25.5 - 25.67	1300 - 1427	8.025 - 8.5
4.17725 - 4.17775	37.5 - 38.25	1435 - 1626.5	9.0 - 9.2
4.20725 - 4.20775	73 - 74.6	1645.5 - 1646.5	9.3 - 9.5
6.215 - 6.218	74.8 - 75.2	1660 - 1710	10.6 - 12.7
6.26775 - 6.26825	108 - 121.94	1718.8 - 1722.2	13.25 - 13.4
6.31175 - 6.31225	123 - 138	2200 - 2300	14.47 - 14.5
8.291 - 8.294	149.9 - 150.05	2310 - 2390	15.35 - 16.2
8.362 - 8.366	156.52475 -	2483.5 - 2500	17.7 - 21.4
8.37625 - 8.38675	156.52525	2655 - 2900	22.01 - 23.12
8.41425 - 8.41475	156.7 - 156.9	3260 - 3267	23.6 - 24.0
12.29 - 12.293	162.0125 - 167.17	3332 - 3339	31.2 - 31.8
12.51975 - 12.52025	167.72 - 173.2	3345.8 - 3358	36.43 - 36.5
12.57675 - 12.57725	240 - 285	3600 - 4400	(²)
13.36 - 13.41	322 - 335.4		

¹ Until February 1, 1999, this restricted band shall be 0.490-0.510 MHz.

² Above 38.6

- (b) Except as provided in paragraphs (d) and (e), the field strength of emissions appearing within these frequency bands shall not exceed the limits shown in Section 15.209. At frequencies equal to or less than 1000 MHz, compliance with the limits in Section 15.209 shall be demonstrated using measurement instrumentation employing a CISPR quasi-peak detector. Above 1000 MHz, compliance with the emission limits in Section 15.209 shall be demonstrated based on the average value of the measured emissions. The provisions in Section 15.35 apply to these measurements.

According to RSS-GEN section 8.10 Restricted bands of operation,

Restricted frequency bands, identified in table 7, are designated primarily for safety-of-life services (distress calling and certain aeronautical activities), certain satellite downlinks, radio astronomy and some government uses. Except where otherwise indicated, the following conditions related to the restricted frequency bands apply:

- (a) The transmit frequency, including fundamental components of modulation, of licence-exempt radio apparatus shall not fall within the restricted frequency bands listed in table 7 except for apparatus compliant with RSS-287, Emergency Position Indicating Radio Beacons (EPIRB), Emergency Locator Transmitters (ELT), Personal Locator Beacons (PLB), and Maritime Survivor Locator Devices (MSLD).
- (b) Unwanted emissions that fall into restricted frequency bands listed in table 7 shall comply with the limits specified in table 5 and table 6.
- (c) Unwanted emissions that do not fall within the restricted frequency bands listed in table 7 shall comply either with the limits specified in the applicable RSS or with those specified in table 5 and table 6.

Table 7 – Restricted frequency bands ^{Note 1}		
MHz	MHz	GHz
0.090 - 0.110	149.9 - 150.05	9.0 - 9.2
0.495 - 0.505	156.52475 - 156.52525	9.3 - 9.5
2.1735 - 2.1905	156.7 - 156.9	10.6 - 12.7
3.020 - 3.026	162.0125 - 167.17	13.25 - 13.4
4.125 - 4.128	167.72 - 173.2	14.47 - 14.5
4.17725 - 4.17775	240 – 285	15.35 - 16.2
4.20725 - 4.20775	322 - 335.4	17.7 - 21.4
5.677 - 5.683	399.9 - 410	22.01 - 23.12
6.215 - 6.218	608 - 614	23.6 - 24.0
6.26775 - 6.26825	960 - 1427	31.2 - 31.8
6.31175 - 6.31225	1435 - 1626.5	36.43 - 36.5
8.291 - 8.294	1645.5 - 1646.5	Above 38.6
8.362 - 8.366	1660 - 1710	
8.37625 - 8.38675	1718.8 - 1722.2	
8.41425 - 8.41475	2200 - 2300	
12.29 - 12.293	2310 - 2390	
12.51975 - 12.52025	2483.5 - 2500	
12.57675 - 12.57725	2655 - 2900	
13.36 - 13.41	3260 – 3267	
16.42 - 16.423	3332 - 3339	
16.69475 - 16.69525	3345.8 - 3358	
16.80425 - 16.80475	3500 - 4400	
25.5 - 25.67	4500 - 5150	
37.5 - 38.25	5350 - 5460	
73 - 74.6	7250 - 7750	
74.8 - 75.2	8025 – 8500	
108 – 138		

Note 1: Certain frequency bands listed in table 7 and in bands above 38.6 GHz are designated for licence-exempt applications. These frequency bands and the requirements that apply to related devices are set out in the 200 and 300 series of RSSs.

Report No.: T200901D14-A-RP

5. INSTRUMENT CALIBRATION

5.1 MEASURING INSTRUMENT CALIBRATION

The measuring equipment, which was utilized in performing the tests documented herein, has been calibrated in accordance with the manufacturer's recommendations for utilizing calibration equipment, which is traceable to recognized national standards.

5.2 MEASUREMENT EQUIPMENT USED

Equipment Used for Emissions Measurement

Wugu 966A Chamber (Radiated Wi-Fi 2.4GHz)					
Name of Equipment	Manufacturer	Model	Serial Number	Calibration Date	Calibration Due
Band Reject Filters	MICRO TRONICS	BRM 50702	120	02/25/2020	02/24/2021
Bilog Antenna	Sunol Sciences	JB3	A030105	07/24/2020	07/23/2021
Coaxial Cable	HUBER SUHNER	SUCOFLEX 104PEA	20995	02/25/2020	02/24/2021
Coaxial Cable	EMCI	EMC105	190914+25111	09/19/2020	09/19/2021
Digital Thermo-Hygro Meter	WISEWIND	1206	D07	01/15/2020	01/14/2021
Horn Antenna	ETS LINDGREN	3117	W3010227	07/22/2020	07/21/2021
Loop Ant	COM-POWER	AL-130	121051	03/27/2020	03/26/2021
Pre-Amplifier	EMEC	EM330	060609	02/25/2020	02/24/2021
Pre-Amplifier	HP	8449B	3008A00965	02/25/2020	02/24/2021
PSA Series Spectrum Analyzer	Agilent	E4446A	MY46180323	07/24/2020	07/23/2021
Antenna Tower	CCS	CC-A-1F	N/A	N.C.R	N.C.R
Controller	CCS	CC-C-1F	N/A	N.C.R	N.C.R
Turn Table	CCS	CC-T-1F	N/A	N.C.R	N.C.R
Software	e3 6.11-20180413				

RF Conducted Test Site					
Name of Equipment	Manufacturer	Model	Serial Number	Calibration Date	Calibration Due
Coaxial Cable	Woken	WC12	CC003	06/29/2020	06/28/2021
Power Meter	Anritsu	ML2487A	6K00003260	05/21/2020	05/20/2021
Power Seneor	Anritsu	MA2490A	032910	05/21/2020	05/20/2021
Signal Analyzer	R&S	FSV 40	101073	09/16/2020	09/15/2021
Thermostatic/Humidity Chamber	TAICHY	MHG-150LF	930619	10/04/2019	10/03/2020
Software	N/A				

Remark:

1. Each piece of equipment is scheduled for calibration once a year.
2. N.C.R. = No Calibration Request.

Report No.: T200901D14-A-RP

5.3 MEASUREMENT UNCERTAINTY

PARAMETER	UNCERTAINTY
AC Powerline Conducted Emission	+/- 1.2575
Emission bandwidth, 20dB bandwidth	+/- 0.0014
RF output power, conducted	+/- 1.14
Power density, conducted	+/- 1.40
3M Semi Anechoic Chamber / 30M~200M	+/- 4.12
3M Semi Anechoic Chamber / 200M~1000M	+/- 4.68
3M Semi Anechoic Chamber / 1G~8G	+/- 5.18
3M Semi Anechoic Chamber / 8G~18G	+/- 5.47
3M Semi Anechoic Chamber / 18G~26G	+/- 3.81
3M Semi Anechoic Chamber / 26G~40G	+/- 3.87

Remark:

- 1.This uncertainty represents an expanded uncertainty expressed at approximately the 95% confidence level using a coverage factor of k=2
2. ISO/IEC 17025 requires that an estimate of the measurement uncertainties associated with the emissions test results be included in the report.

Report No.: T200901D14-A-RP

6. FACILITIES AND ACCREDITATIONS

6.1 FACILITIES

All measurement facilities used to collect the measurement data are located at

No.199, Chunghsen Road, Hsintien City, Taipei Hsien, Taiwan, R.O.C.

Tel: 886-2-2217-0894 / Fax: 886-2-2217-1029

No.11, Wugong 6th Rd., Wugu Dist., New Taipei City 24891, Taiwan. (R.O.C.)

Tel: 886-2-2299-9720 / Fax: 886-2-2299-9721

The sites are constructed in conformance with the requirements of ANSI C63.7, ANSI C63.4 and CISPR Publication 22.

6.2 EQUIPMENT

Radiated emissions are measured with one or more of the following types of linearly polarized antennas: tuned dipole, biconical, log periodic, bi-log, and/or ridged waveguide, horn. Spectrum analyzers with pre-selectors and quasi-peak detectors are used to perform radiated measurements.

Conducted emissions are measured with Line Impedance Stabilization Networks and EMI Test Receivers.

Calibrated wideband preamplifiers, coaxial cables, and coaxial attenuators are also used for making measurements.

All receiving equipment conforms to CISPR Publication 16-1, "Radio Interference Measuring Apparatus and Measurement Methods."

Report No.: T200901D14-A-RP

7. SETUP OF EQUIPMENT UNDER TEST

7.1 SETUP CONFIGURATION OF EUT

See test photographs attached in Appendix I for the actual connections between EUT and support equipment.

7.2 SUPPORT EQUIPMENT

No.	Device Type	Brand	Model	Series No.	FCC ID	Data Cable	Power Cord
1.	NB(L)	Toshiba	PORTEGE R30-A	N/A	PD97260H	N/A	N/A
2	Receiver	SAMSUNG	AA-RR1N0	N/A	N/A	N/A	N/A

Remark:

1. All the above equipment/cables were placed in worse case positions to maximize emission signals during emission test.
2. Grounding was established in accordance with the manufacturer's requirements and conditions for the intended use.

Report No.: T200901D14-A-RP

8. FCC PART 15.249 & RSS-210 REQUIREMENTS

8.1 BAND EDGES AND FUNDAMENTAL MEASUREMENT

LIMIT

According to §15.209, §15.249(a)
According to RSS 210 B.10

(1) The field strength of emissions from intentional radiators operated within these frequency bands shall comply with the following:

Fundamental frequency (MHz)	Field strength of fundamental (millivolts/meter)	Field strength of harmonics (microvolts/meter)
2400-2483.5	50	500
5725-5875	50	500
24000-24250	250	2500

* Field strength limits are specified at a distance of 3 meters

Fundamental Limit Conversion		
Average (mV/m) at 3M	Average (dBuV/m) at 3M	Peak (dBuV/m) at 3M
50	93.98	113.98

Harmonic Limit Conversion		
Average (uV/m) at 3M	Average (dBuV/m) at 3M	Peak (dBuV/m) at 3M
500	53.97	73.97

*(Limit=20LOG(500)=53.79 dBuV/m)

Report No.: T200901D14-A-RP

According to §15.209, §15.249(a)

(2) Emissions radiated outside of the specified frequency bands, except for harmonics, shall be attenuated by at least 50 dB below the level of the fundamental or to the general radiated emission limits in §15.209(follow the table), whichever is the lesser attenuation

Below 30 MHz

Frequency	Field strength (microvolts/meter)	Measurement distance (meters)
9-490 kHz	2,400/F (F in kHz)	300
490-1,705 kHz	24,000/F (F in kHz)	30
1.705-30 MHz	30	30

Above 30 MHz

Frequency	Field strength (microvolts/meter)	Measurement distance (meters)
30-88	100	3
88-216	150	3
216-960	200	3
Above 960	500	3

According to RSS 210 B.10

Below 30 MHz

Frequency	Magnetic field strength (H-Field) (µA/m)	Measurement distance (m)
9-490 kHz ^{Note 1}	6.37/F (F in kHz)	300
490-1,705 kHz	63.7/F (F in kHz)	30
1.705-30 MHz	0.08	30

Note 1: The emission limits for the ranges 9-90 kHz and 110-490 kHz are based on measurements employing a linear average detector.

Above 30 MHz

Frequency	Field strength (µV/m at 3 m)	Measurement distance (m)
30-88	100	3
88-216	150	3
216-960	200	3
Above 960	500	3

Report No.: T200901D14-A-RP

Test Configuration

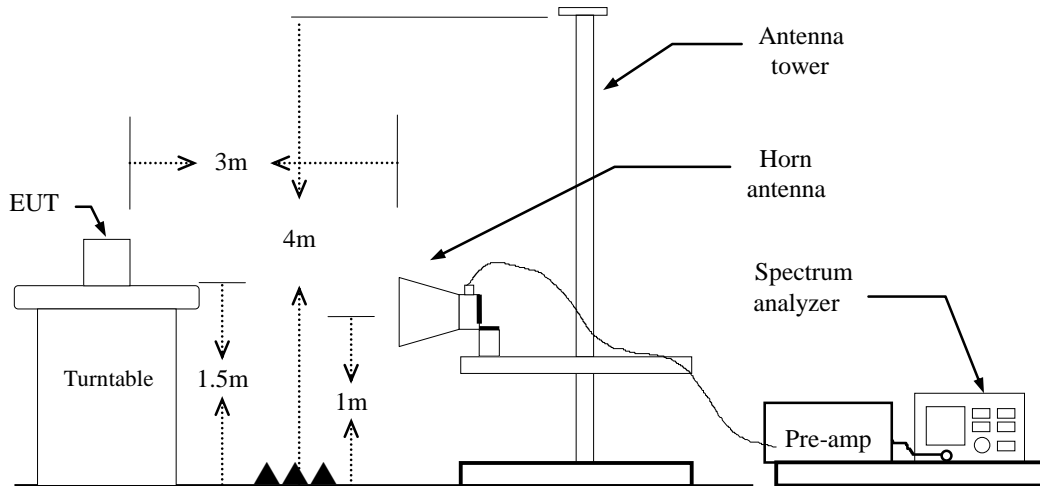

Report No.: T200901D14-A-RP

TEST PROCEDURE

1. The EUT is placed on a turntable, which is 1.5m above the ground plane.
2. The turntable shall be rotated for 360 degrees to determine the position of maximum emission level.
3. EUT is set 3m away from the receiving antenna, which is varied from 1m to 4m to find out the highest emission.
4. Set the spectrum analyzer in the following setting in order to capture the lower and upper band-edges of the emission:
 - (a) PEAK: RBW=1MHz / VBW=3MHz / Sweep=AUTO
 - (b) AVERAGE: RBW=1MHz,
if duty cycle $\geq 98\%$, VBW=10Hz.
if duty cycle $< 98\%$ VBW=1/T.

About Test :

SRD mode: = 49.32%, VBW= 1kHz

5. Repeat the procedures until all the PEAK and AVERAGE versus POLARIZATION are measured.
6. Result = Spectrum Reading + cable loss(spectrum to Amp) - Amp Gain + Cable loss(Amp to receive Ant)+ Receive Ant

DUTY CYCLE

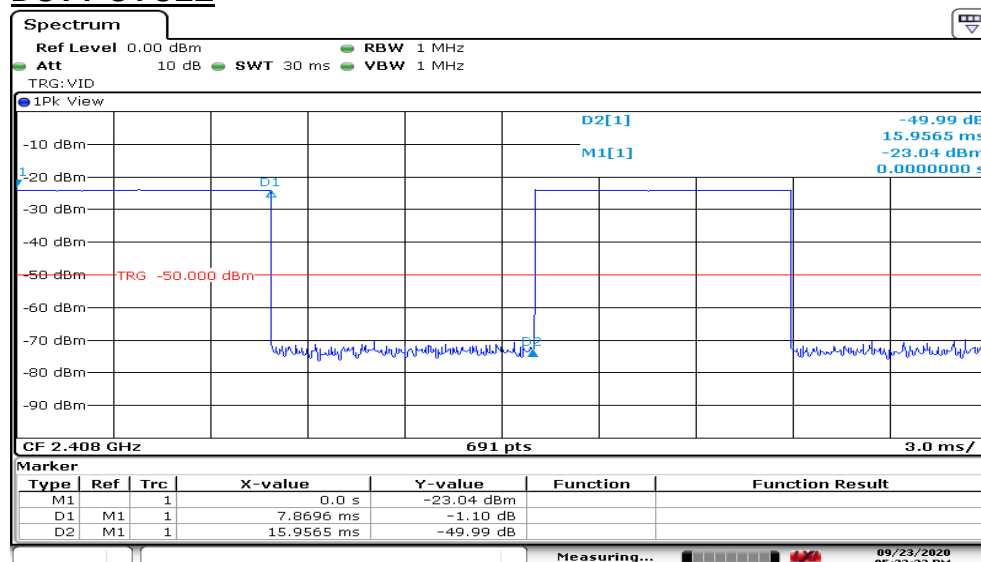

TEST RESULTS

Refer to attach spectrum analyzer data chart.

Report No.: T200901D14-A-RP

Test Mode	Mode 1: Low CH	Temp/Hum	22.4(°C)/ 62%RH
Test Item	Band Edge	Test Date	October 5, 2020
Polarize	Vertical	Test Engineer	Ray Li
Detector	Peak / Average		

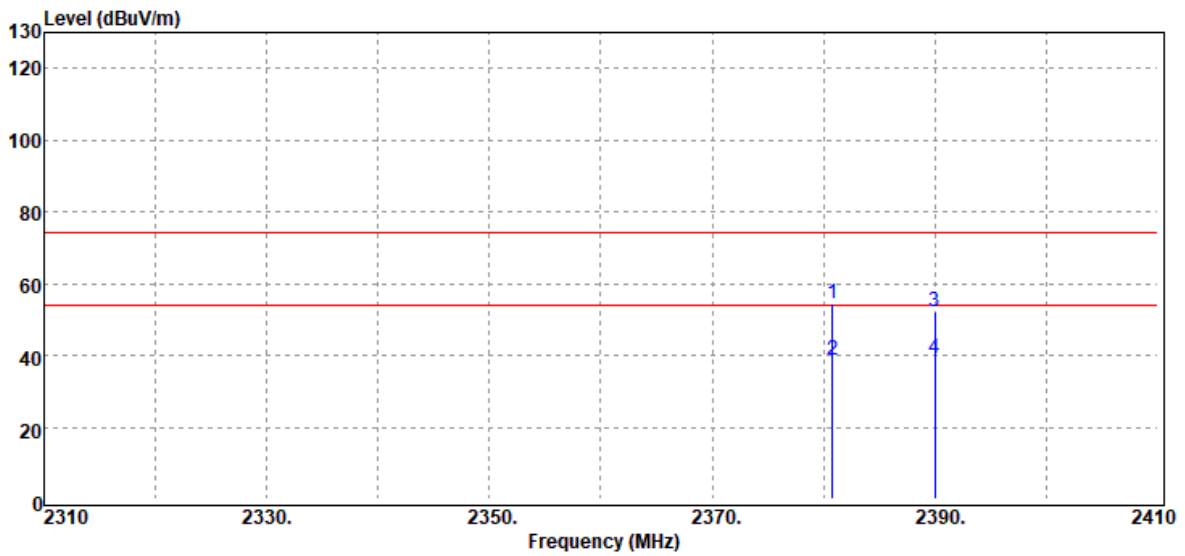

Frequency (MHz)	Detector Mode (PK/QP/AV)	Spectrum Reading Level (dB μ V)	Factor (dB)	Actual FS (dB μ V/m)	Limit @3m (dB μ V/m)	Margin (dB)
2380.80	Peak	53.02	1.22	54.24	74.00	-19.76
2380.80	Average	37.35	1.22	38.57	54.00	-15.43
2390.00	Peak	50.96	1.25	52.21	74.00	-21.79
2390.00	Average	37.93	1.25	39.18	54.00	-14.82

Report No.: T200901D14-A-RP

Test Mode	Mode 1: Low CH	Temp/Hum	22.4(°C)/ 62%RH
Test Item	Band Edge	Test Date	October 5, 2020
Polarize	Horizontal	Test Engineer	Ray Li
Detector	Peak / Average		

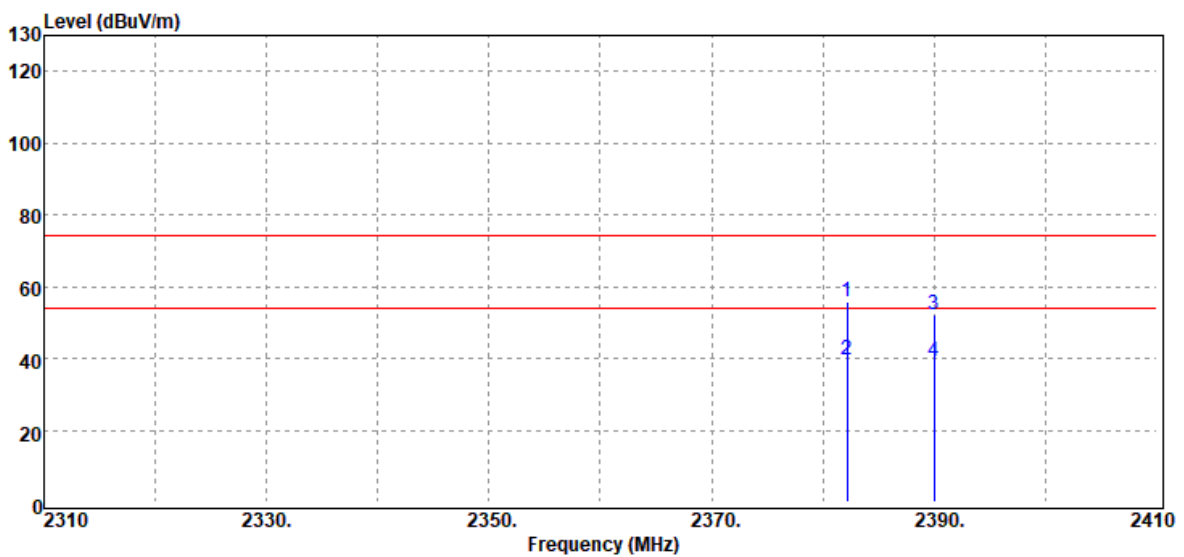

Frequency (MHz)	Detector Mode (PK/QP/AV)	Spectrum Reading Level (dB μ V)	Factor (dB)	Actual FS (dB μ V/m)	Limit @3m (dB μ V/m)	Margin (dB)
2382.20	Peak	54.59	1.23	55.82	74.00	-18.18
2382.20	Average	38.56	1.23	39.79	54.00	-14.21
2390.00	Peak	50.83	1.25	52.08	74.00	-21.92
2390.00	Average	37.77	1.25	39.02	54.00	-14.98

Report No.: T200901D14-A-RP

Test Mode	Mode 1: High CH	Temp/Hum	22.4(°C)/ 62%RH
Test Item	Band Edge	Test Date	October 5, 2020
Polarize	Vertical	Test Engineer	Ray Li
Detector	Peak / Average		

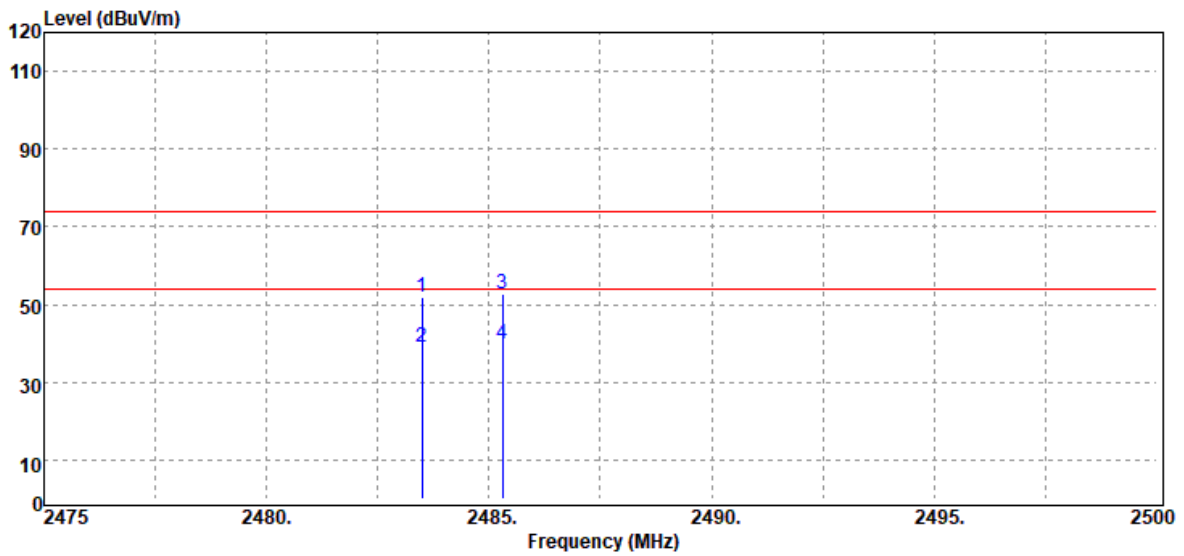

Frequency (MHz)	Detector Mode (PK/QP/AV)	Spectrum Reading Level (dB μ V)	Factor (dB)	Actual FS (dB μ V/m)	Limit @3m (dB μ V/m)	Margin (dB)
2483.50	Peak	50.10	1.62	51.72	74.00	-22.28
2483.50	Average	37.24	1.62	38.86	54.00	-15.14
2485.30	Peak	51.27	1.62	52.89	74.00	-21.11
2485.30	Average	38.13	1.62	39.75	54.00	-14.25

Report No.: T200901D14-A-RP

Test Mode	Mode 1: High CH	Temp/Hum	22.4(°C)/ 62%RH
Test Item	Band Edge	Test Date	October 5, 2020
Polarize	Horizontal	Test Engineer	Ray Li
Detector	Peak / Average		

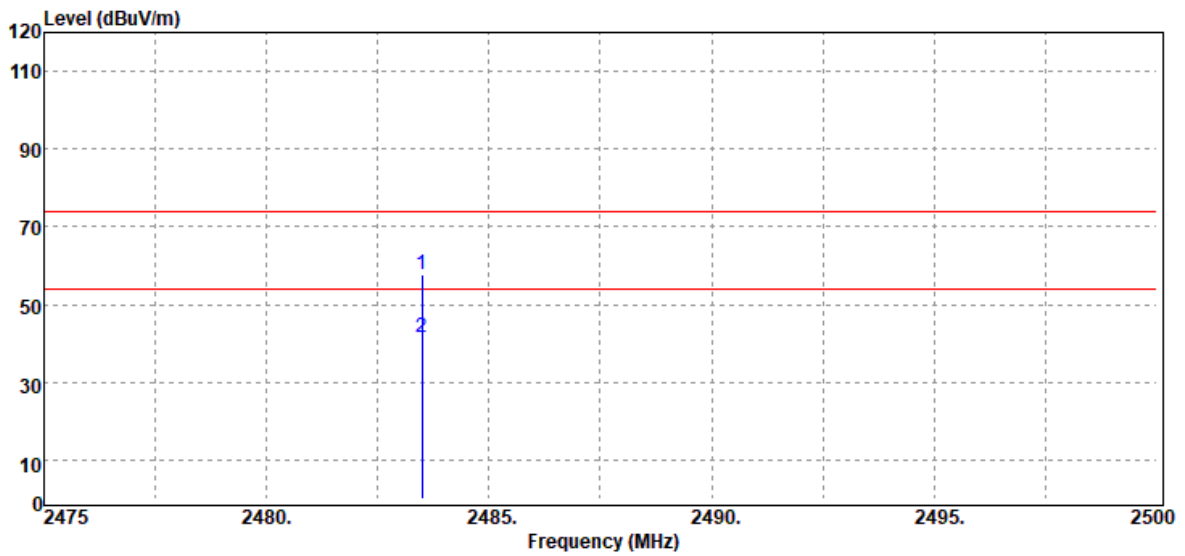

Frequency (MHz)	Detector Mode (PK/QP/AV)	Spectrum Reading Level (dB μ V)	Factor (dB)	Actual FS (dB μ V/m)	Limit @3m (dB μ V/m)	Margin (dB)
2483.50	Peak	56.30	1.62	57.92	74.00	-16.08
2483.50	Average	39.80	1.62	41.42	54.00	-12.58

Report No.: T200901D14-A-RP

8.2 RADIATED EMISSION

LIMIT

According to §15.209, §15.249(a)

Emissions radiated outside of the specified frequency bands, except for harmonics, shall be attenuated by at least 50 dB below the level of the fundamental or to the general radiated emission limits in §15.209(follow the table), whichever is the lesser attenuation

Below 30 MHz

Frequency	Field Strength (microvolts/m)	Measurement Distance (metres)
9-490 kHz	2,400/F (F in kHz)	300
490-1,705 kHz	24,000/F (F in kHz)	30
1.705-30 MHz	30	30

Above 30 MHz

Frequency	Field Strength (microvolts/m)	Measurement Distance (metres)
30-88	100	3
88-216	150	3
216-960	200	3
Above 960	500	3

According to RSS 210 B.10

Below 30 MHz

Frequency	Magnetic field strength (H-Field) ($\mu\text{A/m}$)	Measurement distance (m)
9-490 kHz ^{Note 1}	6.37/F (F in kHz)	300
490-1,705 kHz	63.7/F (F in kHz)	30
1.705-30 MHz	0.08	30

Note 1: The emission limits for the ranges 9-90 kHz and 110-490 kHz are based on measurements employing a linear average detector.

Above 30 MHz

Frequency	Field strength ($\mu\text{V/m}$ at 3 m)	Measurement distance (m)
30-88	100	3
88-216	150	3
216-960	200	3
Above 960	500	3

Report No.: T200901D14-A-RP

Test Configuration

9kHz ~ 30MHz

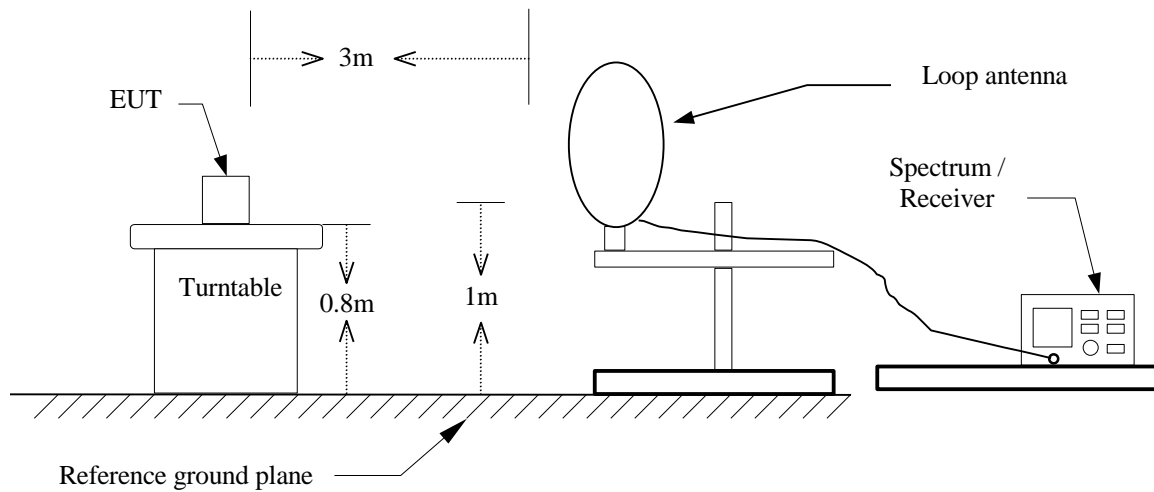

30MHz ~ 1GHz

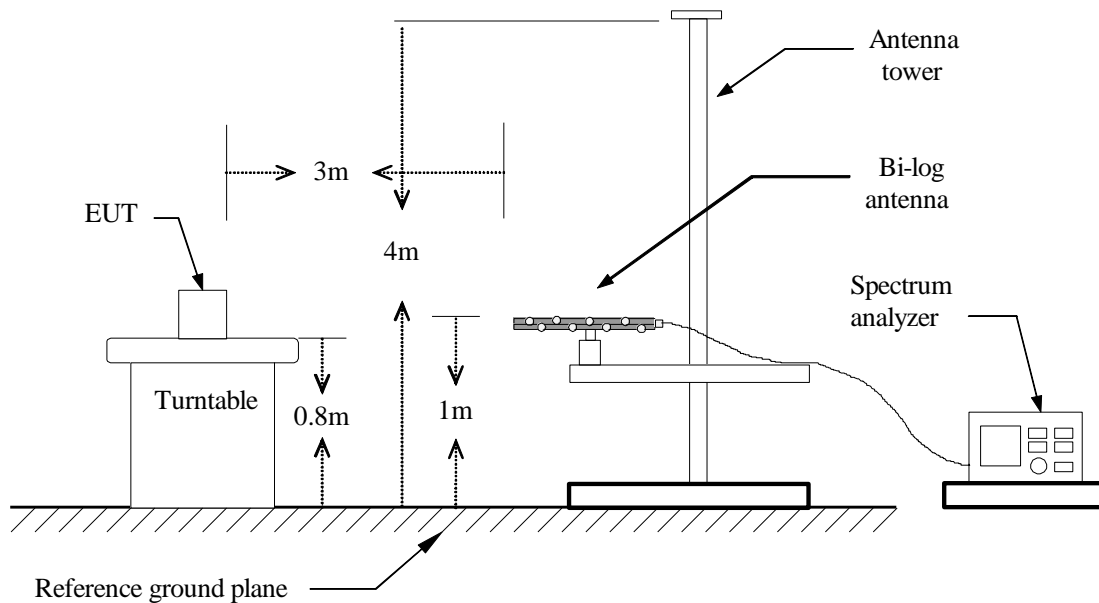

Report No.: T200901D14-A-RP

Above 1 GHz

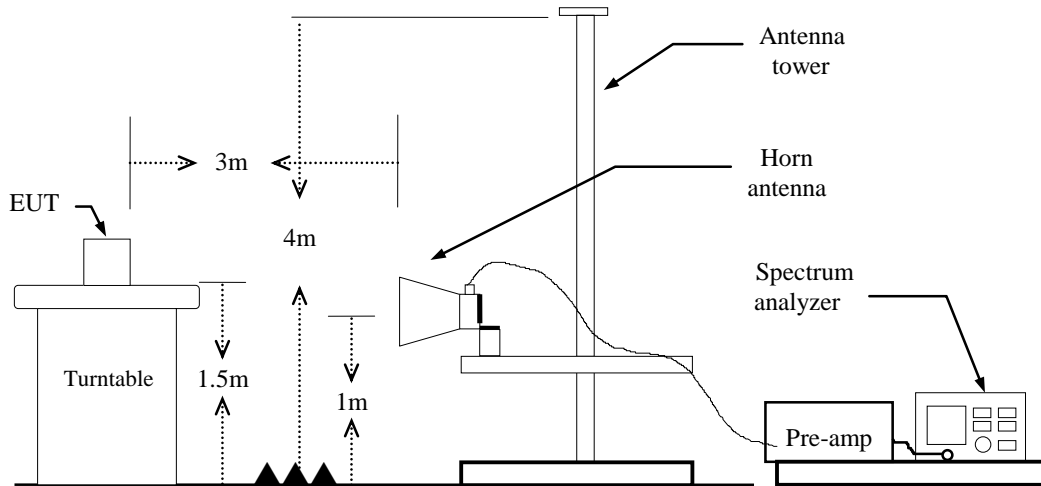

Report No.: T200901D14-A-RP

TEST PROCEDURE

1. The EUT is placed on a turntable, Above 1 GHz is 1.5m high and below 1 GHz is 0.8m high above ground plane.
2. The turntable shall be rotated for 360 degrees to determine the position of maximum emission level.
3. EUT is set 3m away from the receiving antenna, which is varied from 1m to 4m to find out the highest emissions.
4. Maximum procedure was performed on the six highest emissions to ensure EUT compliance.
5. And also, each emission was to be maximized by changing the polarization of receiving antenna both horizontal and vertical.
6. Set the spectrum analyzer in the following setting as:

Below 1GHz:

RBW=100kHz / VBW=300kHz / Sweep=AUTO

Above 1GHz:

(a)PEAK: RBW=1MHz / VBW=3MHz / Sweep=AUTO

(b)AVERAGE: RBW=1MHz,

if duty cycle \geq 98%, VBW=10Hz.

if duty cycle<98% VBW=1/T.

About test

SRD: = 49.32%, VBW= 1 kHz

7. Repeat above procedures until the measurements for all frequencies are complete.
8. Result = Spectrum Reading + cable loss(spectrum to Amp) - Amp Gain + Cable loss(Amp to receive Ant)+ Receive Ant

Note: We checked every harmonics frequencies from Fundamental frequencies with reduced VBW, and we mark a point to prove pass or not if we find any emission. For this case, there are no emissions hidden in the noise floor.

Report No.: T200901D14-A-RP

Operation Mode: Main / CH Low

Test Date: October 5, 2020

Temperature: 22.4°C

Tested by: Ray Li

Humidity: 62% RH

Polarity: Vertical / Horizontal

Vertical

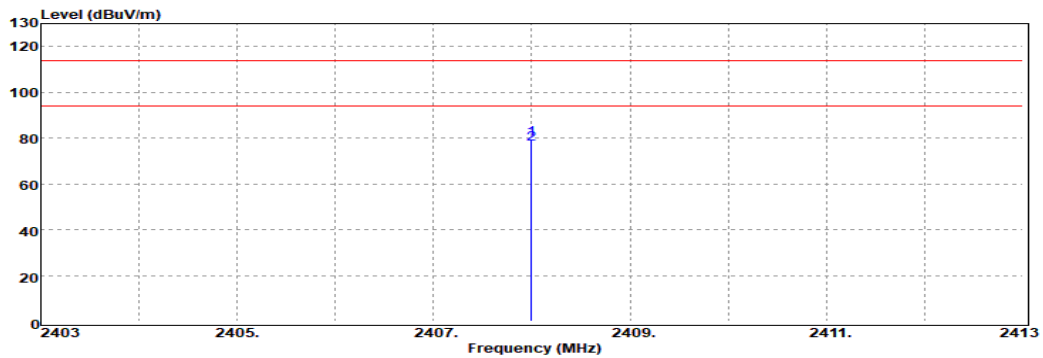

Horizontal

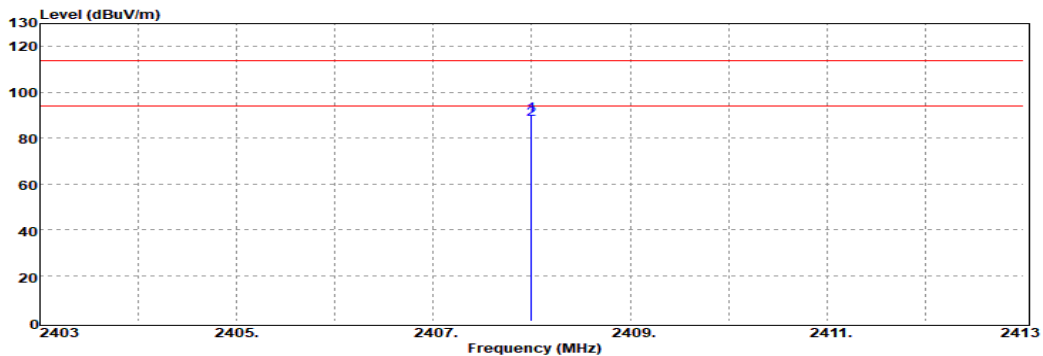

Freq. MHz	Detector Mode PK/QP/AV	Spectrum Reading Level dBμV	Factor dB	Actual FS dBμV/m	Limit @3m dBμV/m	Margin dB	Ant. Pol. (H/V)
2408.00	Peak	78.24	1.33	79.57	114.00	-34.43	V
2408.00	Average	76.10	1.33	77.43	94.00	-16.57	V
2408.00	Peak	88.46	1.33	89.79	114.00	-24.21	H
2408.00	Average	86.72	1.33	88.05	94.00	-5.95	H

Report No.: T200901D14-A-RP

Operation Mode: Main / CH Mid

Test Date: October 5, 2020

Temperature: 22.4°C

Tested by: Ray Li

Humidity: 62% RH

Polarity: Vertical / Horizontal

Vertical

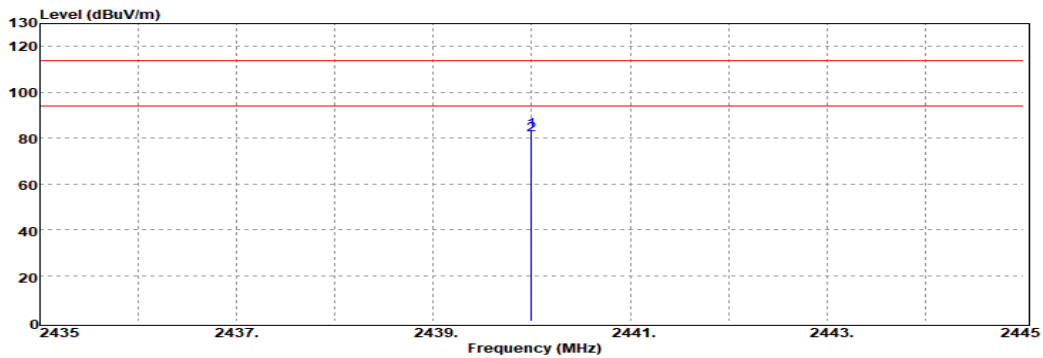

Horizontal

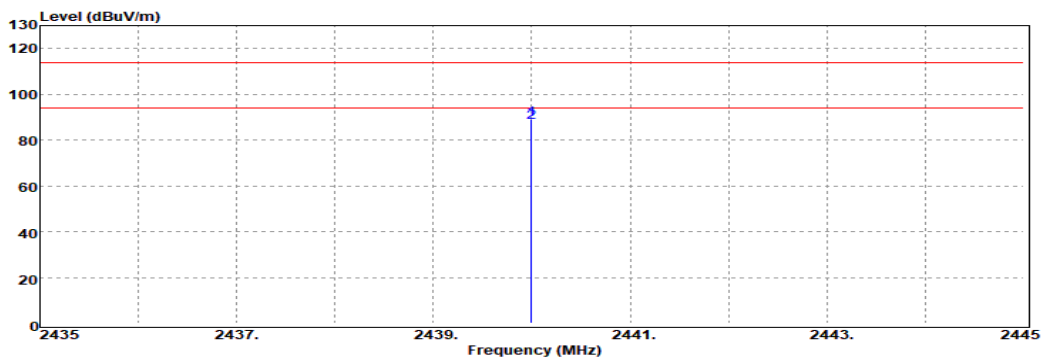

Freq. MHz	Detector Mode PK/QP/AV	Spectrum Reading Level dBμV	Factor dB	Actual FS dBμV/m	Limit @3m dBμV/m	Margin dB	Ant. Pol. (H/V)
2440.00	Peak	81.94	1.50	83.44	114.00	-30.56	V
2440.00	Average	79.78	1.50	81.28	94.00	-12.72	V
2440.00	Peak	87.72	1.50	89.22	114.00	-24.78	H
2440.00	Average	86.03	1.50	87.53	94.00	-6.47	H

Report No.: T200901D14-A-RP

Operation Mode: Main / CH High

Test Date: October 5, 2020

Temperature: 22.4°C

Tested by: Ray Li

Humidity: 62% RH

Polarity: Vertical / Horizontal

Vertical

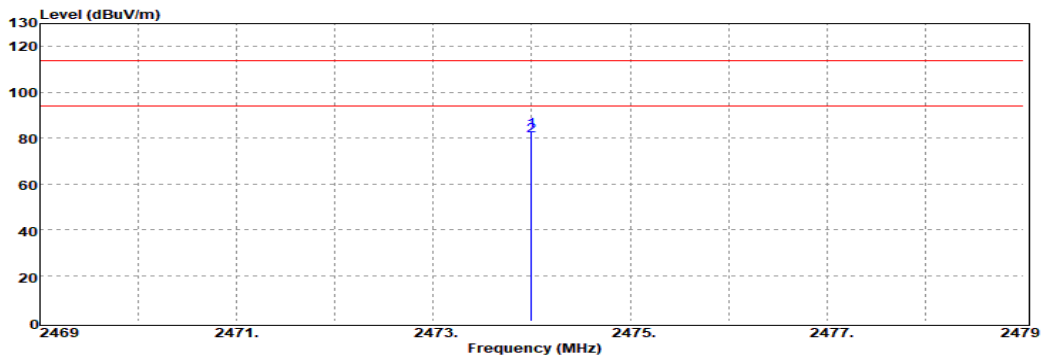

Horizontal

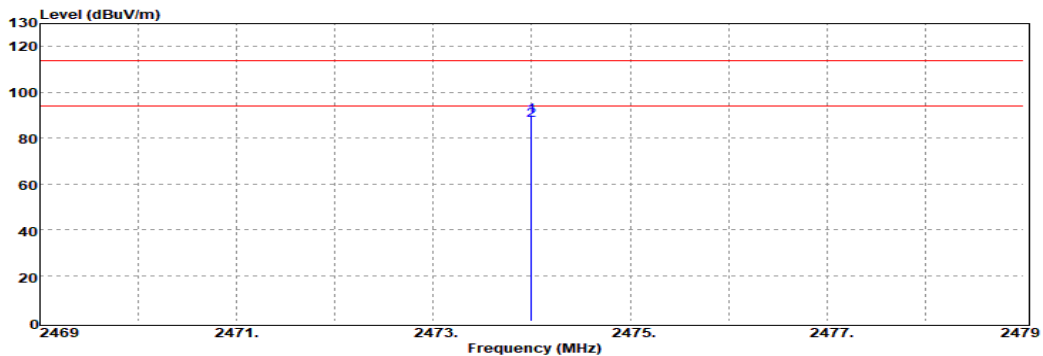

Freq. MHz	Detector Mode PK/QP/AV	Spectrum Reading Level dBμV	Factor dB	Actual FS dBμV/m	Limit @3m dBμV/m	Margin dB	Ant. Pol. (H/V)
2474.00	Peak	81.44	1.60	83.04	114.00	-30.96	V
2474.00	Average	79.37	1.60	80.97	94.00	-13.03	V
2474.00	Peak	87.74	1.60	89.34	114.00	-24.66	H
2474.00	Average	85.92	1.60	87.52	94.00	-6.48	H

Report No.: T200901D14-A-RP

Below 1 GHz

Operation Mode: TX CH Mid
Temperature: 22.4°C
Humidity: 62% RH

Test Date: October 5, 2020
Tested by: Ray Li
Polarity: Vertical

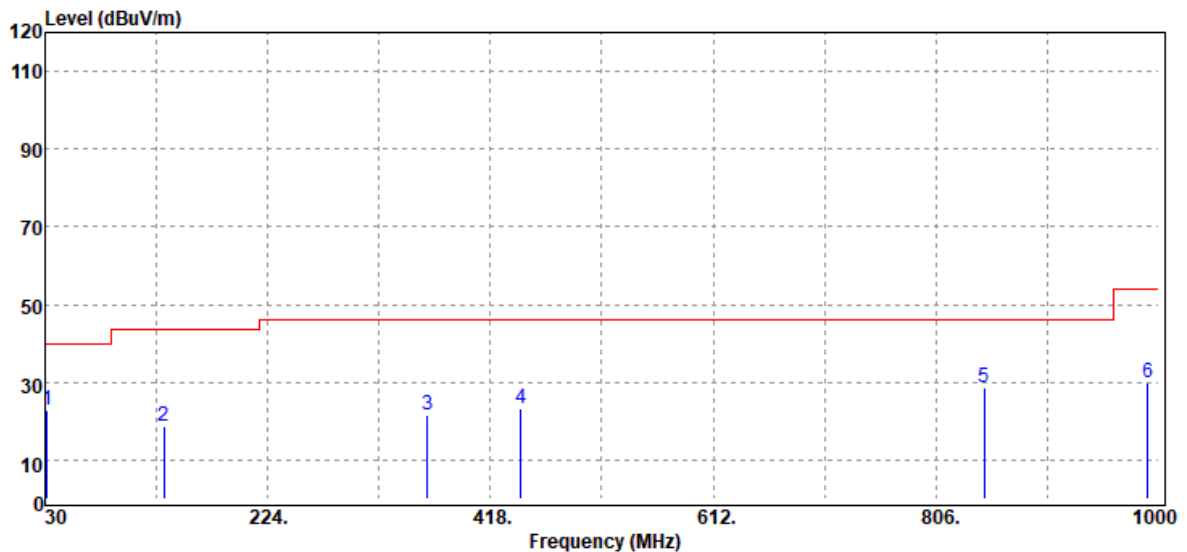

Freq. MHz	Detector Mode PK/QP/AV	Spectrum Reading Level dBμV	Factor dB	Actual FS dBμV/m	Limit @3m dBμV/m	Margin dB
31.94	Peak	27.24	-4.39	22.85	40.00	-17.15
133.79	Peak	27.91	-9.36	18.55	43.50	-24.95
362.71	Peak	28.29	-6.68	21.61	46.00	-24.39
444.19	Peak	27.74	-4.52	23.22	46.00	-22.78
847.71	Peak	25.98	2.49	28.47	46.00	-17.53
990.30	Peak	25.74	4.29	30.03	54.00	-23.97

Remark:

1. No emission found between lowest internal used/generated frequency to 30MHz (9kHz~30MHz)
2. Radiated emissions measured in frequency range from 30 MHz to 1000MHz were made with an instrument using peak/quasi-peak detector mode.
3. Quasi-peak test would be performed if the peak result were greater than the quasi-peak limit or as required by the applicant.
4. Measurements above show only up to 6 maximum emissions noted, or would be lesser, with " N/A " remark, if no specific emissions from the EUT are recorded (ie: margin>20dB from the applicable limit) and considered that's already beyond the background noise floor.
5. Margin (dB) = Remark result (dBUV/m) – Quasi-peak limit (dBUV/m).

Report No.: T200901D14-A-RP

Operation Mode: TX CH Mid
Temperature: 22.4°C
Humidity: 62% RH

Test Date: October 5, 2020
Tested by: Ray Li
Polarity: Horizontal

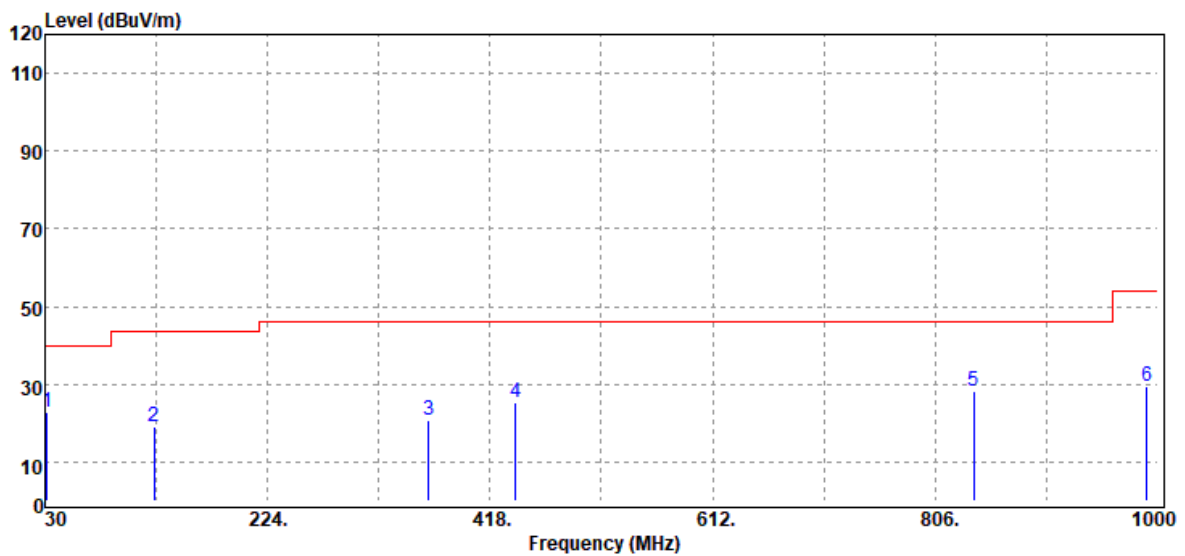

Freq. MHz	Detector Mode PK/QP/AV	Spectrum Reading Level dBμV	Factor dB	Actual FS dBμV/m	Limit @3m dBμV/m	Margin dB
31.94	Peak	27.29	-4.39	22.90	40.00	-17.10
125.06	Peak	28.00	-9.07	18.93	43.50	-24.57
364.65	Peak	27.28	-6.61	20.67	46.00	-25.33
440.31	Peak	29.94	-4.54	25.40	46.00	-20.60
839.95	Peak	25.98	2.30	28.28	46.00	-17.72
990.30	Peak	25.22	4.29	29.51	54.00	-24.49

Remark:

1. No emission found between lowest internal used/generated frequency to 30MHz (9kHz~30MHz)
2. Radiated emissions measured in frequency range from 30 MHz to 1000MHz were made with an instrument using peak/quasi-peak detector mode.
3. Quasi-peak test would be performed if the peak result were greater than the quasi-peak limit or as required by the applicant.
4. Measurements above show only up to 6 maximum emissions noted, or would be lesser, with " N/A " remark, if no specific emissions from the EUT are recorded (ie: margin>20dB from the applicable limit) and considered that's already beyond the background noise floor.
5. Margin (dB) = Remark result (dBuV/m) – Quasi-peak limit (dBuV/m).

Report No.: T200901D14-A-RP

Above 1 GHz

TX / CH Low

Polarity: Vertical

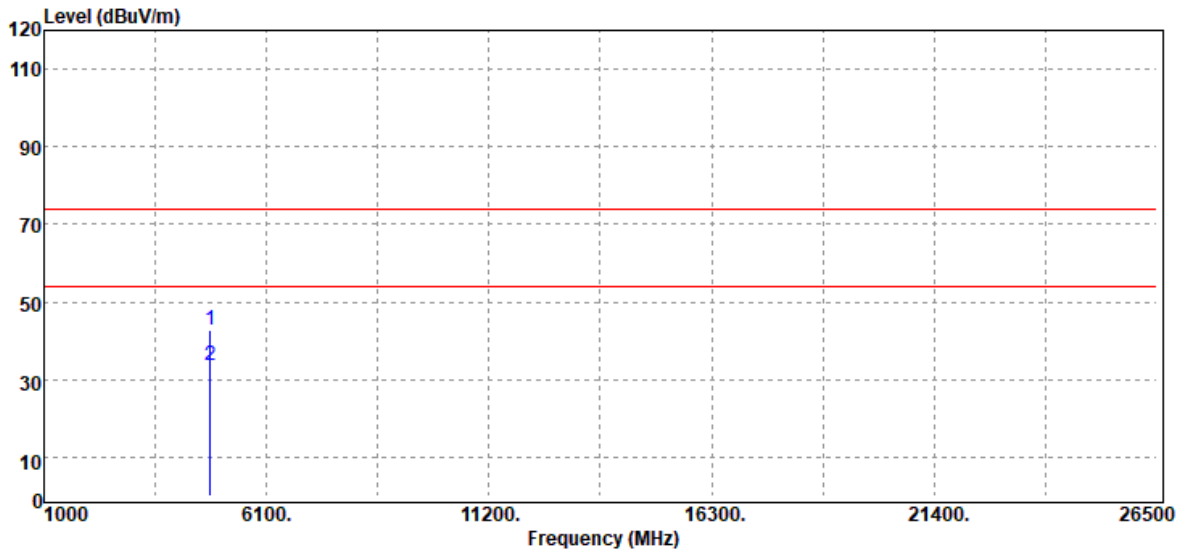

Polarity: Horizontal

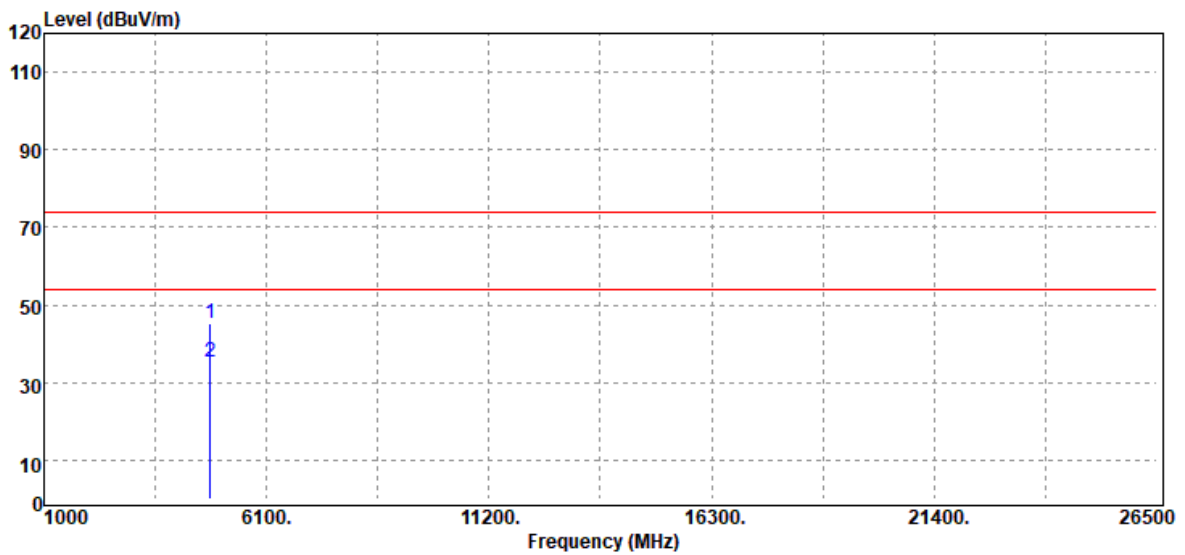

Report No.: T200901D14-A-RP

Operation Mode: Tx / CH Low **Test Date:** October 5, 2020
Temperature: 22.4°C **Tested by:** Ray Li
Humidity: 62% RH **Polarity:** Ver. / Hor.

Freq. MHz	Detector Mode PK/QP/AV	Spectrum Reading Level dBµV	Factor dB	Actual FS dBµV/m	Limit @3m dBµV/m	Margin dB	Ant. Pol. (V/H)
4816.00	Peak	36.58	6.35	42.93	74.00	-31.07	V
4816.00	Average	27.12	6.35	33.47	54.00	-20.53	V
N/A							
4816.00	Peak	38.88	6.35	45.23	74.00	-28.77	H
4816.00	Average	29.11	6.35	35.46	54.00	-18.54	H
N/A							

Remark:

1. Measuring frequencies from 1 GHz to the 10th harmonic of highest fundamental frequency.
2. Radiated emissions measured in frequency above 1000MHz were made with an instrument using peak/average detector mode.
3. Average test would be performed if the peak result were greater than the average limit or as required by the applicant.
4. Data of measurement within this frequency range shown " --- " in the table above means the reading of emissions are attenuated more than 20dB below the permissible limits or the field strength is too small to be measured.
5. Measurements above show only up to 6 maximum emissions noted, or would be lesser, with " N/A " remark, if no specific emissions from the EUT are recorded (ie: margin>20dB from the applicable limit) and considered that's already beyond the background noise floor.
6. Margin (dB) = Result (dBuV/m) – limit (dBuV/m).

Report No.: T200901D14-A-RP

TX / CH Mid

Polarity: Vertical

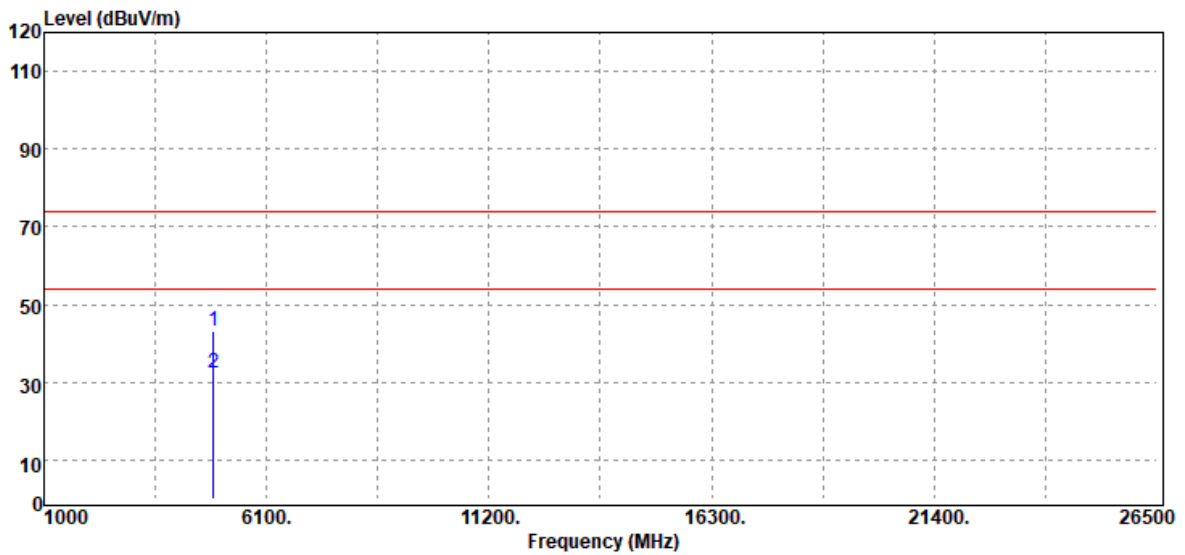

Polarity: Horizontal

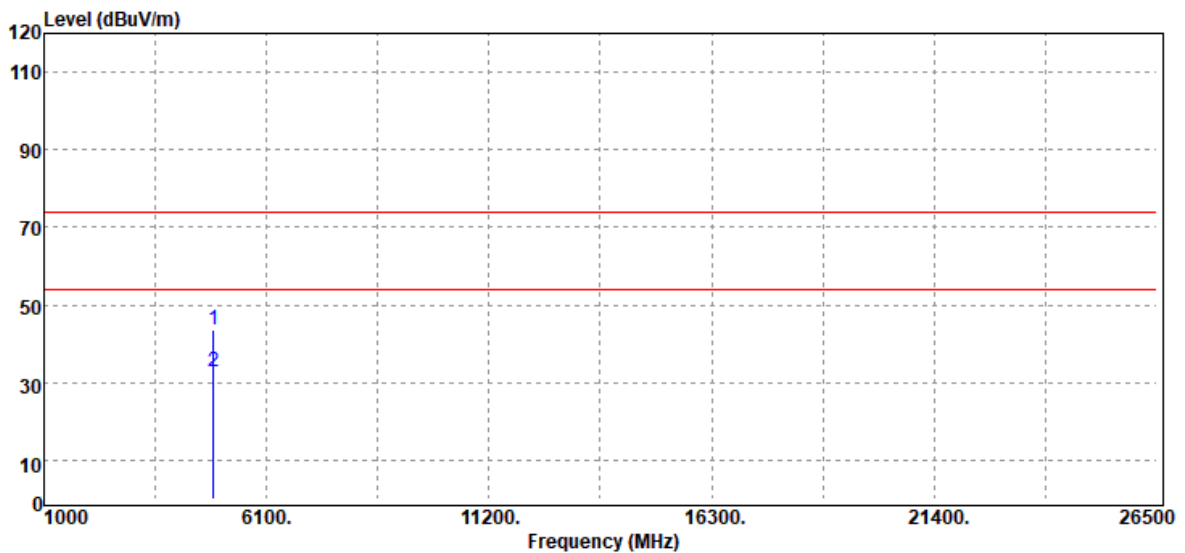

Report No.: T200901D14-A-RP

Operation Mode: Tx / CH Mid **Test Date:** October 5, 2020
Temperature: 22.4°C **Tested by:** Ray Li
Humidity: 62% RH **Polarity:** Ver. / Hor.

Freq. MHz	Detector Mode PK/QP/AV	Spectrum Reading Level dBµV	Factor dB	Actual FS dBµV/m	Limit @3m dBµV/m	Margin dB	Ant. Pol. (V/H)
4880.00	Peak	36.80	6.40	43.20	74.00	-30.80	V
4880.00	Average	25.82	6.40	32.22	54.00	-21.78	V
N/A							
4880.00	Peak	37.27	6.40	43.67	74.00	-30.33	H
4880.00	Average	26.49	6.40	32.89	54.00	-21.11	H
N/A							

Remark:

1. Measuring frequencies from 1 GHz to the 10th harmonic of highest fundamental frequency.
2. Radiated emissions measured in frequency above 1000MHz were made with an instrument using peak/average detector mode.
3. Average test would be performed if the peak result were greater than the average limit or as required by the applicant.
4. Data of measurement within this frequency range shown " --- " in the table above means the reading of emissions are attenuated more than 20dB below the permissible limits or the field strength is too small to be measured.
5. Measurements above show only up to 6 maximum emissions noted, or would be lesser, with " N/A " remark, if no specific emissions from the EUT are recorded (ie: margin>20dB from the applicable limit) and considered that's already beyond the background noise floor.
6. Margin (dB) = Result (dBuV/m) – limit (dBuV/m).

Report No.: T200901D14-A-RP

TX / CH High

Polarity: Vertical

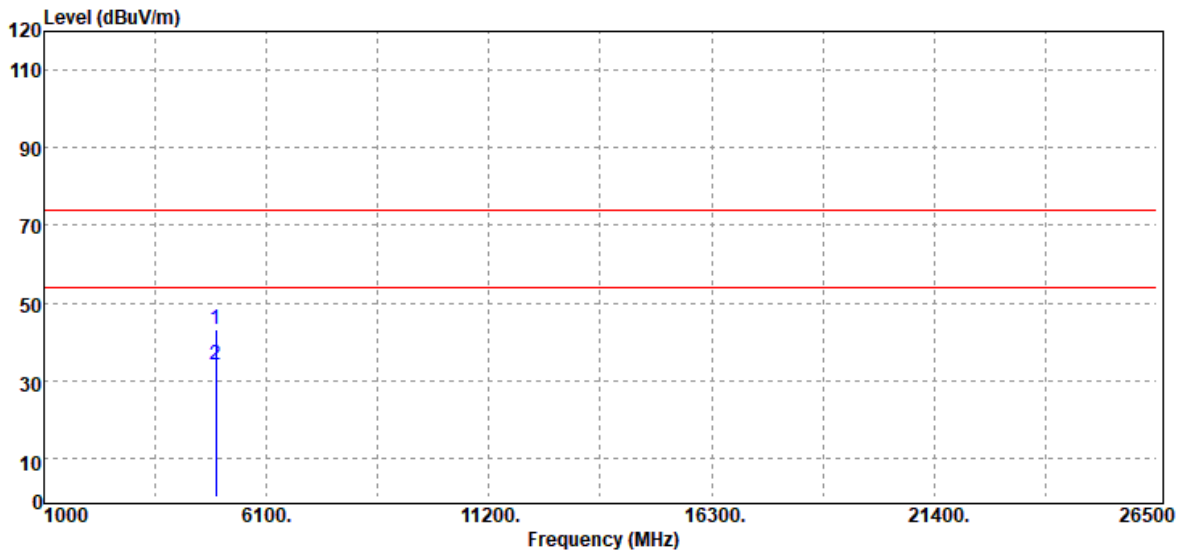

Polarity: Horizontal

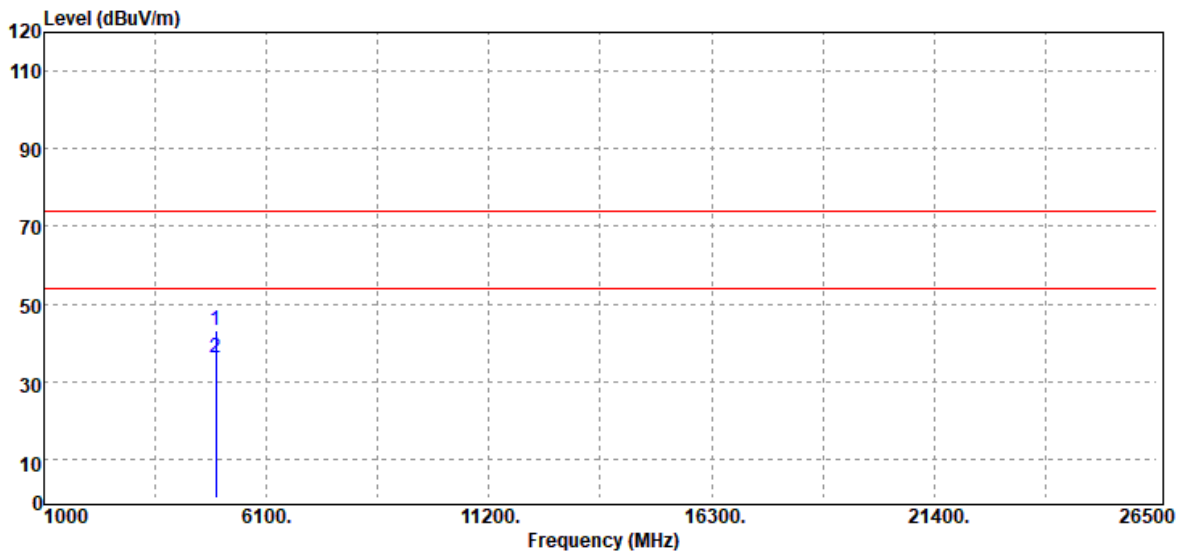

Report No.: T200901D14-A-RP

Operation Mode: Tx / CH Mid **Test Date:** October 5, 2020
Temperature: 22.4°C **Tested by:** Ray Li
Humidity: 62% RH **Polarity:** Ver. / Hor.

Freq. MHz	Detector Mode PK/QP/AV	Spectrum Reading Level dBµV	Factor dB	Actual FS dBµV/m	Limit @3m dBµV/m	Margin dB	Ant. Pol. (V/H)
4948.00	Peak	36.46	6.78	43.24	74.00	-30.76	V
4948.00	Average	27.42	6.78	34.20	54.00	-19.80	V
N/A							
4948.00	Peak	36.24	6.78	43.02	74.00	-30.98	H
4948.00	Average	29.42	6.78	36.20	54.00	-17.80	H
N/A							

Remark:

1. Measuring frequencies from 1 GHz to the 10th harmonic of highest fundamental frequency.
2. Radiated emissions measured in frequency above 1000MHz were made with an instrument using peak/average detector mode.
3. Average test would be performed if the peak result were greater than the average limit or as required by the applicant.
4. Data of measurement within this frequency range shown “ --- ” in the table above means the reading of emissions are attenuated more than 20dB below the permissible limits or the field strength is too small to be measured.
5. Measurements above show only up to 6 maximum emissions noted, or would be lesser, with “ N/A ” remark, if no specific emissions from the EUT are recorded (ie: margin>20dB from the applicable limit) and considered that's already beyond the background noise floor.
6. Margin (dB) = Result (dBuV/m) – limit (dBuV/m).

Report No.: T200901D14-A-RP

8.3 POWERLINE CONDUCTED EMISSIONS

LIMIT

According to §15.207(a)(2) and RSS-GEN section 8.8, for an intentional radiator that is designed to be connected to the public utility (AC) power line, the radio frequency voltage that is conducted back onto the AC power line on any frequency or frequencies within the band 150 kHz to 30 MHz shall not exceed the limits in the following table, as measured using a 50 μ H/50 ohms line impedance stabilization network (LISN). Compliance with the provisions of this paragraph shall be based on the measurement of the radio frequency voltage between each power line and ground at the power terminal. The lower limit applies at the boundary between the frequency ranges.

Frequency Range (MHz)	Limits (dB μ V)	
	Quasi-peak	Average
0.15 to 0.50	66 to 56*	56 to 46*
0.50 to 5	56	46
5 to 30	60	50

Test Configuration

See test photographs attached in Appendix I for the actual connections between EUT and support equipment.

TEST PROCEDURE

1. The EUT was placed on a table, which is 0.8m above ground plane.
2. Maximum procedure was performed on the six highest emissions to ensure EUT compliance.
3. Repeat above procedures until all frequency measured were complete.

Report No.: T200901D14-A-RP

TEST RESULTS

The initial step in collecting conducted data is a spectrum analyzer peak scan of the measurement range. Significant peaks are then marked as shown on the following data page, and these signals are then quasi-peaked.

Test Data

Not applicable, because EUT not connect to AC Main Source direct.

Report No.: T200901D14-A-RP

8.4 20DB BANDWIDTH AND OCCUPIED BANDWIDTH(99%)

LIMIT

20 dB Bandwidth : For reporting purposes only.

Occupied Bandwidth(99%) : For reporting purposes only.

Test Configuration

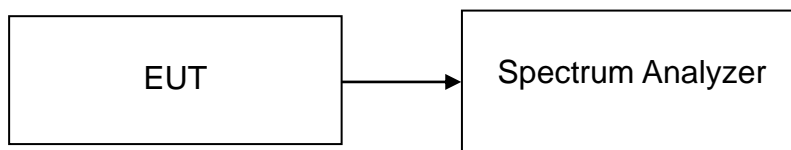

TEST PROCEDURE

Test method Refer as ANSI C63.10: 2013 clause 6.9.2,

1. The EUT RF output connected to the spectrum analyzer by RF cable.
2. Setting maximum power transmit of EUT
3. SA set RBW = 100kHz, VBW = 300kHz and Detector = Peak, to measurement 20 dB Bandwidth and 99% Bandwidth.
4. Measure and record the result of 20 dB Bandwidth and 99% Bandwidth. in the test report.

TEST RESULTS

No non-compliance noted

Test Data

Temperature: 25°C **Test Date:** September 23, 2020
Humidity: 50% RH **Tested by:** Jane Wang

Test mode: SRD mode / 2408 ~ 2474MHz			
Channel	Frequency (MHz)	OBW(99%) (MHz)	20dB BW (MHz)
Low	2408	2.2141	2.3010
Mid	2440	2.2648	2.4023
High	2474	2.2431	2.4819

Report No.: T200901D14-A-RP

Test Plots (20dB Bandwidth)

CH Low

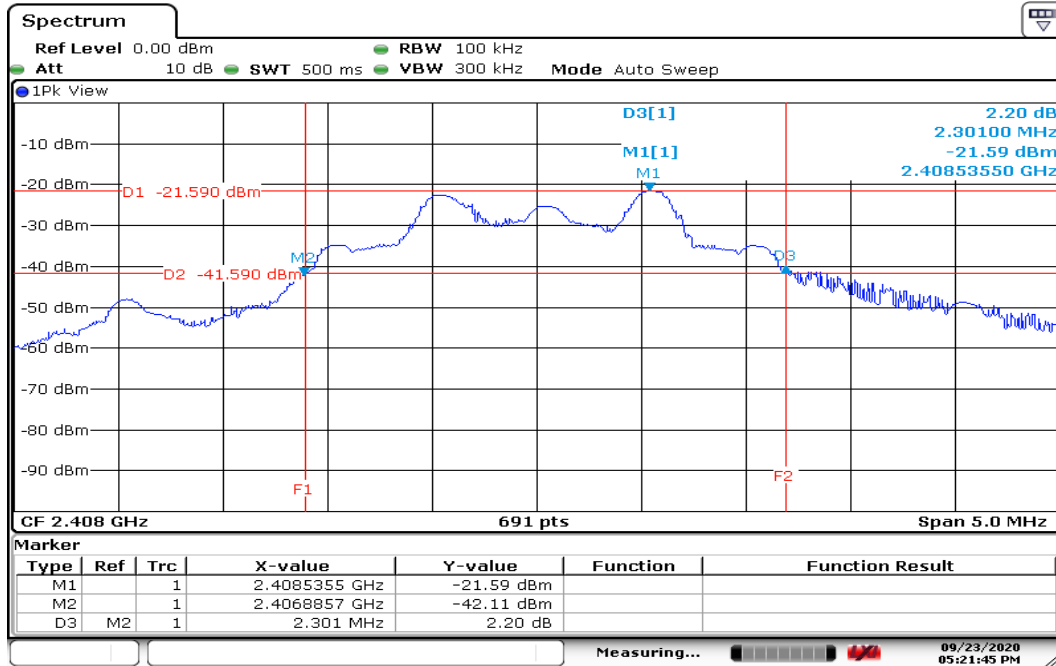

Date: 23.SEP.2020 17:21:46

CH Mid

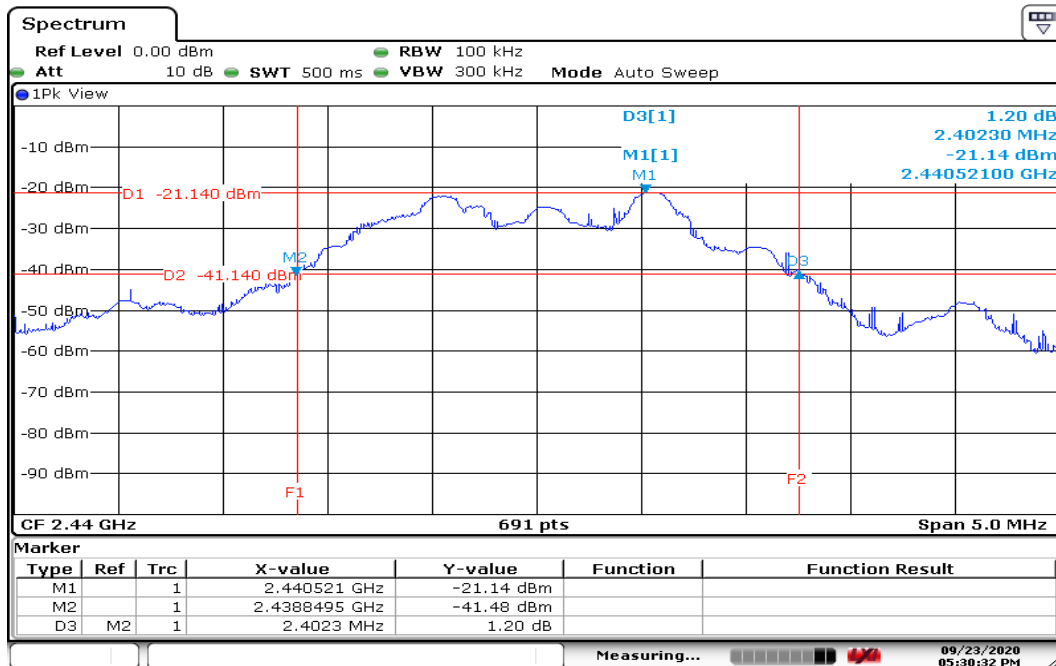

Date: 23.SEP.2020 17:30:33

Report No.: T200901D14-A-RP

CH High

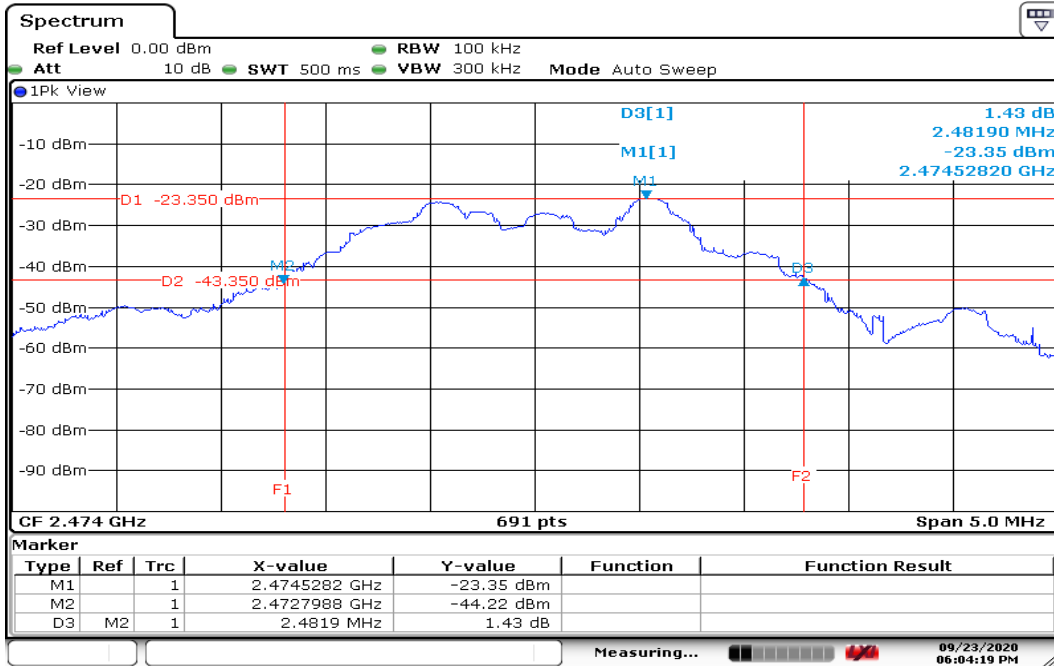

Date: 23 SEP 2020 18:04:20

Report No.: T200901D14-A-RP

Test Plots (Occupied Bandwidth 99%)

CH Low

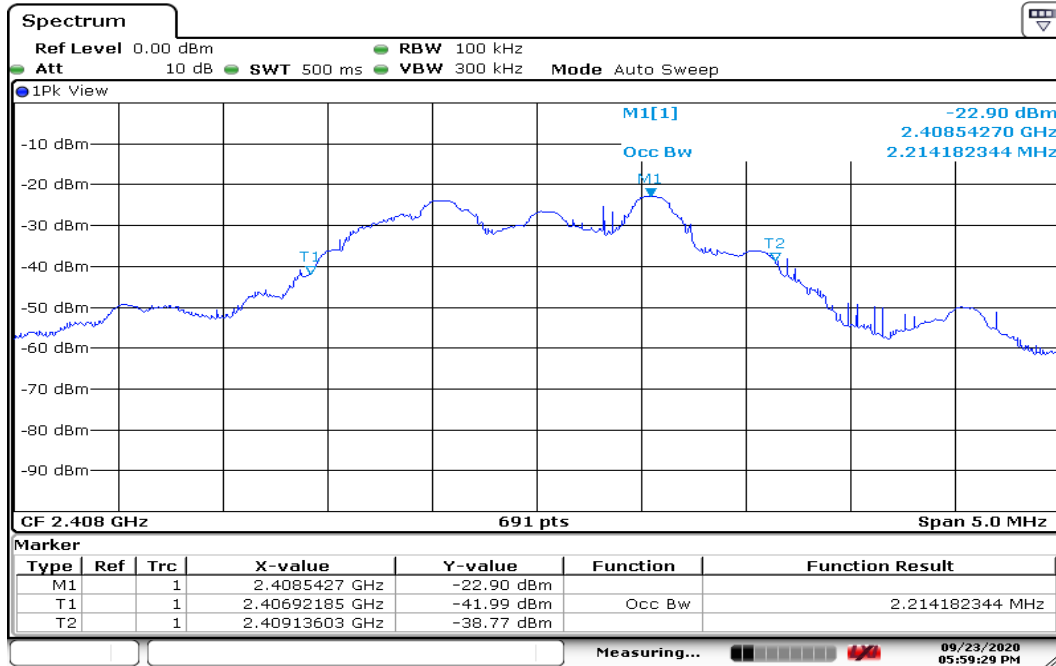

Date: 23.SEP.2020 17:59:29

CH Mid

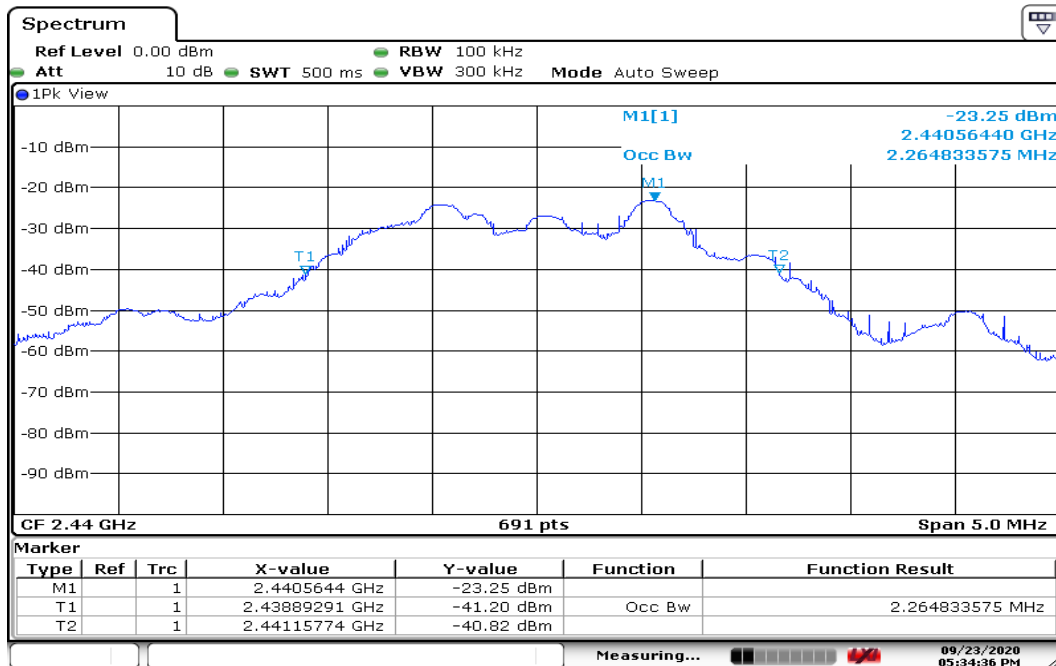

Date: 23.SEP.2020 17:34:36

CH High

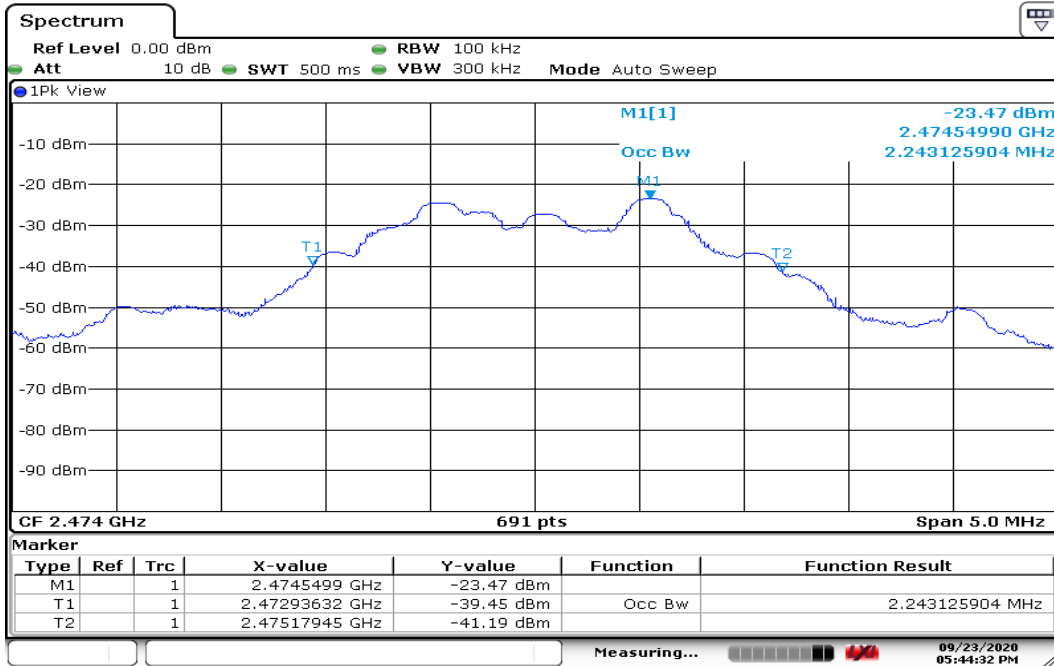

Date: 23 SEP 2020 17:44:32

-- End of Test Report --