

RADIO TEST REPORT

The device described below is tested by Dongguan Nore Testing Center Co., Ltd. to determine the maximum emission levels emanating from the device, the severe levels which the device can endure and E.U.T.'s performance criterion. The test results, data evaluation, test procedures, and equipment of configurations shown in this report were made in accordance with the procedures in ANSI C63.10(2013).

Applicant : Acrox Technologies Co., Ltd.
Address : 4F., No.89, Minshan St., Neihu Dist., Taipei City 114, Taiwan
Manufacturer/Factory : Acrox Technologies Co., Ltd.
Address : Hsinmin Industrial, Changan Town, Dongguan City, Guangdong, China
E.U.T. : Full-Size Ergonomic Wireless Mouse with Fast Scrolling
Brand Name : Acrox, AmazonBasics
Model No. : GP8, GP8-BK (For model difference, refer to section 1)
FCC ID : PRDMU62
Measurement Standard : FCC PART 15.249: 2017
Date of Receiver : January 12, 2018
Date of Test : January 12, 2018 to January 22, 2018
Date of Report : January 22, 2018

This Test Report is Issued Under the Authority of :

Prepared by



Knight Wen / Engineer

Approved & Authorized Signer



Ioff Fan / Authorized Signatory

This test report is for the customer shown above and their specific product only. This report applies to above tested sample only and shall not be reproduced in part without written approval of Dongguan Nore Testing Center Co., Ltd.

Table of Contents

1. GENERAL INFORMATION	4
1.1 PRODUCT DESCRIPTION FOR EQUIPMENT UNDER TEST	4
1.2 RELATED SUBMITTAL(S) / GRANT (S)	6
1.3 TEST METHODOLOGY	6
1.4 EQUIPMENT MODIFICATIONS	6
1.5 SUPPORT DEVICE	6
1.6 TEST FACILITY AND LOCATION	7
1.7 SUMMARY OF TEST RESULTS	8
2. SYSTEM TEST CONFIGURATION.....	9
2.1 EUT CONFIGURATION	9
2.2 SPECIAL ACCESSORIES	9
2.3 DESCRIPTION OF TEST MODES	9
2.4 EUT EXERCISE	9
3. CONDUCTED EMISSIONS TEST	10
3.1 TEST SET-UP (BLOCK DIAGRAM OF CONFIGURATION)	10
3.2 TEST CONDITION.....	10
3.3 MEASUREMENT RESULTS	10
4. RADIATED EMISSION TEST.....	11
4.1 TEST SET-UP (BLOCK DIAGRAM OF CONFIGURATION)	11
4.2 MEASUREMENT PROCEDURE	12
4.3 LIMIT	13
4.4 MEASUREMENT RESULTS	13
5. 20DB BANDWIDTH.....	17
5.1 MEASUREMENT PROCEDURE	17
5.2 TEST SET-UP (BLOCK DIAGRAM OF CONFIGURATION)	17
5.3 MEASUREMENT RESULTS	17
6. BAND EDGE	20
6.1 MEASUREMENT PROCEDURE	20
6.2 LIMIT	20
6.3 MEASUREMENT RESULTS	20
7. ANTENNA REQUIREMENT	23
7.1 MEASUREMENT PROCEDURE	23
7.2 MEASUREMENT RESULTS	23
8. TEST EQUIPMENT LIST.....	24

1. GENERAL INFORMATION

1.1 Product Description for Equipment under Test

Product Name	:	Full-Size Ergonomic Wireless Mouse with Fast Scrolling
Main model number	:	GP8
Additional Model number	:	GP8-BK
Brand Name	:	Acrox, AmazonBasics
Power Supply	:	DC 3.0V From 2*AA battery
Adapter	:	N/A
Test voltage	:	DC 3.0V From 2*AA battery
Model Difference Description	:	Both of models have the same circuit schematic, construction, PCB Layout and critical components. Their difference in model number and brand name due to trading purpose.
Hardware version	:	V01
Software version	:	V01
Note	:	According to the model difference, all tests were carried on model GP8.

Technical Specification:

2.4G Function:

Frequency Range	:	2408~2474MHz
Modulation Type	:	GFSK
Number of Channel	:	34
Channel Space	:	2MHz
Antenna Type	:	PCB
Antenna Gain	:	-1.0 dBi (Declaration by manufacturer)

Channel List:

Channel	Frequency MHz	Channel	Frequency MHz	Channel	Frequency MHz
1	2408	13	2432	25	2456
2	2410	14	2434	26	2458
3	2412	15	2436	27	2460
4	2414	16	2438	28	2462
5	2416	17	2440	29	2464
6	2418	18	2442	30	2466
7	2420	19	2444	31	2468
8	2422	20	2446	32	2470
9	2424	21	2448	33	2472
10	2426	22	2450	34	2474
11	2428	23	2452		
12	2430	24	2454		

Note: The Lowest, middle, and the Highest frequency of channel were selected to perform the test. The frequency selected see below:

The Lowest frequency: 2408MHz
The middle frequency: 2440MHz
The Highest frequency: 2474MHz

1.2 Related Submittal(s) / Grant (s)

This submittal(s) (test report) is intended for FCC ID: PRDMU62 filing to comply with Section 15.249 of the FCC Part 15 (2017), Subpart C Rule.

1.3 Test Methodology

Both AC mains line-conducted and radiated emission measurements were performed according to the procedures in ANSI C63.10 (2013). Radiated emission measurement was performed in semi-anechoic chamber and conducted emission measurement was performed in shield room. For radiated emission measurement, preliminary scans were performed in the semi-anechoic chamber only to determine the worst case modes. All radiated tests were performed at an antenna to EUT distance of 3 meters.

1.4 Equipment Modifications

Not available for this EUT intended for grant.

1.5 Support Device

N/A

1.6 Test Facility and Location

Site Description

- EMC Lab : Listed by CNAS, August 14, 2015
The certificate is valid until August 13, 2018
The Laboratory has been assessed and proved to be in compliance with CNAS/CL01
The Certificate Registration Number is L5795.
- Listed by A2LA, November 01, 2017
The certificate is valid until December 31, 2019
The Laboratory has been assessed and proved to be in compliance with ISO17025
The Certificate Registration Number is 4429.01
- Listed by FCC, November 06, 2017
The Designation Number is CN1214
Test Firm Registration Number: 907417
- Listed by Industry Canada, June 08, 2017
The Certificate Registration Number. Is 46405-9743
- Name of Firm : Dongguan Nore Testing Center Co., Ltd.
(Dongguan NTC Co., Ltd.)
- Site Location : Building D, Gaosheng Science & Technology Park,
Zhouxi Longxi Road, Nancheng District, Dongguan
City, Guangdong Province, China

1.7 Summary of Test Results

FCC Rules	Description Of Test	Uncertainty	Result
§15.207(a)	AC Power Conducted Emission	±1.06dB	Not Applicable
§15.249(a)/ 15.209	Radiated Emissions	±3.70dB	Compliant
§15.249(d)/ 15.205	Band Edge	±1.70dB	Compliant
§15.215(c)	20dB Bandwidth	±1.42 x10 ⁻⁴ %	Compliant
§15.203	Antenna Requirement	---	Compliant

- Note: 1. The EUT has been tested as an independent unit. And Continual transmitting in maximum power (The new battery be used during test)
2. Due to this EUT is powered by battery only, the AC Power Conducted Emission is not applicable.
3. The EUT powered by battery and operating multiple positions, so the EUT shall be performed two or three orthogonal planes. The worst plane is Z.

Example:

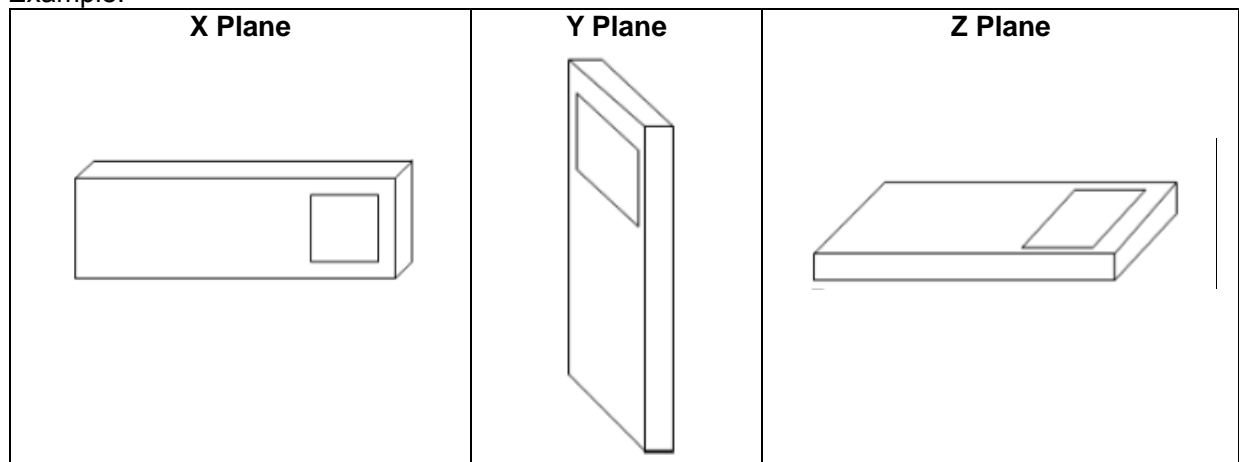

2. System Test Configuration

2.1 EUT Configuration

The EUT configuration for testing is installed on RF field strength measurement to meet the Commissions requirement and operating in a manner which intends to maximize its emission characteristics in a continuous normal application.

2.2 Special Accessories

Not available for this EUT intended for grant.

2.3 Description of test modes

The EUT has been tested under operating condition. The Lowest, middle and highest frequencies were chosen for testing.

2.4 EUT Exercise

The EUT was operated in the engineering mode to fix the Tx frequency that was for the purpose of the measurements.

3. Conducted Emissions Test

3.1 Test SET-UP (Block Diagram of Configuration)

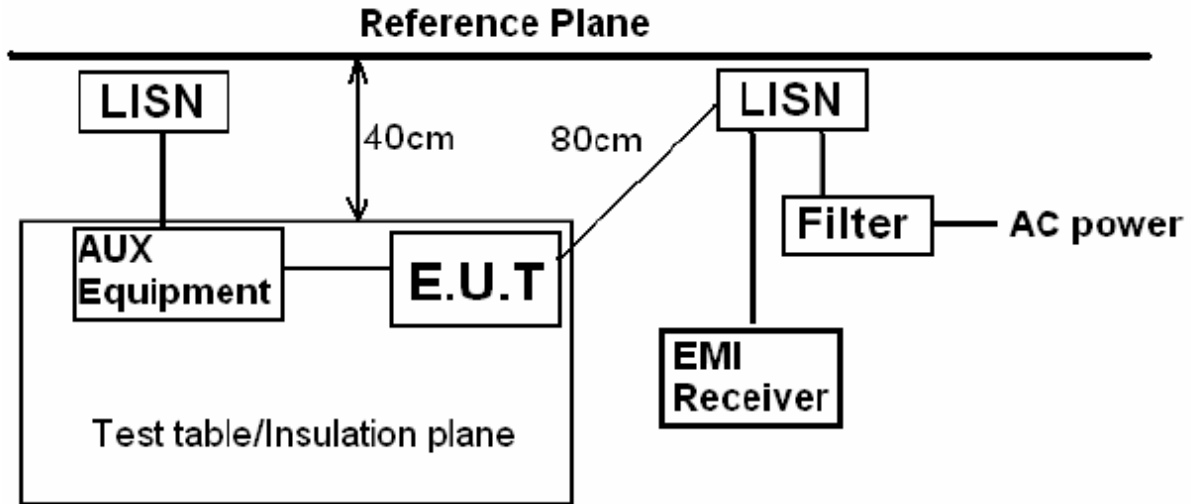

3.2 Test Condition

Test Requirement: FCC Part 15.207

Frequency Range: 150KHz ~ 30MHz

Detector: RBW 9KHz, VBW 30KHz

Operation Mode: TX

3.3 Measurement Results

Not Applicable.

4. Radiated Emission Test

4.1 Test SET-UP (Block Diagram of Configuration)

4.1.1 Radiated Emission Test Set-Up, Frequency Below 30MHz

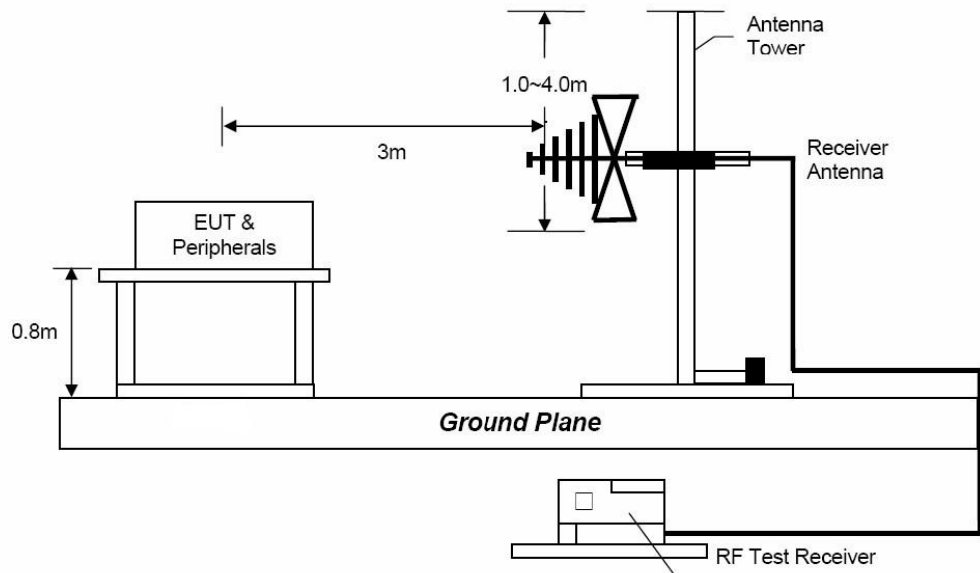
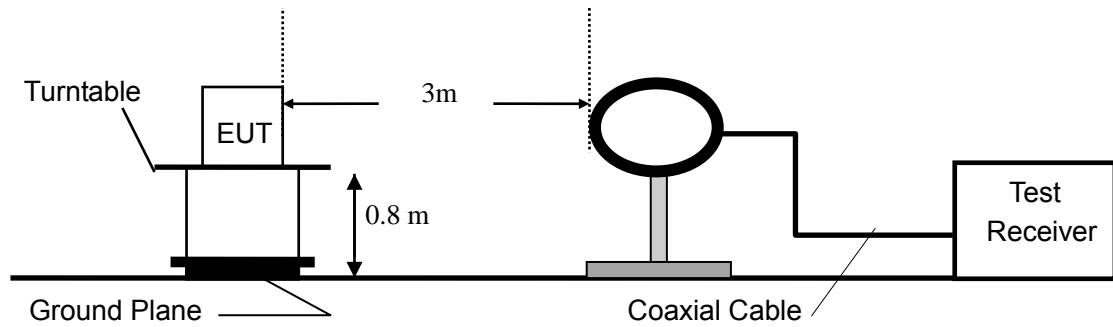

4.1.2 Radiated Emission Test Set-Up, Frequency above 1GHz

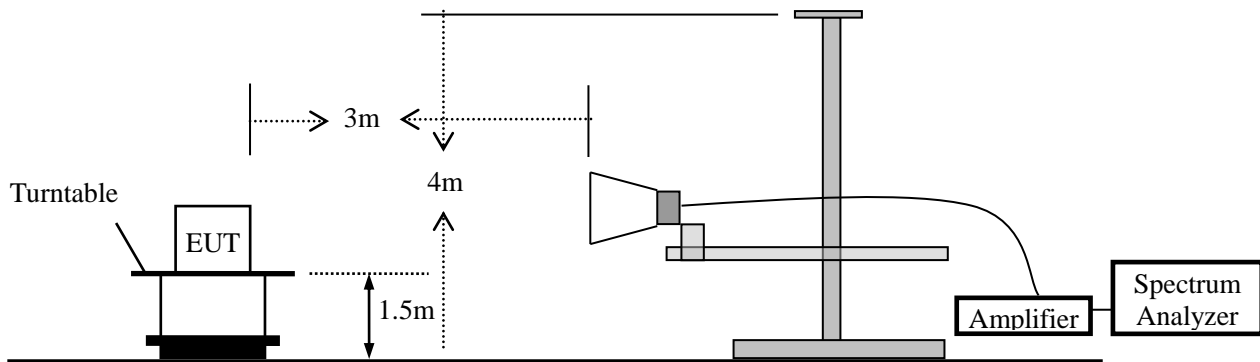

4.2 Measurement Procedure

- a. Blow 1GHz, the EUT was placed on the top of a rotating table 0.8 meters above the ground at a 3 meter semi- anechoic chamber room.
- b. For the radiated emission test above 1GHz:
The EUT was placed on the top of a rotating table 1.5 meters above the ground at a 3 meter full anechoic chamber room. The table was rotated 360 degrees to determine the position of the highest radiation. Place the measurement antenna away from each area of the EUT determined to be a source of emissions at the specified measurement distance, while keeping the measurement antenna aimed at the source of emissions at each frequency of significant emissions, with polarization oriented for maximum response. The measurement antenna may have to be higher or lower than the EUT, depending on the radiation pattern of the emission and staying aimed at the emission source for receiving the maximum signal. The final measurement antenna elevation shall be that which maximizes the emissions. The measurement antenna elevation for maximum emissions shall be restricted to a range of heights of from 1 m to 4 m above the ground or reference ground plane.
- c. The EUT was set 3 meters away from the interference-receiving antenna, which was mounted on the top of a variable-height antenna tower.
- d. The height of antenna is varied from one meter to four meters above the ground to determine the maximum value of the field strength. Both horizontal and vertical polarizations of the antenna are set to make the measurement.
- e. For each suspected emission, the EUT was arranged to its worst case and then the antenna was tuned to heights from 1 meter to 4 meters and the rotatable table was turned from 0 degrees to 360 degrees to find the maximum reading. The test-receiver system was set to peak detect function and specified bandwidth with maximum hold mode.
- f. A Quasi-peak measurement was then made for that frequency point for below 1GHz test. PK and AV for above 1GHz emission test.

During the radiated emission test, the spectrum analyzer was set with the following configurations:

Frequency Band (MHz)	Level	Resolution Bandwidth	Video Bandwidth
30 to 1000	QP	120 kHz	300 kHz
Above 1000	Peak	1 MHz	3 MHz
	Average	1 MHz	10 Hz

4.3 Limit

Frequency range MHz	Distance Meters	Field Strengths Limit (15.209)	
		μV/m	
0.009 ~ 0.490	300	2400/F(kHz)	
0.490 ~ 1.705	30	24000/F(kHz)	
1.705 ~ 30	30	30	
30 ~ 88	3	100	
88 ~ 216	3	150	
216 ~ 960	3	200	
Above 960	3	500	
Frequency range MHz	Distance Meters	Field Strengths Limit (15.249)	
		mV/m (Field strength of fundamental)	μV/m (Field strength of Harmonics)
902 ~ 928	3	50	500
2400 ~ 2483.5	3	50	500
5725 ~ 5875	3	50	500
24000 ~ 2425000	3	250	2500

- Remark : (1) Emission level (dB) μ V = 20 log Emission level μ V/m
 (2) The smaller limit shall apply at the cross point between two frequency bands.
 (3) As shown in 15.35(b), for frequencies above 1000MHz, the field strength limits are based on average detector, however, the peak field strength of any emission shall not exceed the maximum permitted average limits, specified above by more than 20dB under any condition of modulation.
 (4) The frequency range scanned is from the lowest radio frequency signal generated in the device which is greater than 9 kHz to the tenth harmonic of the highest fundamental frequency or 40 GHz, whichever is lower.
 (5) Sample of data calculate:
 Level=Reading + Factor; Margin= Level-Limit
 Factor=CF+AF+AG
 Where CF=Cable attenuation factor in dB
 AF= Antenna factor in dB
 AG=Amplifier Gain in dB

4.4 Measurement Results

Please refer to following the test plots of the worst case: High channel.



Dongguan NTC Co., Ltd.
 Tel:+86-769-22022444 Fax:+86-769-22022799
 Web: [Http://www.ntc-c.com](http://www.ntc-c.com)

Radiated Emission Measurement

File :GP8 Data :#39 Date: 2018-1-16 Time: 21:44:29

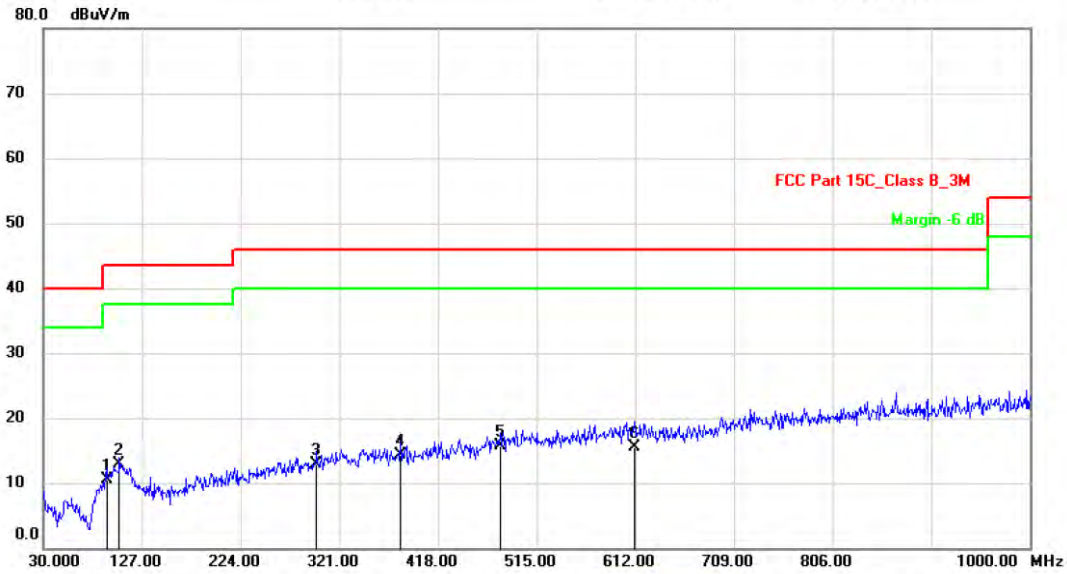

Site: Polarization: *Horizontal* Temperature: 26
 Limit: FCC Part 15C_Class B_3M Power: DC3V Humidity: 47 %
 EUT: Distance: 3m
 M/N: GP8
 Mode: TX
 Note: High (AmazonBasics Full-Size Ergonomic Wireless Mouse with Fast Scrolling)

No.	Mk.	Freq.	Reading Level	Correct Factor	Measurement	Limit	Over	Antenna Height	Table Degree	
		MHz	dBuV	dB	dBuV/m	dBuV/m	dB	cm	degree	Comment
1		92.0800	24.05	-13.45	10.60	43.50	-32.90			QP
2		104.6900	25.16	-12.16	13.00	43.50	-30.50			QP
3		298.6900	23.40	-10.50	12.90	46.00	-33.10			QP
4		381.1400	23.50	-9.20	14.30	46.00	-31.70			QP
5	*	479.1100	22.94	-7.24	15.70	46.00	-30.30			QP
6		611.0300	20.62	-5.02	15.60	46.00	-30.40			QP

*:Maximum data x:Over limit !:over margin (Reference Only)

Note: Below 30MHz, the emissions are lower than 20dB below the allowable limit.



Dongguan NTC Co., Ltd.
 Tel:+86-769-22022444 Fax:+86-769-22022799
 Web: [Http://www.ntc-c.com](http://www.ntc-c.com)

Radiated Emission Measurement

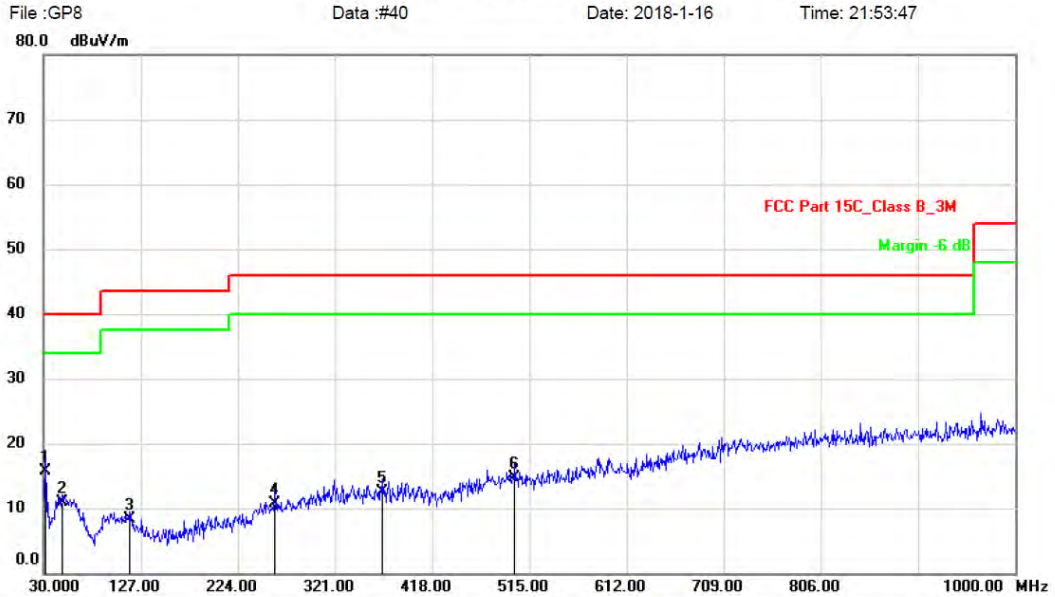

Site Polarization: *Vertical* Temperature: 26
 Limit: FCC Part 15C_Class B_3M Power: DC3V Humidity: 47 %
 EUT: Distance: 3m
 M/N: GP8
 Mode: TX
 Note: High (AmazonBasics Full-Size Ergonomic Wireless Mouse with Fast Scrolling)

No.	Mk.	Freq. MHz	Reading Level dBuV	Correct Factor dB	Measure- ment dBuV/m	Limit dBuV/m	Over dB	Antenna Height cm	Table Degree	Comment
1	*	31.9400	31.47	-15.77	15.70	40.00	-24.30	QP		
2		48.4300	24.32	-13.42	10.90	40.00	-29.10	QP		
3		116.3300	24.65	-16.25	8.40	43.50	-35.10	QP		
4		260.8599	24.21	-13.41	10.80	46.00	-35.20	QP		
5		368.5300	23.77	-11.17	12.60	46.00	-33.40	QP		
6		500.4500	23.56	-8.76	14.80	46.00	-31.20	QP		

*:Maximum data x:Over limit !:over margin (Reference Only)

Note: Below 30MHz, the emissions are lower than 20dB below the allowable limit.



Frequency Range:	1-25GHz	Test Date :	January 17, 2018
Test Result:	PASS	Temperature :	21 °C
Measured Distance:	3m	Humidity :	55 %
Test By:	Sance		

Freq. (MHz)	Ant.Pol. (H/V)	Reading Level(dBuV)		Factor (dB/m)	Emission Level (dBuV)		Limit 3m (dBuV/m)		Margin (dB)	
		PK	AV		PK	AV	PK	AV	PK	AV
Operation Mode: TX Mode (Low)										
2408	V	84.80	58.85	0.15	84.95	/	114.00	94.00	-29.05	/
4816	V	50.79	36.27	6.36	57.15	42.63	74.00	54.00	-16.85	-11.37
7224	V	46.79	31.92	10.46	57.25	42.38	74.00	54.00	-16.75	-11.62

2408	H	92.58	63.20	0.15	92.73	/	114.00	94.00	-21.27	/
4816	H	55.61	38.73	6.36	61.97	45.09	74.00	54.00	-12.03	-8.91
7224	H	45.96	31.70	10.46	56.42	42.16	74.00	54.00	-17.58	-11.84

Operation Mode: TX Mode (Mid)										
2440	V	86.24	58.77	0.23	86.47	/	114.00	94.00	-27.53	/
4880	V	49.25	34.61	6.60	55.85	41.21	74.00	54.00	-18.15	-12.79
7320	V	47.02	31.59	10.55	57.57	42.14	74.00	54.00	-16.43	-11.86

2440	H	91.08	60.61	0.23	91.31	/	114.00	94.00	-22.69	/
4880	H	55.05	38.89	6.60	61.65	45.49	74.00	54.00	-12.35	-8.51
7320	H	46.65	31.40	10.55	57.20	41.95	74.00	54.00	-16.80	-12.05

Operation Mode: TX Mode (High)										
2474	V	84.44	58.39	0.33	84.77	/	114.00	94.00	-29.23	/
4948	V	48.93	34.74	6.85	55.78	41.59	74.00	54.00	-18.22	-12.41
7422	V	47.00	32.44	10.59	57.59	43.03	74.00	54.00	-16.41	-10.97

2474	H	92.71	63.91	0.33	93.04	/	114.00	94.00	-20.96	/
4948	H	54.42	38.32	6.85	61.27	45.17	74.00	54.00	-12.73	-8.83
7422	H	45.48	31.87	10.59	56.07	42.46	74.00	54.00	-17.93	-11.54

- Note:**
- (1) All Readings are Peak Value and AV.
 - (2) Emission Level= Reading Level + Factor
 - (3) Factor= Antenna Gain + Cable Loss – Amplifier Gain
 - (4) Data of measurement within this frequency range shown “ ---” in the table above means the readingOf emissions are attenuated more than 10dB below the permissible limits.
 - (5) Measurement uncertainty : ±3.7dB.
 - (6) Horn antenna used for the emission over 1000MHz.
 - (7) Due to the highest Peak emission level below AVG limit, therefore, the AVG emission level is deemed to meet the requirements, no AVG result record.

5. 20dB Bandwidth

5.1 Measurement Procedure

The 20dB bandwidth of the emission was contained within the frequency band designated which the EUT operated. The effects, if any, from frequency sweeping, frequency hopping, other modulation techniques and frequency stability over excepted variations in temperature and supply voltage were considered, FCC Rule 15.215(c):

The antenna port of the EUT was connected to the input of a spectrum analyzer. Analyzer RBW was chosen so that the display was a result of the hopping channel modulation. For each RF output channel investigated, the spectrum analyzer center frequency was set to the channel carrier. Use the spectrum 20dB down delta function to measure the bandwidth.

5.2 Test SET-UP (Block Diagram of Configuration)

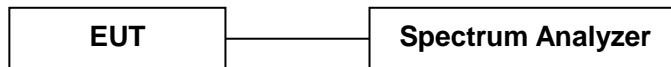

5.3 Measurement Results

Refer to attached data chart.

RBW:	30KHz	VBW:	100KHz
Spectrum Detector:	PK	Temperature :	22 °C
Test By:	Sance	Humidity :	54 %
Test Result:	PASS	Test Date :	January 17, 2018

Channel frequency (MHz)	20dB Down BW(kHz)
2408	2120
2440	2120
2474	2100

Lowest Channel

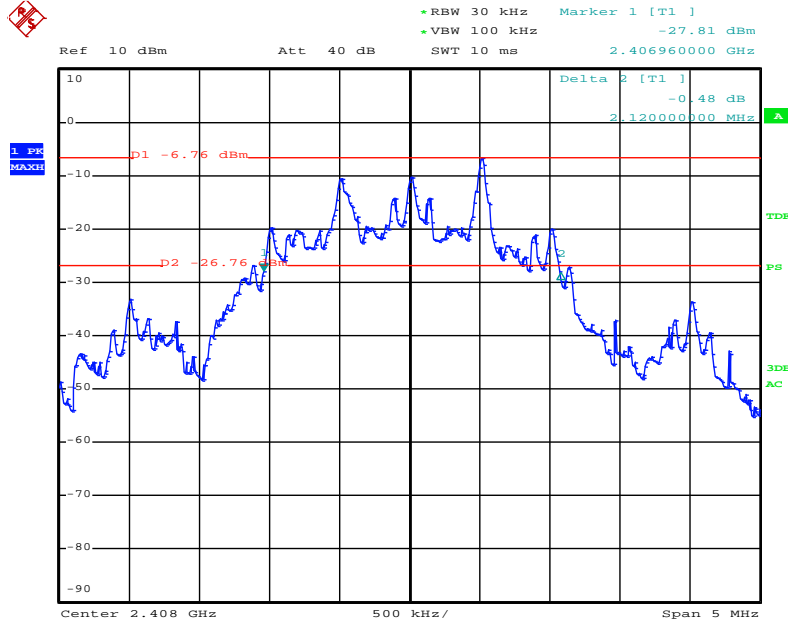

Date: 17.JAN.2018 16:23:18

Middle Channel

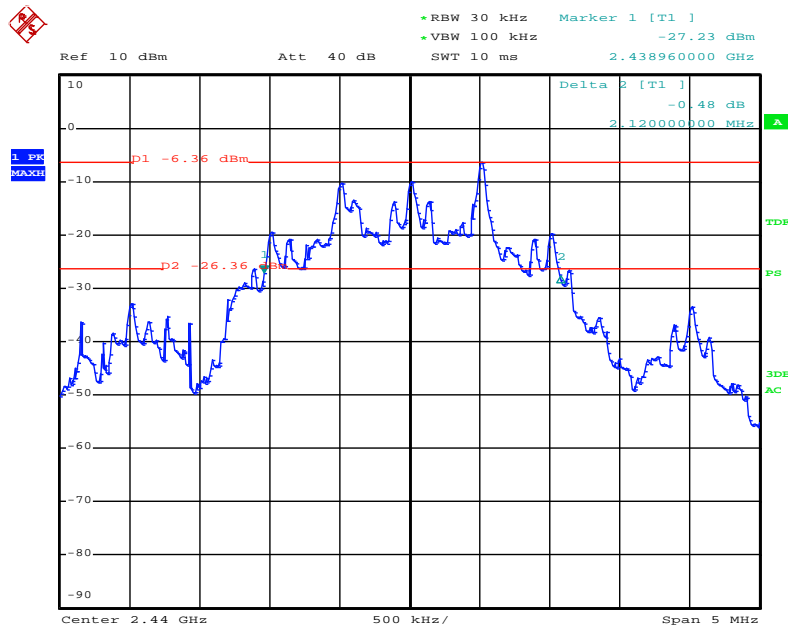

Date: 17.JAN.2018 16:28:44

Highest Channel

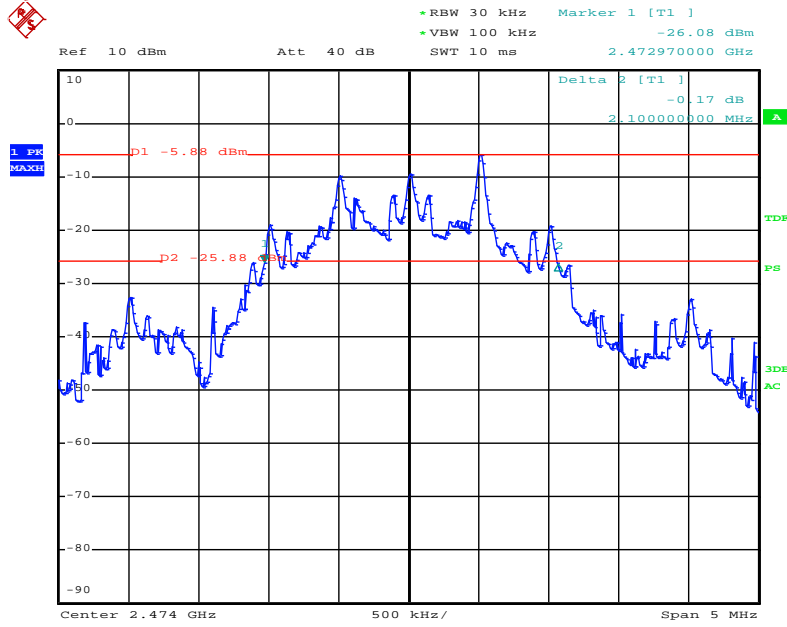

Date: 17.JAN.2018 16:34:24



6. Band Edge

6.1 Measurement Procedure

Same as Radiated Emission Test.

6.2 Limit

Emissions radiated outside of the specified frequency bands, except for harmonics, shall be attenuated by at least 50 dB below the level of the fundamental or to the general radiated emission limits in §15.209, whichever is the lesser attenuation.

6.3 Measurement Results

Operation Mode:	TX Mode	Test Date :	January 17, 2018
Temperature :	21 °C	Humidity :	55 %
Test Result:	PASS	Test By:	Sance
Measured Distance:	3m		

Freq. (MHz)	Ant.Pol. (H/V)	Reading Level(dBuV)		Factor (dB/m)	Emission Level (dBuV)		Limit 3m (dBuV/m)		Margin (dB)	
		PK	AV		PK	AV	PK	AV	PK	AV
2399.680	H	63.78	41.72	0.13	63.91	41.85	74.00	54.00	-10.09	-12.15
2399.000	V	55.47	36.83	0.13	55.60	36.96	74.00	54.00	-18.40	-17.04
2485.480	H	61.67	39.43	0.37	62.04	39.80	74.00	54.00	-11.96	-14.20
2485.000	V	54.15	35.08	0.37	54.52	35.45	74.00	54.00	-19.48	-18.55

- Note:**
- (1) Emission Level= Reading Level + Factor
 - (2) Factor= Antenna Gain + Cable Loss – Amplifier Gain
 - (3) Horn antenna used for the emission over 1000MHz.

Low channel
Horizontal

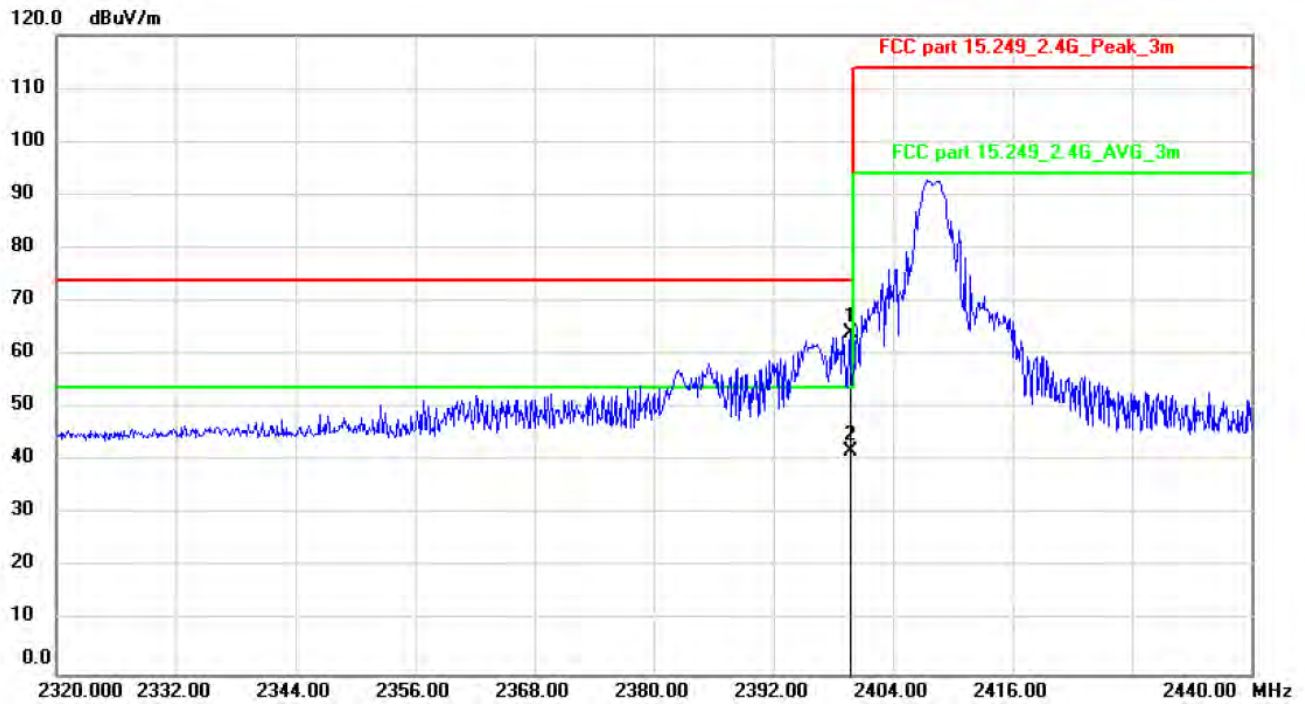

Vertical

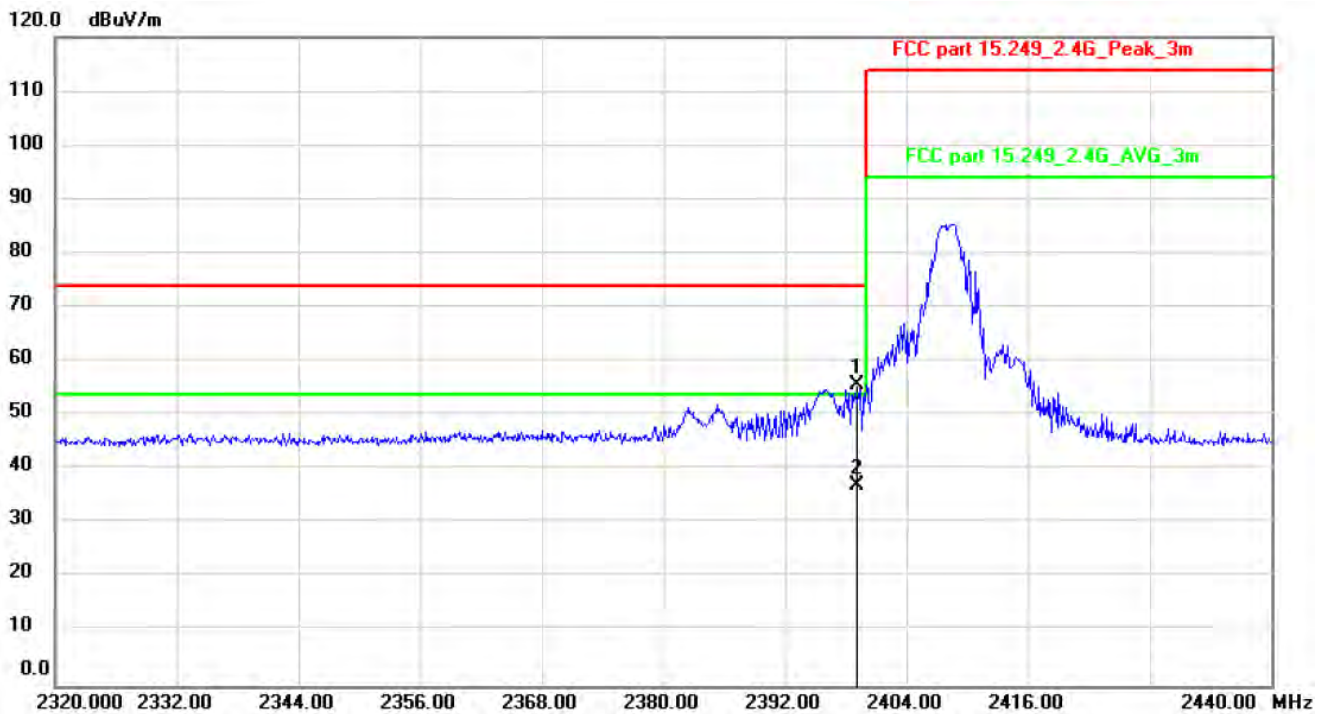

High channel
Horizontal

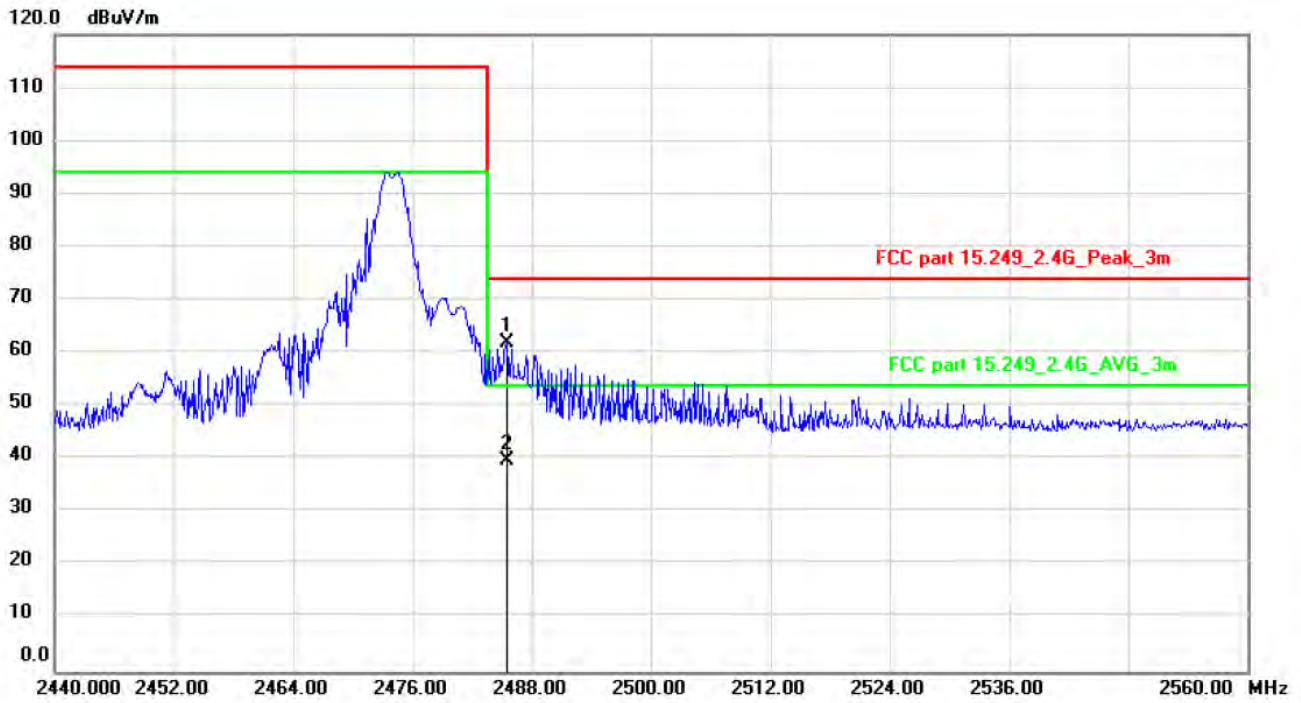

Vertical

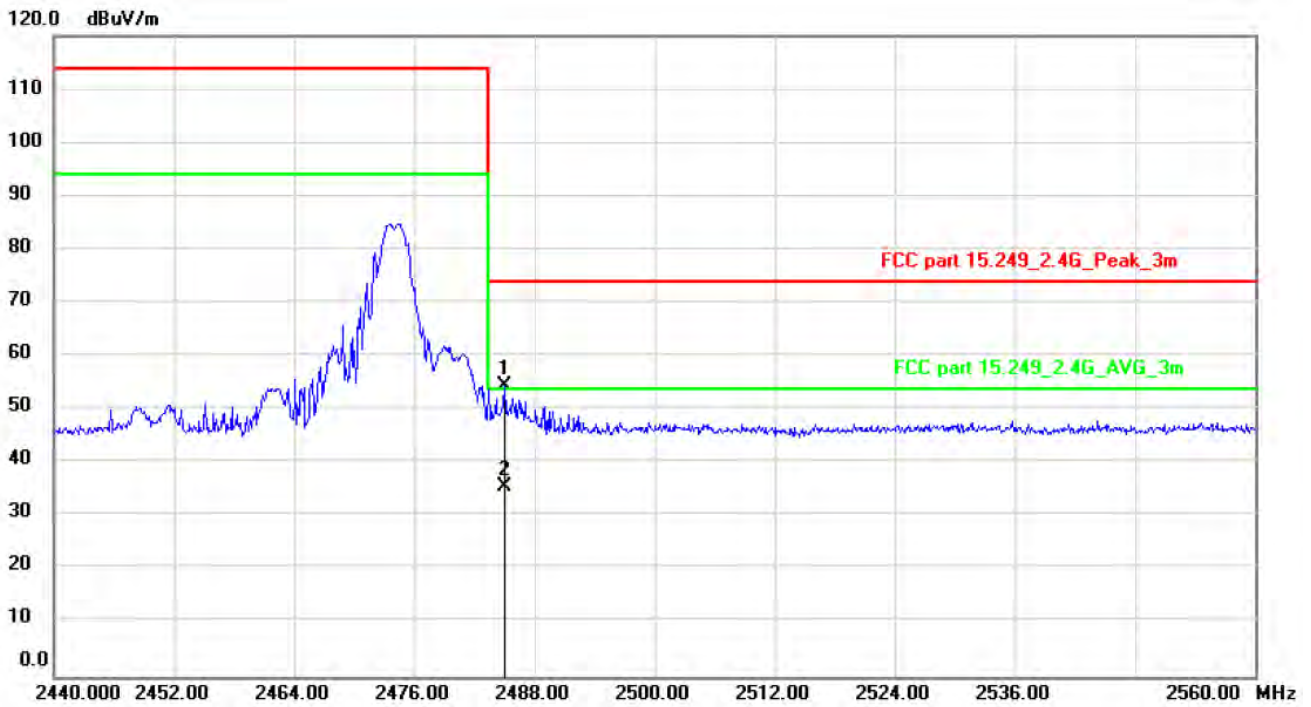

7. Antenna requirement

7.1 Measurement Procedure

According to of FCC part 15C section 15.203:

An intentional radiator shall be designed to ensure that no antenna other than that furnished by the responsible party shall be used with the device. The use of a permanently attached antenna or of an antenna that uses a unique coupling to the intentional radiator, the manufacturer may design the unit so that a broken antenna can be replaced by the user, but the use of a standard antenna jack or electrical connector is prohibited.

Systems operating in the 2400-2483.5MHz band that are used exclusively for fixed, point-to-point operations may employ transmitting antennas with directional gain greater than 6dBi provided the maximum peak output power of the intentional radiator is reduced by 1dB for every 3dB that the directional gain of the antenna exceeds 6dBi.

7.2 Measurement Results

The antenna is PCB antenna and no consideration of replacement, and the best case gain of the antenna is -1.0dBi. So, the antenna is consider meet the requirement.

8. Test Equipment List

Description	Manufacturer	Model Number	Serial Number	Characteristics	Calibration Date	Calibration Due Date
Test Receiver	Rohde & Schwarz	ESCI7	100837	9KHz~7GHz	Mar. 14, 2017	Mar. 13, 2018
Antenna	Schwarzbeck	VULB9162	9162-010	30MHz~7GHz	Mar. 15, 2017	Mar. 14, 2018
Cable	Huber+Suhner	CBL2-NN-1M	22390001	9KHz~7GHz	Mar. 14, 2017	Mar. 13, 2018
Cable	Huber+Suhner	CIL02	N/A	9KHz~7GHz	Mar. 14, 2017	Mar. 13, 2018
RF Cable	Huber+Suhner	SF-104	MY16559/4	9KHz~25GHz	Apr. 25, 2017	Apr. 25, 2018
Power Amplifier	HP	HP 8447D	1145A00203	100KHz~1.3GHz	Mar. 14, 2017	Mar. 13, 2018
Horn Antenna	Schwarzbeck	BBHA9170	9170-242	15GHz~40GHz	Mar. 14, 2017	Mar. 13, 2018
Horn Antenna	Com-Power	AH-118	071078	1GHz~18GHz	Mar. 15, 2017	Mar. 14, 2018
RF Cable	Huber+Suhner	SF-104	N/A	9KHz~40GHz	Apr. 25, 2017	Apr. 24, 2018
Loop antenna	Daze	ZA30900A	0708	9KHz~30MHz	Apr. 25, 2017	Apr. 24, 2018
Spectrum Analyzer	Rohde & Schwarz	FSU26	200409/026	20Hz~26.5GHz	Apr. 25, 2017	Apr. 24, 2018
Spectrum Analyzer	Rohde & Schwarz	FSV40	101003	10Hz~40GHz	April. 06, 2017	April. 05, 2018
Pre-Amplifier	EMCI	EMC 184045	980102	18GHz~40GHz	Nov. 04, 2017	Nov. 03, 2018
Pre-Amplifier	Agilent	8449B	3008A02964	1GHz~26.5GHz	Apr. 25, 2017	Apr. 24, 2018
L.I.S.N.	Rohde & Schwarz	ENV 216	101317	9KHz~30MHz	Mar. 14, 2017	Mar. 13, 2018
Temporary antenna connector	TESCOM	SS402	N/A	9KHz-25GHz	N/A	N/A
Power Meter	Anritsu	ML2495A	1139001	100k-65GHz	Nov. 04, 2017	Nov. 03, 2018
Power Sensor	Anritsu	MA2411B	100345	300M-40GHz	Nov. 04, 2017	Nov. 03, 2018

Note: The temporary antenna connector is soldered on the PCB board in order to perform conducted tests and this temporary antenna connector is listed in the equipment list.

---End---