

<b>Prüfbericht-Nr.:</b> <i>Test Report No.:</i>	<b>50055655 001</b>	<b>Auftrags-Nr.:</b> <i>Order No.:</i>	<b>114055392</b>	<b>Seite 1 von 38</b> <i>Page 1 of 38</i>
<b>Kunden-Referenz-Nr.:</b> <i>Client Reference No.:</i>	<b>N/A</b>	<b>Auftragsdatum:</b> <i>Order date:</i>	<b>30-Aug-2016</b>	
<b>Auftraggeber:</b> <i>Client:</i>	<b>ACROX Technologies Co., Ltd., 4F., No. 89, Minshan St., Neihu Dist., Taipei City, Taiwan, R.O.C.</b>			
<b>Prüfgegenstand:</b> <i>Test item:</i>	<b>Slim Bluetooth Mouse for Mac</b>			
<b>Bezeichnung / Typ-Nr.:</b> <i>Identification / Type No.:</i>	<b>NS-PNM72B-WH</b>			
<b>Auftrags-Inhalt:</b> <i>Order content:</i>	<b>FCC Part15C / IC RSS-247 Test report (BDR)</b>			
<b>Prüfgrundlage:</b> <i>Test specification:</i>	<b>FCC 47CFR Part 15: Subpart C Section 15.247 RSS-247 (05-2015)</b>			
<b>Wareneingangsdatum:</b> <i>Date of receipt:</i>	<b>3-Sep-2016</b>			
<b>Prüfmuster-Nr.:</b> <i>Test sample No.:</i>	<b>A000416270-001</b>			
<b>Prüfzeitraum:</b> <i>Testing period:</i>	<b>5-Sep-2016 - 8-Sep-2016</b>			
<b>Ort der Prüfung:</b> <i>Place of testing:</i>	<b>EMC Laboratory Taipei</b>			
<b>Prüflaboratorium:</b> <i>Testing laboratory:</i>	<b>TUV Rheinland Taiwan Ltd.</b>			
<b>Prüfergebnis*:</b> <i>Test result*:</i>	<b>Pass</b>			
<b>geprüft von / tested by:</b>		<b>kontrolliert von / reviewed by:</b>		
2016-09-20 Amy S.R.Hsu /Engineer		2016-09-20 Rene Charton/Senior Project Manager		
<b>Datum</b> <i>Date</i>	<b>Name / Stellung</b> <i>Name / Position</i>	<b>Unterschrift</b> <i>Signature</i>	<b>Datum</b> <i>Date</i>	<b>Name / Stellung</b> <i>Name / Position</i>
				<b>Unterschrift</b> <i>Signature</i>
<b>Sonstiges / Other:</b>				
<b>Zustand des Prüfgegenstandes bei Anlieferung:</b> <i>Condition of the test item at delivery:</i>		<b>Prüfmuster vollständig und unbeschädigt</b> <i>Test item complete and undamaged</i>		
<p>* Legende: 1 = sehr gut      2 = gut      3 = befriedigend      4 = ausreichend      5 = mangelhaft  P(ass) = entspricht o.g. Prüfgrundlage(n)      F(ail) = entspricht nicht o.g. Prüfgrundlage(n)      N/A = nicht anwendbar      N/T = nicht getestet</p> <p>Legend: 1 = very good      2 = good      3 = satisfactory      4 = sufficient      5 = poor  P(ass) = passed a.m. test specification(s)      F(ail) = failed a.m. test specification(s)      N/A = not applicable      N/T = not tested</p>				
<p><b>Dieser Prüfbericht bezieht sich nur auf das o.g. Prüfmuster und darf ohne Genehmigung der Prüfstelle nicht auszugsweise vervielfältigt werden. Dieser Bericht berechtigt nicht zur Verwendung eines Prüfzeichens.</b>  <i>This test report only relates to the a. m. test sample. Without permission of the test center this test report is not permitted to be duplicated in extracts. This test report does not entitle to carry any test mark.</i></p>				

## TEST SUMMARY

### 5.1.1 ANTENNA REQUIREMENT

RESULT: *Passed*

### 5.1.2 PEAK OUTPUT POWER

RESULT: *Passed*

### 5.1.3 20dB BANDWIDTH

RESULT: *Passed*

### 5.1.4 99% BANDWIDTH

RESULT: *Passed*

### 5.1.5 CONDUCTED SPURIOUS EMISSIONS AND FREQUENCY BAND EDGE MEASURED IN 100KHZ BANDWIDTH

RESULT: *Passed*

### 5.1.6 SPURIOUS EMISSION

RESULT: *Passed*

### 5.1.7 FREQUENCY SEPARATION

RESULT: *Passed*

### 5.1.8 NUMBER OF HOPPING FREQUENCY

RESULT: *Passed*

### 5.1.9 TIME OF OCCUPANCY

RESULT: *Passed*

### 6.1.1 ELECTROMAGNETIC FIELDS

RESULT: *Passed*

## Contents

<b>1.</b>	<b>GENERAL REMARKS .....</b>	<b>5</b>
<b>1.1</b>	<b>COMPLEMENTARY MATERIALS.....</b>	<b>5</b>
<b>2.</b>	<b>TEST SITES .....</b>	<b>6</b>
<b>2.1</b>	<b>TEST LABORATORY .....</b>	<b>6</b>
<b>2.2</b>	<b>TEST FACILITY.....</b>	<b>6</b>
<b>2.3</b>	<b>LIST OF TEST AND MEASUREMENT INSTRUMENTS.....</b>	<b>7</b>
<b>2.4</b>	<b>TRACEABILITY .....</b>	<b>8</b>
<b>2.5</b>	<b>CALIBRATION .....</b>	<b>8</b>
<b>2.6</b>	<b>MEASUREMENT UNCERTAINTY .....</b>	<b>8</b>
<b>3.</b>	<b>GENERAL PRODUCT INFORMATION.....</b>	<b>9</b>
<b>3.1</b>	<b>PRODUCT FUNCTION AND INTENDED USE .....</b>	<b>9</b>
<b>3.2</b>	<b>SYSTEM DETAILS AND RATINGS.....</b>	<b>9</b>
<b>3.3</b>	<b>INDEPENDENT OPERATION MODES.....</b>	<b>10</b>
<b>3.4</b>	<b>NOISE GENERATING AND NOISE SUPPRESSING PARTS .....</b>	<b>11</b>
<b>3.5</b>	<b>SUBMITTED DOCUMENTS.....</b>	<b>11</b>
<b>4.</b>	<b>TEST SET-UP AND OPERATION MODES.....</b>	<b>12</b>
<b>4.1</b>	<b>PRINCIPLE OF CONFIGURATION SELECTION .....</b>	<b>12</b>
<b>4.2</b>	<b>TEST OPERATION AND TEST SOFTWARE.....</b>	<b>12</b>
<b>4.3</b>	<b>SPECIAL ACCESSORIES AND AUXILIARY EQUIPMENT .....</b>	<b>12</b>
<b>4.4</b>	<b>COUNTERMEASURES TO ACHIEVE EMC COMPLIANCE.....</b>	<b>13</b>
<b>4.5</b>	<b>TEST SETUP DIAGRAM .....</b>	<b>13</b>
<b>5.</b>	<b>TEST RESULTS .....</b>	<b>15</b>
<b>5.1</b>	<b>TRANSMITTER REQUIREMENT &amp; TEST SUITES.....</b>	<b>15</b>
<b>5.1.1</b>	<i>Antenna Requirement .....</i>	<i>15</i>
<b>5.1.2</b>	<i>Peak Output Power .....</i>	<i>16</i>
<b>5.1.3</b>	<i>20dB Bandwidth .....</i>	<i>17</i>
<b>5.1.4</b>	<i>99% Bandwidth .....</i>	<i>20</i>
<b>5.1.5</b>	<i>Conducted spurious emissions and Frequency Band Edge measured in 100kHz Bandwidth.....</i>	<i>22</i>
<b>5.1.6</b>	<i>Spurious Emission .....</i>	<i>27</i>
<b>5.1.7</b>	<i>Frequency Separation.....</i>	<i>28</i>
<b>5.1.8</b>	<i>Number of hopping frequency.....</i>	<i>30</i>
<b>5.1.9</b>	<i>Time of Occupancy .....</i>	<i>32</i>
<b>6.</b>	<b>SAFETY HUMAN EXPOSURE .....</b>	<b>34</b>

<b>6.1</b>	<b>RADIO FREQUENCY EXPOSURE COMPLIANCE .....</b>	<b>34</b>
6.1.1	<i>Electromagnetic Fields.....</i>	<i>34</i>
<b>7.</b>	<b>PHOTOGRAPHS OF THE TEST SET-UP.....</b>	<b>35</b>
<b>8.</b>	<b>LIST OF TABLES .....</b>	<b>38</b>
<b>9.</b>	<b>LIST OF PHOTOGRAPHS.....</b>	<b>38</b>

## 1. General Remarks

### 1.1 Complementary Materials

The following attachments are integral parts of this test report:

**Appendix P: Photo Documentation**  
(File Name: 50055655APPENDIX P)

**Appendix D: Test Result of Radiated Emissions**  
(File Name: 50055655APPENDIX D)

Test Specifications

The following standards were applied

**Table 1: Applied Standard and Test Levels**

<b>Radio</b>
FCC CFR47 Part 15: Subpart C Section 15.247 RSS-247 Issue 1 May 2015 RSS-Gen, Issue 4, November 2014 ANSI C63.10:2013

## 2. Test Sites

### 2.1 Test Laboratory

TUV Rheinland Taiwan Ltd.  
Taichung Branch Office

No.9, Lane 36, Minsheng Rd., Sec. 3, Daya District,  
Taichung City 428  
Taiwan (R.O.C.)

### 2.2 Test Facility

TUV Rheinland Taiwan Ltd.  
Taipei Office

11F. No.758, Sec. 4, Bade Rd., Songshan Dist.  
Taipei City 105  
Taiwan (R.O.C.)

FCC RegistrationNo.: 799772  
IC Canada Registration No.: 9465A-1  
TAF Accredited NCC Test Lab. No.:0759  
TAF ISO17025 Certification effective periods: 2016-Jul-1st to 2019-Jun-30<sup>th</sup>



**Testing Laboratory**  
**0759**

## 2.3 List of Test and Measurement Instruments

**Table 2: List of Test and Measurement Equipment**

Kind of Equipment	Manu-facturer	Type	S/N	Last Calibration	Next Calibration
Test Software	Farad	EZ_EMCC	Ver. TUV3A1	N/A	N/A
EMI Test Receiver	R&S	ESR7	101062	2015/09/10	2016/09/10
Spectrum Analyzer	R&S	FSV 40	100921	2016/04/21	2017/04/21
Spectrum Analyzer	Agilent	N9010A	MY53470241	2016/04/25	2017/04/24
Preamplifier (30MHz -1GHz)	HP	8447F	2805A03335	2016/07/29	2017/07/29
Preamplifier (18 GHz -40 GHz)	COM-POWER	PAM-840	461257	2015/11/19	2016/11/19
Pre-Amplifier (1GHz~18GHz)	EM Electronics	EM01G18G	060558	2015/11/19	2016/11/19
Bilog Antenna	TESEQ	CBL6111D	29804	2016/06/23	2017/06/23
Horn Antenna	ETS-Lindgren	3117	138160	2016/05/03	2017/05/03
Horn Antenna (18GHz~40GHz)	COM-POWER	AH840	101031	2015/11/02	2016/11/02
Loop Antenna	Schwarzbeck	FMZB 1513	1513-076	2016/05/11	2017/05/11
EMI Test Receiver	R&S	ESCI7	100797	2015/12/28	2016/12/27
Temp. & Humid. Chamber	Giant Force	GCT-099-40-S	MAF0103-007	2015/07/13	2017/07/12
LISN (1 phase)	R&S	ENV216	101243	2016/06/02	2017/06/02
LISN	R&S	ENV216	101262	2016/06/16	2017/06/16
Test Software	Audix	e3	Ver. 9	N/A	N/A
Power sensor	Agilent	U2021XA	MY53480013	2016/03/11	2017/03/10

## 2.4 Traceability

All measurement equipment calibrations are traceable to NML(Taiwan)/NIST(USA) or where calibration is performed outside Taiwan, to equivalent nationally recognized standards organizations.

## 2.5 Calibration

requiring calibration is calibrated periodically in a suitably accredited Calibration Lab. Additionally all equipment is verified for proper performance on a regular basis using in house standards or comparisons.

## 2.6 Measurement Uncertainty

The estimated combined standard uncertainty for radiated emissions and conducted emissions measurements:.

**Table 3: Emission Measurement Uncertainty**

Parameter	Uncertainty
RF power, conducted	$\pm 1.5$ dB
Adjacent channel power	$\pm 3$ dB
Radiated emission of transmitter, valid up to 26 GHz	$\pm 6$ dB
Radiated emission of receiver, valid up to 26 GHz	$\pm 6$ dB
Temperature	$\pm 2$ °C
Humidity	$\pm 10$ %



### 3. General Product Information

#### 3.1 Product Function and Intended Use

The EUT is a Bluetooth Mouse. It contains a Bluetooth BDR compatible module enabling the user to communicate data through a Wireless interface.  
For details refer to the User Guide, Data Sheet and Circuit Diagram.

#### 3.2 System Details and Ratings

**Table 4: Basic Information of EUT**

Item	EUT information
Kind of Equipment/Test Item	Slim Bluetooth Mouse for Mac
Type Identification	NS-PNM72B-WH
FCC ID	PRDMU42
Canada ID	6180A-BAF
Canada HVIN	BAF

**Table 5: Technical Specification of EUT**

Technical Specification	Value
Operating Frequency	2402 MHz ~ 2480 MHz
Channel Spacing	1 MHz
Channel number	79
Operation Voltage	3 Vdc
Modulation	GFSK,
Antenna gain	2.78 dBi

**Table 6: Frequency hopping information**

Technical Specification	Description
Hopping Range	<p>Hereby we declare that the maximum frequency of this device is: 2402-2480MHz. This is according the Bluetooth Core Specification V2.1+EDR for devices which will be operated in the USA. This was checked during the Bluetooth Qualification tests (Test Case: TRM/CA/04).</p>
Hopping Sequence	<p>Example of a 79 hopping sequence in data mode:</p> <p>33,04,21,44,23,42,53,46,55,48,40,59,72,29,76,31,08,73,07,75,09,45,60,39,58,13,47,11,77,52,35,50,65,54,67,56,69,62,71,64, 7,25,27,66,57,70,74,61,78,63,10,41,05,43,15,44,64,68,02,70,06,01,51,03,55,05,03,66,53,49,36,47,</p>
Receiver input bandwidth	<p>The input bandwidth of the receiver is 1MHz. In every connection one Bluetooth device is the master and the other one is the slave. The master determines the hopping sequence. The slave follows this sequence. Both devices shift between RX and TX time slot according to the clock of the master.</p> <p>Additionally the type of connection is set up at the beginning of the connection. The master adapts its hopping frequency and its TX/RX timing according to the packet type of the connection. Also the slave of the connection will use these settings.</p> <p>Repeating of a packer has no influence on the hopping sequence. The hopping sequence generated by the master of the connection will be followed in any case.</p> <p>That means a repeated packet will not be send on the same frequency, it is send on the next frequency of the hopping sequence.</p>

### 3.3 Independent Operation Modes

The basic operation modes are:

- A. Transmitting
  - 1. Low channel
  - 2. Middle channel
  - 3. High channel
- B. Receiving
- C. Standby
- D. Off

### **3.4 Noise Generating and Noise Suppressing Parts**

Refer to the Circuit Diagram.

### **3.5 Submitted Documents**

- Circuit Diagram
- Instruction Manual
- Rating Label
- Technical Description

## 4. Test Set-up and Operation Modes

### 4.1 Principle of Configuration Selection

The equipment under test (EUT) was configured to measure its maximum power level. The test modes were adapted accordingly in reference to the instructions for use.

### 4.2 Test Operation and Test Software

Setup for testing: Test samples are provided with SPI to USB interface which makes it possible to control them through a test software installed on a notebook computer.

This software was running on the laptop computer connected to the EUT. It was used to enable the operation modes listed in section 3.3 as appropriate.

The samples were used as follows:

Conducted: **A000416270-001**

Radiation: **A000416270-001**

Full test was applied on all test modes, but only worst case was shown.

### 4.3 Special Accessories and Auxiliary Equipment

The product has been tested together with the following additional accessories:

Description	Manufacturer	Model No.	Serial No.
Notebook(EMC-06)	Lenovo	TP00048A	PB-0F8B2

## 4.4 Countermeasures to achieve EMC Compliance

The test sample which has been tested containing the noise suppression parts as in the Photo Appendix and the Test Setup Photos. No additional measures were employed to achieve compliance.

## 4.5 Test Setup Diagram

Diagram of Measurement Configuration for Radiation Test

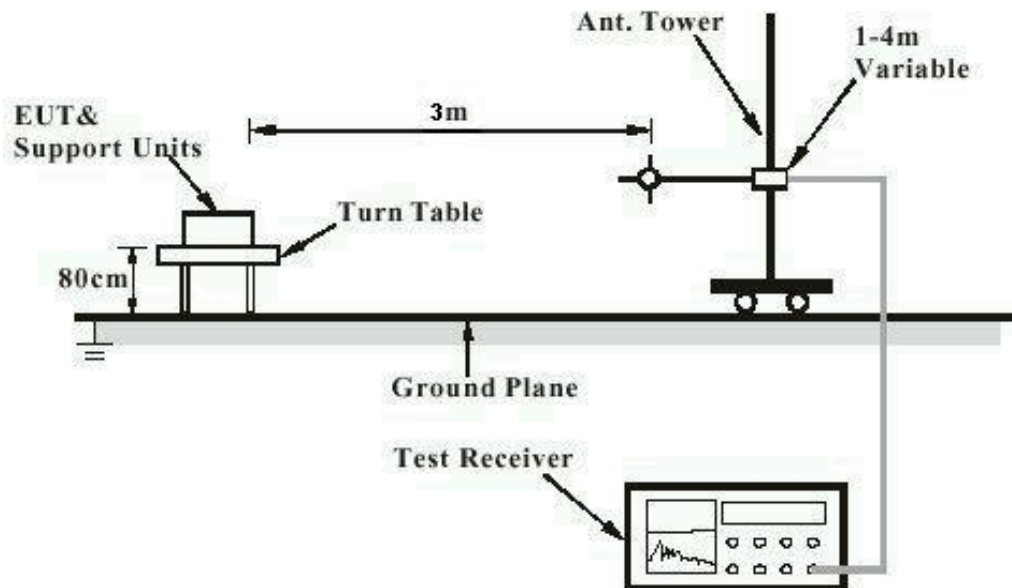

Note: Measurements above 1 GHz are done with a table height of 1.5m

**Diagram of Measurement Equipment Configuration for Mains Conduction Measurement**

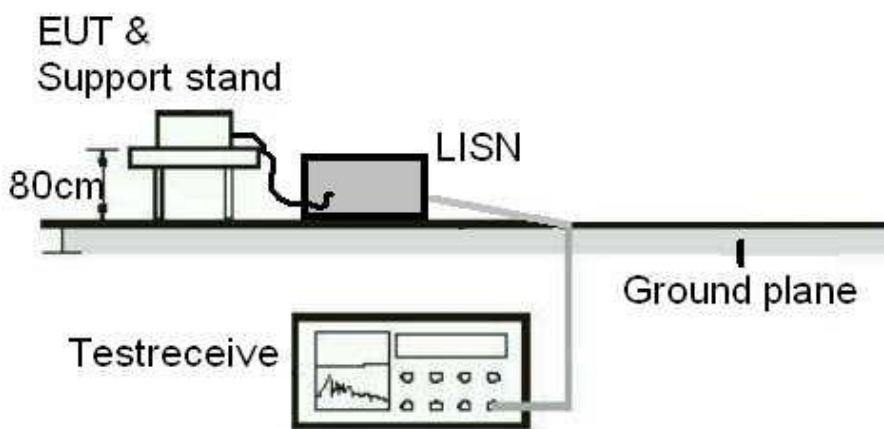

**Diagram of Measurement Equipment Configuration for Conducted Transmitter Measurement**

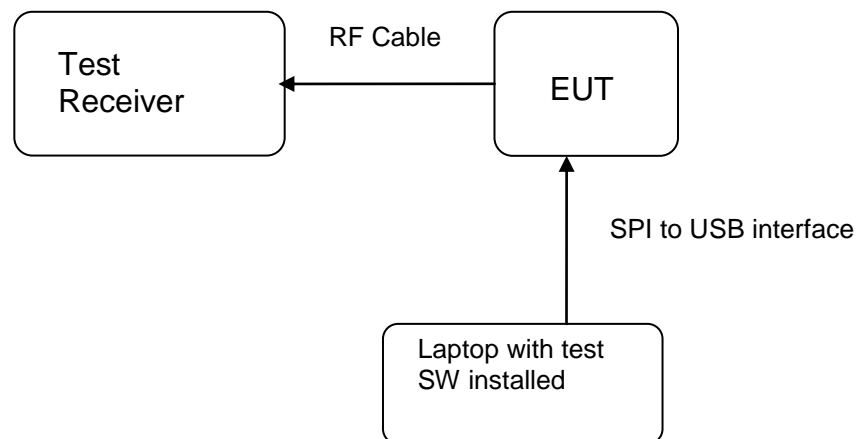

## 5. Test Results

### 5.1 Transmitter Requirement & Test Suites

#### 5.1.1 Antenna Requirement

**RESULT:** **Passed**

Test standard	:	LP0002(2016): 2.2, 3.10.1, (3) FCC Part 15.247(b)(4), Part 15.203 and RSS- Gen 8.3
Requirement	:	use of approved antennas only with directional gains that do not exceed 6 dBi

According to the manufacturer declaration, the EUT has an antenna with a directional gain of 2.78 dBi. The antenna is a printed PCB trace with no possibility of replacement with a non-approved antenna by the end-user. Therefore, the EUT is considered to comply with this provision.

Refer to EUT photo for details.

### 5.1.2 Peak Output Power

**RESULT:**
**Passed**

Date of testing : 25-Mar-2016  
 Test standard : FCC Part 15.247(b)(1),  
 RSS-247 5.4(2)  
 LP0002(2016): 3.10.1, (2)  
 Basic standard : ANSI C63.10:2013  
 LP0002(2016) Appendix II  
 Kind of test site : Shielded room

**Test setup**

Test Channel : Low/ Middle/ High  
 Operation Mode : A  
 Ambient temperature : 22-26 °C  
 Relative humidity : 50-65 %  
 Atmospheric pressure : 100-103 kPa

**Table 7: Test result of Peak Output Power, GFSK modulation**

Channel	Channel Frequency	Peak Output Power		Limit
	(MHz)	(dBm)	(W)	(W)
Low Channel	2402	-13.06	0.000049	0.125
Middle Channel	2441	-12.37	0.000058	0.125
High Channel	2480	-11.89	0.000065	0.125

**Table 8: Test result of AVG Output Power, GFSK modulation**

Channel	Channel Frequency	Peak Output Power		Limit
	(MHz)	(dBm)	(W)	(W)
Low Channel	2402	-14.46	0.00004	0.125
Middle Channel	2441	-13.82	0.00004	0.125
High Channel	2480	-13.46	0.00005	0.125



### 5.1.3 20dB Bandwidth

**RESULT:**
**Passed**

Date of testing : Refer to Screenshot

Test standard : FCC Part 15.247(a)(1),  
RSS-247 5.1(1)  
LP0002(2016): 3.10.1, (6.1.1)

Basic standard : ANSI C63.10:2013  
LP0002(2016) Appendix II

**Test setup**

Test Channel : Low/ Middle/ High

Operation Mode : A

Ambient temperature : 22-26°C

Relative humidity : 50-65%

Atmospheric pressure : 100-103kPa

**Table 9: Test result of 20dB Bandwidth, GFSK modulation**

Channel	Channel Frequency (MHz)	20dB Bandwidth (kHz)	Limit (MHz)	Result
Low Channel	2402	1.040	1.5	Pass
Mid Channel	2441	1.033	1.5	Pass
High Channel	2480	1.029	1.5	Pass

Note: Limit is for Channel Separation of 1 MHz and a power limit of 125 mW.

If the carrier separation frequency of a Bluetooth Device is set at 1 MHz due to the firmware setting and the Bluetooth Standard, then for power <125 mW the limit for the 20 dB Bandwidth, becomes 1 MHz / 0.66666 = 1.5 MHz.

## Test Plot of 20dB Bandwidth, GFSK modulation

### Low Channel

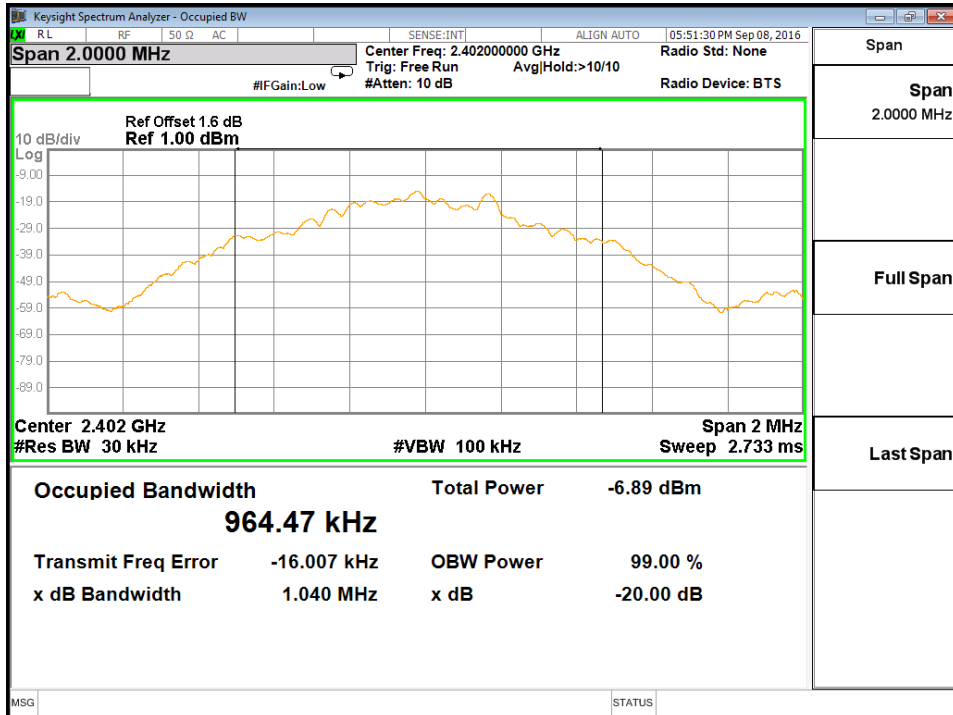

### Middle Channel

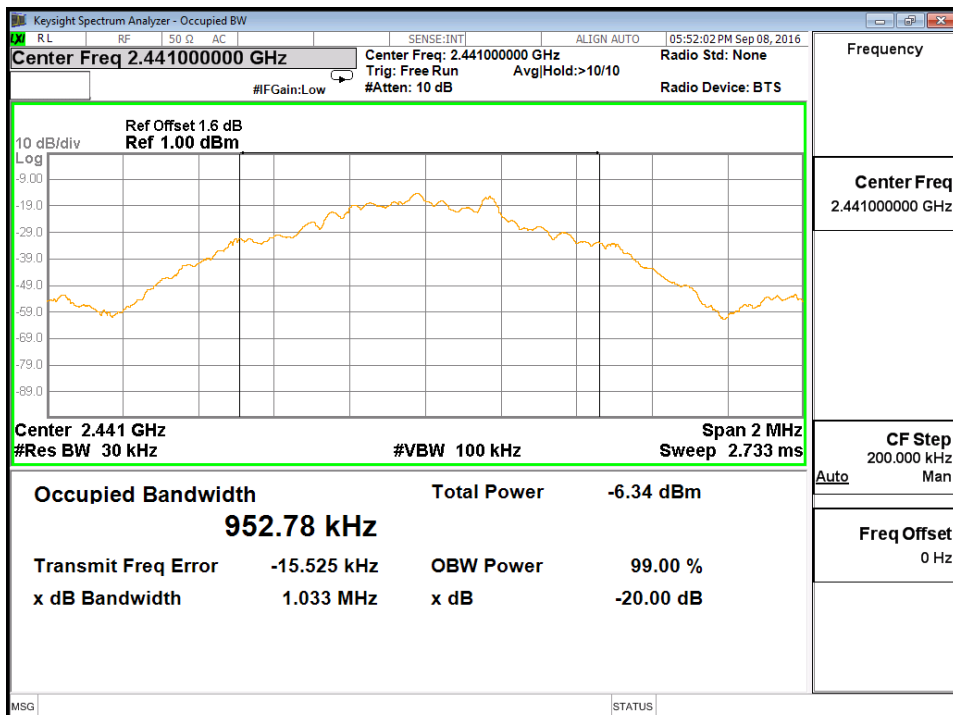

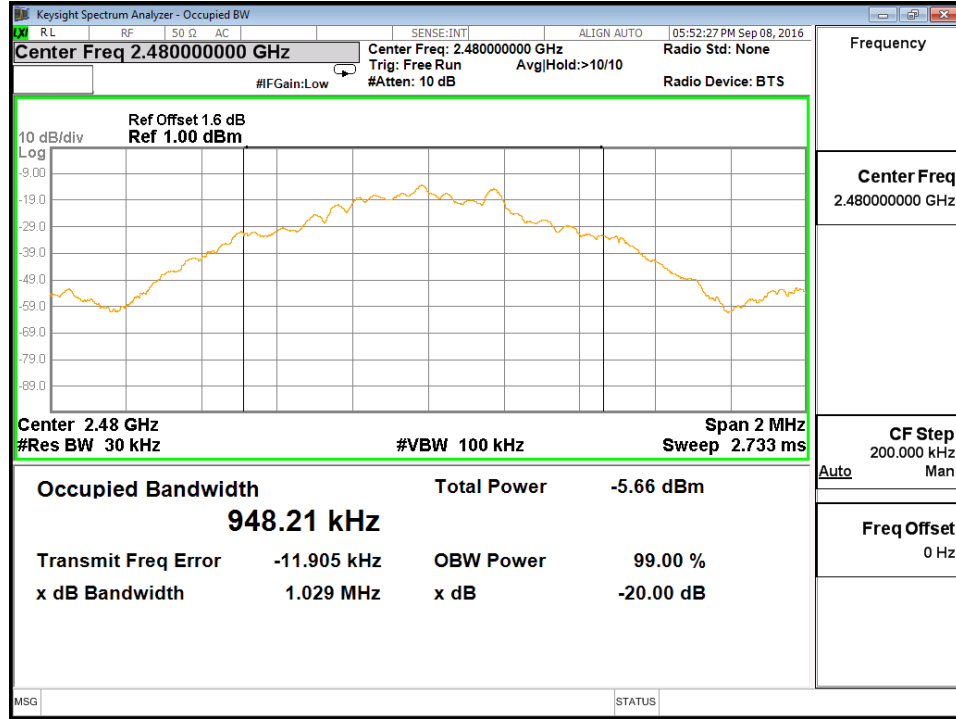
**High Channel**

**Prüfbericht - Nr.: 50055655 001**

Test Report No.

**Seite 20 von 38**

Page 20 of 38

### 5.1.4 99% Bandwidth

**RESULT:****Passed**

Date of testing : Refer to Screenshot  
Test standard : RSS-Gen (Issue 4)  
Basic standard : RSS-Gen (Issue 4)  
Kind of test site : Shielded room

**Test setup**

Test Channel : Low/ Middle/ High  
Operation Mode : A  
Ambient temperature : 22-26°C  
Relative humidity : 50-65%  
Atmospheric pressure : 100-103kPa

**Table 10: Test result of 99% Bandwidth, GFSK modulation**

Channel	Channel Frequency (MHz)	99% Bandwidth (kHz)
Mid Channel	2441	951.15

## Test Plot of 99% Bandwidth, GFSK modulation

### Middle Channel

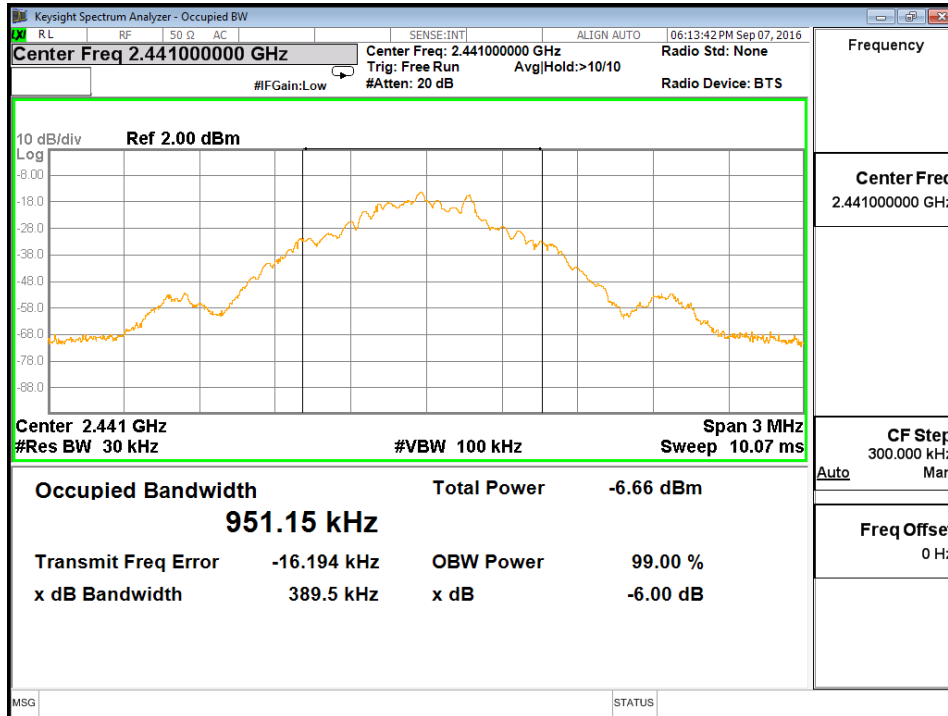

### 5.1.5 Conducted spurious emissions and Frequency Band Edge measured in 100kHz Bandwidth

**RESULT:****Passed**

Date of testing	:	Refer to Screenshot
Test standard	:	FCC part 15.247(d), RSS-247 5.5 LP0002(2016): 3.10.1, (5)
Basic standard	:	ANSI C63.10:2013 LP0002(2016) Appendix II
Limit	:	20dB (below that in the 100kHz bandwidth within the band that contains the highest level of the desired power)
Kind of test site	:	Shielded room

**Test setup**

Test Channel	:	Low/ Middle/ High
Operation Mode	:	A
Ambient temperature	:	22-26°C
Relative humidity	:	50-65%
Atmospheric pressure	:	100-103 kPa

All emissions are more than 20dB below fundamental, details refer to following test plot, and compliance is achieved as well.

Due to the small size of the product and that there are no inductive components of significant size, 9kHz to 30MHz frequency range is not tested based on technical judgment.

## Test Plot of 100kHz Conducted Emissions, GFSK modulation

### Low Channel

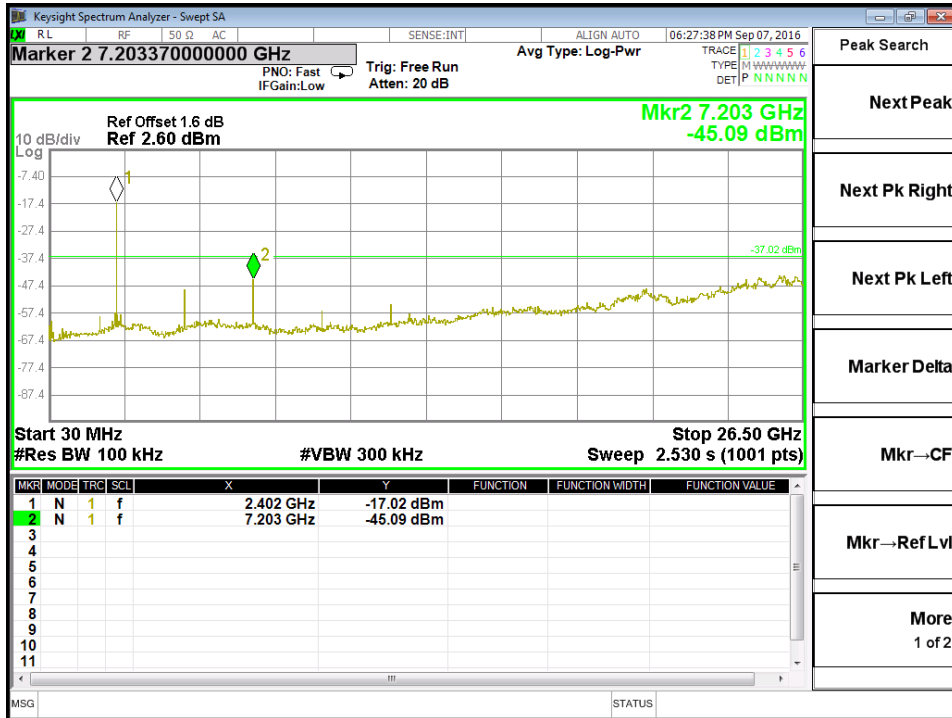

### Middle Channel

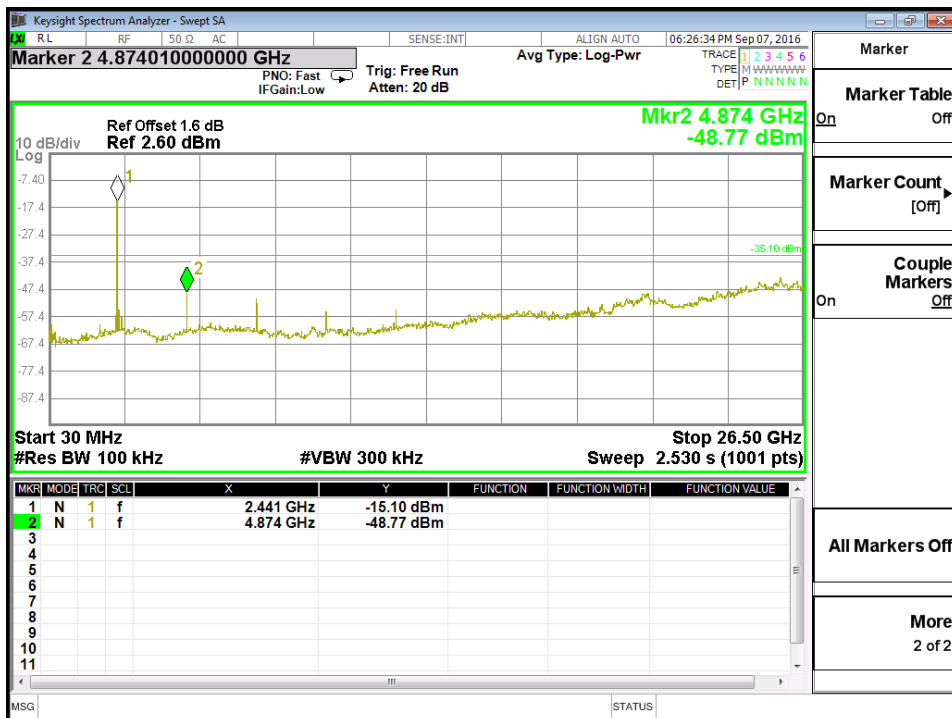

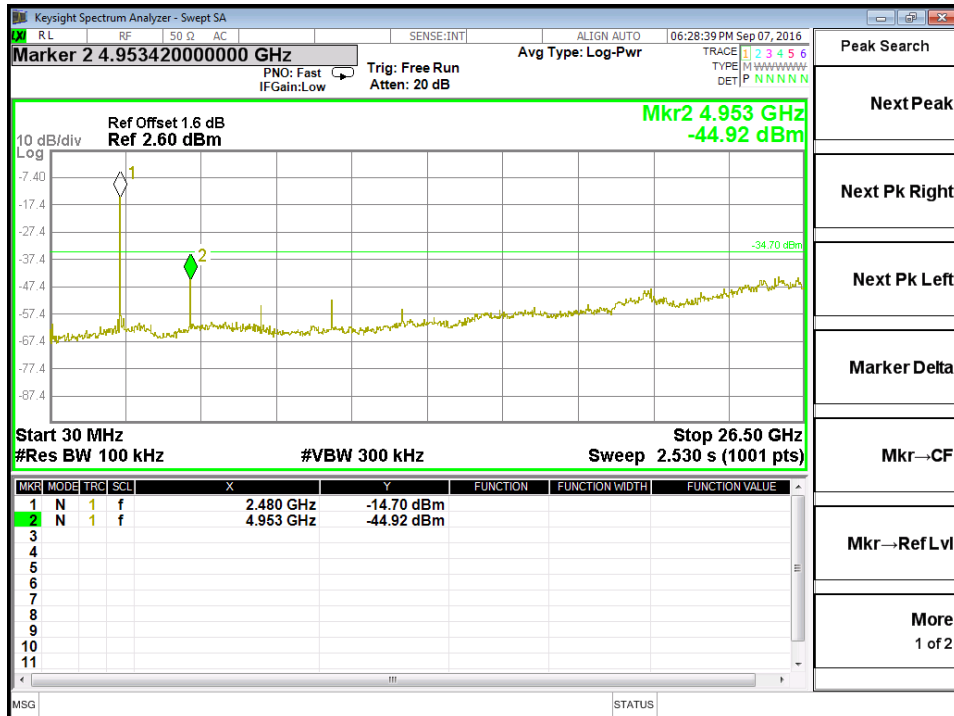
**High Channel**







## 5.1.6 Spurious Emission

**RESULT:****Passed**

Date of testing	:	Refer to Appendix D
Test standard	:	FCC part 15.247(d), FCC 15.205, FCC 15.209, RSS-210 2.2, RSS-247 5.5 and RSS-Gen 8.9 LP0002(2016): 3.10.1, (5)
Basic standard	:	ANSI C63.10
Limits	:	Radiated emissions which fall in the restricted bands, as defined in FCC 15.205(a) and RSS-Gen i4, 8.9 (Table 6), must comply with the radiated emission limits specified in FCC 15.209(a) and RSS-Gen i4, 8.9 (Table 4 and 5). Radiated emissions which fall in the restricted bands, as defined in LP0002(2016): 2.7 , must comply with the radiated emission limits specified in LP0002(2016): 2.8 Emission radiated outside the specified frequency bands must comply with the radiated emission limits specified in FCC 15.209(a) and FCC 15.249(a), RSS-Gen i4, 8.9 (Table 4 and 5) and RSS-210 A2.9(a). Emission radiated outside the specified frequency bands must comply with the radiated emission limits specified in LP0002(2016): 2.8
Kind of test site	:	3m Semi-Anechoic Chamber

**Test setup**

Test Channel	:	Low/ Middle/ High
Operation Mode	:	A,

Remark: Testing was carried out within frequency range 30MHz to the tenth harmonic. For details refer to Appendix D. The Radiated Emissions testing was performed in the X, Y and Z axis orientation. The worst-case Axis orientation is recorded in this test report. Due to the small size of the product and that there are no inductive components of significant size, 9kHz to 30MHz frequency range is not tested based on technical judgment.



## Test Plot of Frequency Separation

### GFSK

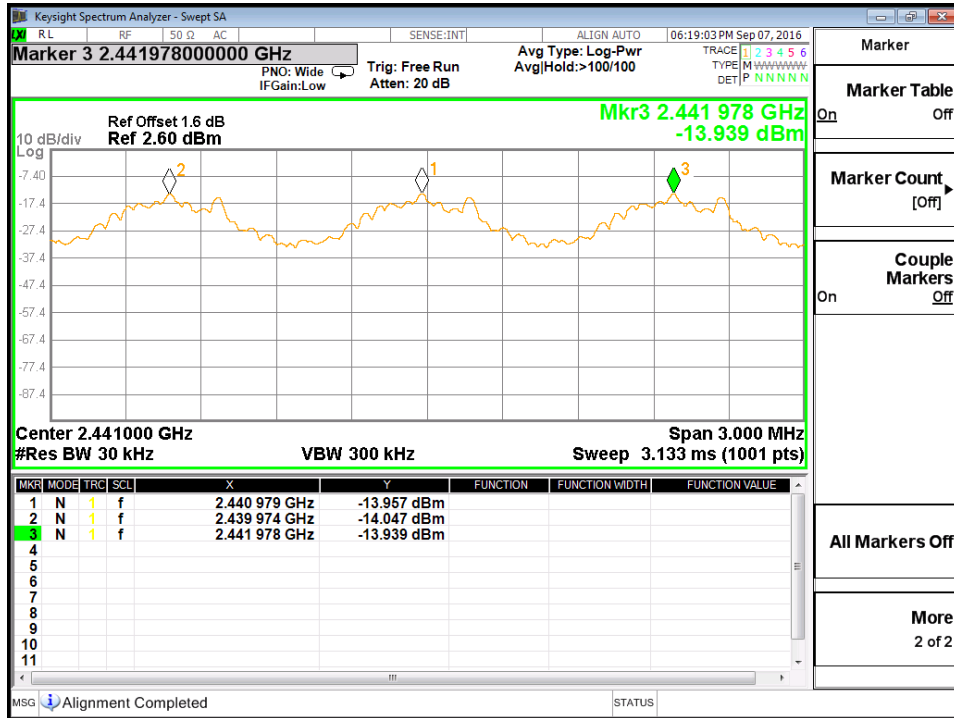

### 5.1.8 Number of hopping frequency

**RESULT:** **Passed**

Date of testing : Refer to Screenshot

Test standard : FCC part 15.247(a)(1)(iii)  
 RSS-247 5.1(5)  
 LP0002(2016): 3.10.1, (6.1.2)

Basic standard : ANSI C63.10:2013  
 LP0002(2016) Appendix II

**Test setup**

Test Channel : Hopping On

Ambient temperature : 22-26°C  
 Relative humidity : 50-65%  
 Atmospheric pressure : 100-103 kPa

**Table 12: Test result of Number of hopping frequency**

Frequency Range	Measured Quantity of Hopping Channel	Limit	Result
2400 to 2483.5 MHz	79	≥15	Pass

## Test Plot of Number of hopping frequencies

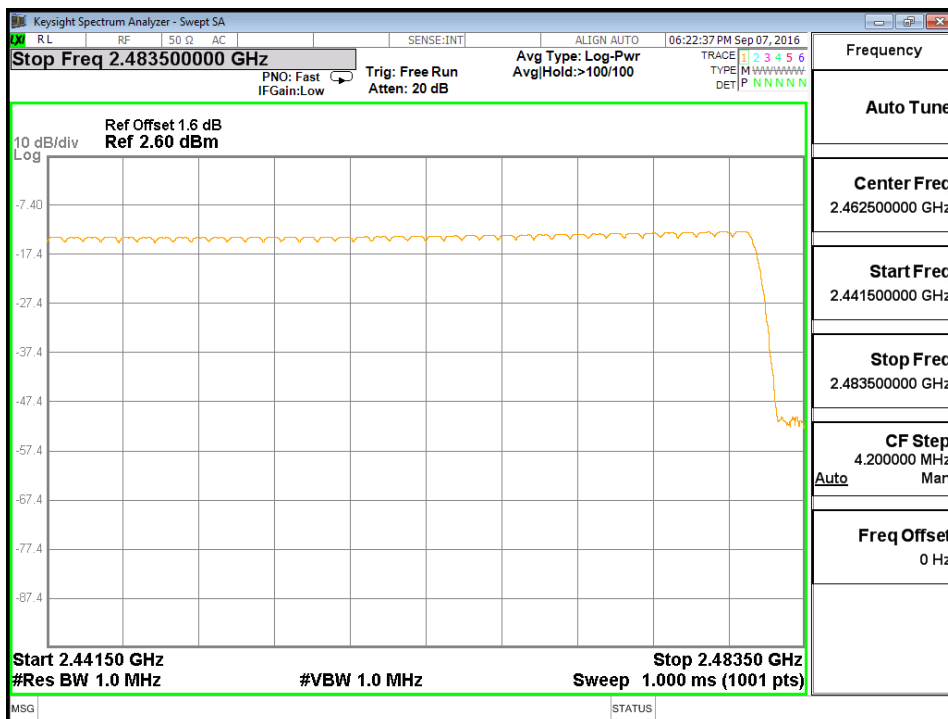
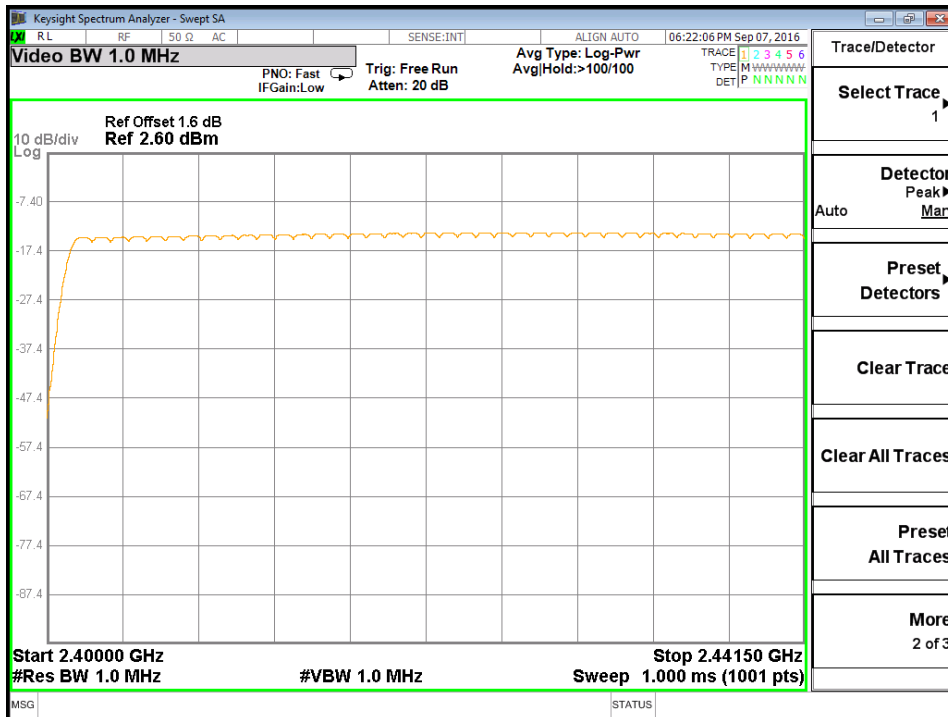

### 5.1.9 Time of Occupancy

**RESULT:**
**Passed**

Date of testing : Refer to Screenshot

Test standard : FCC part 15.247(a)(1)(iii)  
 RSS-247 5.1(5)  
 LP0002(2016): 3.10.1, (6.1.2)

Basic standard : ANSI C63.10:2013  
 LP0002(2016) Appendix II

Limits : 0.4s

Kind of test site : Shield room

**Test setup**

Test Channel : Low/ Middle/ High

Operation Mode : A

Ambient temperature : 22-26°C

Relative humidity : 50-65%

Atmospheric pressure : 100-103 kPa

**Table 13: Test result of Time of Occupancy**

Data Mode	Captured Burst (s)	Dwell time (s)	On+Off time (s)	Limit (s)	Result
DH5	0.00298	0.3710	0.00376	0.4	Pass

Note:

$$\text{Dwell time} = \text{Pulse width} \times (\text{Hopping rate} / \text{Number of channels}) \times \text{Period}$$

$$\text{Period} = 0.4 \text{ (seconds/ channel)} \times 79 \text{ (channel)} = 31.6 \text{ seconds.}$$

$$\text{Hopping rate} = 1 / (\text{On+Off time}) = 266 \text{ Hz}$$



### Test Plot of Time of Occupancy, GFSK modulation

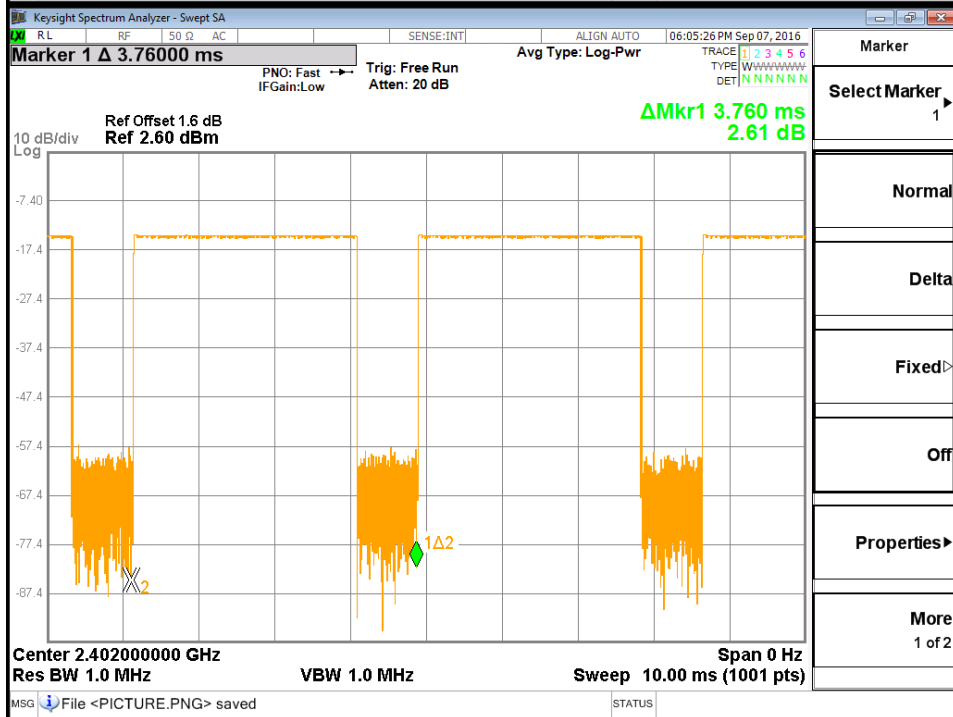
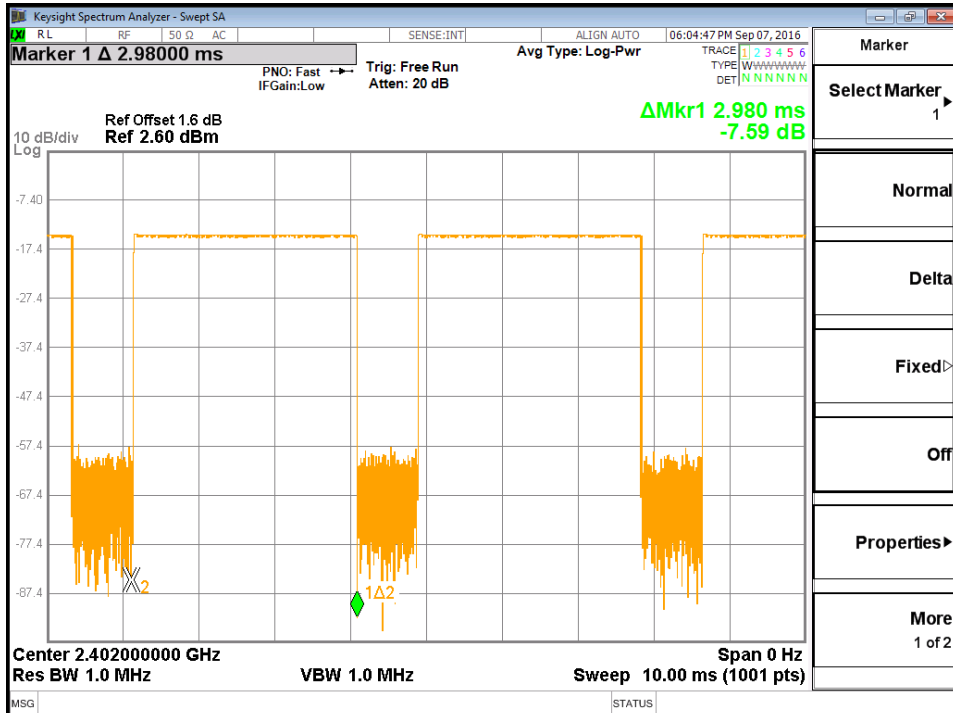

## 6. Safety Human exposure

### 6.1 Radio Frequency Exposure Compliance

#### 6.1.1 Electromagnetic Fields

**RESULT:****Passed**Test standard : FCC KDB Publication 447498 D01 v06  
RSS-102 issue 5, Table 1FCC:

Since maximum peak output power of the transmitter is 0.1 mW < 10mW, hence the EUT is excluded from SAR evaluation according to FCC KDB publication 447498 D01 v06: Mobile Portable RF Exposure

Canada:

Maximum conducted peak power: 0.1 mW

Maximum conducted Average power: 0.05 mW

-----  
Antenna Gain: 2.78 dbi -> x 1.8967

Maximum EIRP available 0.0948 mW

=====  
Maximum Power available: 0.0948 mW  
(higher of EIRP or conducted)

Since maximum output power of the transmitter is 0.0948 mW < 4mW, hence the EUT is excluded from SAR evaluation according to Table 1 in RSS-102

## 7. Photographs of the Test Set-Up

Photograph 1: Set-up for Spurious Emissions (Front View)

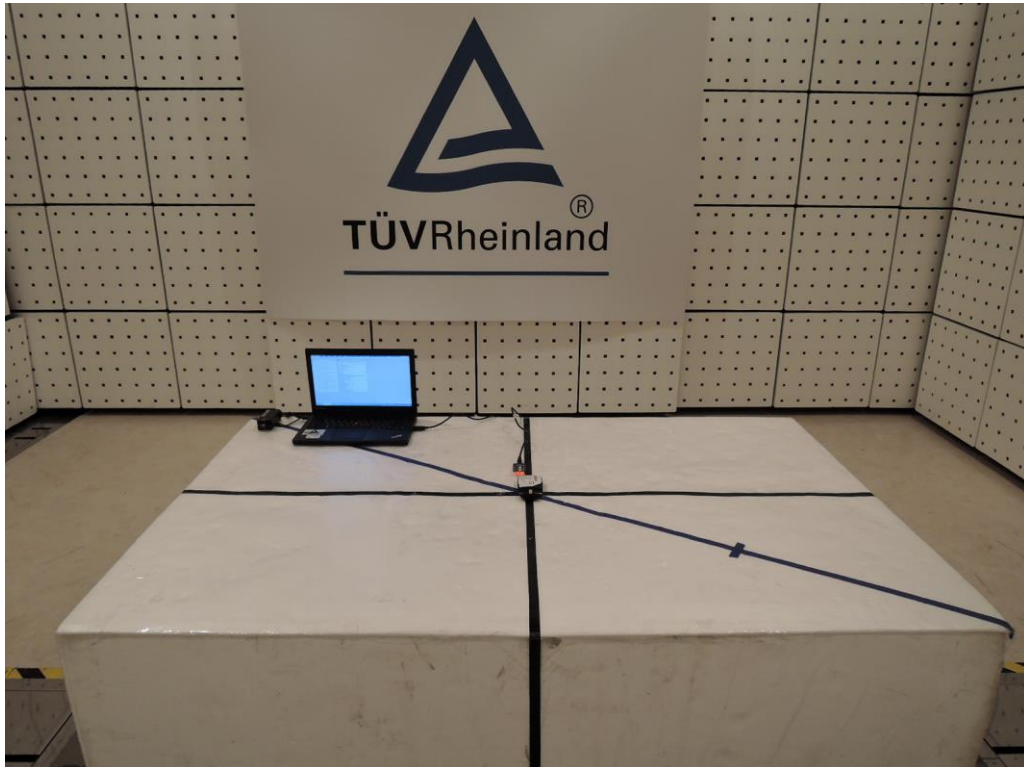

**Photograph 2: Set-up for Spurious Emissions (Back View 1)**

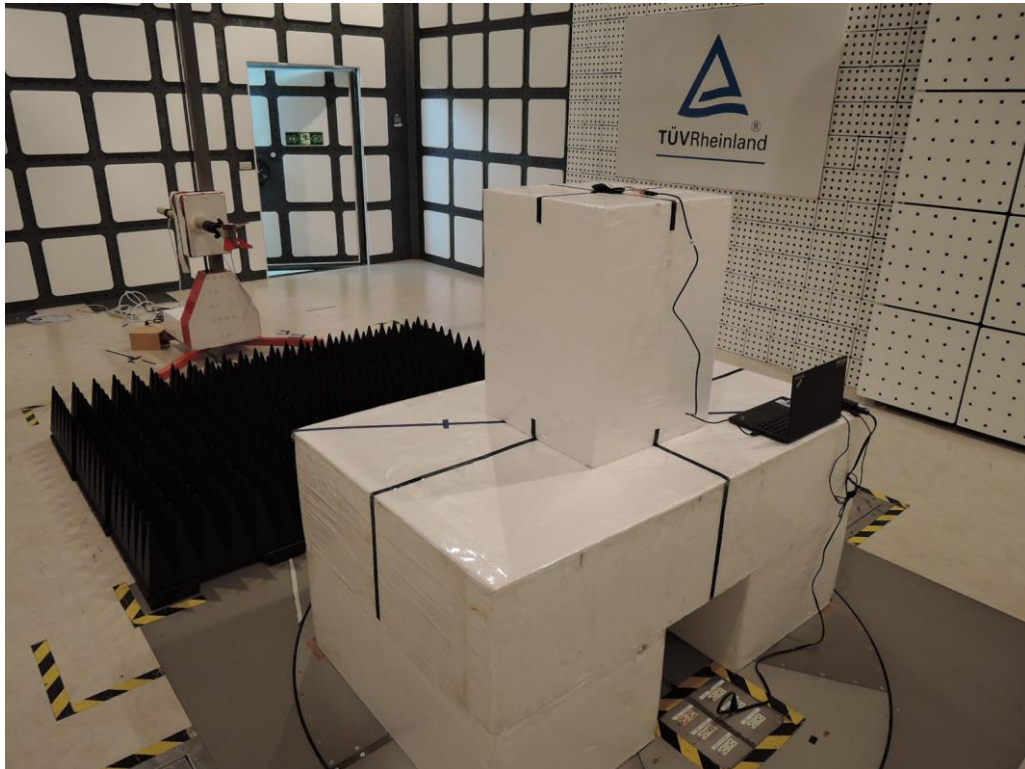

**Photograph 3: Set-up for Spurious Emissions (Back View 2)**

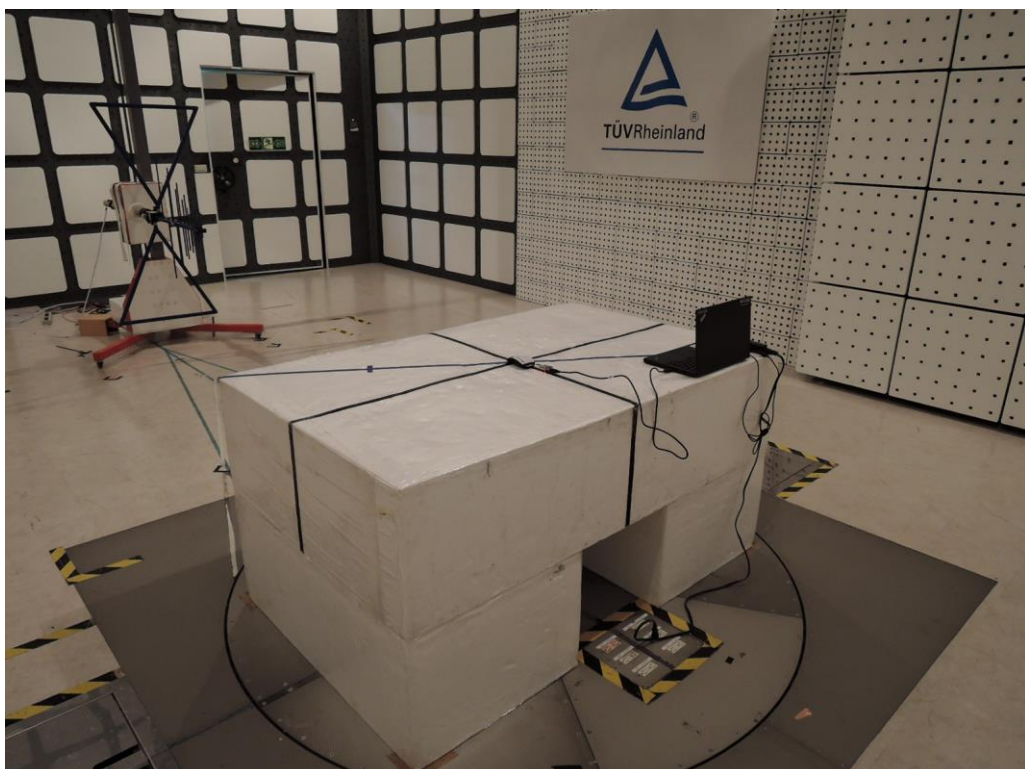

**Photograph 4: Set-up for Conducted testing**



## 8. List of Tables

Table 1: Applied Standard and Test Levels .....	5
Table 2: List of Test and Measurement Equipment .....	7
Table 3: Emission Measurement Uncertainty.....	8
Table 4: Basic Information of EUT .....	9
Table 5: Technical Specification of EUT .....	9
Table 6: Frequency hopping information.....	10
Table 7: Test result of Peak Output Power, GFSK modulation.....	16
Table 8: Test result of AVG Output Power, GFSK modulation .....	16
Table 9: Test result of 20dB Bandwidth, GFSK modulation.....	17
Table 10: Test result of 99% Bandwidth, GFSK modulation .....	20
Table 11: Test result of Frequency Separation .....	28
Table 12: Test result of Number of hopping frequency .....	30
Table 13: Test result of Time of Occupancy.....	32

## 9. List of Photographs

Photograph 1: Set-up for Spurious Emissions (Front View).....	35
Photograph 2: Set-up for Spurious Emissions (Back View 1) .....	36
Photograph 3: Set-up for Spurious Emissions (Back View 2) .....	36
Photograph 4: Set-up for Conducted testing.....	37