

# FCC TEST REPORT

for

Acrox Technologies Co., Ltd.

Wireless Mouse

Model Number: GOK, LS9500R

FCC ID: PRDMU27

Prepared for : Acrox Technologies Co., Ltd.  
Address : 4F., No.89, Minshan St., Neihu Dist., Taipei City 114,  
Taiwan, R.O.C

Prepared by : Keyway Testing Technology Co., Ltd.  
Address : Baishun Industrial Zone, Zhangmutou Town,  
Dongguan, Guangdong, China

Tel: 86-769-8718 2258  
Fax: 86-769-8718 1058

Report No. : 14KW091895F  
Date of Test : Sep. 17~ 18, 2014  
Date of Report : Sep. 18, 2014

## TABLE OF CONTENTS

	Page
Test Report Declaration	
1. TEST SUMMARY .....	4
2. GENERAL PRODUCT INFORMATION.....	4
2.1. Product Function.....	4
2.2. Description of Device (EUT) .....	4
2.3. Difference between Model Numbers.....	4
2.4. Independent Operation Modes .....	4
2.5. Test Supporting System.....	4
3. TEST SITES .....	5
3.1. Test Facilities .....	5
3.2. List of Test and Measurement Instruments.....	6
4. TEST SET-UP AND OPERATION MODES .....	7
4.1. Principle of Configuration Selection .....	7
4.2. Block Diagram of Test Set-up .....	7
4.3. Test Operation Mode and Test Software .....	7
4.4. Special Accessories and Auxiliary Equipment .....	7
4.5. Countermeasures to Achieve EMC Compliance.....	7
5. EMISSION TEST RESULTS .....	8
5.1. Radiated Emission Test.....	8
6. 20DB OCCUPY BANDWIDTH.....	14
6.1. Limits.....	14
6.2. Test setup .....	14
7. BAND EDGE COMPLIANCE TEST.....	16
7.1. Limits.....	16
7.2. Test setup .....	16
8. ANTENNA REQUIREMENTS.....	17
8.1. Limits.....	17
8.2. Result.....	17
9. PHOTOGRAPHS OF TEST SET-UP .....	18
10. PHOTOGRAPHS OF THE EUT.....	19

## Keyway Testing Technology Co., Ltd.

<b>Applicant:</b>	Acrox Technologies Co., Ltd.		
<b>Address:</b>	4F., No.89, Minshan St., Neihu Dist., Taipei City 114, Taiwan, R.O.C		
<b>Manufacturer:</b>	Acrox Technologies Co., Ltd.		
<b>Address:</b>	4F., No.89, Minshan St., Neihu Dist., Taipei City 114, Taiwan, R.O.C		
<b>E.U.T:</b>	Wireless Mouse		
<b>Model Number:</b>	GOK, LS9500R		
<b>Trade Name:</b>		<b>Serial No.:</b>	-----
<b>Date of Receipt:</b>	Sep. 16, 2014	<b>Date of Test:</b>	Sep. 17~ 18, 2014
<b>Test Specification:</b>	FCC Part 15, Subpart C Section 15.249: Oct. 1, 2013 ANSI C63.4:2009		
<b>Test Result:</b>	The equipment under test was found to be compliance with the requirements of the standards applied.		
		<b>Issue Date: Sep. 18, 2014</b>	
Tested by:	Reviewed by:	Approved by:	
			
Jack Bu / Engineer	Andy Gao / Supervisor	Jade Yang / Supervisor	
<b>Other Aspects:</b>	None.		
<i>Abbreviations: OK/P=passed    fail/F=failed    n.a/N=not applicable    E.U.T=equipment under tested</i>			
<i>This test report is based on a single evaluation of one sample of above mentioned products. It is not permitted to be duplicated in extracts without written approval of Keyway Testing Technology Co., Ltd.</i>			

## 1. TEST SUMMARY

Test Items	Test Requirement	Result
Conducted Emissions	15.207	N/A
Radiated Emissions	15.209 15.249(a)(d)	PASS
20dB Bandwidth	15.249	PASS
Emissions from out of band	15.249(d)	PASS
Antenna Requirement	15.203	PASS

## 2. GENERAL PRODUCT INFORMATION

### 2.1. Product Function

Refer to Technical Construction Form and User Manual.

### 2.2. Description of Device (EUT)

Product Name:	Wireless Mouse
Model No.:	GOK, LS9500R
Operation Frequency:	2408~2474MHz
Modulation technology:	GFSK
Antenna Type:	Integral Antenna
Antenna gain:	0dBi (declare by Applicant)
Power supply:	DC 3V(1.5V AA battery*2)

### 2.3. Difference between Model Numbers

None.

### 2.4. Independent Operation Modes

The basic operation modes are:

2.4.1. EUT work continues TX mode and frequency as below:

Modulation	Channel	Frequency
GFSK	Low	2408MHz
	Middle	2440MHz
	High	2474MHz

### 2.5. Test Supporting System

None.

### 3. TEST SITES

#### 3.1. Test Facilities

Lab Qualifications : 944 Shielded Room built by ETS-Lindgren, USA  
Date of completion: March 28, 2011

966 Chamber built by ETS-Lindgren, USA  
Date of completion: March 28, 2011

Certificated by TUV Rheinland, Germany.  
Registration No.: UA 50207153  
Date of registration: July 13, 2011

Certificated by UL, USA  
Registration No.: 100567-237  
Date of registration: September 1, 2011

Certificated by Intertek  
Registration No.: 2011-RTL-L1-31  
Date of registration: October 11, 2011

Certificated by Industry Canada  
Registration No.: 9868A  
Date of registration: December 8, 2011

Certificated by FCC, USA  
Registration No.: 370994  
Date of registration: February 21, 2012

Certificated by CNAS China  
Registration No.: CNAS L5783  
Date of registration: August 8, 2012

Name of Firm : Keyway Testing Technology Co., Ltd.

Site Location : Baishun Industrial Zone, Zhangmutou Town,  
Dongguan, Guangdong, China

## 3.2. List of Test and Measurement Instruments

### 3.2.1. For radiated emission test

Equipment	Manufacturer	Model No.	Serial No.	Last Cal.	Next Cal.
EMI Test Receiver	Rohde&Schwarz	ESCI	101156	Apr. 27,14	Apr. 27,15
System Simulator	Agilent	E5515C	GB43130245	Apr. 30,14	Apr. 30,15
Power Splitter	Weinschel	1506A	NW425	Apr. 30,14	Apr. 30,15
Bilog Antenna	ETS-LINDGREEN	3142D	135452	Apr. 27,14	Apr. 27,15
Spectrum Analyzer	Agilent	E4411B	MY4511304	Apr. 27,14	Apr. 27,15
3m Semi-anechoic Chamber	ETS-LINDGREEN	966	KW01	Apr. 27,14	Apr. 27,15
Signal Amplifier	SONOMA	310	187016	Apr. 27,14	Apr. 27,15
Signal Amplifier	Agilent	8449B	3008A00251	Apr. 27,14	Apr. 27,15
RF Cable	IMRO	IMRO-400	966 Cable 1#	N/A	N/A
MULTI-DEVICE Controller	ETS-LINDGREEN	2090	126913	N/A	N/A
Horn Antenna	DAZE	ZN30701	11003	Apr. 27,14	Apr. 27,15
Horn Antenna	SCHWARZBECK	BBHA9170	9170-068	Apr. 27,14	Apr. 27,15
Spectrum Analyzer	Agilent	8593E	3911A04271	Apr. 27,14	Apr. 27,15
Spectrum Analyzer	Agilent	E4408B	MY44211125	Apr. 30,14	Apr. 30,15
Signal Amplifier	DAZE	ZN3380C	11001	Apr. 27,14	Apr. 27,15
High Pass filter	Micro	HPM50111	324216	Apr. 30,14	Apr. 30,15
Filter	COM-MW	ZBSF-C836.5-25-X	KW032	Apr. 30,14	Apr. 30,15
Filter	COM-MW	ZBSF-C1747.5-75-X2	KW035	Apr. 30,14	Apr. 30,15
Filter	COM-MW	ZBSF-C1880-60-X2	KW037	Apr. 30,14	Apr. 30,15
DC Power Supply	LongWei	PS-305D	010964729	Apr. 27,14	Apr. 27,15
Constant temperature and humidity box	GF	GTH-800-40-1P	MAA9906-005	Apr. 27,14	Apr. 27,15
Universal radio communication tester	Rohde&Schwarz	CMU200	3215420	Apr. 27,14	Apr. 27,15
Splitter	Agilent	11636B	0025164	Apr. 27,14	Apr. 27,15

## 4. TEST SET-UP AND OPERATION MODES

### 4.1. Principle of Configuration Selection

**Emission:** The equipment under test (EUT) was configured to measure its highest possible radiation level. The test modes were adapted accordingly in reference to the Operating Instructions.

### 4.2. Block Diagram of Test Set-up

System Diagram of Connections between EUT and Simulators



(EUT: *Wireless Mouse*)

### 4.3. Test Operation Mode and Test Software

None.

### 4.4. Special Accessories and Auxiliary Equipment

None.

### 4.5. Countermeasures to Achieve EMC Compliance

None.

### 4.6. Test Environment:

Ambient conditions in the test laboratory:

Items	Actual
Temperature (°C)	21~23
Humidity (%RH)	50~65

## 5. EMISSION TEST RESULTS

### 5.1. Radiated Emission Test

#### 5.1.1. Limit 15.209 limits

FREQUENCY MHz	DISTANCE Meters	FIELD STRENGTHS LIMIT	
		µV/m	dB(µV)/m
30 ~ 88	3	100	40.0
88 ~ 216	3	150	43.5
216 ~ 960	3	200	46.0
960 ~ 1000	3	500	54.0
Above 1000	3	74.0 dB(µV)/m (Peak) 54.0 dB(µV)/m (Average)	

#### 5.1.2. Restricted bands of operation

MHz	MHz	MHz	GHz
0.090 - 0.110	16.42 - 16.423	399.9 - 410	4.5 - 5.15
<sup>1</sup> 0.495 - 0.505	16.69475 - 16.69525	608 - 614	5.35 - 5.46
2.1735 - 2.1905	16.80425 - 16.80475	960 - 1240	7.25 - 7.75
4.125 - 4.128	25.5 - 25.67	1300 - 1427	8.025 - 8.5
4.17725 - 4.17775	37.5 - 38.25	1435 - 1626.5	9.0 - 9.2
4.20725 - 4.20775	73 - 74.6	1645.5 - 1646.5	9.3 - 9.5
6.215 - 6.218	74.8 - 75.2	1660 - 1710	10.6 - 12.7
6.26775 - 6.26825	108 - 121.94	1718.8 - 1722.2	13.25 - 13.4
6.31175 - 6.31225	123 - 138	2200 - 2300	14.47 - 14.5
8.291 - 8.294	149.9 - 150.05	2310 - 2390	15.35 - 16.2
8.362 - 8.366	156.52475 - 156.52525	2483.5 - 2500	17.7 - 21.4
8.37625 - 8.38675	156.7 - 156.9	2690 - 2900	22.01 - 23.12
8.41425 - 8.41475	162.0125 - 167.17	3260 - 3267	23.6 - 24.0
12.29 - 12.293	167.72 - 173.2	3332 - 3339	31.2 - 31.8
12.51975 - 12.52025	240 - 285	3345.8 - 3358	36.43 - 36.5
12.57675 - 12.57725	322 - 335.4	3600 - 4400	( <sup>2</sup> )

All the emissions appearing within 15.205 restricted frequency bands shall not exceed the limits shown in 15.209, all the other emissions shall be at least 20dB below the fundamental emissions, or comply with 15.209 limits.



### 5.1.3. Test setup

The EUT was placed on a turn table which was 0.8 m above the ground. The turn table can rotate 360 degrees to determine the position of the maximum emission level. The EUT was set 3 m away from the receiving antenna which was mounted on an antenna tower. The measuring antenna moved up and down to find out the maximum emission level. It moved from 1 m to 4 m for both horizontal and vertical polarizations.

The EUT was tested in the Chamber Site. It was pre-scanned with a Peak detector from the spectrum, and all the final readings from the test receiver were measured with the Quasi-Peak detector below 1GHz.

The bandwidth of the EMI test receiver is set at 120kHz for frequency range from 30MHz to 1000 MHz.

The bandwidth of the Spectrum's VBW is set at 3MHz and RBW is set at 1MHz for peak emissions measurement above 1GHz and 1MHz RBW, 10Hz VBW for average emissions measure above 1GHz.

The frequency range from 30MHz to 10<sup>th</sup> harmonic (25GHz) is checked. And no any emissions were found from 18GHz to 25 GHz, So the radiated emissions from 18GHz to 25GHz were not record.

Notes: 1. Emission Level = Antenna Factor + Cable Loss + Meter Reading-Preamp Factor.

2. Measurement Uncertainty:  $\pm 3.2$  dB at a level of confidence of 95%.

3. For emissions above 1GHz, if peak level comply with average limit, then the average level is deemed to comply with average limit.

4. For emissions below 1GHz, pretest for all modes, The test data of the worst case condition(s) was reported on the following pages.

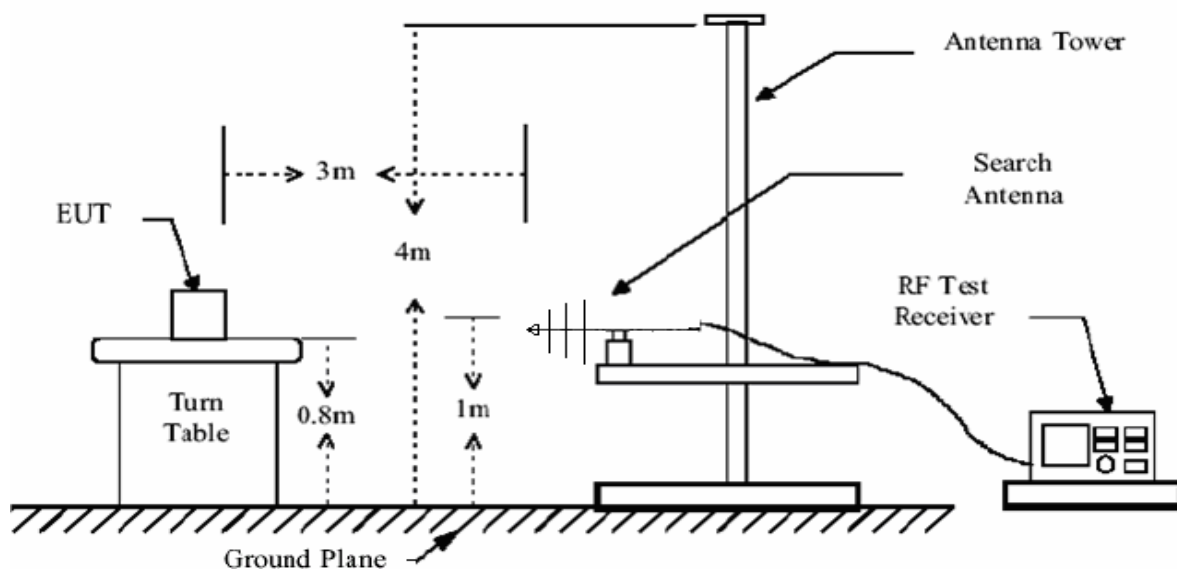

Below 1GHz  
 TX Mode Horizontal polarizations

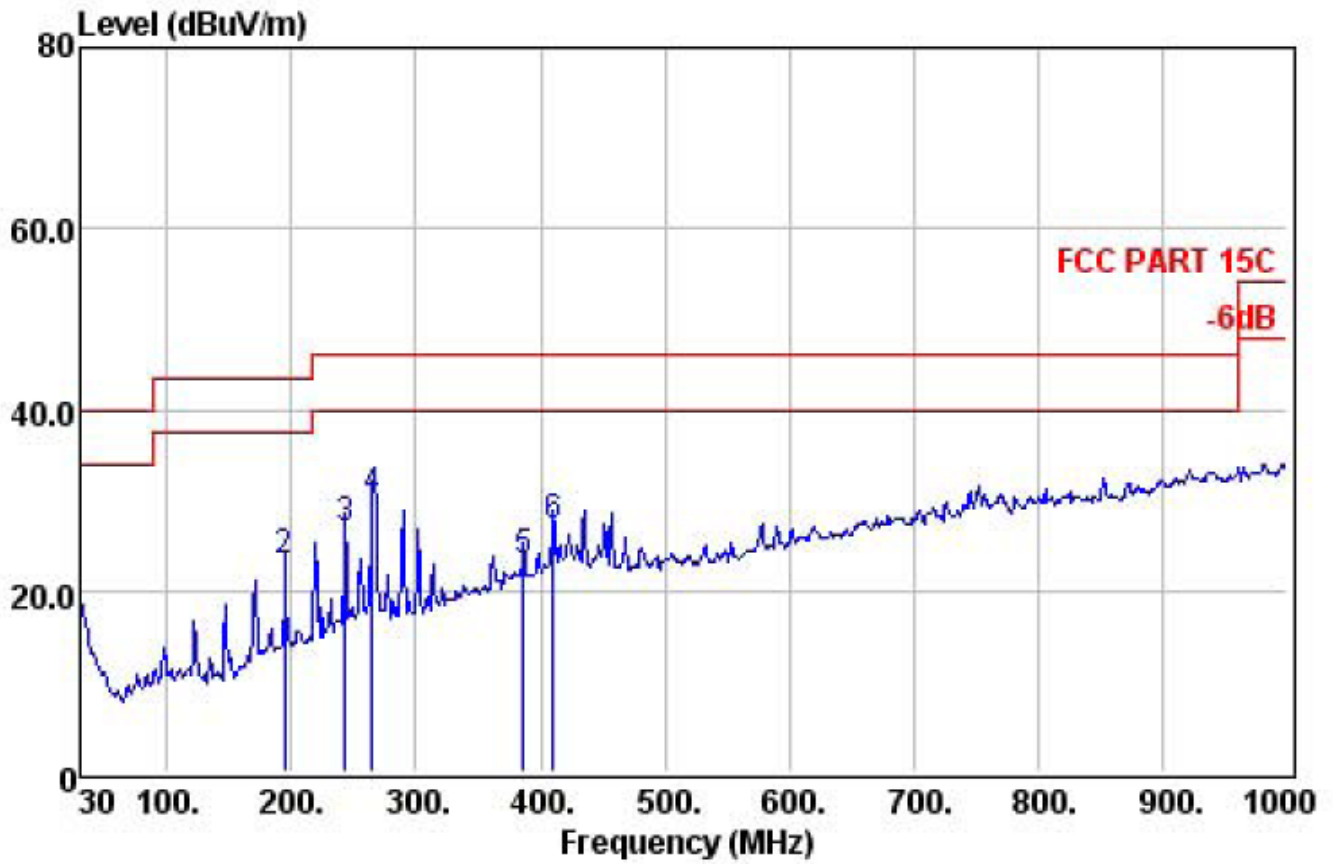

	Preamp	Read	CableAntenna		Limit	Over			
	Freq	Factor	Level	Loss	Factor	Level	Line	Limit	
	MHz	dB	dBuV	dB	dB/m	dBuV/m	dBuV/m	dB	
1	30.00	31.41	32.32	0.56	18.80	20.27	40.00	-19.73	QP
2	194.90	31.11	42.42	1.46	10.54	23.31	43.50	-20.19	QP
3	243.40	30.95	43.27	1.61	12.72	26.65	46.00	-19.35	QP
4	264.74	30.96	46.33	1.78	12.96	30.11	46.00	-15.89	QP
5	386.96	30.62	35.43	2.27	16.24	23.32	46.00	-22.68	QP
6	410.24	30.64	38.46	2.48	16.63	26.93	46.00	-19.07	QP

TX Mode Vertical polarizations

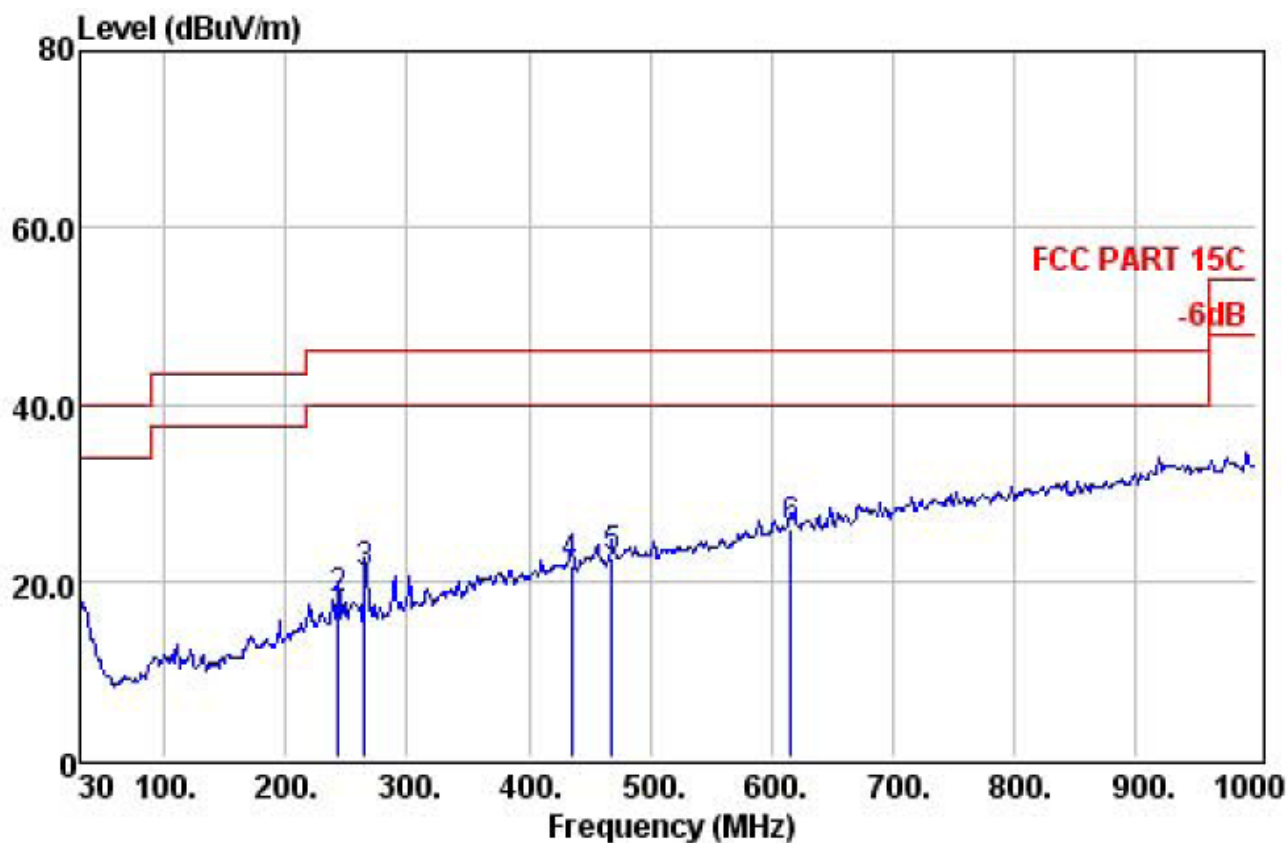

	Preamp	Read	Cable&Antenna		Limit	Over	
	Freq	Factor	Level	Loss	Factor	Level	Line
	MHz	dB	dBuV	dB	dB/m	dBuV/m	dBuV/m
1	30.00	31.41	30.35	0.56	18.80	18.30	40.00
2	243.40	30.95	34.43	1.61	12.72	17.81	46.00
3	264.74	30.96	36.90	1.78	12.96	20.68	46.00
4	435.46	30.62	32.57	2.55	17.31	21.81	46.00
5	468.44	30.60	32.35	2.69	18.12	22.56	46.00
6	616.85	30.64	31.96	3.38	21.07	25.77	46.00

## Above 1GHz

## 2408MHz Horizontal polarizations

	Freq	Preamp Factor	Read Level	CableAntenna Loss	Antenna Factor	Level	Limit Line	Over Limit	Remark
	MHz	dB	dBuV	dB	dB/m	dBuV/m	dBuV/m	dB	
1	2408.00	26.32	79.67	7.39	28.73	89.47	94.00	-4.53	Average
2	2408.00	26.32	92.25	7.39	28.73	102.05	114.00	-11.95	Peak
3	4816.00	27.49	31.11	12.01	32.94	48.57	74.00	-25.43	Peak
4	7477.00	27.99	15.25	16.63	37.39	41.28	74.00	-32.72	Peak
5	10146.00	28.82	16.25	16.99	38.64	43.06	74.00	-30.94	Peak
6	12050.00	29.01	15.08	17.41	39.41	42.89	74.00	-31.11	Peak

## 2408MHz Vertical polarizations

	Freq	Preamp Factor	Read Level	CableAntenna Loss	Antenna Factor	Level	Limit Line	Over Limit	Remark
	MHz	dB	dBuV	dB	dB/m	dBuV/m	dBuV/m	dB	
1	2408.00	26.32	78.96	7.39	28.73	88.76	94.00	-5.24	Average
2	2408.00	26.32	91.79	7.39	28.73	101.59	114.00	-12.41	Peak
3	4816.00	27.49	30.91	12.01	32.94	48.37	74.00	-25.63	Peak
4	6984.00	27.90	14.85	16.60	37.16	40.71	74.00	-33.29	Peak
5	9517.00	28.61	16.11	16.92	38.01	42.43	74.00	-31.57	Peak
6	13070.00	29.21	14.29	18.30	41.02	44.40	74.00	-29.60	Peak

## 2440MHz Horizontal polarizations

	Freq	Preamp Factor	Read Level	CableAntenna Loss	Antenna Factor	Level	Limit Line	Over Limit	Remark
	MHz	dB	dBuV	dB	dB/m	dBuV/m	dBuV/m	dB	
1	2440.00	26.33	79.03	7.48	28.76	88.94	94.00	-5.06	Average
2	2440.00	26.33	91.77	7.48	28.76	101.68	114.00	-12.32	Peak
3	4880.00	27.53	30.95	12.14	33.11	48.67	74.00	-25.33	Peak
4	7426.00	27.98	16.28	16.62	37.37	42.29	74.00	-31.71	Peak
5	9109.00	28.44	18.73	16.89	37.52	44.70	74.00	-29.30	Peak
6	12883.00	29.18	14.41	18.11	40.42	43.76	74.00	-30.24	Peak

**2440MHz Vertical polarizations**

	Freq	Preamp Factor	Read Level	CableAntenna Loss	Factor	Level	Limit Line	Over Limit	Remark
	MHz	dB	dBuV	dB	dB/m	dBuV/m	dBuV/m	dB	
1	2440.00	26.33	79.06	7.48	28.76	88.97	94.00	-5.03	Average
2	2440.00	26.33	91.27	7.48	28.76	101.18	114.00	-12.82	Peak
3	4880.00	27.53	30.95	12.14	33.11	48.67	74.00	-25.33	Peak
4	7511.00	28.00	16.09	16.63	37.37	42.09	74.00	-31.91	Peak
5	10537.00	28.85	18.83	17.07	39.22	46.27	74.00	-27.73	Peak
6	13410.00	29.28	13.24	18.69	42.60	45.25	74.00	-28.75	Peak

**2474MHz Horizontal polarizations**

	Freq	Preamp Factor	Read Level	CableAntenna Loss	Factor	Level	Limit Line	Over Limit	Remark
	MHz	dB	dBuV	dB	dB/m	dBuV/m	dBuV/m	dB	
1	2474.00	26.34	78.70	7.52	28.79	88.67	94.00	-5.33	Average
2	2474.00	26.34	91.50	7.52	28.79	101.47	114.00	-12.53	Peak
3	4948.00	27.57	30.60	12.32	33.28	48.63	74.00	-25.37	Peak
4	7392.00	27.98	17.01	16.62	37.36	43.01	74.00	-30.99	Peak
5	10979.00	28.90	12.99	17.16	39.49	40.74	74.00	-33.26	Peak
6	14243.00	29.44	11.39	19.52	42.10	43.57	74.00	-30.43	Peak

**2474MHz Vertical polarizations**

	Freq	Preamp Factor	Read Level	CableAntenna Loss	Factor	Level	Limit Line	Over Limit	Remark
	MHz	dB	dBuV	dB	dB/m	dBuV/m	dBuV/m	dB	
1	2474.00	26.34	79.26	7.52	28.79	89.23	94.00	-4.77	Average
2	2474.00	26.34	92.90	7.52	28.79	102.87	114.00	-11.13	Peak
3	4948.00	27.57	31.14	12.32	33.28	49.17	74.00	-24.83	Peak
4	7086.00	27.92	16.76	16.60	37.23	42.67	74.00	-31.33	Peak
5	10520.00	28.85	14.46	17.07	39.21	41.89	74.00	-32.11	Peak
6	15076.00	29.56	13.65	20.04	38.49	42.62	74.00	-31.38	Peak

## 6. 20DB OCCUPY BANDWIDTH

### 6.1. Limits

Intentional radiators operating under the alternative provisions to the general emission limits, as contained in §§ 15.217 through 15.257 and in Subpart E of this part, must be designed to ensure that the 20 dB bandwidth of the emission, or whatever bandwidth may otherwise be specified in the specific rule section under which the equipment operates, is contained within the frequency band designated in the rule section under which the equipment is operated.

### 6.2. Test setup

1. Set the RBW =100kHz.
2. Set the VBW = 300kHz
3. Span=5MHz
4. Detector = peak.
5. Sweep time = 2.5ms.
6. Allow trace to fully stabilize, and view the plot.
7. Measure and record the result in the test report.

Test data:

	Channel Frequency (MHz)	20dB Bandwidth (MHz)	Result
GFSK	2408	2.260	Pass
	2440	2.260	Pass
	2474	2.260	Pass

Test plot as follows:

GFSK

2408MHz

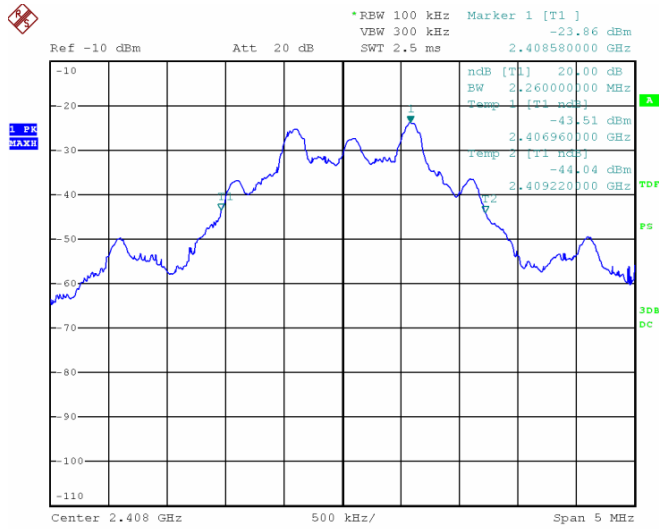

2440 MHz

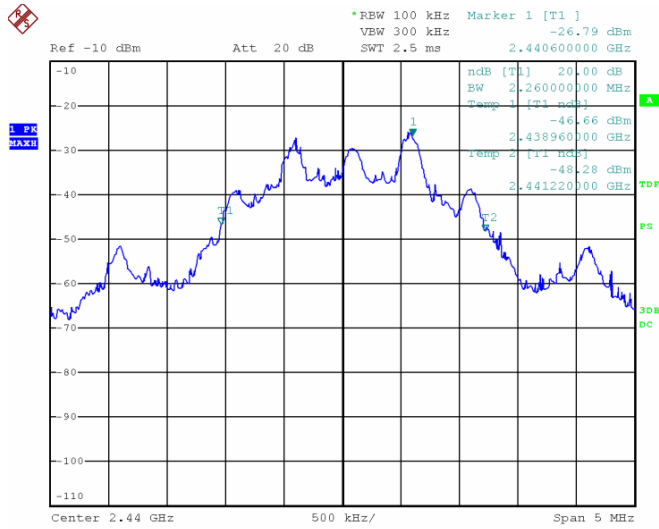

2474 MHz

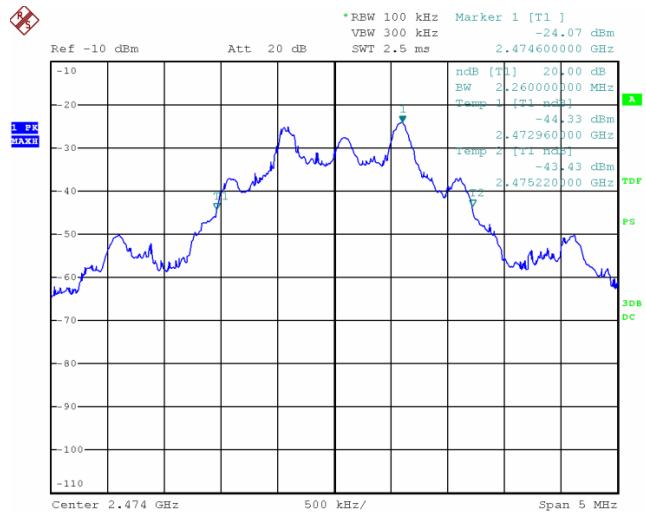

## 7. BAND EDGE COMPLIANCE TEST

### 7.1. Limits

All the lower and upper band-edges emissions appearing within 2310MHz to 2390MHz and 2483.5MHz to 2500MHz restricted frequency bands shall not exceed the limits shown in 15.209, all the other emissions outside operation frequency band 2400MHz to 2483.5MHz shall be at least 20dB below the fundamental emissions, or comply with 15.209 limits.

### 7.2. Test setup

The EUT was placed on a turn table which was 0.8 m above the ground. The turn table can rotate 360 degrees to determine the position of the maximum emission level. The EUT was set 3 m away from the receiving antenna which was mounted on an antenna tower. The measuring antenna moved up and down to find out the maximum emission level. It moved from 1 m to 4 m for both horizontal and vertical polarizations.

The bandwidth of the Spectrum's VBW is set at 3MHz and RBW is set at 1MHz for peak emissions measurement above 1GHz and 1MHz RBW, 10Hz VBW for average emissions measure.

Test plot as follows:

	Frequency (MHz)	Antenna polarization (H/V)	Emission (dBuV/m)	Band edge Limit (dBuV/m)		Result
			PK	PK	AV	
Hopping	<2400	H	50.32	74.00	54.00	Pass
	<2400	V	49.57	74.00	54.00	Pass
	>2483.5	H	49.45	74.00	54.00	Pass
	>2483.5	V	50.02	74.00	54.00	Pass
Unhopping	<2400	H	49.63	74.00	54.00	Pass
	<2400	V	49.38	74.00	54.00	Pass
	>2483.5	H	49.67	74.00	54.00	Pass
	>2483.5	V	50.11	74.00	54.00	Pass

If the PK measured levels comply with average limit, then the average level were deemed to comply with average limit.



## 8. ANTENNA REQUIREMENTS

### 8.1. Limits

For intentional device, according to FCC 47 CFR Section 15.203, an intentional radiator shall be designed to ensure that no antenna other than that furnished by the responsible party shall be used with the device. And according to FCC 47 CFR Section 15.247 (b), if transmitting antennas of directional gain greater than 6dBi are used, the power shall be reduced by the amount in dB that the directional gain of the antenna exceeds 6dBi.

### 8.2. Result

The antennas used for this product are integral antenna and that no antenna other than that furnished by the responsible party shall be used with the device, the maximum peak gain of the transmit antenna is only 0dBi.

## 9. PHOTOGRAPHS OF TEST SET-UP

Radiated Emission

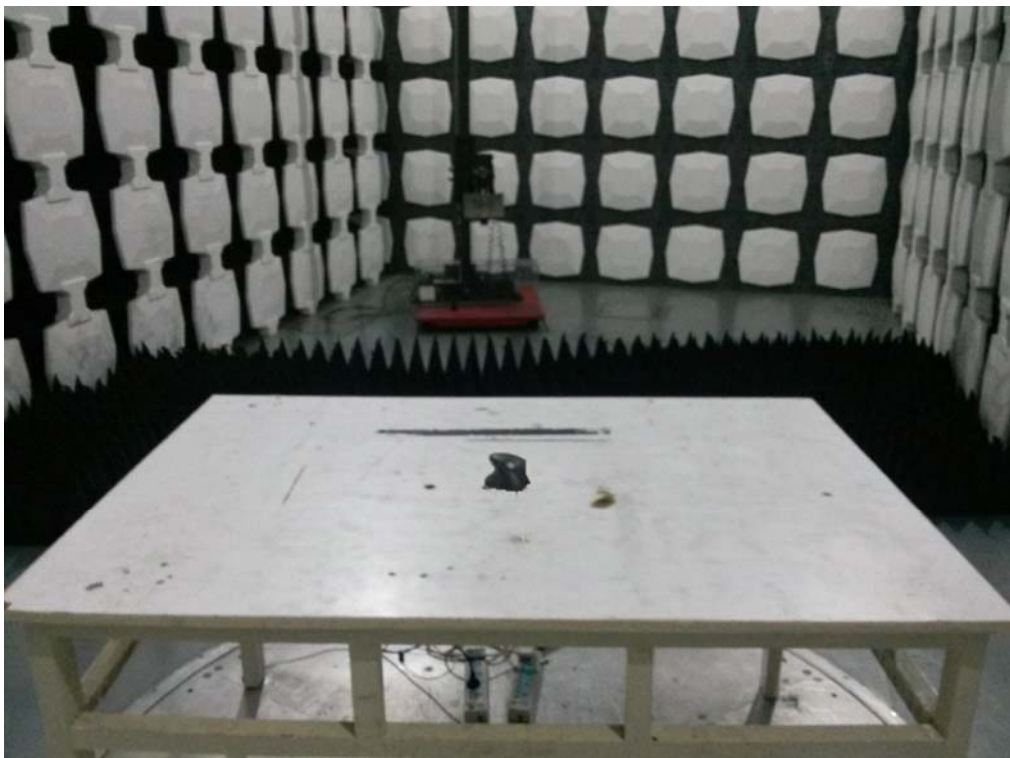

### 10. PHOTOGRAPHS OF THE EUT





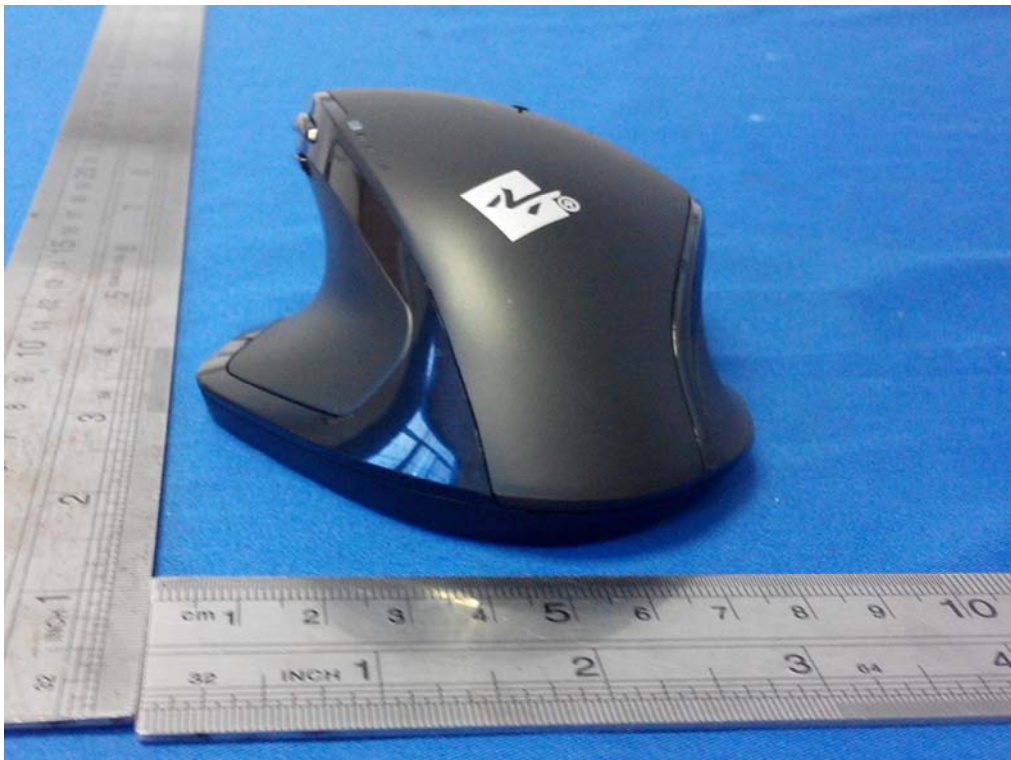
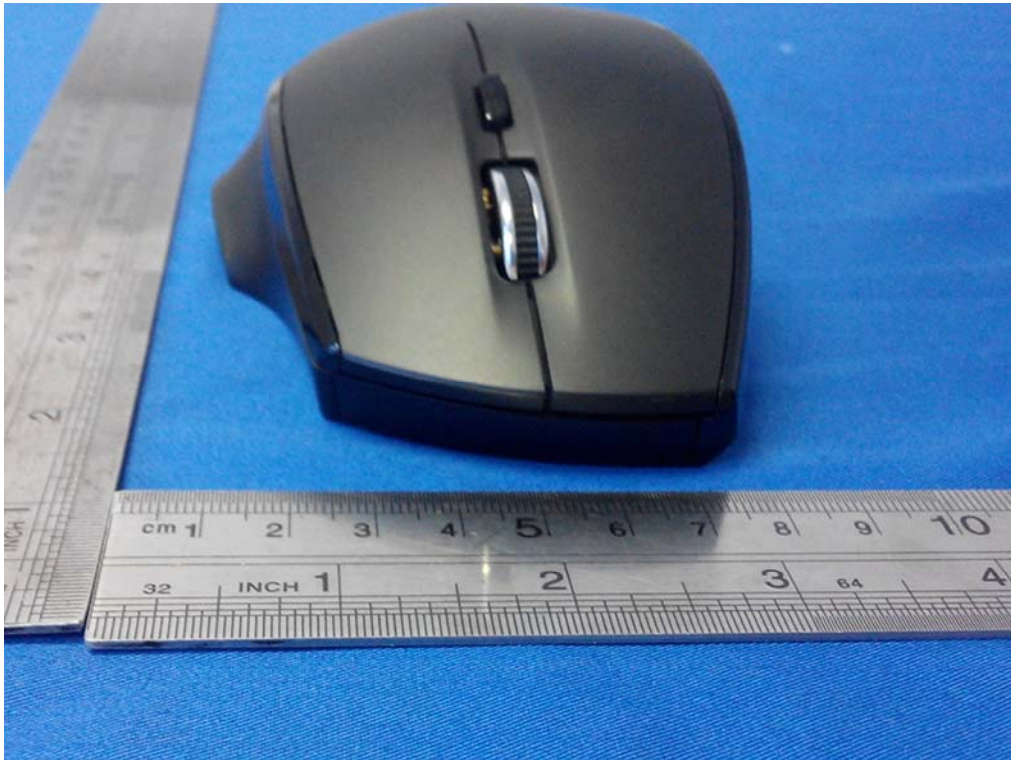

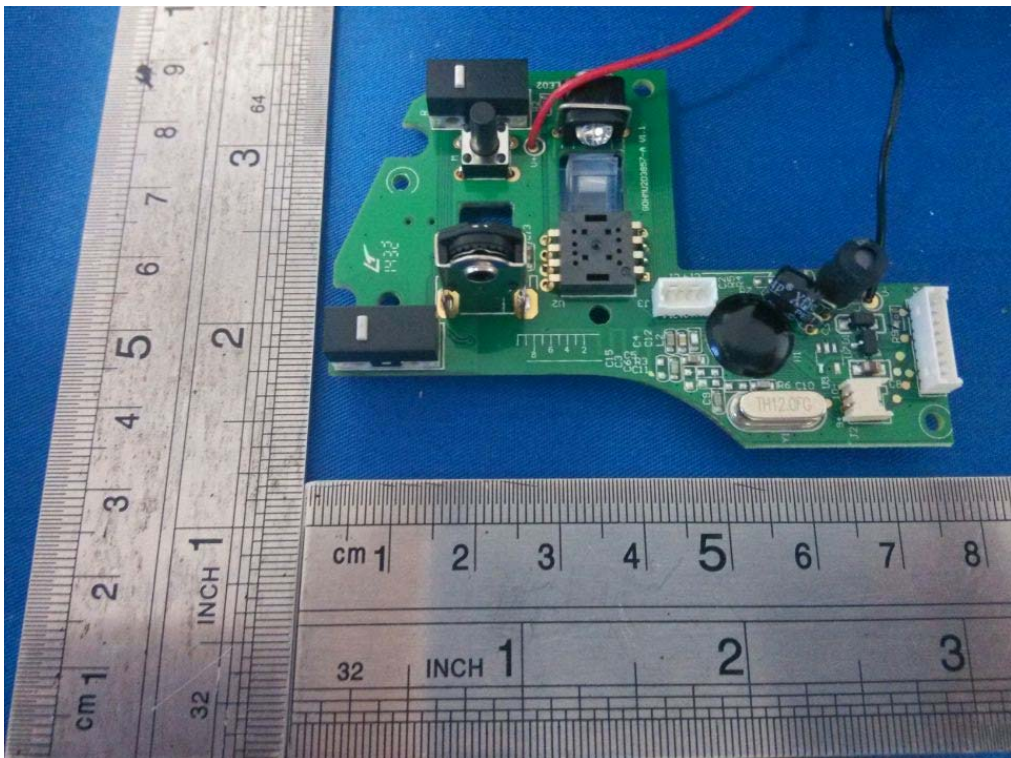
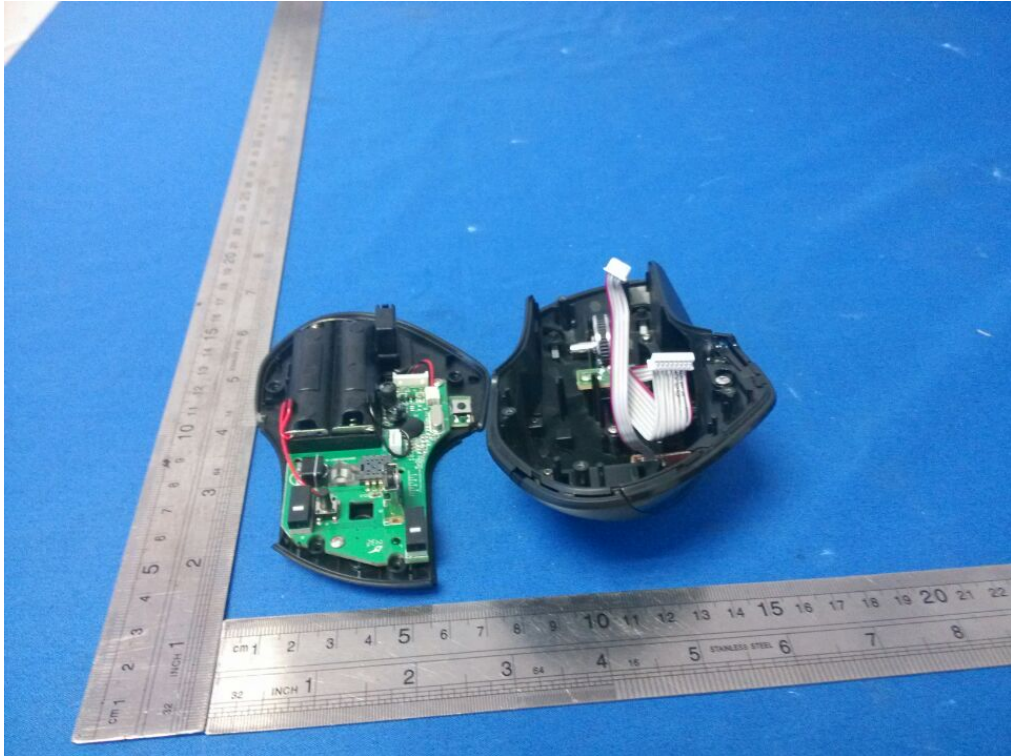

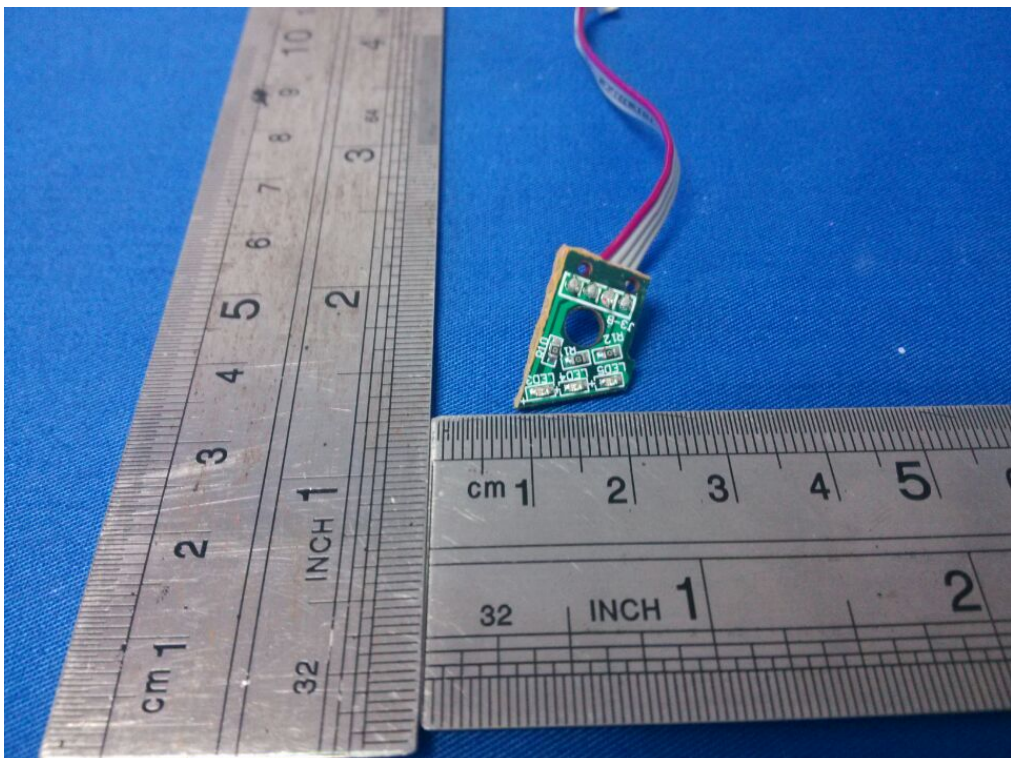
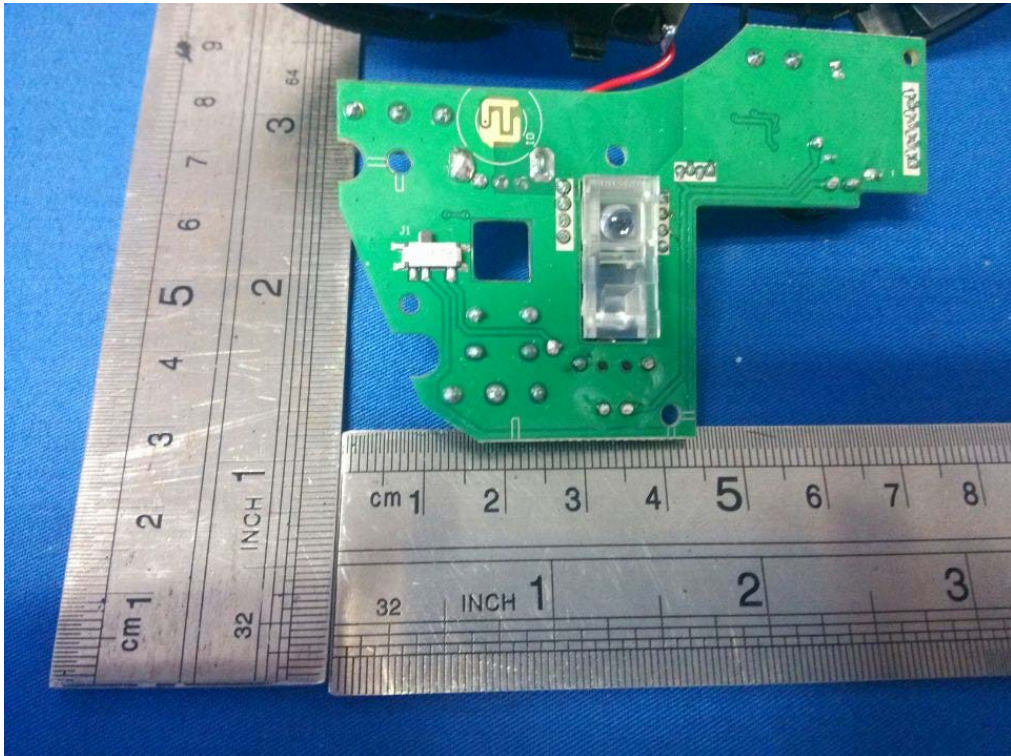

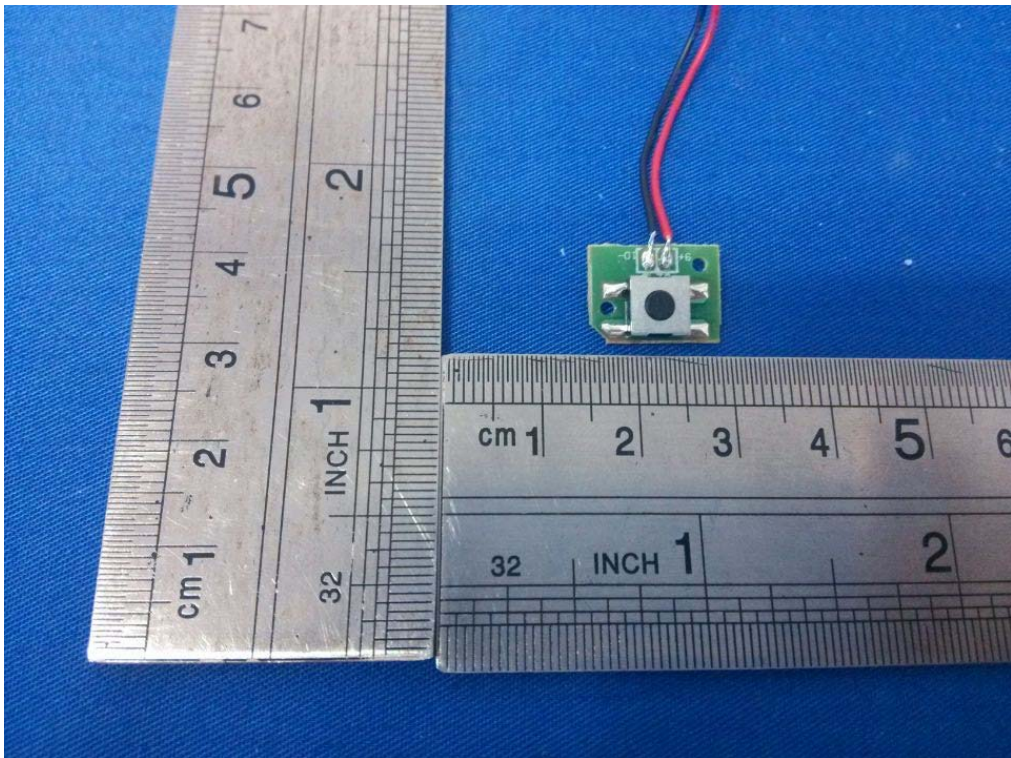
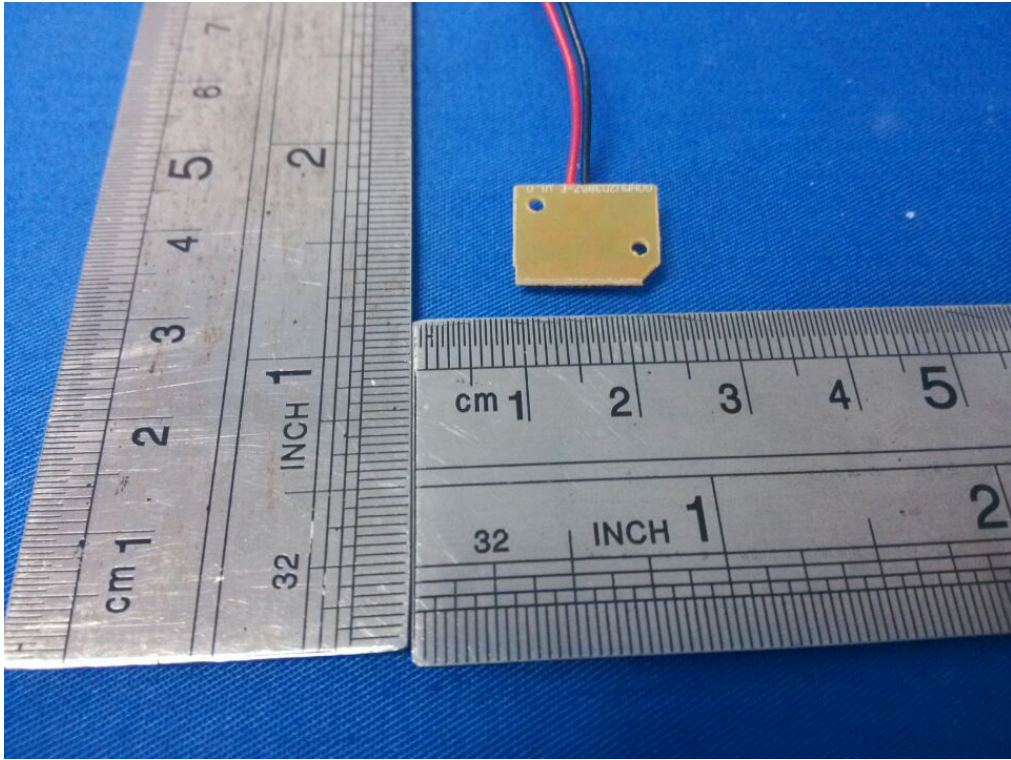

-----End-----