



FCC 47 CFR PART 15 SUBPART C

TEST REPORT

For

Bluetooth Optical Mouse

Model: B12

Trade Name: Acrox; TARGUS

Issued to

Acrox Technologies Co., Ltd.

4F, No. 89, Min shan St., Nei hu Dist., Taipei City 114, Taiwan, R.O.C.

Issued by

Compliance Certification Services Inc.

No.81-1, Lane 210, Bade 2nd Rd., Lujhu Township,

Taoyuan County 33841, Taiwan, R.O.C.

TEL: 886-3-324-0332

FAX: 886-3-324-5235

<http://www.ccsrf.com>

service@ccsrf.com



Note: This report shall not be reproduced except in full, without the written approval of Compliance Certification Services Inc. This document may be altered or revised by Compliance Certification Services Inc. personnel only, and shall be noted in the revision section of the document. The client should not use it to claim product endorsement by TAF, A2LA, NIST or any government agencies. The test results in the report only apply to the tested sample.



Revision History

Rev.	Issue Date	Revisions	Effect Page	Revised By
00	March 22, 2011	Initial Issue	ALL	Jill Shiau



TABLE OF CONTENTS

1	TEST RESULT CERTIFICATION	4
2	EUT DESCRIPTION	5
3	TEST METHODOLOGY	6
3.1.	EUT CONFIGURATION	6
3.2.	EUT EXERCISE	6
3.3.	GENERAL TEST PROCEDURES	6
3.4.	FCC PART 15.205 RESTRICTED BANDS OF OPERATIONS.....	7
3.5.	DESCRIPTION OF TEST MODES.....	8
4	INSTRUMENT CALIBRATION	9
4.1.	MEASUREMENT EQUIPMENT USED	9
4.2.	MEASUREMENT UNCERTAINTY	10
5	FACILITIES AND ACCREDITATIONS	11
5.1.	FACILITIES.....	11
5.2.	EQUIPMENT	11
5.3.	TABLE OF ACCREDITATIONS AND LISTINGS.....	12
6	SETUP OF EQUIPMENT UNDER TEST	13
6.1.	SETUP CONFIGURATION OF EUT	13
6.2.	SUPPORT EQUIPMENT	13
7	FCC PART 15.247 REQUIREMENTS	14
7.1.	20DB BANDWIDTH	14
7.2.	PEAK POWER.....	17
7.3.	AVERAGE POWER.....	18
7.4.	BAND EDGES MEASUREMENT	19
7.5.	FREQUENCY SEPARATION	24
7.6.	NUMBER OF HOPPING FREQUENCY	26
7.7.	TIME OF OCCUPANCY (DWELL TIME).....	28
7.8.	SPURIOUS EMISSIONS	39
7.9.	POWERLINE CONDUCTED EMISSIONS	49
8	RADIO FREQUENCY EXPOSURE	50
9	PHOTOGRAPHS OF TEST SETUP	51



1 TEST RESULT CERTIFICATION

Applicant: Acrox Technologies Co., Ltd.
4F, No. 89, Min shan St., Nei hu Dist., Taipei City 114, Taiwan, R.O.C

Equipment Under Test: Bluetooth Optical Mouse

Trade Name: Acrox; TARGUS

Model: B12

Date of Test: March 14 ~ 17, 2011

APPLICABLE STANDARDS	
STANDARD	TEST RESULT
FCC 47 CFR Part 15 Subpart C	No non-compliance noted

We hereby certify that:

The above equipment was tested by Compliance Certification Services Inc. The test data, data evaluation, test procedures, and equipment configurations shown in this report were made in accordance with the procedures given in ANSI C63.4: 2009 and the energy emitted by the sample EUT tested as described in this report is in compliance with the requirements of FCC Rules Part 15.207, 15.209, 15.247.

The test results of this report relate only to the tested sample EUT identified in this report.

Approved by:

Stan Lin
Supervisor

Reviewed by:

Chieh Cheng
Engineer



2 EUT DESCRIPTION

Product	Bluetooth Optical Mouse
Trade Name	Acrox; TARGUS
Model Number	B12
Model Name Discrepancy	N/A
EUT Power Rating	Power from PC
Operating Frequency Range	2402 ~ 2480 MHz
Transmit Power	0.20 dBm (0.00105W)
Modulation Technique	GFSK
Transmit Data Rate	1Mbps
Number of Channels	79 Channels
Antenna Specification	PCB Antenna / Gain: -1.55dBi

Remark:

- 1. The sample selected for test was production product and was provided by manufacturer.*
- 2. This submittal(s) (test report) is intended for FCC ID: **PRDMU02** filing to comply with Section 15.207, 15.209 and 15.247 of the FCC Part 15, Subpart C Rules.*



3 TEST METHODOLOGY

The tests documented in this report were performed in accordance with ANSI C63.4 (2009) and FCC CFR 47 15.207, 15.209 and 15.247.

3.1. EUT CONFIGURATION

The EUT configuration for testing is installed on RF field strength measurement to meet the Commissions requirement and operating in a manner that intends to maximize its emission characteristics in a continuous normal application.

3.2. EUT EXERCISE

The EUT was operated in the engineering mode to fix the TX frequency that was for the purpose of the measurements.

According to its specifications, the EUT must comply with the requirements of the Section 15.207, 15.209 and 15.247 under the FCC Rules Part 15 Subpart C.

3.3. GENERAL TEST PROCEDURES

Conducted Emissions

The EUT is placed on the turntable, which is 0.8 m above ground plane. According to the requirements in Section 13.1.4.1 of ANSI C63.4 (2009) Conducted emissions from the EUT measured in the frequency range between 0.15 MHz and 30MHz using CISPR Quasi-peak and average detector modes.

Radiated Emissions

The EUT is placed on a turn table, which is 0.8 m above ground plane. The turntable shall rotate 360 degrees to determine the position of maximum emission level. EUT is set 3m away from the receiving antenna, which varied from 1m to 4m to find out the highest emission. And also, each emission was to be maximized by changing the polarization of receiving antenna both horizontal and vertical. In order to find out the maximum emissions, exploratory radiated emission measurements were made according to the requirements in Section 13.1.4.1 of ANSI C63.4 (2009).



3.4. FCC PART 15.205 RESTRICTED BANDS OF OPERATIONS

(a) Except as shown in paragraph (d) of this section, only spurious emissions are permitted in any of the frequency bands listed below:

MHz	MHz	MHz	GHz
0.090 - 0.110	16.42 - 16.423	399.9 - 410	4.5 - 5.15
¹ 0.495 - 0.505	16.69475 - 16.69525	608 - 614	5.35 - 5.46
2.1735 - 2.1905	16.80425 - 16.80475	960 - 1240	7.25 - 7.75
4.125 - 4.128	25.5 - 25.67	1300 - 1427	8.025 - 8.5
4.17725 - 4.17775	37.5 - 38.25	1435 - 1626.5	9.0 - 9.2
4.20725 - 4.20775	73 - 74.6	1645.5 - 1646.5	9.3 - 9.5
6.215 - 6.218	74.8 - 75.2	1660 - 1710	10.6 - 12.7
6.26775 - 6.26825	108 - 121.94	1718.8 - 1722.2	13.25 - 13.4
6.31175 - 6.31225	123 - 138	2200 - 2300	14.47 - 14.5
8.291 - 8.294	149.9 - 150.05	2310 - 2390	15.35 - 16.2
8.362 - 8.366	156.52475 -	2483.5 - 2500	17.7 - 21.4
8.37625 - 8.38675	156.52525	2655 - 2900	22.01 - 23.12
8.41425 - 8.41475	156.7 - 156.9	3260 - 3267	23.6 - 24.0
12.29 - 12.293	162.0125 - 167.17	3332 - 3339	31.2 - 31.8
12.51975 - 12.52025	167.72 - 173.2	3345.8 - 3358	36.43 - 36.5
12.57675 - 12.57725	240 - 285	3600 - 4400	(²)
13.36 - 13.41	322 - 335.4		

¹ Until February 1, 1999, this restricted band shall be 0.490-0.510 MHz.

² Above 38.6

(b) Except as provided in paragraphs (d) and (e), the field strength of emissions appearing within these frequency bands shall not exceed the limits shown in Section 15.209. At frequencies equal to or less than 1000 MHz, compliance with the limits in Section 15.209 shall be demonstrated using measurement instrumentation employing a CISPR quasi-peak detector. Above 1000 MHz, compliance with the emission limits in Section 15.209 shall be demonstrated based on the average value of the measured emissions. The provisions in Section 15.35 apply to these measurements.



3.5. DESCRIPTION OF TEST MODES

The EUT (model: B12) had been tested under operating condition and had been reported as worst case on this test report.

Test program used to control the EUT for staying in continuous transmitting mode was programmed.

After verification, all tests were carried out with the worst case test modes as shown below except radiated spurious emission below 1GHz, which worst case was in normal link mode only.

For the power line conducted emissions test, the EUT has three charge modes, (USB charge mode, power adapter mode and car charger mode), after the preliminary test, the power adapter mode was found to be the worst case and chosen for testing.

Channel Low (2402MHz), Mid (2441MHz) and High (2480MHz) with 1Mbps data rate was chosen for full testing.

The field strength of spurious emission was measured in the following position: EUT stand-up position (Z axis), lie-down position (X, Y axis). The worst emission was found in stand-up position (X axis) and the worst case was recorded.



4 INSTRUMENT CALIBRATION

The measuring equipment, which was utilized in performing the tests documented herein, has been calibrated in accordance with the manufacturer's recommendations for utilizing calibration equipment, which is traceable to recognized national standards.

4.1. MEASUREMENT EQUIPMENT USED

Equipment Used for Emissions Measurement

Remark: Each piece of equipment is scheduled for calibration once a year.

Conducted Emission Test site				
Name of Equipment	Manufacturer	Model	Serial Number	Calibration Due
Spectrum Analyzer	Agilent	E4446A	MY48250064	12/29/2011
Spectrum Analyzer	R&S	FSEB	825829/011	12/12/2011
Power meter	Anritsu	MA2411B	917221	08/24/2011

3M Semi Anechoic Chamber				
Name of Equipment	Manufacturer	Model	Serial Number	Calibration Due
Spectrum Analyzer	Agilent	E4446A	MY48250064	12/29/2011
Pre-Amplifier	HP	8447D	2944A06530	01/02/2012
Pre-Amplifier	HP	8449B	3008A01738	04/17/2011
EMI Test Receiver	SCHAFFNER	SCR 3501	430	01/18/2012
Loop Antenna	EMCO	6502	2356	06/11/2013
Bilog Antenna	SCHWAZBECK	VULB9160	3084	10/07/2011
Horn Antenna	EMCO	3115	00022250	05/09/2011
Turn Table	CCS	CC-T-1F	N/A	N.C.R
Antenna Tower	CCS	CC-A-1F	N/A	N.C.R
Controller	CCS	CC-C-1F	N/A	N.C.R
Spectrum Analyzer	Agilent	E4446A	MY48250064	12/29/2011
Test S/W	LabVIEW 6.1 (Wugu Chamber EMI Test V1_4.5.3)			



4.2. MEASUREMENT UNCERTAINTY

For the test methods, according to the present document, the measurement uncertainty figures shall be calculated in accordance with TR 100 028-1 [2] and shall correspond to an expansion factor (coverage factor) $k = 1,96$ or $k = 2$ (which provide confidence levels of respectively 95 % and 95,45 % in the case where the distributions characterizing the actual measurement uncertainties are normal (Gaussian)).

Table 6 is based on such expansion factors.

Table 6: Maximum measurement uncertainty

Parameter	Uncertainty
RF frequency	$\pm 1 \cdot 10^{-5}$
Total RF power conducted	$\pm 1,5$ dB
RF power density, conducted	± 3 dB
Spurious emissions, conducted	± 3 dB
All emissions, radiated	± 6 dB
Humidity	± 5 %
Temperature	± 1 °C
DC and low frequency voltages	± 3 %
Powerline Conducted Emission	± 2.0518



5 FACILITIES AND ACCREDITATIONS

5.1. FACILITIES

All measurement facilities used to collect the measurement data are located at

- No.199, Chunghsen Road, Hsintien City, Taipei Hsien, Taiwan, R.O.C.
Tel: 886-2-2217-0894 / Fax: 886-2-2217-1029

- No.11, Wugong 6th Rd., Wugu Industrial Park, Taipei Hsien 248, Taiwan
Tel: 886-2-2299-9720 / Fax: 886-2-2298-4045

- No.81-1, Lane 210, Bade 2nd Rd., Lujhu Township, Taoyuan County 33841, Taiwan, R.O.C.
Tel: 886-3-324-0332 / Fax: 886-3-324-5235

The sites are constructed in conformance with the requirements of ANSI C63.7, ANSI C63.4 (2009) and CISPR Publication 22.

5.2. EQUIPMENT

Radiated emissions are measured with one or more of the following types of linearly polarized antennas: tuned dipole, biconical, log periodic, bi-log, and/or ridged waveguide, horn. Spectrum analyzers with pre-selectors and quasi-peak detectors are used to perform radiated measurements.





Conducted emissions are measured with Line Impedance Stabilization Networks and EMI Test Receivers.

Calibrated wideband preamplifiers, coaxial cables, and coaxial attenuators are also used for making measurements.

All receiving equipment conforms to CISPR Publication 16-1, "Radio Interference Measuring Apparatus and Measurement Methods."

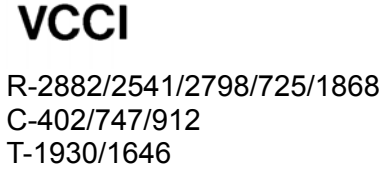

5.3. TABLE OF ACCREDITATIONS AND LISTINGS

Country	Agency	Scope of Accreditation	Logo
USA	A2LA	CFR 47, FCC Part15/18, CISPR 22, EN 55022, ICES-003, AS/NZS CISPR 22, VCCI V-3, EN 55011, CISPR 11, IEC/EN 61000-4-2/3/4/5/6/8/11, EN 61000-6-1/2/3/4, EN 55024, CISPR 24, AS/NZS CISPR 24, AS/NZS 61000.6.2, EN 55014-1/-2, ETSI EN 300 386 v1.3.2/v1.3.3, IEC/EN 61000-3-2, AS/NZS 61000.3.2, IEC/EN 61000-3-3, AS/NZS 61000.3.3	
USA	FCC MRA	3/10 meter Open Area Test Sites to perform FCC Part 15/18 measurements	
Japan	VCCI	3/10 meter Open Area Test Sites and conducted test sites to perform radiated/conducted measurements	
Taiwan	TAF	EN 55014-1, CISPR 14, CNS 13781-1, EN 55013, CISPR 13, CNS 13439, EN 55011, CISPR 11, CNS 13803, PLMN09, IS2045-0, LP0002 FCC Part 27/90, Part 15B/C/D/E, RSS-192/193/210/310 ETSI EN 300 328/ 300 220-1/ 300 220-2/ 301 893/ 301 489-01/ 301 489-03/ 301 489-07 / 301 489-17/ 300 440-1/ 300 440-2 AS/NZS 4268, AS/NZS 4771 CISPR 22, EN 55022, CNS 13438, AS/NZS CISPR 22, VCCI, IEC/EN 61000-4-2/3/4/5/6/8/11, CNS 14676-2/3/4/5/6/8, CNS 14934-2/3, CNS 13783-1, CNS 13439, CNS 13803	
Taiwan	BSMI	CNS 13438, CNS 13783-1, CNS 13439, CNS 14115	SL2-IS-E-0014 / IN-E-0014 /A1-E-0014 /R1-E-0014 /R2-E-0014 /L1-E-0014
Canada	Industry Canada	RSS-Gen Issue 3	

Note: No part of this report may be used to claim or imply product endorsement by A2LA, TAF or other government agency.



6 SETUP OF EQUIPMENT UNDER TEST

6.1. SETUP CONFIGURATION OF EUT

See test photographs attached in Appendix 1 for the actual connections between EUT and support equipment.

6.2. SUPPORT EQUIPMENT

For Conducted & Radiated Emission measurement (Above 1GHz):							
No.	Equipment	Model No.	Serial No.	BSMI ID	Trade Name	Data Cable	Power Cord
1.	N/A						

****No any support equipment during the test.**

For Radiated Emission measurement (Below 1GHz) & Power line conducted emission measurement:							
No.	Equipment	Model No.	Serial No.	BSMI ID	Trade Name	Data Cable	Power Cord
1.	Notebook PC	D400	0932RY	R33002	DELL	N/A	Unshielded, 1.8m
2.	LCD Monitor	2407WFPb	CN-0FC255-46633-6 75-22TJS	DELL	Logitech	D-SUB Cable: Shielded, 1.8m, with two cores	Unshielded, 1.8m
3.	Printer	STYLUS C60	DR3K039632	3902E006	EPSON	Unshielded, 1.8m	Unshielded, 1.8m

Remark: Grounding was established in accordance with the manufacturer's requirements and conditions for the intended use.



7 FCC PART 15.247 REQUIREMENTS

7.1. 20DB BANDWIDTH

LIMIT

None; for reporting purposes only.

TEST CONFIGURATION

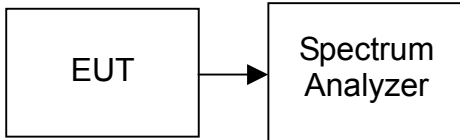

TEST PROCEDURE

1. Place the EUT on the table and set it in the transmitting mode.
2. Remove the antenna from the EUT and then connect a low loss RF cable from the antenna port to the spectrum analyzer.
3. Set the spectrum analyzer as RBW=30kHz, VBW = 100kHz, Span = 3MHz, Sweep = auto.
4. Mark the peak frequency and 20dB (upper and lower) frequency.
5. Repeat until all the rest channels are investigated.

TEST RESULTS

No non-compliance noted



Test Plot

20dB Bandwidth (CH Low)

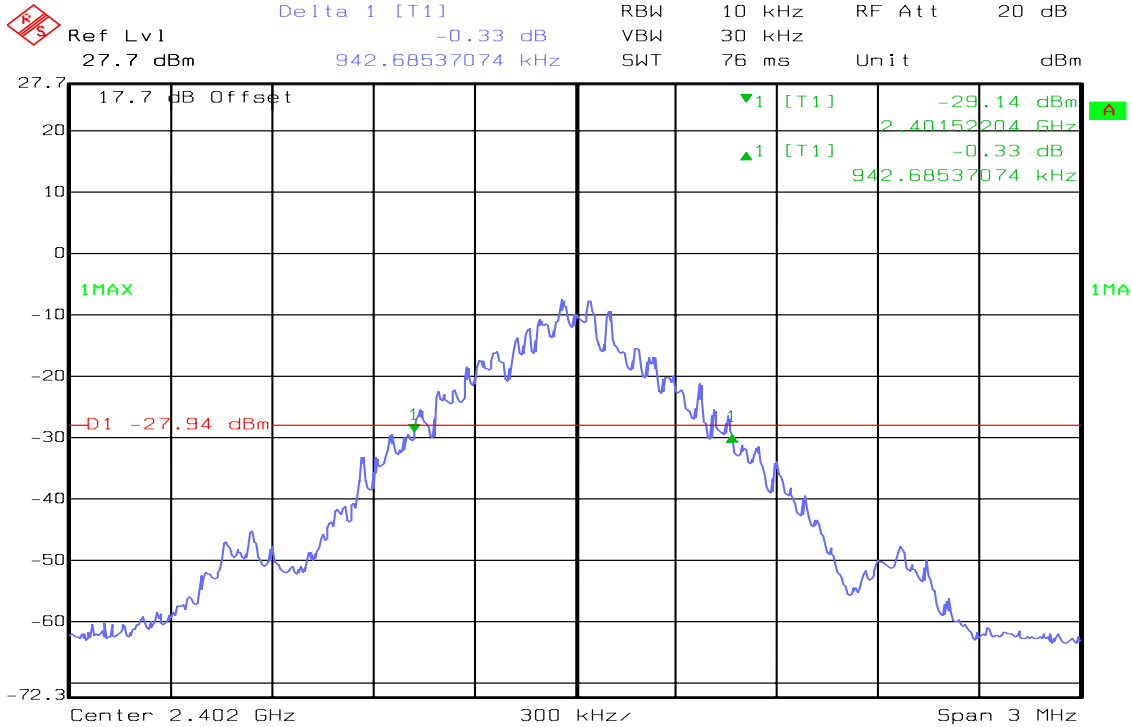

Date: 14.MAR.2011 19:46:28

20dB Bandwidth (CH Mid)

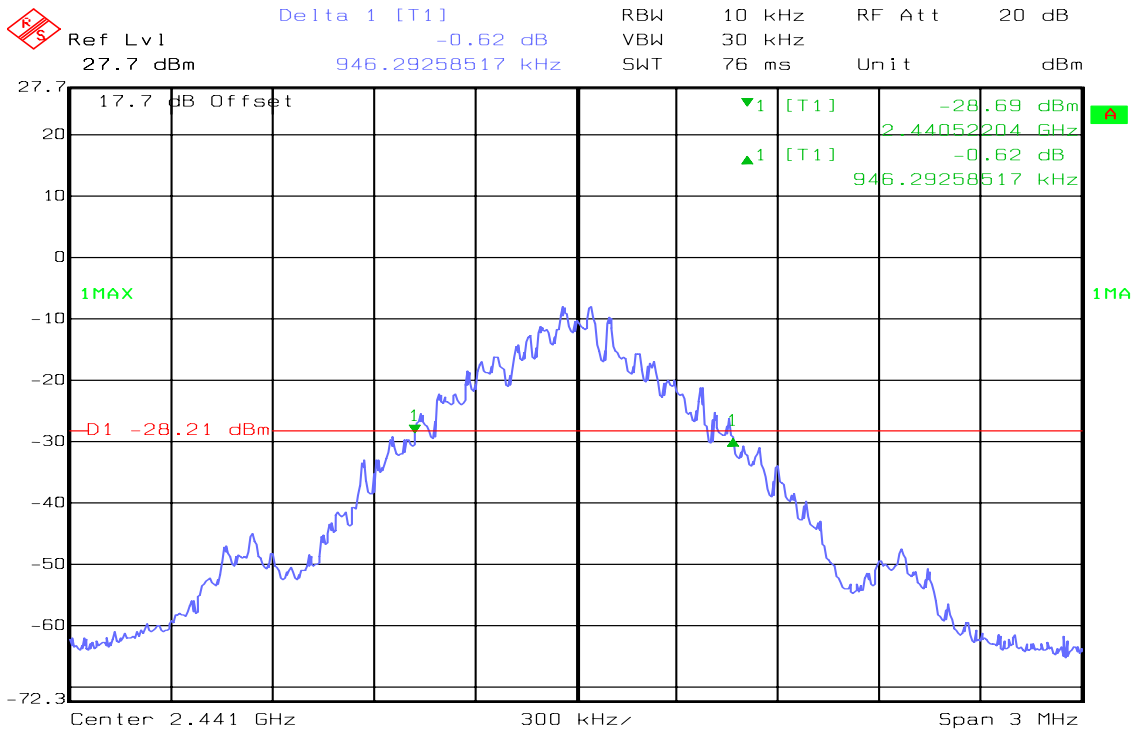

Date: 14.MAR.2011 19:48:00



20dB Bandwidth (CH High)

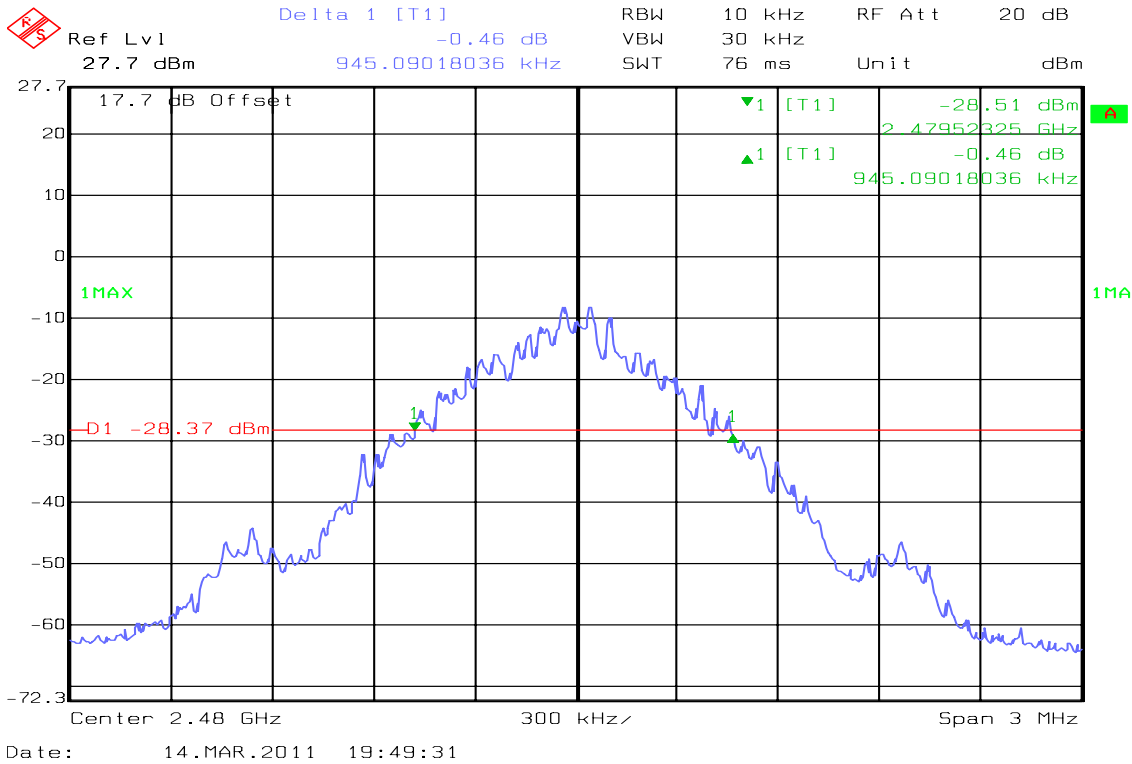



7.2. PEAK POWER

LIMIT

According to §15.247, the maximum peak output power of the intentional radiator shall not exceed the following:

1. According to §15.247(a)(1), Frequency hopping systems shall have hopping channel carrier frequencies separated by a minimum of 25 kHz or the 20 dB bandwidth of the hopping channel, whichever is greater. Alternatively, frequency hopping systems operating in the 2400-2483.5 MHz band may have hopping channel carrier frequencies that are separated by 25 kHz or two-thirds of the 20 dB bandwidth of the hopping channel, whichever is greater, provided the systems operate with an output power no greater than 125 mW.
2. According to §15.247(b)(3), for systems using digital modulation in the bands of 902-928 MHz, 2400-2483.5 MHz, and 5725-5850 MHz: 1 watt.
3. According to §15.247(b) (4), the conducted output power limit specified in paragraph (b) of this section is based on the use of antennas with directional gains that do not exceed 6 dBi. Except as shown in paragraph (c) of this section, if transmitting antennas of directional gain greater than 6 dBi are used, the conducted output power from the intentional radiator shall be reduced below the stated values in paragraphs (b)(1), (b)(2), and (b)(3) of this section, as appropriate, by the amount in dB that the directional gain of the antenna exceeds 6 dBi.

TEST CONFIGURATION

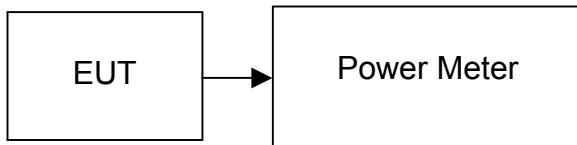

TEST PROCEDURE

The transmitter output is connected to the Power Meter. The Power Meter is set to the peak power detection.

TEST RESULTS

No non-compliance noted

TEST DATA

Channel	Frequency (MHz)	Output Power (dBm)	Output Power (W)	Limit (W)	Test Result
Low	2402	0.20	0.001047	0.125	PASS
Mid	2441	-0.09	0.000979		PASS
High	2480	-0.16	0.000964		PASS



7.3. AVERAGE POWER

LIMIT

None; for reporting purposes only.

TEST CONFIGURATION

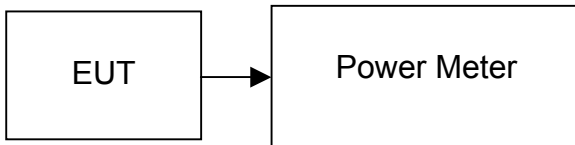

TEST PROCEDURE

The transmitter output is connected to the Power Meter. The Power Meter is set to the average power detection.

TEST RESULTS

No non-compliance noted

TEST DATA

Channel	Frequency (MHz)	Output Power (dBm)	Output Power (W)
Low	2402	-1.22	0.000755
Mid	2441	-1.62	0.000689
High	2480	-1.74	0.000670



7.4. BAND EDGES MEASUREMENT

LIMIT

According to §15.247(d), in any 100 kHz bandwidth outside the frequency band in which the spread spectrum or digitally modulated intentional radiator is operating, the radio frequency power that is produced by the intentional radiator shall be at least 20 dB below that in the 100 kHz bandwidth within the band that contains the highest level of this paragraph shall be 30 dB instead of 20 dB. Attenuation below the general limits specified in Section 15.209(a) is not required. In addition, radiated emissions which fall in the restricted bands, as defined in Section 15.205(a), must also comply with the radiated emission limits specified in Section 15.209(a) (see Section 15.205(c)).

TEST CONFIGURATION

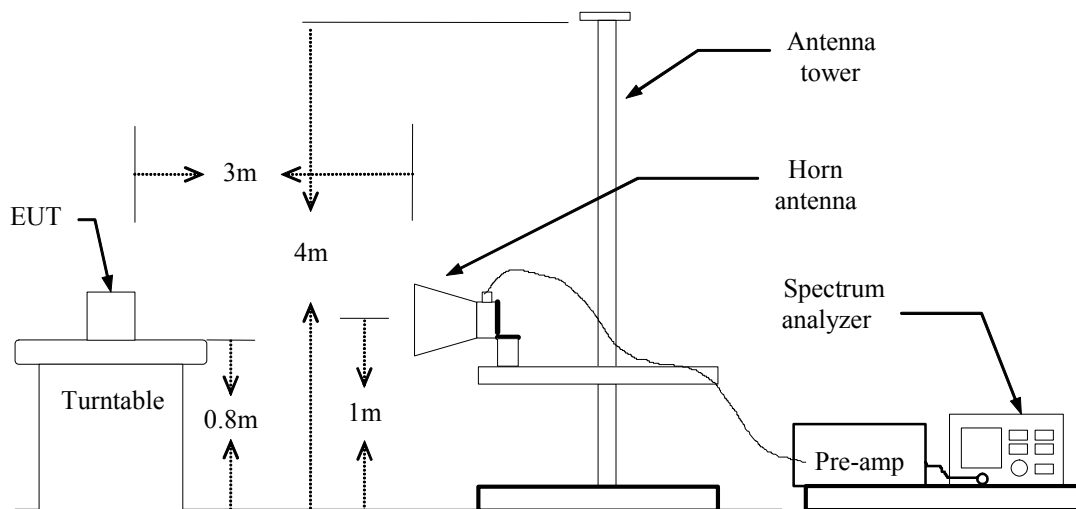

TEST PROCEDURE

1. The EUT is placed on a turntable, which is 0.8m above the ground plane.
2. The turntable shall be rotated for 360 degrees to determine the position of maximum emission level.
3. EUT is set 3m away from the receiving antenna, which is varied from 1m to 4m to find out the highest emission.
4. Set the spectrum analyzer in the following setting in order to capture the lower and upper band-edges of the emission:
 - (a) PEAK: RBW=VBW=1MHz / Sweep=100ms
 - (b) AVERAGE: RBW=1MHz / VBW=10Hz / Sweep=AUTO
5. Repeat the procedures until all the PEAK and AVERAGE versus POLARIZATION are measured.

TEST RESULTS

No non-compliance noted

TEST DATA

Refer to attach spectrum analyzer data chart.



Band Edges (CH Low)

Detector mode: Peak

Polarity: Vertical

Agilent 17:12:36 Mar 17, 2011

R T

Mkr3 2.401 83 GHz
81.41 dB μ V/m

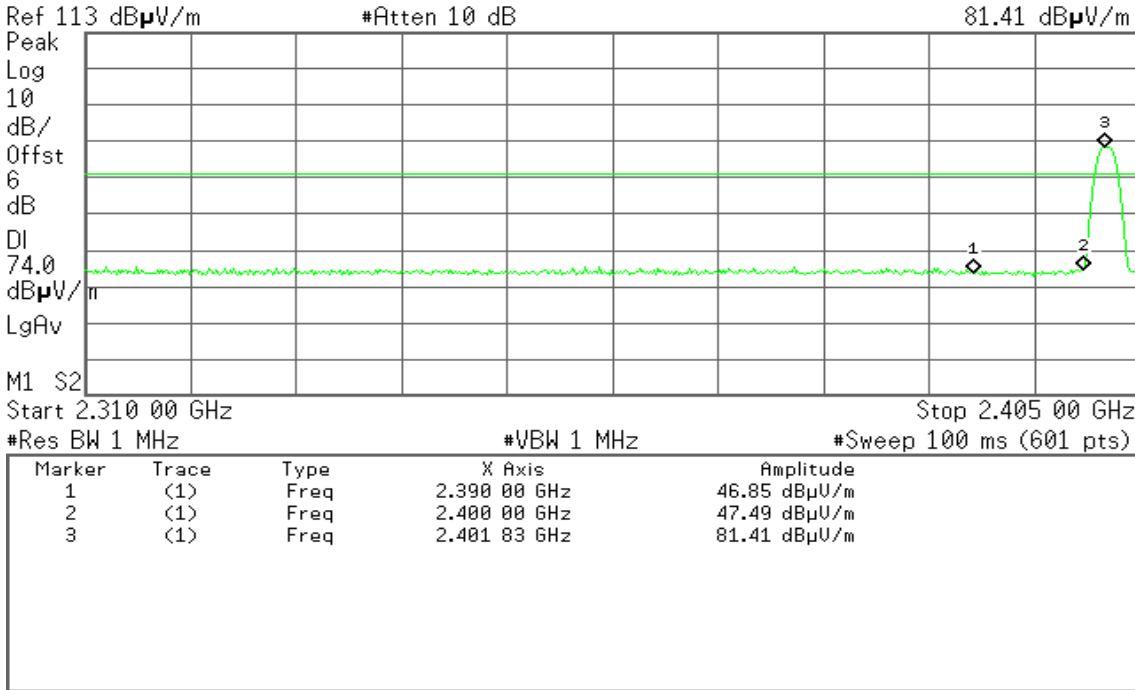

Detector mode: Average

Polarity: Vertical

Agilent 17:14:52 Mar 17, 2011

R T

Mkr3 2.401 99 GHz
81.14 dB μ V/m

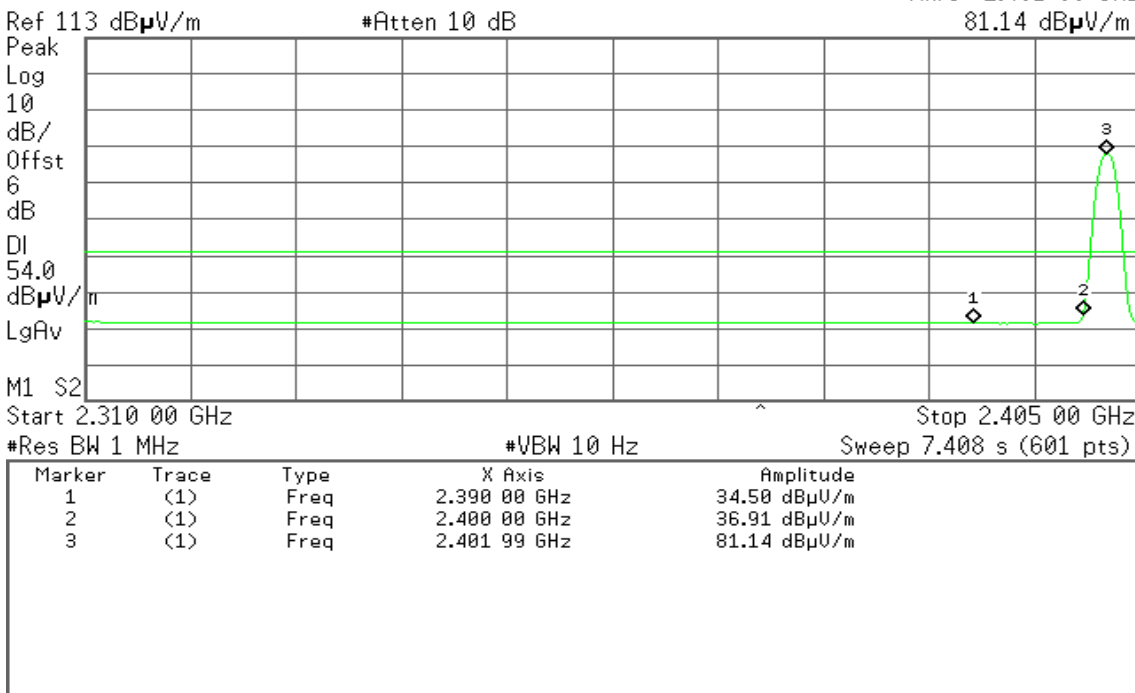



Detector mode: Peak

Polarity: Horizontal

Agilent 17:17:07 Mar 17, 2011

R T

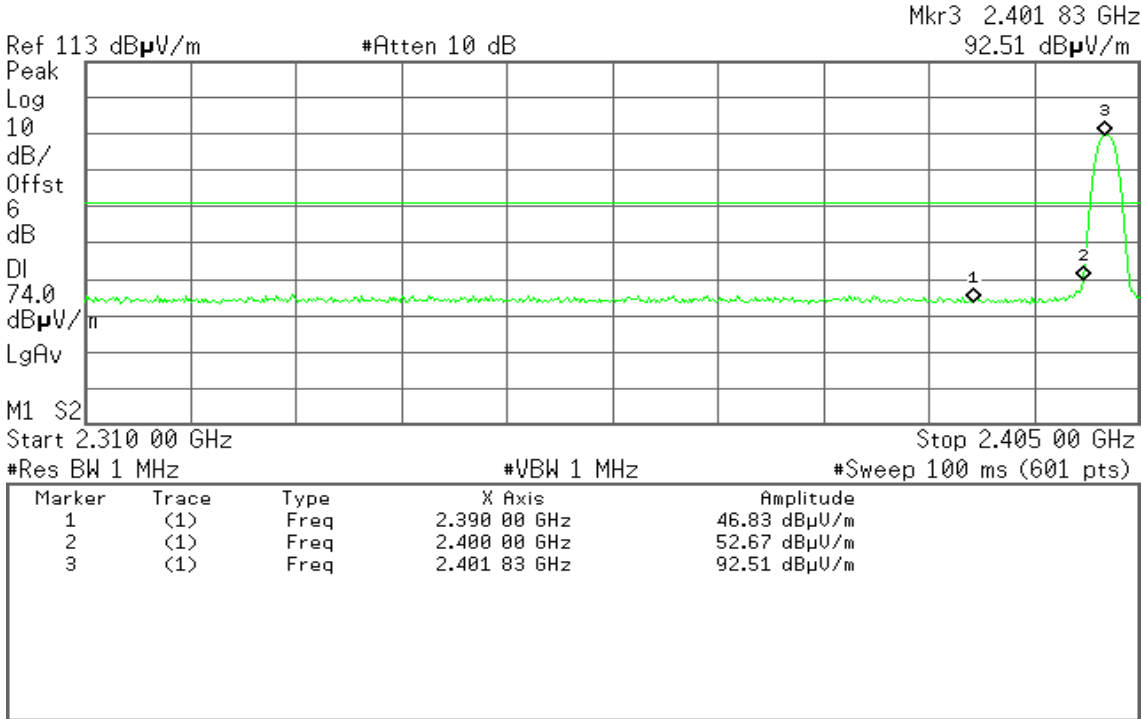

Detector mode: Average

Polarity: Horizontal

Agilent 17:19:01 Mar 17, 2011

R T

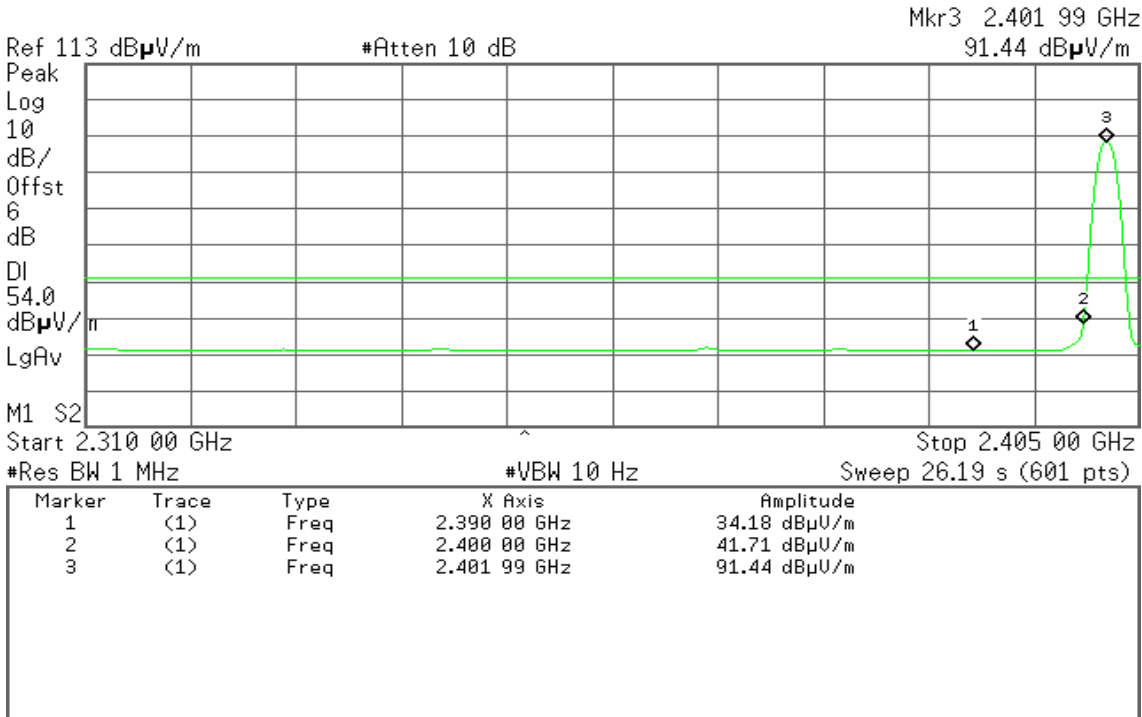



Band Edges (CH High)

Detector mode: Peak

Polarity: Vertical

Agilent 17:26:26 Mar 17, 2011

R T

Mkr1 2.480 17 GHz
78.78 dB μ V/m

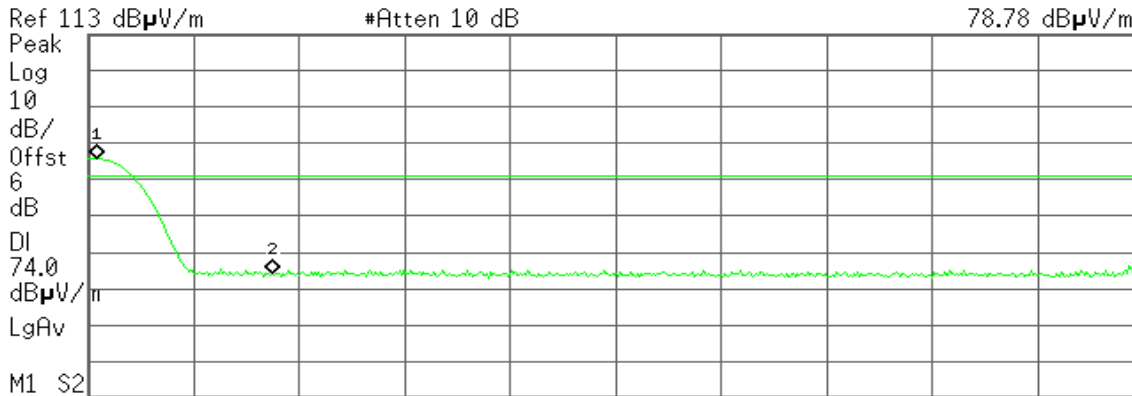

Ref 113 dB μ V/m #Atten 10 dB
Start 2.480 00 GHz Stop 2.500 00 GHz
#Res BW 1 MHz #VBW 1 MHz #Sweep 100 ms (601 pts)

Marker	Trace	Type	X Axis	Amplitude
1	(1)	Freq	2.480 17 GHz	78.78 dB μ V/m
2	(1)	Freq	2.483 50 GHz	47.28 dB μ V/m

Detector mode: Average

Polarity: Vertical

Agilent 17:27:26 Mar 17, 2011

R T

Mkr1 2.480 00 GHz
78.28 dB μ V/m

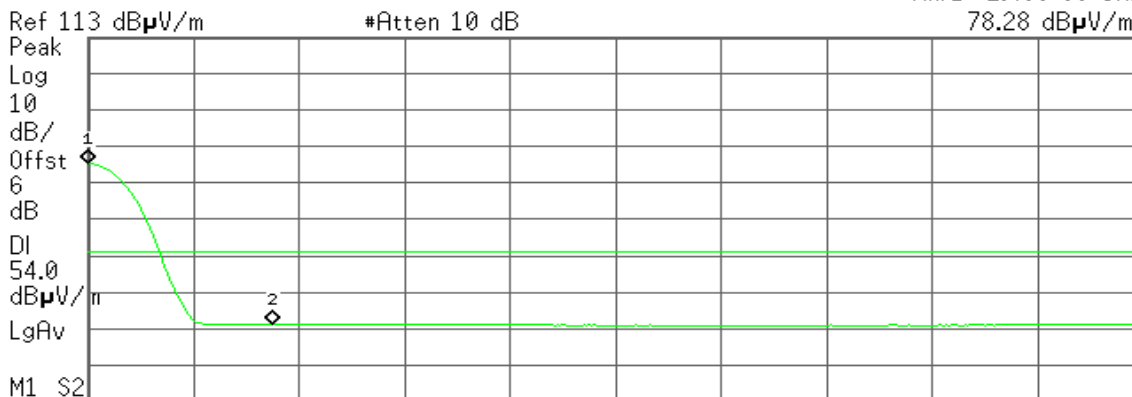

Ref 113 dB μ V/m #Atten 10 dB
Start 2.480 00 GHz Stop 2.500 00 GHz
#Res BW 1 MHz #VBW 10 Hz Sweep 5.514 s (601 pts)

Marker	Trace	Type	X Axis	Amplitude
1	(1)	Freq	2.480 00 GHz	78.28 dB μ V/m
2	(1)	Freq	2.483 50 GHz	34.17 dB μ V/m



Detector mode: Peak

Polarity: Horizontal

Agilent 17:23:00 Mar 17, 2011

R T

Mkr1 2.480 20 GHz
89.70 dBµV/m

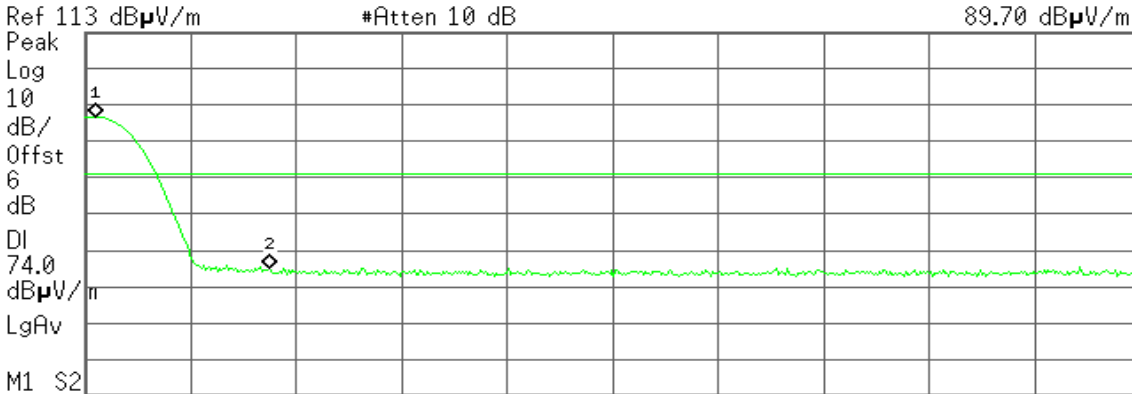

Start 2.480 00 GHz Stop 2.500 00 GHz
#Res BW 1 MHz #VBW 1 MHz #Sweep 100 ms (601 pts)

Marker	Trace	Type	X Axis	Amplitude
1	(1)	Freq	2.480 20 GHz	89.70 dBµU/m
2	(1)	Freq	2.483 50 GHz	47.95 dBµU/m

Detector mode: Average

Polarity: Horizontal

Agilent 17:24:32 Mar 17, 2011

R T

Mkr1 2.480 00 GHz
89.47 dBµV/m

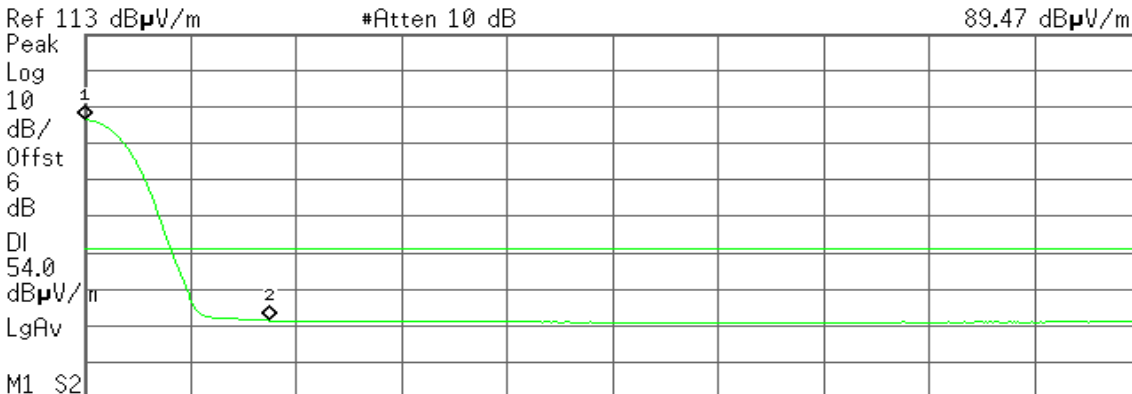

Start 2.480 00 GHz Stop 2.500 00 GHz
#Res BW 1 MHz #VBW 10 Hz Sweep 5.514 s (601 pts)

Marker	Trace	Type	X Axis	Amplitude
1	(1)	Freq	2.480 00 GHz	89.47 dBµU/m
2	(1)	Freq	2.483 50 GHz	34.42 dBµU/m



7.5. FREQUENCY SEPARATION

LIMIT

According to §15.247(a)(1), Frequency hopping systems shall have hopping channel carrier frequencies separated by a minimum of 25 kHz or the 20 dB bandwidth of the hopping channel, whichever is greater. Alternatively, frequency hopping systems operating in the 2400-2483.5 MHz band may have hopping channel carrier frequencies that are separated by 25 kHz or two-thirds of the 20 dB bandwidth of the hopping channel, whichever is greater, provided the systems operate with an output power no greater than 125 mW.

TEST CONFIGURATION

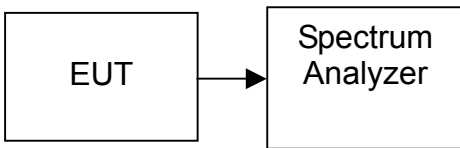

TEST PROCEDURE

1. Place the EUT on the table and set it in transmitting mode.
2. Remove the antenna from the EUT and then connect a low loss RF cable from the antenna port to the spectrum analyzer.
3. Set center frequency of spectrum analyzer = middle of hopping channel.
4. Set the spectrum analyzer as RBW = 30kHz, VBW = 100kHz, Span = 3MHz, Sweep = auto.
5. Max hold, mark 3 peaks of hopping channel and record the 3 peaks frequency.

TEST RESULTS

No non-compliance noted

TEST DATA

Channel Separation (MHz)	Result
1.00	Pass



Test Plot

Measurement of Channel Separation

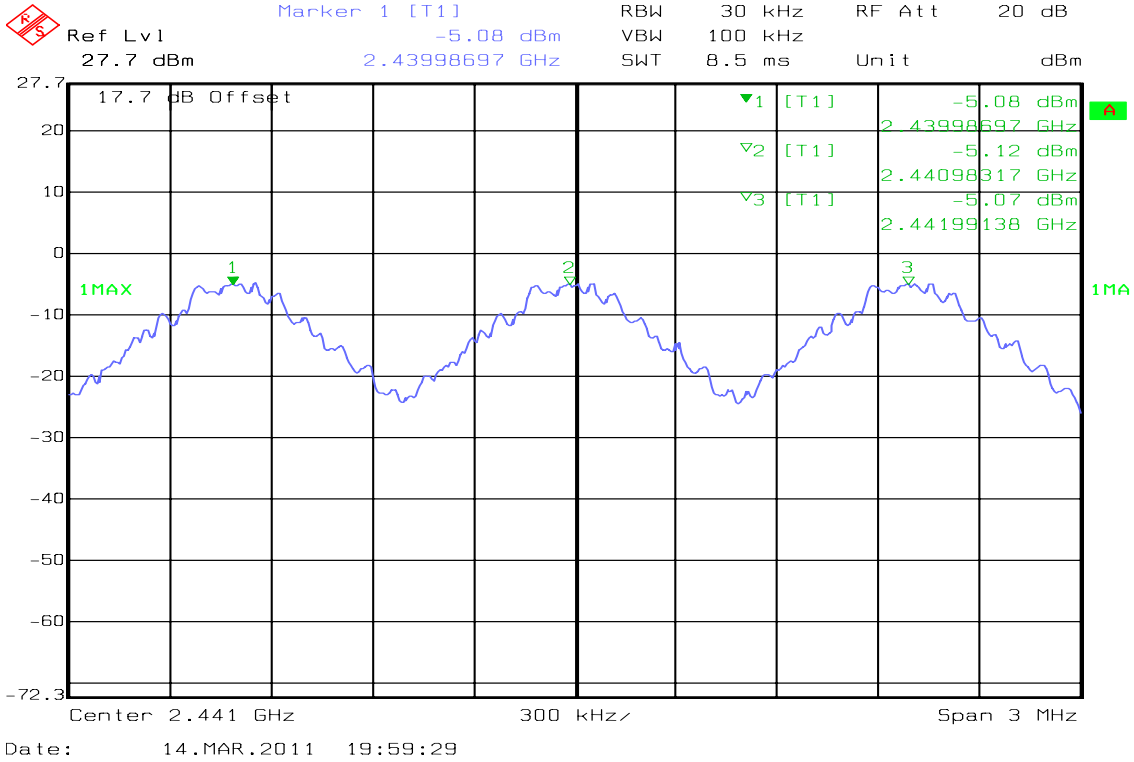



7.6. NUMBER OF HOPPING FREQUENCY

LIMIT

According to §15.247(a)(1)(ii), Frequency hopping systems operating in the 2400MHz-2483.5 MHz bands shall use at least 15 hopping frequencies.

TEST CONFIGURATION

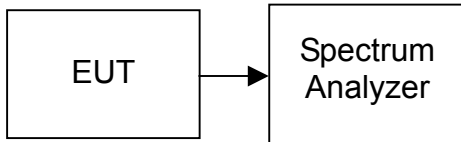

TEST PROCEDURE

1. Place the EUT on the table and set it in transmitting mode.
2. Remove the antenna from the EUT and then connect a low loss RF cable from the antenna port to the spectrum analyzer.
3. Set spectrum analyzer Start=2400MHz, Stop = 2441.5MHz, Sweep = auto and Start=2441.5MHz, Stop = 2483.5MHz, Sweep = auto.
4. Set the spectrum analyzer as RBW, VBW=510kHz.
5. Max hold, view and count how many channel in the band.

TEST RESULTS

No non-compliance noted

TEST DATA

Result (No. of CH)	Limit (No. of CH)	Result
79	>75	PASS



Test Plot

Channel Number

2.4 GHz – 2.4415 GHz

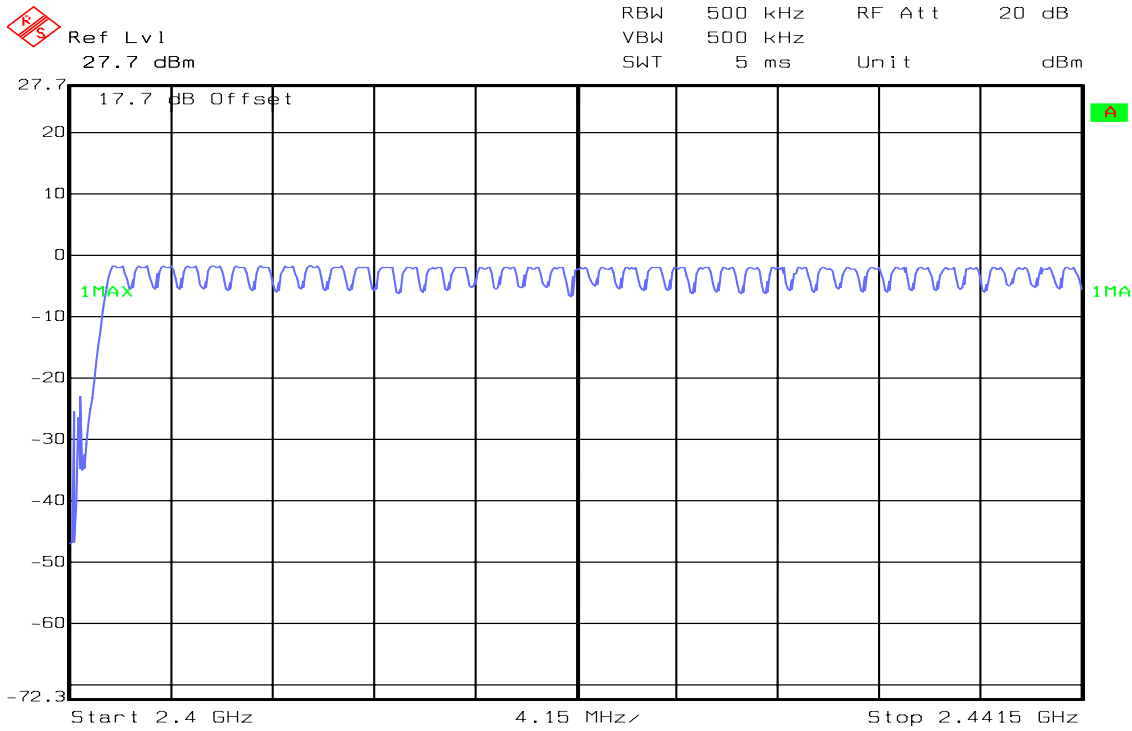

Date: 14.MAR.2011 20:01:43

2.4415 GHz – 2.4835 GHz

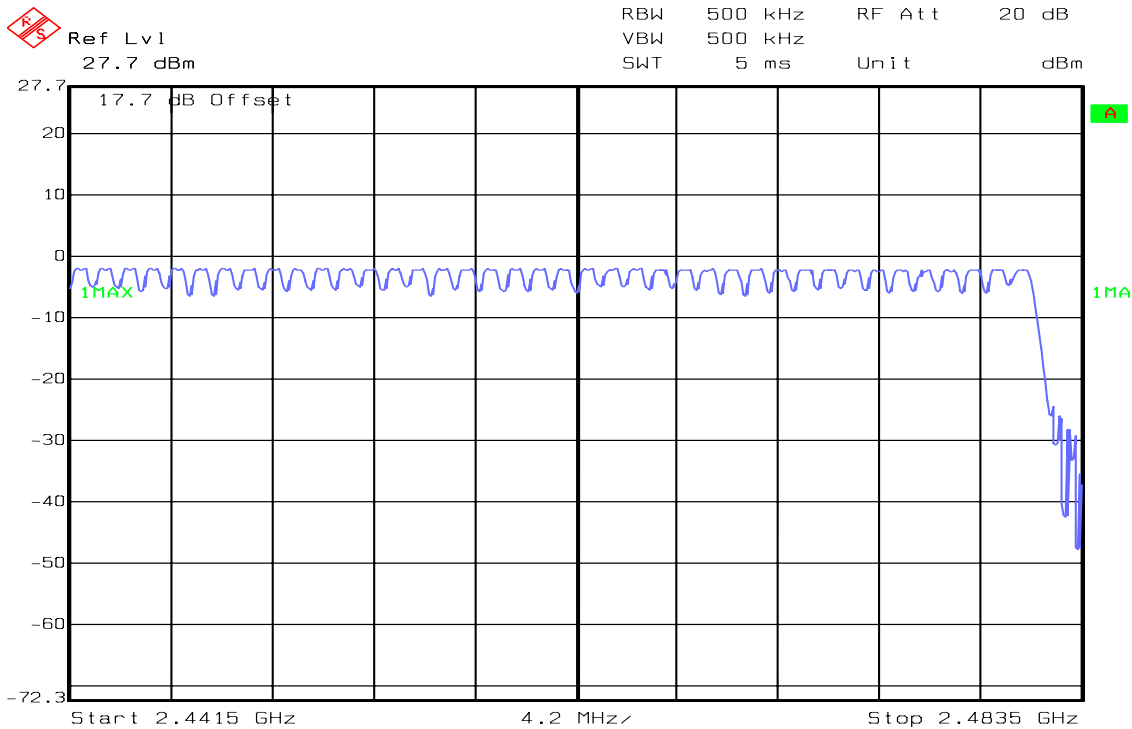

Date: 14.MAR.2011 20:02:37



7.7. TIME OF OCCUPANCY (DWELL TIME)

LIMIT

According to §15.247(a)(1)(iii), Frequency hopping systems operating in the 2400MHz-2483.5 MHz bands. The average time of occupancy on any channels shall not greater than 0.4 s within a period 0.4 s multiplied by the number of hopping channels employed.

TEST CONFIGURATION

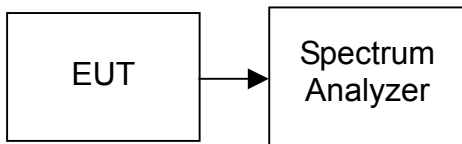

TEST PROCEDURE

1. Place the EUT on the table and set it in transmitting mode.
2. Remove the antenna from the EUT and then connect a low loss RF cable from the antenna port to the spectrum analyzer.
3. Set center frequency of spectrum analyzer = operating frequency.
4. Set the spectrum analyzer as RBW, VBW=1MHz, Span = 0Hz, Sweep = 10ms.
5. Repeat above procedures until all frequency measured were complete.

TEST RESULTS

No non-compliance noted



TEST DATA

DH 1

CH Low: $0.541 * (1600/2)/79 * 31.60 = 173.15$ (ms)

CH Mid: $0.557 * (1600/2)/79 * 31.60 = 178.28$ (ms)

CH High: $0.557 * (1600/2)/79 * 31.60 = 178.28$ (ms)

CH	Pulse Time (ms)	Total of Dwell (ms)	Period Time (s)	Limit (ms)	Result
Low	0.541	173.15	31.60	400.00	PASS
Mid	0.557	178.28	31.60		PASS
High	0.557	178.28	31.60		PASS

DH 3

CH Low: $1.804 * (1600/4)/79 * 31.60 = 288.58$ (ms)

CH Mid: $1.798 * (1600/4)/79 * 31.60 = 287.62$ (ms)

CH High: $1.804 * (1600/4)/79 * 31.60 = 288.58$ (ms)

CH	Pulse Time (ms)	Total of Dwell (ms)	Period Time (s)	Limit (ms)	Result
Low	1.804	288.58	31.60	400.00	PASS
Mid	1.798	287.62	31.60		PASS
High	1.804	288.58	31.60		PASS

DH 5

CH Low: $3.056 * (1600/6)/79 * 31.60 = 325.99$ (ms)

CH Mid: $3.056 * (1600/6)/79 * 31.60 = 325.99$ (ms)

CH High: $3.062 * (1600/6)/79 * 31.60 = 326.63$ (ms)

CH	Pulse Time (ms)	Total of Dwell (ms)	Period Time (s)	Limit (ms)	Result
Low	3.056	325.99	31.60	400.00	PASS
Mid	3.056	325.99	31.60		PASS
High	3.062	326.63	31.60		PASS



Test Plot

DH 1

(CH Low)

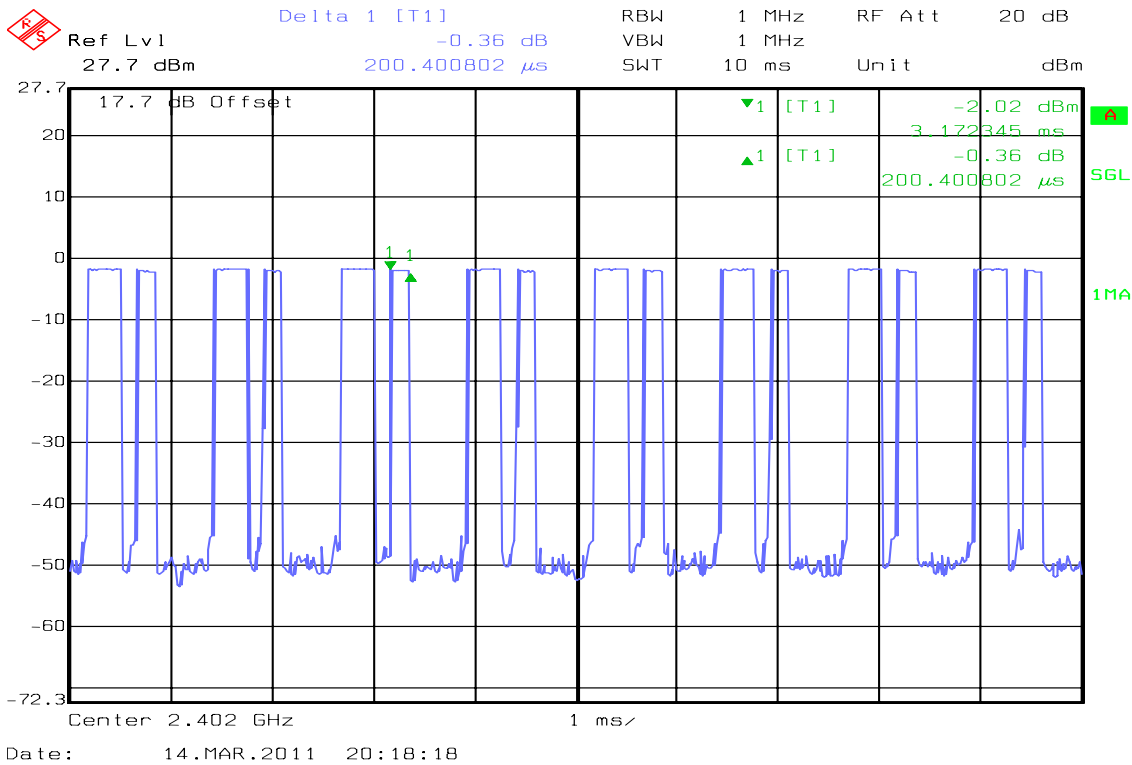
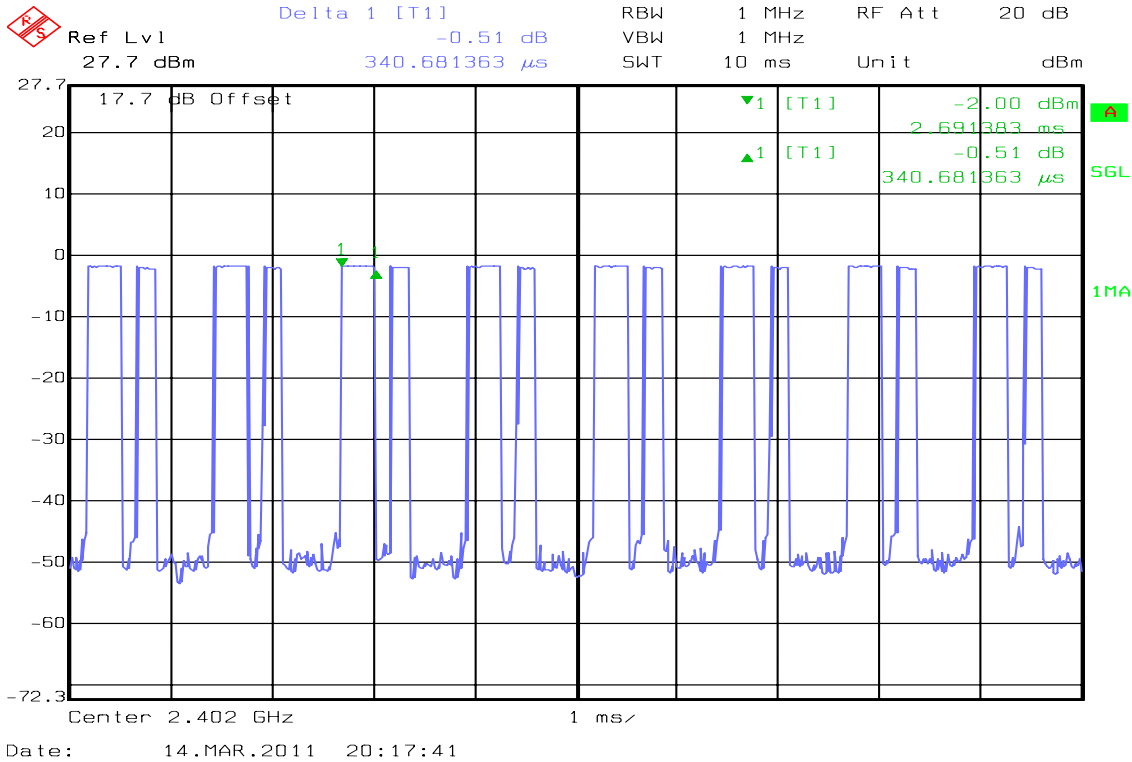



(CH Mid)

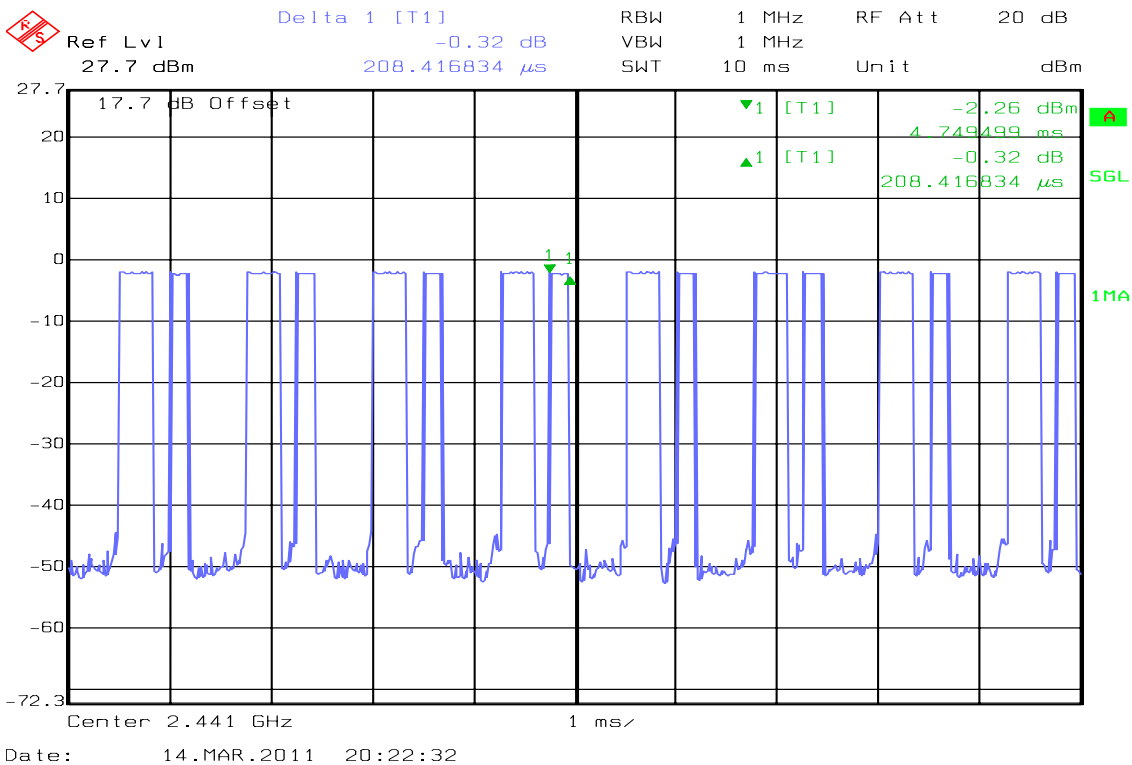
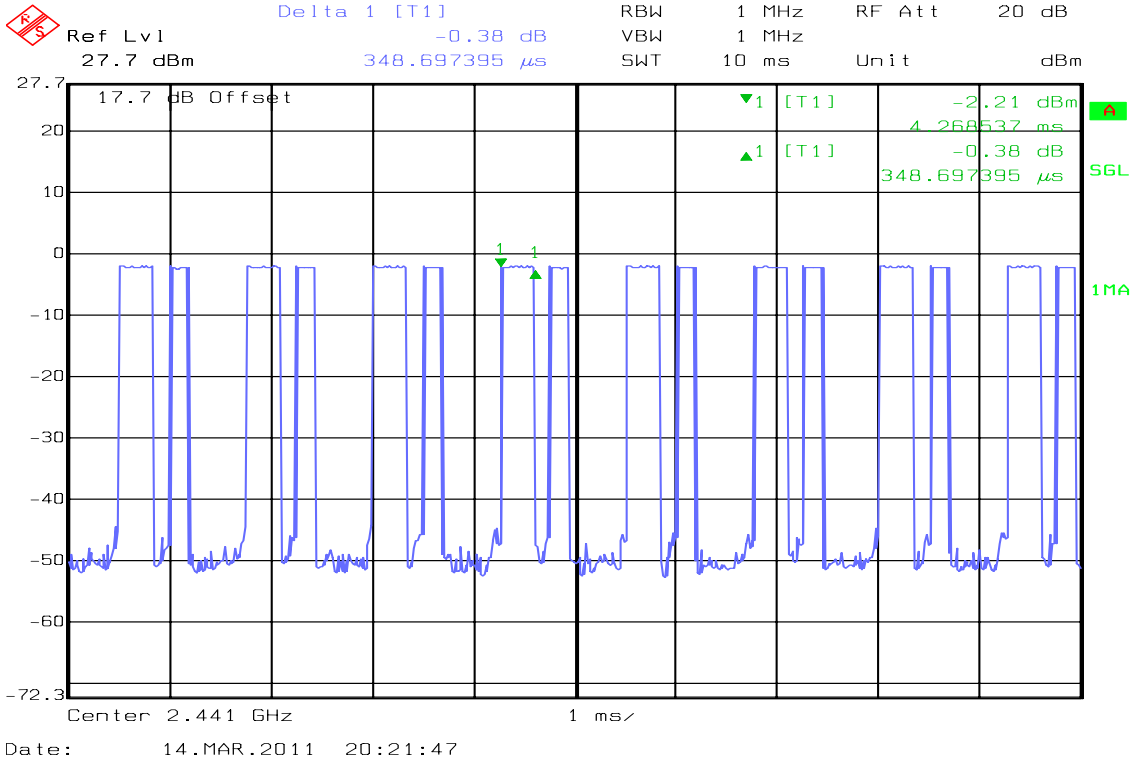



(CH High)

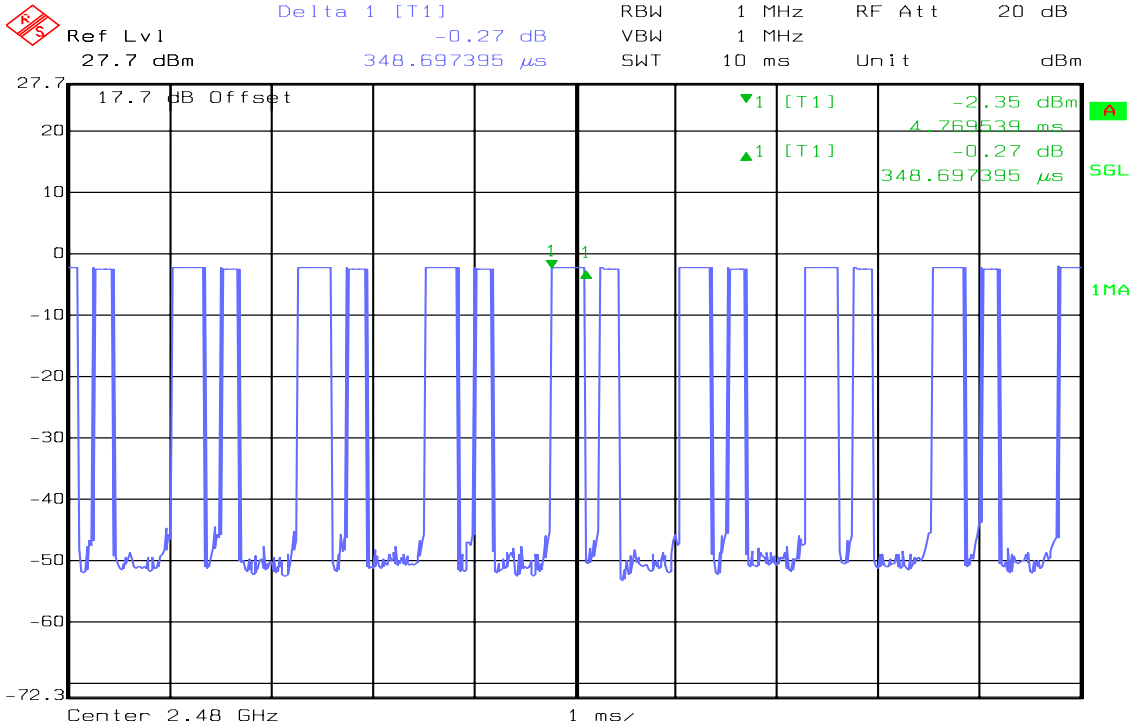

Date: 14.MAR.2011 20:27:55

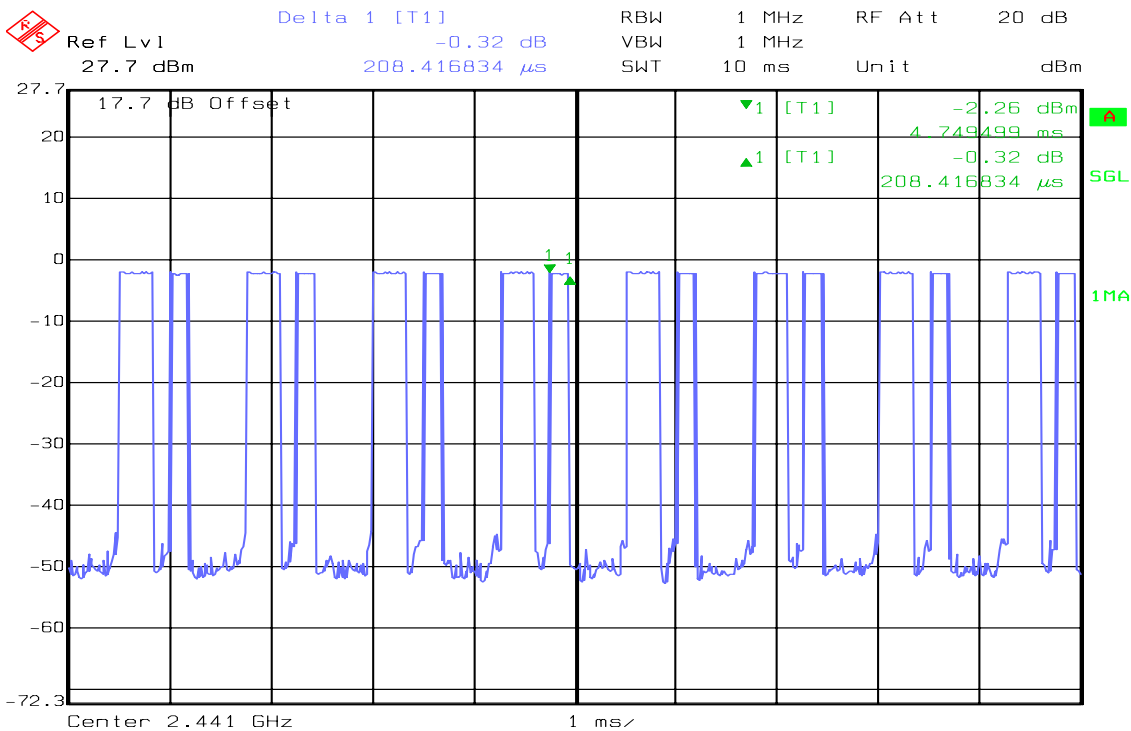

Date: 14.MAR.2011 20:22:32



DH 3

(CH Low)

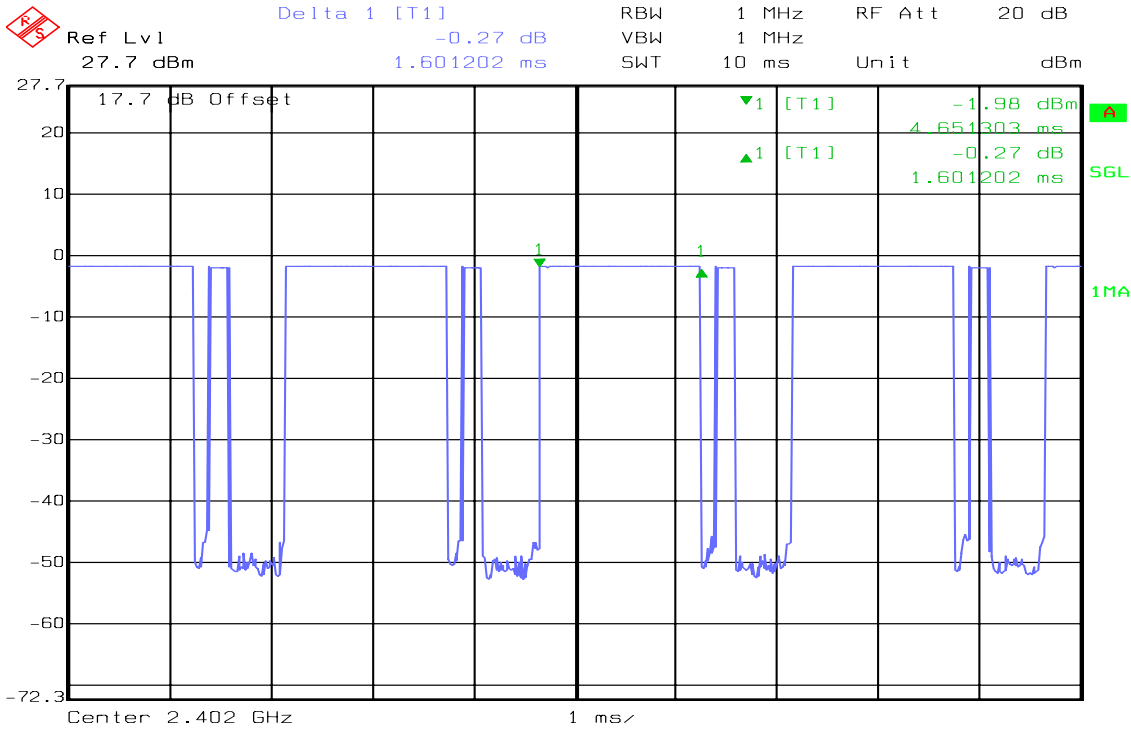

Date: 14.MAR.2011 20:19:25

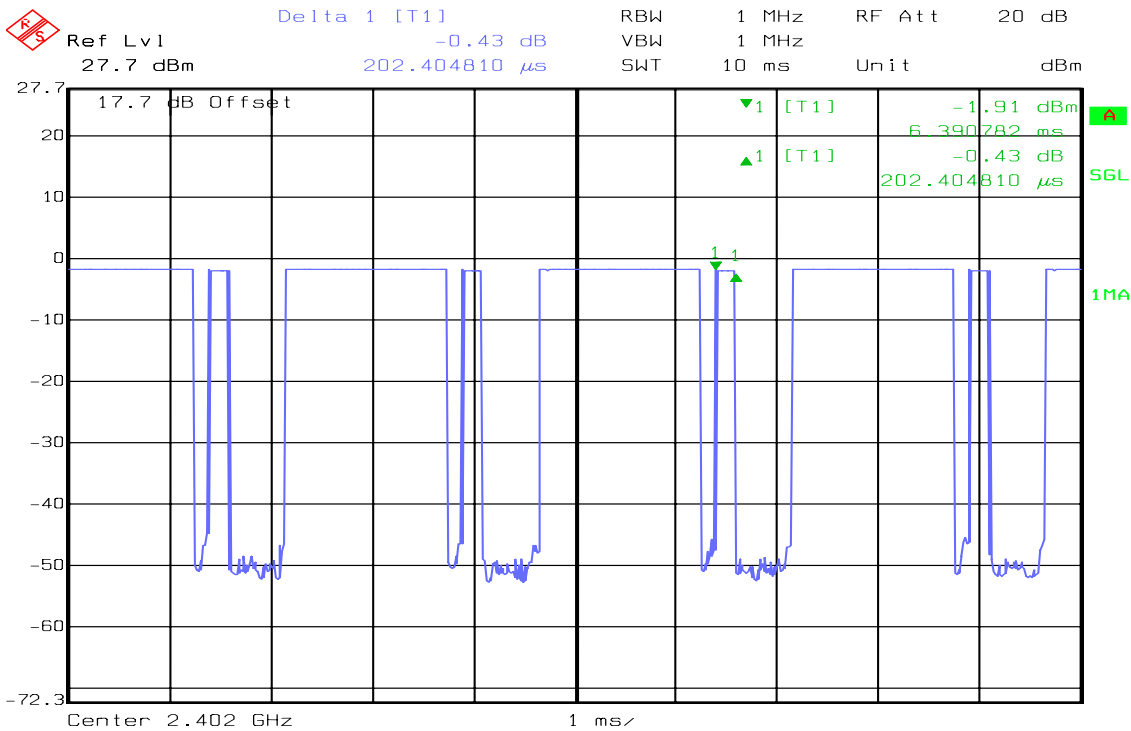

Date: 14.MAR.2011 20:19:49



(CH Mid)

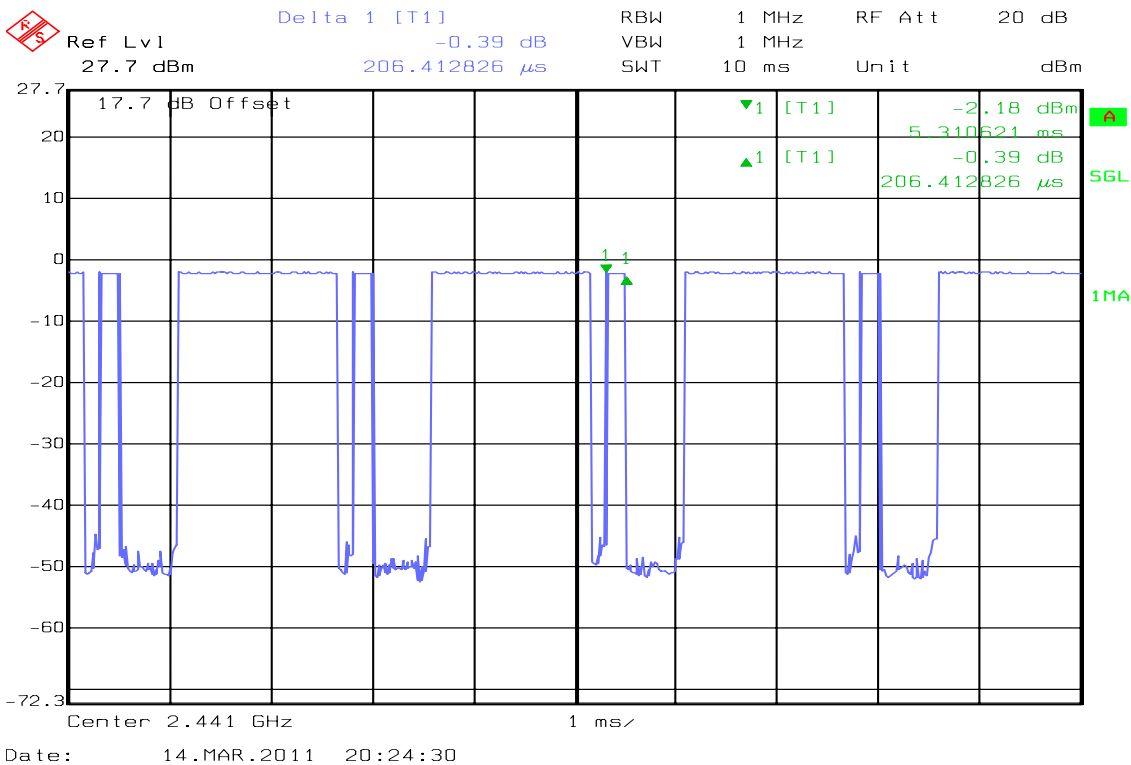
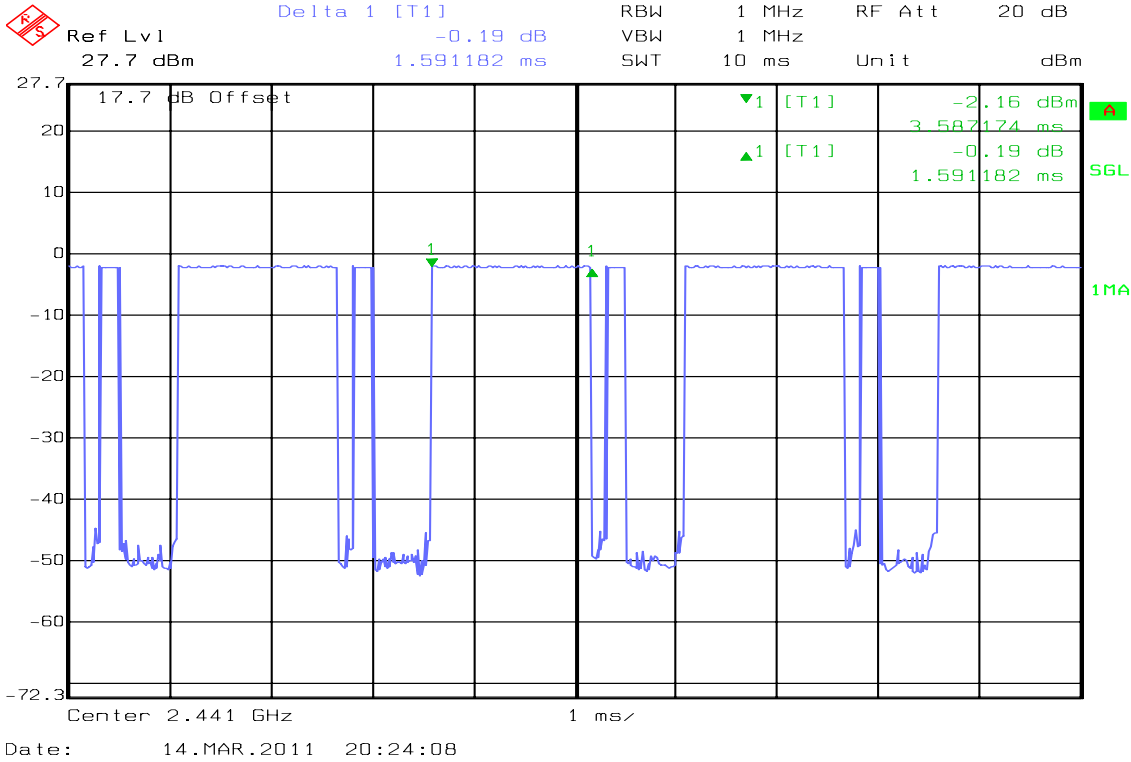



(CH High)

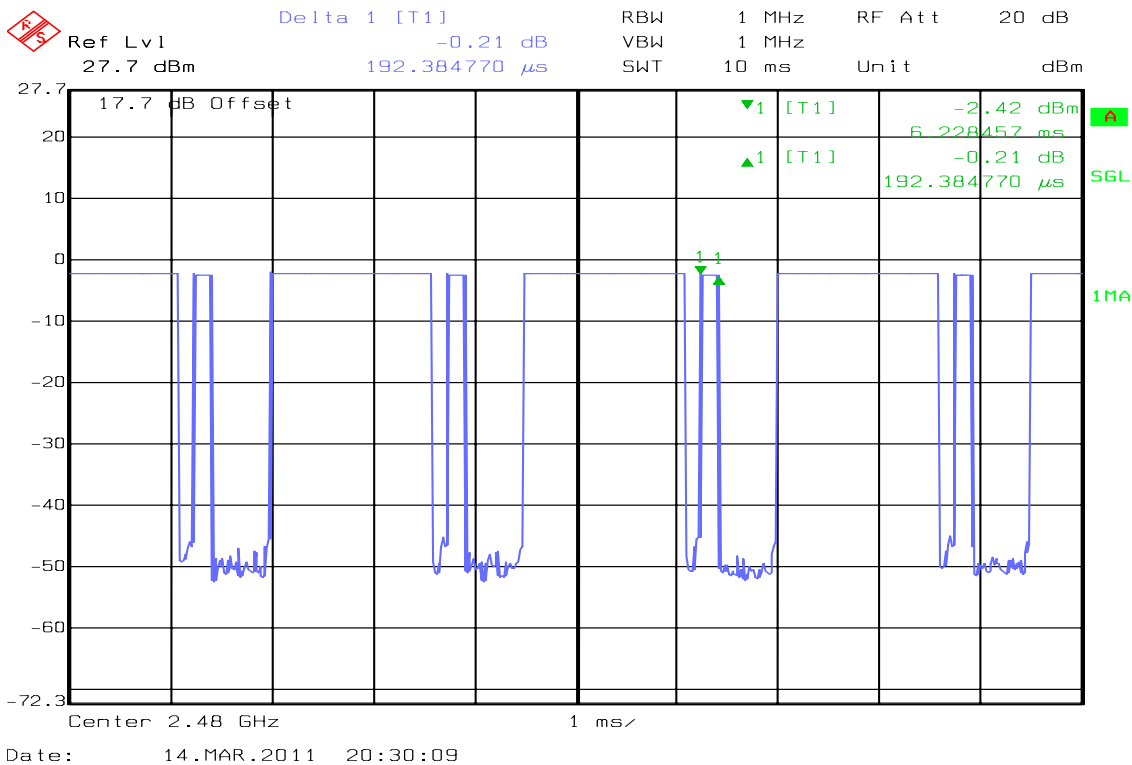
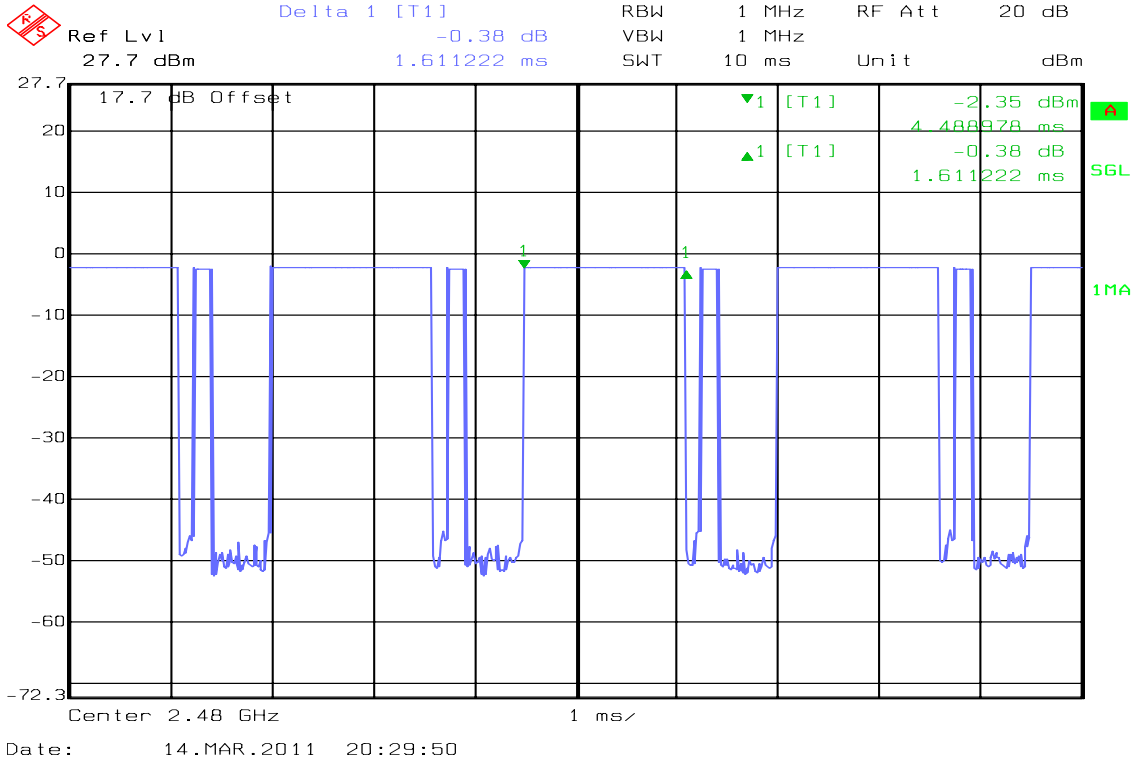



DH 5

(CH Low)

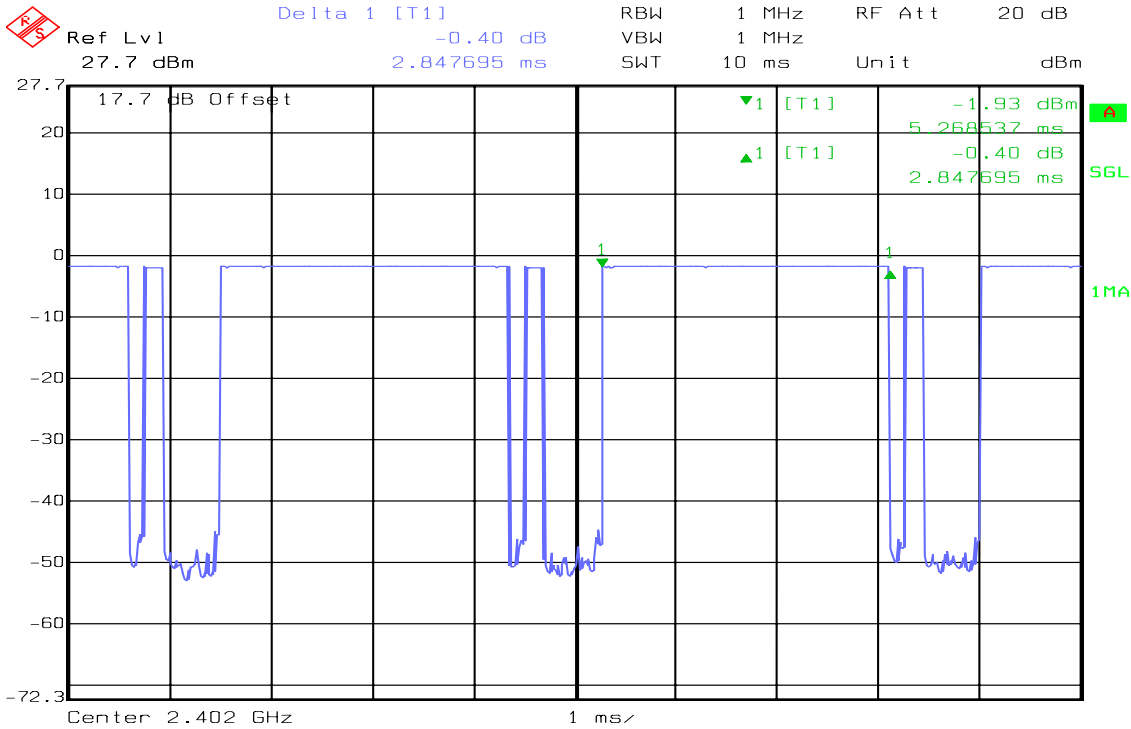

Date: 14.MAR.2011 20:20:41

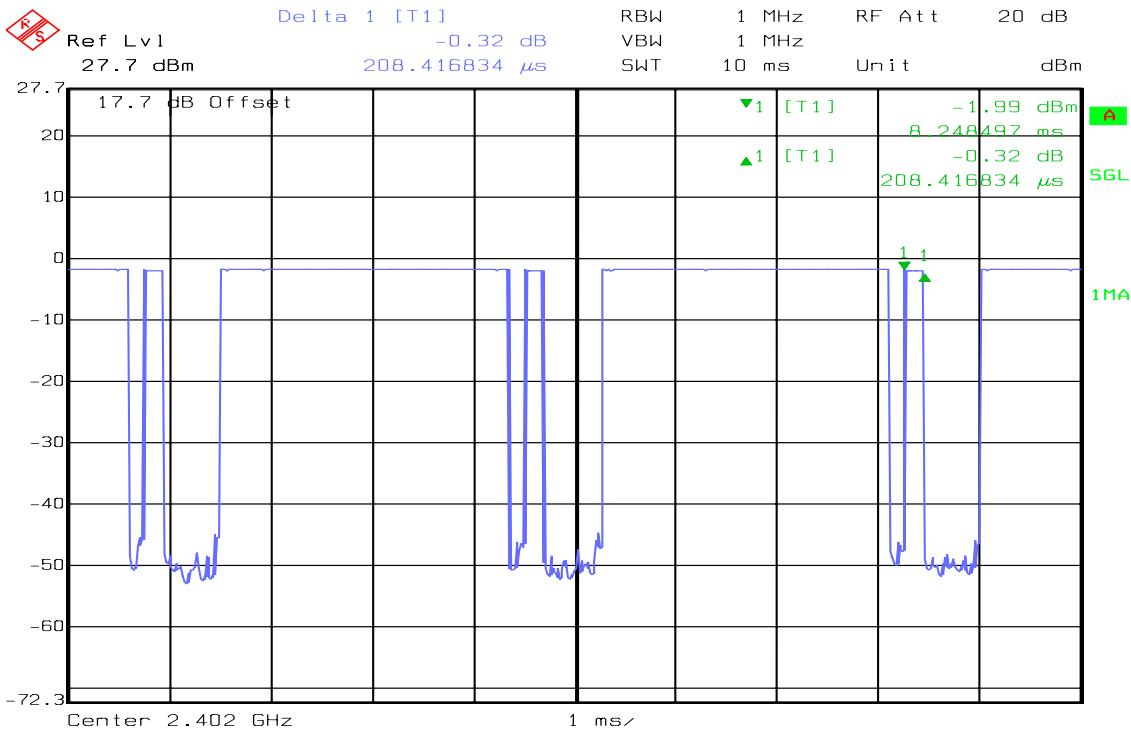

Date: 14.MAR.2011 20:21:01



(CH Mid)

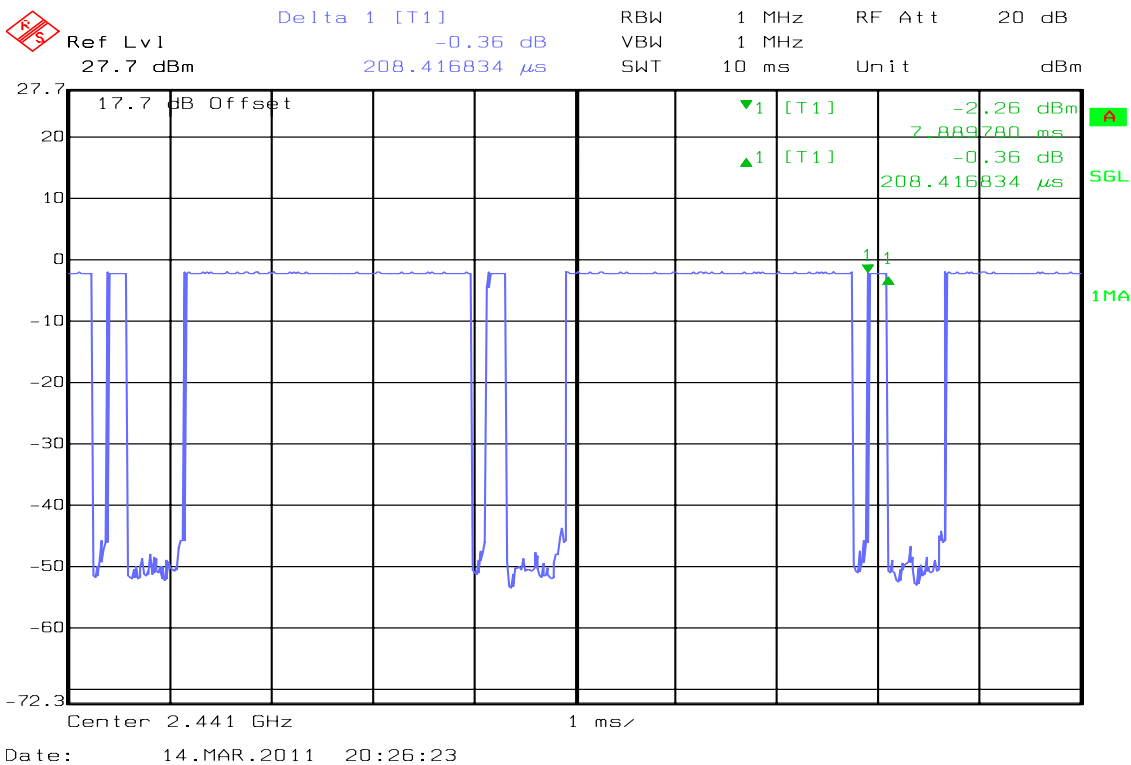
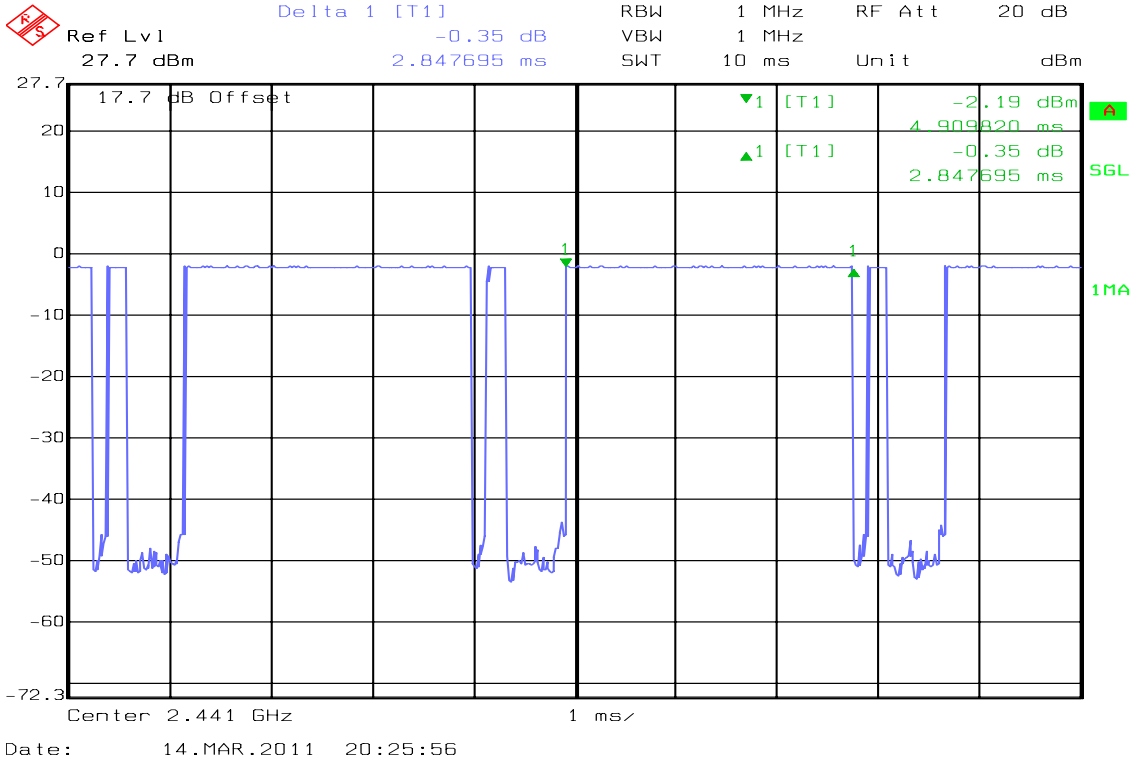



(CH High)

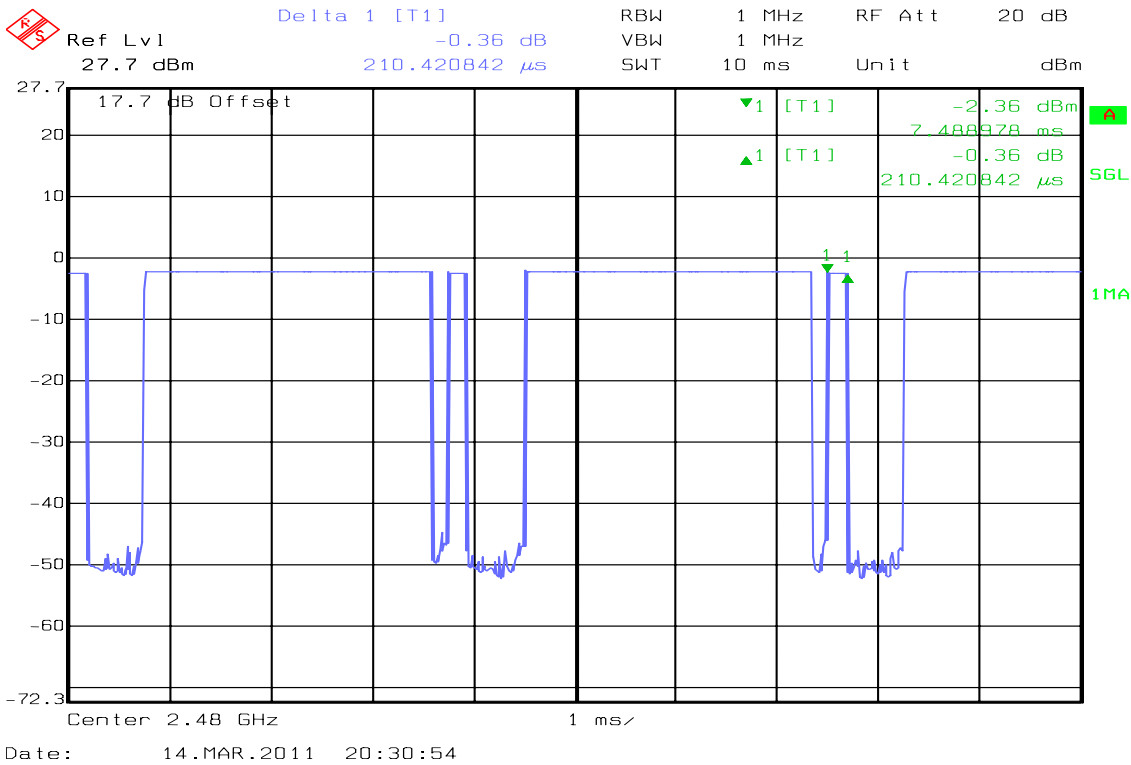
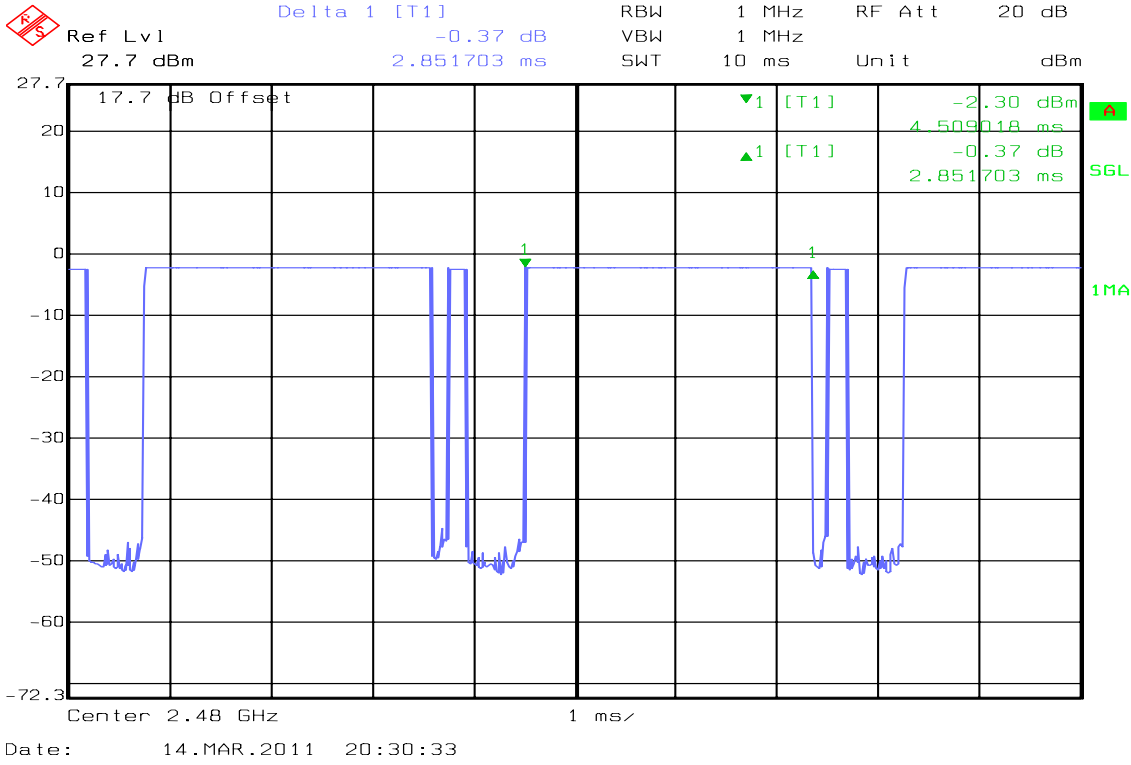



7.8. SPURIOUS EMISSIONS

7.8.1 Conducted Measurement

LIMIT

In any 100 kHz bandwidth outside the frequency band in which the spread spectrum or digitally modulated intentional radiator is operating, the radio frequency power that is produced by the intentional radiator shall be at least 20 dB below that in the 100 kHz bandwidth within the band that contains the highest level of the desired power, based on either an RF conducted or a radiated measurement. Attenuation below the general limits specified in Section 15.209(a) is not required. In addition, radiated emissions which fall in the restricted bands, as defined in Section 15.205(a), must also comply with the radiated emission limits specified in Section 15.209(a) (see Section 15.205(c)).

TEST CONFIGURATION

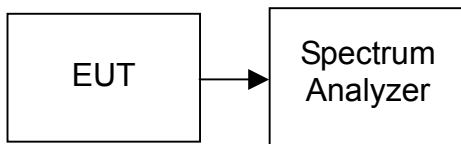

TEST PROCEDURE

Conducted RF measurements of the transmitter output were made to confirm that the EUT antenna port conducted emissions meet the specified limit and to identify any spurious signals that require further investigation or measurements on the radiated emissions site.

The transmitter output is connected to the spectrum analyzer. The resolution bandwidth is set to 100 kHz. The video bandwidth is set to 100 kHz.

Measurements are made over the 30MHz to 26GHz range with the transmitter set to the lowest, middle, and highest channels.

TEST RESULTS

No non-compliance noted

TEST DATA

Refer to attach spectrum analyzer data chart.



Test Plot

CH Low

* Agilent 21:14:57 Mar 14, 2011

R T

Mkr1 2.41 GHz
-1.63 dBm

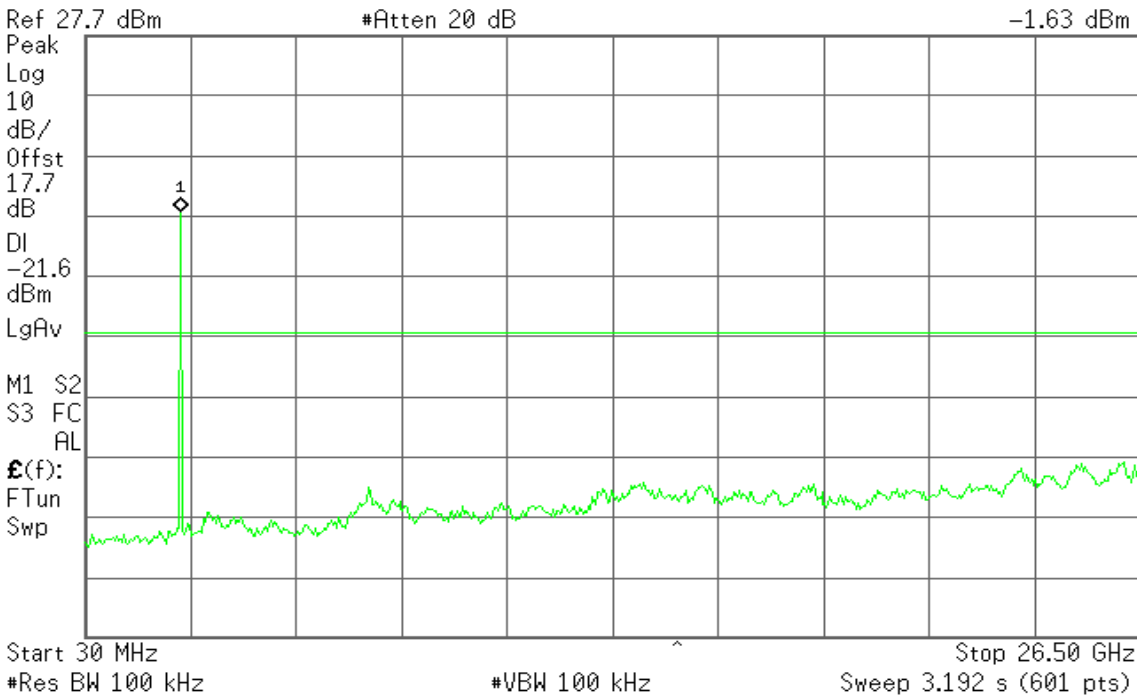

CH Mid

* Agilent 21:16:14 Mar 14, 2011

R T

Mkr1 2.46 GHz
-1.40 dBm

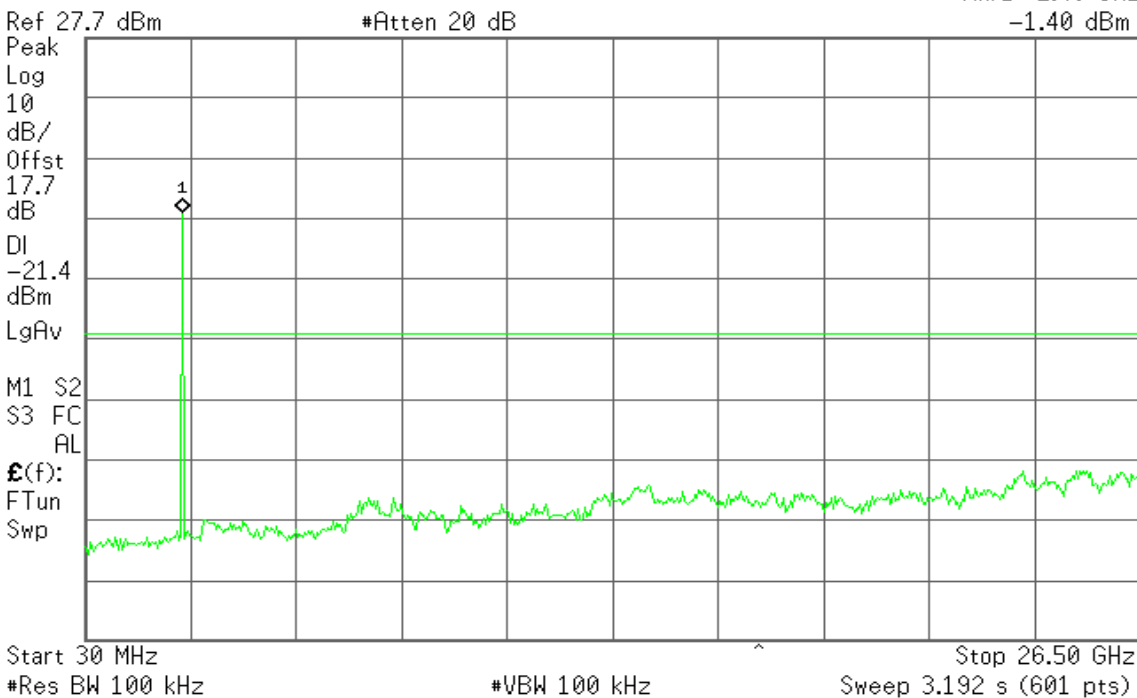



CH High

* Agilent 21:29:48 Mar 14, 2011

R T

Mkr1 2.50 GHz
-2.64 dBm

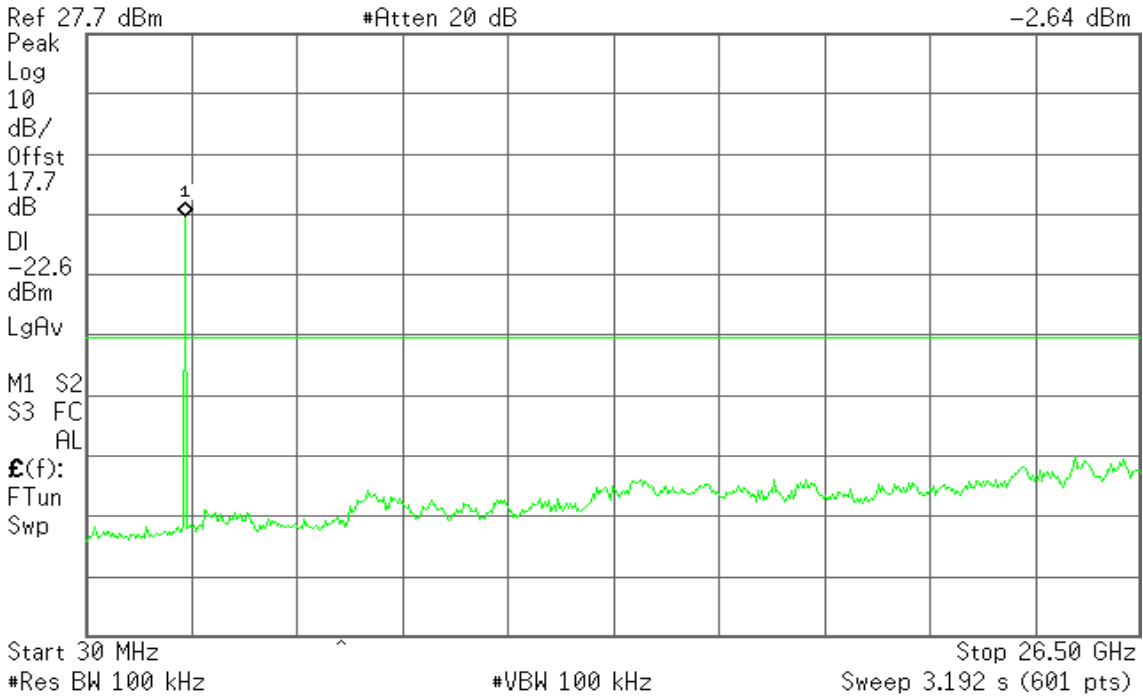



7.8.2 RADIATED EMISSIONS

LIMIT

1. According to §15.209(a), except as provided elsewhere in this Subpart, the emissions from an intentional radiator shall not exceed the field strength levels specified in the following table:

Frequency (MHz)	Field Strength ($\mu\text{V}/\text{m}$)	Measurement Distance (m)
30-88	100*	3
88-216	150*	3
216-960	200*	3
Above 960	500	3

Remark: Except as provided in paragraph (g), fundamental emissions from intentional radiators operating under this Section shall not be located in the frequency bands 54-72 MHz, 76-88 MHz, 174-216 MHz or 470-806 MHz. However, operation within these frequency bands is permitted under other sections of this Part, e.g., Sections 15.231 and 15.241.

2. In the emission table above, the tighter limit applies at the band edges.

Frequency (Hz)	Field Strength ($\mu\text{V}/\text{m}$ at 3-meter)	Field Strength ($\text{dB}\mu\text{V}/\text{m}$ at 3-meter)
30-88	100	40
88-216	150	43.5
216-960	200	46
Above 960	500	54



TEST CONFIGURATION

9kHz ~ 30MHz

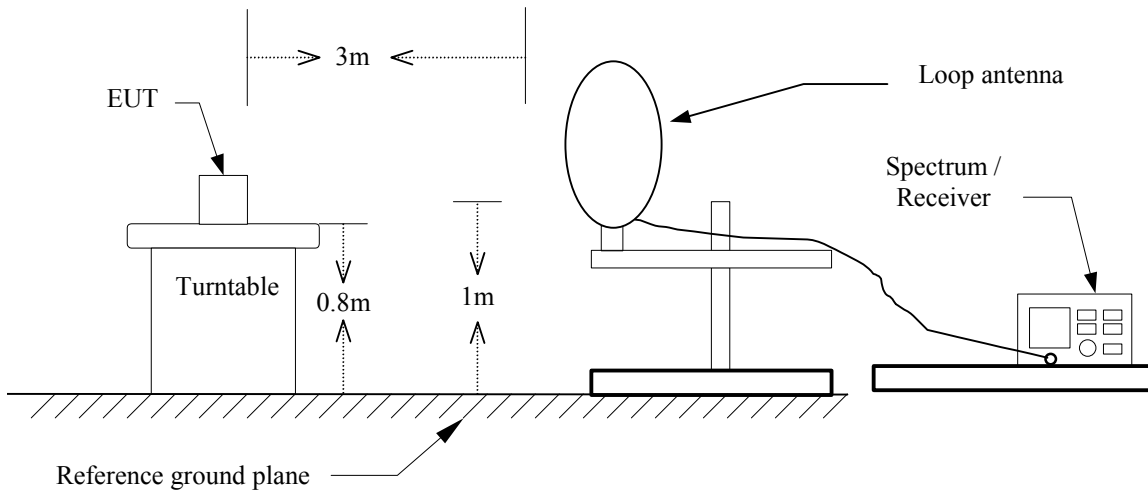

30MHz ~ 1 GHz

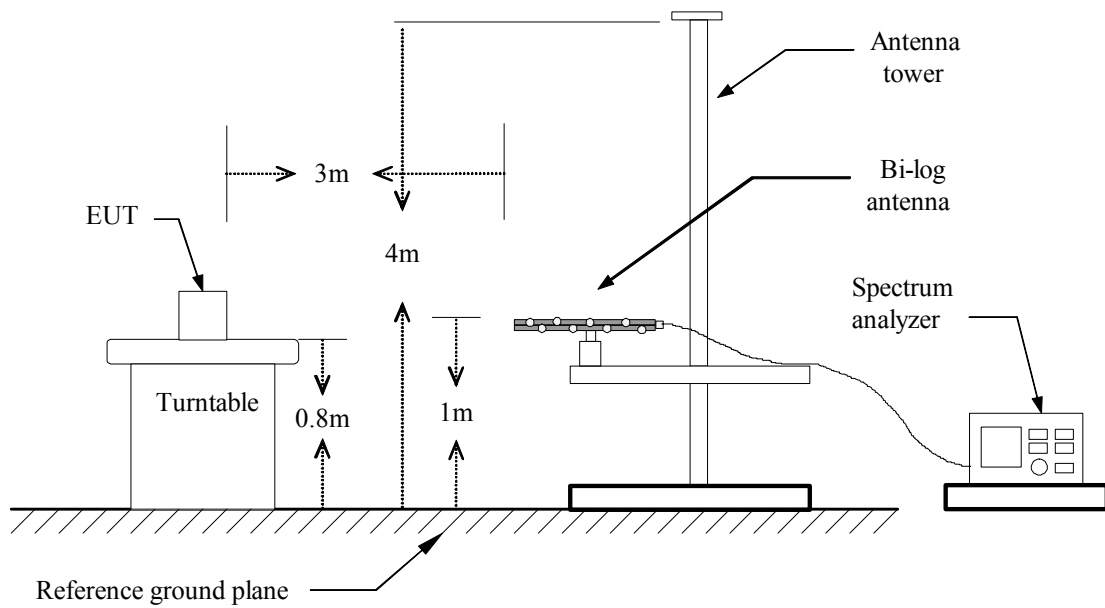



Above 1 GHz

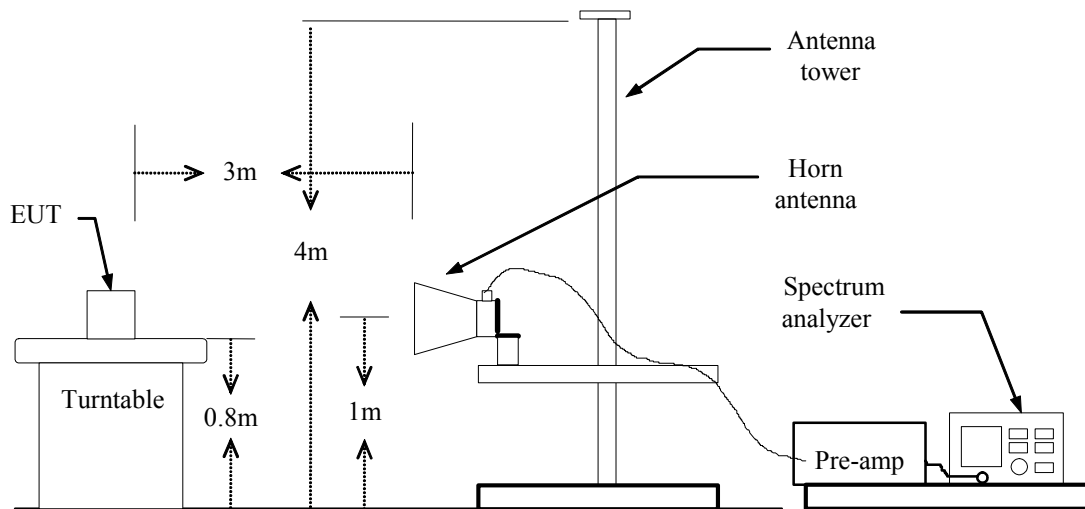

TEST PROCEDURE

1. The EUT is placed on a turntable, which is 0.8m above ground plane.
2. The turntable shall be rotated for 360 degrees to determine the position of maximum emission level.
3. EUT is set 3m away from the receiving antenna, which is varied from 1m to 4m to find out the highest emissions.
4. Maximum procedure was performed on the six highest emissions to ensure EUT compliance.
5. And also, each emission was to be maximized by changing the polarization of receiving antenna both horizontal and vertical.
6. Set the spectrum analyzer in the following setting as:
 - For Below 30MHz**
RBW=9kHz / VBW=300kHz / Sweep=AUTO
 - For 30 ~ 1000MHz:**
RBW=120kHz / VBW=300kHz / Sweep=AUTO
 - Above 1GHz:**
 - (a) PEAK: RBW=VBW=1MHz / Sweep=AUTO
 - (b) AVERAGE: RBW=1MHz / VBW=10Hz / Sweep=AUTO
7. Repeat above procedures until the measurements for all frequencies are complete.

TEST RESULTS

No non-compliance noted



TEST DATA

Below 1 GHz

Operation Mode: TX

Test Date: March 15, 2011

Temperature: 18°C

Tested by: Juicheng Su

Humidity: 60 % RH

Polarity: Ver. / Hor.

Freq. (MHz)	Ant.Pol. H/V	Detector Mode (PK/QP)	Reading (dBuV)	Factor (dB)	Actual FS (dBuV/m)	Limit 3m (dBuV/m)	Safe Margin (dB)
65.5667	V	QP	47.58	-17.09	30.49	40.00	-9.51
131.8500	V	QP	45.60	-13.96	31.64	43.50	-11.86
199.7500	V	QP	53.94	-15.40	38.54	43.50	-4.96
259.5667	V	QP	44.12	-12.29	31.83	46.00	-14.17
400.2167	V	QP	42.01	-9.46	32.55	46.00	-13.45
451.9500	V	QP	43.79	-8.25	35.54	46.00	-10.46
532.7833	V	QP	40.28	-6.50	33.78	46.00	-12.22
928.8667	V	QP	36.01	0.98	36.99	46.00	-9.01
65.5667	H	QP	41.43	-17.09	24.34	40.00	-15.66
133.4667	H	QP	40.09	-13.62	26.47	43.50	-17.03
199.7500	H	QP	50.80	-15.40	35.40	43.50	-8.10
257.9500	H	QP	45.87	-12.32	33.55	46.00	-12.45
398.6000	H	QP	45.69	-9.48	36.21	46.00	-9.79
453.5667	H	QP	38.11	-8.21	29.90	46.00	-16.10
932.1000	H	QP	34.58	1.07	35.65	46.00	-10.35

Remark:

1. No emission found between lowest internal used / generated frequency to 30 MHz. (9kHz ~ 30MHz)
2. Measuring frequencies from 30 MHz to the 1GHz.
3. Radiated emissions measured in frequency range from 30 MHz to 1000MHz were made with an instrument using Peak detector mode.
4. Data of measurement within this frequency range shown " --- " in the table above means the reading of emissions are attenuated more than 20dB below the permissible limits or the field strength is too small to be measured.
5. The IF bandwidth of SPA between 30MHz to 1GHz was 100kHz.



Above 1 GHz

Operation Mode: TX / CH Low**Test Date:** March 15, 2011**Temperature:** 18°C**Tested by:** Chieh Cheng**Humidity:** 54% RH**Polarity:** Ver. / Hor.

Freq. (MHz)	Ant. Pol H/V	Peak Reading (dBuV)	AV Reading (dBuV)	Ant. / CL CF (dB)	Actual Fs		Peak Limit (dBuV/m)	AV Limit (dBuV/m)	Margin (dB)	Remark
					Peak (dBuV/m)	AV (dBuV/m)				
1770.00	V	49.82	---	-1.47	48.35	---	74.00	54.00	-5.65	Peak
2480.00	V	49.52	---	2.20	51.72	---	74.00	54.00	-2.28	Peak
4808.33	V	44.47	---	6.25	50.72	---	74.00	54.00	-3.28	Peak
N/A										
1716.67	H	50.64	---	-3.80	46.84	---	74.00	54.00	-7.16	Peak
2620.00	H	49.03	---	0.08	49.11	---	74.00	54.00	-4.89	Peak
4808.33	H	49.17	45.92	7.73	56.91	53.65	74.00	54.00	-0.35	AVG
N/A										

Remark:

1. Measuring frequencies from 1 GHz to the 10th harmonic of highest fundamental frequency.
2. Radiated emissions measured in frequency above 1000MHz were made with an instrument using peak/average detector mode.
3. Average test would be performed if the peak result were greater than the average limit or as required by the applicant.
4. Data of measurement within this frequency range shown " --- " in the table above means the reading of emissions are attenuated more than 20dB below the permissible limits or the field strength is too small to be measured.
5. Measurements above show only up to 6 maximum emissions noted, or would be lesser, with " N/A " remark, if no specific emissions from the EUT are recorded (ie: margin > 20dB from the applicable limit) and considered that's already beyond the background noise floor.
6. Margin (dB) = Remark result (dBuV/m) – Average limit (dBuV/m).



Compliance Certification Services Inc.

Report No: T110303201-RP1

FCC ID: PRDMU02

Date of Issue: March 22, 2011

Operation Mode: TX / CH Mid

Test Date: March 15, 2011

Temperature: 18°C

Tested by: Chieh Cheng

Humidity: 54% RH

Polarity: Ver. / Hor.

Freq. (MHz)	Ant. Pol H/V	Peak Reading (dBuV)	AV Reading (dBuV)	Ant. / CL CF (dB)	Actual Fs		Peak Limit (dBuV/m)	AV Limit (dBuV/m)	Margin (dB)	Remark
					Peak (dBuV/m)	AV (dBuV/m)				
1886.67	V	50.02	---	-0.92	49.10	---	74.00	54.00	-4.90	Peak
2636.67	V	50.05	---	1.29	51.35	---	74.00	54.00	-2.65	Peak
4883.33	V	45.08	---	7.44	52.52	---	74.00	54.00	-1.48	Peak
N/A										
2276.67	H	49.92	---	-1.53	48.40	---	74.00	54.00	-5.60	Peak
2553.33	H	49.50	---	-0.58	48.91	---	74.00	54.00	-5.09	Peak
4883.33	H	47.17	44.83	7.75	54.92	52.58	74.00	54.00	-1.42	AVG
N/A										

Remark:

1. Measuring frequencies from 1 GHz to the 10th harmonic of highest fundamental frequency.
2. Radiated emissions measured in frequency above 1000MHz were made with an instrument using peak/average detector mode.
3. Average test would be performed if the peak result were greater than the average limit or as required by the applicant.
4. Data of measurement within this frequency range shown " --- " in the table above means the reading of emissions are attenuated more than 20dB below the permissible limits or the field strength is too small to be measured.
5. Measurements above show only up to 6 maximum emissions noted, or would be lesser, with " N/A " remark, if no specific emissions from the EUT are recorded (ie: margin>20dB from the applicable limit) and considered that's already beyond the background noise floor.
6. Margin (dB) = Remark result (dBuV/m) – Average limit (dBuV/m).



Compliance Certification Services Inc.

Report No: T110303201-RP1

FCC ID: PRDMU02

Date of Issue: March 22, 2011

Operation Mode: TX / CH High

Test Date: March 15, 2011

Temperature: 18°C

Tested by: Chieh Cheng

Humidity: 54% RH

Polarity: Ver. / Hor.

Freq. (MHz)	Ant. Pol H/V	Peak Reading (dBuV)	AV Reading (dBuV)	Ant. / CL CF (dB)	Actual Fs		Peak Limit (dBuV/m)	AV Limit (dBuV/m)	Margin (dB)	Remark
					Peak (dBuV/m)	AV (dBuV/m)				
1716.67	V	50.05	---	-2.35	47.71	---	74.00	54.00	-6.29	Peak
2680.00	V	48.71	---	1.44	50.15	---	74.00	54.00	-3.85	Peak
4958.33	V	43.56	---	6.96	50.52	---	74.00	54.00	-3.48	Peak
N/A										
2316.67	H	49.39	---	-1.36	48.03	---	74.00	54.00	-5.97	Peak
2890.00	H	48.26	---	0.98	49.25	---	74.00	54.00	-4.75	Peak
4958.33	H	47.08	44.72	8.75	55.84	53.47	74.00	54.00	-0.53	AVG
N/A										

Remark:

1. Measuring frequencies from 1 GHz to the 10th harmonic of highest fundamental frequency.
2. Radiated emissions measured in frequency above 1000MHz were made with an instrument using peak/average detector mode.
3. Average test would be performed if the peak result were greater than the average limit or as required by the applicant.
4. Data of measurement within this frequency range shown " --- " in the table above means the reading of emissions are attenuated more than 20dB below the permissible limits or the field strength is too small to be measured.
5. Measurements above show only up to 6 maximum emissions noted, or would be lesser, with " N/A " remark, if no specific emissions from the EUT are recorded (ie: margin>20dB from the applicable limit) and considered that's already beyond the background noise floor.
6. Margin (dB) = Remark result (dBuV/m) – Average limit (dBuV/m).



7.9. POWERLINE CONDUCTED EMISSIONS

LIMIT

For an intentional radiator which is designed to be connected to the public utility (AC) power line, the radio frequency voltage that is conducted back onto the AC power line on any frequency or frequencies within the band 150 kHz to 30 MHz shall not exceed 250 microvolts (The limit decreases linearly with the logarithm of the frequency in the range 0.15 MHz to 0.50 MHz). The limits at specific frequency range is listed as follows:

Frequency Range (MHz)	Limits (dB μ V)	
	Quasi-peak	Average
0.15 to 0.50	66 to 56	56 to 46
0.50 to 5	56	46
5 to 30	60	50

Compliance with this provision shall be based on the measurement of the radio frequency voltage between each power line (LINE and NEUTRAL) and ground at the power terminals.

TEST CONFIGURATION

See test photographs attached in Appendix 1 for the actual connections between EUT and support equipment.

TEST PROCEDURE

1. The EUT was placed on a table, which is 0.8m above ground plane.
2. Maximum procedure was performed on the six highest emissions to ensure EUT compliance.
3. Repeat above procedures until all frequency measured were complete.

TEST RESULTS

The initial step in collecting conducted data is a spectrum analyzer peak scan of the measurement range. Significant peaks are then marked as shown on the following data page, and these signals are then quasi-peaked.

TEST DATA

Not applicable (Since the EUT is powered by battery)



8 RADIO FREQUENCY EXPOSURE

LIMIT

According to §15.247(i), systems operating under the provisions of this section shall be operated in a manner that ensures that the public is not exposed to radio frequency energy levels in excess of the Commission's guidelines. See § 1.1307(b)(1) of this chapter.

EUT SPECIFICATION

EUT	Bluetooth Optical Mouse
Frequency band (Operating)	<input type="checkbox"/> WLAN: 2.412GHz ~ 2.462GHz <input type="checkbox"/> WLAN: 5.18GHz ~ 5.32GHz / 5.50GHz ~ 5.70GHz <input type="checkbox"/> WLAN: 5.745GHz ~ 5.825GHz <input checked="" type="checkbox"/> Others Bluetooth: 2.402GHz ~ 2.480GHz
Device category	<input checked="" type="checkbox"/> Portable (<20cm separation) <input type="checkbox"/> Mobile (>20cm separation) <input type="checkbox"/> Others _____
Exposure classification	<input type="checkbox"/> Occupational/Controlled exposure ($S = 5mW/cm^2$) <input checked="" type="checkbox"/> General Population/Uncontrolled exposure ($S=1mW/cm^2$)
Antenna diversity	<input checked="" type="checkbox"/> Single antenna <input type="checkbox"/> Multiple antennas <input type="checkbox"/> Tx diversity <input type="checkbox"/> Rx diversity <input type="checkbox"/> Tx/Rx diversity
Max. output power	0.20 dBm (0.001047W)
Antenna gain (Max)	-1.55 dBi (Numeric gain: 0.6998)
Evaluation applied	<input type="checkbox"/> MPE Evaluation <input type="checkbox"/> SAR Evaluation <input checked="" type="checkbox"/> N/A
Remark:	
1. <u>The maximum output power is 0.20dBm (0.001047W) at 2402MHz (with 0.6998 numeric antenna gain.)</u>	

TEST RESULTS

No non-compliance noted.

(SAR evaluation is not required for the PORTABLE device while its maximum output power is lower than the general population low threshold: $60/f_{(GHz)}=60/2.441=24.58mW$ even if the calculation indicates that the power density would be larger.)