



FCC 47 CFR PART 15 Subpart C

TEST REPORT

For

Wireless Mouse

Model: G33

Trade Name: ACROX

Issued to

Acrox Technologies Co., Ltd.

4F., No.89, Minshan St., Neihu Dist., Taipei City 114, Taiwan, R.O.C.

Issued by

Compliance Certification Services Inc.

No.81-1, Lane 210, Bade 2nd Rd., Lujhu Township,

Taoyuan County 33841, Taiwan, R.O.C.

TEL: 886-3-324-0332

FAX: 886-3-324-5235

<http://www.ccsrf.com>

service@ccsrf.com



Note: *This report shall not be reproduced except in full, without the written approval of Compliance Certification Services Inc. This document may be altered or revised by Compliance Certification Services Inc. personnel only, and shall be noted in the revision section of the document. The client should not use it to claim product endorsement by TAF, A2LA, NIST or any government agencies. The test results in the report only apply to the tested sample.*



Revision History

Rev.	Issue Date	Revisions	Effect Page	Revised By
00	March 28, 2011	Initial Issue	All	Angel Hu



TABLE OF CONTENTS

1. TEST RESULT CERTIFICATION.....	4
2. EUT DESCRIPTION	5
3. TEST METHODOLOGY.....	6
3.1 EUT CONFIGURATION.....	6
3.2 EUT EXERCISE.....	6
3.3 GENERAL TEST PROCEDURES.....	6
3.4 FCC PART 15.205 RESTRICTED BANDS OF OPERATIONS	7
3.5 DESCRIPTION OF TEST MODES	7
4. INSTRUMENT CALIBRATION	8
4.1 MEASURING INSTRUMENT CALIBRATION	8
4.2 MEASUREMENT EQUIPMENT USED	8
4.3 MEASUREMENT UNCERTAINTY	8
5. FACILITIES AND ACCREDITATIONS	9
5.1 FACILITIES.....	9
5.2 EQUIPMENT	9
5.3 TABLE OF ACCREDITATIONS AND LISTINGS.....	10
6. SETUP OF EQUIPMENT UNDER TEST.....	11
6.1 SETUP CONFIGURATION OF EUT	11
6.2 SUPPORT EQUIPMENT	11
7. FCC PART 15.249 REQUIREMENTS.....	12
7.1 20dB BANDWIDTH.....	12
7.2 BAND EDGES MEASUREMENT	15
7.3 SPURIOUS EMISSION.....	20
7.4 POWERLINE CONDUCTED EMISSIONS	27
8. APPENDIX 1 PHOTOGRAPHS OF TEST SETUP.....	29
APPENDIX 1: PHOTOGRAPHS OF EUT.....	31



1. TEST RESULT CERTIFICATION

Applicant: Acrox Technologies Co., Ltd.
4F., No.89, Minshan St., Neihu Dist., Taipei City 114,
Taiwan, R.O.C.

Equipment Under Test: Wireless Mouse

Trade Name: ACROX

Model: G33

Date of Test: March 18 ~ 21, 2011

APPLICABLE STANDARDS	
STANDARD	TEST RESULT
FCC 47 CFR Part 15 Subpart C	No non-compliance noted

We hereby certify that:

The above equipment was tested by Compliance Certification Services Inc. The test data, data evaluation, test procedures, and equipment configurations shown in this report were made in accordance with the procedures given in ANSI C63.4: 2009 and the energy emitted by the sample EUT tested as described in this report is in compliance with the requirements emission limits of FCC Rules Part 15.207, 15.209 and 15.249. The test results of this report relate only to the tested sample identified in this report.

Approved by:

Stan Lin
Supervisor

Reviewed by:

Chieh Cheng
Engineer



2. EUT DESCRIPTION

Product	Wireless Mouse
Model	G33
Brand	ACROX
Model Discrepancy	N/A
EUT Power Rating	3VDC from Battery
Operating Frequency Range	2403 ~ 2480MHz
Output Power	93.53dBuV/m
Modulation Technique	GFSK
Number of Channels	78 Channels
Antenna Gain	-1.45dBi
Antenna Designation	PCB Antenna

Remark:

1. The sample selected for test was production product and was provided by manufacturer.
2. This test report is intended for FCC ID: **PRDMU01** to comply with Section 15.207, 15.209, 15.249 (FCC Part 15, Subpart C Rules.)
3. The Nano dongle (in external photographs) is a receiver only.



3. TEST METHODOLOGY

The tests documented in this report were performed in accordance with ANSI C63.4 (2009) and FCC CFR 47 Part 2, Part 15.207, 15.209 and 15.249.

3.1 EUT CONFIGURATION

The EUT configuration for testing is installed on RF field strength measurement to meet the Commissions requirement and operating in a manner that intends to maximize its emission characteristics in a continuous normal application.

3.2 EUT EXERCISE

The EUT was operated in the engineering mode to fix the TX frequency that was for the purpose of the measurements.

According to its specifications, the EUT must comply with the requirements of the Section 15.207, 15.209, 15.249 under the FCC Rules Part 15 Subpart C.

3.3 GENERAL TEST PROCEDURES

Conducted Emissions

The EUT is placed on the turntable, which is 0.8 m above ground plane. According to the requirements in Section 13.1.4.1 of ANSI C63.4 (2009) Conducted emissions from the EUT measured in the frequency range between 0.15 MHz and 30MHz using CISPR Quasi-peak and average detector modes.

Radiated Emissions

The EUT is placed on a turn table, which is 0.8 m above ground plane. The turntable shall rotate 360 degrees to determine the position of maximum emission level. EUT is set 3m away from the receiving antenna, which varied from 1m to 4m to find out the highest emission. And also, each emission was to be maximized by changing the polarization of receiving antenna both horizontal and vertical. In order to find out the maximum emissions, exploratory radiated emission measurements were made according to the requirements in Section 13.1.4.1 of ANSI C63.4 (2009).



3.4 FCC PART 15.205 RESTRICTED BANDS OF OPERATIONS

(a) Except as shown in paragraph (d) of this section, only spurious emissions are permitted in any of the frequency bands listed below:

MHz	MHz	MHz	GHz
0.090 - 0.110	16.42 - 16.423	399.9 - 410	4.5 - 5.15
¹ 0.495 - 0.505	16.69475 - 16.69525	608 - 614	5.35 - 5.46
2.1735 - 2.1905	16.80425 - 16.80475	960 - 1240	7.25 - 7.75
4.125 - 4.128	25.5 - 25.67	1300 - 1427	8.025 - 8.5
4.17725 - 4.17775	37.5 - 38.25	1435 - 1626.5	9.0 - 9.2
4.20725 - 4.20775	73 - 74.6	1645.5 - 1646.5	9.3 - 9.5
6.215 - 6.218	74.8 - 75.2	1660 - 1710	10.6 - 12.7
6.26775 - 6.26825	108 - 121.94	1718.8 - 1722.2	13.25 - 13.4
6.31175 - 6.31225	123 - 138	2200 - 2300	14.47 - 14.5
8.291 - 8.294	149.9 - 150.05	2310 - 2390	15.35 - 16.2
8.362 - 8.366	156.52475 -	2483.5 - 2500	17.7 - 21.4
8.37625 - 8.38675	156.52525	2655 - 2900	22.01 - 23.12
8.41425 - 8.41475	156.7 - 156.9	3260 - 3267	23.6 - 24.0
12.29 - 12.293	162.0125 - 167.17	3332 - 3339	31.2 - 31.8
12.51975 - 12.52025	167.72 - 173.2	3345.8 - 3358	36.43 - 36.5
12.57675 - 12.57725	240 - 285	3600 - 4400	(²)
13.36 - 13.41	322 - 335.4		

¹ Until February 1, 1999, this restricted band shall be 0.490-0.510 MHz.

² Above 38.6

(b) Except as provided in paragraphs (d) and (e), the field strength of emissions appearing within these frequency bands shall not exceed the limits shown in Section 15.209. At frequencies equal to or less than 1000 MHz, compliance with the limits in Section 15.209 shall be demonstrated using measurement instrumentation employing a CISPR quasi-peak detector. Above 1000 MHz, compliance with the emission limits in Section 15.209 shall be demonstrated based on the average value of the measured emissions. The provisions in Section 15.35 apply to these measurements.

3.5 DESCRIPTION OF TEST MODES

The EUT (model: G33) had been tested under operating condition.

Test program used to control the EUT for staying in continuous transmitting mode was programmed.

After verification, all tests were carried out with the worst case test modes as shown below except radiated spurious emission below 1GHz, which worst case was in normal link mode only.

Channel Low (2403MHz), Channel Mid (2440MHz) and Channel High (2480MHz) were chosen for the final testing.

The field strength of spurious emission was measured in the following position: EUT stand-up position (Z axis), lie-down position (X, Y axis). The worst emission was found in lie-down position (X axis) and the worst case was recorded.



4. INSTRUMENT CALIBRATION

4.1 MEASURING INSTRUMENT CALIBRATION

The measuring equipment, which was utilized in performing the tests documented herein, has been calibrated in accordance with the manufacturer's recommendations for utilizing calibration equipment, which is traceable to recognized national standards.

4.2 MEASUREMENT EQUIPMENT USED

Equipment Used for Emissions Measurement

Remark: Each piece of equipment is scheduled for calibration once a year.

3M Semi Anechoic Chamber				
Name of Equipment	Manufacturer	Model	Serial Number	Calibration Due
Spectrum Analyzer	Agilent	E4446A	MY48250064	12/29/2011
Pre-Amplifier	HP	8447D	2944A06530	01/02/2012
Pre-Amplifier	HP	8449B	3008A01738	04/17/2011
EMI Test Receiver	SCHAFFNER	SCR 3501	430	01/18/2012
Loop Antenna	EMCO	6502	2356	06/11/2011
Bilog Antenna	SCHWAZBECK	VULB9160	3084	10/07/2011
Horn Antenna	EMCO	3115	00022250	05/09/2011
Turn Table	CCS	CC-T-1F	N/A	N.C.R
Antenna Tower	CCS	CC-A-1F	N/A	N.C.R
Controller	CCS	CC-C-1F	N/A	N.C.R
Test S/W	LabVIEW 6.1 (Wugu Chamber EMI Test V1_4.5.3)			

4.3 MEASUREMENT UNCERTAINTY

Parameter	Uncertainty
Powerline Conducted Emission	N/A
3M Semi Anechoic Chamber / 30MHz ~ 1GHz	±4.0474
3M Semi Anechoic Chamber / Above 1GHz	±3.8967

Remark: This uncertainty represents an expanded uncertainty expressed at approximately the 95% confidence level using a coverage factor of k=2.



5. FACILITIES AND ACCREDITATIONS

5.1 FACILITIES

All measurement facilities used to collect the measurement data are located at

- No. 199, Chunghsen Road, Hsintien City, Taipei Hsien, Taiwan, R.O.C.
Tel: 886-2-2217-0894 / Fax: 886-2-2217-1029

- No.11, Wugong 6th Rd., Wugu Industrial Park, Taipei Hsien 248, Taiwan
Tel: 886-2-2299-9720 / Fax: 886-2-2298-4045

- No.81-1, Lane 210, Bade 2nd Rd., Lujhu Township, Taoyuan County 33841, Taiwan, R.O.C.
Tel: 886-3-324-0332 / Fax: 886-3-324-5235

The sites are constructed in conformance with the requirements of ANSI C63.7 (1992), ANSI C63.4 (2009) and CISPR Publication 22.

5.2 EQUIPMENT

Radiated emissions are measured with one or more of the following types of linearly polarized antennas: tuned dipole, biconical, log periodic, bi-log, and/or ridged waveguide, horn. Spectrum analyzers with pre-selectors and quasi-peak detectors are used to perform radiated measurements.

Conducted emissions are measured with Line Impedance Stabilization Networks and EMI Test Receivers.

Calibrated wideband preamplifiers, coaxial cables, and coaxial attenuators are also used for making measurements.

All receiving equipment conforms to CISPR Publication 16-1, "Radio Interference Measuring Apparatus and Measurement Methods."



5.3 TABLE OF ACCREDITATIONS AND LISTINGS

Country	Agency	Scope of Accreditation	Logo
USA	A2LA	CFR 47, FCC Part15/18, CISPR 22, EN 55022, ICES-003, AS/NZS CISPR 22, VCCI V-3, EN 55011, CISPR 11, IEC/EN 61000-4-2/3/4/5/6/8/11, EN 61000-6-1/2/3/4, EN 55024, CISPR 24, AS/NZS CISPR 24, AS/NZS 61000.6.2, EN 55014-1/-2, ETSI EN 300 386 v1.3.2/v1.3.3, IEC/EN 61000-3-2, AS/NZS 61000.3.2, IEC/EN 61000-3-3, AS/NZS 61000.3.3	
USA	FCC MRA	3/10 meter Open Area Test Sites to perform FCC Part 15/18 measurements	
Japan	VCCI	3/10 meter Open Area Test Sites and conducted test sites to perform radiated/conducted measurements	
Taiwan	TAF	EN 55014-1, CISPR 14, CNS 13781-1, EN 55013, CISPR 13, CNS 13439, EN 55011, CISPR 11, CNS 13803, PLMN09, IS2045-0, LP0002 FCC Part 27/90, Part 15B/C/D/E, RSS-192/193/210/310 ETSI EN 300 328/ 300 220-1/ 300 220-2/ 301 893/ 301 489-01/ 301 489-03/ 301 489-07 / 301 489-17/ 300 440-1/ 300 440-2 AS/NZS 4268, AS/NZS 4771 CISPR 22, EN 55022, CNS 13438, AS/NZS CISPR 22, VCCI, IEC/EN 61000-4-2/3/4/5/6/8/11, CNS 14676-2/3/4/5/6/8, CNS 14934-2/3, CNS 13783-1, CNS 13439, CNS 13803	
Taiwan	BSMI	CNS 13438, CNS 13783-1, CNS 13439, CNS 14115	SL2-IS-E-0014 / IN-E-0014 /A1-E-0014 /R1-E-0014 /R2-E-0014 /L1-E-0014
Canada	Industry Canada	RSS-Gen Issue 3	

Note: No part of this report may be used to claim or imply product endorsement by A2LA, TAF or other government agency.



6. SETUP OF EQUIPMENT UNDER TEST

6.1 SETUP CONFIGURATION OF EUT

See test photographs attached in Appendix 1 for the actual connections between EUT and support equipment.

6.2 SUPPORT EQUIPMENT

No.	Equipment	Model No.	Serial No.	FCC ID	Trade Name	Data Cable	Power Cord
	N/A						

****No any support equipment during the test.**

Remark: Grounding was established in accordance with the manufacturer's requirements and conditions for the intended use.



7. FCC PART 15.249 REQUIREMENTS

7.1 20dB BANDWIDTH

LIMIT

None; for reporting purposes only.

TEST CONFIGURATION

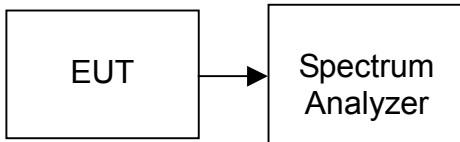

TEST PROCEDURE

1. Place the EUT on the table and set it in the transmitting mode.
2. Remove the antenna from the EUT and then connect a low loss RF cable from the antenna port to the spectrum analyzer.
3. Set the spectrum analyzer as RBW=100kHz, VBW = 300kHz, Span = 3MHz, Sweep = auto.
4. Mark the peak frequency and 20dB (upper and lower) frequency.
5. Repeat until all the rest channels are investigated.

TEST RESULTS

No non-compliance noted



TEST PLOT

20dB Bandwidth (CH Low)

Agilent 15:08:32 Mar 21, 2011

R L

Mkr1 1.210 MHz
-1.30 dB

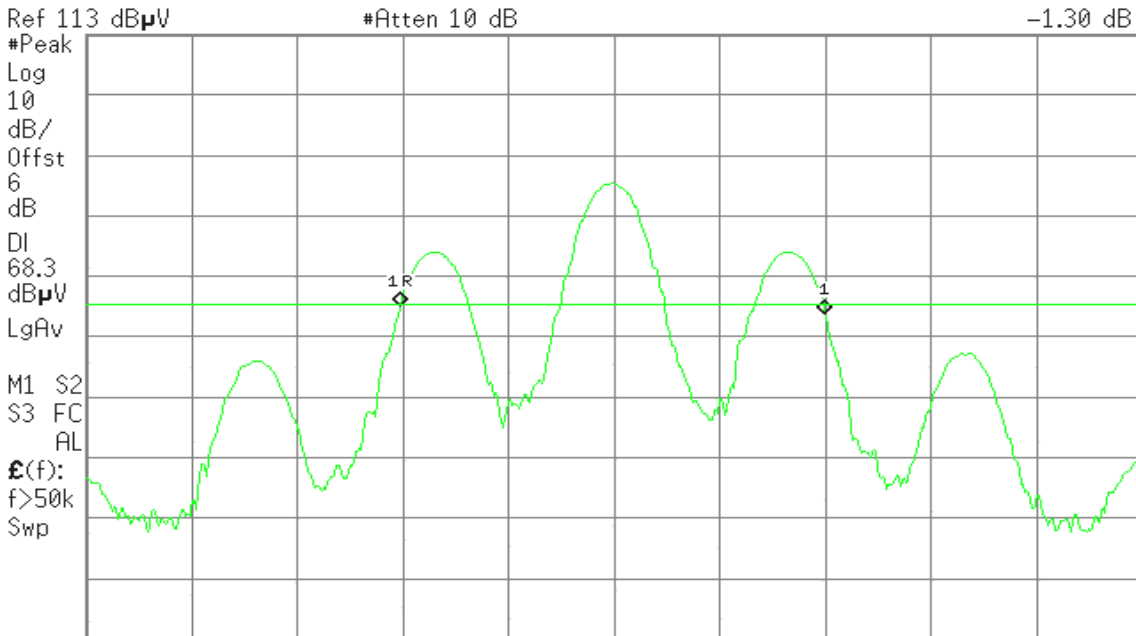

Center 2.402 980 GHz

#Res BW 100 kHz

#VBW 300 kHz

Span 3 MHz

Sweep 1 ms (601 pts)

20dB Bandwidth (CH Mid)

Agilent 15:10:36 Mar 21, 2011

R L

Mkr1 1.215 MHz
1.32 dB

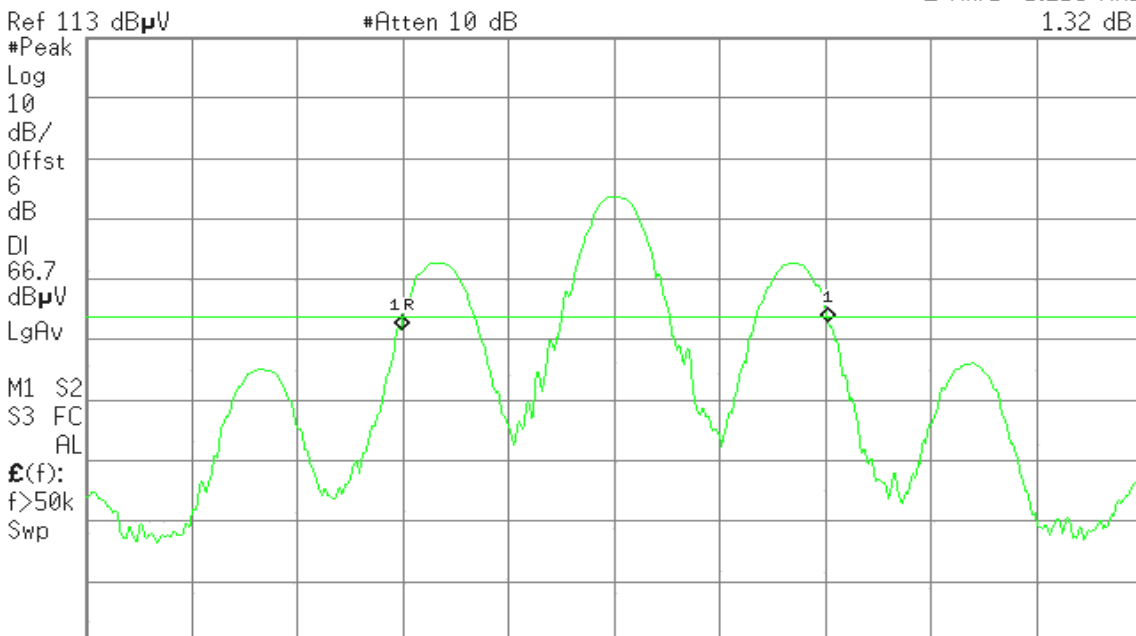

Center 2.439 968 GHz

#Res BW 100 kHz

#VBW 300 kHz

Span 3 MHz

Sweep 1 ms (601 pts)



20dB Bandwidth (CH High)

Agilent 15:13:01 Mar 21, 2011

R L

Mkr1 1.225 MHz
0.13 dB

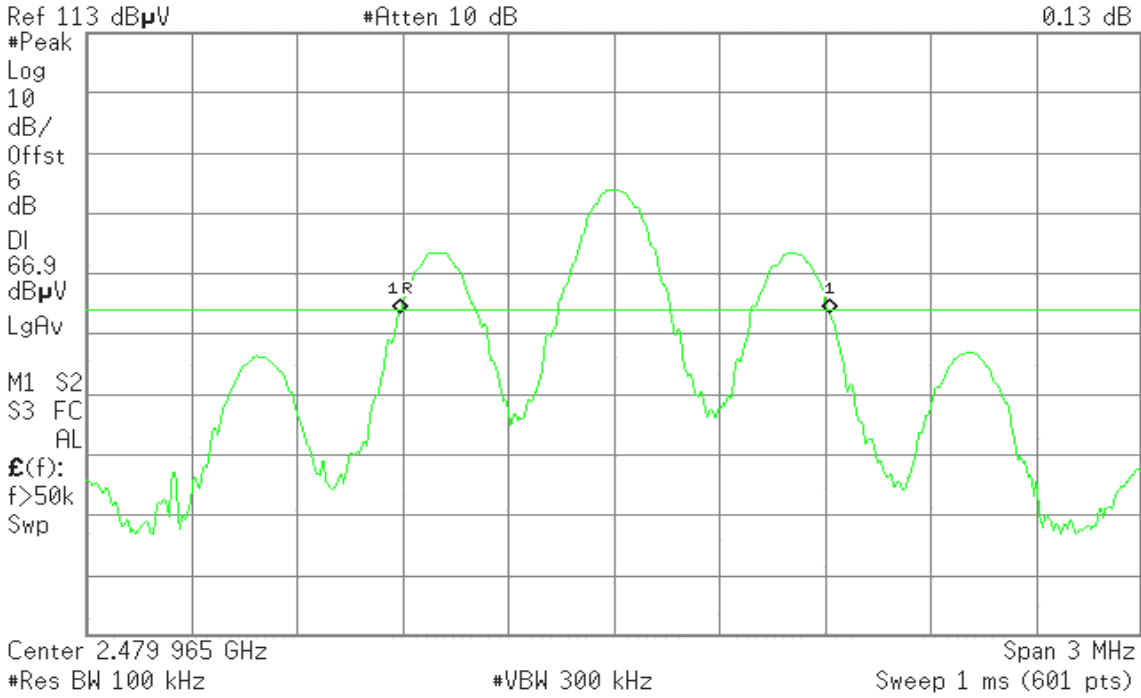



7.2 BAND EDGES MEASUREMENT

LIMIT

1. In the above emission table, the tighter limit applies at the band edges.

Frequency (MHz)	Field Strength ($\mu\text{V}/\text{m}$ at 3-meter)	Field Strength ($\text{dB}\mu\text{V}/\text{m}$ at 3-meter)
30-88	100	40
88-216	150	43.5
216-960	200	46
Above 960	500	54

2. As shown in Section 15.35(b), for frequencies above 1000 MHz, the above field strength limits in paragraphs (a) and (b) of this section are based on average limits. However, the peak field strength of any emission shall not exceed the maximum permitted average limits specified above by more than 20 dB under any condition of modulation. For point-to-point operation under paragraph (b) of this section, the peak field strength shall not exceed 2500 millivolts/meter at 3 meters along the antenna azimuth.

TEST CONFIGURATION

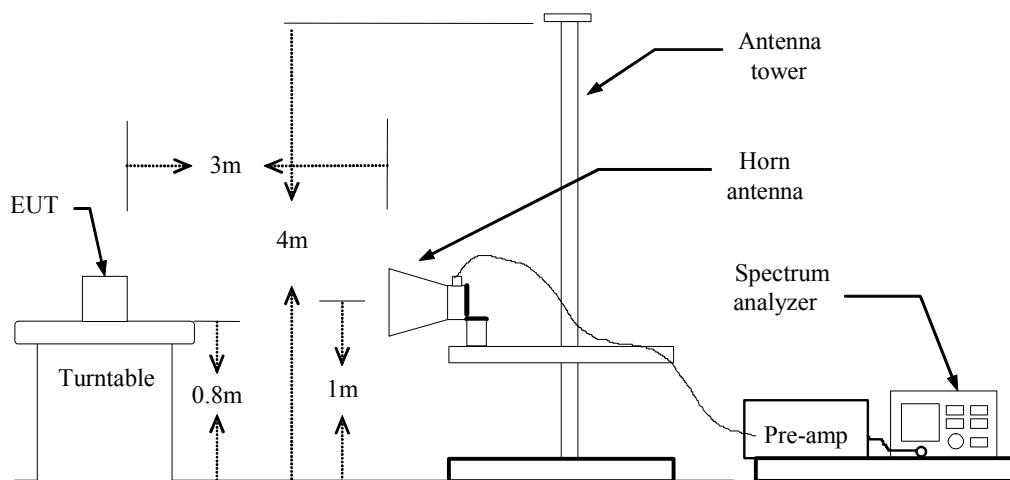

TEST PROCEDURE

1. The EUT is placed on a turntable, which is 0.8m above the ground plane.
2. The turntable shall be rotated for 360 degrees to determine the position of maximum emission level.
3. EUT is set 3m away from the receiving antenna, which is varied from 1m to 4m to find out the highest emission.
4. Set the spectrum analyzer in the following setting in order to capture the lower and upper band-edges of the emission:
 - (a) PEAK: RBW=VBW=1MHz / Sweep=AUTO
 - (b) AVERAGE: RBW=1MHz / VBW=10Hz / Sweep=AUTO
5. Repeat the procedures until all the PEAK and AVERAGE versus POLARIZATION are measured.

TEST RESULTS

Refer to attach spectrum analyzer data chart.



TEST PLOT

Band Edges (CH Low)

Detector mode: Peak

Polarity: Vertical

Agilent 16:58:26 Mar 21, 2011

R T

Mkr3 2.403 10 GHz 78.32 dBµV

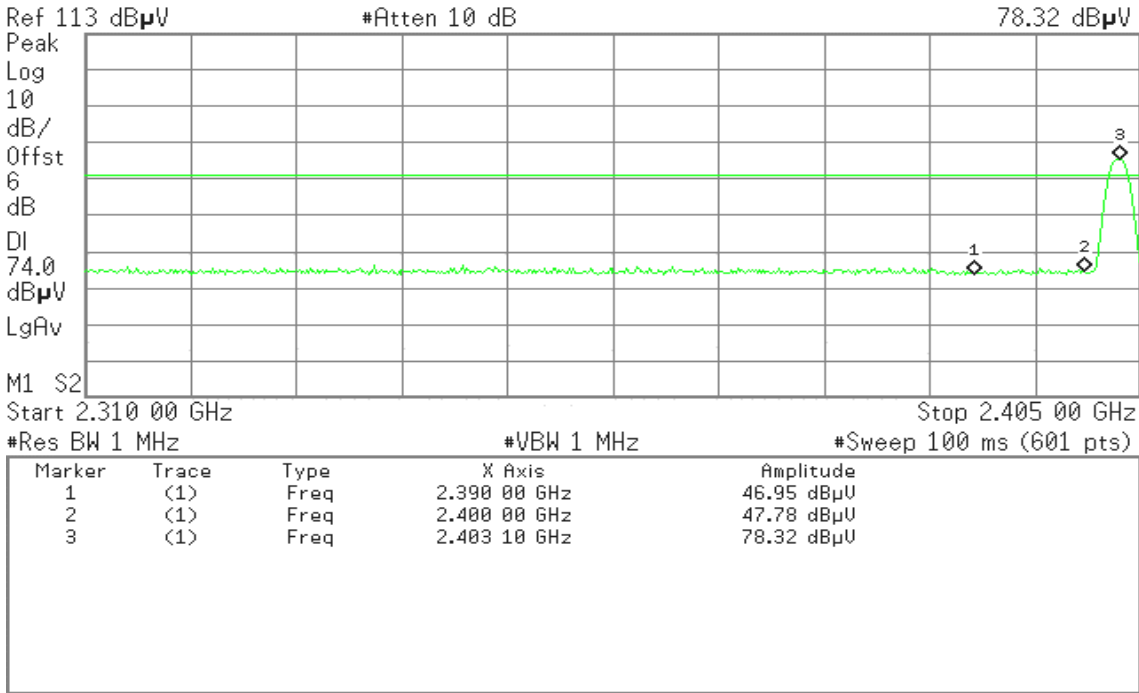

Detector mode: Average

Polarity: Vertical

Agilent 17:02:43 Mar 21, 2011

R T

Mkr3 2.402 94 GHz 77.54 dBµV

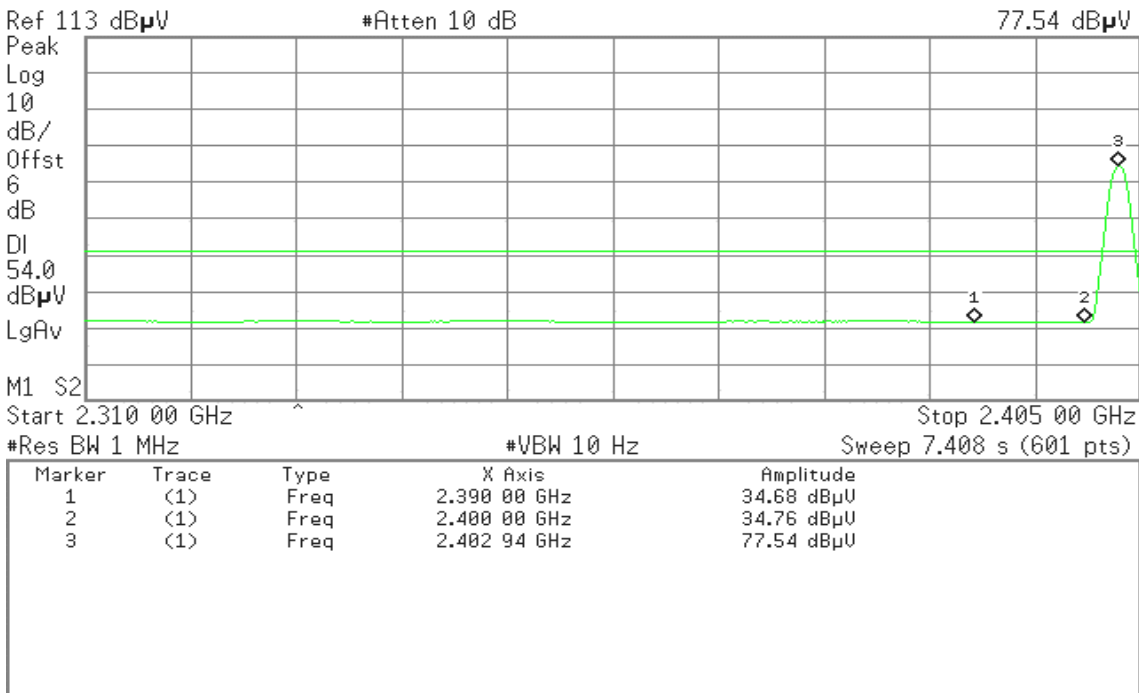

**Detector mode: Peak****Polarity: Horizontal**

* Agilent 17:04:57 Mar 21, 2011

R T

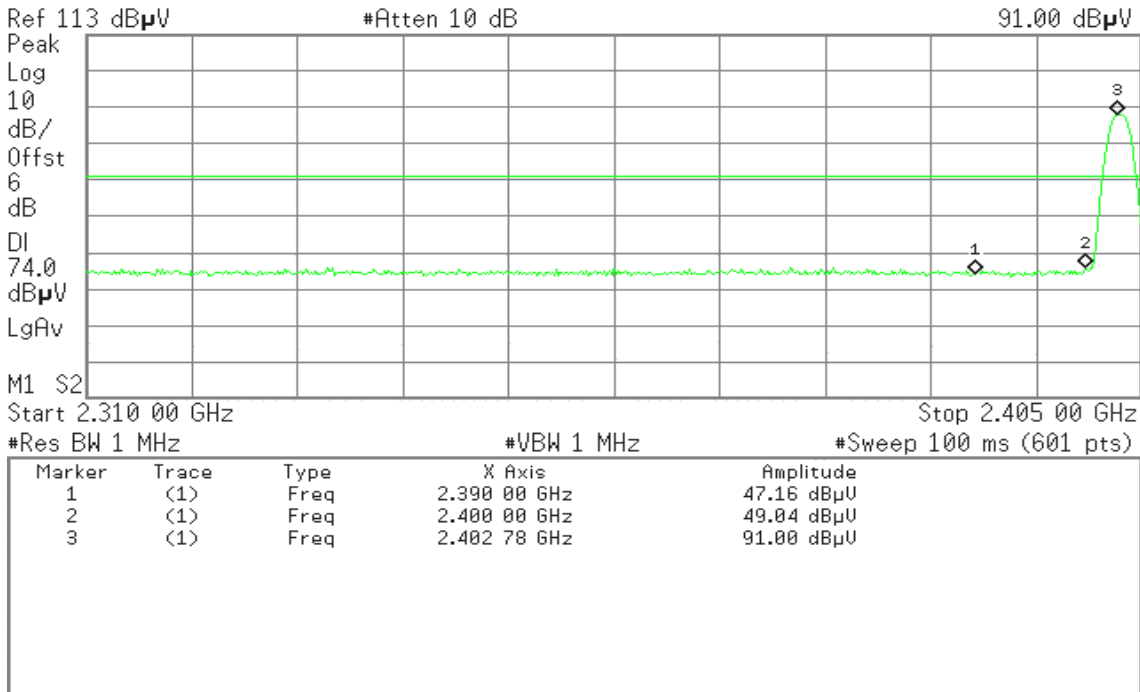
Mkr3 2.402 78 GHz
91.00 dB μ V**Detector mode: Average****Polarity: Horizontal**

* Agilent 17:06:07 Mar 21, 2011

R T

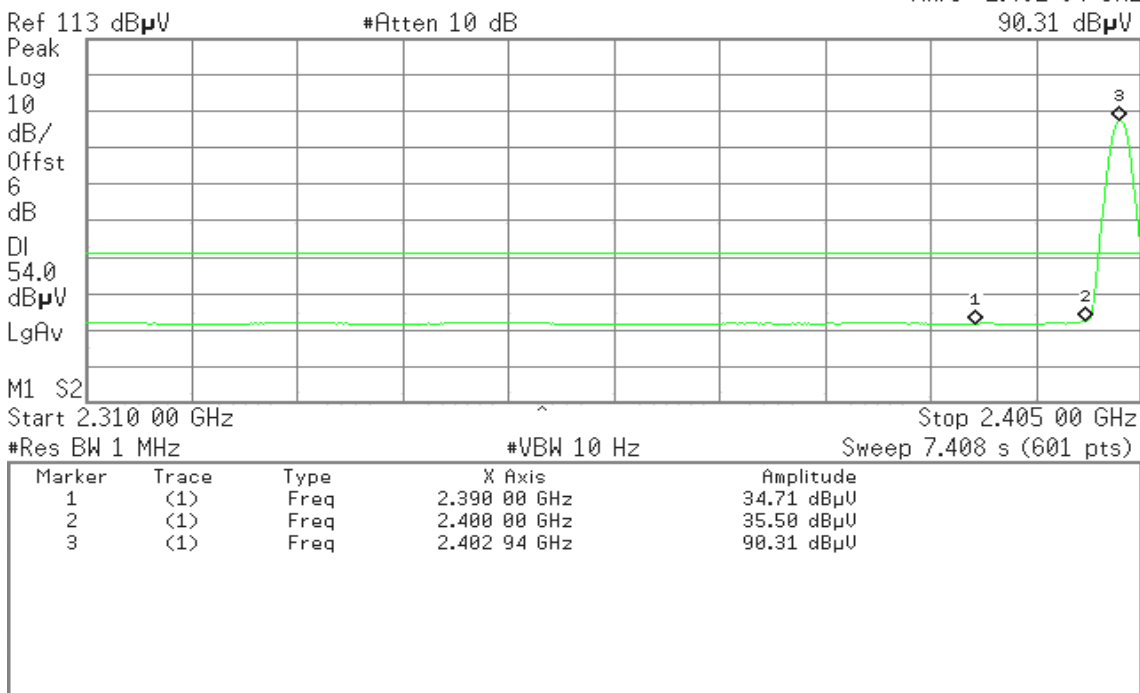
Mkr3 2.402 94 GHz
90.31 dB μ V



Band Edges (CH High)

Detector mode: Peak**Polarity: Vertical**

* Agilent 16:52:40 Mar 21, 2011

R T

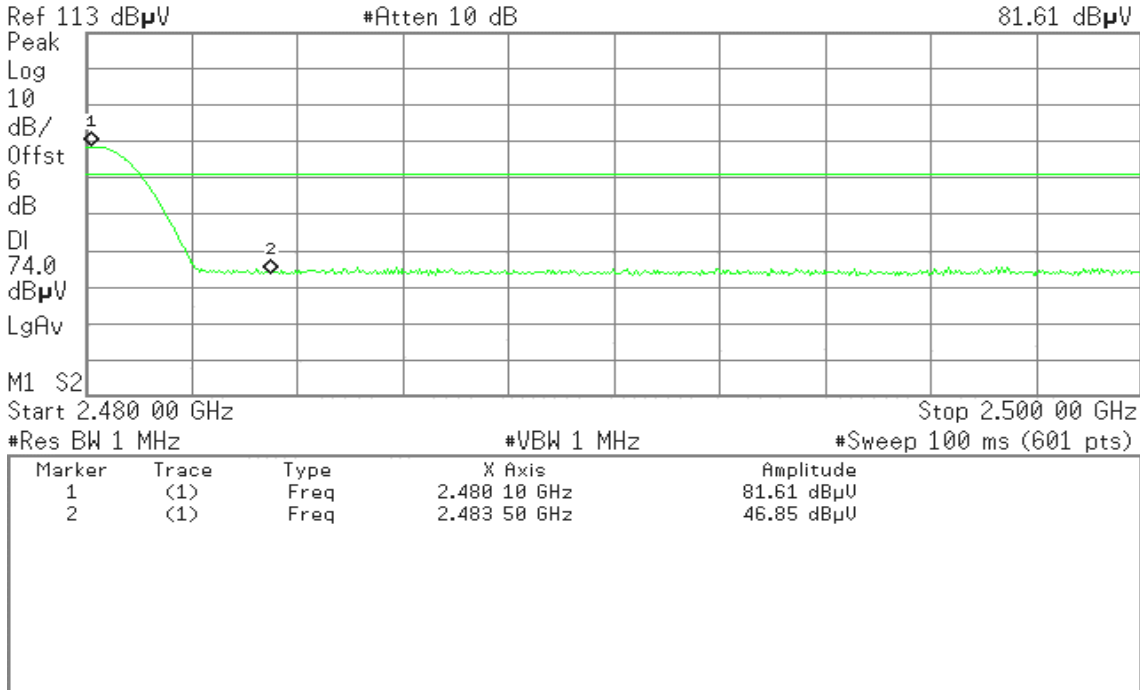
Mkr1 2.480 10 GHz
81.61 dB μ V**Detector mode: Average****Polarity: Vertical**

* Agilent 17:09:45 Mar 21, 2011

R T

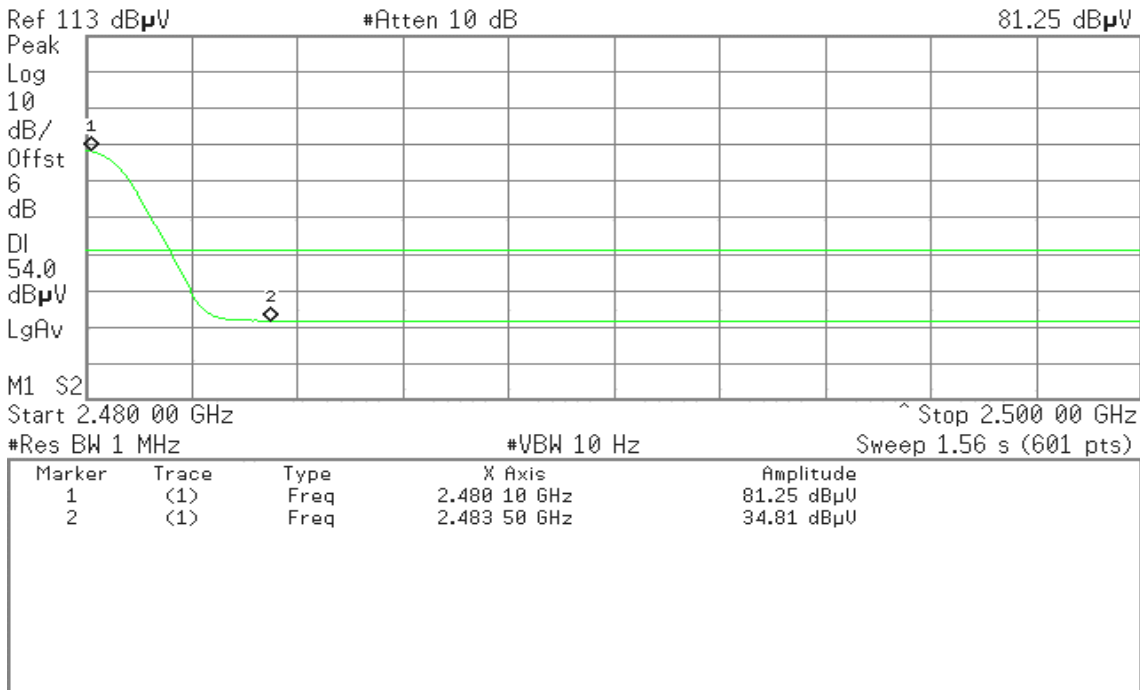
Mkr1 2.480 10 GHz
81.25 dB μ V



Detector mode: Peak

Polarity: Horizontal

Agilent 16:44:44 Mar 21, 2011

R T

Mkr1 2.480 17 GHz
93.44 dBµV

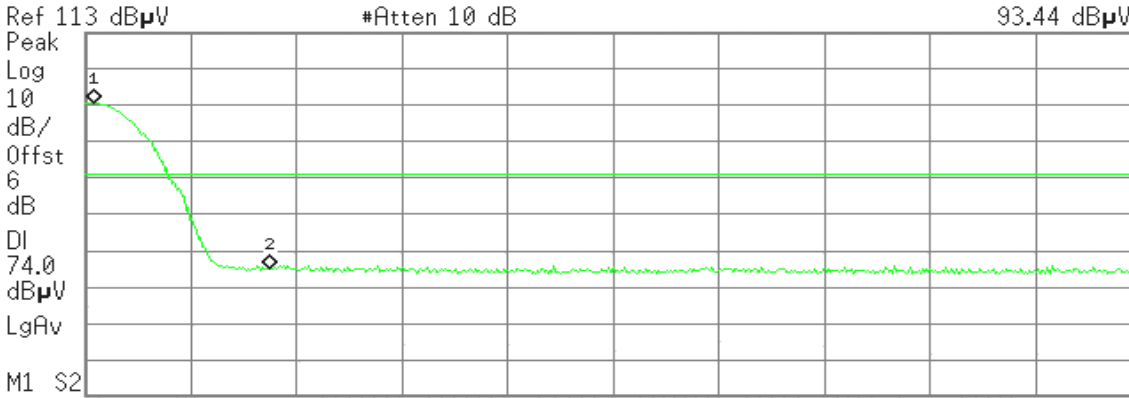

Start 2.480 00 GHz Stop 2.500 00 GHz
#Res BW 1 MHz #VBW 1 MHz #Sweep 100 ms (601 pts)

Marker	Trace	Type	X Axis	Amplitude
1	(1)	Freq	2.480 17 GHz	93.44 dBµU
2	(1)	Freq	2.483 50 GHz	48.27 dBµU

Detector mode: Average

Polarity: Horizontal

Agilent 16:50:45 Mar 21, 2011

R T

Mkr1 2.480 00 GHz
92.22 dBµV

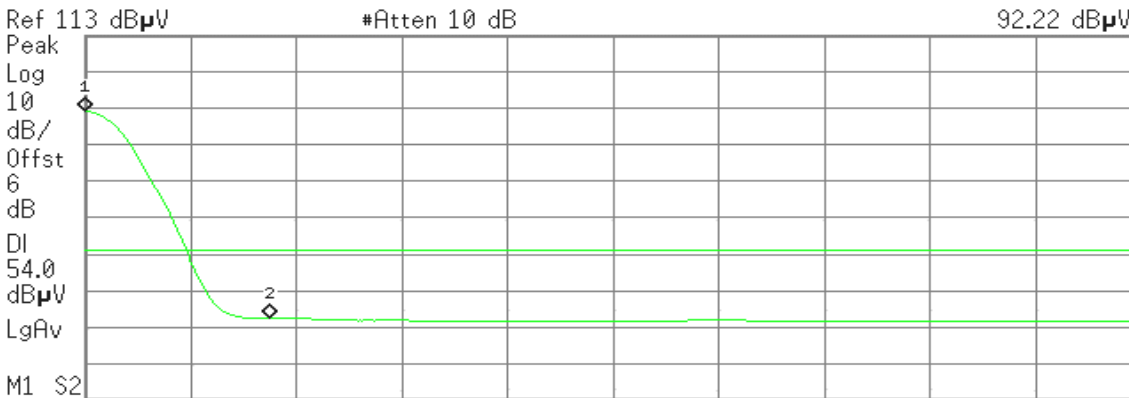

Start 2.480 00 GHz Stop 2.500 00 GHz
#Res BW 1 MHz #VBW 10 Hz Sweep 1.56 s (601 pts)

Marker	Trace	Type	X Axis	Amplitude
1	(1)	Freq	2.480 00 GHz	92.22 dBµU
2	(1)	Freq	2.483 50 GHz	35.39 dBµU



7.3 SPURIOUS EMISSION

LIMIT

1. In the section 15.249(a):

Except as provided in paragraph (b) of this section, the field strength of emissions from intentional radiators operated within these frequency bands shall comply with the following:

Fundamental Frequency (MHz)	Field Strength of Fundamental Field Strength (mV/m)	Field Strength of Harmonics (µV/m)
902-928 MHz	50	500
2400 - 2483.5 MHz	50	500
5725 - 5875 MHz	50	500
24.0 - 24.25 GHz	250	2500

2. Except as provided elsewhere in this Subpart, the emissions from an intentional radiator shall not exceed the field strength levels specified in the following table:

Frequency (MHz)	Field Strength (µV/m)	Measurement Distance (m)
30-88	100*	3
88-216	150*	3
216-960	200*	3
Above 960	500	3

Remark: Except as provided in paragraph (g), fundamental emissions from intentional radiators operating under this Section shall not be located in the frequency bands 54-72 MHz, 76-88 MHz, 174-216 MHz or 470-806 MHz. However, operation within these frequency bands is permitted under other sections of this Part, e.g., Sections 15.231 and 15.241.

3. In the above emission table, the tighter limit applies at the band edges.

Frequency (MHz)	Field Strength (µV/m at 3-meter)	Field Strength (dBµV/m at 3-meter)
30-88	100	40
88-216	150	43.5
216-960	200	46
Above 960	500	54



TEST CONFIGURATION

9kHz ~ 30MHz

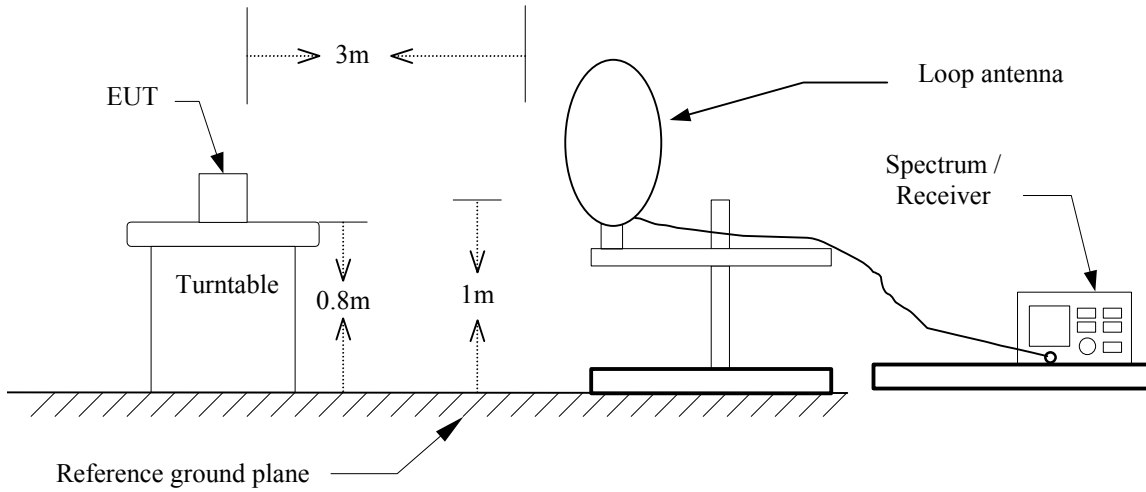

Below 1 GHz

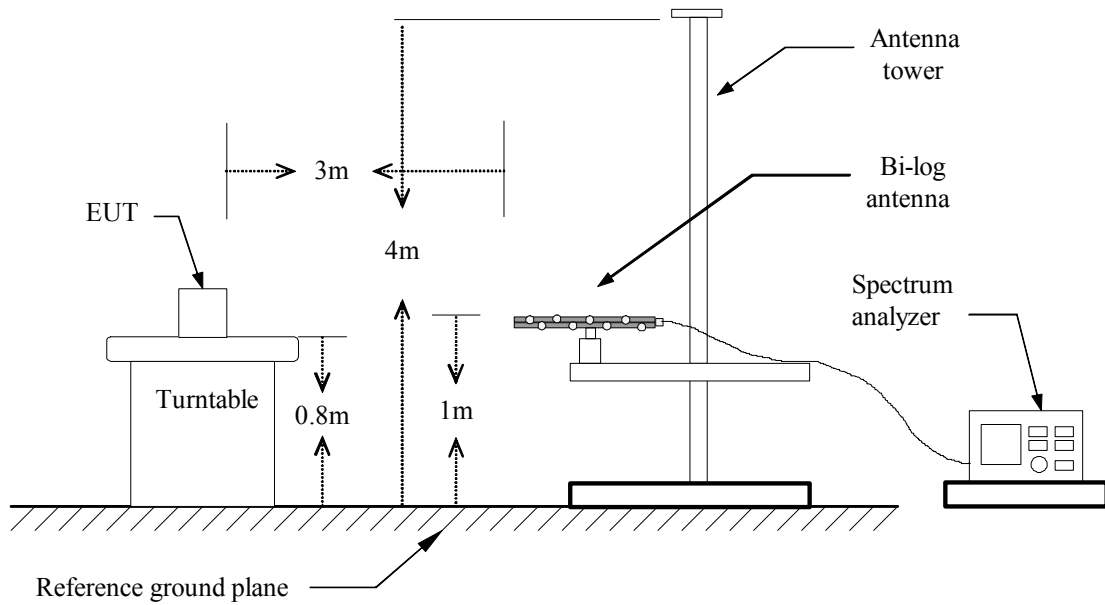



Above 1 GHz

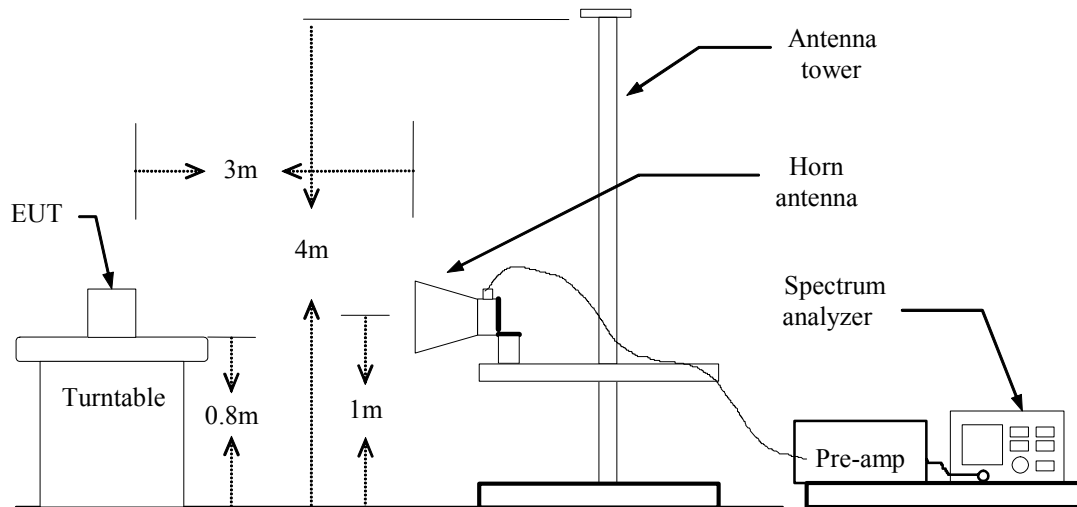

TEST PROCEDURE

1. The EUT is placed on a turntable, which is 0.8m above ground plane.
2. The turntable shall be rotated for 360 degrees to determine the position of maximum emission level.
3. EUT is set 3m away from the receiving antenna, which is varied from 1m to 4m to find out the highest emissions.
4. Maximum procedure was performed on the six highest emissions to ensure EUT compliance.
5. And also, each emission was to be maximized by changing the polarization of receiving antenna both horizontal and vertical.
6. Set the spectrum analyzer in the following setting as:

Below 30MHz

RBW=9kHz / VBW=300kHz / Sweep=AUTO

30 ~ 1000MHz:

RBW=120kHz / VBW=300kHz / Sweep=AUTO

Above 1GHz:

(a) PEAK: RBW=VBW=1MHz / Sweep=AUTO

(b) AVERAGE: RBW=1MHz / VBW=10Hz / Sweep=AUTO

7. Repeat above procedures until the measurements for all frequencies are complete.

TEST RESULTS

No non-compliance noted.



TEST DATA

Below 1 GHz

Operation Mode: Normal Link **Test Date:** 2011/3/21
Temperature: 18°C **Tested by:** Stan Lin
Humidity: 60% RH **Polarity:** Ver. / Hor.

Frequency (MHz)	Ant. Pol. (H/V)	Reading (dBuV)	Correction Factor (dB/m)	Result (dBuV/m)	Limit (dBuV/m)	Margin (dB)	Remark
134.3235	V	49.63	-13.45	36.18	43.50	-7.32	QP
199.7500	V	45.98	-15.40	30.58	43.50	-12.92	QP
226.4250	V	46.12	-14.65	31.47	46.00	-14.53	QP
257.9500	V	50.54	-12.32	38.22	46.00	-7.78	QP
398.6000	V	47.94	-9.48	38.46	46.00	-7.54	QP
599.8750	V	42.30	-3.99	38.31	46.00	-7.69	QP
665.3500	V	39.86	-4.39	35.47	46.00	-10.53	QP
143.9750	H	35.78	-12.40	23.38	43.50	-20.12	QP
160.9500	H	34.32	-13.01	21.31	43.50	-22.19	QP
199.7500	H	35.98	-15.40	20.58	43.50	-22.92	QP
493.1750	H	33.00	-7.24	25.76	46.00	-20.24	QP
599.8750	H	35.70	-3.99	31.71	46.00	-14.29	QP
759.9250	H	34.29	-2.15	32.14	46.00	-13.86	QP
944.2250	H	32.68	1.36	34.04	46.00	-11.96	QP

Remark:

1. No emission found between lowest internal used / generated frequency to 30 MHz. (9kHz ~ 30MHz)
2. Measuring frequencies from 9 kHz to the 1GHz.
3. Radiated emissions measured in the measured frequency range were made with an instrument using Quasi-peak detector mode.
4. Data of measurement within this frequency range shown " --- " in the table above means the reading of emissions are attenuated more than 20dB below the permissible limits or the field strength is too small to be measured.
5. The IF bandwidth of SPA between 30MHz to 1GHz was 100kHz.



Above 1 GHz

Operation Mode: Tx / CH Low **Test Date:** 2011/3/18
Temperature: 20°C **Tested by:** Chieh Cheng
Humidity: 50% RH **Polarity:** Ver. / Hor.

Freq. (MHz)	Ant. Pol H/V	Peak Reading (dBuV)	AV Reading (dBuV)	Ant. / CL CF (dB)	Result		Peak Limit (dBuV/m)	AV Limit (dBuV/m)	Margin (dB)	Remark
					Peak (dBuV/m)	AV (dBuV/m)				
2403.08	V	79.98	79.25	1.32	81.29	80.57	114.00	94.00	-13.43	AVG
2210.00	V	48.93	---	0.76	49.69	---	74.00	54.00	-4.31	Peak
2646.67	V	48.51	---	1.33	49.84	---	74.00	54.00	-4.16	Peak
4808.33	V	42.00	---	6.25	48.26	---	74.00	54.00	-5.74	Peak
N/A										
2403.13	H	92.66	92.21	-1.54	91.12	90.67	114.00	94.00	-3.33	AVG
1776.67	H	50.32	---	-4.20	46.12	---	74.00	54.00	-7.88	Peak
2703.33	H	48.55	---	-0.51	48.04	---	74.00	54.00	-5.96	Peak
4808.33	H	44.64	---	7.73	52.37	---	74.00	54.00	-1.63	Peak
N/A										

Remark:

1. Measuring frequencies from 1 GHz to the 10th harmonic of highest fundamental frequency.
2. Radiated emissions measured in frequency above 1000MHz were made with an instrument using peak/average detector mode.
3. Average test would be performed if the peak result were greater than the average limit or as required by the applicant.
4. Data of measurement within this frequency range shown "---" in the table above means the reading of emissions are attenuated more than 20dB below the permissible limits or the field strength is too small to be measured.
5. Measurements above show only up to 6 maximum emissions noted, or would be lesser, with "N/A" no emission measured remark, if no specific emissions from the EUT are recorded (ie: margin>20dB from the applicable limit) and considered that's already beyond the background noise floor.



Operation Mode: Tx / CH Mid **Test Date:** 2011/3/18
Temperature: 20°C **Tested by:** Chieh Cheng
Humidity: 50% RH **Polarity:** Ver. / Hor.

Freq. (MHz)	Ant. Pol H/V	Peak Reading (dBuV)	AV Reading (dBuV)	Ant. / CL CF (dB)	Result		Peak Limit (dBuV/m)	AV Limit (dBuV/m)	Margin (dB)	Remark
					Peak (dBuV/m)	AV (dBuV/m)				
2440.15	V	80.85	80.38	1.74	82.59	82.12	114.00	94.00	-11.88	AVG
1753.33	V	50.62	---	-1.75	48.87	---	74.00	54.00	-5.13	Peak
2826.67	V	48.46	---	0.94	49.41	---	74.00	54.00	-4.59	Peak
4883.33	V	44.97	---	7.44	52.40	---	74.00	54.00	-1.60	Peak
N/A										
2440.17	H	93.61	93.15	-1.53	92.08	91.62	114.00	94.00	-2.38	AVG
2076.67	H	49.85	---	-2.12	47.74	---	74.00	54.00	-6.26	Peak
2563.33	H	49.66	---	-0.41	49.25	---	74.00	54.00	-4.75	Peak
4883.33	H	45.21	---	7.75	52.96	---	74.00	54.00	-1.04	Peak
N/A										

Remark:

1. Measuring frequencies from 1 GHz to the 10th harmonic of highest fundamental frequency.
2. Radiated emissions measured in frequency above 1000MHz were made with an instrument using peak/average detector mode.
3. Average test would be performed if the peak result were greater than the average limit or as required by the applicant.
4. Data of measurement within this frequency range shown "---" in the table above means the reading of emissions are attenuated more than 20dB below the permissible limits or the field strength is too small to be measured.
5. Measurements above show only up to 6 maximum emissions noted, or would be lesser, with "N/A" no emission measured remark, if no specific emissions from the EUT are recorded (ie: margin>20dB from the applicable limit) and considered that's already beyond the background noise floor.

**Operation Mode:** Tx / CH High**Test Date:** 2011/3/18**Temperature:** 20°C**Tested by:** Chieh Cheng**Humidity:** 50% RH**Polarity:** Ver. / Hor.

Freq. (MHz)	Ant. Pol H/V	Peak Reading (dBuV)	AV Reading (dBuV)	Ant. / CL CF (dB)	Result		Peak Limit (dBuV/m)	AV Limit (dBuV/m)	Margin (dB)	Remark
					Peak (dBuV/m)	AV (dBuV/m)				
2479.78	V	83.37	82.89	2.20	85.57	85.09	114.00	94.00	-8.91	AVG
2220.00	V	49.53	---	0.73	50.25	---	74.00	54.00	-3.75	Peak
2723.33	V	49.40	---	1.42	50.82	---	74.00	54.00	-3.18	Peak
4958.33	V	44.67	---	6.96	51.62	---	74.00	54.00	-2.38	Peak
N/A										
2480.17	H	95.05	94.63	-1.52	93.53	93.11	114.00	94.00	-0.89	AVG
2306.67	H	49.70	---	-1.33	48.36	---	74.00	54.00	-5.64	Peak
2876.67	H	48.15	---	0.72	48.87	---	74.00	54.00	-5.13	Peak
4958.33	H	44.05	---	8.75	52.81	---	74.00	54.00	-1.19	Peak
N/A										

Remark:

1. Measuring frequencies from 1 GHz to the 10th harmonic of highest fundamental frequency.
2. Radiated emissions measured in frequency above 1000MHz were made with an instrument using peak/average detector mode.
3. Average test would be performed if the peak result were greater than the average limit or as required by the applicant.
4. Data of measurement within this frequency range shown "---" in the table above means the reading of emissions are attenuated more than 20dB below the permissible limits or the field strength is too small to be measured.
5. Measurements above show only up to 6 maximum emissions noted, or would be lesser, with "N/A" no emission measured remark, if no specific emissions from the EUT are recorded (ie: margin>20dB from the applicable limit) and considered that's already beyond the background noise floor.



7.4 POWERLINE CONDUCTED EMISSIONS

LIMIT

According to §15.207(a), except as shown in paragraphs (b) and (c) of this section, for an intentional radiator that is designed to be connected to the public utility (AC) power line, the radio frequency voltage that is conducted back onto the AC power line on any frequency or frequencies within the band 150 kHz to 30 MHz shall not exceed the limits in the following table, as measured using a 50 μ H/50 ohms line impedance stabilization network (LISN). Compliance with the provisions of this paragraph shall be based on the measurement of the radio frequency voltage between each power line and ground at the power terminal. The lower limit applies at the boundary between the frequency ranges.

Frequency Range (MHz)	Limits (dB μ V)	
	Quasi-peak	Average
0.15 to 0.50	66 to 56*	56 to 46*
0.50 to 5	56	46
5 to 30	60	50

* Decreases with the logarithm of the frequency.

TEST CONFIGURATION

See test photographs attached in Appendix 1 for the actual connections between EUT and support equipment.

TEST PROCEDURE

1. The EUT was placed on a table, which is 0.8m above ground plane.
2. Maximum procedure was performed on the six highest emissions to ensure EUT compliance.
3. Repeat above procedures until all frequency measured were complete.



TEST RESULTS

The initial step in collecting conducted data is a spectrum analyzer peak scan of the measurement range. Significant peaks are then marked as shown on the following data page, and these signals are then quasi-peaked.

TEST DATA

Not applicable (Since the EUT is powered by battery)