



FCC 47 CFR PART 15 SUBPART C

TEST REPORT

For

2.4G Wireless Mouse

Model Number: GAR, GAT, GC5

Trade Name: ACROX

Issued to

**Acrox Technologies Co., Ltd.
8F, No. 437, Rui Guang Rd., Nei Hu Dist.,
Taipei 114, Taiwan, R.O.C.**

Issued by

**Compliance Certification Services Inc.
No. 11, Wu-Gong 6th Rd., Wugu Industrial Park,
Taipei Hsien 248, Taiwan (R.O.C.)
<http://www.ccsrf.com>
service@ccsrf.com**



***Note:** This report shall not be reproduced except in full, without the written approval of Compliance Certification Services Inc. This document may be altered or revised by Compliance Certification Services Inc. personnel only, and shall be noted in the revision section of the document.*



TABLE OF CONTENTS

1. TEST RESULT CERTIFICATION.....	3
2. EUT DESCRIPTION.....	4
3. TEST METHODOLOGY	5
3.1 EUT CONFIGURATION	5
3.2 EUT EXERCISE.....	5
3.3 GENERAL TEST PROCEDURES.....	5
3.4 FCC PART 15.205 RESTRICTED BANDS OF OPERATIONS	6
3.5 DESCRIPTION OF TEST MODES	7
4. INSTRUMENT CALIBRATION.....	8
4.1 MEASURING INSTRUMENT CALIBRATION	8
4.2 MEASUREMENT EQUIPMENT USED	8
4.3 MEASUREMENT UNCERTAINTY	9
5. FACILITIES AND ACCREDITATIONS	10
5.1 FACILITIES	10
5.2 EQUIPMENT.....	10
5.3 TABLE OF ACCREDITATIONS AND LISTINGS.....	11
6. SETUP OF EQUIPMENT UNDER TEST	12
6.1 SETUP CONFIGURATION OF EUT.....	12
6.2 SUPPORT EQUIPMENT	12
7. FCC PART 15.249 REQUIREMENTS.....	13
7.1 20 DB BANDWIDTH.....	13
7.2 BAND EDGES MEASUREMENT	16
7.3 SPURIOUS EMISSION	21
7.4 POWERLINE CONDUCTED EMISSIONS	29
APPENDIX I PHOTOGRAPHS OF TEST SETUP	30
APPENDIX 1 - PHOTOGRAPHS OF EUT	



1. TEST RESULT CERTIFICATION

Applicant: Acrox Technologies Co., Ltd.
 8F, No. 437, Rui Guang Rd., Nei Hu Dist.,
 Taipei 114, Taiwan, R.O.C.

Equipment Under Test: 2.4G Wireless Mouse

Trade Name: ACROX

Model Number: GAR, GAT, GC5

Date of Test: April 12 ~ 23, 2010

APPLICABLE STANDARDS	
STANDARD	TEST RESULT
FCC 47 CFR Part 15 Subpart C	No non-compliance noted

We hereby certify that:

The above equipment was tested by Compliance Certification Services Inc. The test data, data evaluation, test procedures, and equipment configurations shown in this report were made in accordance with the procedures given in **ANSI C63.4: 2003** and the energy emitted by the sample EUT tested as described in this report is in compliance with the requirements emission limits of FCC Rules Part 15.207, 15.209 and 15.249.

The test results of this report relate only to the tested sample identified in this report.

Approved by:

Reviewed by:

 Rex Lai
 Section Manager
 Compliance Certification Services Inc.

 Gina Lo
 Section Manager
 Compliance Certification Services Inc.



2. EUT DESCRIPTION

Product	2.4G Wireless Mouse
Trade Name	ACROX
Model Number	GAR, GAT, GC5
Model Discrepancy	All the specification and layout are identical except they come with different model numbers for marketing purposes.
Power Supply	Powered by AAA batteries × 2 (DC: 3V)
Frequency Range	2403 ~ 2480 MHz
Frequency Spacing	1MHz
Frequency Number	78 Channels
Modulation Technique	GFSK
Antenna Gain	-5.91 dBi
Antenna Designation	PCB Antenna

Remark:

1. *The sample selected for test was production product and was provided by manufacturer.*
2. *This submittal(s) (test report) is intended for FCC ID: **PRDLAWIRTMU02** filing to comply with Section 15.107, 15.109, 15.207, 15.209, 15.249 (FCC Part 15, Subpart C Rules.)*



3. TEST METHODOLOGY

The tests documented in this report were performed in accordance with ANSI C63.4: 2003 and FCC CFR 47 Part 15.207, 15.209 and 15.249.

3.1 EUT CONFIGURATION

The EUT configuration for testing is installed on RF field strength measurement to meet the Commissions requirement and operating in a manner that intends to maximize its emission characteristics in a continuous normal application.

3.2 EUT EXERCISE

The EUT was operated in the engineering mode to fix the TX frequency that was for the purpose of the measurements.

According to its specifications, the EUT must comply with the requirements of the Section 15.207, 15.209, 15.249 under the FCC Rules Part 15 Subpart C.

3.3 GENERAL TEST PROCEDURES

Conducted Emissions

The EUT is placed on the turntable, which is 0.8 m above ground plane. According to the requirements in Section 13.1.4.1 of ANSI C63.4: 2003 Conducted emissions from the EUT measured in the frequency range between 0.15 MHz and 30MHz using CISPR Quasi-peak and average detector modes.

Radiated Emissions

The EUT is placed on a turn table, which is 0.8 m above ground plane. The turntable shall rotate 360 degrees to determine the position of maximum emission level. EUT is set 3m away from the receiving antenna, which varied from 1m to 4m to find out the highest emission. And also, each emission was to be maximized by changing the polarization of receiving antenna both horizontal and vertical. In order to find out the maximum emissions, exploratory radiated emission measurements were made according to the requirements in Section 13.1.4.1 of ANSI C63.4: 2003.



3.4 FCC PART 15.205 RESTRICTED BANDS OF OPERATIONS

(a) Except as shown in paragraph (d) of this section, only spurious emissions are permitted in any of the frequency bands listed below:

MHz	MHz	MHz	GHz
0.090 - 0.110	16.42 - 16.423	399.9 - 410	4.5 - 5.15
¹ 0.495 - 0.505	16.69475 - 16.69525	608 - 614	5.35 - 5.46
2.1735 - 2.1905	16.80425 - 16.80475	960 - 1240	7.25 - 7.75
4.125 - 4.128	25.5 - 25.67	1300 - 1427	8.025 - 8.5
4.17725 - 4.17775	37.5 - 38.25	1435 - 1626.5	9.0 - 9.2
4.20725 - 4.20775	73 - 74.6	1645.5 - 1646.5	9.3 - 9.5
6.215 - 6.218	74.8 - 75.2	1660 - 1710	10.6 - 12.7
6.26775 - 6.26825	108 - 121.94	1718.8 - 1722.2	13.25 - 13.4
6.31175 - 6.31225	123 - 138	2200 - 2300	14.47 - 14.5
8.291 - 8.294	149.9 - 150.05	2310 - 2390	15.35 - 16.2
8.362 - 8.366	156.52475 -	2483.5 - 2500	17.7 - 21.4
8.37625 - 8.38675	156.52525	2655 - 2900	22.01 - 23.12
8.41425 - 8.41475	156.7 - 156.9	3260 - 3267	23.6 - 24.0
12.29 - 12.293	162.0125 - 167.17	3332 - 3339	31.2 - 31.8
12.51975 - 12.52025	167.72 - 173.2	3345.8 - 3358	36.43 - 36.5
12.57675 - 12.57725	240 - 285	3600 - 4400	(²)
13.36 - 13.41	322 - 335.4		

¹ Until February 1, 1999, this restricted band shall be 0.490-0.510 MHz.

² Above 38.6

(b) Except as provided in paragraphs (d) and (e), the field strength of emissions appearing within these frequency bands shall not exceed the limits shown in Section 15.209. At frequencies equal to or less than 1000 MHz, compliance with the limits in Section 15.209 shall be demonstrated using measurement instrumentation employing a CISPR quasi-peak detector. Above 1000 MHz, compliance with the emission limits in Section 15.209 shall be demonstrated based on the average value of the measured emissions. The provisions in Section 15.35 apply to these measurements.



3.5 DESCRIPTION OF TEST MODES

The EUT (model: GAR) had been tested under operating condition.

After verification, all tests were carried out with the worst case test modes as shown below except radiated spurious emission below 1GHz, which worst case was in normal link mode only

Channel Low (2403MHz), Channel Mid (2440MHz) and Channel High (2480MHz) were chosen for full testing.



4. INSTRUMENT CALIBRATION

4.1 MEASURING INSTRUMENT CALIBRATION

The measuring equipment, which was utilized in performing the tests documented herein, has been calibrated in accordance with the manufacturer's recommendations for utilizing calibration equipment, which is traceable to recognized national standards.

4.2 MEASUREMENT EQUIPMENT USED

Equipment Used for Emissions Measurement

Remark: Each piece of equipment is scheduled for calibration once a year.

3M Semi Anechoic Chamber				
Name of Equipment	Manufacturer	Model	Serial Number	Calibration Due
Spectrum Analyzer	Agilent	E4446A	US42510252	10/26/2010
EMI Test Receiver	R&S	ESCI	100064	02/04/2011
Pre-Amplifier	Mini-Circuits	ZFL-1000LN	SF350700823	01/13/2011
Pre-Amplifier	MITEQ	AFS44-00102650-42-10P-44	1415367	11/20/2010
Bilog Antenna	Sunol Sciences	JB3	A030105	09/11/2010
Horn Antenna	EMCO	3117	00055165	12/07/2010
Loop Antenna	EMCO	6502	8905/2356	05/28/2010
Turn Table	CCS	CC-T-1F	N/A	N.C.R
Antenna Tower	CCS	CC-A-1F	N/A	N.C.R
Controller	CCS	CC-C-1F	N/A	N.C.R
Site NSA	CCS	N/A	N/A	12/31/2010
Test S/W	EZ-EMC (CCS-3A1RE)			



4.3 MEASUREMENT UNCERTAINTY

PARAMETER	UNCERTAINTY
Powerline Conducted Emission	+/-1.1559
3M Semi Anechoic Chamber / 30M~200M	+/-3.9944
3M Semi Anechoic Chamber / 200M~1000M	+/-3.9285
3M Semi Anechoic Chamber / 1G~8G	+/-2.4734
3M Semi Anechoic Chamber / 8G~18G	+/-2.4878
3M Semi Anechoic Chamber / 18G~26G	+/-2.6215
3M Semi Anechoic Chamber / 26G~40G	+/-2.8603

Remark: This uncertainty represents an expanded uncertainty expressed at approximately the 95% confidence level using a coverage factor of $k=2$.



5. FACILITIES AND ACCREDITATIONS

5.1 FACILITIES

All measurement facilities used to collect the measurement data are located at

No. 199, Chunghsen Road, Hsintien City, Auerbach / Opf GERMANY

Tel: 886-2-2217-0894 / Fax: 886-2-2217-1029

No.11, Wugong 6th Rd., Wugu Industrial Park, Taipei Hsien 248, Taiwan

Tel: 886-2-2299-9720 / Fax: 886-2-2298-4045

No.81-1, Lane 210, Bade 2nd Rd., Luchu Hsiang, Taoyuan Hsien 338, Taiwan

Tel: 886-3-324-0332 / Fax: 886-3-324-5235

The sites are constructed in conformance with the requirements of ANSI C63.7, ANSI C63.4 and CISPR Publication 22.

5.2 EQUIPMENT



Radiated emissions are measured with one or more of the following types of linearly polarized antennas: tuned dipole, biconical, log periodic, bi-log, and/or ridged waveguide, horn. Spectrum analyzers with pre-selectors and quasi-peak detectors are used to perform radiated measurements.

Conducted emissions are measured with Line Impedance Stabilization Networks and EMI Test Receivers.

Calibrated wideband preamplifiers, coaxial cables, and coaxial attenuators are also used for making measurements.

All receiving equipment conforms to CISPR Publication 16-1, "Radio Interference Measuring Apparatus and Measurement Methods."

5.3 TABLE OF ACCREDITATIONS AND LISTINGS

Country	Agency	Scope of Accreditation	Logo
USA	FCC	3M Semi Anechoic Chamber (FCC MRA: TW1039) to perform FCC Part 15 measurements	 FCC MRA: TW1039
Taiwan	TAF	LP0002, RTTE01, FCC Method-47 CFR Part 15 Subpart C, D, E, RSS-210, RSS-310 IDA TS SRD, AS/NZS 4268, AS/NZS 4771, TS 12.1 & 12.2, ETSI EN 300 440-1, ETSI EN 300 440-2, ETSI EN 300 328, ETSI EN 300 220-1, ETSI EN 300 220-2, ETSI EN 301 893, ETSI EN 301 489-1/3/7/17 FCC OET Bulletin 65 + Supplement C, EN 50360, EN 50361, EN 50371, RSS 102, EN 50383, EN 50385, EN 50392, IEC 62209, CNS 14958-1, CNS 14959 FCC Method -47 CFR Part 15 Subpart B IEC / EN 61000-3-2, IEC / EN 61000-3-3, IEC / EN 61000-4-2/3/4/5/6/8/11	
Canada	Industry Canada	3M Semi Anechoic Chamber (IC 2324G-1 / IC 2324G-2) to perform	 IC 2324G-1 IC 2324G-2

** No part of this report may be used to claim or imply product endorsement by A2LA or any agency of the US Government.*



6. SETUP OF EQUIPMENT UNDER TEST

6.1 SETUP CONFIGURATION OF EUT

See test photographs attached in Appendix I for the actual connections between EUT and support equipment.

6.2 SUPPORT EQUIPMENT

No	Equipment	Trade Name	Model	Serial No.	FCC ID	Data Cable	Power Cord
	N/A	N/A	N/A	N/A	N/A	N/A	N/A

7. FCC PART 15.249 REQUIREMENTS

7.1 20 DB BANDWIDTH

LIMIT

None; for reporting purposes only.

Test Configuration

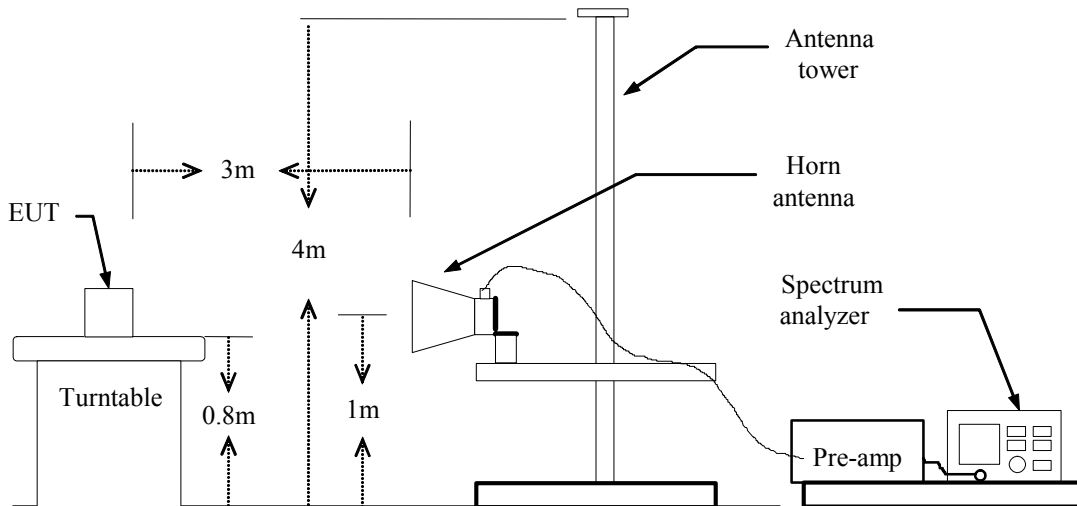

TEST PROCEDURE

1. Place the EUT on the table and set it in the transmitting mode.
2. Remove the antenna from the EUT and then connect a low loss RF cable from the antenna port to the spectrum analyzer.
3. Set the spectrum analyzer as RBW=51kHz, VBW = 160kHz, Span = 5MHz, Sweep = auto.
4. Mark the peak frequency and 20dB (upper and lower) frequency.
5. Repeat until all the rest channels are investigated.

TEST RESULTS

No non-compliance noted

Test Data

Channel	Frequency (MHz)	20dB Bandwidth (MHz)
Low	2403	1.117
Mid	2440	1.142
High	2480	1.183



Test Plot

CH Low

Agilent 11:26:17 Apr 21, 2010

R T

Δ Mkr2 1.117 MHz

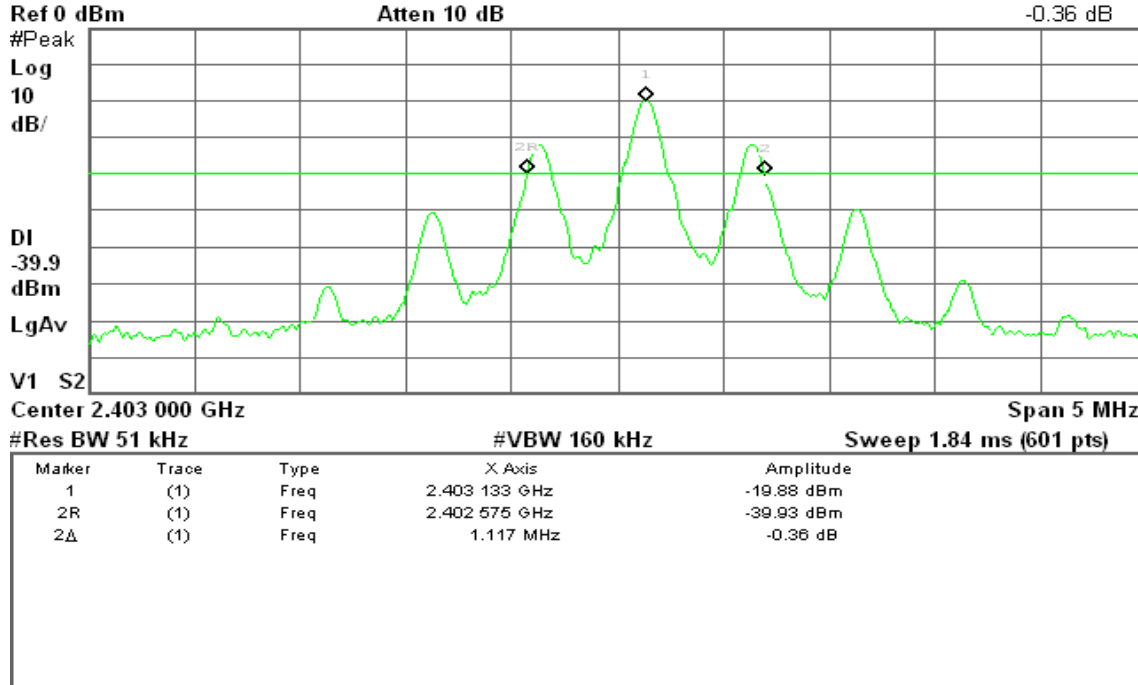

CH Mid

Agilent 11:27:00 Apr 21, 2010

R T

Δ Mkr2 1.142 MHz

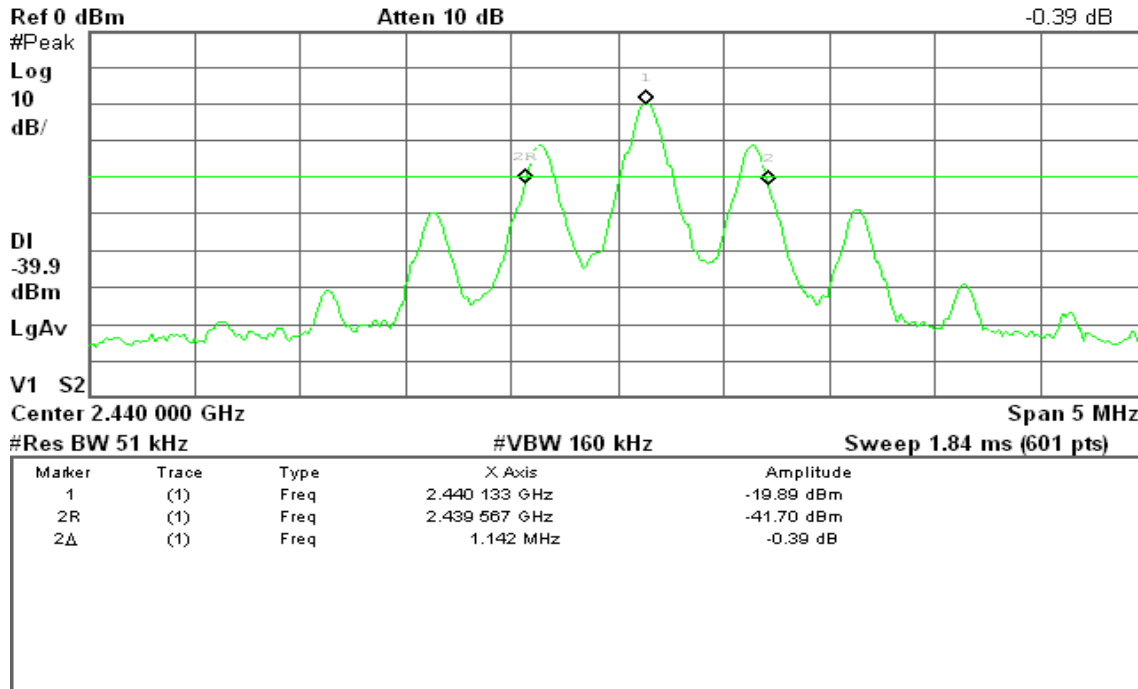



CH High

Agilent 18:11:17 Apr 22, 2010

R T

Δ Mkr2 1.183 MHz

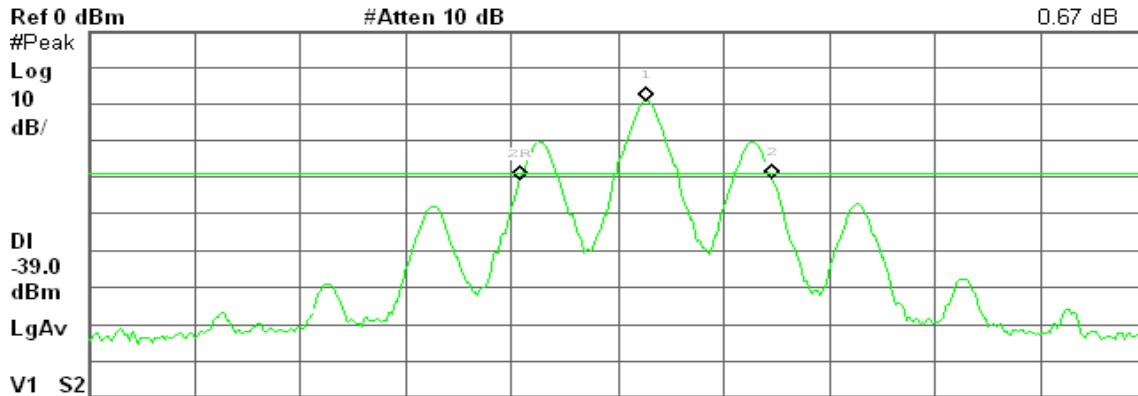

Ref 0 dBm #Atten 10 dB

Center 2.480 000 GHz Span 5 MHz

#Res BW 51 kHz #VBW 160 kHz Sweep 1.84 ms (601 pts)

Marker	Trace	Type	X Axis	Amplitude
1	(1)	Freq	2.480 133 GHz	-19.03 dBm
2R	(1)	Freq	2.479 542 GHz	-40.88 dBm
2Δ	(1)	Freq	1.183 MHz	0.67 dB

7.2 BAND EDGES MEASUREMENT

LIMIT

1. In the above emission table, the tighter limit applies at the band edges.

Frequency (MHz)	Field Strength ($\mu\text{V}/\text{m}$ at 3-meter)	Field Strength ($\text{dB}\mu\text{V}/\text{m}$ at 3-meter)
30-88	100	40
88-216	150	43.5
216-960	200	46
Above 960	500	54

2. As shown in Section 15.35(b), for frequencies above 1000 MHz, the above field strength limits in paragraphs (a) and (b) of this section are based on average limits. However, the peak field strength of any emission shall not exceed the maximum permitted average limits specified above by more than 20 dB under any condition of modulation. For point-to-point operation under paragraph (b) of this section, the peak field strength shall not exceed 2500 millivolts/meter at 3 meters along the antenna azimuth.

Test Configuration

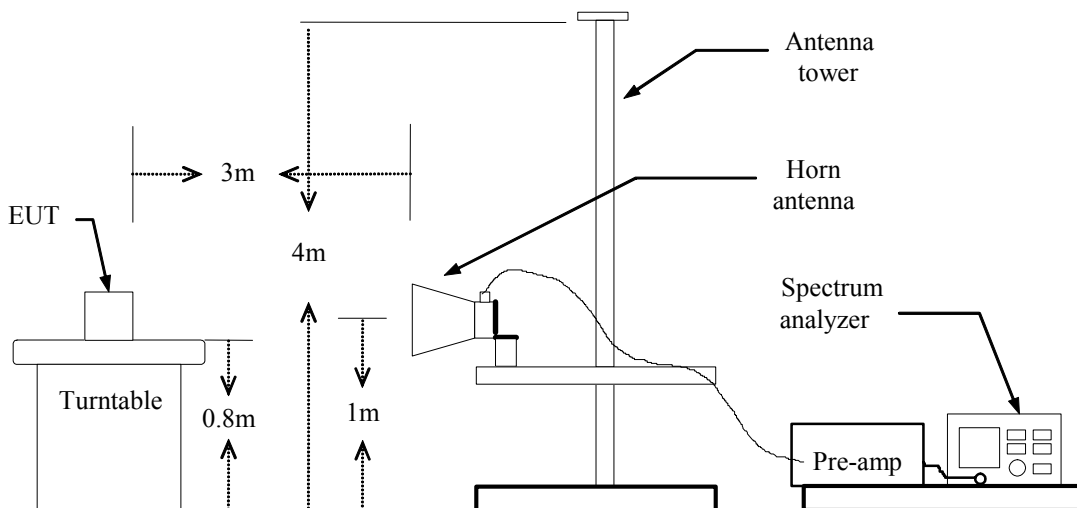

TEST PROCEDURE

1. The EUT is placed on a turntable, which is 0.8m above the ground plane.
2. The turntable shall be rotated for 360 degrees to determine the position of maximum emission level.
3. EUT is set 3m away from the receiving antenna, which is varied from 1m to 4m to find out the highest emission.
4. Set the spectrum analyzer in the following setting in order to capture the lower and upper band-edges of the emission:
 - (a) PEAK: RBW=VBW=1MHz / Sweep=AUTO
 - (b) AVERAGE: RBW=1MHz / VBW=10Hz / Sweep=AUTO
5. Repeat the procedures until all the PEAK and AVERAGE versus POLARIZATION are measured.

TEST RESULTS

Refer to attach spectrum analyzer data chart.



Band Edges (CH Low)

Detector mode: Peak

Polarity: Vertical

Agilent 11:51:35 Apr 23, 2010

T

Mkr2 2.400 00 GHz
48.41 dBμV

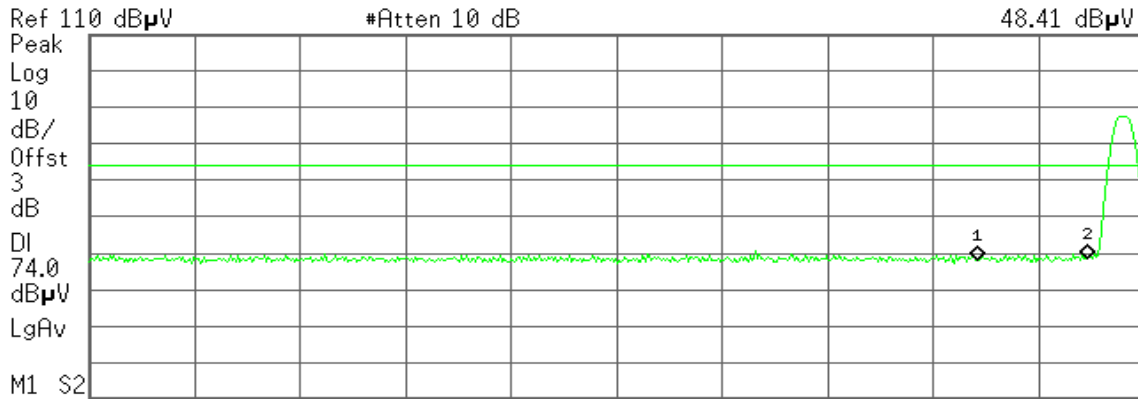

Marker	Trace	Type	X Axis	Amplitude
1	(1)	Freq	2.390 00 GHz	47.91 dBμU
2	(1)	Freq	2.400 00 GHz	48.41 dBμU

Detector mode: Average

Polarity: Vertical

Agilent 11:51:23 Apr 23, 2010

T

Mkr2 2.400 00 GHz
36.81 dBμV

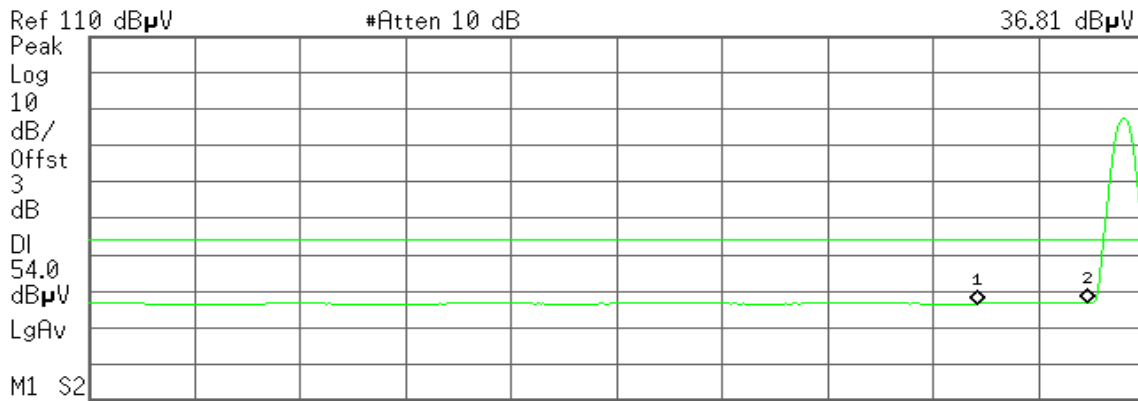

Marker	Trace	Type	X Axis	Amplitude
1	(1)	Freq	2.390 00 GHz	36.59 dBμU
2	(1)	Freq	2.400 00 GHz	36.81 dBμU



Detector mode: Peak

Polarity: Horizontal

Agilent 11:57:43 Apr 23, 2010

T

Mkr2 2.400 00 GHz
48.33 dBμV

Ref 110 dBμV

#Atten 10 dB

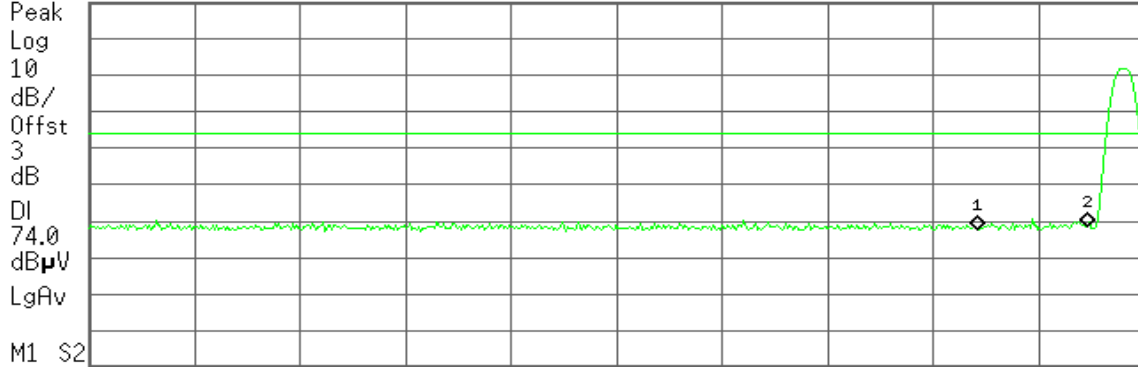

Start 2.310 00 GHz

Stop 2.405 00 GHz

#Res BW 1 MHz

#VBW 1 MHz

#Sweep 100 ms (601 pts)

Marker	Trace	Type	X Axis	Amplitude
1	(1)	Freq	2.390 00 GHz	47.83 dBμU
2	(1)	Freq	2.400 00 GHz	48.33 dBμU

Detector mode: Average

Polarity: Horizontal

Agilent 11:57:31 Apr 23, 2010

T

Mkr2 2.400 00 GHz
37.46 dBμV

Ref 110 dBμV

#Atten 10 dB

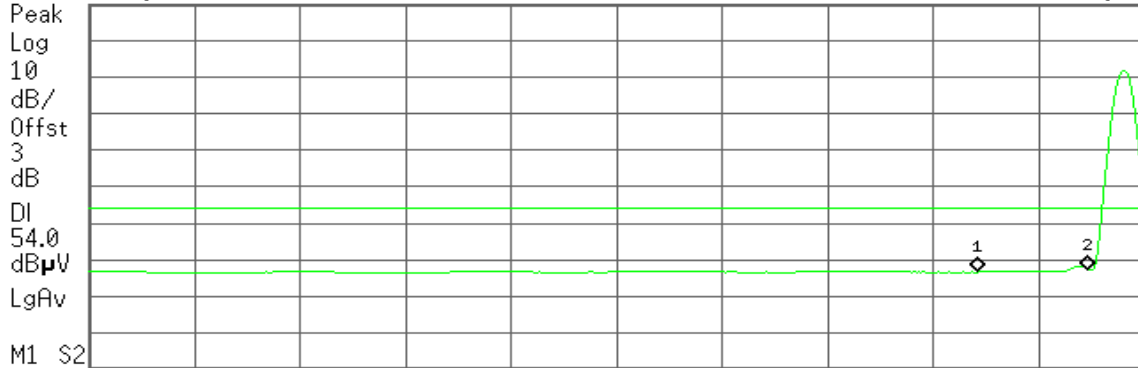

Start 2.310 00 GHz

Stop 2.405 00 GHz

#Res BW 1 MHz

#VBW 10 Hz

Sweep 7.408 s (601 pts)

Marker	Trace	Type	X Axis	Amplitude
1	(1)	Freq	2.390 00 GHz	36.61 dBμU
2	(1)	Freq	2.400 00 GHz	37.46 dBμU



Band Edges (CH High)

Detector mode: Peak

Polarity: Vertical

Agilent 11:45:43 Apr 23, 2010

T

Mkr1 2.483 50 GHz
48.84 dB μ V

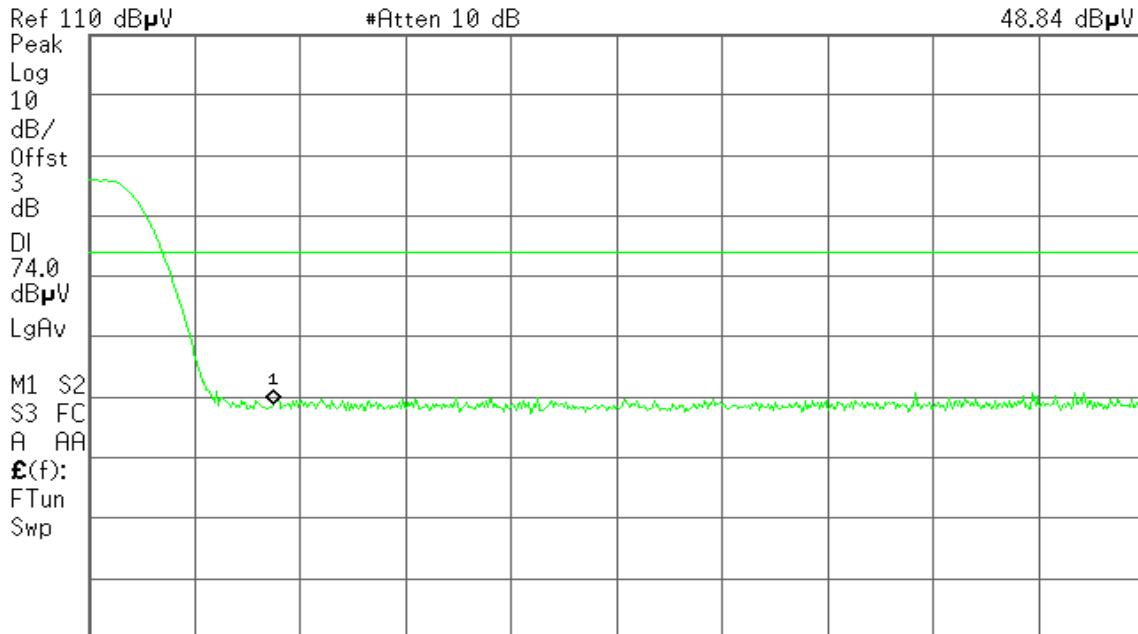

Start 2.480 00 GHz Stop 2.500 00 GHz
#Res BW 1 MHz #VBW 1 MHz #Sweep 100 ms (601 pts)

Detector mode: Average

Polarity: Vertical

Agilent 11:45:32 Apr 23, 2010

T

Mkr1 2.483 50 GHz
37.05 dB μ V

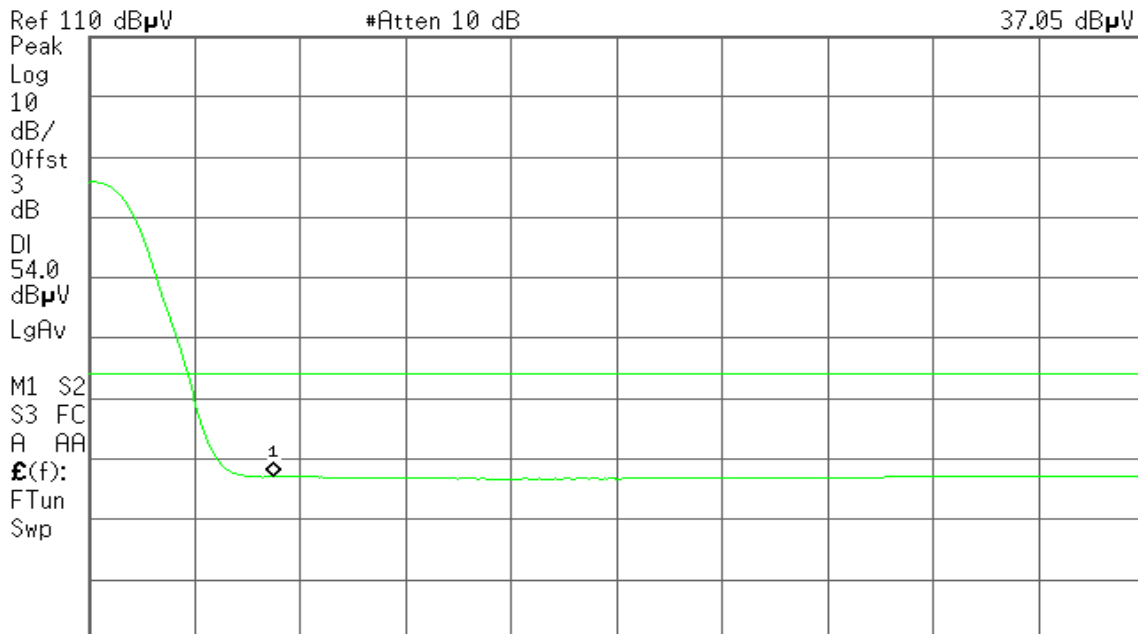

Start 2.480 00 GHz Stop 2.500 00 GHz
#Res BW 1 MHz #VBW 10 Hz Sweep 1.56 s (601 pts)



Detector mode: Peak

Polarity: Horizontal

Agilent 11:40:13 Apr 23, 2010

T

Mkr1 2.483 50 GHz
48.62 dBµV

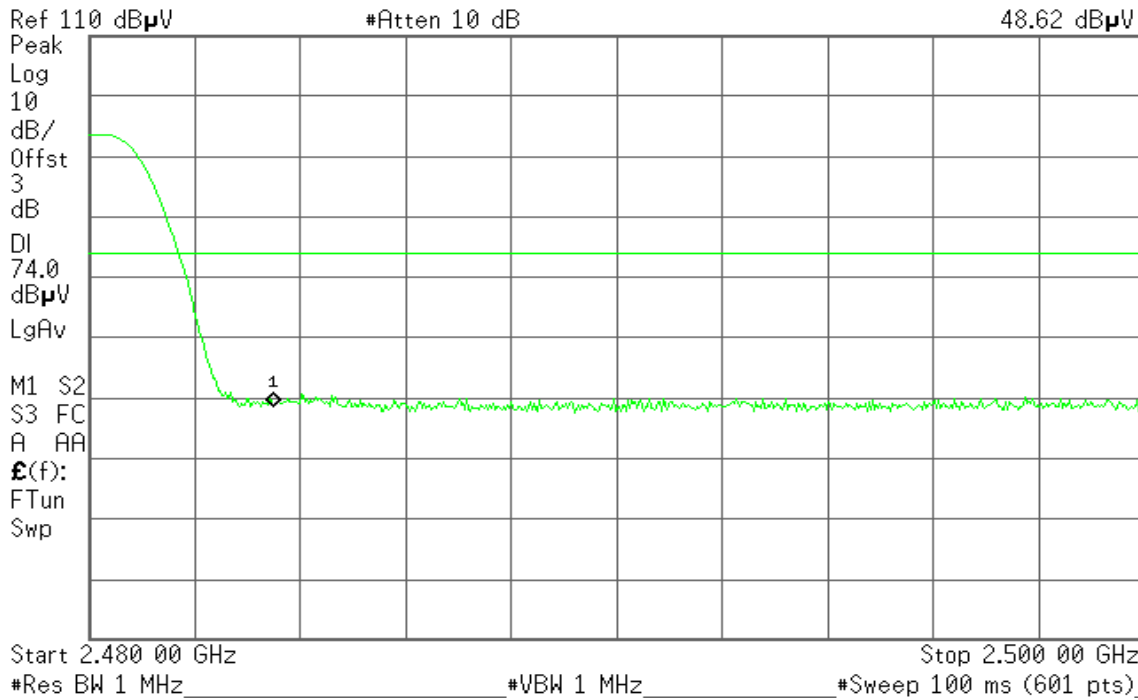

Detector mode: Average

Polarity: Horizontal

Agilent 11:39:59 Apr 23, 2010

T

Mkr1 2.483 50 GHz
37.65 dBµV

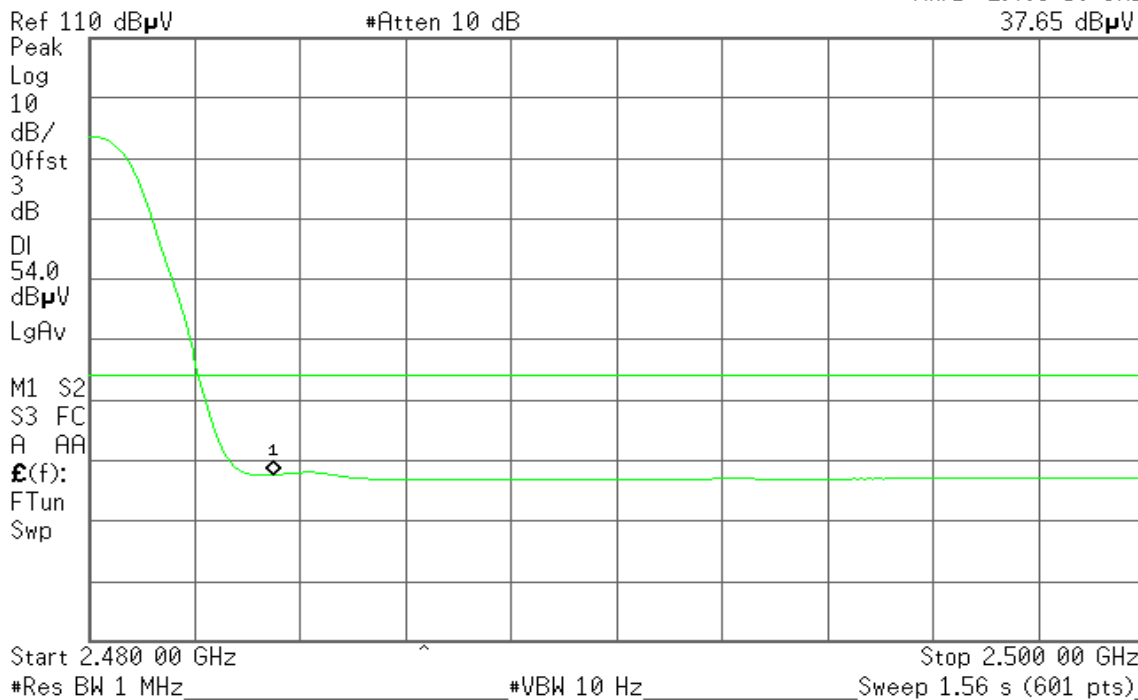



7.3 SPURIOUS EMISSION

LIMIT

1. In the section 15.249(a):

Except as provided in paragraph (b) of this section, the field strength of emissions from intentional radiators operated within these frequency bands shall comply with the following:

Fundamental Frequency (MHz)	Field Strength of Fundamental Field Strength (mV/m)	Field Strength of Harmonics (µV/m)
902-928 MHz	50	500
2400 - 2483.5 MHz	50	500
5725 - 5875 MHz	50	500
24.0 - 24.25 GHz	250	2500

2. Except as provided elsewhere in this Subpart, the emissions from an intentional radiator shall not exceed the field strength levels specified in the following table:

Frequency (MHz)	Field Strength (µV/m)	Measurement Distance (m)
30-88	100*	3
88-216	150*	3
216-960	200*	3
Above 960	500	3

Remark: Except as provided in paragraph (g), fundamental emissions from intentional radiators operating under this Section shall not be located in the frequency bands 54-72 MHz, 76-88 MHz, 174-216 MHz or 470-806 MHz. However, operation within these frequency bands is permitted under other sections of this Part, e.g., Sections 15.231 and 15.241.

3. In the above emission table, the tighter limit applies at the band edges.

Frequency (MHz)	Field Strength (µV/m at 3-meter)	Field Strength (dBµV/m at 3-meter)
30-88	100	40
88-216	150	43.5
216-960	200	46
Above 960	500	54

Test Configuration

9kHz ~ 30MHz

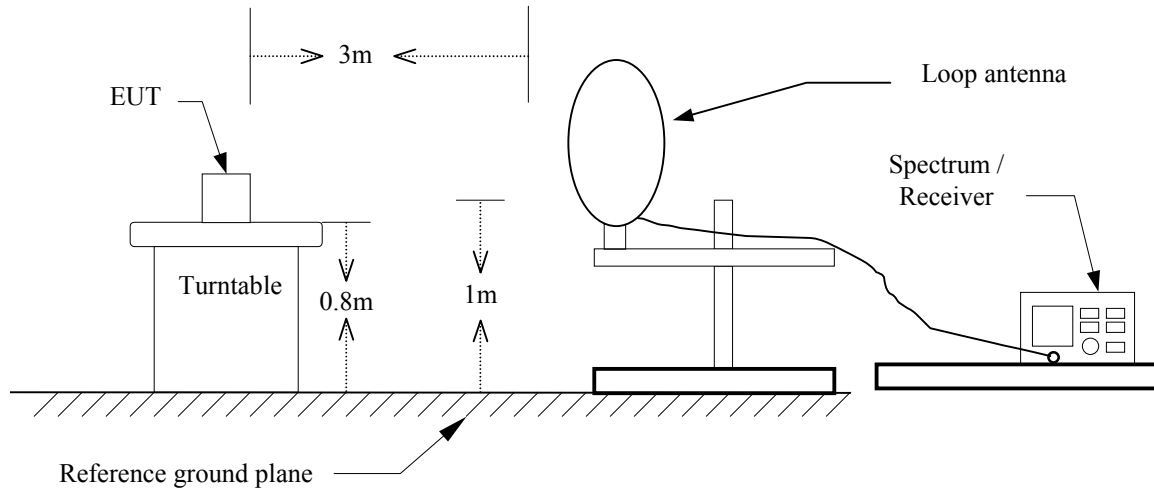

30MHz ~ 1GHz

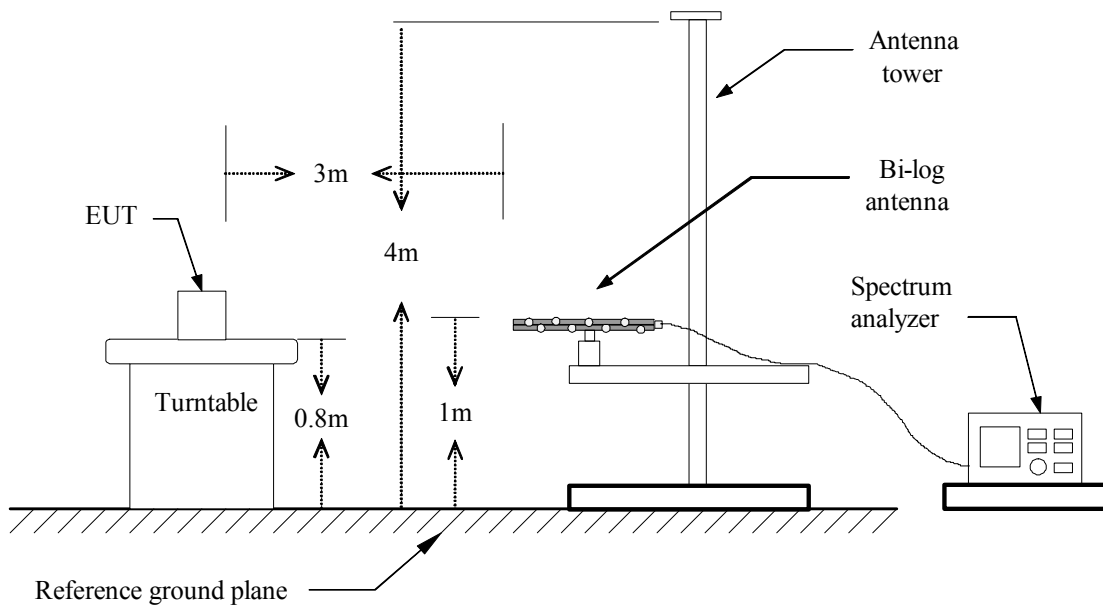



Above 1 GHz

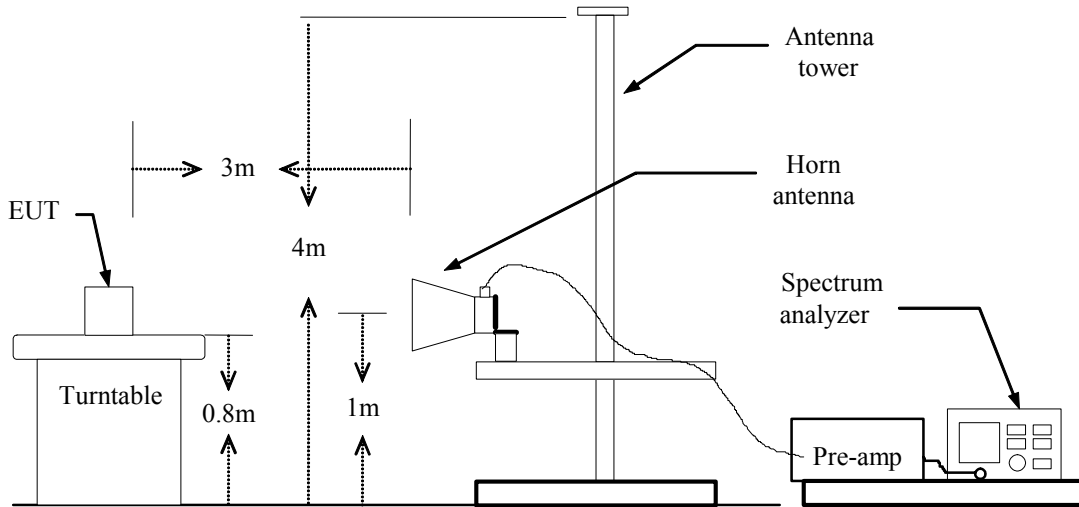



TEST PROCEDURE

1. The EUT is placed on a turntable, which is 0.8m above ground plane.
2. The turntable shall be rotated for 360 degrees to determine the position of maximum emission level.
3. EUT is set 3m away from the receiving antenna, which is varied from 1m to 4m to find out the highest emissions.
4. Maximum procedure was performed on the six highest emissions to ensure EUT compliance.
5. And also, each emission was to be maximized by changing the polarization of receiving antenna both horizontal and vertical.
6. Set the spectrum analyzer in the following setting as:
Below 1GHz:
RBW=100kHz / VBW=300kHz / Sweep=AUTO
Above 1GHz:
(a) PEAK: RBW=VBW=1MHz / Sweep=AUTO
(b) AVERAGE: RBW=1MHz / VBW=10Hz / Sweep=AUTO
7. Repeat above procedures until the measurements for all frequencies are complete.



Below 1 GHz

Operation Mode: Normal Link

Test Date: April 12, 2010

Temperature: 23°C

Tested by: Mimic Yang

Humidity: 53% RH

Polarity: Ver. / Hor.

Frequency (MHz)	Ant.Pol. (H/V)	Detector Mode (PK/QP)	Reading (dBuV)	Correction Factor (dB/m)	Result (dBuV/m)	Limit 3m (dBuV/m)	Margin (dB)
96.28	V	Peak	36.71	-13.95	22.76	43.50	-20.74
135.08	V	Peak	32.83	-9.82	23.02	43.50	-20.48
243.40	V	Peak	35.33	-11.03	24.31	46.00	-21.69
296.75	V	Peak	36.66	-9.27	27.39	46.00	-18.61
405.07	V	Peak	34.83	-6.97	27.87	46.00	-18.13
647.57	V	Peak	32.68	-2.95	29.73	46.00	-16.27
96.28	H	Peak	33.86	-13.95	19.91	43.50	-23.59
135.08	H	Peak	26.92	-9.82	17.10	43.50	-26.40
243.40	H	Peak	28.56	-11.03	17.53	46.00	-28.47
296.75	H	Peak	32.46	-9.27	23.19	46.00	-22.81
448.72	H	Peak	26.42	-5.89	20.53	46.00	-25.47
686.37	H	Peak	25.49	-2.64	22.85	46.00	-23.15

Remark:

1. No emission found between lowest internal used/generated frequency to 30MHz (9kHz~30MHz).
2. Radiated emissions measured were made with an instrument using peak/quasi-peak detector mode.
3. Quasi-peak test would be performed if the peak result were greater than the quasi-peak limit or as required by the applicant.
4. Measurements above show only up to 6 maximum emissions noted, or would be lesser; with " N/A " remark, if no specific emissions from the EUT are recorded (ie: margin>20dB from the applicable limit) and considered that's already beyond the background noise floor.
5. Margin (dB) = Remark result (dBuV/m) – Quasi-peak limit (dBuV/m).



Above 1 GHz

Operation Mode: Tx / CH Low

Test Date: April 23, 2010

Temperature: 23°C

Tested by: Mimic Yang

Humidity: 53% RH

Polarity: Ver. / Hor.

Freq. (MHz)	Ant. Pol H/V	Peak Reading (dBuV)	AV Reading (dBuV)	Ant. / CL CF (dB)	Result		Peak Limit (dBuV/m)	AV Limit (dBuV/m)	Margin (dB)	Remark
					Peak (dBuV/m)	AV (dBuV/m)				
2403.33	V	90.68	90.56	-2.95	87.73	87.61	114.00	94.00	-6.39	AVG
1526.67	V	54.18	---	-8.51	45.67	---	74.00	54.00	-8.33	Peak
4808.33	V	55.05	51.49	1.18	56.23	52.67	74.00	54.00	-1.33	AVG
N/A										
2403.33	H	95.01	94.69	-2.95	92.06	91.74	114.00	94.00	-2.26	AVG
1476.67	H	54.29	---	-8.80	45.49	---	74.00	54.00	-8.51	Peak
N/A										

Remark:

1. Measuring frequencies from 1 GHz to the 10th harmonic of highest fundamental frequency.
2. Radiated emissions measured in frequency above 1000MHz were made with an instrument using peak/average detector mode.
3. Average test would be performed if the peak result were greater than the average limit or as required by the applicant.
4. Data of measurement within this frequency range shown " --- " in the table above means the reading of emissions are attenuated more than 20dB below the permissible limits or the field strength is too small to be measured.
5. Measurements above show only up to 6 maximum emissions noted, or would be lesser; with " N/A " remark, if no specific emissions from the EUT are recorded (ie: margin > 20dB from the applicable limit) and considered that's already beyond the background noise floor.
6. Margin (dB) = Remark result (dBuV/m) – Average limit (dBuV/m). Peak detector mode and average detector mode of the emission shown in Result column.



Operation Mode: Tx / CH Mid

Test Date: April 23, 2010

Temperature: 23°C

Tested by: Mimic Yang

Humidity: 53% RH

Polarity: Ver. / Hor.

Freq. (MHz)	Ant. Pol H/V	Peak Reading (dBuV)	AV Reading (dBuV)	Ant. / CL CF (dB)	Result		Peak Limit (dBuV/m)	AV Limit (dBuV/m)	Margin (dB)	Remark
					Peak (dBuV/m)	AV (dBuV/m)				
2440.00	V	89.02	88.54	-2.84	86.18	85.70	114.00	94.00	-8.30	AVG
1593.33	V	54.15	---	-7.90	46.25	---	74.00	54.00	-7.75	Peak
4883.33	V	53.22	50.99	1.16	54.37	52.15	74.00	54.00	-1.85	AVG
N/A										
2440.00	H	95.53	95.40	-2.84	92.69	92.56	114.00	94.00	-1.44	AVG
1526.67	H	53.99	---	-8.51	45.48	---	74.00	54.00	-8.52	Peak
4883.33	H	50.03	---	1.16	51.19	---	74.00	54.00	-2.81	Peak
N/A										

Remark:

1. Measuring frequencies from 1 GHz to the 10th harmonic of highest fundamental frequency.
2. Radiated emissions measured in frequency above 1000MHz were made with an instrument using peak/average detector mode.
3. Average test would be performed if the peak result were greater than the average limit or as required by the applicant.
4. Data of measurement within this frequency range shown " --- " in the table above means the reading of emissions are attenuated more than 20dB below the permissible limits or the field strength is too small to be measured.
5. Measurements above show only up to 6 maximum emissions noted, or would be lesser, with " N/A " remark, if no specific emissions from the EUT are recorded (ie: margin>20dB from the applicable limit) and considered that's already beyond the background noise floor.
6. Margin (dB) = Remark result (dBuV/m) – Average limit (dBuV/m). Peak detector mode and average detector mode of the emission shown in Result column.



Operation Mode: Tx / CH High

Test Date: April 23, 2010

Temperature: 23°C

Tested by: Mimic Yang

Humidity: 53% RH

Polarity: Ver. / Hor.

Freq. (MHz)	Ant. Pol H/V	Peak Reading (dBuV)	AV Reading (dBuV)	Ant. / CL CF (dB)	Result		Peak Limit (dBuV/m)	AV Limit (dBuV/m)	Margin (dB)	Remark
					Peak (dBuV/m)	AV (dBuV/m)				
2480.00	V	91.01	90.76	-2.72	88.29	88.04	114.00	94.00	-5.99	AVG
1556.67	V	58.26	---	-8.24	50.02	---	74.00	54.00	-3.98	Peak
4958.33	V	53.19	47.57	1.13	54.32	48.70	74.00	54.00	-5.30	AVG
N/A										
2480.00	H	95.38	95.18	-2.72	92.66	92.46	114.00	94.00	-1.54	AVG
1610.00	H	57.21	---	-7.75	49.47	---	74.00	54.00	-4.53	Peak
4958.33	H	53.26	45.95	1.13	54.39	47.08	74.00	54.00	-6.92	AVG
N/A										

Remark:

1. Measuring frequencies from 1 GHz to the 10th harmonic of highest fundamental frequency.
2. Radiated emissions measured in frequency above 1000MHz were made with an instrument using peak/average detector mode.
3. Average test would be performed if the peak result were greater than the average limit or as required by the applicant.
4. Data of measurement within this frequency range shown " --- " in the table above means the reading of emissions are attenuated more than 20dB below the permissible limits or the field strength is too small to be measured.
5. Measurements above show only up to 6 maximum emissions noted, or would be lesser; with " N/A " remark, if no specific emissions from the EUT are recorded (ie: margin>20dB from the applicable limit) and considered that's already beyond the background noise floor.
6. Margin (dB) = Remark result (dBuV/m) – Average limit (dBuV/m). Peak detector mode and average detector mode of the emission shown in Result column.



7.4 POWERLINE CONDUCTED EMISSIONS

LIMIT

According to §15.207(a), except as shown in paragraphs (b) and (c) of this section, for an intentional radiator that is designed to be connected to the public utility (AC) power line, the radio frequency voltage that is conducted back onto the AC power line on any frequency or frequencies within the band 150 kHz to 30 MHz shall not exceed the limits in the following table, as measured using a 50 μH/50 ohms line impedance stabilization network (LISN). Compliance with the provisions of this paragraph shall be based on the measurement of the radio frequency voltage between each power line and ground at the power terminal. The lower limit applies at the boundary between the frequency ranges.

Frequency Range (MHz)	Limits (dBμV)	
	Quasi-peak	Average
0.15 to 0.50	66 to 56*	56 to 46*
0.50 to 5	56	46
5 to 30	60	50

* Decreases with the logarithm of the frequency.

Test Configuration

See test photographs attached in Appendix I for the actual connections between EUT and support equipment.

TEST PROCEDURE

1. The EUT was placed on a table, which is 0.8m above ground plane.
2. Maximum procedure was performed on the six highest emissions to ensure EUT compliance.
3. Repeat above procedures until all frequency measured were complete.

TEST RESULTS

Not applicable, because EUT does not connect to AC Main Source.