



INSIGNIA

QUICK SETUP GUIDE

Wireless Keyboard and Mouse Combo

NS-PNC7011

PACKAGE CONTENTS

- Wireless keyboard
- AA battery (1)
- Wireless mouse
- AAA batteries (2)
- Nano receiver
- Quick Setup Guide

SYSTEM REQUIREMENTS

- Windows® 10, Windows® 8.1, Windows® 8, Windows® 7, or Mac OS 10.X or higher
- One available USB port

Before using your new product, please read these instructions to prevent any damage.

MOUSE FEATURES

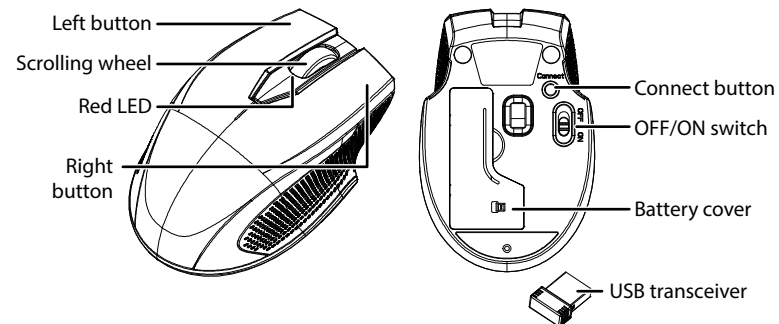

INSTALLING THE MOUSE BATTERIES AND REMOVING THE NANO RECEIVER

- 1 Take the battery cover off.
- 2 Remove the nano receiver.

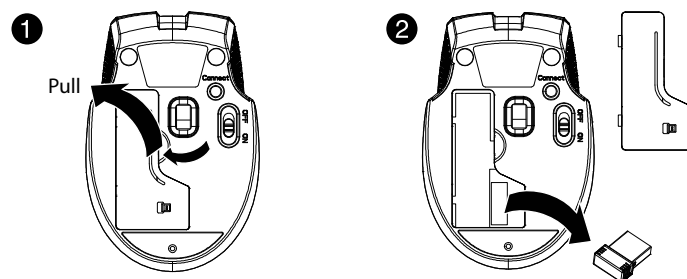

- 3 Insert the included AA battery into the battery compartment. Make sure that the + and - signs match the symbols in the compartment.

- 4 Replace the battery cover.

Tip: Store the nano receiver in the mouse when it is not in use.

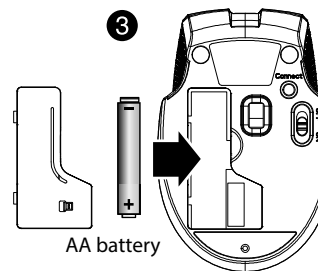

KEYBOARD FEATURES

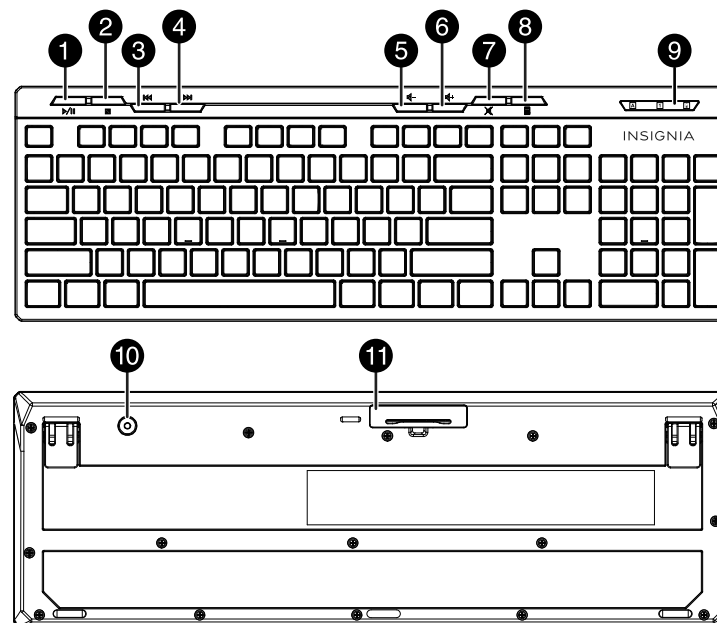

Final flat size: 419.1 × 148.08 mm
Final fold size: 104.775 × 148.08 mm



#	ICON	ITEM	DESCRIPTION
1	▶/	Play/Pause	Press to play or pause media.
2	■	Stop	Press to stop playing media.
3	◀◀	Previous	Press to select the previous media track.
4	▶▶	Next	Press to select the next media track.
5	◀-	Volume down	Press to decrease the computer's volume.
6	▶+	Volume up	Press to increase the computer's volume.
7	✖	Mute	Press to turn off the computer's sound.
8	🧮	Calculator	Press to launch the Microsoft calculator.
9	LED indicator		Cap lock , Num lock, Low battery warning and pairing.
10	Connect button		Press to initiate pairing with your computer.
11	Battery cover		Remove to install or replace the batteries.





INSTALLING THE KEYBOARD BATTERIES

- 1 Take the battery cover off.
- 2 Insert two AAA batteries (included) into the battery compartment. Make sure that the + and - signs match the symbols in the compartment.
- 3 Replace the cover.

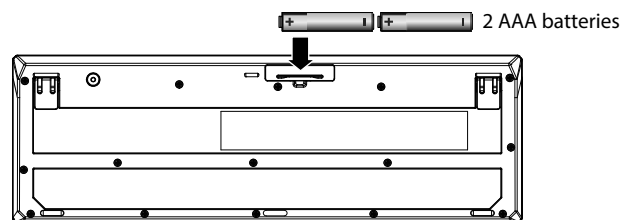

CONNECTING YOUR MOUSE AND KEYBOARD TO YOUR COMPUTER

- 1 Plug the nano receiver into the USB port on your computer.
- 2 Slide the ON/OFF switch on your mouse to **ON**. The computer automatically detects the mouse and keyboard and you can immediately begin using them.

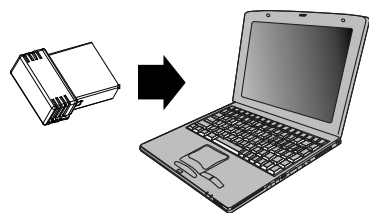

If the mouse or keyboard does not work:

- Re-plug the nano receiver into the USB port on your computer, then press the connect button on the mouse and keyboard. The LED indicators on the mouse and keyboard flash steadily while in pairing mode (10 seconds). After pairing successfully, the LED turns off.
- Check the batteries in your mouse or keyboard. The LED indicators blink for 10 seconds when the batteries are low.



LED INDICATORS

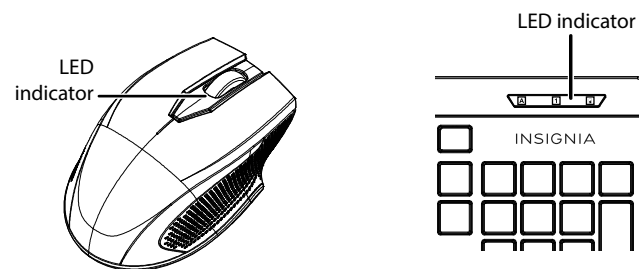

FUNCTION	DESCRIPTION
Power ON	Red LED is on for 10 seconds, then turns off.
Low battery warning	Red LED blinks for 10 seconds.
Pairing	Red LED blinks for 10 seconds after pressing the Connect button.
Pairing failed	After pressing the Connect button, the LED blinks, then lights solid for 10 seconds.
Paired successfully	After pressing the Connect button, the LED blinks for 10 seconds, then turns off.

CLEANING YOUR MOUSE AND KEYBOARD

- Wipe the mouse and keyboard with a damp, lint-free cloth.

SPECIFICATIONS

Keyboard:

- Dimension (HxWxD): 5.6 × .8 × 17.1 in. (14.3 × 2.06 × 43.4 cm)
- Weight: 16.9 oz. (.5 kg)
- Rating: 3V C.C. - 4mA
- Radio frequency: 2.4Ghz
- Operating distance: 33 feet (10 meters)
- Key number: 104 keys (US)
- Battery: 2 AAA alkaline batteries
- Battery life: 6 months (based on average usage)

Mouse:

- Dimensions (HxWxD): 1.43 × 2.57 × 3.85 in. (3.64 × 6.53 × 9.78 cm)
- Weight: 1.86 oz. (.05 kg)
- Battery: 1 AA alkaline battery
- Battery life: 6 months (based on average usage)
- Radio frequency: 2.4Ghz
- Operating distance: 33 feet (10 meters)
- Rating: 1.5V C.C. - 10mA

Nano receiver:

- Dimension (HxWxD): .6 × .2 × .7 in. (1.4 × .6 × 1.8 cm)
- Weight: .04 oz. (.001 kg)
- Interface: USB 1.1, 2.0, 3.0

TROUBLESHOOTING

My mouse or keyboard is not working.

- Make sure that your mouse and keyboard are turned on.
- Move your keyboard and mouse closer to your computer.
- Make sure that your computer meets the system requirements.
- Only use the mouse on a clean, flat, non-slippery surface to ensure smooth and accurate cursor action.
- Avoid using your mouse on reflective, transparent, or metallic surfaces.
- Make sure that your mouse or keyboard and nano receiver are paired by pressing the connect button on the mouse or keyboard.
- Replace the mouse or keyboard batteries.
- Try connecting your nano receiver into a different USB port on your computer.
- Try removing or moving other wireless devices near the computer to prevent interference.

If your mouse pointer is too sensitive, or not sensitive enough, or your scrolling wheel needs adjustment, do the following:

- Go to **Control Panel > Hardware and Sound > Mouse** (Windows 7), **PC Settings > PC and Devices** (Windows 8) or **System Preferences > Mouse** (Mac) and adjusting the cursor or scrolling wheel settings.

LEGAL NOTICES

FCC Statement

This device complies with Part 15 of the FCC Rules. Operation is subject to the following two conditions: (1) this device may not cause harmful interference, and (2) this device must accept any interference received, including interference that may cause undesired operation.

This equipment has been tested and found to comply with the limits for a Class B digital device, pursuant to Part 15 of the FCC Rules. These limits are designed to provide reasonable protection against harmful interference in a residential installation. This equipment generates, uses and can radiate radio frequency energy and, if not installed and used in accordance with the instructions, may cause harmful interference to radio communications. However, there is no guarantee that interference will not occur in a particular installation. If this equipment does cause harmful interference to radio or television reception, which can be determined by turning the equipment off and on, the user is encouraged to try to correct the interference by one or more of the following measures:

- Reorient or relocate the receiving antenna.
- Increase the separation between the equipment and receiver.
- Connect the equipment into an outlet on a circuit different from that to which the receiver is connected.
- Consult the dealer or an experienced radio/TV technician for help.

Warning: Changes or modifications not expressly approved by the party responsible for compliance could void the user's authority to operate the equipment.

RSS-Gen and RSS-210 statement

This device complies with Industry Canada license-exempt RSS standard(s).

Operation is subject to the following two conditions: (1) this device may not cause interference, and (2) this device must accept any interference, including interference that may cause undesired operation of the device.

Le présent appareil est conforme aux CNR d'Industrie Canada applicables aux appareils radio exempts de licence.

L'exploitation est autorisée aux deux conditions suivantes : (1) l'appareil ne doit pas produire de brouillage, et (2) l'utilisateur de l'appareil doit accepter tout brouillage radioélectrique subi, même si le brouillage est susceptible d'en compromettre le fonctionnement.

RSS-102 statement

This equipment complies with Industry Canada radiation exposure limits set forth for an uncontrolled environment.

Cet équipement est conforme à l'exposition aux rayonnements Industry Canada limites établies pour un environnement non contrôlé.

ONE-YEAR LIMITED WARRANTY

For complete warranty, visit www.insigniaproducts.com.

CONTACT INSIGNIA

1-877-467-4289 (U.S. and Canada) or 01-800-926-3000 (Mexico)
www.insigniaproducts.com

INSIGNIA is a trademark of Best Buy and its affiliated companies

Distributed by Best Buy Purchasing, LLC

7601 Penn Ave South, Richfield, MN 55423 U.S.A.

©2016 Best Buy. All rights reserved.

Made in China

