

FCC Test Report

FCC ID : PRDKB14
Equipment : HP Wireless Keyboard K2500
Model No. : KBIM, K2BM
Brand Name : ACROX, HP
Applicant : ACROX Technologies Co., Ltd.
Address : 4F., No.89, Minshan St., Neihu Dist., Taipei City
114
Standard : 47 CFR FCC Part 15.249
Received Date : Mar. 31, 2014
Tested Date : Apr. 02, 2014

We, International Certification Corp., would like to declare that the tested sample has been evaluated and in compliance with the requirement of the above standards. The test results contained in this report refer exclusively to the product. It may be duplicated completely for legal use with the approval of the applicant. It shall not be reproduced except in full without the written approval of our laboratory.

Approved & Reviewed by:

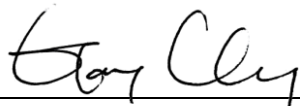

Gary Chang / Manager



Testing Laboratory
2732

Table of Contents

1	GENERAL DESCRIPTION	5
1.2	Local Support Equipment List	6
1.3	Test Setup Chart	6
1.4	The Equipment List	7
1.5	Test Standards	8
1.6	Measurement Uncertainty	8
2	TEST CONFIGURATION	9
2.1	Testing Condition	9
2.2	The Worst Test Modes and Channel Details	9
3	TRANSMITTER TEST RESULTS.....	10
3.1	Radiated Emission	10
3.2	20dB and Occupied Bandwidth	22
4	TEST LABORATORY INFORMATION	23

Release Record

Report No.	Version	Description	Issued Date
FR433104	Rev. 01	Initial issue	Apr. 14, 2014

Summary of Test Results

FCC Rules	Test Items	Measured	Result
15.207	AC Power Line Conducted Emissions	N/A	N/A
15.249(a)	Field Strength of Fundamental	Meet the requirement of limit	Pass
15.249(a)(d)	Field Strength of Harmonics and Emissions Radiated outside of the Specified Frequency Bands	Meet the requirement of limit	Pass
15.215(c)	20dB bandwidth	Meet the requirement of limit	Pass
15.203	Antenna Requirement	Meet the requirement of limit	Pass
Note: AC power line conducted emissions test is not performed since the EUT consumes DC power from battery.			

1 General Description

1.1.1 Product Details

The following brands are provided to this EUT.

Brand Name	Model Name	Product Name	Description
ACROX	KBIM, K2BM	HP Wireless Keyboard K2500	Marketing purpose
HP			

1.1.2 Specification of the Equipment under Test (EUT)

RF General Information				
Frequency Range (MHz)	Modulation	Ch. Freq. (MHz)	Channel Number	Channel Bandwidth (MHz)
2400-2483.5	FSK	2408-2474	1-34 [34]	2

1.1.3 Antenna Details

Ant. No.	Type	Gain (dBi)	Connector
1	PCB	-1.5532	N/A

1.1.4 EUT Operational Condition

Power Supply Type	3Vdc from battery.
--------------------------	--------------------

Note: The equipment tests are performed using a new battery.

1.1.5 Accessories

N/A

1.1.6 Channel List

Frequency band (MHz)				2400~2483.5			
Channel	Frequency (MHz)	Channel	Frequency (MHz)	Channel	Frequency (MHz)	Channel	Frequency (MHz)
1	2408	10	2426	19	2444	28	2462
2	2410	11	2428	20	2446	29	2464
3	2412	12	2430	21	2448	30	2466
4	2414	13	2432	22	2450	31	2468
5	2416	14	2434	23	2452	32	2470
6	2418	15	2436	24	2454	33	2472
7	2420	16	2438	25	2456	34	2474
8	2422	17	2440	26	2458	-	-
9	2424	18	2442	27	2460	-	-

1.2 Local Support Equipment List

Support Equipment List						
No.	Equipment	Brand	Model	S/N	FCC ID	Signal cable / Length (m)
1	---	---	---	---	---	---

1.3 Test Setup Chart

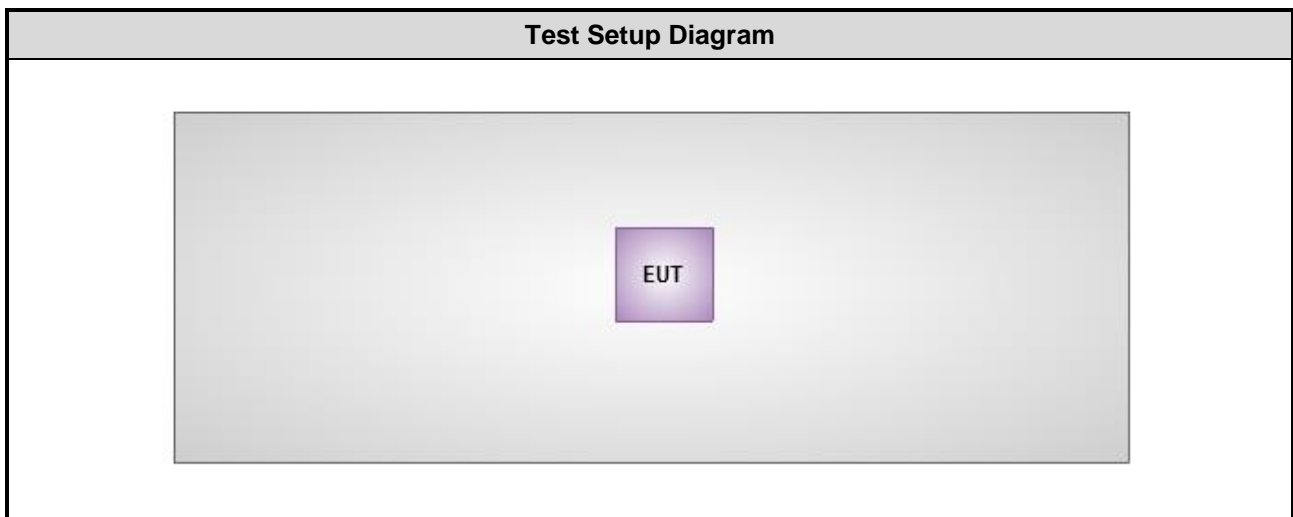

1.4 The Equipment List

Test Item	Radiated Emission				
Test Site	966 chamber1 / (03CH01-WS)				
Instrument	Manufacturer	Model No.	Serial No.	Calibration Date	Calibration Until
Spectrum Analyzer	R&S	FSV40	101498	Jan. 25, 2014	Jan. 24, 2015
Receiver	R&S	ESR3	101658	Jan. 10, 2014	Jan. 09, 2015
Bilog Antenna	SCHWARZBECK	VULB9168	VULB9168-522	Jan. 02, 2014	Jan. 01, 2015
Horn Antenna 1G-18G	SCHWARZBECK	BBHA 9120 D	BBHA 9120 D 1096	Feb. 13, 2014	Feb. 12, 2015
Horn Antenna 18G-40G	SCHWARZBECK	BBHA 9170	BBHA 9170517	Dec. 27, 2013	Dec. 26, 2014
Preamplifier	Burgeon	BPA-530	SN:100219	Nov. 28, 2013	Nov. 27, 2014
Preamplifier	Agilent	83017A	MY39501308	Dec. 16, 2013	Dec. 15, 2014
Preamplifier	EM	EM18G40G	060572	Jun. 20, 2013	Jun. 19, 2014
RF Cable	HUBER+SUHNER	SUCOFLEX104	MY16014/4	Dec. 16, 2013	Dec. 15, 2014
RF Cable	HUBER+SUHNER	SUCOFLEX104	MY16019/4	Dec. 16, 2013	Dec. 15, 2014
RF Cable	HUBER+SUHNER	SUCOFLEX104	MY16139/4	Dec. 16, 2013	Dec. 15, 2014
LF cable 3M	Woken	CFD400NL-LW	CFD400NL-001	Dec. 16, 2013	Dec. 15, 2014
LF cable 10M	Woken	CFD400NL-LW	CFD400NL-002	Dec. 16, 2013	Dec. 15, 2014
Note: Calibration Interval of instruments listed above is one year.					

Loop Antenna	R&S	HFH2-Z2	100330	Nov. 15, 2012	Nov. 14, 2014
Note: Calibration Interval of instruments listed above is two year.					

Test Item	RF Conducted				
Test Site	(TH01-WS)				
Instrument	Manufacturer	Model No.	Serial No.	Calibration Date	Calibration Until
Spectrum Analyzer	R&S	FSV40	101063	Feb. 17, 2014	Feb. 16, 2015
Note: Calibration Interval of instruments listed above is one year.					

1.5 Test Standards

According to the specification of EUT, the EUT must comply with following standards and KDB documents.

47 CFR FCC Part 15.249

ANSI C63.10-2009

Note: The EUT has been tested and complied with FCC part 15B requirement. FCC Part 15B test results are issued to another report.

1.6 Measurement Uncertainty

ISO/IEC 17025 requires that an estimate of the measurement uncertainties associated with the emissions test results be included in the report. The measurement uncertainties given below are based on a 95% confidence level (based on a coverage factor $k=2$)

Measurement Uncertainty	
Parameters	Uncertainty
AC conducted emission	± 2.43 dB
Radiated emission	± 2.49 dB

2 Test Configuration

2.1 Testing Condition

Test Item	Test Site	Ambient Condition	Tested By
Radiated Emissions	03CH01-WS	21°C / 63%	Brad Wu
RF Conducted	TH01-WS	21°C / 63%	Brad Wu

➤ FCC site registration No.: 657002

➤ IC site registration No.: 10807A-1

2.2 The Worst Test Modes and Channel Details

Test item	Mode	Test Frequency (MHz)	Test Configuration
Field Strength of Fundamental	GFSK	2408, 2440, 2480	---
Radiated Emissions (below 1GHz)	GFSK	2440	---
Radiated Emissions (Above 1GHz)	GFSK	2408, 2440, 2480	---
20dB bandwidth	GFSK	2408, 2440, 2480	---

3 Transmitter Test Results

3.1 Radiated Emission

This section includes field strength of fundamental, field strength of harmonics and emissions radiated outside of the operating frequency bands.

3.1.1 Limit of field strength of fundamental and field strength of harmonics

Fundamental Frequency	Field strength of fundamental (millivolts/meter)	Field strength of harmonics (microvolts/meter)
902–928 MHz	50	50
2400–2483.5 MHz	50	500
5725–5875 MHz	50	500
24.0–24.25 GHz	250	2500

3.1.2 Limit of Unwanted Emissions

Emissions radiated outside of the specified frequency bands, except for harmonics, shall be attenuated by at least 50 dB below the level of the fundamental or to the general radiated emission limits in §15.209, whichever is the lesser attenuation.

Radiated emission limits in §15.209			
Frequency Range (MHz)	Field Strength (uV/m)	Field Strength (dBuV/m)	Measure Distance (m)
0.009~0.490	2400/F(kHz)	48.5 - 13.8	300
0.490~1.705	24000/F(kHz)	33.8 - 23	30
1.705~30.0	30	29	30
30~88	100	40	3
88~216	150	43.5	3
216~960	200	46	3
Above 960	500	54	3

Note 1:
Qusai-Peak value is measured for frequency below 1GHz except for 9–90 kHz, 110–490 kHz frequency band. Peak and average value are measured for frequency above 1GHz. The limit on average radio frequency emission is as above table. The limit on peak radio frequency emissions is 20 dB above the maximum permitted average emission limit

Note 2:
Measurements may be performed at a distance other than what is specified provided. When performing measurements at a distance other than that specified, the results shall be extrapolated to the specified distance using an extrapolation factor as below, Frequency at or above 30 MHz: 20 dB/decade Frequency below 30 MHz: 40 dB/decade.

3.1.3 Test Procedures

1. Measurement is made at a semi-anechoic chamber that incorporates a turntable allowing a EUT rotation of 360°. A continuously-rotating, remotely-controlled turntable is installed at the test site to support the EUT and facilitate determination of the direction of maximum radiation for each EUT emission frequency. The EUT is placed at a height of 0.8 m test table above the ground plane.
2. Measurement is made with the antenna positioned in both the horizontal and vertical planes of polarization. The measurement antenna is varied in height (1m ~ 4m) above the reference ground plane to obtain the maximum signal strength. Distance between EUT and antenna is 3 m.
3. This investigation is performed with the EUT rotated 360°, the antenna height scanned between 1 m and 4 m, and the antenna rotated to repeat the measurements for both the horizontal and vertical antenna polarizations.

Note:

1. Radiated emission below 1GHz
120kHz measurement bandwidth of test receiver and Quasi-peak detector is for radiated emission
2. Radiated emission above 1GHz / Peak value except fundamental
RBW=1MHz, VBW=3MHz and Peak detector
Radiated emission above 1GHz / Average value for harmonics and fundamental

The average value is: Average = Peak value + 20log(Duty cycle) Where the duty factor is calculated from following formula:

3.
$$20\log(\text{Duty cycle}) = 20\log \frac{7 * 0.155 \text{ ms}}{100 \text{ ms}} = -39.29\text{dB}$$

Please see page 21 for plotted duty

4. Radiated emission above 1GHz / Average value for other emissions
RBW=1MHz, VBW=10Hz and Peak detector
5. Radiated emission Peak value for fundamental
RBW=3MHz, VBW=10MHz and Peak detector

3.1.4 Test Setup

Radiated Emissions below 1 GHz

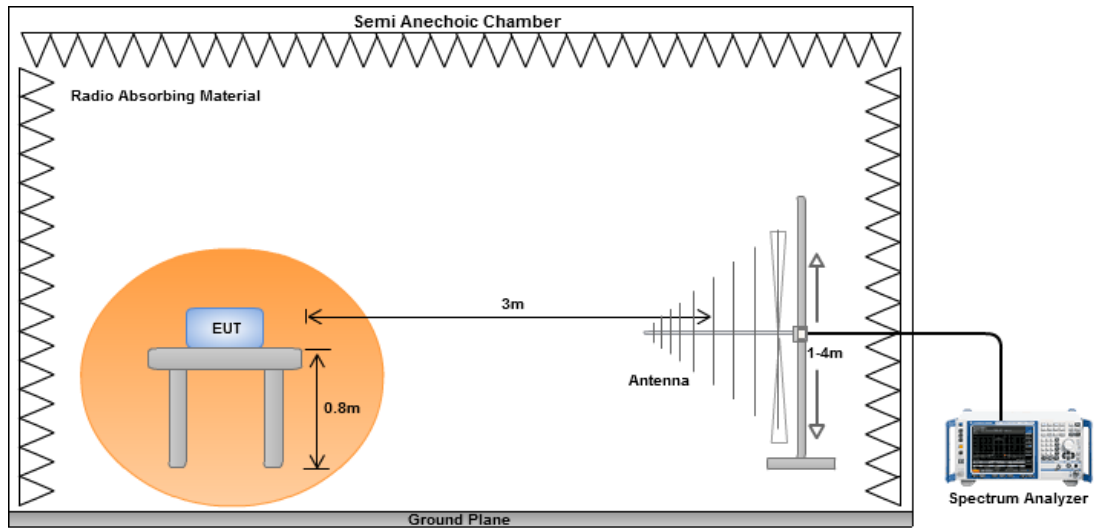

Radiated Emissions above 1 GHz

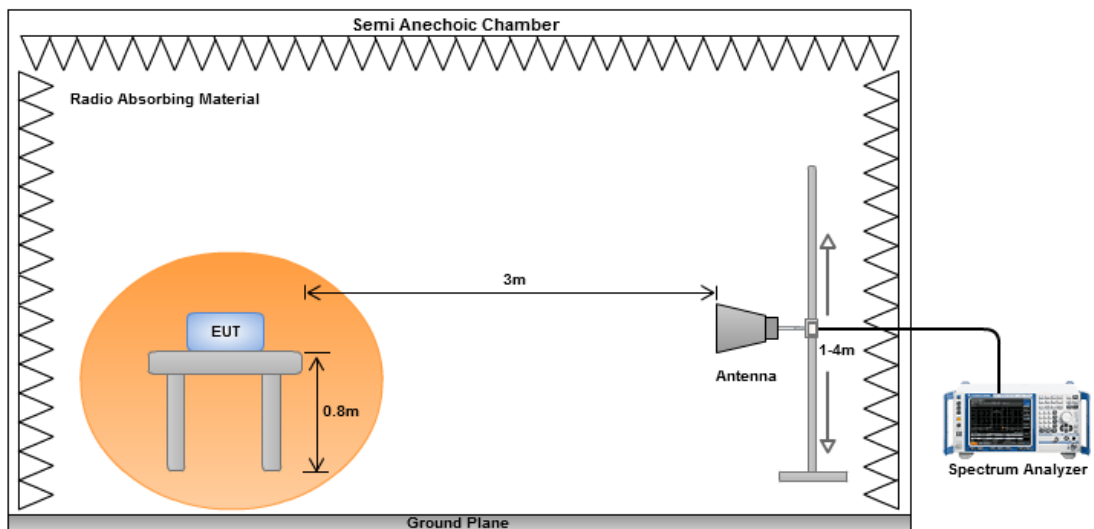

3.1.5 Transmitter Radiated Unwanted Emissions (Below 1GHz)

Modulation	FSK	Test Freq. (MHz)	2440
Polarization	Horizontal		

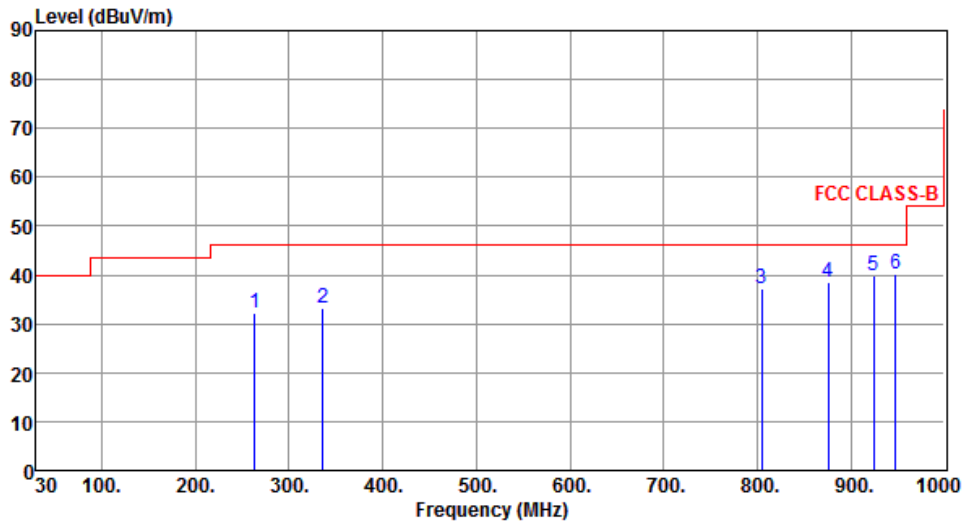

	Freq. MHz	Emission level dBuV/m	Limit dBuV/m	Margin dB	SA reading dBuV	Factor dB	Remark	ANT High cm	Turn Table deg
1	263.77	32.28	46.00	-13.72	49.71	-17.43	Peak	---	---
2	336.52	33.16	46.00	-12.84	48.52	-15.36	Peak	---	---
3	805.03	37.35	46.00	-8.65	44.06	-6.71	Peak	---	---
4	875.84	38.49	46.00	-7.51	44.30	-5.81	Peak	---	---
5	924.34	39.85	46.00	-6.15	44.94	-5.09	Peak	---	---
6	947.62	40.27	46.00	-5.73	44.98	-4.71	Peak	---	---

Note 1: Emission Level (dBuV/m) = SA Reading (dBuV/m) + Factor* (dB)

*Factor includes antenna factor , cable loss and amplifier gain

Note 2: Margin (dB) = Emission level (dBuV/m) – Limit (dBuV/m).

Note 3: All spurious emissions below 30MHz are more than 20 dB below the limit.

Modulation	FSK	Test Freq. (MHz)	2440
Polarization	Vertical		

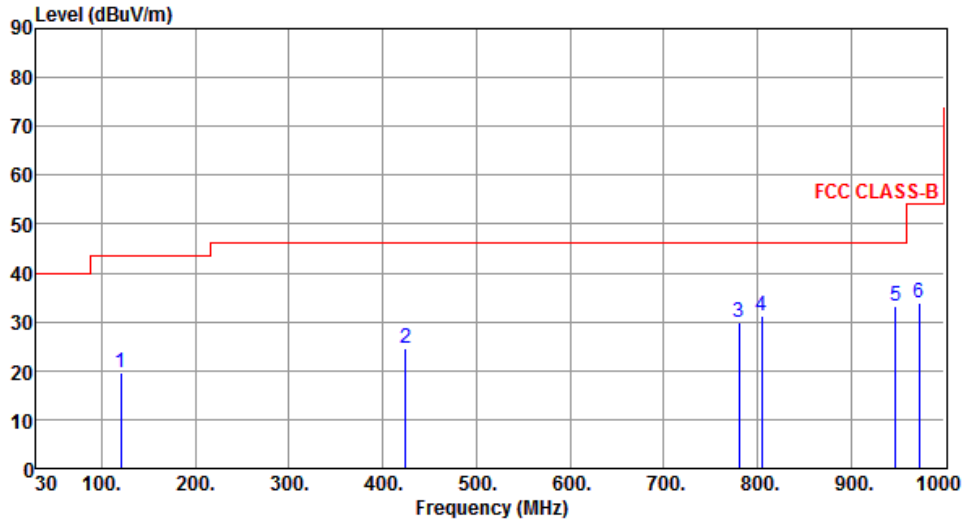

	Freq. MHz	Emission level dBuV/m	Limit dBuV/m	Margin dB	SA reading dBuV	Factor dB	Remark	ANT High cm	Turn Table deg
1	120.21	19.63	43.50	-23.87	38.75	-19.12	Peak	---	---
2	424.79	24.61	46.00	-21.39	37.69	-13.08	Peak	---	---
3	780.78	29.84	46.00	-16.16	36.78	-6.94	Peak	---	---
4	805.03	31.24	46.00	-14.76	37.95	-6.71	Peak	---	---
5	947.62	33.27	46.00	-12.73	37.98	-4.71	Peak	---	---
6	972.84	34.00	54.00	-20.00	38.56	-4.56	Peak	---	---

Note 1: Emission Level (dBuV/m) = SA Reading (dBuV/m) + Factor* (dB)

*Factor includes antenna factor , cable loss and amplifier gain

Note 2: Margin (dB) = Emission level (dBuV/m) – Limit (dBuV/m).

Note 3: All spurious emissions below 30MHz are more than 20 dB below the limit.

3.1.1 Transmitter Radiated Unwanted Emissions (Above 1GHz)

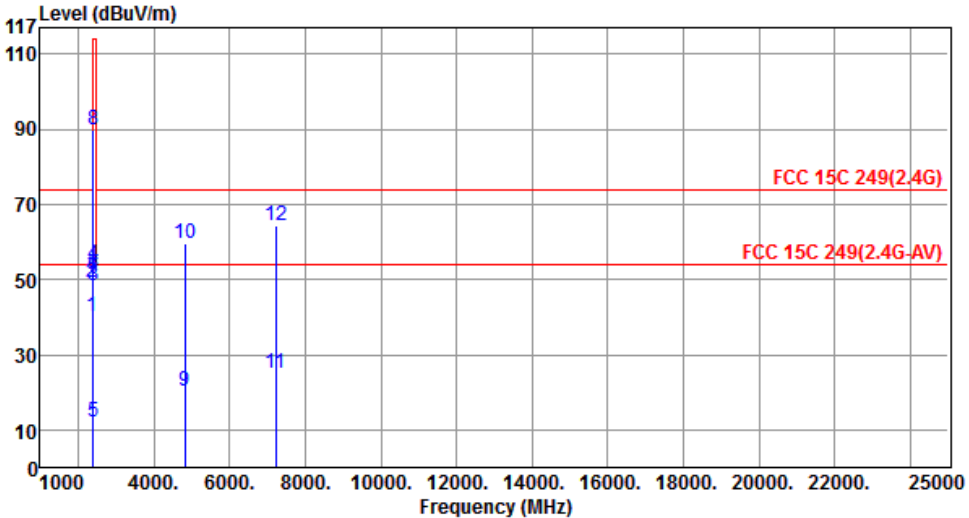
Modulation	FSK	Test Freq. (MHz)	2408						
Polarization	Horizontal								
 <p>The graph plots Level (dBuV/m) on the y-axis (0 to 117) against Frequency (MHz) on the x-axis (1000 to 25000). Two horizontal red lines represent FCC limits: FCC 15C 249(2.4G) at approximately 75 dBuV/m and FCC 15C 249(2.4G-AV) at approximately 55 dBuV/m. Vertical blue lines with labels 1 through 12 indicate specific emission measurements at various frequencies.</p>									
	Freq. MHz	Emission level dBuV/m	Limit dBuV/m	Margin dB	SA reading dBuV	Factor dB	Remark	ANT High cm	Turn Table deg
1	2384.00	40.25	54.00	-13.75	43.97	-3.72	Average	---	---
2	2384.00	49.15	74.00	-24.85	52.87	-3.72	Peak	---	---
3	2396.00	48.23	54.00	-5.77	51.89	-3.66	Average	---	---
4	2396.00	53.84	74.00	-20.16	57.50	-3.66	Peak	---	---
5	2400.00	12.05	54.00	-41.95	15.70	-3.65	Average	---	---
6	2400.00	51.34	74.00	-22.66	54.99	-3.65	Peak	---	---
7	2408.00	50.48	94.00	-43.52	54.09	-3.61	Average	---	---
8	2408.00	89.77	114.00	-24.23	93.38	-3.61	Peak	---	---
9	4816.00	20.49	54.00	-33.51	15.51	4.98	Average	---	---
10	4816.00	59.78	74.00	-14.22	54.80	4.98	Peak	---	---
11	7224.00	24.87	54.00	-29.13	15.59	9.28	Average	---	---
12	7224.00	64.16	74.00	-9.84	54.88	9.28	Peak	---	---

Note 1: Emission Level (dBuV/m) = SA Reading (dBuV/m) + Factor* (dB)

*Factor includes antenna factor , cable loss and amplifier gain

Note 2: Margin (dB) = Emission level (dBuV/m) – Limit (dBuV/m).

Modulation	FSK	Test Freq. (MHz)	2408
Polarization	Vertical		

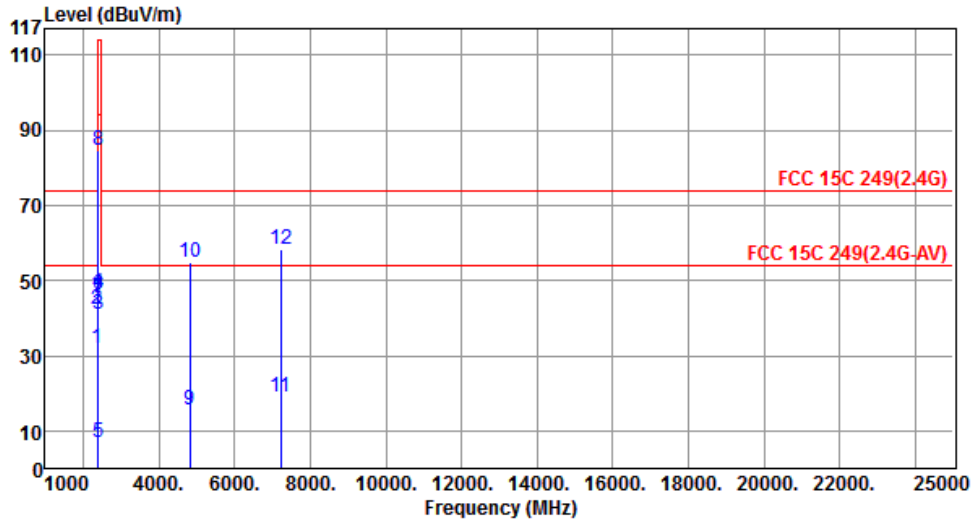

	Freq. MHz	Emission level dBUV/m	Limit dBUV/m	Margin dB	SA reading dBUV	Factor dB	Remark	ANT High cm	Turn Table deg
1	2384.00	31.76	54.00	-22.24	35.48	-3.72	Average	---	---
2	2384.00	42.35	74.00	-31.65	46.07	-3.72	Peak	---	---
3	2396.00	40.90	54.00	-13.10	44.56	-3.66	Average	---	---
4	2396.00	46.81	74.00	-27.19	50.47	-3.66	Peak	---	---
5	2400.00	6.91	54.00	-47.09	10.56	-3.65	Average	---	---
6	2400.00	46.20	74.00	-27.80	49.85	-3.65	Peak	---	---
7	2408.00	45.34	94.00	-48.66	48.95	-3.61	Average	---	---
8	2408.00	84.63	114.00	-29.37	88.24	-3.61	Peak	---	---
9	4816.00	15.56	54.00	-38.44	10.58	4.98	Average	---	---
10	4816.00	54.85	74.00	-19.15	49.87	4.98	Peak	---	---
11	7224.00	19.04	54.00	-34.96	9.76	9.28	Average	---	---
12	7224.00	58.33	74.00	-15.67	49.05	9.28	Peak	---	---

Note 1: Emission Level (dBUV/m) = SA Reading (dBUV/m) + Factor* (dB)

*Factor includes antenna factor , cable loss and amplifier gain

Note 2: Margin (dB) = Emission level (dBUV/m) – Limit (dBUV/m).

Modulation	FSK	Test Freq. (MHz)	2440
Polarization	Horizontal		

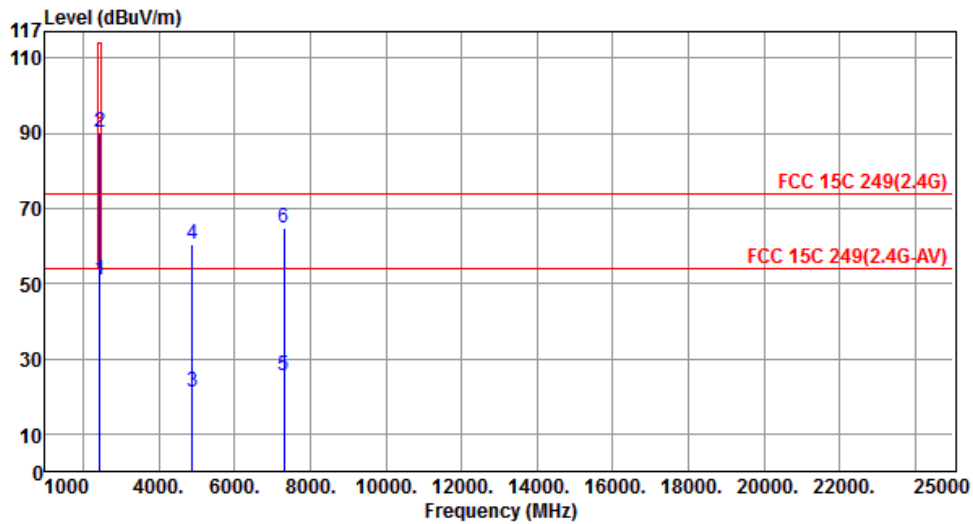

	Freq. MHz	Emission level dBuV/m	Limit dBuV/m	Margin dB	SA reading dBuV	Factor dB	Remark	ANT High cm	Turn Table deg
1	2440.00	51.04	94.00	-42.96	54.51	-3.47	Average	---	---
2	2440.00	90.33	114.00	-23.67	93.80	-3.47	Peak	---	---
3	4880.00	21.18	54.00	-32.82	16.07	5.11	Average	---	---
4	4880.00	60.47	74.00	-13.53	55.36	5.11	Peak	---	---
5	7320.00	25.28	54.00	-28.72	15.94	9.34	Average	---	---
6	7320.00	64.57	74.00	-9.43	55.23	9.34	Peak	---	---

Note 1: Emission Level (dBuV/m) = SA Reading (dBuV/m) + Factor* (dB)

*Factor includes antenna factor , cable loss and amplifier gain

Note 2: Margin (dB) = Emission level (dBuV/m) – Limit (dBuV/m).

Modulation	FSK	Test Freq. (MHz)	2440
Polarization	Vertical		

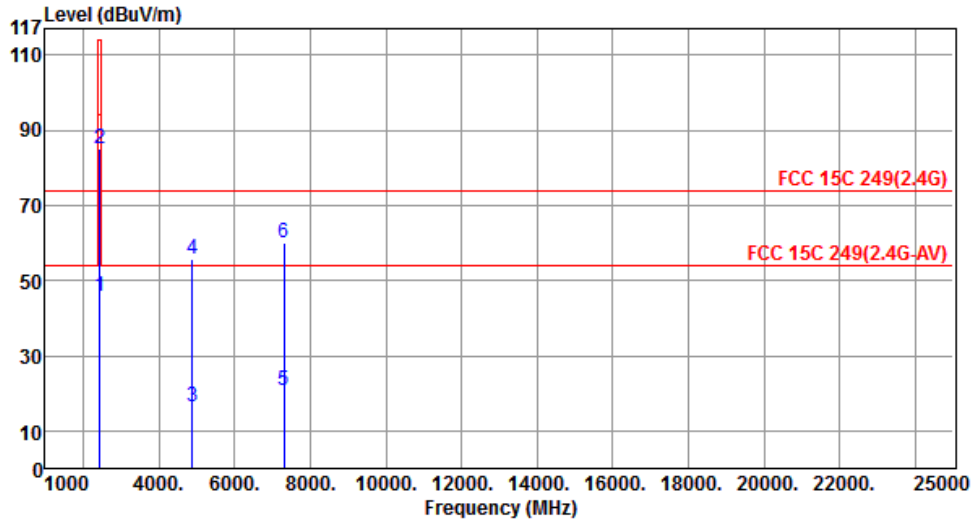

	Freq. MHz	Emission level dBuV/m	Limit dBuV/m	Margin dB	SA reading dBuV	Factor dB	Remark	ANT High cm	Turn Table deg
1	2440.00	45.92	94.00	-48.08	49.39	-3.47	Average	---	---
2	2440.00	85.21	114.00	-28.79	88.68	-3.47	Peak	---	---
3	4880.00	16.33	54.00	-37.67	11.22	5.11	Average	---	---
4	4880.00	55.62	74.00	-18.38	50.51	5.11	Peak	---	---
5	7320.00	20.84	54.00	-33.16	11.50	9.34	Average	---	---
6	7320.00	60.13	74.00	-13.87	50.79	9.34	Peak	---	---

Note 1: Emission Level (dBuV/m) = SA Reading (dBuV/m) + Factor* (dB)

*Factor includes antenna factor , cable loss and amplifier gain

Note 2: Margin (dB) = Emission level (dBuV/m) – Limit (dBuV/m).

Modulation	FSK	Test Freq. (MHz)	2480
Polarization	Horizontal		

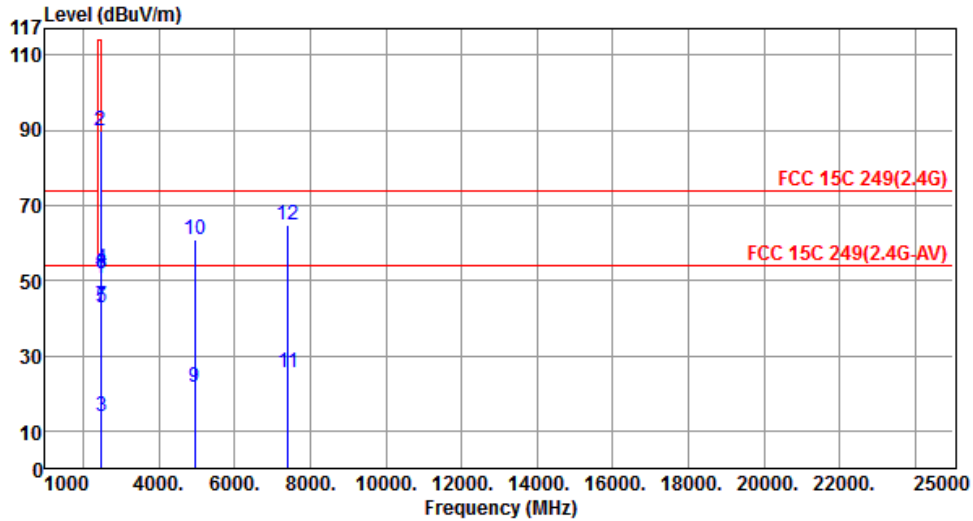

	Freq. MHz	Emission level dBuV/m	Limit dBuV/m	Margin dB	SA reading dBuV	Factor dB	Remark	ANT High cm	Turn Table deg
1	2474.00	50.59	94.00	-43.41	53.93	-3.34	Average	---	---
2	2474.00	89.88	114.00	-24.12	93.22	-3.34	Peak	---	---
3	2483.50	13.67	54.00	-40.33	16.97	-3.30	Average	---	---
4	2483.50	52.96	74.00	-21.04	56.26	-3.30	Peak	---	---
5	2485.50	42.58	54.00	-11.42	45.86	-3.28	Average	---	---
6	2485.50	51.84	74.00	-22.16	55.12	-3.28	Peak	---	---
7	2487.50	43.22	54.00	-10.78	46.50	-3.28	Average	---	---
8	2487.50	51.98	74.00	-22.02	55.26	-3.28	Peak	---	---
9	4948.00	21.54	54.00	-32.46	16.29	5.25	Average	---	---
10	4948.00	60.83	74.00	-13.17	55.58	5.25	Peak	---	---
11	7422.00	25.62	54.00	-28.38	16.12	9.50	Average	---	---
12	7422.00	64.91	74.00	-9.09	55.41	9.50	Peak	---	---

Note 1: Emission Level (dBuV/m) = SA Reading (dBuV/m) + Factor* (dB)

*Factor includes antenna factor , cable loss and amplifier gain

Note 2: Margin (dB) = Emission level (dBuV/m) – Limit (dBuV/m).

Modulation	FSK	Test Freq. (MHz)	2480
Polarization	Vertical		

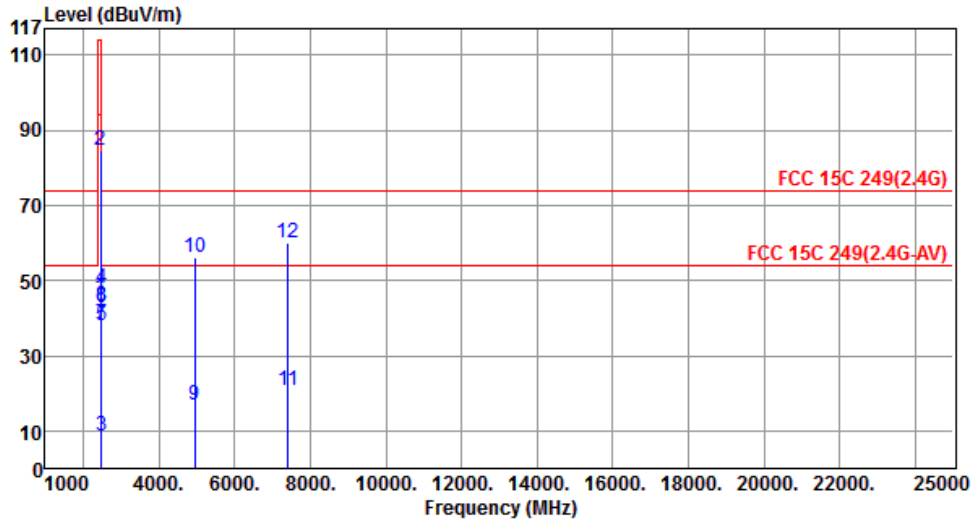

	Freq. MHz	Emission level dBuV/m	Limit dBuV/m	Margin dB	SA reading dBuV	Factor dB	Remark	ANT High cm	Turn Table deg
1	2474.00	45.50	94.00	-48.50	48.84	-3.34	Average	---	---
2	2474.00	84.79	114.00	-29.21	88.13	-3.34	Peak	---	---
3	2483.50	8.58	54.00	-45.42	11.88	-3.30	Average	---	---
4	2483.50	47.87	74.00	-26.13	51.17	-3.30	Peak	---	---
5	2485.50	37.99	54.00	-16.01	41.27	-3.28	Average	---	---
6	2485.50	42.78	74.00	-31.22	46.06	-3.28	Peak	---	---
7	2487.50	38.21	54.00	-15.79	41.49	-3.28	Average	---	---
8	2487.50	43.08	74.00	-30.92	46.36	-3.28	Peak	---	---
9	4948.00	16.96	54.00	-37.04	11.71	5.25	Average	---	---
10	4948.00	56.25	74.00	-17.75	51.00	5.25	Peak	---	---
11	7422.00	20.93	54.00	-33.07	11.43	9.50	Average	---	---
12	7422.00	60.22	74.00	-13.78	50.72	9.50	Peak	---	---

Note 1: Emission Level (dBuV/m) = SA Reading (dBuV/m) + Factor* (dB)

*Factor includes antenna factor , cable loss and amplifier gain

Note 2: Margin (dB) = Emission level (dBuV/m) – Limit (dBuV/m).

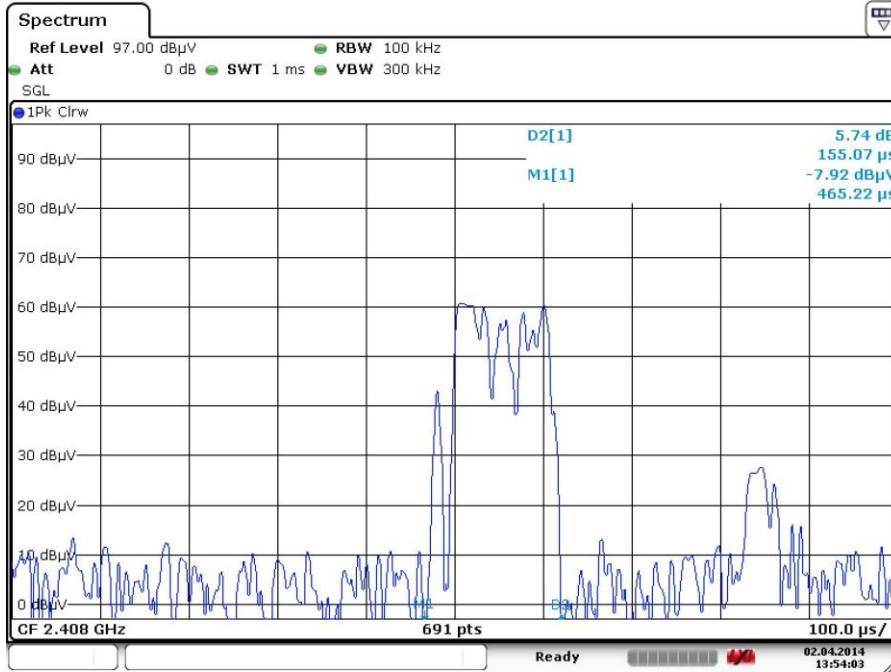

Date: 2.APR.2014 13:54:03

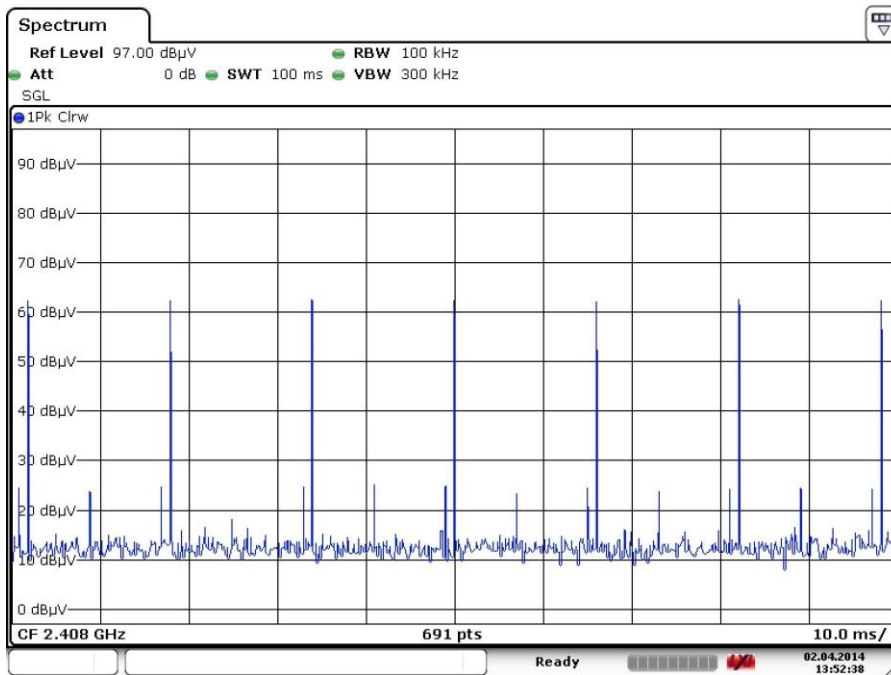

Date: 2.APR.2014 13:52:38

$$20\log(\text{Duty cycle}) = 20\log \frac{7 * 0.155 \text{ ms}}{100 \text{ ms}} = -39.29\text{dB}$$

3.2 20dB and Occupied Bandwidth

3.2.1 Test Procedures

1. Set resolution bandwidth (RBW) = 100 kHz, Video bandwidth = 300 kHz.
2. Detector = Peak, Trace mode = max hold.
3. Sweep = auto couple, Allow the trace to stabilize.
4. Measure the maximum width of the emission that is constrained by the frequencies associated with the two outermost amplitude points (upper and lower) that are attenuated by 20dB relative to the maximum level measured in the fundamental emission.
5. Use the occupied measurement function of spectrum analyzer to measure 99% occupied bandwidth

3.2.2 Test Setup

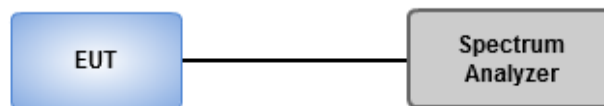

3.2.3 20dB and Occupied Bandwidth

Freq. (MHz)	20dB Bandwidth (MHz)	Occupied Bandwidth (MHz)
2404	2.200	2.156
2440	2.193	2.156
2479	2.192	2.149

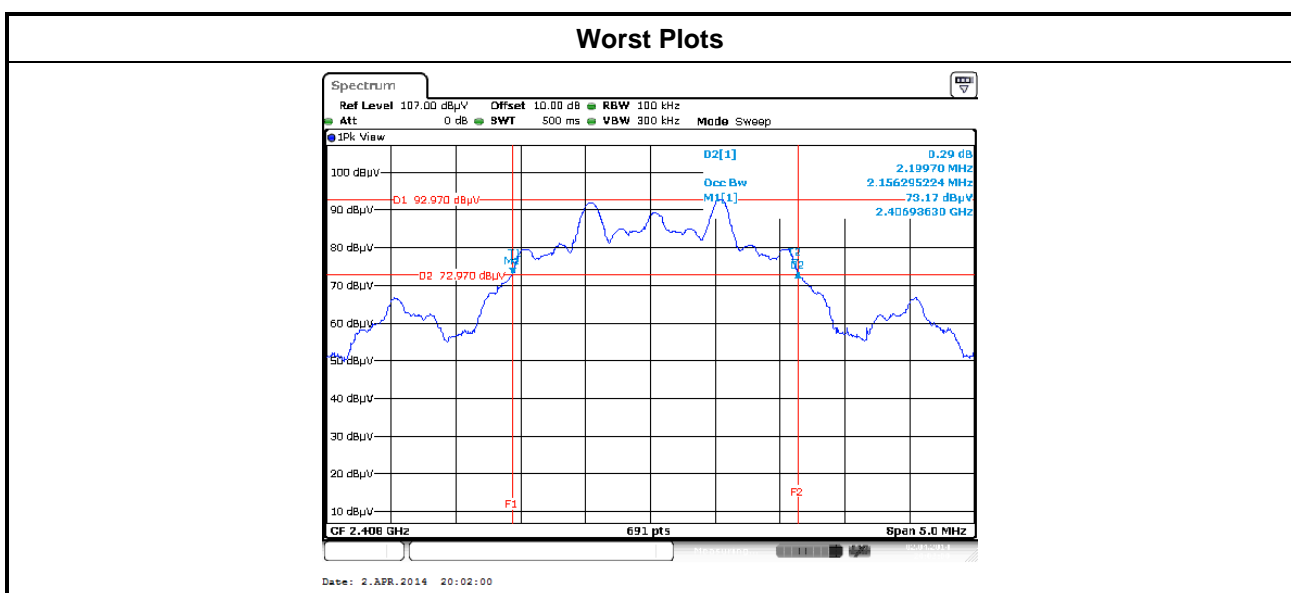

4 Test laboratory information

Established in 2012, ICC provides foremost EMC & RF Testing and advisory consultation services by our skilled engineers and technicians. Our services employ a wide variety of advanced edge test equipment and one of the widest certification extents in the business.

International Certification Corp, it is our definitive objective is to institute long term, trust-based associations with our clients. The expectation we set up with our clients is based on outstanding service, practical expertise and devotion to a certified value structure. Our passion is to grant our clients with best EMC / RF services by oriented knowledgeable and accommodating staff.

Our Test sites are located at Linkou District and Kwei Shan Hsiang. Location map can be found on our website <http://www.icertifi.com.tw>.

Linkou

Tel: 886-2-2601-1640

No. 30-2, Ding Fwu Tsuen, Lin Kou District, New Taipei City, Taiwan, R.O.C.

Kwei Shan

Tel: 886-3-271-8666

No. 3-1, Lane 6, Wen San 3rd St., Kwei Shan Hsiang, Tao Yuan Hsien 333, Taiwan, R.O.C.

If you have any suggestion, please feel free to contact us as below information

Tel: 886-3-271-8666

Fax: 886-3-318-0155

Email: ICC_Service@icertifi.com.tw

==END==