

TEST REPORT

CERTIFICATE OF CONFORMITY

Standard: 47 CFR FCC Part 15, Subpart C (Section 15.247)

Report No.: RFB DYV-WTW-P22040280

FCC ID: PRDHS06

Model No.: TPA-A003HS

Received Date: 2022/4/8

Test Date: 2022/6/8 ~ 2022/8/10

Issued Date: 2022/9/1

Applicant: Acrox Technologies Co., Ltd

Address: 4F., No. 89, Minshan St., Neihu Dist., Taipei City 114, Taiwan, R.O.C.

Issued By: Bureau Veritas Consumer Products Services (H.K.) Ltd., Taoyuan Branch
Lin Kou Laboratories

Lab Address: No. 47-2, 14th Ling, Chia Pau Vil., Lin Kou Dist., New Taipei City, Taiwan

Test Location: No. 47-2, 14th Ling, Chia Pau Vil., Lin Kou Dist., New Taipei City, Taiwan

FCC Registration / 198487 / TW2021

Designation Number:

Approved by: Jeremy Lin, **Date:** 2022/9/1
Jeremy Lin / Project Engineer

This test report consists of 53 pages in total. It may be duplicated completely for legal use with the approval of the applicant. It should not be reproduced except in full, without the written approval of our laboratory. The test results in the report only apply to the tested sample. The test results in this report are traceable to the national or international standards.

Prepared by : Annie Chang / Senior Specialist



This report is governed by, and incorporates by reference, the Conditions of Testing as posted at the date of issuance of this report at <http://www.bureauveritas.com/home/about-us/our-business/cps/about-us/terms-conditions/> and is intended for your exclusive use. Any copying or replication of this report to or for any other person or entity, or use of our name or trademark, is permitted only with our prior written permission. This report sets forth our findings solely with respect to the test samples identified herein. The results set forth in this report are not indicative or representative of the quality or characteristics of the lot from which a test sample was taken or any similar or identical product unless specifically and expressly noted. Our report includes all of the tests requested by you and the results thereof based upon the information that you provided to us. Measurement uncertainty is only provided upon request for accredited tests. Statements of conformity are based on simple acceptance criteria without taking measurement uncertainty into account, unless otherwise requested in writing. You have 60 days from date of issuance of this report to notify us of any material error or omission caused by our negligence or if you require measurement uncertainty; provided, however, that such notice shall be in writing and shall specifically address the issue you wish to raise. A failure to raise such issue within the prescribed time shall constitute your unqualified acceptance of the completeness of this report, the tests conducted and the correctness of the report contents.

Table of Contents

Release Control Record	4
1 Certificate	5
2 Summary of Test Results	6
2.1 Measurement Uncertainty	6
2.2 Supplementary Information	6
3 General Information	7
3.1 General Description	7
3.2 Antenna Description of EUT	7
3.3 Channel List	8
3.4 Test Mode Applicability and Tested Channel Detail	9
3.5 Duty Cycle of Test Signal	9
3.6 Test Program Used and Operation Descriptions	10
3.7 Connection Diagram of EUT and Peripheral Devices	10
3.8 Configuration of Peripheral Devices and Cable Connections	11
4 Test Instruments	12
4.1 RF Output Power	12
4.2 Number of Hopping Frequency Used	12
4.3 Dwell Time on Each Channel	12
4.4 Hopping Channel Separation	12
4.5 20 dB Bandwidth	12
4.6 Conducted Out of Band Emissions	12
4.7 AC Power Conducted Emissions	13
4.8 Unwanted Emissions below 1 GHz	14
4.9 Unwanted Emissions above 1 GHz	15
5 Limits of Test Items	16
5.1 RF Output Power	16
5.2 Number of Hopping Frequency Used	16
5.3 Dwell Time on Each Channel	16
5.4 Hopping Channel Separation	16
5.5 20 dB Bandwidth	16
5.6 Conducted Out of Band Emissions	16
5.7 AC Power Conducted Emissions	16
5.8 Unwanted Emissions below 1 GHz	17
5.9 Unwanted Emissions above 1 GHz	17
6 Test Arrangements	18
6.1 RF Output Power	18
6.1.1 Test Setup	18
6.1.2 Test Procedure	18
6.2 Number of Hopping Frequency Used	18
6.2.1 Test Setup	18
6.2.2 Test Procedure	18
6.3 Dwell Time on Each Channel	19
6.3.1 Test Setup	19
6.3.2 Test Procedure	19
6.4 Hopping Channel Separation	19
6.4.1 Test Setup	19
6.4.2 Test Procedure	19
6.5 20 dB Bandwidth	20
6.5.1 Test Setup	20
6.5.2 Test Procedure	20
6.6 Conducted Out of Band Emissions	20
6.6.1 Test Setup	20
6.6.2 Test Procedure	20
6.7 AC Power Conducted Emissions	21



6.7.1	Test Setup	21
6.7.2	Test Procedure.....	21
6.8	Unwanted Emissions below 1 GHz	22
6.8.1	Test Setup	22
6.8.2	Test Procedure.....	23
6.9	Unwanted Emissions above 1 GHz.....	24
6.9.1	Test Setup	24
6.9.2	Test Procedure.....	24
7	Test Results of Test Item	25
7.1	RF Output Power.....	25
7.2	Number of Hopping Frequency Used.....	26
7.3	Dwell Time on Each Channel	27
7.4	Hopping Channel Separation	29
7.5	20 dB Bandwidth	30
7.6	Conducted Out of Band Emissions	31
7.7	AC Power Conducted Emissions	33
7.8	Unwanted Emissions below 1 GHz	37
7.9	Unwanted Emissions above 1 GHz.....	39
8	Pictures of Test Arrangements	52
9	Information of the Testing Laboratories	53



Release Control Record

Issue No.	Description	Date Issued
RFBDYV-WTW-P22040280	Original release.	2022/9/1

1 Certificate

Product: HP 445 Conferencing On-Ear Bluetooth Headset

Brand: hp

Test Model: TPA-A003HS

Sample Status: Engineering sample

Applicant: Acrox Technologies Co., Ltd

Test Date: 2022/6/8 ~ 2022/8/10

Standard: 47 CFR FCC Part 15, Subpart C (Section 15.247)

Measurement ANSI C63.10-2013

procedure: KDB 558074 D01 15.247 Meas Guidance v05r02

The above equipment has been tested by **Bureau Veritas Consumer Products Services (H.K.) Ltd., Taoyuan Branch**, and found compliance with the requirement of the above standards. The test record, data evaluation & Equipment Under Test (EUT) configurations represented herein are true and accurate accounts of the measurements of the sample's RF characteristics under the conditions specified in this report.

2 Summary of Test Results

47 CFR FCC Part 15, Subpart C (Section 15.247)			
Standard / Clause	Test Item	Result	Remark
15.247 (a)(1)	RF Output Power	Pass	Meet the requirement of limit.
15.247(a)(1) (iii)	Number of Hopping Frequency Used	Pass	Meet the requirement of limit.
15.247(a)(1) (iii)	Dwell Time on Each Channel	Pass	Meet the requirement of limit.
15.247(a)(1)	Hopping Channel Separation	Pass	Meet the requirement of limit.
15.247(a)(1)	20 dB Bandwidth	Pass	Refer to note 1
15.247(d)	Conducted Out of Band Emissions	Pass	Meet the requirement of limit.
15.207	AC Power Conducted Emissions	Pass	Minimum passing margin is -16.53 dB at 8.76172 MHz
15.205 / 15.209 / 15.247(d)	Unwanted Emissions below 1 GHz	Pass	Minimum passing margin is -16.3 dB at 30.58 MHz
15.205 / 15.209 / 15.247(d)	Unwanted Emissions above 1 GHz	Pass	Minimum passing margin is -3.2 dB at 2483.50 MHz
15.203	Antenna Requirement	Pass	No antenna connector is used.

Notes:

1. If the Frequency Hopping System operating in 2400-2483.5 MHz band and the output power less than 125 mW. The hopping channel carrier frequencies separated by a minimum of 25 kHz or two-thirds of the 20 dB bandwidth of hopping channel whichever is greater.
2. Determining compliance based on the results of the compliance measurement, not taking into account measurement instrumentation uncertainty.

2.1 Measurement Uncertainty

Where relevant, the following measurement uncertainty levels have been estimated for tests performed on the EUT as specified in CISPR 16-4-2:

Measurement	Specification	Expanded Uncertainty (k=2) (±)
Conducted Out of Band Emissions	9 kHz ~ 40 GHz	2.63 dB
AC Power Conducted Emissions	150 kHz ~ 30 MHz	3.00 dB
Unwanted Emissions below 1 GHz	9 kHz ~ 30 MHz	2.38 dB
	30 MHz ~ 1 GHz	5.62 dB
Unwanted Emissions above 1 GHz	1 GHz ~ 6 GHz	4.61 dB
	6 GHz ~ 18 GHz	5.41 dB
	18 GHz ~ 40 GHz	5.14 dB

The other instruments specified are routine verified to remain within the calibrated levels, no measurement uncertainty is required to be calculated.

2.2 Supplementary Information

There is not any deviation from the test standards for the test method, and no modifications required for compliance.

3 General Information

3.1 General Description

Product	HP 445 Conferencing On-Ear Bluetooth Headset
Brand	hp
Test Model	TPA-A003HS
Status of EUT	Engineering sample
Power Supply Rating	3.7Vdc from Battery or 5Vdc from USB port
Modulation Type	GFSK, $\pi/4$ -DQPSK, 8DPSK
Modulation Technology	FHSS
Transfer Rate	Up to 3 Mbps
Operating Frequency	2402 ~ 2480 MHz
Number of Channel	79
Output Power	3.006 mW (4.78 dBm)
Data Cable Supplied	Non-shielded Audio cable (1.2m) Shielded USB A – USB C cable (1.2m)

Note: The above EUT information is declared by manufacturer and for more detailed features description, please refer to the manufacturer's specifications or User's Manual.

3.2 Antenna Description of EUT

The antenna information is listed as below.

Gain (dBi)	Antenna Type	Connector Type
2.78	Ceramic	N/A

* Detail antenna specification please refer to antenna datasheet and/or antenna measurement report.

3.3 Channel List

79 channels are provided for BT-EDR:

Channel	Frequency (MHz)	Channel	Frequency (MHz)	Channel	Frequency (MHz)	Channel	Frequency (MHz)
0	2402	20	2422	40	2442	60	2462
1	2403	21	2423	41	2443	61	2463
2	2404	22	2424	42	2444	62	2464
3	2405	23	2425	43	2445	63	2465
4	2406	24	2426	44	2446	64	2466
5	2407	25	2427	45	2447	65	2467
6	2408	26	2428	46	2448	66	2468
7	2409	27	2429	47	2449	67	2469
8	2410	28	2430	48	2450	68	2470
9	2411	29	2431	49	2451	69	2471
10	2412	30	2432	50	2452	70	2472
11	2413	31	2433	51	2453	71	2473
12	2414	32	2434	52	2454	72	2474
13	2415	33	2435	53	2455	73	2475
14	2416	34	2436	54	2456	74	2476
15	2417	35	2437	55	2457	75	2477
16	2418	36	2438	56	2458	76	2478
17	2419	37	2439	57	2459	77	2479
18	2420	38	2440	58	2460	78	2480
19	2421	39	2441	59	2461		

3.4 Test Mode Applicability and Tested Channel Detail

Pre-Scan:	<p>1. EUT can be used in the following ways: XYZ 3-axis. Pre-scan in these ways and find the worst case as a representative test condition.</p> <p>2. For Unwanted Emission below 1 GHz has Battery / EUT with USB cable (Adapter) / EUT with USB cable (Notebook) mode of power supply. Pre-scan these modes and find the worst case as a representative test condition.</p> <p>3. For Unwanted Emission above 1 GHz has Battery / EUT with USB cable (Notebook) mode of power supply. Pre-scan these modes and find the worst case as a representative test condition.</p>
Worst Case:	<p>1. X/ Y/ Z Worst Condition: X axis for Unwanted Emission above 1GHz and Unwanted Emission below 1GHz.</p> <p>2. For Unwanted Emission below 1 GHz EUT with USB cable (Notebook) mode is the worst case of power supply.</p> <p>3. For Unwanted Emission above 1 GHz EUT with USB cable (Notebook) mode is the worst case of power supply.</p>

Following channel(s) was (were) selected for the final test as listed below:

Test Item	EUT Configure Mode	Tested Channel	Modulation	Data Rate Parameter
RF Output Power	A	0, 39, 78	GFSK	DH5
			8DPSK	3DH5
Number of Hopping Frequency Used	A	Hopping	GFSK	DH5
			8DPSK	3DH5
Dwell Time on Each Channel	A	Hopping	GFSK	DH1/DH3/DH5
			8DPSK	3DH1/3DH3/3DH5
Hopping Channel Separation / 20 dB Bandwidth	A	0, 39, 78	GFSK	DH5
			8DPSK	3DH5
Conducted Out of Band Emissions	A	Hopping 0, 78	GFSK	DH5
			8DPSK	3DH5
AC Power Conducted Emissions	A	0	GFSK	DH5
	B	0	GFSK	DH5
Unwanted Emissions below 1 GHz	A	0	GFSK	DH5
Unwanted Emissions above 1 GHz	A	0, 39, 78	GFSK	DH5
			8DPSK	3DH5
EUT Configure Mode:	A	EUT with USB cable (Notebook)		
	B	EUT with USB cable (Adapter)		

3.5 Duty Cycle of Test Signal

Mode A

GFSK: Duty cycle = 2.9 ms / 100 ms x 100% = 2.9%

8DPSK: Duty cycle = 2.9 ms / 100 ms x 100% = 2.9%

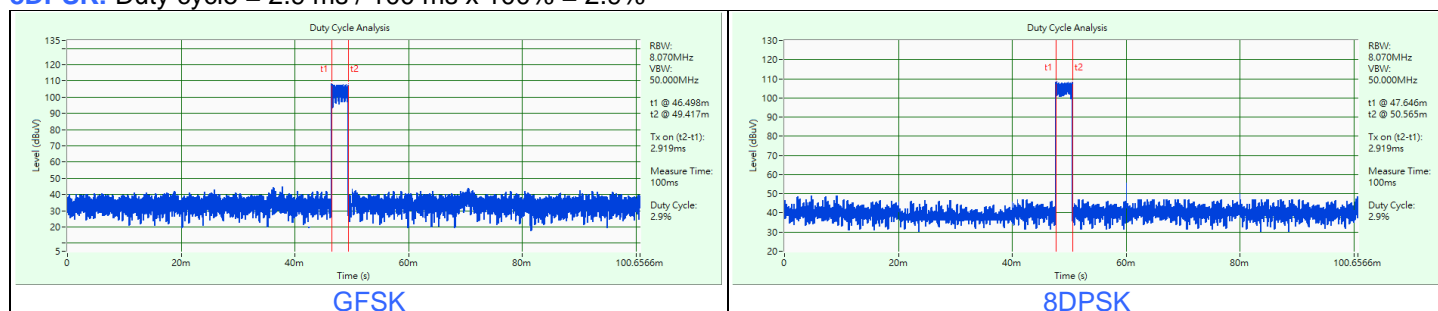

3.6 Test Program Used and Operation Descriptions

Controlling software (AWRDLABV2(1.0.9.22)) has been activated to set the EUT under transmission condition continuously at specific channel frequency.

3.7 Connection Diagram of EUT and Peripheral Devices

Mode A

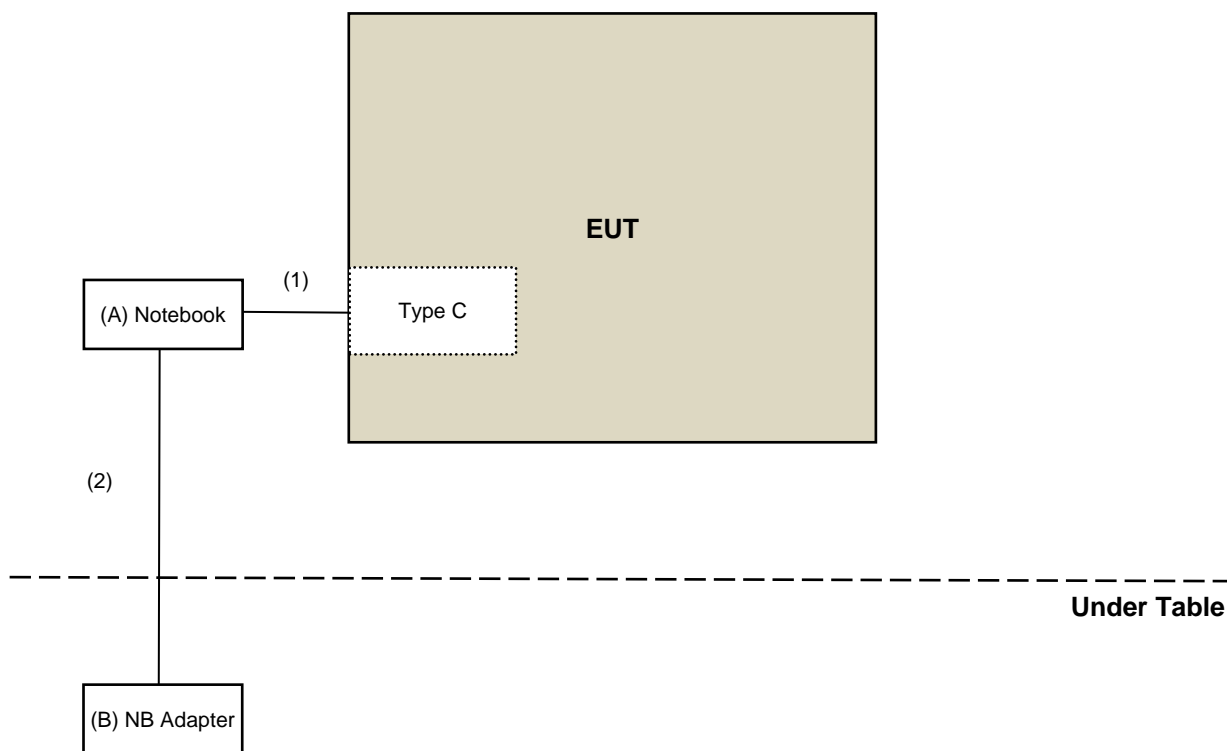

Mode B

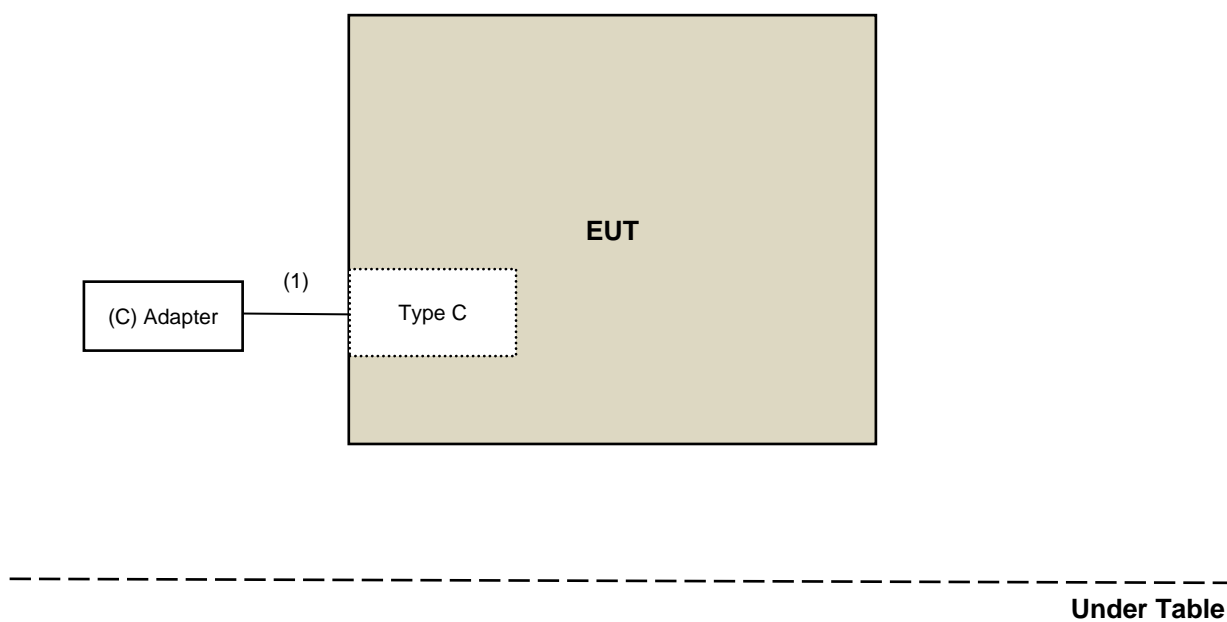

3.8 Configuration of Peripheral Devices and Cable Connections

ID	Product	Brand	Model No.	Serial No.	FCC ID	Remarks
A	Notebook	Lenovo	81A4	YD02TWDP	N/A	Provided by Lab
B	NB Adapter	Lenovo	ADLX65CLGU2A	N/A	N/A	Provided by Lab
C	Adapter	Apple	A1385	N/A	N/A	Provided by Lab

ID	Cable Descriptions	Qty.	Length (m)	Shielding (Yes/No)	Cores (Qty.)	Remarks
1	USB Type A to C Cable	1	1.2	Y	0	Supplied by applicant
2	NB Power Cable	1	1.9	N	0	Provided by Lab

4 Test Instruments

The calibration interval of the all test instruments are 12 months and the calibrations are traceable to NML/ROC and NIST/USA.

4.1 RF Output Power

Description Manufacturer	Model No.	Serial No.	Calibrated Date	Calibrated Until
MIMO Powermeasurement Test set (4X4) KEYSIGHT	U2021XA	U2021XA_001	2022/6/13	2023/6/12
MXG Vector Signal Generator KEYSIGHT	N5182B	MY53052658	2022/5/9	2023/5/8
Power Meter Anritsu	ML2495A	1232003	2022/1/9	2023/1/8
Power Sensor Anritsu	MA2411B	1207333	2022/1/9	2023/1/8
Spectrum Analyzer KEYSIGHT	N9030A	MY54490260	2022/7/14	2023/7/13
Spectrum Analyzer R&S	FSV40	101042	2021/9/9	2022/9/8
		101544	2022/5/9	2023/5/8
Temperature & Humidity Chamber TERCHY	MHU-225AU	920409	2022/6/27	2023/6/26

Notes:

1. The test was performed in LK - Oven
2. Tested Date: 2022/8/10

4.2 Number of Hopping Frequency Used

Refer to section 4.1 to get information of the instruments.

4.3 Dwell Time on Each Channel

Refer to section 4.1 to get information of the instruments.

4.4 Hopping Channel Separation

Refer to section 4.1 to get information of the instruments.

4.5 20 dB Bandwidth

Refer to section 4.1 to get information of the instruments.

4.6 Conducted Out of Band Emissions

Refer to section 4.1 to get information of the instruments.

4.7 AC Power Conducted Emissions

Description Manufacturer	Model No.	Serial No.	Calibrated Date	Calibrated Until
50 ohm terminal LYNICS	0900510	E1-011285	2021/10/1	2022/9/30
		E1-011286	2021/10/1	2022/9/30
50 Ohms Terminator LYNICS	0900510	E1-01-305	2022/2/9	2023/2/8
Attenuator STI	STI02-2200-10	NO.4	2021/9/3	2022/9/2
DC LISN R&S	ESH3-Z6	100219	2021/7/25	2022/7/24
		844950/018	2021/7/25	2022/7/24
DC LISN Schwarzbeck	NNLK 8121	8121-808	2022/4/29	2023/4/28
High Voltage Probe Schwarzbeck	TK9420	00982	2021/12/24	2022/12/23
Isolation Transformer Erika Fiedler	D-65396	017	2021/9/9	2022/9/8
LISN R&S	ENV216	101196	2022/5/24	2023/5/23
	ESH3-Z5	100220	2021/11/25	2022/11/24
LISN Schwarzbeck	NNLK 8121	8121-731	2022/5/26	2023/5/25
		8121-00759	2021/8/17	2022/8/16
	NNLK8129	8129229	2022/6/8	2023/6/7
	NSLK 8128	8128-244	2021/11/11	2022/11/10
RF Coaxial Cable Commate	5D-FB	Cable-CO5-01	2022/1/28	2023/1/27
Software BVADT	Cond_V7.3.7.4	N/A	N/A	N/A
TEST RECEIVER R&S	ESCS 30	100276	2022/4/19	2023/4/18
Test Receiver R&S	ESR3	102412	2022/1/22	2023/1/21

Notes:

1. The test was performed in Linkou Conduction 5.
2. Tested Date: 2022/7/6

4.8 Unwanted Emissions below 1 GHz

Description Manufacturer	Model No.	Serial No.	Calibrated Date	Calibrated Until
* LOOP ANTENNA EMCI	LPA600	270	2021/9/2	2023/9/1
Bi_Log Antenna Schwarzbeck	VULB 9168	137	2021/10/27	2022/10/26
Coupling/Dcoupling Network Schwarzbeck	CDNE-M2	00097	2022/6/1	2023/5/31
	CDNE-M3	00091	2022/6/1	2023/5/31
Pre_Amplifier EMCI	EMC001340	980269	2021/6/29	2022/6/28
Pre_Amplifier HP	8447D	2432A03504	2022/2/17	2023/2/16
RF Coaxial Cable Pacific	8D-FB	Cable-CH6-02	2021/7/13	2022/7/12
Software BVADT	Radiated_V8.7.08	N/A	N/A	N/A
Spectrum Analyzer R&S	FSV40	101544	2022/5/9	2023/5/8
Test Receiver Agilent	N9038A	MY51210129	2022/4/8	2023/4/7
		MY51210137	2022/6/9	2023/6/8
Tower ADT	AT100	0306	N/A	N/A
Turn Table ADT	TT100	0306	N/A	N/A

Notes:

1. * The calibration interval of the above test instruments is 24 months and the calibrations are traceable to NML/ROC and NIST/USA
2. The test was performed in Linkou 966 Chamber 6 (CH 6).
3. Tested Date: 2022/6/9

4.9 Unwanted Emissions above 1 GHz

Description Manufacturer	Model No.	Serial No.	Calibrated Date	Calibrated Until
Band Pass Filter MICRO-TRONICS	BRM17690	005	2022/5/26	2023/5/25
Boresight antenna tower fixture BV	BAF-02	6	N/A	N/A
High Pass Filter Wainwright Instruments	WHK 3.1/18G-10SS	SN 8	2022/5/26	2023/5/25
Horn Antenna EMCO	3115	00027024	2021/11/14	2022/11/13
		00028257	2021/11/14	2022/11/13
Horn Antenna ETS-Lindgren	3117-PA	00215857	2021/11/14	2022/11/13
Horn Antenna Schwarzbeck	BBHA 9170	212	2021/10/13	2022/10/12
Notch Filter MICRO-TRONICS	BRC50703-01	010	2022/5/26	2023/5/25
Pre_Amplifier EMCI	EMC0126545	980076	2022/2/17	2023/2/16
	EMC184045B	980235	2022/2/17	2023/2/16
Pre-amplifier HP	8449B	3008A01201	2022/2/17	2023/2/16
Pre-amplifier (18GHz-40GHz) EMCI	EMC184045B	980175	2021/9/4	2022/9/3
RF Coaxial Cable EM	EM102-KMKM-3.5+1M	EM102-KMKM-3.5+1M-01	2021/7/8	2022/7/7
RF Coaxial Cable HUBER SUHNER	SF-104	Cable-CH6-01	2021/7/8	2022/7/7
RF Coaxial Cable Rosnol	K1K50-UP0279-K1K50-3000	Cable-CH10(3m)-04	2021/7/8	2022/7/7
RF Coaxial Cable WOKEN	WC01	Cable-CH10-03	2021/7/8	2022/7/7
Software BVADT	Radiated_V8.7.08	N/A	N/A	N/A
Spectrum Analyzer Agilent	E4446A	MY51100009	2021/6/29	2022/6/28
Spectrum Analyzer KEYSIGHT	N9030A	MY54490260	2021/7/23	2022/7/22
Spectrum Analyzer R&S	FSV40	101042	2021/9/9	2022/9/8
		101544	2022/5/9	2023/5/8
Test Receiver Agilent	N9038A	MY51210129	2022/4/8	2023/4/7
		MY51210137	2021/6/16	2022/6/15
Tower ADT	AT100	0306	N/A	N/A
Turn Table ADT	TT100	0306	N/A	N/A

Notes:

1. The test was performed in Linkou 966 Chamber 6 (CH 6).
2. Tested Date: 2022/6/8 ~ 2022/6/9

5 Limits of Test Items

5.1 RF Output Power

The Maximum Output Power Measurement is 125 mW (21 dBm).

5.2 Number of Hopping Frequency Used

At least 15 channels frequencies, and should be equally spaced.

5.3 Dwell Time on Each Channel

The average time of occupancy on any channel shall not be greater than 0.4 seconds within a period of 0.4 seconds multiplied by the number of hopping channels employed.

5.4 Hopping Channel Separation

At least 25 kHz or two-third of 20 dB hopping channel bandwidth (whichever is greater).

5.5 20 dB Bandwidth

Maximum bandwidth is not specified.

5.6 Conducted Out of Band Emissions

Below 20 dB of the highest emission level of operating band (in 100 kHz Resolution Bandwidth).

5.7 AC Power Conducted Emissions

Frequency (MHz)	Conducted Limit (dBuV)	
	Quasi-peak	Average
0.15 - 0.5	66 - 56	56 - 46
0.50 - 5.0	56	46
5.0 - 30.0	60	50

Notes:

1. The lower limit shall apply at the transition frequencies.
2. The limit decreases in line with the logarithm of the frequency in the range of 0.15 to 0.50 MHz.

5.8 Unwanted Emissions below 1 GHz

Radiated emissions up to 1 GHz which fall in the restricted bands must comply with the radiated emission limits specified as below table. Other emissions shall be at least 20 dB below the highest level of the desired power:

Frequencies (MHz)	Field Strength (microvolts/meter)	Measurement Distance (meters)
0.009 ~ 0.490	2400/F(kHz)	300
0.490 ~ 1.705	24000/F(kHz)	30
1.705 ~ 30.0	30	30
30 ~ 88	100	3
88 ~ 216	150	3
216 ~ 960	200	3
Above 960	500	3

Notes:

1. The lower limit shall apply at the transition frequencies.
2. Emission level (dBuV/m) = 20 log Emission level (uV/m).

5.9 Unwanted Emissions above 1 GHz

Radiated emissions above 1 GHz which fall in the restricted bands must comply with the radiated emission limits specified as below table. Other emissions shall be at least 20 dB below the highest level of the desired power:

Frequencies (MHz)	Field Strength (microvolts/meter)	Measurement Distance (meters)
Above 960	500	3

Notes:

1. The lower limit shall apply at the transition frequencies.
2. Emission level (dBuV/m) = 20 log Emission level (uV/m).
3. For frequencies above 1000 MHz, the field strength limits are based on average detector, however, the peak field strength of any emission shall not exceed the maximum permitted average limits, specified above by more than 20 dB under any condition of modulation.

6 Test Arrangements

6.1 RF Output Power

6.1.1 Test Setup

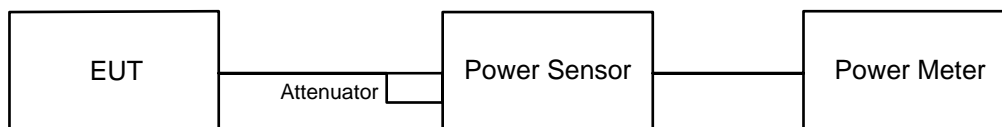

6.1.2 Test Procedure

Peak Power:

A peak power sensor was used on the output port of the EUT. A power meter was used to read the response of the peak power sensor. Record the power level.

Average Power:

Average power sensor was used to perform output power measurement, trigger and gating function of wide band power meter is enabled to measure max output power of TX on burst. Duty factor is not added to measured value.

6.2 Number of Hopping Frequency Used

6.2.1 Test Setup

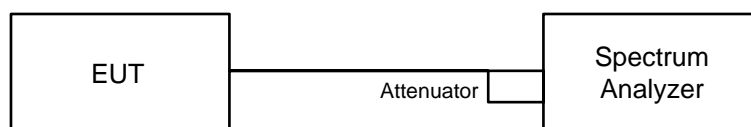

6.2.2 Test Procedure

- a. Check the calibration of the measuring instrument (SA) using either an internal calibrator or a known signal from an external generator.
- b. Turn on the EUT and connect its antenna terminal to measurement via a low loss cable. Then set it to any one measured frequency within its operating range and make sure the instrument is operated in its linear range.
- c. Set the SA on MaxHold Mode, and then keep the EUT in hopping mode. Record all the signals from each channel until each one has been recorded.
- d. Set the SA on View mode and then plot the result on SA screen.
- e. Repeat above procedures until all frequencies measured were complete.

6.3 Dwell Time on Each Channel

6.3.1 Test Setup

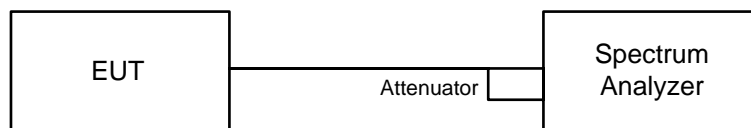

6.3.2 Test Procedure

- Check the calibration of the measuring instrument (SA) using either an internal calibrator or a known signal from an external generator.
- Turn on the EUT and connect its antenna terminal to measurement via a low loss cable. Then set it to any one measured frequency within its operating range and make sure the instrument is operated in its linear range.
- Adjust the center frequency of SA on any frequency to be measured and set SA to zero span mode. And then, set RBW and VBW of spectrum analyzer to proper value.
- Measure the time duration of one transmission on the measured frequency. And then plot the result with time difference of this time duration.
- Repeat above procedures until all different time-slot modes have been completed.

6.4 Hopping Channel Separation

6.4.1 Test Setup

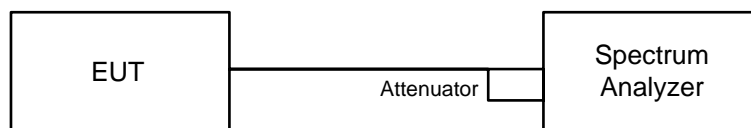

6.4.2 Test Procedure

- Check the calibration of the measuring instrument using either an internal calibrator or a known signal from an external generator.
- Turn on the EUT and connect it to measurement instrument. Then set it to any one convenient frequency within its operating range.
- By using the MaxHold function record the separation of two adjacent channels.
- Measure the frequency difference of these two adjacent channels by SA MARK function. And then plot the result on SA screen.
- Repeat above procedures until all frequencies measured were complete.

6.5 20 dB Bandwidth

6.5.1 Test Setup

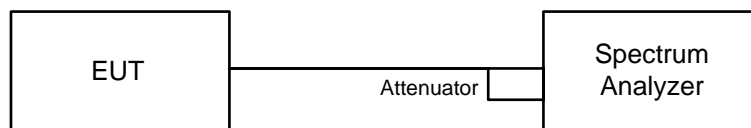

6.5.2 Test Procedure

- Check the calibration of the measuring instrument using either an internal calibrator or a known signal from an external generator.
- Turn on the EUT and connect it to measurement instrument. Then set it to any one convenient frequency within its operating range. Set a reference level on the measuring instrument equal to the highest peak value.
- Measure the frequency difference of two frequencies that were attenuated 20 dB from the reference level. Record the frequency difference as the emission bandwidth.
- Repeat above procedures until all frequencies measured were complete.

6.6 Conducted Out of Band Emissions

6.6.1 Test Setup



6.6.2 Test Procedure

MEASUREMENT PROCEDURE REF

- Set the RBW = 100 kHz.
- Set the VBW \geq 300 kHz.
- Detector = peak.
- Sweep time = auto couple.
- Trace mode = max hold.
- Allow trace to fully stabilize.
- Use the peak marker function to determine the maximum power level in any 100 kHz band segment within the fundamental EBW.

MEASUREMENT PROCEDURE OOB

- Set RBW = 100 kHz.
- Set VBW \geq 300 kHz.
- Detector = peak.
- Sweep = auto couple.
- Trace Mode = max hold.
- Allow trace to fully stabilize.
- Use the peak marker function to determine the maximum amplitude level.

6.7 AC Power Conducted Emissions

6.7.1 Test Setup

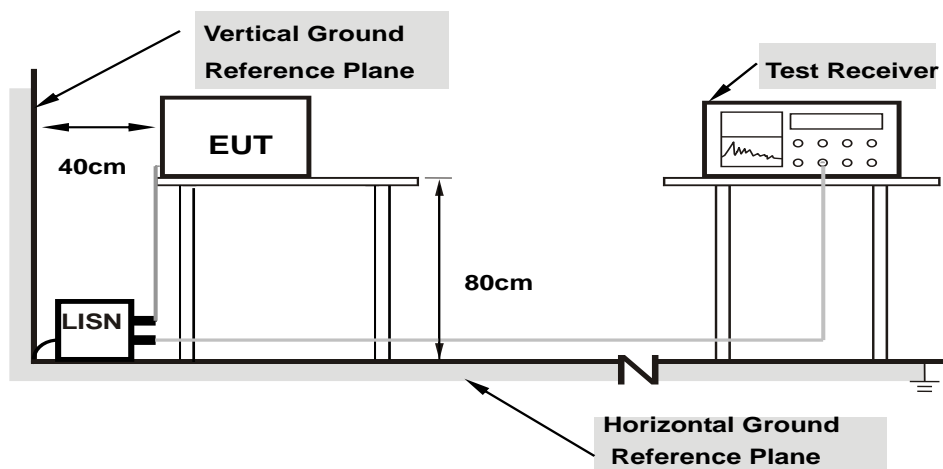

Note: 1.Support units were connected to second LISN.

For the actual test configuration, please refer to the attached file (Test Setup Photo).

6.7.2 Test Procedure

- The EUT was placed on a 0.8 meter to the top of table and placed 0.4 meters from the conducting wall of the shielded room with EUT being connected to the power mains through a line impedance stabilization network (LISN). Other support units were connected to the power mains through another LISN. The two LISNs provide 50 ohm/ 50 uH of coupling impedance for the measuring instrument.
- Both lines of the power mains connected to the EUT were checked for maximum conducted interference.
- The frequency range from 150 kHz to 30 MHz was searched. Emission levels under (Limit – 20 dB) was not recorded.

Note: The resolution bandwidth and video bandwidth of test receiver is 9 kHz for quasi-peak detection (QP) and average detection (AV) at frequency 0.15 MHz-30 MHz.

6.8 Unwanted Emissions below 1 GHz

6.8.1 Test Setup

For Radiated emission below 30 MHz

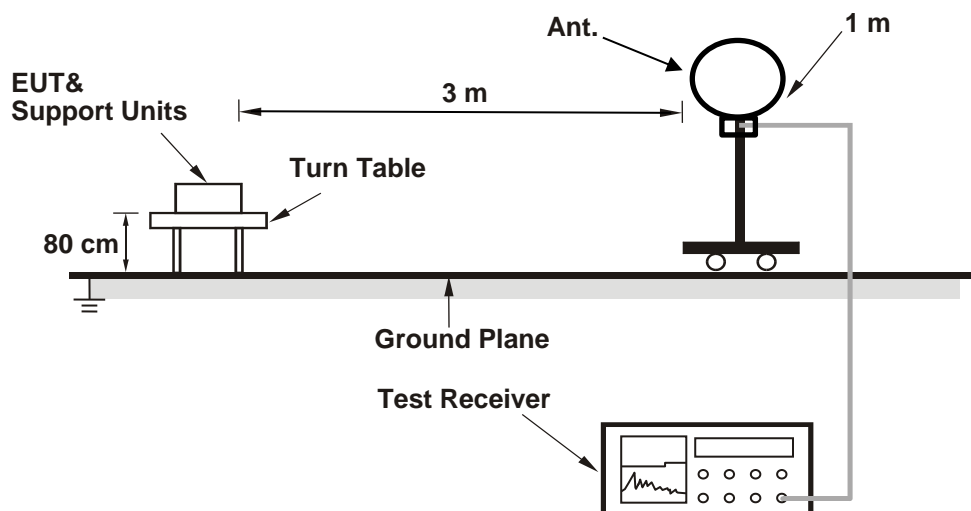

For Radiated emission above 30 MHz

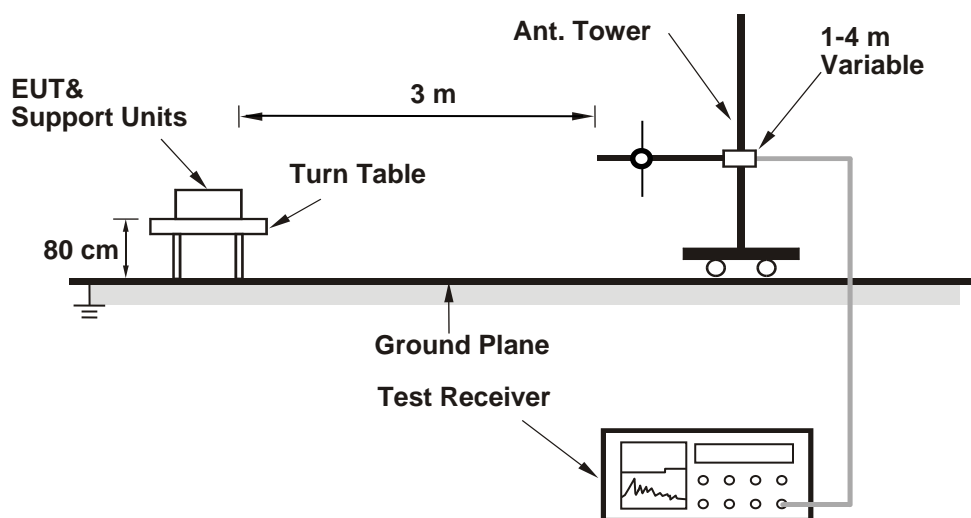

For the actual test configuration, please refer to the attached file (Test Setup Photo).

6.8.2 Test Procedure

For Radiated emission below 30 MHz

- a. The EUT was placed on the top of a rotating table 0.8 meters above the ground at 3 meter chamber room for test. The table was rotated 360 degrees to determine the position of the highest radiation.
- b. The EUT was set 3 meters away from the interference-receiving antenna, which was mounted on the top of a variable-height antenna tower.
- c. Parallel, perpendicular, and ground-parallel orientations of the antenna are set to make the measurement.
- d. For each suspected emission, the EUT was arranged to its worst case and the rotatable table was turned from 0 degrees to 360 degrees to find the maximum reading.
- e. The test-receiver system was set to Quasi-Peak Detect Function and Specified Bandwidth with Maximum Hold Mode, except for the frequency band (9 kHz to 90 kHz and 110 kHz to 490 kHz) set to average detect function and peak detect function.

Notes:

1. The resolution bandwidth and video bandwidth of test receiver/spectrum analyzer is 200 Hz at frequency below 150 kHz.
2. The resolution bandwidth and video bandwidth of test receiver/spectrum analyzer is 9 kHz or 10 kHz at frequency (150 kHz to 30 MHz).
3. All modes of operation were investigated and the worst-case emissions are reported.

For Radiated emission above 30 MHz

- a. The EUT was placed on the top of a rotating table 0.8 meters above the ground at 3 meter chamber room for test. The table was rotated 360 degrees to determine the position of the highest radiation.
- b. The EUT was set 3 meters away from the interference-receiving antenna, which was mounted on the top of a variable-height antenna tower.
- c. The height of antenna is varied from one meter to four meters above the ground to determine the maximum value of the field strength. Both horizontal and vertical polarizations of the antenna are set to make the measurement.
- d. For each suspected emission, the EUT was arranged to its worst case and then the antenna was tuned to heights from 1 meter to 4 meters and the rotatable table was turned from 0 degrees to 360 degrees to find the maximum reading.
- e. The test-receiver system was set to quasi-peak detect function and specified bandwidth with maximum hold mode when the test frequency is below 1 GHz.

Notes:

1. The resolution bandwidth and video bandwidth of test receiver/spectrum analyzer is 120 kHz for Quasi-peak detection (QP) at frequency below 1 GHz.
2. All modes of operation were investigated and the worst-case emissions are reported.

6.9 Unwanted Emissions above 1 GHz

6.9.1 Test Setup

For Radiated emission above 1 GHz

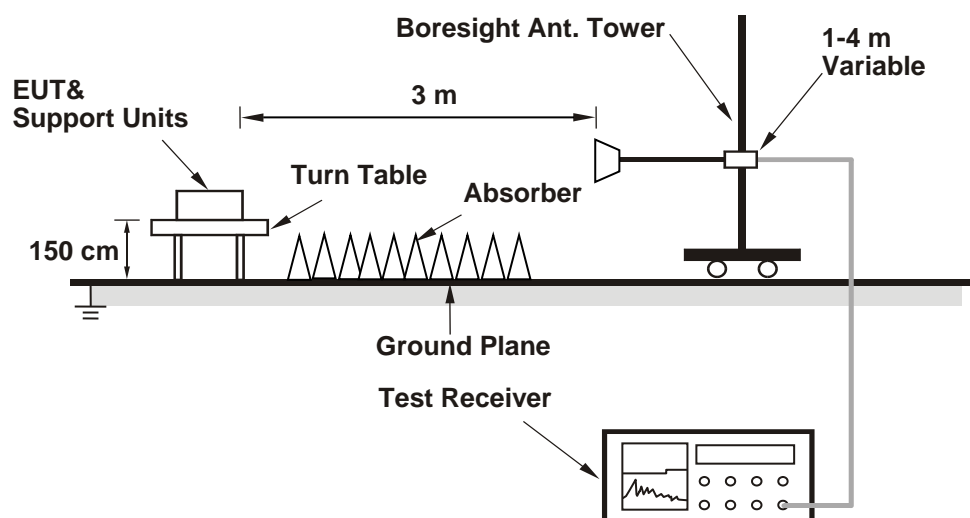

For the actual test configuration, please refer to the attached file (Test Setup Photo).

6.9.2 Test Procedure

- The EUT was placed on the top of a rotating table 1.5 meters above the ground at 3 meter chamber room for test. The table was rotated 360 degrees to determine the position of the highest radiation.
- The EUT was set 3 meters away from the interference-receiving antenna, which was mounted on the top of a variable-height antenna tower.
- The height of antenna is varied from one meter to four meters above the ground to determine the maximum value of the field strength. Both horizontal and vertical polarizations of the antenna are set to make the measurement.
- For each suspected emission, the EUT was arranged to its worst case and then the antenna was tuned to heights from 1 meter to 4 meters and the rotatable table was turned from 0 degrees to 360 degrees to find the maximum reading.
- The test-receiver system was set to peak and average detects function and specified bandwidth with maximum hold mode when the test frequency is above 1 GHz. If the peak reading value also meets average limit, measurement with the average detector is unnecessary.

Notes:

- The resolution bandwidth of test receiver/spectrum analyzer is 1 MHz and the video bandwidth is 3 MHz for Peak detection (PK) and Average detection (AV) at frequency above 1 GHz.
- According to ANSI C63.10 section 6.6.4 and 4.1.4.2.2. For fundamental and harmonic signal measurement, according to ANSI C63.10 section 7.5, the average value = peak value + duty cycle correction factor. For duty cycle correction factor values, see the Test Signal Duty Cycle section in this report.
- All modes of operation were investigated and the worst-case emissions are reported.

7 Test Results of Test Item

7.1 RF Output Power

Input Power:	120 Vac, 60 Hz	Environmental Conditions:	25°C, 76% RH	Tested By:	Waydi Tuan
--------------	----------------	---------------------------	--------------	------------	------------

Mode A

For Peak Power

GFSK

Chan.	Chan. Freq. (MHz)	Peak Power (mW)	Peak Power (dBm)	Power Limit (dBm)	Test Result
0	2402	3.006	4.78	21	Pass
39	2441	2.455	3.90	21	Pass
78	2480	1.963	2.93	21	Pass

Note: The antenna gain is 2.78 dBi < 6 dBi, so the output power limit shall not be reduced.

8DPSK

Chan.	Chan. Freq. (MHz)	Peak Power (mW)	Peak Power (dBm)	Power Limit (dBm)	Test Result
0	2402	2.992	4.76	21	Pass
39	2441	2.455	3.90	21	Pass
78	2480	2.000	3.01	21	Pass

Note: The antenna gain is 2.78 dBi < 6 dBi, so the output power limit shall not be reduced.

For Average Power

GFSK

Chan.	Chan. Freq. (MHz)	Average Power (mW)	Average Power (dBm)
0	2402	2.931	4.67
39	2441	2.399	3.80
78	2480	1.936	2.87

8DPSK

Chan.	Chan. Freq. (MHz)	Average Power (mW)	Average Power (dBm)
0	2402	2.911	4.64
39	2441	2.388	3.78
78	2480	1.936	2.87

7.2 Number of Hopping Frequency Used

Input Power:	120 Vac, 60 Hz	Environmental Conditions:	25°C, 76% RH	Tested By:	Waydi Tuan
--------------	----------------	---------------------------	--------------	------------	------------

Mode A

GFSK

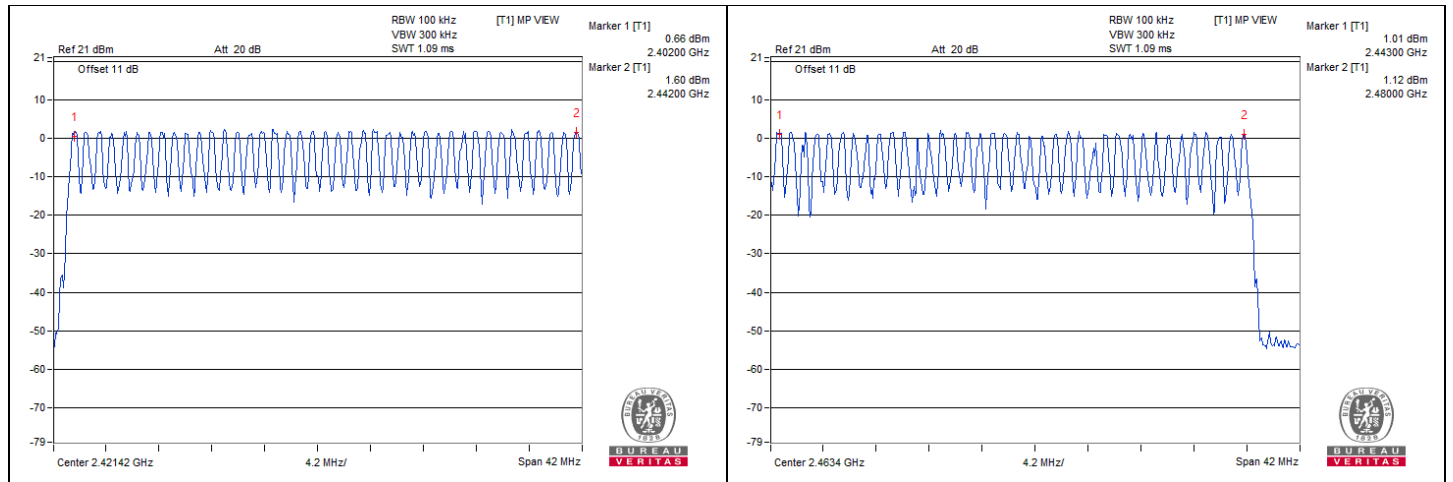

Note: There are 79 hopping frequencies in the hopping mode. On the plots, it shows that the hopping frequencies are equally spaced.

8DPSK

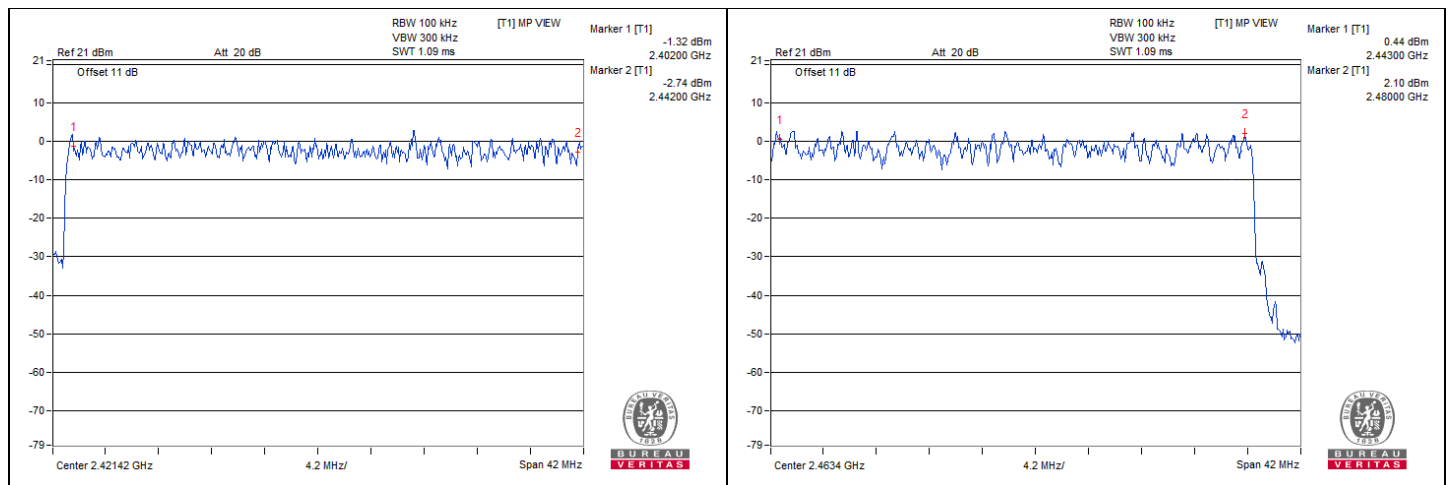

Note: There are 79 hopping frequencies in the hopping mode. On the plots, it shows that the hopping frequencies are equally spaced.



7.3 Dwell Time on Each Channel

Input Power:	120 Vac, 60 Hz	Environmental Conditions:	25°C, 76% RH	Tested By:	Waydi Tuan
--------------	----------------	---------------------------	--------------	------------	------------

Mode A

GFSK

Mode	Number of transmission in 31.6 sec	Length of transmission time (msec)	Result (msec)	Limit (msec)	Test Result
DH1	51 (times / 5 sec) * 6.32 = 323 times	0.444	143.41	400	Pass
DH3	25 (times / 5 sec) * 6.32 = 158 times	1.68	265.44	400	Pass
DH5	17 (times / 5 sec) * 6.32 = 108 times	2.952	318.82	400	Pass

Spectrum plots of Dwell Time



8DPSK

Mode	Number of transmission in 31.6 sec	Length of transmission time (msec)	Result (msec)	Limit (msec)	Test Result
3DH1	51 (times / 5 sec) * 6.32 = 323 times	0.438	141.47	400	Pass
3DH3	26 (times / 5 sec) * 6.32 = 165 times	1.7	280.5	400	Pass
3DH5	17 (times / 5 sec) * 6.32 = 108 times	2.968	320.54	400	Pass

Spectrum plots of Dwell Time



7.4 Hopping Channel Separation

Input Power:	120 Vac, 60 Hz	Environmental Conditions:	25°C, 76% RH	Tested By:	Waydi Tuan
--------------	----------------	---------------------------	--------------	------------	------------

Mode A

GFSK

Channel	Frequency (MHz)	Hopping Channel Separation (MHz)	Minimum Limit (MHz)	Test Result
0	2402	1	0.58	Pass
39	2441	1	0.62	Pass
78	2480	1	0.58	Pass

Note: The minimum limit is two-third 20dB bandwidth.

8DPSK

Channel	Frequency (MHz)	Hopping Channel Separation (MHz)	Minimum Limit (MHz)	Test Result
0	2402	1	0.85	Pass
39	2441	1	0.85	Pass
78	2480	1	0.85	Pass

Note: The minimum limit is two-third 20dB bandwidth.

Spectrum Plot of Minimum Value

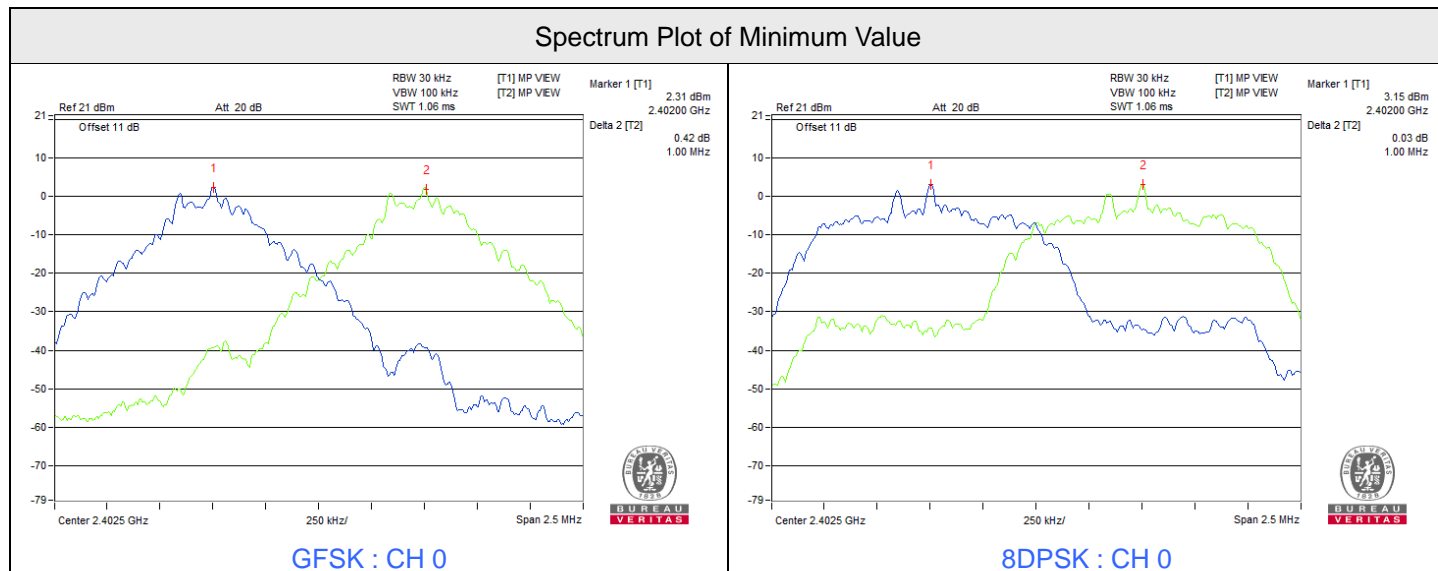

7.5 20 dB Bandwidth

Input Power:	120 Vac, 60 Hz	Environmental Conditions:	25°C, 76% RH	Tested By:	Waydi Tuan
--------------	----------------	---------------------------	--------------	------------	------------

Mode A

GFSK

Channel	Frequency (MHz)	20dB Bandwidth (MHz)
0	2402	0.87
39	2441	0.92
78	2480	0.87

8DPSK

Channel	Frequency (MHz)	20dB Bandwidth (MHz)
0	2402	1.27
39	2441	1.27
78	2480	1.27

Spectrum Plot of Maximum Value

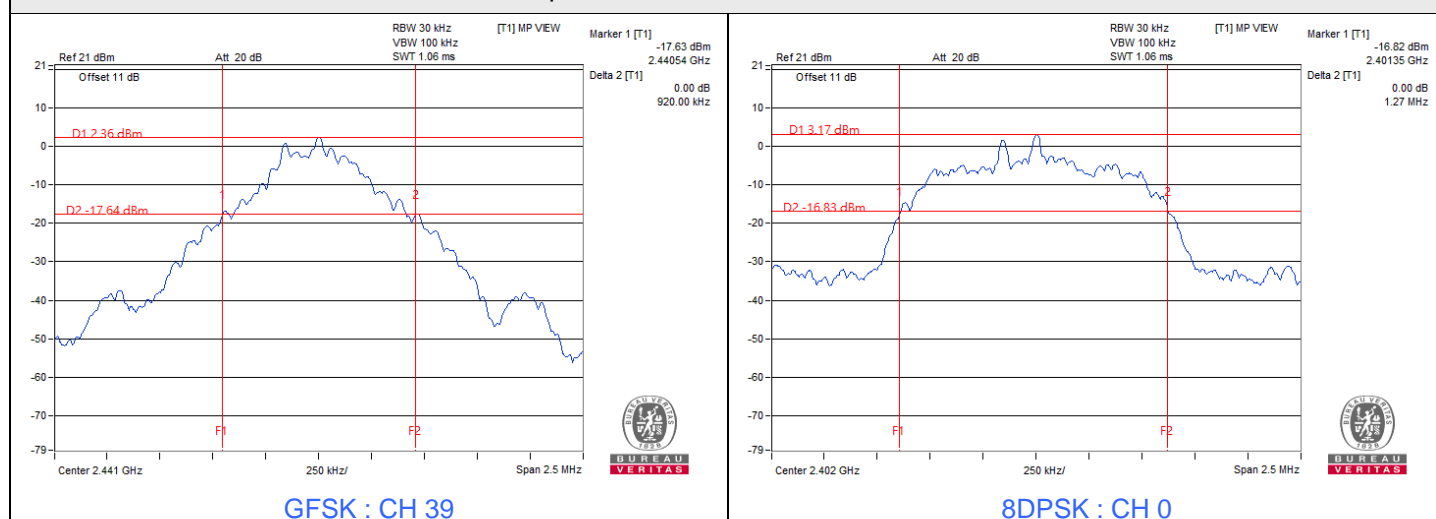



BUREAU VERITAS

7.6 Conducted Out of Band Emissions

Input Power:	120 Vac, 60 Hz	Environmental Conditions:	25°C, 76% RH	Tested By:	Waydi Tuan
--------------	----------------	---------------------------	--------------	------------	------------

Mode A

GFSK

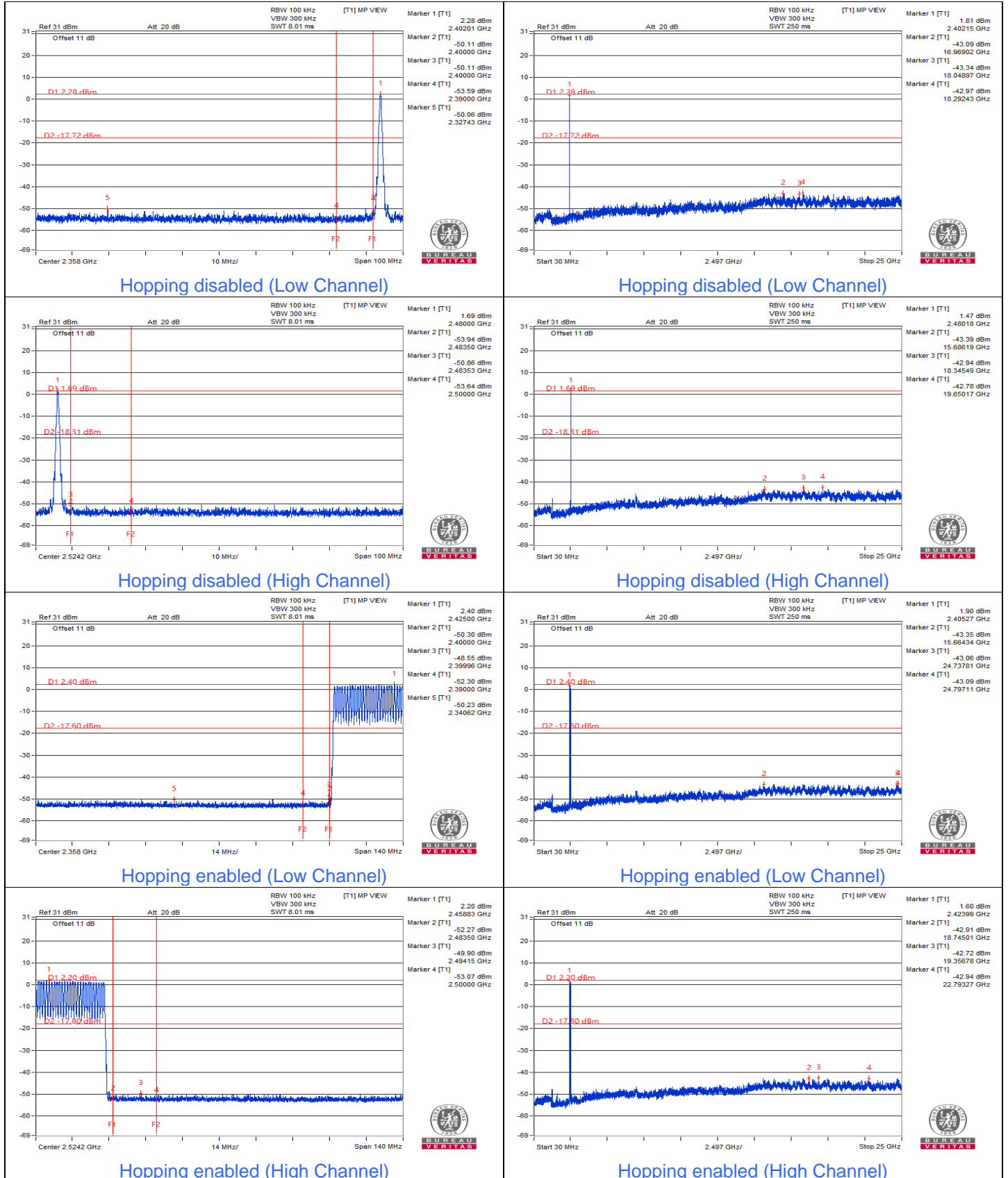



8DPSK

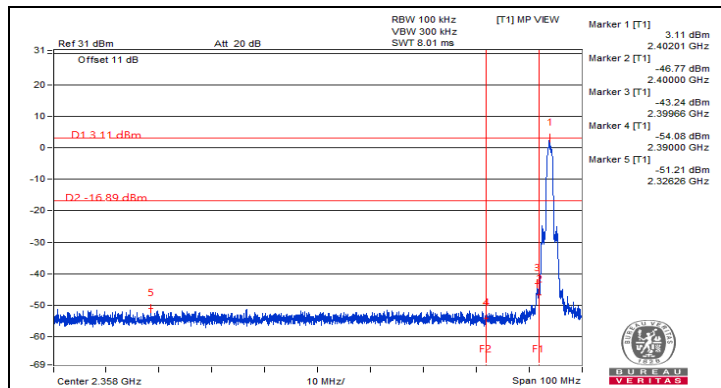

Hopping disabled (Low Channel)

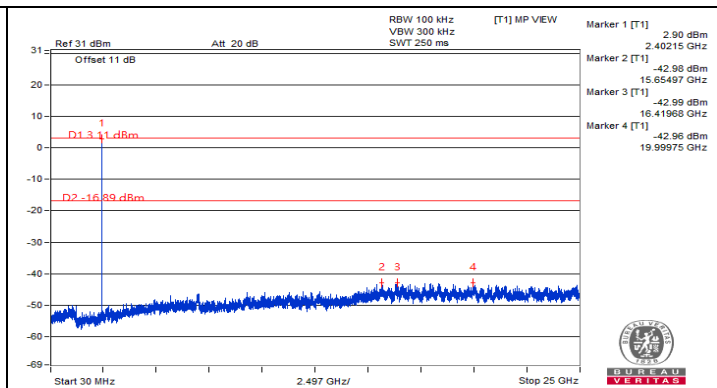

Hopping disabled (Low Channel)

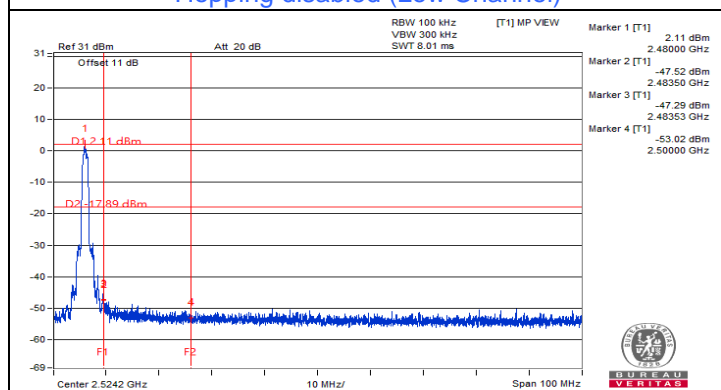

Hopping disabled (High Channel)

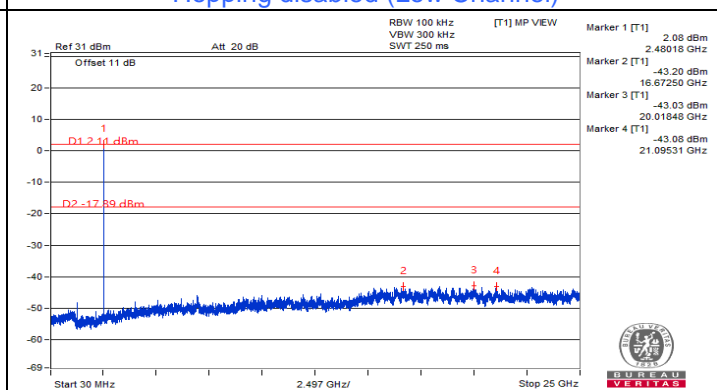

Hopping disabled (High Channel)

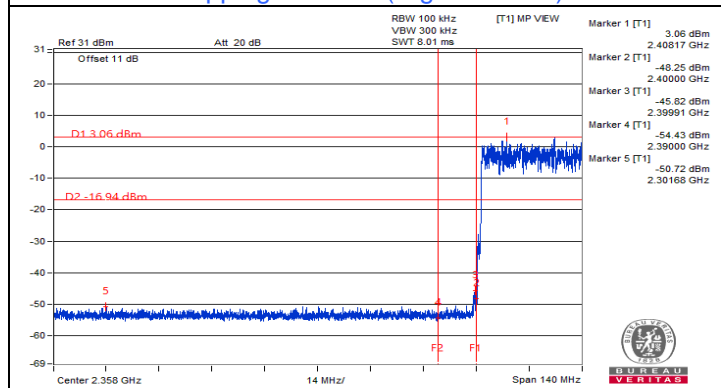

Hopping enabled (Low Channel)

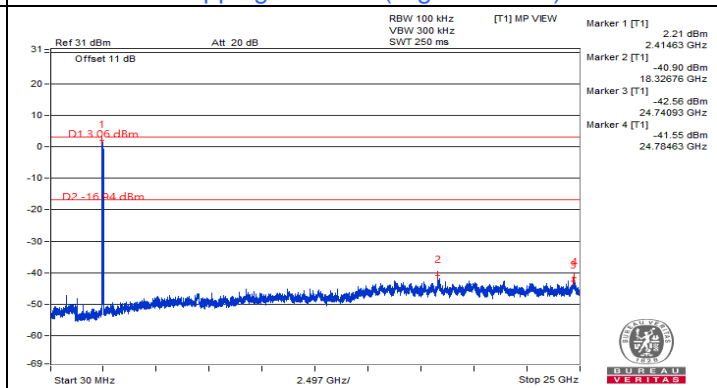

Hopping enabled (Low Channel)

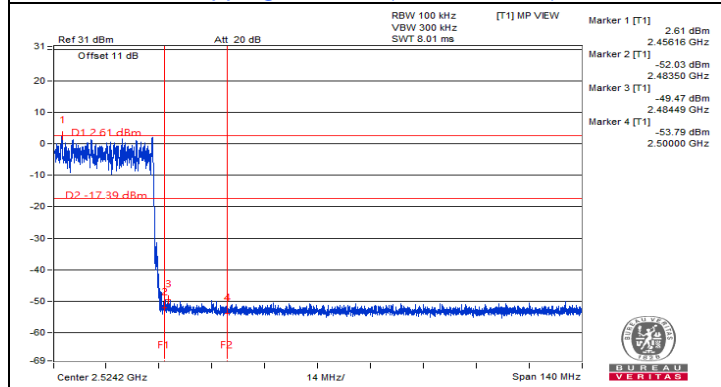

Hopping enabled (High Channel)

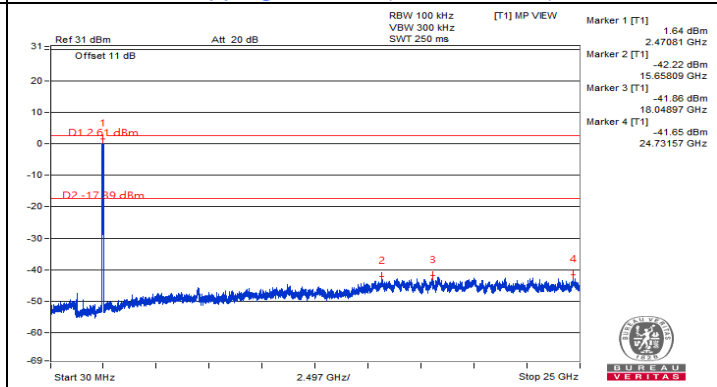

Hopping enabled (High Channel)

7.7 AC Power Conducted Emissions

Mode A

RF Mode	TX BT GFSK	Channel	CH 0 : 2402 MHz
Frequency Range	150 kHz ~ 30 MHz	Detector Function & Resolution Bandwidth	Quasi-Peak (QP) / Average (AV), 9 kHz
Input Power	120 Vac, 60 Hz	Environmental Conditions	22.7°C, 57.1% RH
Tested By	Jed Wu		

Phase Of Power : Line (L)										
No	Frequency (MHz)	Correction Factor (dB)	Reading Value (dBuV)		Emission Level (dBuV)		Limit (dBuV)		Margin (dB)	
			Q.P.	AV.	Q.P.	AV.	Q.P.	AV.	Q.P.	AV.
1	0.16172	9.90	32.02	16.34	41.92	26.24	65.38	55.38	-23.46	-29.14
2	0.23203	9.91	23.90	12.88	33.81	22.79	62.38	52.38	-28.57	-29.59
3	0.45859	9.93	23.37	19.11	33.30	29.04	56.72	46.72	-23.42	-17.68
4	0.75938	9.95	14.49	8.67	24.44	18.62	56.00	46.00	-31.56	-27.38
5	3.61328	10.12	22.60	14.27	32.72	24.39	56.00	46.00	-23.28	-21.61
6	8.76172	10.34	30.18	23.13	40.52	33.47	60.00	50.00	-19.48	-16.53

Remarks:

1. Q.P. and AV. are abbreviations of quasi-peak and average individually.
2. The emission levels of other frequencies were very low against the limit.
3. Margin value = Emission level – Limit value
4. Correction factor = Insertion loss + Cable loss
5. Emission Level = Correction Factor + Reading Value

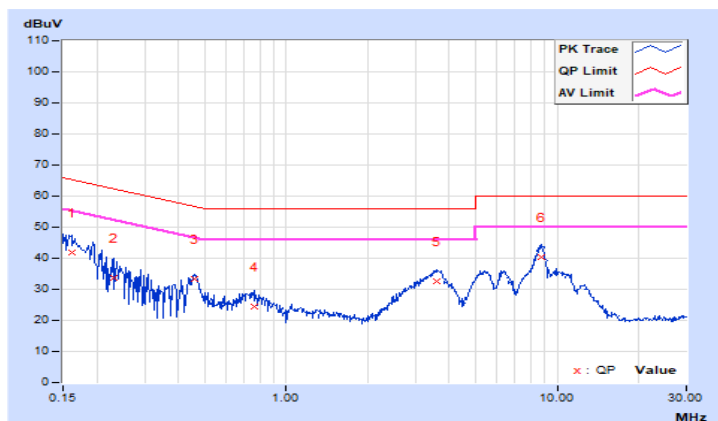

RF Mode	TX BT GFSK	Channel	CH 0 : 2402 MHz
Frequency Range	150 kHz ~ 30 MHz	Detector Function & Resolution Bandwidth	Quasi-Peak (QP) / Average (AV), 9 kHz
Input Power	120 Vac, 60 Hz	Environmental Conditions	22.7°C, 57.1% RH
Tested By	Jed Wu		

Phase Of Power : Neutral (N)										
No	Frequency (MHz)	Correction Factor (dB)	Reading Value (dBuV)		Emission Level (dBuV)		Limit (dBuV)		Margin (dB)	
			Q.P.	AV.	Q.P.	AV.	Q.P.	AV.	Q.P.	AV.
1	0.17734	9.92	27.83	12.76	37.75	22.68	64.61	54.61	-26.86	-31.93
2	0.25938	9.93	20.81	8.55	30.74	18.48	61.45	51.45	-30.71	-32.97
3	0.45859	9.95	21.38	13.12	31.33	23.07	56.72	46.72	-25.39	-23.65
4	0.73203	9.97	14.62	7.69	24.59	17.66	56.00	46.00	-31.41	-28.34
5	3.77734	10.14	23.22	12.27	33.36	22.41	56.00	46.00	-22.64	-23.59
6	8.68359	10.33	27.21	18.71	37.54	29.04	60.00	50.00	-22.46	-20.96

Remarks:

1. Q.P. and AV. are abbreviations of quasi-peak and average individually.
2. The emission levels of other frequencies were very low against the limit.
3. Margin value = Emission level – Limit value
4. Correction factor = Insertion loss + Cable loss
5. Emission Level = Correction Factor + Reading Value

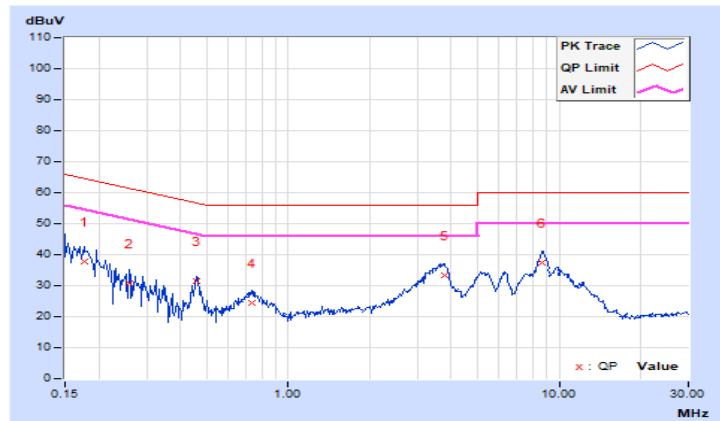

Mode B

RF Mode	TX BT GFSK	Channel	CH 0 : 2402 MHz
Frequency Range	150 kHz ~ 30 MHz	Detector Function & Resolution Bandwidth	Quasi-Peak (QP) / Average (AV), 9 kHz
Input Power	120 Vac, 60 Hz	Environmental Conditions	22.7°C, 57.1% RH
Tested By	Jed Wu		

Phase Of Power : Line (L)

No	Frequency (MHz)	Correction Factor (dB)	Reading Value (dBuV)		Emission Level (dBuV)		Limit (dBuV)		Margin (dB)	
			Q.P.	AV.	Q.P.	AV.	Q.P.	AV.	Q.P.	AV.
1	0.15781	9.90	22.22	0.61	32.12	10.51	65.58	55.58	-33.46	-45.07
2	0.25547	9.92	20.38	4.06	30.30	13.98	61.58	51.58	-31.28	-37.60
3	0.34141	9.92	16.87	1.08	26.79	11.00	59.17	49.17	-32.38	-38.17
4	0.76719	9.95	18.70	9.71	28.65	19.66	56.00	46.00	-27.35	-26.34
5	3.52344	10.12	15.14	0.51	25.26	10.63	56.00	46.00	-30.74	-35.37
6	10.64063	10.41	17.85	3.66	28.26	14.07	60.00	50.00	-31.74	-35.93

Remarks:

1. Q.P. and AV. are abbreviations of quasi-peak and average individually.
2. The emission levels of other frequencies were very low against the limit.
3. Margin value = Emission level – Limit value
4. Correction factor = Insertion loss + Cable loss
5. Emission Level = Correction Factor + Reading Value

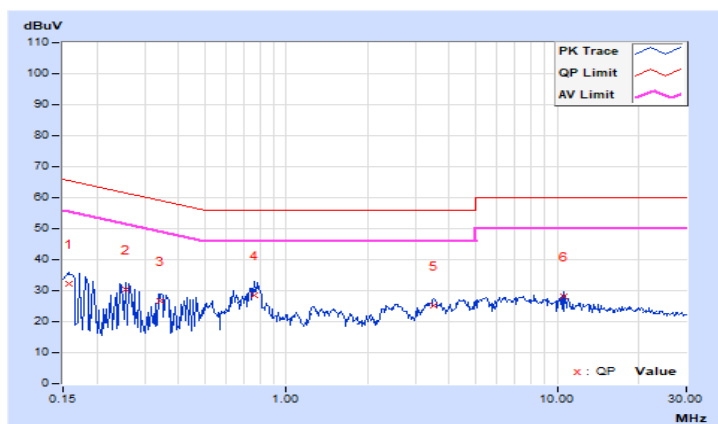

RF Mode	TX BT GFSK	Channel	CH 0 : 2402 MHz
Frequency Range	150 kHz ~ 30 MHz	Detector Function & Resolution Bandwidth	Quasi-Peak (QP) / Average (AV), 9 kHz
Input Power	120 Vac, 60 Hz	Environmental Conditions	22.7°C, 57.1% RH
Tested By	Jed Wu		

Phase Of Power : Neutral (N)										
No	Frequency (MHz)	Correction Factor (dB)	Reading Value (dBuV)		Emission Level (dBuV)		Limit (dBuV)		Margin (dB)	
			Q.P.	AV.	Q.P.	AV.	Q.P.	AV.	Q.P.	AV.
1	0.17344	9.91	23.49	0.91	33.40	10.82	64.79	54.79	-31.39	-43.97
2	0.24766	9.93	20.45	2.23	30.38	12.16	61.84	51.84	-31.46	-39.68
3	0.35703	9.94	16.88	0.18	26.82	10.12	58.80	48.80	-31.98	-38.68
4	0.77109	9.97	16.53	9.14	26.50	19.11	56.00	46.00	-29.50	-26.89
5	3.55859	10.13	13.06	0.66	23.19	10.79	56.00	46.00	-32.81	-35.21
6	7.37891	10.28	14.01	0.72	24.29	11.00	60.00	50.00	-35.71	-39.00

Remarks:

1. Q.P. and AV. are abbreviations of quasi-peak and average individually.
2. The emission levels of other frequencies were very low against the limit.
3. Margin value = Emission level – Limit value
4. Correction factor = Insertion loss + Cable loss
5. Emission Level = Correction Factor + Reading Value

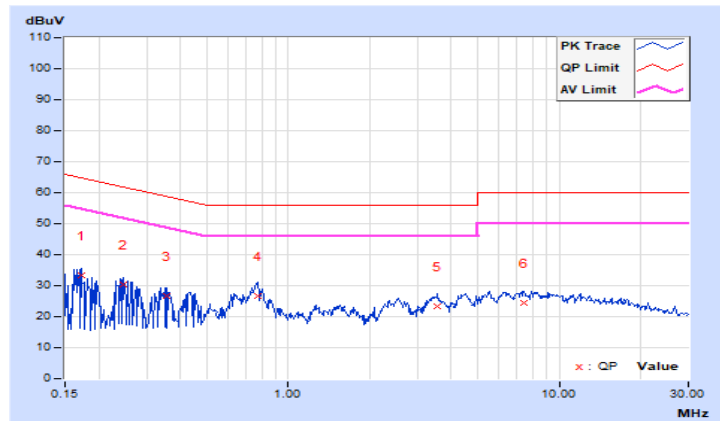

7.8 Unwanted Emissions below 1 GHz

Mode A

RF Mode	TX BT GFSK	Channel	CH 0 : 2402 MHz
Frequency Range	9 kHz ~ 1 GHz	Detector Function & Bandwidth	(QP) RB = 120kHz
Input Power	120 Vac, 60 Hz	Environmental Conditions	22°C, 67% RH
Tested By	Jed Wu		

Antenna Polarity & Test Distance : Horizontal at 3 m

No	Frequency (MHz)	Emission Level (dBuV/m)	Limit (dBuV/m)	Margin (dB)	Antenna Height (m)	Table Angle (Degree)	Raw Value (dBuV)	Correction Factor (dB/m)
1	37.71	21.8 QP	40.0	-18.2	1.63 H	284	31.3	-9.5
2	154.55	22.9 QP	43.5	-20.6	1.42 H	334	30.7	-7.8
3	299.95	28.6 QP	46.0	-17.4	1.72 H	37	34.4	-5.8
4	397.92	26.4 QP	46.0	-19.6	1.88 H	82	30.0	-3.6
5	470.62	29.0 QP	46.0	-17.0	1.36 H	192	30.8	-1.8
6	545.31	29.4 QP	46.0	-16.6	1.28 H	209	30.2	-0.8

Remarks:

1. Emission Level(dBuV/m) = Raw Value(dBuV) + Correction Factor(dB/m)
2. Correction Factor(dB/m) = Antenna Factor(dB/m) + Cable Factor(dB) – Pre-Amplifier Factor(dB)
3. Margin value = Emission Level – Limit value
4. The other emission levels were very low against the limit of frequency range 30 MHz ~ 1 GHz.
5. The emission levels were very low against the limit of frequency range 9 kHz ~ 30 MHz: the amplitude of spurious emissions attenuated more than 20 dB below the permissible value to be report.

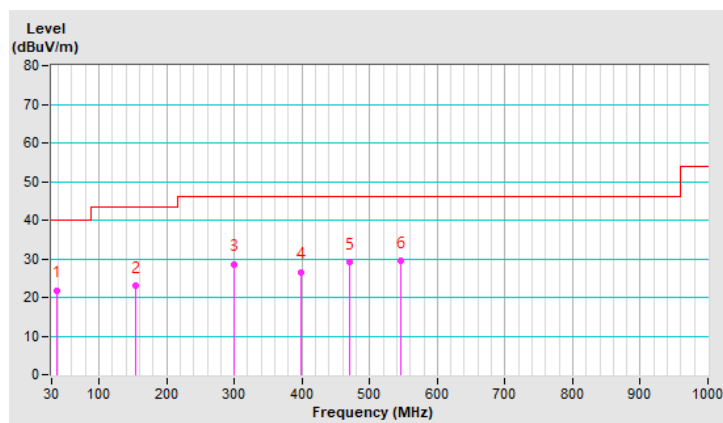

RF Mode	TX BT GFSK	Channel	CH 0 : 2402 MHz
Frequency Range	9 kHz ~ 1 GHz	Detector Function & Bandwidth	(QP) RB = 120kHz
Input Power	120 Vac, 60 Hz	Environmental Conditions	22°C, 67% RH
Tested By	Jed Wu		

Antenna Polarity & Test Distance : Vertical at 3 m								
No	Frequency (MHz)	Emission Level (dBuV/m)	Limit (dBuV/m)	Margin (dB)	Antenna Height (m)	Table Angle (Degree)	Raw Value (dBuV)	Correction Factor (dB/m)
1	30.58	23.7 QP	40.0	-16.3	1.35 V	326	34.1	-10.4
2	66.62	22.9 QP	40.0	-17.1	1.20 V	210	32.6	-9.7
3	147.03	22.6 QP	43.5	-20.9	1.18 V	89	30.6	-8.0
4	260.42	23.1 QP	46.0	-22.9	1.79 V	106	30.6	-7.5
5	325.95	24.6 QP	46.0	-21.4	1.56 V	360	29.6	-5.0
6	393.56	26.9 QP	46.0	-19.1	1.88 V	21	30.6	-3.7

Remarks:

1. Emission Level(dBuV/m) = Raw Value(dBuV) + Correction Factor(dB/m)
2. Correction Factor(dB/m) = Antenna Factor(dB/m) + Cable Factor(dB) – Pre-Amplifier Factor(dB)
3. Margin value = Emission Level – Limit value
4. The other emission levels were very low against the limit of frequency range 30 MHz ~ 1 GHz.
5. The emission levels were very low against the limit of frequency range 9 kHz ~ 30 MHz: the amplitude of spurious emissions attenuated more than 20 dB below the permissible value to be report.

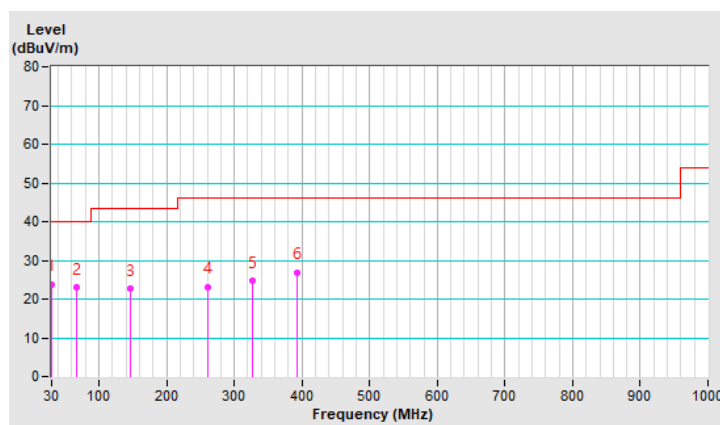

7.9 Unwanted Emissions above 1 GHz

Mode A

RF Mode	TX BT GFSK	Channel	CH 0 : 2402 MHz
Frequency Range	1 GHz ~ 25 GHz	Detector Function & Bandwidth	(PK) RB = 1 MHz, VB = 3 MHz (AV) RB = 1 MHz, VB = 3 MHz (RMS)
Input Power	120 Vac, 60 Hz	Environmental Conditions	22°C, 67% RH
Tested By	Jed Wu		

Antenna Polarity & Test Distance : Horizontal at 3 m								
No	Frequency (MHz)	Emission Level (dBUV/m)	Limit (dBUV/m)	Margin (dB)	Antenna Height (m)	Table Angle (Degree)	Raw Value (dBUV)	Correction Factor (dB/m)
1	2390.00	53.2 PK	74.0	-20.8	1.27 H	100	55.5	-2.3
2	2390.00	43.0 AV	54.0	-11.0	1.27 H	100	45.3	-2.3
3	*2402.00	107.8 PK			1.27 H	100	110.1	-2.3
4	*2402.00	77.0 AV			1.27 H	100	79.3	-2.3
5	4804.00	48.8 PK	74.0	-25.2	2.34 H	133	43.3	5.5
6	4804.00	18.0 AV	54.0	-36.0	2.34 H	133	12.5	5.5

Remarks:

- Emission Level(dBUV/m) = Raw Value(dBUV) + Correction Factor(dB/m)
- Correction Factor(dB/m) = Antenna Factor(dB/m) + Cable Factor(dB) – Pre-Amplifier Factor(dB)
- Margin value = Emission Level – Limit value
- The other emission levels were very low against the limit.
- " * " : Fundamental frequency, the limit was restricted at the RF Output Power.
- The average value of fundamental and harmonic frequency is: Average = Peak value + 20 log(Duty cycle) Where the duty cycle correction factor is calculated from following formula:
 $20 \log(\text{Duty cycle}) = 20 \log(2.9 \text{ ms} / 100 \text{ ms}) = -30.8 \text{ dB}$

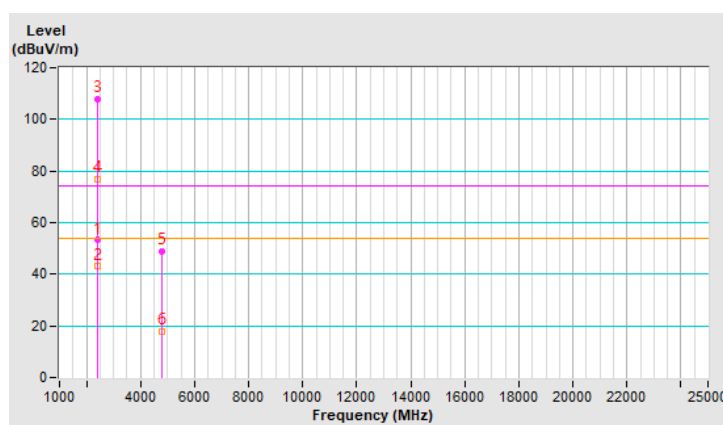

RF Mode	TX BT GFSK	Channel	CH 0 : 2402 MHz
Frequency Range	1 GHz ~ 25 GHz	Detector Function & Bandwidth	(PK) RB = 1 MHz, VB = 3 MHz (AV) RB = 1 MHz, VB = 3 MHz (RMS)
Input Power	120 Vac, 60 Hz	Environmental Conditions	22°C, 67% RH
Tested By	Jed Wu		

Antenna Polarity & Test Distance : Vertical at 3 m								
No	Frequency (MHz)	Emission Level (dBuV/m)	Limit (dBuV/m)	Margin (dB)	Antenna Height (m)	Table Angle (Degree)	Raw Value (dBuV)	Correction Factor (dB/m)
1	2390.00	52.4 PK	74.0	-21.6	1.66 V	173	54.7	-2.3
2	2390.00	41.6 AV	54.0	-12.4	1.66 V	173	43.9	-2.3
3	*2402.00	103.2 PK			1.66 V	173	105.5	-2.3
4	*2402.00	72.4 AV			1.66 V	173	74.7	-2.3
5	4804.00	48.3 PK	74.0	-25.7	2.08 V	199	42.8	5.5
6	4804.00	17.5 AV	54.0	-36.5	2.08 V	199	12.0	5.5

Remarks:

1. Emission Level(dBuV/m) = Raw Value(dBuV) + Correction Factor(dB/m)
2. Correction Factor(dB/m) = Antenna Factor(dB/m) + Cable Factor(dB) – Pre-Amplifier Factor(dB)
3. Margin value = Emission Level – Limit value
4. The other emission levels were very low against the limit.
5. " * " : Fundamental frequency, the limit was restricted at the RF Output Power.
6. The average value of fundamental and harmonic frequency is: Average = Peak value + 20 log(Duty cycle) Where the duty cycle correction factor is calculated from following formula:
 $20 \log(\text{Duty cycle}) = 20 \log(2.9 \text{ ms} / 100 \text{ ms}) = -30.8 \text{ dB}$

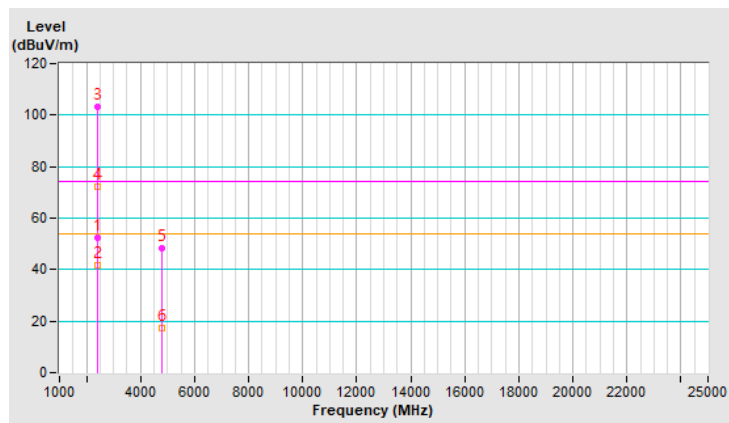

RF Mode	TX BT GFSK	Channel	CH 39 : 2441 MHz
Frequency Range	1 GHz ~ 25 GHz	Detector Function & Bandwidth	(PK) RB = 1 MHz, VB = 3 MHz (AV) RB = 1 MHz, VB = 3 MHz (RMS)
Input Power	120 Vac, 60 Hz	Environmental Conditions	22°C, 67% RH
Tested By	Jed Wu		

Antenna Polarity & Test Distance : Horizontal at 3 m

No	Frequency (MHz)	Emission Level (dBuV/m)	Limit (dBuV/m)	Margin (dB)	Antenna Height (m)	Table Angle (Degree)	Raw Value (dBuV)	Correction Factor (dB/m)
1	*2441.00	108.5 PK			1.25 H	98	110.7	-2.2
2	*2441.00	77.7 AV			1.25 H	98	79.9	-2.2
3	4882.00	49.3 PK	74.0	-24.7	2.32 H	136	43.7	5.6
4	4882.00	18.5 AV	54.0	-35.5	2.32 H	136	12.9	5.6

Remarks:

1. Emission Level(dBuV/m) = Raw Value(dBuV) + Correction Factor(dB/m)
2. Correction Factor(dB/m) = Antenna Factor(dB/m) + Cable Factor(dB) – Pre-Amplifier Factor(dB)
3. Margin value = Emission Level – Limit value
4. The other emission levels were very low against the limit.
5. " * " : Fundamental frequency, the limit was restricted at the RF Output Power.
6. The average value of fundamental and harmonic frequency is: Average = Peak value + 20 log(Duty cycle) Where the duty cycle correction factor is calculated from following formula:
 $20 \log(\text{Duty cycle}) = 20 \log(2.9 \text{ ms} / 100 \text{ ms}) = -30.8 \text{ dB}$

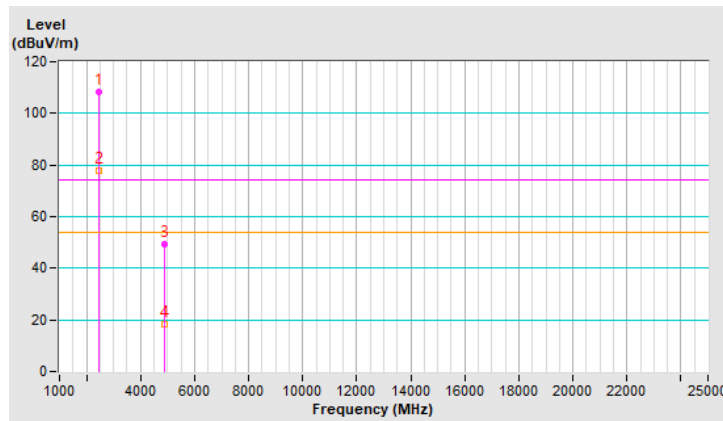

RF Mode	TX BT GFSK	Channel	CH 39 : 2441 MHz
Frequency Range	1 GHz ~ 25 GHz	Detector Function & Bandwidth	(PK) RB = 1 MHz, VB = 3 MHz (AV) RB = 1 MHz, VB = 3 MHz (RMS)
Input Power	120 Vac, 60 Hz	Environmental Conditions	22°C, 67% RH
Tested By	Jed Wu		

Antenna Polarity & Test Distance : Vertical at 3 m								
No	Frequency (MHz)	Emission Level (dBuV/m)	Limit (dBuV/m)	Margin (dB)	Antenna Height (m)	Table Angle (Degree)	Raw Value (dBuV)	Correction Factor (dB/m)
1	*2441.00	104.1 PK			1.62 V	177	106.3	-2.2
2	*2441.00	73.3 AV			1.62 V	177	75.5	-2.2
3	4882.00	48.8 PK	74.0	-25.2	2.04 V	195	43.2	5.6
4	4882.00	18.0 AV	54.0	-36.0	2.04 V	195	12.4	5.6

Remarks:

1. Emission Level(dBuV/m) = Raw Value(dBuV) + Correction Factor(dB/m)
2. Correction Factor(dB/m) = Antenna Factor(dB/m) + Cable Factor(dB) – Pre-Amplifier Factor(dB)
3. Margin value = Emission Level – Limit value
4. The other emission levels were very low against the limit.
5. " * " : Fundamental frequency, the limit was restricted at the RF Output Power.
6. The average value of fundamental and harmonic frequency is: Average = Peak value + 20 log(Duty cycle) Where the duty cycle correction factor is calculated from following formula:
 $20 \log(\text{Duty cycle}) = 20 \log(2.9 \text{ ms} / 100 \text{ ms}) = -30.8 \text{ dB}$

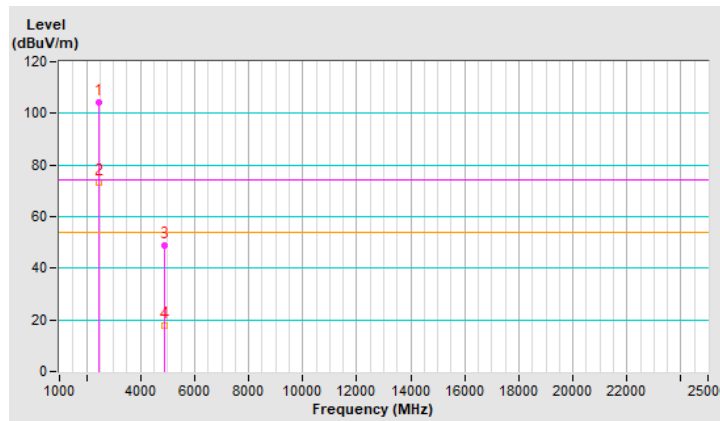

RF Mode	TX BT GFSK	Channel	CH 78 : 2480 MHz
Frequency Range	1 GHz ~ 25 GHz	Detector Function & Bandwidth	(PK) RB = 1 MHz, VB = 3 MHz (AV) RB = 1 MHz, VB = 3 MHz (RMS)
Input Power	120 Vac, 60 Hz	Environmental Conditions	22°C, 67% RH
Tested By	Jed Wu		

Antenna Polarity & Test Distance : Horizontal at 3 m								
No	Frequency (MHz)	Emission Level (dBuV/m)	Limit (dBuV/m)	Margin (dB)	Antenna Height (m)	Table Angle (Degree)	Raw Value (dBuV)	Correction Factor (dB/m)
1	*2480.00	108.8 PK			1.23 H	98	110.9	-2.1
2	*2480.00	78.0 AV			1.23 H	98	80.1	-2.1
3	2483.50	61.6 PK	74.0	-12.4	1.23 H	98	63.7	-2.1
4	2483.50	30.8 AV	54.0	-23.2	1.23 H	98	32.9	-2.1
5	4960.00	50.0 PK	74.0	-24.0	2.31 H	129	44.3	5.7
6	4960.00	19.2 AV	54.0	-34.8	2.31 H	129	13.5	5.7

Remarks:

1. Emission Level(dBuV/m) = Raw Value(dBuV) + Correction Factor(dB/m)
2. Correction Factor(dB/m) = Antenna Factor(dB/m) + Cable Factor(dB) – Pre-Amplifier Factor(dB)
3. Margin value = Emission Level – Limit value
4. The other emission levels were very low against the limit.
5. " * " : Fundamental frequency, the limit was restricted at the RF Output Power.
6. The average value of fundamental and harmonic frequency is: Average = Peak value + 20 log(Duty cycle) Where the duty cycle correction factor is calculated from following formula:
 $20 \log(\text{Duty cycle}) = 20 \log(2.9 \text{ ms} / 100 \text{ ms}) = -30.8 \text{ dB}$

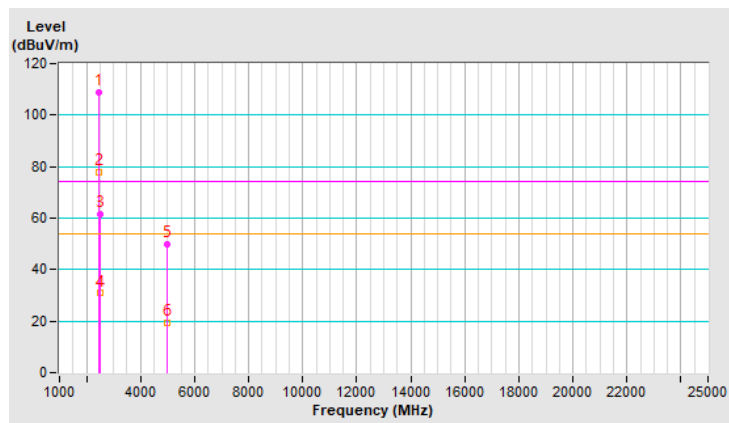

RF Mode	TX BT GFSK	Channel	CH 78 : 2480 MHz
Frequency Range	1 GHz ~ 25 GHz	Detector Function & Bandwidth	(PK) RB = 1 MHz, VB = 3 MHz (AV) RB = 1 MHz, VB = 3 MHz (RMS)
Input Power	120 Vac, 60 Hz	Environmental Conditions	22°C, 67% RH
Tested By	Jed Wu		

Antenna Polarity & Test Distance : Vertical at 3 m								
No	Frequency (MHz)	Emission Level (dBuV/m)	Limit (dBuV/m)	Margin (dB)	Antenna Height (m)	Table Angle (Degree)	Raw Value (dBuV)	Correction Factor (dB/m)
1	*2480.00	104.5 PK			1.60 V	179	106.6	-2.1
2	*2480.00	73.7 AV			1.60 V	179	75.8	-2.1
3	2483.50	59.3 PK	74.0	-14.7	1.60 V	179	61.4	-2.1
4	2483.50	28.5 AV	54.0	-25.5	1.60 V	179	30.6	-2.1
5	4960.00	49.2 PK	74.0	-24.8	2.02 V	193	43.5	5.7
6	4960.00	18.4 AV	54.0	-35.6	2.02 V	193	12.7	5.7

Remarks:

1. Emission Level(dBuV/m) = Raw Value(dBuV) + Correction Factor(dB/m)
2. Correction Factor(dB/m) = Antenna Factor(dB/m) + Cable Factor(dB) – Pre-Amplifier Factor(dB)
3. Margin value = Emission Level – Limit value
4. The other emission levels were very low against the limit.
5. " * " : Fundamental frequency, the limit was restricted at the RF Output Power.
6. The average value of fundamental and harmonic frequency is: Average = Peak value + 20 log(Duty cycle) Where the duty cycle correction factor is calculated from following formula:
 $20 \log(\text{Duty cycle}) = 20 \log(2.9 \text{ ms} / 100 \text{ ms}) = -30.8 \text{ dB}$

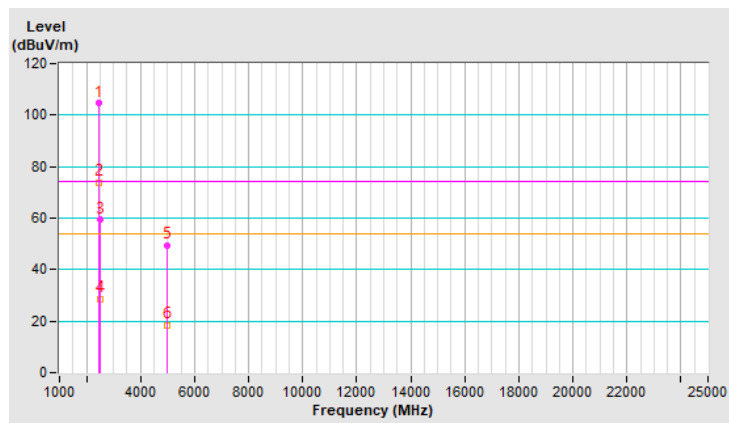

RF Mode	TX BT 8DPSK	Channel	CH 0 : 2402 MHz
Frequency Range	1 GHz ~ 25 GHz	Detector Function & Bandwidth	(PK) RB = 1 MHz, VB = 3 MHz (AV) RB = 1 MHz, VB = 3 MHz (RMS)
Input Power	120 Vac, 60 Hz	Environmental Conditions	22°C, 67% RH
Tested By	Jed Wu		

Antenna Polarity & Test Distance : Horizontal at 3 m								
No	Frequency (MHz)	Emission Level (dBuV/m)	Limit (dBuV/m)	Margin (dB)	Antenna Height (m)	Table Angle (Degree)	Raw Value (dBuV)	Correction Factor (dB/m)
1	2390.00	60.6 PK	74.0	-13.4	1.27 H	98	62.9	-2.3
2	2390.00	47.9 AV	54.0	-6.1	1.27 H	98	50.2	-2.3
3	*2402.00	109.3 PK			1.27 H	98	111.6	-2.3
4	*2402.00	78.5 AV			1.27 H	98	80.8	-2.3
5	4804.00	50.3 PK	74.0	-23.7	2.39 H	140	44.8	5.5
6	4804.00	19.5 AV	54.0	-34.5	2.39 H	140	14.0	5.5

Remarks:

1. Emission Level(dBuV/m) = Raw Value(dBuV) + Correction Factor(dB/m)
2. Correction Factor(dB/m) = Antenna Factor(dB/m) + Cable Factor(dB) – Pre-Amplifier Factor(dB)
3. Margin value = Emission Level – Limit value
4. The other emission levels were very low against the limit.
5. " * " : Fundamental frequency, the limit was restricted at the RF Output Power.
6. The average value of fundamental and harmonic frequency is: Average = Peak value + 20 log(Duty cycle) Where the duty cycle correction factor is calculated from following formula:
 $20 \log(\text{Duty cycle}) = 20 \log(2.9 \text{ ms} / 100 \text{ ms}) = -30.8 \text{ dB}$

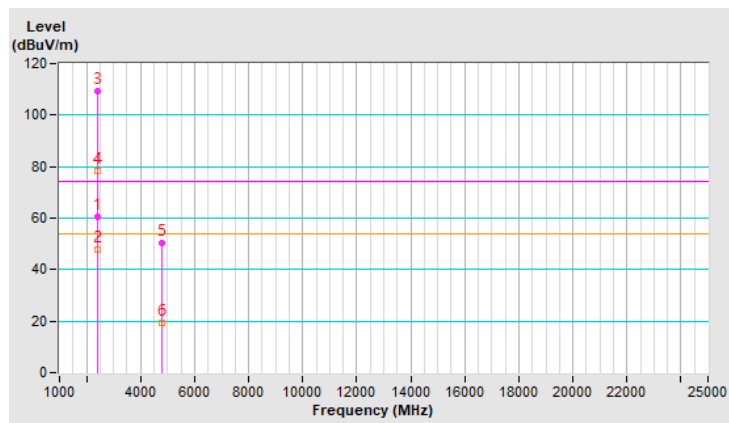

RF Mode	TX BT 8DPSK	Channel	CH 0 : 2402 MHz
Frequency Range	1 GHz ~ 25 GHz	Detector Function & Bandwidth	(PK) RB = 1 MHz, VB = 3 MHz (AV) RB = 1 MHz, VB = 3 MHz (RMS)
Input Power	120 Vac, 60 Hz	Environmental Conditions	22°C, 67% RH
Tested By	Jed Wu		

Antenna Polarity & Test Distance : Vertical at 3 m								
No	Frequency (MHz)	Emission Level (dBuV/m)	Limit (dBuV/m)	Margin (dB)	Antenna Height (m)	Table Angle (Degree)	Raw Value (dBuV)	Correction Factor (dB/m)
1	2390.00	57.4 PK	74.0	-16.6	1.65 V	170	59.7	-2.3
2	2390.00	44.3 AV	54.0	-9.7	1.65 V	170	46.6	-2.3
3	*2402.00	104.7 PK			1.65 V	170	107.0	-2.3
4	*2402.00	73.9 AV			1.65 V	170	76.2	-2.3
5	4804.00	49.8 PK	74.0	-24.2	2.11 V	203	44.3	5.5
6	4804.00	19.0 AV	54.0	-35.0	2.11 V	203	13.5	5.5

Remarks:

1. Emission Level(dBuV/m) = Raw Value(dBuV) + Correction Factor(dB/m)
2. Correction Factor(dB/m) = Antenna Factor(dB/m) + Cable Factor(dB) – Pre-Amplifier Factor(dB)
3. Margin value = Emission Level – Limit value
4. The other emission levels were very low against the limit.
5. " * " : Fundamental frequency, the limit was restricted at the RF Output Power.
6. The average value of fundamental and harmonic frequency is: Average = Peak value + 20 log(Duty cycle) Where the duty cycle correction factor is calculated from following formula:
 $20 \log(\text{Duty cycle}) = 20 \log(2.9 \text{ ms} / 100 \text{ ms}) = -30.8 \text{ dB}$

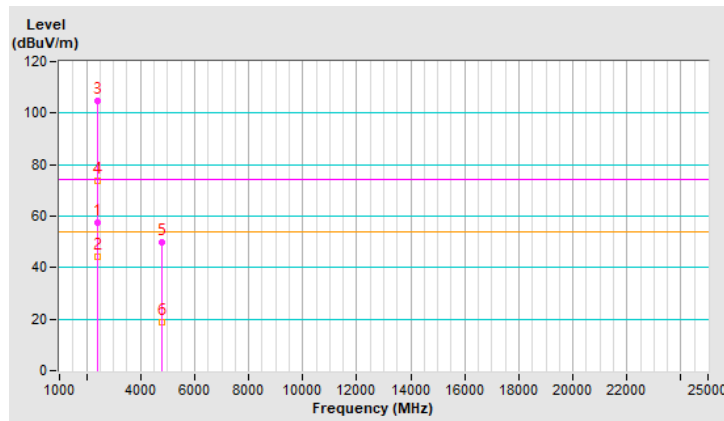

RF Mode	TX BT 8DPSK	Channel	CH 39 : 2441 MHz
Frequency Range	1 GHz ~ 25 GHz	Detector Function & Bandwidth	(PK) RB = 1 MHz, VB = 3 MHz (AV) RB = 1 MHz, VB = 3 MHz (RMS)
Input Power	120 Vac, 60 Hz	Environmental Conditions	22°C, 67% RH
Tested By	Jed Wu		

Antenna Polarity & Test Distance : Horizontal at 3 m

No	Frequency (MHz)	Emission Level (dBuV/m)	Limit (dBuV/m)	Margin (dB)	Antenna Height (m)	Table Angle (Degree)	Raw Value (dBuV)	Correction Factor (dB/m)
1	*2441.00	109.7 PK			1.41 H	97	111.9	-2.2
2	*2441.00	78.9 AV			1.41 H	97	81.1	-2.2
3	4882.00	50.7 PK	74.0	-23.3	2.34 H	142	45.1	5.6
4	4882.00	19.9 AV	54.0	-34.1	2.34 H	142	14.3	5.6

Remarks:

1. Emission Level(dBuV/m) = Raw Value(dBuV) + Correction Factor(dB/m)
2. Correction Factor(dB/m) = Antenna Factor(dB/m) + Cable Factor(dB) – Pre-Amplifier Factor(dB)
3. Margin value = Emission Level – Limit value
4. The other emission levels were very low against the limit.
5. " * ": Fundamental frequency, the limit was restricted at the RF Output Power.
6. The average value of fundamental and harmonic frequency is: Average = Peak value + 20 log(Duty cycle) Where the duty cycle correction factor is calculated from following formula:
 $20 \log(\text{Duty cycle}) = 20 \log(2.9 \text{ ms} / 100 \text{ ms}) = -30.8 \text{ dB}$

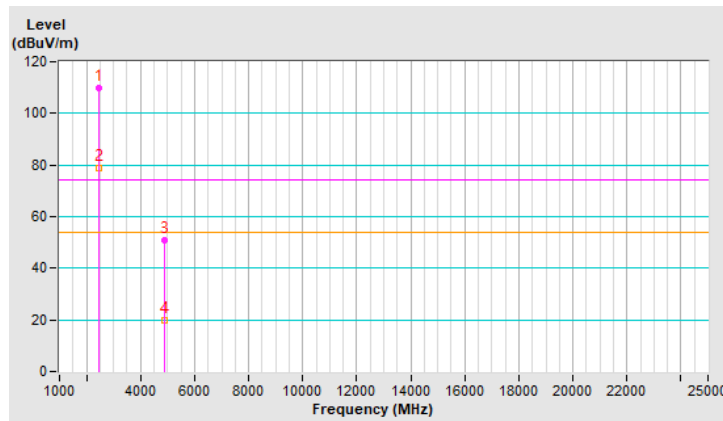

RF Mode	TX BT 8DPSK	Channel	CH 39 : 2441 MHz
Frequency Range	1 GHz ~ 25 GHz	Detector Function & Bandwidth	(PK) RB = 1 MHz, VB = 3 MHz (AV) RB = 1 MHz, VB = 3 MHz (RMS)
Input Power	120 Vac, 60 Hz	Environmental Conditions	22°C, 67% RH
Tested By	Jed Wu		

Antenna Polarity & Test Distance : Vertical at 3 m								
No	Frequency (MHz)	Emission Level (dBuV/m)	Limit (dBuV/m)	Margin (dB)	Antenna Height (m)	Table Angle (Degree)	Raw Value (dBuV)	Correction Factor (dB/m)
1	*2441.00	105.1 PK			1.85 V	169	107.3	-2.2
2	*2441.00	74.3 AV			1.85 V	169	76.5	-2.2
3	4882.00	50.2 PK	74.0	-23.8	2.16 V	205	44.6	5.6
4	4882.00	19.4 AV	54.0	-34.6	2.16 V	205	13.8	5.6

Remarks:

1. Emission Level(dBuV/m) = Raw Value(dBuV) + Correction Factor(dB/m)
2. Correction Factor(dB/m) = Antenna Factor(dB/m) + Cable Factor(dB) – Pre-Amplifier Factor(dB)
3. Margin value = Emission Level – Limit value
4. The other emission levels were very low against the limit.
5. " * " : Fundamental frequency, the limit was restricted at the RF Output Power.
6. The average value of fundamental and harmonic frequency is: Average = Peak value + 20 log(Duty cycle) Where the duty cycle correction factor is calculated from following formula:
 $20 \log(\text{Duty cycle}) = 20 \log(2.9 \text{ ms} / 100 \text{ ms}) = -30.8 \text{ dB}$

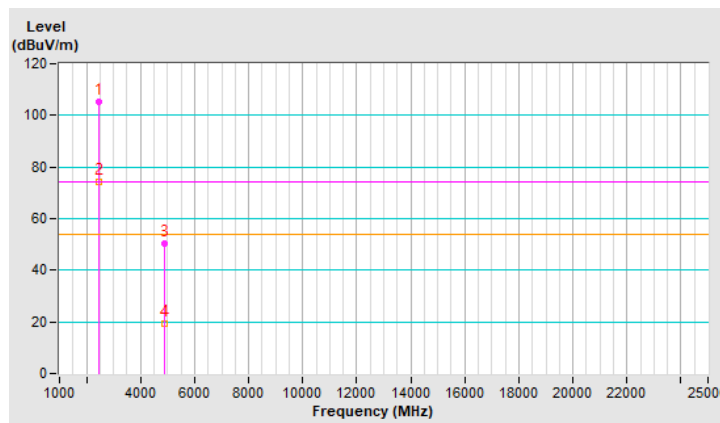

RF Mode	TX BT 8DPSK	Channel	CH 78 : 2480 MHz
Frequency Range	1 GHz ~ 25 GHz	Detector Function & Bandwidth	(PK) RB = 1 MHz, VB = 3 MHz (AV) RB = 1 MHz, VB = 3 MHz (RMS)
Input Power	120 Vac, 60 Hz	Environmental Conditions	22°C, 67% RH
Tested By	Jed Wu		

Antenna Polarity & Test Distance : Horizontal at 3 m								
No	Frequency (MHz)	Emission Level (dBuV/m)	Limit (dBuV/m)	Margin (dB)	Antenna Height (m)	Table Angle (Degree)	Raw Value (dBuV)	Correction Factor (dB/m)
1	*2480.00	109.7 PK			1.08 H	96	111.8	-2.1
2	*2480.00	78.9 AV			1.08 H	96	81.0	-2.1
3	2483.50	70.8 PK	74.0	-3.2	1.08 H	96	72.9	-2.1
4	2483.50	40.0 AV	54.0	-14.0	1.08 H	96	42.1	-2.1
5	4960.00	50.6 PK	74.0	-23.4	2.37 H	142	44.9	5.7
6	4960.00	19.8 AV	54.0	-34.2	2.37 H	142	14.1	5.7

Remarks:

1. Emission Level(dBuV/m) = Raw Value(dBuV) + Correction Factor(dB/m)
2. Correction Factor(dB/m) = Antenna Factor(dB/m) + Cable Factor(dB) – Pre-Amplifier Factor(dB)
3. Margin value = Emission Level – Limit value
4. The other emission levels were very low against the limit.
5. " * " : Fundamental frequency, the limit was restricted at the RF Output Power.
6. The average value of fundamental and harmonic frequency is: Average = Peak value + 20 log(Duty cycle) Where the duty cycle correction factor is calculated from following formula:
 $20 \log(\text{Duty cycle}) = 20 \log(2.9 \text{ ms} / 100 \text{ ms}) = -30.8 \text{ dB}$

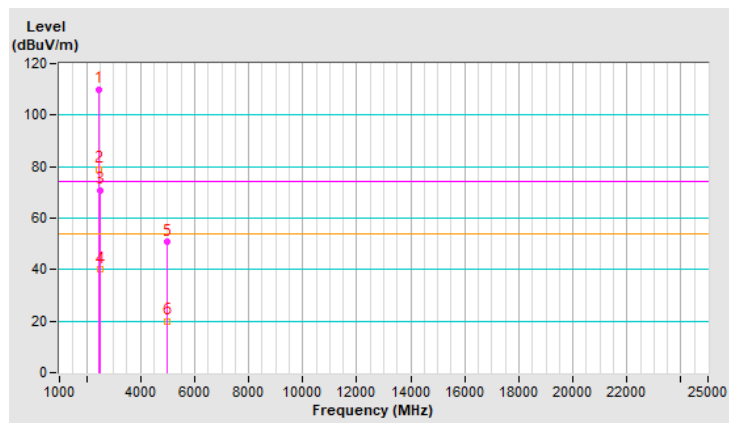

RF Mode	TX BT 8DPSK	Channel	CH 78 : 2480 MHz
Frequency Range	1 GHz ~ 25 GHz	Detector Function & Bandwidth	(PK) RB = 1 MHz, VB = 3 MHz (AV) RB = 1 MHz, VB = 3 MHz (RMS)
Input Power	120 Vac, 60 Hz	Environmental Conditions	22°C, 67% RH
Tested By	Jed Wu		

Antenna Polarity & Test Distance : Vertical at 3 m								
No	Frequency (MHz)	Emission Level (dBuV/m)	Limit (dBuV/m)	Margin (dB)	Antenna Height (m)	Table Angle (Degree)	Raw Value (dBuV)	Correction Factor (dB/m)
1	*2480.00	105.1 PK			1.43 V	167	107.2	-2.1
2	*2480.00	74.3 AV			1.43 V	167	76.4	-2.1
3	2483.50	66.8 PK	74.0	-7.2	1.43 V	167	68.9	-2.1
4	2483.50	36.0 AV	54.0	-18.0	1.43 V	167	38.1	-2.1
5	4960.00	50.2 PK	74.0	-23.8	2.16 V	201	44.5	5.7
6	4960.00	19.4 AV	54.0	-34.6	2.16 V	201	13.7	5.7

Remarks:

1. Emission Level(dBuV/m) = Raw Value(dBuV) + Correction Factor(dB/m)
2. Correction Factor(dB/m) = Antenna Factor(dB/m) + Cable Factor(dB) – Pre-Amplifier Factor(dB)
3. Margin value = Emission Level – Limit value
4. The other emission levels were very low against the limit.
5. " * " : Fundamental frequency, the limit was restricted at the RF Output Power.
6. The average value of fundamental and harmonic frequency is: Average = Peak value + 20 log(Duty cycle) Where the duty cycle correction factor is calculated from following formula:
 $20 \log(\text{Duty cycle}) = 20 \log(2.9 \text{ ms} / 100 \text{ ms}) = -30.8 \text{ dB}$

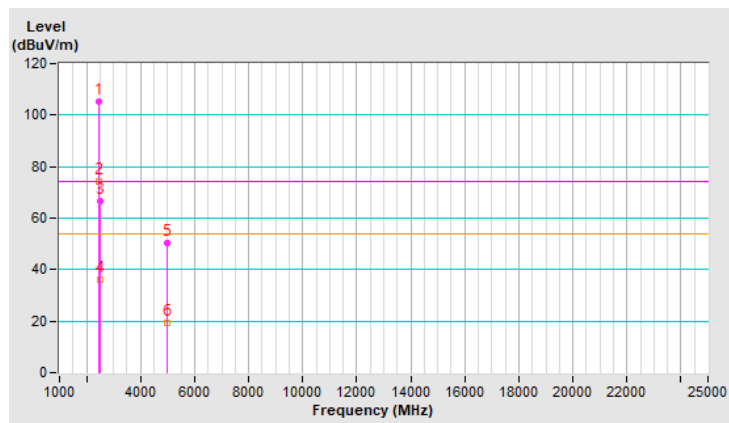

Mode A-Plot of Band Edge

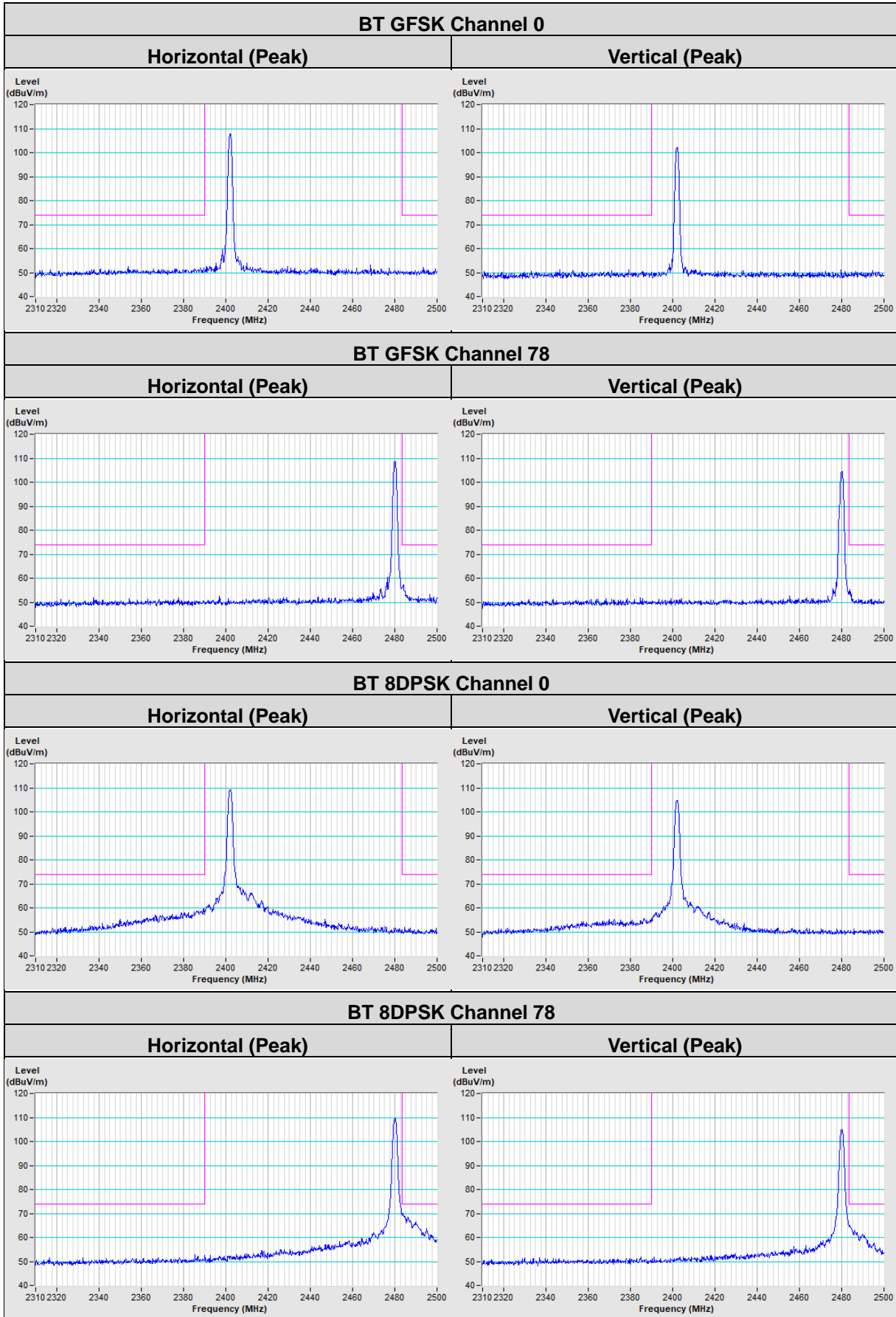

8 Pictures of Test Arrangements

Please refer to the attached file (Test Setup Photo)

9 Information of the Testing Laboratories

We, Bureau Veritas Consumer Products Services (H.K.) Ltd., Taoyuan Branch, were founded in 1988 to provide our best service in EMC, Radio, Telecom and Safety consultation. Our laboratories are FCC recognized accredited test firms and accredited according to ISO/IEC 17025.

If you have any comments, please feel free to contact us at the following:

Lin Kou EMC/RF Lab

Tel: 886-2-26052180

Fax: 886-2-26051924

Hsin Chu EMC/RF/Telecom Lab

Tel: 886-3-6668565

Fax: 886-3-6668323

Hwa Ya EMC/RF/Safety Lab

Tel: 886-3-3183232

Fax: 886-3-3270892

Email: service.adt@bureauveritas.com

Web Site: <http://ee.bureauveritas.com.tw>

The address and road map of all our labs can be found in our web site also.

--- END ---