

FCC Test Report

Report No.: RF191008D01

FCC ID: PRDHS02

Test Model: HSA-A003H

Series Model: NHJ

Received Date: Oct. 8, 2019

Test Date: Oct. 31, 2019 to Feb. 3, 2020

Issued Date: Feb. 4, 2020

Applicant: Acrox Technologies Co., Ltd

Address: 4F., No. 89, Minshan St., Neihu Dist., Taipei City 114, Taiwan, R.O.C.

Issued By: Bureau Veritas Consumer Products Services (H.K.) Ltd., Taoyuan Branch
Lin Kou Laboratories

Lab Address: No. 47-2, 14th Ling, Chia Pau Vil., Lin Kou Dist., New Taipei City, Taiwan

**FCC Registration /
Designation Number:** 198487 / TW2021



This report is for your exclusive use. Any copying or replication of this report to or for any other person or entity, or use of our name or trademark, is permitted only with our prior written permission. This report sets forth our findings solely with respect to the test samples identified herein. The results set forth in this report are not indicative or representative of the quality or characteristics of the lot from which a test sample was taken or any similar or identical product unless specifically and expressly noted. Our report includes all of the tests requested by you and the results thereof based upon the information that you provided to us. You have 60 days from date of issuance of this report to notify us of any material error or omission caused by our negligence, provided, however, that such notice shall be in writing and shall specifically address the issue you wish to raise. A failure to raise such issue within the prescribed time shall constitute your unqualified acceptance of the completeness of this report, the tests conducted and the correctness of the report contents. Unless specific mention, the uncertainty of measurement has been explicitly taken into account to declare the compliance or non-compliance to the specification. The report must not be used by the client to claim product certification, approval, or endorsement by TAF or any government agencies.

Table of Contents

Release Control Record	3
1 Certificate of Conformity	4
2 Summary of Test Results	5
2.1 Measurement Uncertainty.....	5
2.2 Modification Record.....	5
3 General Information	6
3.1 General Description of EUT.....	6
3.2 Description of Test Modes.....	6
3.2.1 Test Mode Applicability and Tested Channel Detail.....	7
3.3 Description of Support Units.....	9
3.3.1 Configuration of System under Test.....	9
3.4 General Description of Applied Standards.....	10
4 Test Types and Results	11
4.1 Radiated Emission and Bandedge Measurement.....	11
4.1.1 Limits of Radiated Emission and Bandedge Measurement.....	11
4.1.2 Test Instruments.....	12
4.1.3 Test Procedures.....	13
4.1.4 Deviation from Test Standard.....	13
4.1.5 Test Setup.....	14
4.1.6 EUT Operating Conditions.....	15
4.1.7 Test Results.....	16
4.2 Conducted Emission Measurement.....	25
4.2.1 Limits of Conducted Emission Measurement.....	25
4.2.2 Test Instruments.....	25
4.2.3 Test Procedures.....	26
4.2.4 Deviation from Test Standard.....	26
4.2.5 Test Setup.....	26
4.2.6 EUT Operating Conditions.....	26
4.2.7 Test Results.....	27
4.3 Channel Bandwidth.....	31
4.3.1 Test Setup.....	31
4.3.2 Test Instruments.....	31
4.3.3 Test Procedure.....	31
4.3.4 Deviation from Test Standard.....	31
4.3.5 EUT Operating Condition.....	31
4.3.6 Test Results.....	32
5 Pictures of Test Arrangements	33
Appendix – Information of the Testing Laboratories	34

Release Control Record

Issue No.	Description	Date Issued
RF191008D01	Original release.	Feb. 4, 2020

1 Certificate of Conformity

Product: Wireless Headset
Brand: hp
Test Model: HSA-A003H
Series Model: NHJ
Sample Status: Engineering sample
Applicant: Acrox Technologies Co., Ltd
Test Date: Oct. 31, 2019 to Feb. 3, 2020
Standards: 47 CFR FCC Part 15, Subpart C (Section 15.249)
ANSI C63.10: 2013

The above equipment has been tested by **Bureau Veritas Consumer Products Services (H.K.) Ltd., Taoyuan Branch**, and found compliance with the requirement of the above standards. The test record, data evaluation & Equipment Under Test (EUT) configurations represented herein are true and accurate accounts of the measurements of the sample's RF characteristics under the conditions specified in this report.

Prepared by : Annie Chang, **Date:** Feb. 4, 2020
Annie Chang / Senior Specialist

Approved by : Rex Lai, **Date:** Feb. 4, 2020
Rex Lai / Associate Technical Manager

2 Summary of Test Results

47 CFR FCC Part 15, Subpart C (SECTION 15.249)			
FCC Clause	Test Item	Result	Remarks
15.207	AC Power Conducted Emission	PASS	Meet the requirement of limit. Minimum passing margin is -16.27dB at 0.15000MHz.
15.215	Channel Bandwidth Measurement	-	
15.209 15.249 15.249 (d)	Radiated Emission Test Band Edge Measurement Limit: 50dB less than the peak value of fundamental frequency or meet radiated emission limit in section 15.209	PASS	Meet the requirement of limit. Minimum passing margin is -5.05dB at 7434.00MHz.
15.203	Antenna Requirement	PASS	No antenna connector is used.

Note: Determining compliance based on the results of the compliance measurement, not taking into account measurement instrumentation uncertainty.

2.1 Measurement Uncertainty

Where relevant, the following measurement uncertainty levels have been estimated for tests performed on the EUT as specified in CISPR 16-4-2:

Measurement	Frequency	Expanded Uncertainty (k=2) (\pm)
Conducted Emissions at mains ports	150kHz ~ 30MHz	2.93 dB
Radiated Emissions up to 1 GHz	9kHz ~ 30MHz	2.61 dB
	30MHz ~ 1000MHz	5.43 dB
Radiated Emissions above 1 GHz	Above 1GHz	5.42 dB

2.2 Modification Record

There were no modifications required for compliance.

3 General Information

3.1 General Description of EUT

Product	Wireless Headset
Brand	hp
Test Model	HSA-A003H
Series Model	NHJ
Model Difference	For marketing purpose
Status of EUT	Engineering sample
Power Supply Rating	3.7Vdc from Battery or 5Vdc from USB port
Modulation Type	GFSK
Operating Frequency	2406MHz ~ 2478MHz
Number of Channel	25
Antenna Type	Refer to note as below
Antenna Connector	N/A
Accessory Device	N/A
Data Cable Supplied	Shielded USB to Micro USB cable (1.0m)

Note:

1. The EUT was pre-tested with the following modes:

- ✧ Operating Mode (EUT + Battery)
- ✧ Operating + Charging Mode (EUT + Adapter)
- ✧ Operating + Charging Mode (EUT + Notebook)

The worst emission level was found when the EUT tested under **Operating + Charging Mode (EUT + Notebook)** therefore, only its test data was recorded in this report.

2. The EUT used antennas listed as below:

Antenna	Antenna Type	Antenna Connector	Gain (dBi)
ANT1	PCB	N/A	1.74
ANT2	PCB	N/A	3.48

3. The above EUT information is declared by manufacturer and for more detailed features description, please refer to the manufacturer's specifications or user's manual.

3.2 Description of Test Modes

25 channels are provided to this EUT:

CHANNEL	FREQ. (MHz)	CHANNEL	FREQ. (MHz)	CHANNEL	FREQ. (MHz)	CHANNEL	FREQ. (MHz)
1	2406	8	2427	15	2448	22	2469
2	2409	9	2430	16	2451	23	2472
3	2412	10	2433	17	2454	24	2475
4	2415	11	2436	18	2457	25	2478
5	2418	12	2439	19	2460		
6	2421	13	2442	20	2463		
7	2424	14	2445	21	2466		

3.2.1 Test Mode Applicability and Tested Channel Detail

EUT Configure Mode	Applicable To				Description
	RE \geq 1G	RE<1G	PLC	APCM	
A	√	√	√	√	Operating + Charging Mode (EUT + Notebook) + ANT1
B	-	-	√	-	Operating + Charging Mode (EUT + Adapter) + ANT1
C	√	-	-	-	Operating + Charging Mode (EUT + Notebook) + ANT2

Where RE \geq 1G: Radiated Emission above 1GHz & Bandedge Measurement
 RE<1G: Radiated Emission below 1GHz
 PLC: Power Line Conducted Emission
 APCM: Antenna Port Conducted Measurement

NOTE: The EUT had been pre-tested on the positioned of each 3 axis. The worst case was found when positioned on **X-plane**.

Radiated Emission Test (Above 1GHz):

- Pre-Scan has been conducted to determine the worst-case mode from all possible combinations between available modulations, data rates and antenna ports (if EUT with antenna diversity architecture).
- Following channel(s) was (were) selected for the final test as listed below.

EUT Configure Mode	Available Channel	Tested Channel	Modulation Type
A & C	1 to 25	1, 12, 25	GFSK

Radiated Emission Test (Below 1GHz):

- Pre-Scan has been conducted to determine the worst-case mode from all possible combinations between available modulations, data rates and antenna ports (if EUT with antenna diversity architecture).
- Following channel(s) was (were) selected for the final test as listed below.

EUT Configure Mode	Available Channel	Tested Channel	Modulation Type
A	1 to 25	1	GFSK

Power Line Conducted Emission Test:

- Pre-Scan has been conducted to determine the worst-case mode from all possible combinations between available modulations, data rates and antenna ports (if EUT with antenna diversity architecture).
- Following channel(s) was (were) selected for the final test as listed below.

EUT Configure Mode	Available Channel	Tested Channel	Modulation Type
A & B	1 to 25	1	GFSK

Antenna Port Conducted Measurement:

- This item includes all test value of each mode, but only includes spectrum plot of worst value of each mode.
- Pre-Scan has been conducted to determine the worst-case mode from all possible combinations between available modulations, data rates and antenna ports (if EUT with antenna diversity architecture).
- Following channel(s) was (were) selected for the final test as listed below.

EUT Configure Mode	Available Channel	Tested Channel	Modulation Type
A	1 to 25	1, 12, 25	GFSK

Test Condition:

Applicable To	EUT Configure Mode	Environmental Conditions	Input Power	Tested By
RE≥1G	A	24deg. C, 73%RH	120Vac, 60Hz (System)	Dalen Dai
	C	11deg. C, 72%RH	120Vac, 60Hz (System)	Dalen Dai
RE<1G	A	23deg. C, 78%RH	120Vac, 60Hz (System)	Starlaly Wu
PLC	A	25deg. C, 75%RH	120Vac, 60Hz (System)	Starlaly Wu
	B	25deg. C, 75%RH	120Vac, 60Hz (Adapter)	Starlaly Wu
APCM	A	25deg. C, 76%RH	120Vac, 60Hz (System)	Saxon Lee

3.3 Description of Support Units

The EUT has been tested as an independent unit together with other necessary accessories or support units. The following support units or accessories were used to form a representative test configuration during the tests.

ID	Product	Brand	Model No.	Serial No.	FCC ID	Remarks
A.	Notebook PC	Lenovo	80WG	YD01YRC9	N/A	Provided by Lab
B.	AC Adapter	Apple	A1385	N/A	N/A	Provided by Lab

Note: All power cords of the above support units are non-shielded (1.8m).

No.	Cable Descriptions	Qty.	Length (m)	Shielding (Yes/ No)	Cores (Qty.)	Remarks
1.	USB cable	1	1	Y	0	Supplied by client

NOTE: The core(s) is(are) originally attached to the cable(s).

3.3.1 Configuration of System under Test

Mode A & C:

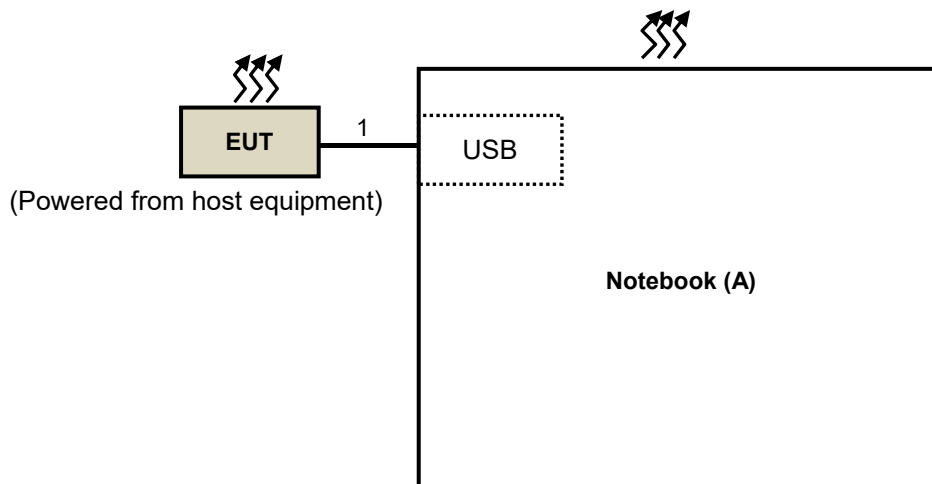

Mode B:

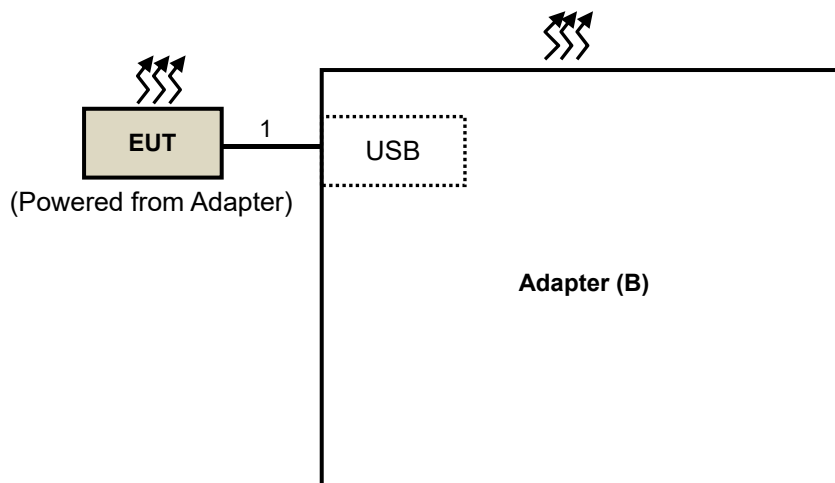

3.4 General Description of Applied Standards

The EUT is a RF Product. According to the specifications of the manufacturer, it must comply with the requirements of the following standards:

FCC Part 15, Subpart C (15.249)

ANSI C63.10-2013

All test items have been performed and recorded as per the above standards.

4 Test Types and Results

4.1 Radiated Emission and Bandedge Measurement

4.1.1 Limits of Radiated Emission and Bandedge Measurement

The field strength of emissions from intentional radiators operated within these frequency bands shall comply with the following

Fundamental Frequency	Field Strength of Fundamental (millivolts/meter)	Field Strength of Harmonics (microvolts/meter)
902 ~ 928 MHz	50	500
2400 ~ 2483.5 MHz	50	500
5725 ~ 5875 MHz	50	500
24 ~ 24.25 GHz	250	2500

Emissions radiated outside of the specified frequency bands, except for harmonics, shall be attenuated by at least 50 dB below the level of the fundamental or to the general radiated emission limits as below table, whichever is the lesser attenuation

Frequencies (MHz)	Field Strength (microvolts/meter)	Measurement Distance (meters)
0.009 ~ 0.490	2400/F(kHz)	300
0.490 ~ 1.705	24000/F(kHz)	30
1.705 ~ 30.0	30	30
30 ~ 88	100	3
88 ~ 216	150	3
216 ~ 960	200	3
Above 960	500	3

NOTE:

1. The lower limit shall apply at the transition frequencies.
2. Emission level (dBuV/m) = 20 log Emission level (uV/m).
3. For frequencies above 1000MHz, the field strength limits are based on average detector, however, the peak field strength of any emission shall not exceed the maximum permitted average limits, specified above by more than 20dB under any condition of modulation.

4.1.2 Test Instruments

DESCRIPTION & MANUFACTURER	MODEL NO.	SERIAL NO.	CALIBRATED DATE	CALIBRATED UNTIL
HP Preamplifier	8447D	2432A03504	Feb. 20, 2019	Feb. 19, 2020
HP Preamplifier	8449B	3008A01201	Feb. 21, 2019	Feb. 20, 2020
MITEQ Preamplifier	AMF-6F-260400-33-8P	892164	Feb. 20, 2019	Feb. 19, 2020
Agilent TEST RECEIVER	N9038A	MY51210129	Mar. 05, 2019	Mar. 04, 2020
Schwarzbeck Antenna	VULB 9168	139	Nov. 26, 2018	Nov. 25, 2019
			Nov. 7, 2019	Nov. 6, 2020
Schwarzbeck Antenna	VHBA 9123	480	Jun. 3, 2019	Jun. 2, 2021
Schwarzbeck Horn Antenna	BBHA-9170	212	Nov. 25, 2018	Nov. 24, 2019
			Nov. 24, 2019	Nov. 23, 2020
Schwarzbeck Horn Antenna	BBHA 9120-D1	D130	Nov. 25, 2018	Nov. 24, 2019
			Nov. 24, 2019	Nov. 23, 2020
ADT. Turn Table	TT100	0306	NA	NA
ADT. Tower	AT100	0306	NA	NA
Software	Radiated_V7.6.15.9.5	NA	NA	NA
SUHNER RF cable With 4dB PAD	SF102	Cable-CH6-01	Jul. 10, 2019	Jul. 9, 2020
SUHNER RF cable With 3/4dB PAD	SF102	Cable-CH8-3.6m	Jul. 10, 2019	Jul. 9, 2020
KEYSIGHT MIMO Powermeasurement Test set	U2021XA	U2021XA-001	Jun. 11, 2019	Jun. 10, 2020
KEYSIGHT Spectrum Analyzer	N9030A	MY54490260	Jul. 30, 2019	Jul. 29, 2020
Loop Antenna EMCI	LPA600	270	Aug. 23, 2019	Aug. 22, 2021
EMCO Horn Antenna	3115	00028257	Nov. 25, 2018	Nov. 24, 2019
			Nov. 24, 2019	Nov. 23, 2020
Highpass filter Wainwright Instruments	WHK 3.1/18G-10SS	SN 8	NA	NA
ROHDE & SCHWARZ Spectrum Analyzer	FSV40	101042	Sep. 23, 2019	Sep. 22, 2020
Anritsu Power Sensor	MA2411B	0738404	Apr. 16, 2019	Apr. 15, 2020
Anritsu Power Meter	ML2495A	0842014	Apr. 16, 2019	Apr. 15, 2020

- NOTE:**
1. The calibration interval of the above test instruments is 12/24 months. And the calibrations are traceable to NML/ROC and NIST/USA.
 2. The horn antenna and HP preamplifier (model: 8449B) are used only for the measurement of emission frequency above 1GHz if tested.
 3. The test was performed in Chamber No. 6.
 4. Tested Date: Oct. 31, 2019 to Feb. 3, 2020

4.1.3 Test Procedures

For Radiated emission below 30MHz

- a. The EUT was placed on the top of a rotating table 0.8 meters above the ground at a 3 meter chamber room. The table was rotated 360 degrees to determine the position of the highest radiation.
- b. The EUT was set 3 meters away from the interference-receiving antenna, which was mounted on the top of a variable-height antenna tower.
- c. Parallel, perpendicular, and ground-parallel orientations of the antenna are set to make the measurement.
- d. For each suspected emission, the EUT was arranged to its worst case and the rotatable table was turned from 0 degrees to 360 degrees to find the maximum reading.
- e. The test-receiver system was set to Quasi-Peak Detect Function and Specified Bandwidth with Maximum Hold Mode.

NOTE:

1. The resolution bandwidth and video bandwidth of test receiver/spectrum analyzer is 9kHz at frequency below 30MHz.

For Radiated emission above 30MHz

- a. The EUT was placed on the top of a rotating table 0.8 meters (for 30MHz ~ 1GHz) / 1.5 meters (for above 1GHz) above the ground at 3 meter chamber room for test. The table was rotated 360 degrees to determine the position of the highest radiation.
- b. The EUT was set 3 meters away from the interference-receiving antenna, which was mounted on the top of a variable-height antenna tower.
- c. The height of antenna is varied from one meter to four meters above the ground to determine the maximum value of the field strength. Both horizontal and vertical polarizations of the antenna are set to make the measurement.
- d. For each suspected emission, the EUT was arranged to its worst case and then the antenna was tuned to heights from 1 meter to 4 meters and the rotatable table was turned from 0 degrees to 360 degrees to find the maximum reading.
- e. The test-receiver system was set to quasi-peak detect function and specified bandwidth with maximum hold mode when the test frequency is below 1 GHz.
- f. The test-receiver system was set to peak and average detect function and specified bandwidth with maximum hold mode when the test frequency is above 1 GHz. If the peak reading value also meets average limit, measurement with the average detector is unnecessary.

Note:

1. The resolution bandwidth and video bandwidth of test receiver/spectrum analyzer is 120kHz for Quasi-peak detection (QP) at frequency below 1GHz.
2. The resolution bandwidth of test receiver/spectrum analyzer is 1 MHz and the video bandwidth is 3 MHz for Peak detection (PK) at frequency above 1GHz.
3. The resolution bandwidth of test receiver/spectrum analyzer is 1MHz and the video bandwidth is $\geq 1/T$ (Duty cycle < 98%) or 10Hz (Duty cycle $\geq 98\%$) for Average detection (AV) at frequency above 1GHz.
4. All modes of operation were investigated and the worst-case emissions are reported.

4.1.4 Deviation from Test Standard

No deviation.

4.1.5 Test Setup

For Radiated emission below 30MHz

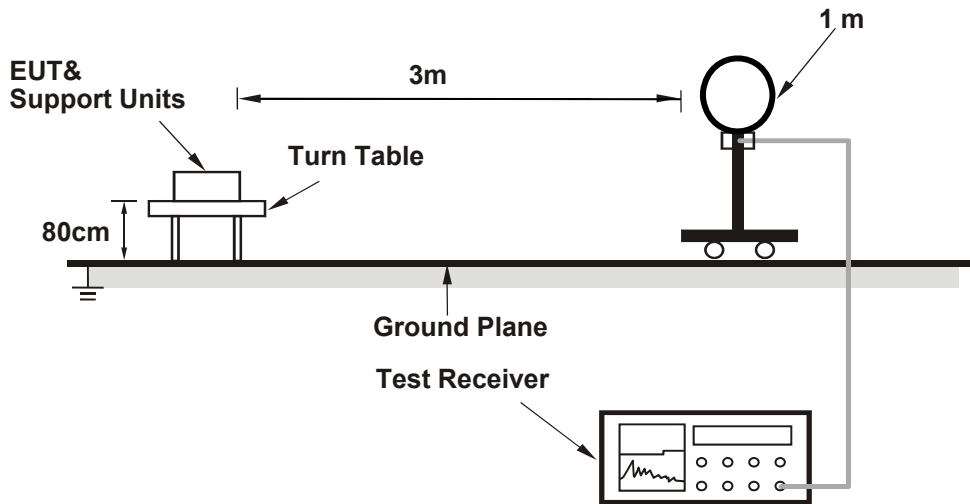

For Radiated emission 30MHz to 1GHz

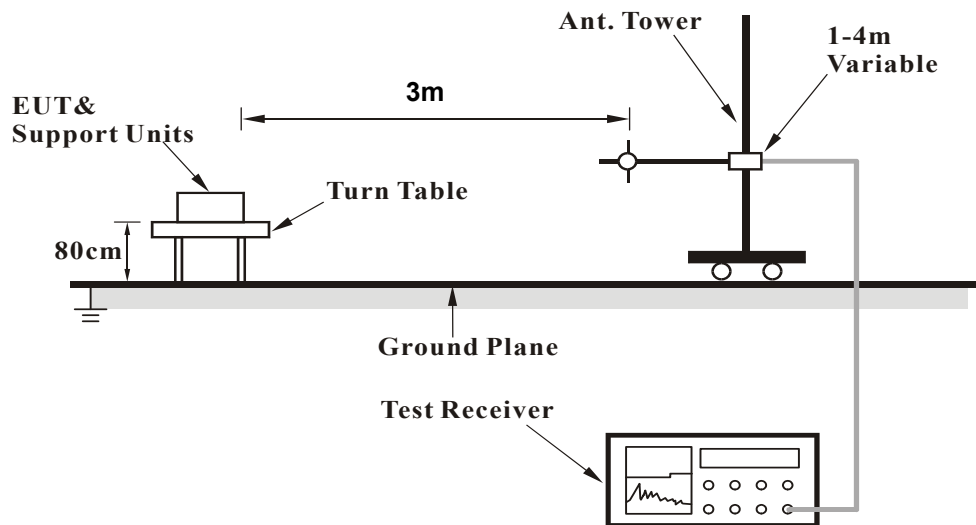

For Radiated emission above 1GHz

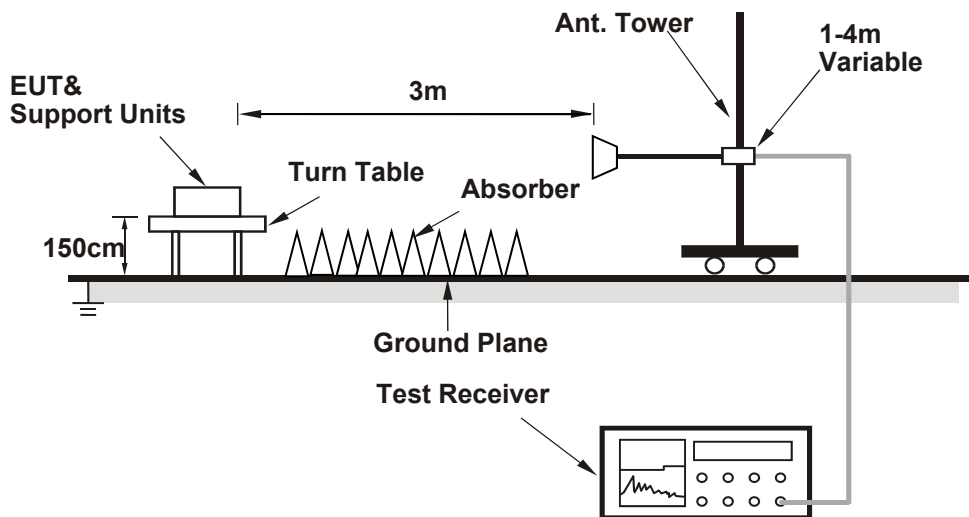

For the actual test configuration, please refer to the attached file (Test Setup Photo).

4.1.6 EUT Operating Conditions

- Connected the EUT to Notebook.
- Set the EUT under transmission condition continuously at specific channel frequency.

4.1.7 Test Results

ABOVE 1GHz DATA

Mode A

CHANNEL	TX Channel 1	DETECTOR FUNCTION	Peak (PK)
FREQUENCY RANGE	1GHz ~ 25GHz		Average (AV)

ANTENNA POLARITY & TEST DISTANCE: HORIZONTAL AT 3 M

NO.	FREQ. (MHz)	EMISSION LEVEL (dBuV/m)	LIMIT (dBuV/m)	MARGIN (dB)	ANTENNA HEIGHT (m)	TABLE ANGLE (Degree)	RAW VALUE (dBuV)	CORRECTION FACTOR (dB/m)
1	2390.00	45.46 PK	74.00	-28.54	1.00 H	101	45.02	0.44
2	2390.00	32.10 AV	54.00	-21.90	1.00 H	101	31.66	0.44
3	2400.00	67.69 PK	74.00	-6.31	1.00 H	101	67.22	0.47
4	2400.00	42.06 AV	54.00	-11.94	1.00 H	101	41.59	0.47
5	*2406.00	103.45 PK	114.00	-10.55	1.00 H	101	102.98	0.47
6	*2406.00	87.95 AV	94.00	-6.05	1.00 H	101	87.48	0.47
7	4812.00	56.29 PK	74.00	-17.71	1.04 H	164	48.13	8.16
8	4812.00	40.79 AV	54.00	-13.21	1.04 H	164	32.63	8.16
9	7218.00	63.06 PK	74.00	-10.94	1.50 H	27	50.18	12.88
10	7218.00	47.56 AV	54.00	-6.44	1.50 H	27	34.68	12.88

ANTENNA POLARITY & TEST DISTANCE: VERTICAL AT 3 M

NO.	FREQ. (MHz)	EMISSION LEVEL (dBuV/m)	LIMIT (dBuV/m)	MARGIN (dB)	ANTENNA HEIGHT (m)	TABLE ANGLE (Degree)	RAW VALUE (dBuV)	CORRECTION FACTOR (dB/m)
1	2390.00	45.22 PK	74.00	-28.78	1.08 V	66	44.78	0.44
2	2390.00	31.96 AV	54.00	-22.04	1.08 V	66	31.52	0.44
3	2400.00	60.86 PK	74.00	-13.14	1.08 V	66	60.39	0.47
4	2400.00	37.18 AV	54.00	-16.82	1.08 V	66	36.71	0.47
5	*2406.00	100.85 PK	114.00	-13.15	1.08 V	66	100.38	0.47
6	*2406.00	85.35 AV	94.00	-8.65	1.08 V	66	84.88	0.47
7	4812.00	55.90 PK	74.00	-18.10	2.89 V	154	47.74	8.16
8	4812.00	40.40 AV	54.00	-13.60	2.89 V	154	32.24	8.16
9	7218.00	62.39 PK	74.00	-11.61	1.13 V	162	49.51	12.88
10	7218.00	46.89 AV	54.00	-7.11	1.13 V	162	34.01	12.88

REMARKS:

- Emission Level(dBuV/m) = Raw Value(dBuV) + Correction Factor(dB/m)
- Correction Factor(dB/m) = Antenna Factor(dB/m) + Cable Factor(dB) – Pre-Amplifier Factor(dB)
- Margin value = Emission Level – Limit value
- The other emission levels were very low against the limit.
- " * ": Fundamental frequency.
- The average value of fundamental and harmonic frequency is: Average = Peak value + 20 log(Duty cycle) Where the duty factor is calculated from following formula:
 $20 \log(\text{Duty cycle}) = 20 \log(0.6931 \text{ ms} / 4.113 \text{ ms}) = -15.5 \text{ dB}$
Please see page 22 for plotted duty.

CHANNEL	TX Channel 12	DETECTOR FUNCTION	Peak (PK)
FREQUENCY RANGE	1GHz ~ 25GHz		Average (AV)

ANTENNA POLARITY & TEST DISTANCE: HORIZONTAL AT 3 M

NO.	FREQ. (MHz)	EMISSION LEVEL (dBuV/m)	LIMIT (dBuV/m)	MARGIN (dB)	ANTENNA HEIGHT (m)	TABLE ANGLE (Degree)	RAW VALUE (dBuV)	CORRECTION FACTOR (dB/m)
1	*2439.00	103.13 PK	114.00	-10.87	1.02 H	96	102.65	0.48
2	*2439.00	87.63 AV	94.00	-6.37	1.02 H	96	87.15	0.48
3	4878.00	56.37 PK	74.00	-17.63	1.06 H	179	47.97	8.40
4	4878.00	40.87 AV	54.00	-13.13	1.06 H	179	32.47	8.40
5	7317.00	63.07 PK	74.00	-10.93	1.47 H	32	49.86	13.21
6	7317.00	47.57 AV	54.00	-6.43	1.47 H	32	34.36	13.21

ANTENNA POLARITY & TEST DISTANCE: VERTICAL AT 3 M

NO.	FREQ. (MHz)	EMISSION LEVEL (dBuV/m)	LIMIT (dBuV/m)	MARGIN (dB)	ANTENNA HEIGHT (m)	TABLE ANGLE (Degree)	RAW VALUE (dBuV)	CORRECTION FACTOR (dB/m)
1	*2439.00	100.65 PK	114.00	-13.35	1.10 V	73	100.17	0.48
2	*2439.00	85.15 AV	94.00	-8.85	1.10 V	73	84.67	0.48
3	4878.00	55.95 PK	74.00	-18.05	2.82 V	160	47.55	8.40
4	4878.00	40.45 AV	54.00	-13.55	2.82 V	160	32.05	8.40
5	7317.00	62.57 PK	74.00	-11.43	1.17 V	179	49.36	13.21
6	7317.00	47.07 AV	54.00	-6.93	1.17 V	179	33.86	13.21

REMARKS:

- Emission Level(dBuV/m) = Raw Value(dBuV) + Correction Factor(dB/m)
- Correction Factor(dB/m) = Antenna Factor(dB/m) + Cable Factor(dB) – Pre-Amplifier Factor(dB)
- Margin value = Emission Level – Limit value
- The other emission levels were very low against the limit.
- " * ": Fundamental frequency.
- The average value of fundamental and harmonic frequency is: Average = Peak value + 20 log(Duty cycle) Where the duty factor is calculated from following formula:
 $20 \log(\text{Duty cycle}) = 20 \log(0.6931 \text{ ms} / 4.113 \text{ ms}) = -15.5 \text{ dB}$
Please see page 22 for plotted duty.

CHANNEL	TX Channel 25	DETECTOR FUNCTION	Peak (PK)
FREQUENCY RANGE	1GHz ~ 25GHz		Average (AV)

ANTENNA POLARITY & TEST DISTANCE: HORIZONTAL AT 3 M

NO.	FREQ. (MHz)	EMISSION LEVEL (dBuV/m)	LIMIT (dBuV/m)	MARGIN (dB)	ANTENNA HEIGHT (m)	TABLE ANGLE (Degree)	RAW VALUE (dBuV)	CORRECTION FACTOR (dB/m)
1	*2478.00	102.70 PK	114.00	-11.30	1.06 H	73	102.11	0.59
2	*2478.00	87.20 AV	94.00	-6.80	1.06 H	73	86.61	0.59
3	2483.50	54.88 PK	74.00	-19.12	1.06 H	73	54.26	0.62
4	2483.50	41.41 AV	54.00	-12.59	1.06 H	73	40.79	0.62
5	4956.00	56.14 PK	74.00	-17.86	1.03 H	175	47.64	8.50
6	4956.00	40.64 AV	54.00	-13.36	1.03 H	175	32.14	8.50
7	7434.00	62.90 PK	74.00	-11.10	1.41 H	51	49.63	13.27
8	7434.00	47.40 AV	54.00	-6.60	1.41 H	51	34.13	13.27

ANTENNA POLARITY & TEST DISTANCE: VERTICAL AT 3 M

NO.	FREQ. (MHz)	EMISSION LEVEL (dBuV/m)	LIMIT (dBuV/m)	MARGIN (dB)	ANTENNA HEIGHT (m)	TABLE ANGLE (Degree)	RAW VALUE (dBuV)	CORRECTION FACTOR (dB/m)
1	*2478.00	100.51 PK	114.00	-13.49	1.13 V	71	99.92	0.59
2	*2478.00	85.01 AV	94.00	-8.99	1.13 V	71	84.42	0.59
3	2483.50	54.56 PK	74.00	-19.44	1.13 V	71	53.94	0.62
4	2483.50	41.13 AV	54.00	-12.87	1.13 V	71	40.51	0.62
5	4956.00	55.81 PK	74.00	-18.19	2.67 V	158	47.31	8.50
6	4956.00	40.31 AV	54.00	-13.69	2.67 V	158	31.81	8.50
7	7434.00	62.35 PK	74.00	-11.65	1.15 V	172	49.08	13.27
8	7434.00	46.85 AV	54.00	-7.15	1.15 V	172	33.58	13.27

REMARKS:

- Emission Level(dBuV/m) = Raw Value(dBuV) + Correction Factor(dB/m)
- Correction Factor(dB/m) = Antenna Factor(dB/m) + Cable Factor(dB) – Pre-Amplifier Factor(dB)
- Margin value = Emission Level – Limit value
- The other emission levels were very low against the limit.
- " * ": Fundamental frequency.
- The average value of fundamental and harmonic frequency is: Average = Peak value + 20 log(Duty cycle) Where the duty factor is calculated from following formula:
 $20 \log(\text{Duty cycle}) = 20 \log(0.6931 \text{ ms} / 4.113 \text{ ms}) = -15.5 \text{ dB}$
 Please see page 22 for plotted duty.

Mode C

CHANNEL	TX Channel 1	DETECTOR FUNCTION	Peak (PK)
FREQUENCY RANGE	1GHz ~ 25GHz		Average (AV)

ANTENNA POLARITY & TEST DISTANCE: HORIZONTAL AT 3 M

NO.	FREQ. (MHz)	EMISSION LEVEL (dBuV/m)	LIMIT (dBuV/m)	MARGIN (dB)	ANTENNA HEIGHT (m)	TABLE ANGLE (Degree)	RAW VALUE (dBuV)	CORRECTION FACTOR (dB/m)
1	2390.00	45.26 PK	74.00	-28.74	1.31 H	300	44.82	0.44
2	2390.00	31.71 AV	54.00	-22.29	1.31 H	300	31.27	0.44
3	2400.00	45.51 PK	74.00	-28.49	1.31 H	300	45.04	0.47
4	2400.00	32.09 AV	54.00	-21.91	1.31 H	300	31.62	0.47
5	*2406.00	94.83 PK	114.00	-19.17	1.31 H	300	94.36	0.47
6	*2406.00	79.33 AV	94.00	-14.67	1.31 H	300	78.86	0.47
7	4812.00	55.88 PK	74.00	-18.12	2.27 H	327	47.72	8.16
8	4812.00	40.38 AV	54.00	-13.62	2.27 H	327	32.22	8.16
9	7218.00	55.54 PK	74.00	-18.46	1.05 H	346	42.66	12.88
10	7218.00	40.04 AV	54.00	-13.96	1.05 H	346	27.16	12.88

ANTENNA POLARITY & TEST DISTANCE: VERTICAL AT 3 M

NO.	FREQ. (MHz)	EMISSION LEVEL (dBuV/m)	LIMIT (dBuV/m)	MARGIN (dB)	ANTENNA HEIGHT (m)	TABLE ANGLE (Degree)	RAW VALUE (dBuV)	CORRECTION FACTOR (dB/m)
1	2390.00	44.41 PK	74.00	-29.59	2.11 V	145	43.97	0.44
2	2390.00	31.62 AV	54.00	-22.38	2.11 V	145	31.18	0.44
3	2400.00	44.59 PK	74.00	-29.41	2.11 V	145	44.12	0.47
4	2400.00	31.86 AV	54.00	-22.14	2.11 V	145	31.39	0.47
5	*2406.00	93.54 PK	114.00	-20.46	2.11 V	145	93.07	0.47
6	*2406.00	78.04 AV	94.00	-15.96	2.11 V	145	77.57	0.47
7	4812.00	59.42 PK	74.00	-14.58	2.35 V	294	51.26	8.16
8	4812.00	43.92 AV	54.00	-10.08	2.35 V	294	35.76	8.16
9	7218.00	58.32 PK	74.00	-15.68	1.14 V	317	45.44	12.88
10	7218.00	42.82 AV	54.00	-11.18	1.14 V	317	29.94	12.88

REMARKS:

- Emission Level(dBuV/m) = Raw Value(dBuV) + Correction Factor(dB/m)
- Correction Factor(dB/m) = Antenna Factor(dB/m) + Cable Factor(dB) – Pre-Amplifier Factor(dB)
- Margin value = Emission Level – Limit value
- The other emission levels were very low against the limit.
- " * ": Fundamental frequency.
- The average value of fundamental and harmonic frequency is: Average = Peak value + 20 log(Duty cycle) Where the duty factor is calculated from following formula:
 $20 \log(\text{Duty cycle}) = 20 \log(0.6931 \text{ ms} / 4.113 \text{ ms}) = -15.5 \text{ dB}$
 Please see page 22 for plotted duty.

CHANNEL	TX Channel 12	DETECTOR FUNCTION	Peak (PK)
FREQUENCY RANGE	1GHz ~ 25GHz		Average (AV)

ANTENNA POLARITY & TEST DISTANCE: HORIZONTAL AT 3 M

NO.	FREQ. (MHz)	EMISSION LEVEL (dBuV/m)	LIMIT (dBuV/m)	MARGIN (dB)	ANTENNA HEIGHT (m)	TABLE ANGLE (Degree)	RAW VALUE (dBuV)	CORRECTION FACTOR (dB/m)
1	*2439.00	94.51 PK	114.00	-19.49	1.80 H	301	94.03	0.48
2	*2439.00	79.01 AV	94.00	-14.99	1.80 H	301	78.53	0.48
3	4878.00	56.45 PK	74.00	-17.55	2.45 H	319	48.05	8.40
4	4878.00	40.95 AV	54.00	-13.05	2.45 H	319	32.55	8.40
5	7317.00	56.01 PK	74.00	-17.99	1.02 H	20	42.80	13.21
6	7317.00	40.51 AV	54.00	-13.49	1.02 H	20	27.30	13.21

ANTENNA POLARITY & TEST DISTANCE: VERTICAL AT 3 M

NO.	FREQ. (MHz)	EMISSION LEVEL (dBuV/m)	LIMIT (dBuV/m)	MARGIN (dB)	ANTENNA HEIGHT (m)	TABLE ANGLE (Degree)	RAW VALUE (dBuV)	CORRECTION FACTOR (dB/m)
1	*2439.00	93.31 PK	114.00	-20.69	2.55 V	145	92.83	0.48
2	*2439.00	77.81 AV	94.00	-16.19	2.55 V	145	77.33	0.48
3	4878.00	58.64 PK	74.00	-15.36	2.00 V	294	50.24	8.40
4	4878.00	43.14 AV	54.00	-10.86	2.00 V	294	34.74	8.40
5	7317.00	58.98 PK	74.00	-15.02	1.00 V	313	45.77	13.21
6	7317.00	43.48 AV	54.00	-10.52	1.00 V	313	30.27	13.21

REMARKS:

- Emission Level(dBuV/m) = Raw Value(dBuV) + Correction Factor(dB/m)
- Correction Factor(dB/m) = Antenna Factor(dB/m) + Cable Factor(dB) – Pre-Amplifier Factor(dB)
- Margin value = Emission Level – Limit value
- The other emission levels were very low against the limit.
- " * ": Fundamental frequency.
- The average value of fundamental and harmonic frequency is: Average = Peak value + 20 log(Duty cycle) Where the duty factor is calculated from following formula:
 $20 \log(\text{Duty cycle}) = 20 \log(0.6931 \text{ ms} / 4.113 \text{ ms}) = -15.5 \text{ dB}$
 Please see page 22 for plotted duty.

CHANNEL	TX Channel 25	DETECTOR FUNCTION	Peak (PK)
FREQUENCY RANGE	1GHz ~ 25GHz		Average (AV)

ANTENNA POLARITY & TEST DISTANCE: HORIZONTAL AT 3 M

NO.	FREQ. (MHz)	EMISSION LEVEL (dBuV/m)	LIMIT (dBuV/m)	MARGIN (dB)	ANTENNA HEIGHT (m)	TABLE ANGLE (Degree)	RAW VALUE (dBuV)	CORRECTION FACTOR (dB/m)
1	*2478.00	94.45 PK	114.00	-19.55	1.43 H	303	93.86	0.59
2	*2478.00	78.95 AV	94.00	-15.05	1.43 H	303	78.36	0.59
3	2483.50	45.00 PK	74.00	-29.00	1.43 H	303	44.38	0.62
4	2483.50	31.57 AV	54.00	-22.43	1.43 H	303	30.95	0.62
5	4956.00	56.81 PK	74.00	-17.19	2.64 H	322	48.31	8.50
6	4956.00	41.31 AV	54.00	-12.69	2.64 H	322	32.81	8.50
7	7434.00	56.36 PK	74.00	-17.64	1.00 H	27	43.09	13.27
8	7434.00	40.86 AV	54.00	-13.14	1.00 H	27	27.59	13.27

ANTENNA POLARITY & TEST DISTANCE: VERTICAL AT 3 M

NO.	FREQ. (MHz)	EMISSION LEVEL (dBuV/m)	LIMIT (dBuV/m)	MARGIN (dB)	ANTENNA HEIGHT (m)	TABLE ANGLE (Degree)	RAW VALUE (dBuV)	CORRECTION FACTOR (dB/m)
1	*2478.00	93.26 PK	114.00	-20.74	2.08 V	135	92.67	0.59
2	*2478.00	77.76 AV	94.00	-16.24	2.08 V	135	77.17	0.59
3	2483.50	44.82 PK	74.00	-29.18	2.08 V	135	44.20	0.62
4	2483.50	31.33 AV	54.00	-22.67	2.08 V	135	30.71	0.62
5	4956.00	59.16 PK	74.00	-14.84	1.89 V	317	50.66	8.50
6	4956.00	43.66 AV	54.00	-10.34	1.89 V	317	35.16	8.50
7	7434.00	64.45 PK	74.00	-9.55	1.04 V	307	51.18	13.27
8	7434.00	48.95 AV	54.00	-5.05	1.04 V	307	35.68	13.27

REMARKS:

- Emission Level(dBuV/m) = Raw Value(dBuV) + Correction Factor(dB/m)
- Correction Factor(dB/m) = Antenna Factor(dB/m) + Cable Factor(dB) – Pre-Amplifier Factor(dB)
- Margin value = Emission Level – Limit value
- The other emission levels were very low against the limit.
- " * ": Fundamental frequency.
- The average value of fundamental and harmonic frequency is: Average = Peak value + 20 log(Duty cycle) Where the duty factor is calculated from following formula:
 $20 \log(\text{Duty cycle}) = 20 \log(0.6931 \text{ ms} / 4.113 \text{ ms}) = -15.5 \text{ dB}$
 Please see page 22 for plotted duty.

Duty Cycle

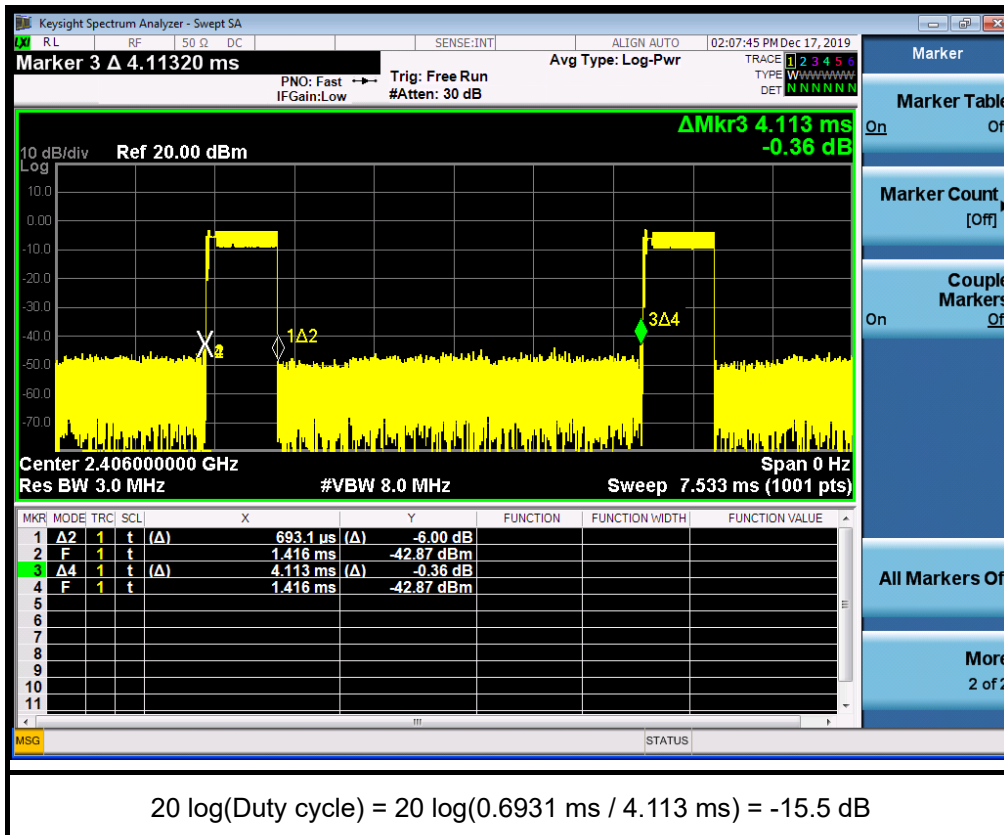

BELOW 1GHz WORST-CASE DATA

Mode A

CHANNEL	TX Channel 1	DETECTOR FUNCTION	Quasi-Peak (QP)
FREQUENCY RANGE	9kHz ~ 1GHz		

ANTENNA POLARITY & TEST DISTANCE: HORIZONTAL AT 3 M								
NO.	FREQ. (MHz)	EMISSION LEVEL (dBuV/m)	LIMIT (dBuV/m)	MARGIN (dB)	ANTENNA HEIGHT (m)	TABLE ANGLE (Degree)	RAW VALUE (dBuV)	CORRECTION FACTOR (dB/m)
1	133.21	22.41 QP	43.50	-21.09	3.45 H	219	30.15	-7.74
2	268.47	20.22 QP	46.00	-25.78	1.27 H	180	26.19	-5.97
3	398.36	23.96 QP	46.00	-22.04	3.08 H	48	27.02	-3.06
4	527.37	26.88 QP	46.00	-19.12	2.85 H	118	27.05	-0.17
5	618.89	29.43 QP	46.00	-16.57	3.33 H	348	27.21	2.22
6	915.61	35.31 QP	46.00	-10.69	1.14 H	331	27.97	7.34

REMARKS:

1. Emission Level(dBuV/m) = Raw Value(dBuV) + Correction Factor(dB/m)
2. Correction Factor(dB/m) = Antenna Factor(dB/m) + Cable Factor(dB) – Pre-Amplifier Factor(dB)
3. Margin value = Emission Level – Limit value
4. The other emission levels were very low against the limit of frequency range 30MHz~1000MHz.
5. The emission levels were very low against the limit of frequency range 9kHz~30MHz: the amplitude of spurious emissions attenuated more than 20 dB below the permissible value to be report.

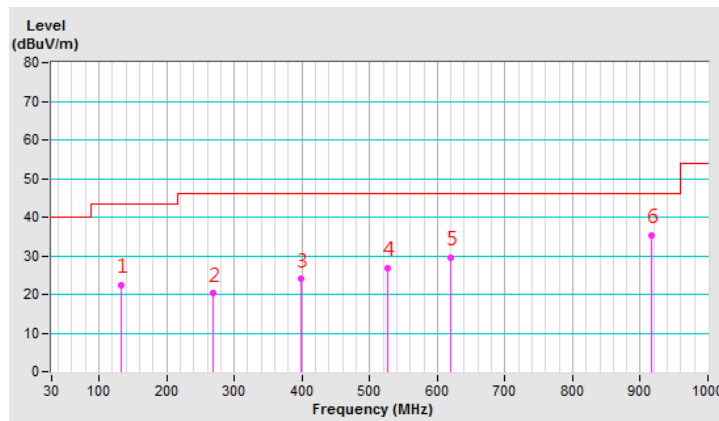

CHANNEL	TX Channel 1	DETECTOR FUNCTION	Quasi-Peak (QP)
FREQUENCY RANGE	9kHz ~ 1GHz		

ANTENNA POLARITY & TEST DISTANCE: VERTICAL AT 3 M

NO.	FREQ. (MHz)	EMISSION LEVEL (dBuV/m)	LIMIT (dBuV/m)	MARGIN (dB)	ANTENNA HEIGHT (m)	TABLE ANGLE (Degree)	RAW VALUE (dBuV)	CORRECTION FACTOR (dB/m)
1	149.46	21.56 QP	43.50	-21.94	2.45 V	113	28.31	-6.75
2	247.09	20.00 QP	46.00	-26.00	3.21 V	286	26.97	-6.97
3	311.69	22.27 QP	46.00	-23.73	1.57 V	51	26.84	-4.57
4	475.42	26.29 QP	46.00	-19.71	3.58 V	148	27.39	-1.10
5	623.49	29.75 QP	46.00	-16.25	2.54 V	122	27.43	2.32
6	906.78	34.62 QP	46.00	-11.38	2.65 V	139	27.44	7.18

REMARKS:

1. Emission Level(dBuV/m) = Raw Value(dBuV) + Correction Factor(dB/m)
2. Correction Factor(dB/m) = Antenna Factor(dB/m) + Cable Factor(dB) – Pre-Amplifier Factor(dB)
3. Margin value = Emission Level – Limit value
4. The other emission levels were very low against the limit of frequency range 30MHz~1000MHz.
5. The emission levels were very low against the limit of frequency range 9kHz~30MHz: the amplitude of spurious emissions attenuated more than 20 dB below the permissible value to be report.

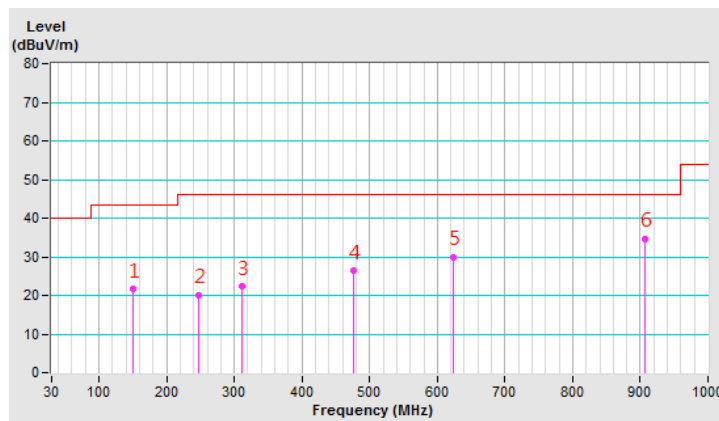

4.2 Conducted Emission Measurement

4.2.1 Limits of Conducted Emission Measurement

Frequency (MHz)	Conducted Limit (dBuV)	
	Quasi-peak	Average
0.15 - 0.5	66 - 56	56 - 46
0.50 - 5.0	56	46
5.0 - 30.0	60	50

Note: 1. The lower limit shall apply at the transition frequencies.

2. The limit decreases in line with the logarithm of the frequency in the range of 0.15 to 0.50MHz.

4.2.2 Test Instruments

Description & Manufacturer	Model No.	Serial No.	Cal. Date	Cal. Due
ROHDE & SCHWARZ TEST RECEIVER	ESR3	102413	Feb. 18, 2019	Feb. 17, 2020
ROHDE & SCHWARZ Artificial Mains Network (for EUT)	ESH2-Z5	100104	Dec. 13, 2019	Dec. 12, 2020
LISN With Adapter (for EUT)	AD10	C09Ada-001	Dec. 13, 2019	Dec. 12, 2020
ROHDE & SCHWARZ Artificial Mains Network (for peripherals)	ESH3-Z5	847265/023	Oct. 31, 2019	Oct. 30, 2020
SCHWARZBECK Artificial Mains Network (For EUT)	NNLK8129	8129229	May 14, 2019	May 13, 2020
SCHWARZBECK Artificial Mains Network (For EUT)	NNLK 8121	8121-808	Mar. 15, 2019	Mar. 14, 2020
Software	Cond_V7.3.7.4	NA	NA	NA
RF cable (JYEBAO) With 10dB PAD	5D-FB	Cable-C09.01	Aug. 15, 2019	Aug. 14, 2020
SUHNTER Terminator (For ROHDE & SCHWARZ LISN)	65BNC-5001	E1-010789	May 13, 2019	May 12, 2020

Note: 1. The calibration interval of the above test instruments is 12 months and the calibrations are traceable to NML/ROC and NIST/USA.

2. The test was performed in Shielded Room No. 9.

3. Tested Date: Nov. 16, 2019

4.2.3 Test Procedures

- The EUT was placed 0.4 meters from the conducting wall of the shielded room with EUT being connected to the power mains through a line impedance stabilization network (LISN). Other support units were connected to the power mains through another LISN. The two LISNs provide 50 ohm/ 50uH of coupling impedance for the measuring instrument.
- Both lines of the power mains connected to the EUT were checked for maximum conducted interference.
- The frequency range from 150kHz to 30MHz was searched. Emission levels under (Limit - 20dB) was not recorded.

NOTE: The resolution bandwidth and video bandwidth of test receiver is 9kHz for quasi-peak detection (QP) and average detection (AV) at frequency 0.15MHz-30MHz.

4.2.4 Deviation from Test Standard

No deviation.

4.2.5 Test Setup

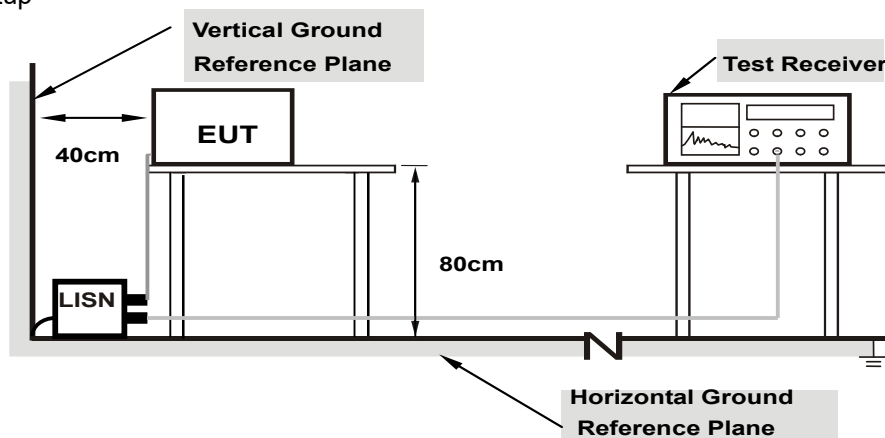

Note: 1.Support units were connected to second LISN.

For the actual test configuration, please refer to the attached file (Test Setup Photo).

4.2.6 EUT Operating Conditions

- Connected the EUT to Notebook or Adapter.
- Set the EUT under transmission condition continuously at specific channel frequency.

4.2.7 Test Results

Mode A

Phase	Line (L)	Detector Function	Quasi-Peak (QP) / Average (AV)
-------	----------	-------------------	--------------------------------

Phase Of Power : Line (L)										
No	Frequency (MHz)	Correction Factor (dB)	Reading Value (dBuV)		Emission Level (dBuV)		Limit (dBuV)		Margin (dB)	
			Q.P.	AV.	Q.P.	AV.	Q.P.	AV.	Q.P.	AV.
1	0.15000	10.55	38.70	19.39	49.25	29.94	66.00	56.00	-16.75	-26.06
2	0.43934	10.62	18.99	11.65	29.61	22.27	57.07	47.07	-27.46	-24.80
3	4.79271	11.00	18.79	11.69	29.79	22.69	56.00	46.00	-26.21	-23.31
4	7.08794	11.13	14.82	8.89	25.95	20.02	60.00	50.00	-34.05	-29.98
5	8.19838	11.19	15.52	10.12	26.71	21.31	60.00	50.00	-33.29	-28.69
6	20.72602	11.91	15.29	10.22	27.20	22.13	60.00	50.00	-32.80	-27.87

Remarks:

1. Q.P. and AV. are abbreviations of quasi-peak and average individually.
2. The emission levels of other frequencies were very low against the limit.
3. Margin value = Emission level – Limit value
4. Correction factor = Insertion loss + Cable loss
5. Emission Level = Correction Factor + Reading Value

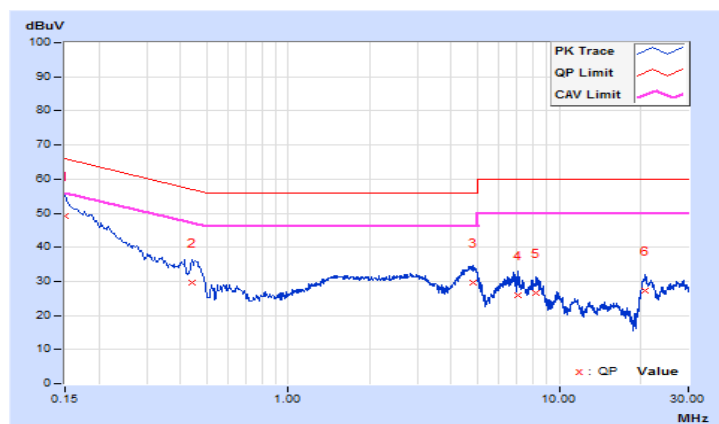

Phase	Neutral (N)	Detector Function	Quasi-Peak (QP) / Average (AV)
-------	-------------	-------------------	--------------------------------

Phase Of Power : Neutral (N)										
No	Frequency (MHz)	Correction Factor (dB)	Reading Value (dBuV)		Emission Level (dBuV)		Limit (dBuV)		Margin (dB)	
			Q.P.	AV.	Q.P.	AV.	Q.P.	AV.	Q.P.	AV.
1	0.15000	10.58	39.15	20.81	49.73	31.39	66.00	56.00	-16.27	-24.61
2	0.15969	10.58	36.54	16.30	47.12	26.88	65.48	55.48	-18.36	-28.60
3	0.17328	10.59	37.81	17.31	48.40	27.90	64.80	54.80	-16.40	-26.90
4	0.36896	10.63	16.08	1.52	26.71	12.15	58.52	48.52	-31.81	-36.37
5	0.44325	10.63	20.87	13.62	31.50	24.25	57.00	47.00	-25.50	-22.75
6	0.78934	10.66	7.93	1.98	18.59	12.64	56.00	46.00	-37.41	-33.36
7	0.84408	10.67	9.82	4.48	20.49	15.15	56.00	46.00	-35.51	-30.85

Remarks:

1. Q.P. and AV. are abbreviations of quasi-peak and average individually.
2. The emission levels of other frequencies were very low against the limit.
3. Margin value = Emission level – Limit value
4. Correction factor = Insertion loss + Cable loss
5. Emission Level = Correction Factor + Reading Value

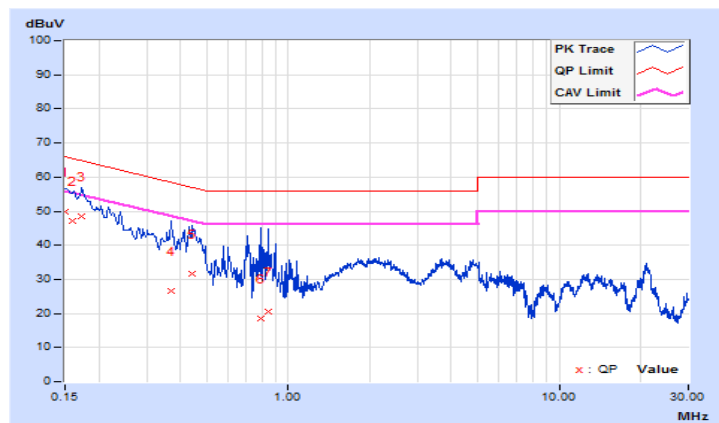

Mode B

Phase	Line (L)	Detector Function	Quasi-Peak (QP) / Average (AV)
-------	----------	-------------------	--------------------------------

Phase Of Power : Line (L)										
No	Frequency (MHz)	Correction Factor (dB)	Reading Value (dBuV)		Emission Level (dBuV)		Limit (dBuV)		Margin (dB)	
			Q.P.	AV.	Q.P.	AV.	Q.P.	AV.	Q.P.	AV.
1	0.16526	10.56	7.65	5.13	18.21	15.69	65.20	55.20	-46.99	-39.51
2	0.32186	10.60	6.31	4.70	16.91	15.30	59.66	49.66	-42.75	-34.36
3	0.78934	10.65	8.83	4.15	19.48	14.80	56.00	46.00	-36.52	-31.20
4	2.26341	10.80	4.13	3.28	14.93	14.08	56.00	46.00	-41.07	-31.92
5	4.89093	11.01	1.95	1.39	12.96	12.40	56.00	46.00	-43.04	-33.60
6	10.90410	11.35	2.43	1.57	13.78	12.92	60.00	50.00	-46.22	-37.08

Remarks:

1. Q.P. and AV. are abbreviations of quasi-peak and average individually.
2. The emission levels of other frequencies were very low against the limit.
3. Margin value = Emission level – Limit value
4. Correction factor = Insertion loss + Cable loss
5. Emission Level = Correction Factor + Reading Value

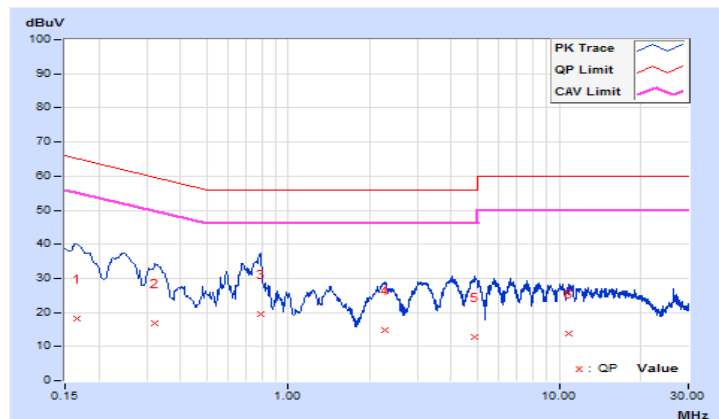

Phase	Neutral (N)	Detector Function	Quasi-Peak (QP) / Average (AV)
-------	-------------	-------------------	--------------------------------

Phase Of Power : Neutral (N)										
No	Frequency (MHz)	Correction Factor (dB)	Reading Value (dBuV)		Emission Level (dBuV)		Limit (dBuV)		Margin (dB)	
			Q.P.	AV.	Q.P.	AV.	Q.P.	AV.	Q.P.	AV.
1	0.16096	10.58	8.02	5.97	18.60	16.55	65.41	55.41	-46.81	-38.86
2	0.25166	10.62	3.56	2.49	14.18	13.11	61.70	51.70	-47.52	-38.59
3	0.64858	10.65	8.58	2.70	19.23	13.35	56.00	46.00	-36.77	-32.65
4	0.73460	10.66	2.86	1.38	13.52	12.04	56.00	46.00	-42.48	-33.96
5	4.33180	10.98	5.48	3.09	16.46	14.07	56.00	46.00	-39.54	-31.93
6	7.19742	11.11	3.79	1.45	14.90	12.56	60.00	50.00	-45.10	-37.44

Remarks:

1. Q.P. and AV. are abbreviations of quasi-peak and average individually.
2. The emission levels of other frequencies were very low against the limit.
3. Margin value = Emission level – Limit value
4. Correction factor = Insertion loss + Cable loss
5. Emission Level = Correction Factor + Reading Value

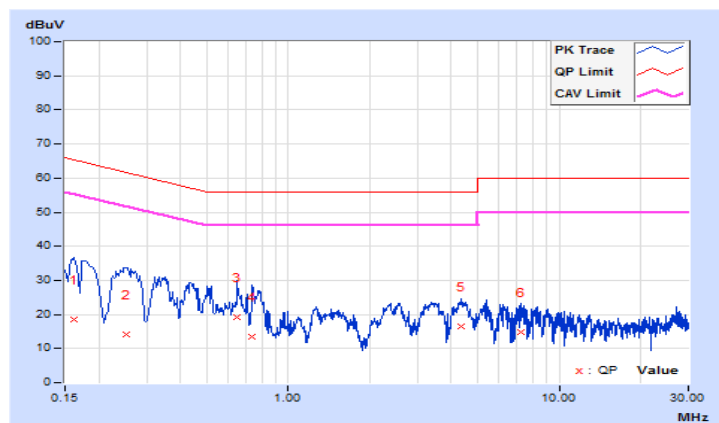

4.3 Channel Bandwidth

4.3.1 Test Setup

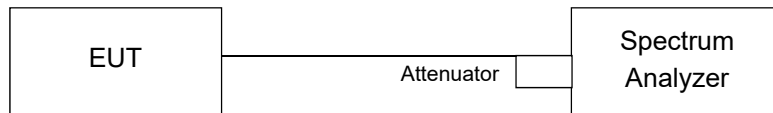

4.3.2 Test Instruments

DESCRIPTION & MANUFACTURER	MODEL NO.	SERIAL NO.	CALIBRATED DATE	CALIBRATED UNTIL
ROHDE & SCHWARZ Spectrum Analyzer	FSV40	101042	Sep. 23, 2019	Sep. 22, 2020

- NOTE:** 1. The calibration interval of the above test instruments is 12/24 months. And the calibrations are traceable to NML/ROC and NIST/USA.
 2. Tested Date: Oct. 31, 2019

4.3.3 Test Procedure

- Check the calibration of the measuring instrument using either an internal calibrator or a known signal from an external generator.
- Turn on the EUT and connect it to measurement instrument. Then set it to any one convenient frequency within its operating range. Set a reference level on the measuring instrument equal to the highest peak value.
- Measure the frequency difference of two frequencies that were attenuated 20dB from the reference level. Record the frequency difference as the emission bandwidth.
- Repeat above procedures until all frequencies measured were complete.

4.3.4 Deviation from Test Standard

No deviation.

4.3.5 EUT Operating Condition

The software provided by client enabled the EUT to transmit and receive data at lowest, middle and highest channel frequencies individually.

4.3.6 Test Results

Mode A

CHANNEL	FREQUENCY (MHz)	20dB BANDWIDTH (MHz)
1	2406	3.51
12	2439	3.63
25	2478	3.73

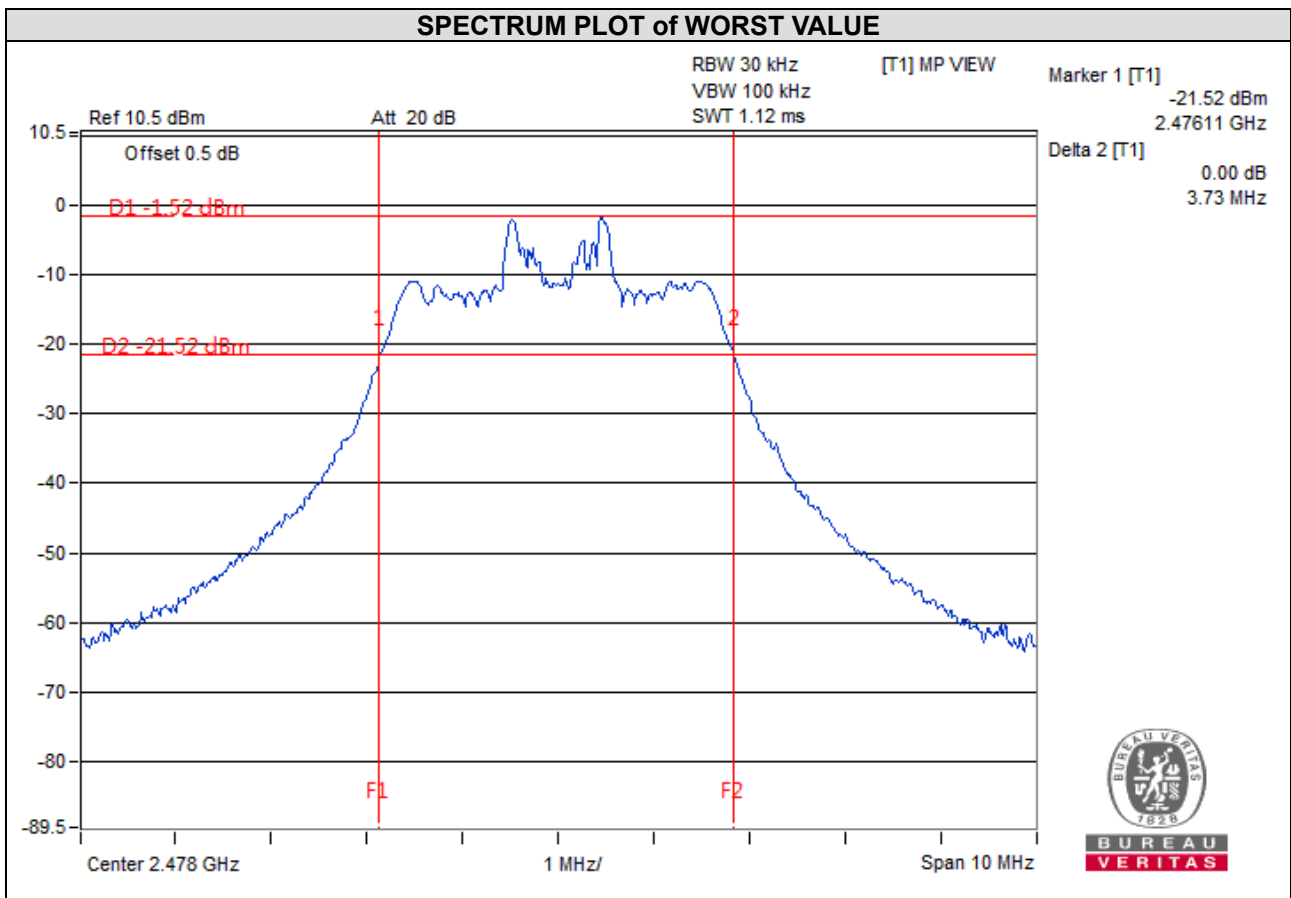

5 Pictures of Test Arrangements

Please refer to the attached file (Test Setup Photo).

Appendix – Information of the Testing Laboratories

We, Bureau Veritas Consumer Products Services (H.K.) Ltd., Taoyuan Branch, were founded in 1988 to provide our best service in EMC, Radio, Telecom and Safety consultation. Our laboratories are FCC recognized accredited test firms and accredited according to ISO/IEC 17025.

If you have any comments, please feel free to contact us at the following:

Lin Kou EMC/RF Lab

Tel: 886-2-26052180

Fax: 886-2-26051924

Hsin Chu EMC/RF/Telecom Lab

Tel: 886-3-6668565

Fax: 886-3-6668323

Hwa Ya EMC/RF/Safety Lab

Tel: 886-3-3183232

Fax: 886-3-3270892

Email: service.adt@tw.bureauveritas.com

Web Site: www.bureauveritas-adt.com

The address and road map of all our labs can be found in our web site also.

--- END ---