

**FCC 47 CFR PART 15 SUBPART C AND ANSI C63.10:2013
TEST REPORT**

For

Bluetooth Amplifier

Model: BSS-005

Data Applies To: SO-7500; SO-7500XXXXXXXX (X=0~9, a~z, A~Z)

Trade Name: SOLIS

Issued for

Acrox Technologies Co., Ltd.

4F., No.89, Minshan St., Neihu Dist., Taipei City 114, Taiwan, R.O.C.

Issued by

**Compliance Certification Services Inc.
Hsinchu Lab.**

**No.989-1, Wenshan Rd., Shangshan Village,
Qionglin Township, Hsinchu County 30741, Taiwan (R.O.C.)**

TEL: +886-3-5921698

FAX: +886-3-5921108

<http://www.ccsrf.com>

E-Mail: service@ccsrf.com

Issued Date: June 14, 2017



Note: This report shall not be reproduced except in full, without the written approval of Compliance Certification Services Inc. This document may be altered or revised by Compliance Certification Services Inc. personnel only, and shall be noted in the revision section of the document. The client should not use it to claim product endorsement by TAF or any government agencies. The test results of this report relate only to the tested sample identified in this report.

Revision History

Rev.	Issue Date	Revisions	Effect Page	Revised By
00	06/12/2017	Initial Issue	All Page 49	Gloria Chang
01	06/14/2017	Revised FCC ID	All Page 49	Gloria Chang

TABLE OF CONTENTS

TITLE	PAGE NO.
1. TEST REPORT CERTIFICATION.....	4
2. EUT DESCRIPTION.....	5
3. DESCRIPTION OF TEST MODES.....	6
4. TEST METHODOLOGY.....	7
5. FACILITIES AND ACCREDITATION.....	7
5.1 FACILITIES.....	7
5.2 ACCREDITATIONS.....	7
5.3 MEASUREMENT UNCERTAINTY.....	8
6. SETUP OF EQUIPMENT UNDER TEST.....	9
7. FCC PART 15.247 REQUIREMENTS.....	10
7.1 DUTY CYCLE CORRECTION FACTOR.....	10
7.2 6dB BANDWIDTH.....	11
7.3 MAXIMUM PEAK OUTPUT POWER.....	15
7.4 AVERAGE POWER.....	17
7.5 POWER SPECTRAL DENSITY.....	19
7.6 CONDUCTED SPURIOUS EMISSION.....	24
7.7 RADIATED EMISSION.....	28
7.8 CONDUCTED EMISSION.....	41
8. APPENDIX SETUP PHOTOS.....	46

1. TEST REPORT CERTIFICATION

Applicant : Acrox Technologies Co., Ltd.
Address : 4F., No.89, Minshan St., Neihu Dist., Taipei City 114,
 Taiwan, R.O.C.
Equipment Under Test : Bluetooth Amplifier
Model : BSS-005
Data Applies To : SO-7500; SO-7500XXXXXXXX (X=0~9, a~z, A~Z)
Trade Name : SOLIS
Tested Date : March 13 ~ April 14, 2017

APPLICABLE STANDARD	
Standard	Test Result
FCC Part 15 Subpart C AND ANSI C63.10:2013	PASS

WE HEREBY CERTIFY THAT: The above equipment has been tested by Compliance Certification Services Inc., and found compliance with the requirements set forth in the technical standards mentioned above. The results of testing in this report apply only to the product/system, which was tested. Other similar equipment will not necessarily produce the same results due to production tolerance and measurement uncertainties.

Approved by:



Sb. Lu
Sr. Engineer

Reviewed by:



Gundam Lin
Sr. Engineer

2. EUT DESCRIPTION

Product Name	Bluetooth Amplifier
Model Number	BSS-005
Data Applies To	SO-7500; SO-7500XXXXXXXX (X=0~9, a~z, A~Z)
Identify Number	T170313D09
Received Date	March 13, 2017
Frequency Range	2402MHz ~ 2480MHz
Transmit Power	6.99 dBm (0.0050W)
Channel Spacing	2MHz
Channel Number	40 Channels
Transmit Data Rate	1Mbps
Type of Modulation	GFSK
Antenna Type	PCB Antenna, Antenna Gain: -5.69 dBi
Power Rating	110Vac, 50/60Hz, 1.6A 230Vac, 50/60Hz, 1.6A
Test Voltage	120Vac, 60Hz
AC Power Cord Type	Non-shielded cable, 1.7 m × 1 (Detachable)
I/O Port	LINE 1(L/R) Port × 2, LINE 2(L/R) Port × 2, Speaker(R) Output Port × 2, Speaker(L) Output Port × 2, Power Port × 1
Signal Cable	Shielded AV cable, 1.7m × 2 (Detachable) Non-shielded audio cable, 1.75m × 2 (Detachable)
Support Equipment	Speaker × 2

The difference of the series model

Model Number	Difference
BSS-005	1. X=0~9, a~z, A~Z 2. The different models as for the marketing purpose.
SO-7500	
SO-7500XXXXXXXX	

Remark:

1. The sample selected for test was engineering sample that approximated to production product and was provided by manufacturer.
2. For more details, please refer to the User's manual of the EUT.
3. This submittal(s) (test report) is intended for FCC ID: PRDBSS05 filing to comply with Section 15.207, 15.209 and 15.247 of the FCC Part 15, Subpart C Rules.
4. The model BSS-005 was considered the main model for testing.

3. DESCRIPTION OF TEST MODES

Conducted Emission / Radiated Emission Test (Below 1 GHz)

1. The following test modes were scanned during the preliminary test:

No.	Pre-Test mode
1	TX mode
2	Normal Mode

2. After the preliminary scan, the following test mode was found to produce the highest emission level.

Final Test mode		
Emission	Radiated Emission	Mode 1
	Conducted Emission	Mode 2

Remark: Then, the above highest emission mode of the configuration of the EUT and cable was chosen for all final test items.

Conducted / Radiated Emission Test (Above 1 GHz)

The EUT had been tested under operating condition.

There are three channels have been tested as following:

Channel	Frequency (MHz)
Low	2402
Middle	2440
High	2480

4. TEST METHODOLOGY

The tests documented in this report were performed in accordance with ANSI C63.10:2013 and FCC CFR 47, 15.207, 15.209 and 15.247.

5. FACILITIES AND ACCREDITATION

5.1 FACILITIES

All measurement facilities used to collect the measurement data are located at

No.989-1, Wenshan Rd., Shangshan Village,
Qionglin Township, Hsinchu County 30741, Taiwan (R.O.C.)

The sites are constructed in conformance with the requirements of ANSI C63.10:2013 and CISPR 22. All receiving equipment conforms to CISPR 16-1-1, CISPR 16-1-2, CISPR 16-1-3, CISPR 16-1-4 and CISPR 16-1-5.

5.2 ACCREDITATIONS

Our laboratories are accredited and approved by the following approval agencies according to ISO/IEC 17025.

Taiwan	TAF
---------------	-----

The measuring facility of laboratories has been authorized or registered by the following approval agencies.

Canada	INDUSTRY CANADA
Japan	VCCI
Taiwan	BSMI
USA	FCC MRA

Copies of granted accreditation certificates are available for downloading from our web site, <http://www.ccsrf.com>

Remark: FCC Designation Number TW1027.

5.3 MEASUREMENT UNCERTAINTY

The following table is for the measurement uncertainty, which is calculated as per the document CISPR 16-4-2.

PARAMETER	UNCERTAINTY
Semi Anechoic Chamber (966 Chamber_B) / Radiated Emission, 30 to 1000 MHz	+/- 3.97
Semi Anechoic Chamber (966 Chamber_B) / Radiated Emission, 1 to 18GHz	+/- 3.58
Semi Anechoic Chamber (966 Chamber_B) / Radiated Emission, 18 to 26 GHz	+/- 3.59
Semi Anechoic Chamber (966 Chamber_B) / Radiated Emission, 26 to 40 GHz	+/- 3.81
Conducted Emission (Mains Terminals), 9kHz to 30MHz	+/- 2.48

This uncertainty represents an expanded uncertainty expressed at approximately the 95% confidence level using a coverage factor of k=2.

Consistent with industry standard (e.g. CISPR 22, clause 11, Measurement Uncertainty) determining compliance with the limits shall be base on the results of the compliance measurement. Consequently the measure emissions being less than the maximum allowed emission result in this be a compliant test or passing test.

The acceptable measurement uncertainty value without requiring revision of the compliance statement is base on conducted and radiated emissions being less than U_{CISPR} which is 3.6dB and 5.2dB respectively. CCS values (called U_{Lab} in CISPR 16-4-2) is less than U_{CISPR} as shown in the table above. Therefore, MU need not be considered for compliance.

6. SETUP OF EQUIPMENT UNDER TEST

SUPPORT EQUIPMENT

No.	Product	Manufacturer	Model No.	Serial No.
1	Notebook PC	TOSHIBA	PORTEGE R30-A	7F097011H
2	DC Power Supply	Agilent	E3631A	MY40007576
3	DVD Player	BLUESKY	DVD-929U	0729U01365
4	DVD Player	BLUESKY	DVD-929U	0729U00362
5	Galaxy S5	Samsung	SM-G900I	R58F818DMSB

No.	Signal Cable Description
1	Non-shielded DC cable, 1m × 1
2	Shielded USB cable, 2m × 1, with two ferrite core
3	Shielded print cable, 2m × 1, with two ferrite core

SETUP DIAGRAM FOR TESTS

EUT & peripherals setup diagram is shown in appendix setup photos.

EUT OPERATING CONDITION

RF Mode:

1. EUT & peripherals setup diagram is shown in appendix setup photos.
2. TX mode:

⇒ **Power control:**

Channel Low (2402MHz) Power set Default.

Channel Mid (2440MHz) Power set Default.

Channel High (2480MHz) Power set Default.

3. All of the functions are under run.
4. Start test

Normal Mode:

1. EUT & peripherals setup diagram is shown in appendix setup photos.
2. Power of all equipment.
3. Connect the speaker.
4. AV terminal link DVD player.
5. Bluetooth link to mobile phone.
6. Play music.
7. All of the functions are under run.
8. Start test.

7. FCC PART 15.247 REQUIREMENTS

7.1 DUTY CYCLE CORRECTION FACTOR

Product Name	Bluetooth Amplifier	Test By	Rex Chiu
Test Model	BSS-005	Test Date	2017/04/05
Test Mode	TX Mode	Temp. & Humidity	25°C, 50%

TX on (ms)	TX on + off (ms)	Duty Cycle (%)	Duty Factor (dB)	1/T Minimum VBW (kHz)
0.425	0.649	65.49%	1.84	2.353

7.2 6dB BANDWIDTH

LIMITS

§ 15.247(a) (2) For direct sequence systems, the minimum 6dB bandwidth shall be at least 500kHz.

TEST EQUIPMENT

Name of Equipment	Manufacturer	Model	Serial Number	Calibration Due
EXA Signal Analyzer	Agilent	N9010A	MY52220817	03/07/2018
Test S/W	N/A			

Remark: Each piece of equipment is scheduled for calibration once a year.

TEST SETUP

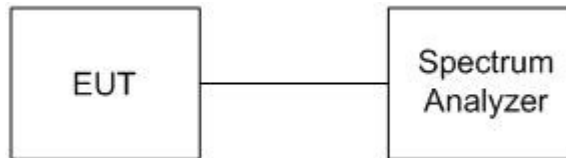

TEST PROCEDURE

1. The transmitter output was connected to a spectrum analyzer.
2. Set RBW = 100 kHz.
3. Set the video bandwidth (VBW) $\geq 3 \times$ RBW.
4. Detector = Peak.
5. Trace mode = max hold.
6. Sweep = auto couple.
7. Allow the trace to stabilize.
8. Measure the maximum width of the emission that is constrained by the frequencies associated with the two outermost amplitude points (upper and lower frequencies) that are attenuated by 6 dB relative to the maximum level measured in the fundamental emission.

TEST RESULTS

Product Name	Bluetooth Amplifier	Test By	Waternil Guan
Test Model	BSS-005	Test Date	2017/04/10
Test Mode	TX Mode	Temp. & Humidity	25°C, 53%

Channel	Channel Frequency (MHz)	6dB Bandwidth (MHz)	Minimum Limit (kHz)	Result
Low	2402	0.689	500	PASS
Middle	2440	0.677	500	PASS
High	2480	0.678	500	PASS

6dB BANDWIDTH

CH Low

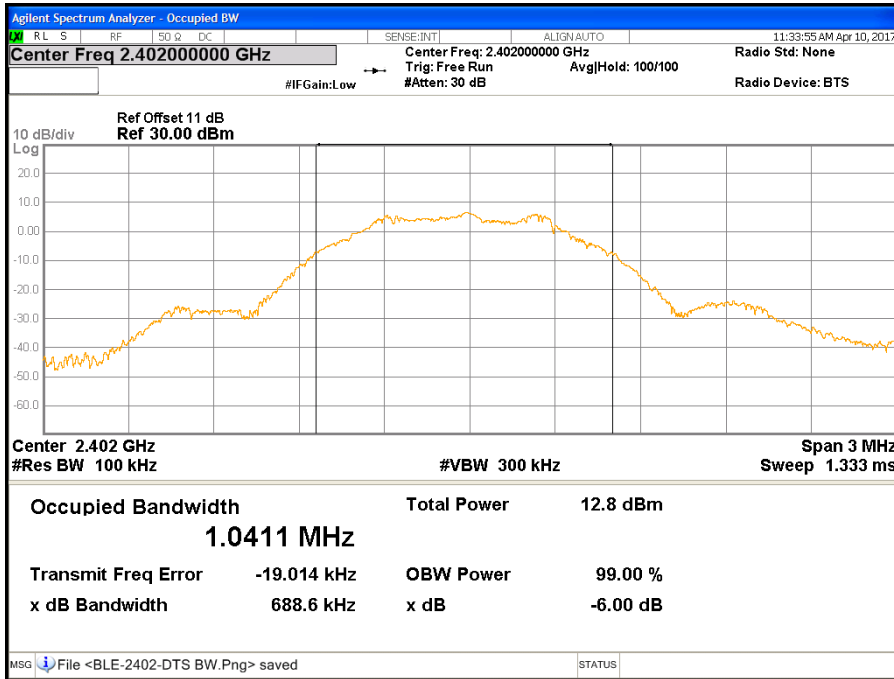

CH Middle

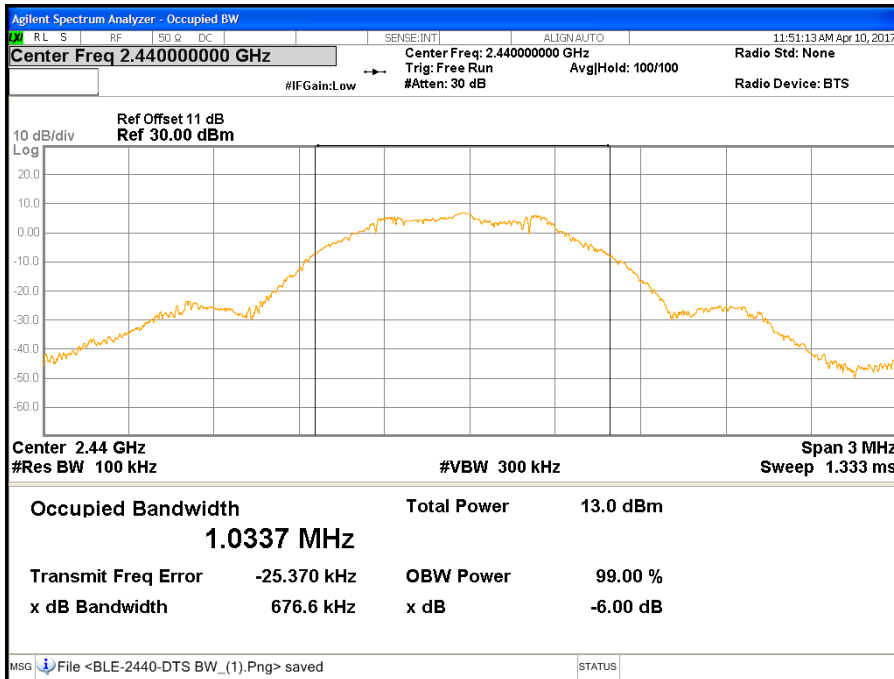

CH High

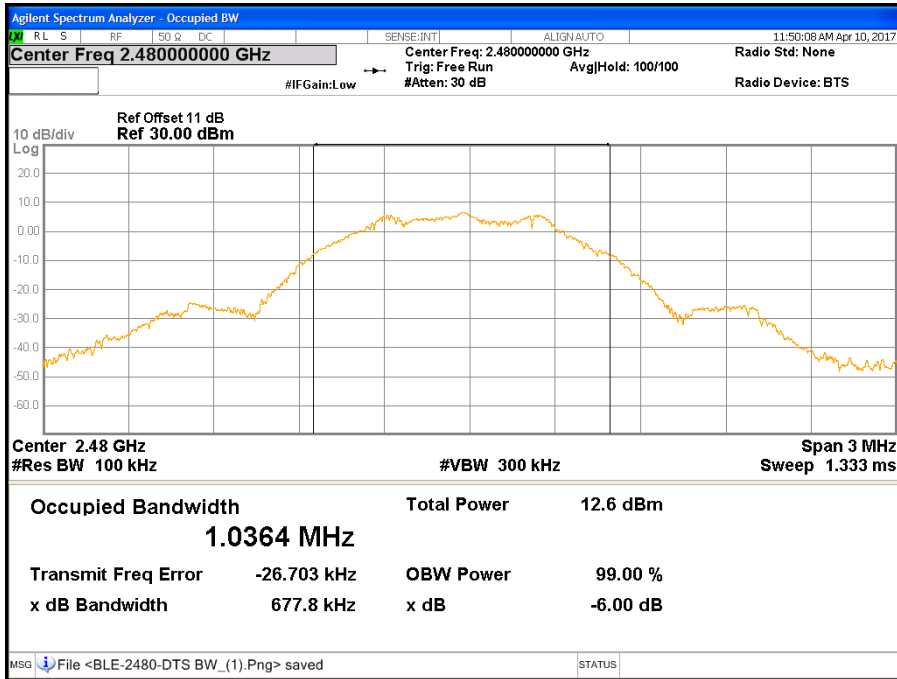

7.3 MAXIMUM PEAK OUTPUT POWER

LIMITS

§ 15.247(b) The maximum peak output power of the intentional radiator shall not exceed the following:

§ 15.247(b) (3) For systems using digital modulation in the 902-928 MHz, 2400-2483.5 MHz, and 5725-5850 MHz bands: 1 watt.

§ 15.247(b) (4) Except as shown in paragraphs (c) of this section, if transmitting antennas of directional gain greater than 6 dBi are used the peak output power from the intentional radiator shall be reduced below the stated values in paragraphs (b)(1) or (b)(2), and (b)(3) of this section, as appropriate, by the amount in dB that the directional gain of the antenna exceeds 6 dBi.

TEST EQUIPMENT

Name of Equipment	Manufacturer	Model	Serial Number	Calibration Due
Power Meter	Anritsu	ML2495A	1149001	12/05/2017
Power Sensor	Anritsu	MA2411B	1126148	12/05/2017
Test S/W	N/A			

Remark: Each piece of equipment is scheduled for calibration once a year.

TEST SETUP

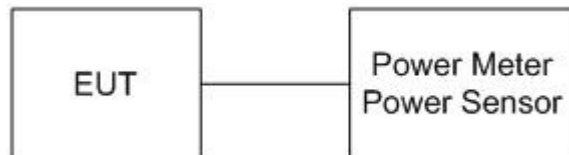

TEST PROCEDURE

The transmitter output is connected to the power meter. The power meter is set to the peak power detection.

TEST RESULTS

Product Name	Bluetooth Amplifier	Test By	Waternil Guan
Test Model	BSS-005	Test Date	2017/04/10
Test Mode	TX Mode	Temp. & Humidity	25°C, 53%

Channel	Channel Frequency (MHz)	Maximum Peak Output Power				Result
		Measured Value		Limit		
		(dBm)	(W)	(dBm)	(W)	
Low	2402	6.80	0.0048	30.00	1.0000	PASS
Middle	2440	6.99	0.0050	30.00	1.0000	PASS
High	2480	6.63	0.0046	30.00	1.0000	PASS

Remark: The cable assembly insertion loss of 11 dB (including 10 dB pad and 1 dB cable) was entered as an offset in the power meter to allow for direct reading of power.

7.4 AVERAGE POWER

LIMITS

None: For reporting purposes only.

TEST EQUIPMENT

Name of Equipment	Manufacturer	Model	Serial Number	Calibration Due
Power Meter	Anritsu	ML2495A	1149001	12/05/2017
Power Sensor	Anritsu	MA2411B	1126148	12/05/2017
Test S/W	N/A			

Remark: Each piece of equipment is scheduled for calibration once a year.

TEST SETUP

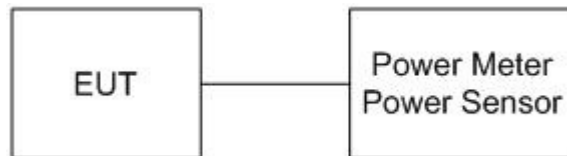

TEST PROCEDURE

The transmitter output is connected to the power meter. The power meter is set to the average power detection.

TEST RESULTS

Product Name	Bluetooth Amplifier	Test By	Waternil Guan
Test Model	BSS-005	Test Date	2017/04/10
Test Mode	TX Mode	Temp. & Humidity	25°C, 53%

Channel	Channel Frequency (MHz)	Average Power (dBm)
Low	2402	6.56
Middle	2440	6.79
High	2480	6.46

Remark: The cable assembly insertion loss of 11 dB (including 10 dB pad and 1 dB cable) was entered as an offset in the power meter to allow for direct reading of power.

7.5 POWER SPECTRAL DENSITY

LIMITS

§ 15.247(e) For digitally modulated systems, the power spectral density conducted from the intentional radiator to the antenna shall not greater than 8 dBm in any 3 kHz band during any time interval of continuous transmission.

§ KDB 662911:

If all antennas have the same gain, G_{ANT} , Directional gain = G_{ANT} + Array Gain, where Array Gain is as follows.

Array Gain = $10 \log(N_{ANT}/N_{SS})$ dB.

If antenna gains are not equal, the user may use either of the following methods to calculate directional gain, provided that each transmit antenna is driven by only one spatial stream:

Directional gain may be calculated by using the formulas applicable to equal gain antennas with G_{ANT} set equal to the gain of the antenna having the highest gain; or,

$$DirectionalGain = 10 \cdot \log \left[\frac{\sum_{j=1}^{N_{SS}} \left\{ \sum_{k=1}^{N_{ANT}} g_{j,k} \right\}^2}{N_{ANT}} \right]$$

TEST EQUIPMENT

Name of Equipment	Manufacturer	Model	Serial Number	Calibration Due
EXA Signal Analyzer	Agilent	N9010A	MY52220817	03/07/2018
Test S/W	N/A			

Remark: Each piece of equipment is scheduled for calibration once a year.

TEST SETUP



TEST PROCEDURE

1. The transmitter output was connected to the spectrum analyzer.
2. Set analyzer center frequency to DTS channel center frequency.
3. Set the span to 1.5 times the DTS channel bandwidth.
4. Set the RBW to: $3 \text{ kHz} \leq \text{RBW} \leq 100 \text{ kHz}$.
5. Set the VBW $\geq 3 \times \text{RBW}$.
6. Detector = peak.
7. Sweep time = auto couple.
8. Trace mode = max hold.
9. Allow trace to fully stabilize.
10. Use the peak marker function to determine the maximum amplitude level within the RBW.
11. If measured value exceeds limit, reduce RBW (no less than 3 kHz) and repeat.

TEST RESULTS

Product Name	Bluetooth Amplifier	Test By	Waternil Guan
Test Model	BSS-005	Test Date	2017/04/10
Test Mode	TX Mode	Temp. & Humidity	25°C, 53%

Channel	Channel Frequency (MHz)	Final RF Power Level in 3KHz BW (dBm)		Result
		Measured Value	Limit	
Low	2402	-1.030	8	PASS
Middle	2440	-0.700	8	PASS
High	2480	-1.000	8	PASS

Remark: The cable assembly insertion loss of 11 dB (including 10 dB pad and 1 dB cable) was entered as an offset in the spectrum analyzer to allow for direct reading of power.

POWER SPECTRAL DENSITY

CH Low

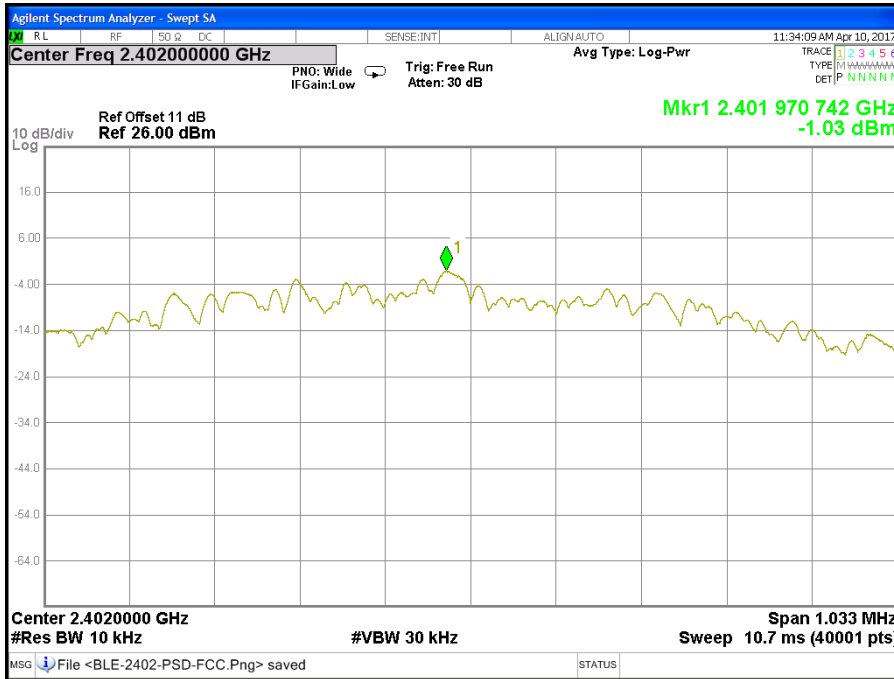

CH Middle



CH High

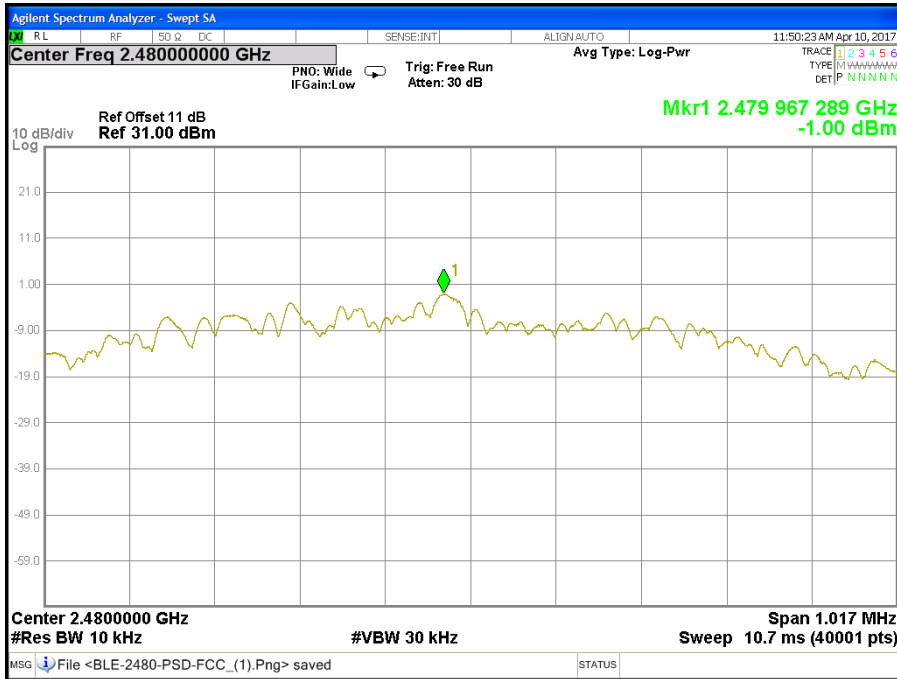

7.6 CONDUCTED SPURIOUS EMISSION

LIMITS

§ 15.247(d) In any 100 kHz bandwidth outside the frequency band in which the spread spectrum intentional radiator is operating, the radio frequency power that is produced by the intentional radiator shall be at least 20 dB below that in the 100 kHz bandwidth within the and that contains the highest level of the desired power, based on either an RF conducted or a radiated measurement. Attenuation below the general limits specified in § 15.209(a) is not required. In addition, radiated emissions which fall in the restricted bands, as defined in § 15.205(a), must also comply with the radiated emission limits specified in § 15.209(a) (see § 15.205(c)).

TEST EQUIPMENT

Name of Equipment	Manufacturer	Model	Serial Number	Calibration Due
EXA Signal Analyzer	Agilent	N9010A	MY52220817	03/07/2018
Test S/W	N/A			

Remark: Each piece of equipment is scheduled for calibration once a year.

TEST SETUP



TEST PROCEDURE

The transmitter output is connected to a spectrum analyzer. The resolution bandwidth is set to 100 kHz. The video bandwidth is set to 300 kHz.

The spectrum from 30 MHz to 26.5 GHz is investigated with the transmitter set to the lowest, middle, and highest channels in the 2.4 GHz band.

TEST RESULTS

Product Name	Bluetooth Amplifier	Test By	Waternil Guan
Test Model	BSS-005	Test Date	2017/04/10
Test Mode	TX Mode	Temp. & Humidity	25°C, 50%

OUT-OF-BAND SPURIOUS EMISSIONS-CONDUCTED MEASUREMENT

CH Low (2.38GHz ~ 2.5GHz)

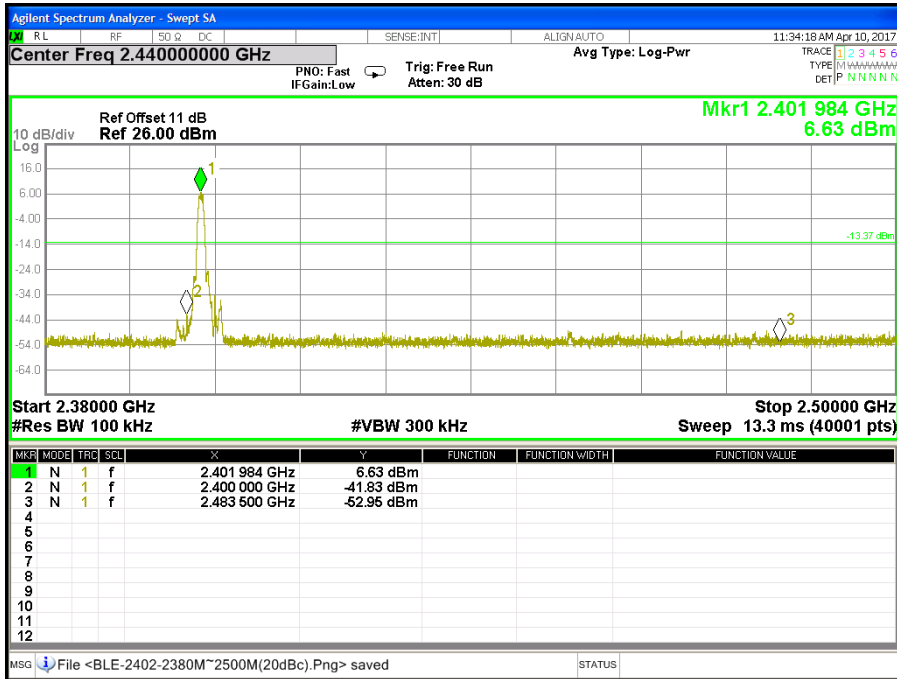

CH Low (30MHz ~ 26.5GHz)

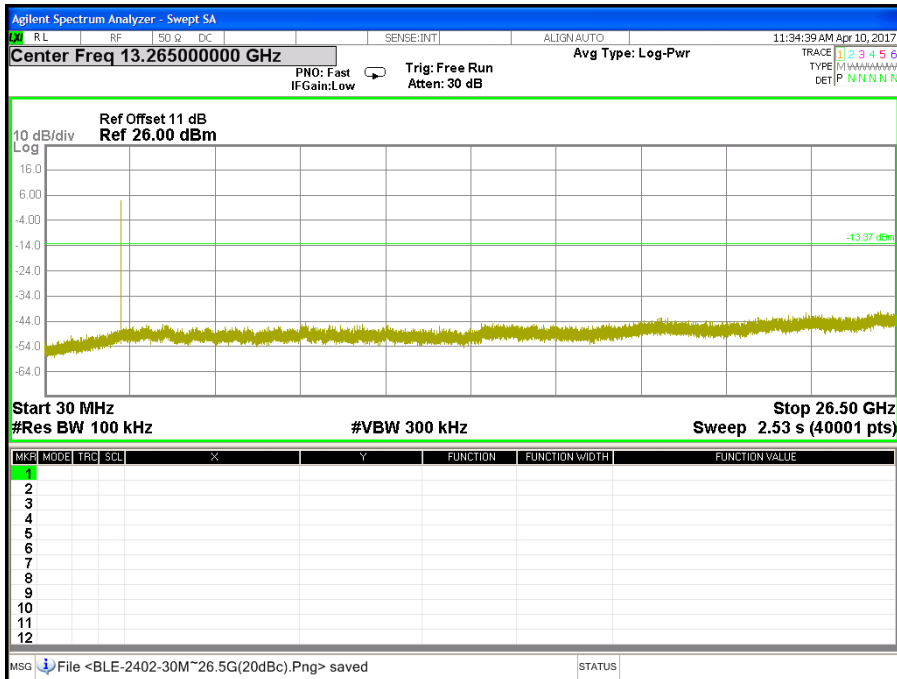

CH Middle (2.38GHz ~ 2.5GHz)

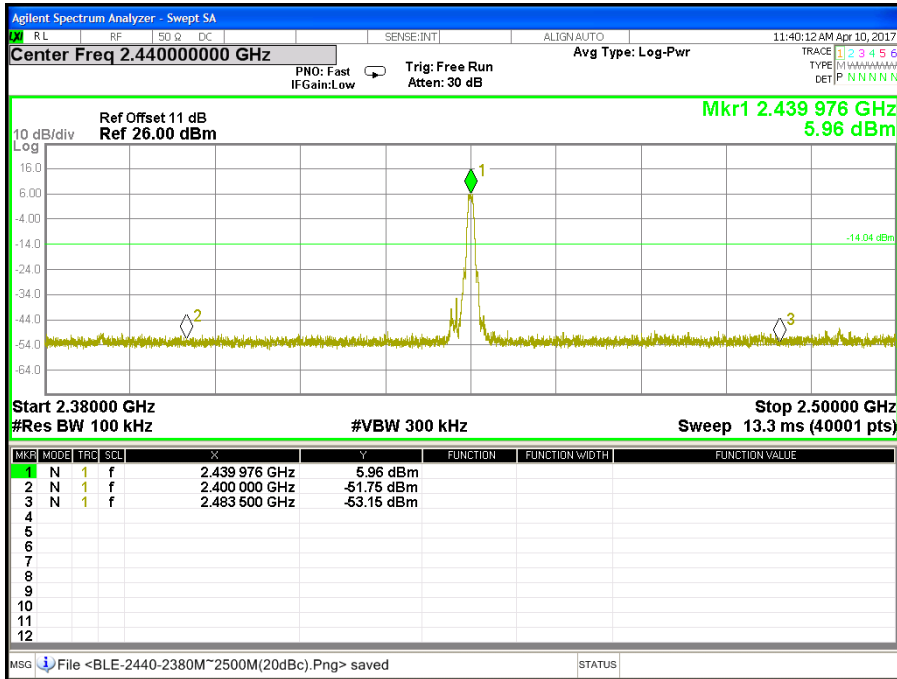

CH Middle (30MHz ~ 26.5GHz)

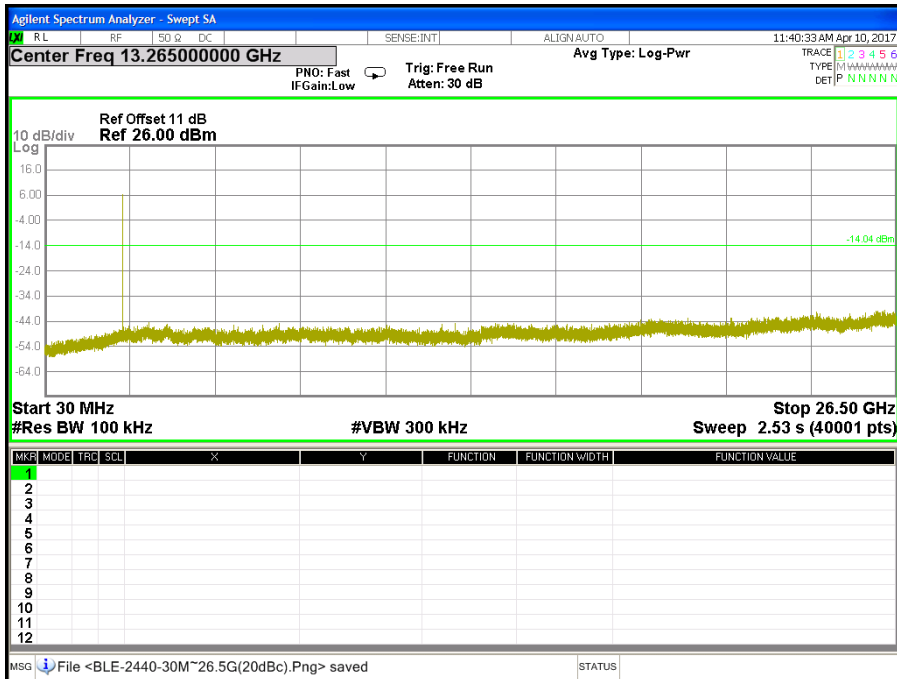

CH High (2.38GHz ~ 2.5GHz)

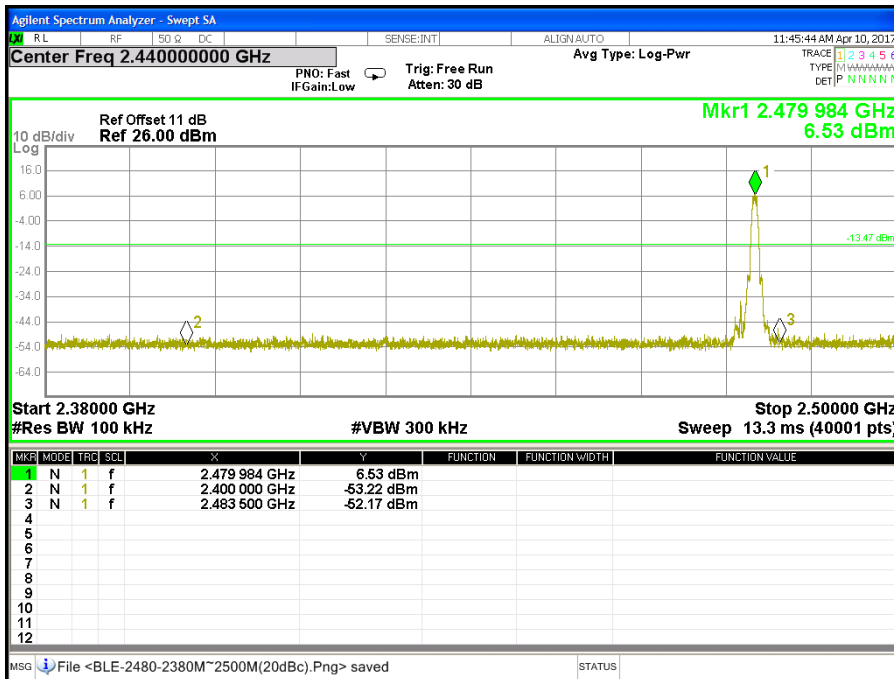

CH High (30MHz ~ 26.5GHz)

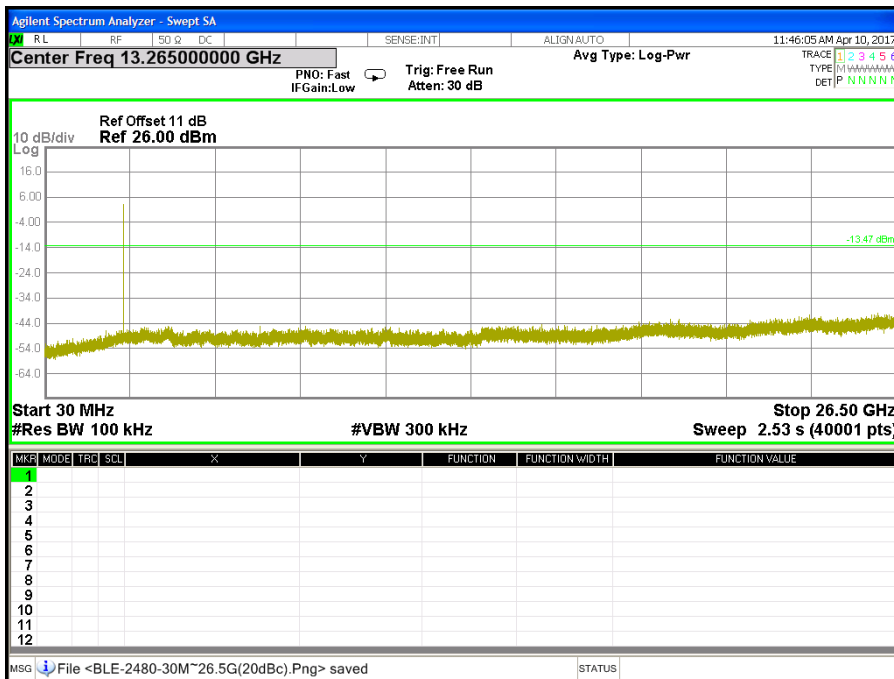

7.7 RADIATED EMISSION

LIMITS

- (1) According to § 15.205 (a) Except as shown in paragraph (d) of this section, only spurious emissions are permitted in any of the frequency bands listed below:

MHz	MHz	MHz	GHz
0.090 - 0.110	16.42 - 16.423	399.9 - 410	4.5 - 5.15
¹ 0.495 - 0.505	16.69475 - 16.69525	608 - 614	5.35 - 5.46
2.1735 - 2.1905	16.80425 - 16.80475	960 - 1240	7.25 - 7.75
4.125 - 4.128	25.5 - 25.67	1300 - 1427	8.025 - 8.5
4.17725 - 4.17775	37.5 - 38.25	1435 - 1626.5	9.0 - 9.2
4.20725 - 4.20775	73 - 74.6	1645.5 - 1646.5	9.3 - 9.5
6.215 - 6.218	74.8 - 75.2	1660 - 1710	10.6 - 12.7
6.26775 - 6.26825	108 - 121.94	1718.8 - 1722.2	13.25 - 13.4
6.31175 - 6.31225	123 - 138	2200 - 2300	14.47 - 14.5
8.291 - 8.294	149.9 - 150.05	2310 - 2390	15.35 - 16.2
8.362 - 8.366	156.52475 - 156.52525	2483.5 - 2500	17.7 - 21.4
8.37625 - 8.38675	156.7 - 156.9	2655 - 2900	22.01 - 23.12
8.41425 - 8.41475	162.0125 - 167.17	3260 - 3267	23.6 - 24.0
12.29 - 12.293	167.72 - 173.2	3332 - 3339	31.2 - 31.8
12.51975 - 12.52025	240 - 285	3345.8 - 3338	36.43 - 36.5
12.57675 - 12.57725	322 - 335.4	3600 - 4400	(²)
13.36 - 13.41			

Remark:

1. ¹ Until February 1, 1999, this restricted band shall be 0.490-0.510 MHz.
2. ² Above 38.6

- (2) According to § 15.205 (b) Except as provided in paragraphs (d) and (e), the field strength of emissions appearing within these frequency bands shall not exceed the limits shown in Section 15.209. At frequencies equal to or less than 1000 MHz, compliance with the limits in Section 15.209 shall be demonstrated using measurement instrumentation employing a CISPR quasi-peak detector. Above 1000 MHz, compliance with the emission limits in Section 15.209 shall be demonstrated based on the average value of the measured emissions. The provisions in Section 15.35 apply to these measurements.

- (3) According to § 15.209 (a) Except as provided elsewhere in this Subpart, the emissions from an intentional radiator shall not exceed the field strength levels specified in the following table:

Frequency (MHz)	Field Strength (microvolts/meter)	Measurement Distance (meters)
0.009 – 0.490	2400/F(KHz)	300
0.490 – 1.705	24000/F(KHz)	30
1.705 – 30.0	30	30
30 - 88	100 **	3
88 - 216	150 **	3
216 - 960	200 **	3
Above 960	500	3

Remark: **Except as provided in paragraph (g), fundamental emissions from intentional radiators operating under this Section shall not be located in the frequency bands 54-72 MHz, 76-88 MHz, 174-216 MHz or 470-806 MHz. However, operation within these frequency bands is permitted under other sections of this Part, e.g., Sections 15.231 and 15.241.

- (4) According to § 15.209 (b) In the emission table above, the tighter limit applies at the band edges.

TEST EQUIPMENT

Radiated Emission / 966Chamber B

Name of Equipment	Manufacture	Model	Serial Number	Calibration Due
Spectrum Analyzer	Agilent	E4446A	MY46180323	03/16/2018
EMI Test Receiver	Rohde & Schwarz	ESCI	100221	04/26/2017
Bi-log Antenna	TESEQ	CBL 6112D	35403	07/02/2017
Broad-Band Horn Antenna	Schwarzbeck	BBHA 9120 D	9120D-778	07/14/2017
Double-Ridged Waveguide Horn	ETS-LINDGREN	3117	00078733	11/16/2017
Horn Antenna	COM-POWER	AH-840	03077	12/01/2017
Pre-Amplifier	Agilent	8447D	2944A10052	07/12/2017
Pre-Amplifier	Agilent	8449B	3008A01916	07/12/2017
LOOP Antenna	COM-POWER	AL-130	121060	05/23/2017
Test S/W	E3.815206a			

Remark: Each piece of equipment is scheduled for calibration once a year.

TEST SETUP

The diagram below shows the test setup that is utilized to make the measurements for emission below 1GHz.

9kHz ~ 30MHz

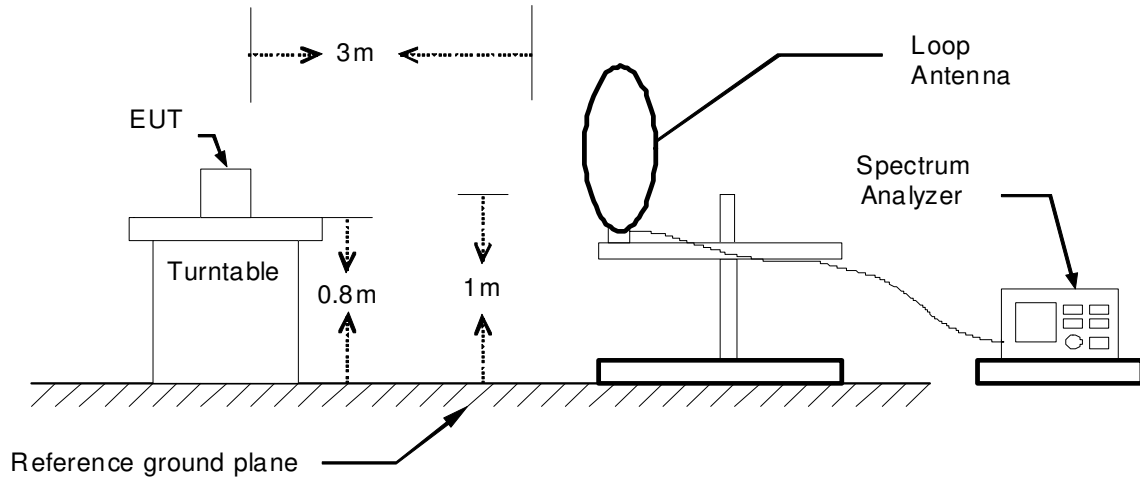

30MHz ~ 1GHz

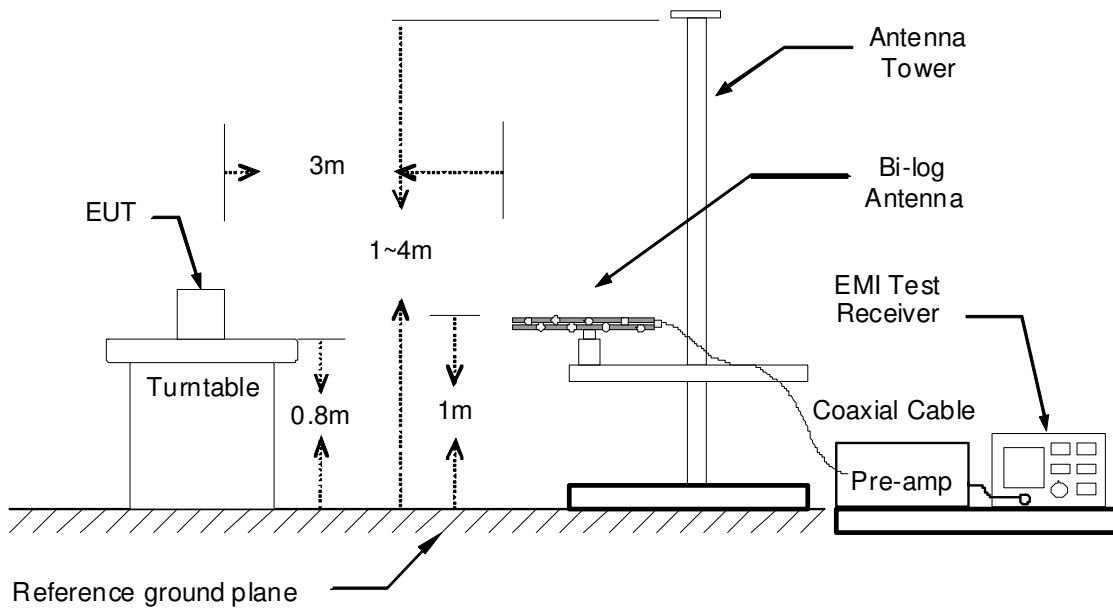

The diagram below shows the test setup that is utilized to make the measurements for emission above 1GHz.

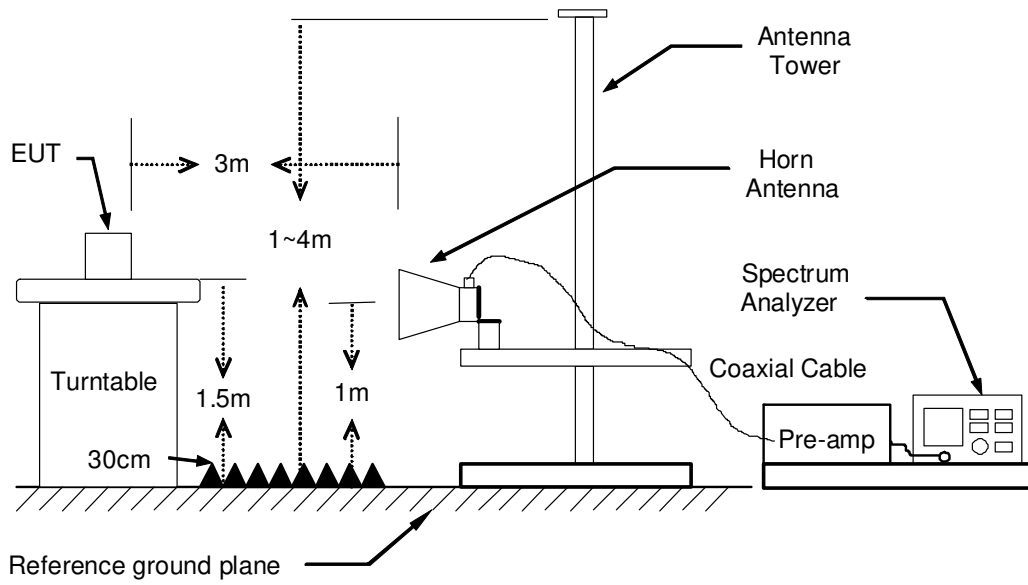

TEST PROCEDURE

1. The EUT was placed on the top of a rotating table 0.8 and 1.5 meters above the ground. The table was rotated 360 degrees to determine the position of the highest radiation.
2. While measuring the radiated emission below 1GHz, the EUT was set 3 meters away from the interference-receiving antenna, which was mounted on the top of a variable-height antenna tower. While measuring the radiated emission above 1GHz, the EUT was set 3 meters away from the interference-receiving antenna.
3. The antenna is a broadband antenna, and its height is varied from one meter to four meters above the ground to determine the maximum value of the field strength. Both horizontal and vertical polarization of the antenna are set to make the measurement.
4. For each suspected emission, the EUT was arranged to its worst case and then the antenna was tuned to heights from 1 meter to 4 meters and the table was turned from 0 degrees to 360 degrees to find the maximum reading.
5. The test-receiver system was set to Peak Detect Function and Specified Bandwidth with Maximum Hold mode.
6. If the emission level of the EUT in peak mode was 10 dB lower than the limit specified, then testing could be stopped and the peak values of the EUT would be reported. Otherwise the emissions that did not have 10 dB margin would be re-tested one by one using peak, quasi-peak or average method as specified and then reported in a data sheet.

Remark:

1. *The resolution bandwidth and video bandwidth of test receiver/spectrum analyzer is 120 KHz for Peak detection (PK) and Quasi-peak detection (QP) at frequency below 1GHz.*
2. *The resolution bandwidth and video bandwidth of test receiver/spectrum analyzer is 1 MHz for Peak detection and frequency above 1GHz.*
3. *The resolution bandwidth of test receiver/spectrum analyzer is 1 MHz and the video bandwidth is 10 Hz for Average detection (AV) at frequency above 1GHz.*

TEST RESULTS

Below 1 GHz (9kHz ~ 30MHz)

No emission found between lowest internal used/generated frequency to 30MHz.

Below 1 GHz (30MHz ~ 1GHz)

Product Name	Bluetooth Amplifier	Test By	Rex Chiu
Test Model	BSS-005	Test Date	2017/04/05
Test Mode	Mode 1	Temp. & Humidity	25°C, 50%

966Chamber_B at 3Meter / Horizontal

Freq. MHz	Reading dBuV	C.F. dB/m	Result dBuV/m	Limit dBuV/m	Margin dB	Azimuth deg	Height cm	Remark
98.87	44.04	-12.42	31.62	43.50	-11.88	165	200	Peak
165.80	47.64	-12.80	34.84	43.50	-8.66	84	200	Peak
365.62	48.77	-6.91	41.86	46.00	-4.14	235	100	Peak
432.55	46.50	-5.51	40.99	46.00	-5.01	124	200	Peak
499.48	46.90	-4.72	42.18	46.00	-3.82	298	200	QP
632.37	46.40	-3.03	43.37	46.00	-2.63	224	100	QP
765.26	42.78	-1.75	41.03	46.00	-4.97	253	100	Peak

966Chamber_B at 3Meter / Vertical

Freq. MHz	Reading dBuV	C.F. dB/m	Result dBuV/m	Limit dBuV/m	Margin dB	Azimuth deg	Height cm	Remark
47.46	52.90	-14.31	38.59	40.00	-1.41	333	100	QP
65.89	51.70	-17.11	34.59	40.00	-5.41	161	100	QP
165.80	50.33	-12.80	37.53	43.50	-5.97	250	100	Peak
365.62	49.80	-6.91	42.89	46.00	-3.11	110	100	QP
432.55	49.90	-5.51	44.39	46.00	-1.61	201	100	QP
480.08	47.61	-4.86	42.75	46.00	-3.25	184	100	Peak
499.48	46.90	-4.72	42.18	46.00	-3.82	167	100	QP
865.17	42.19	-0.52	41.67	46.00	-4.33	272	100	Peak
998.06	42.50	1.55	44.05	54.00	-9.95	129	100	Peak

Remark:

1. Quasi-peak test would be performed if the peak result were greater than the quasi-peak limit.
2. Correction Factor (dB/m) = Antenna Factor (dB/m) + Cable Loss (dB) – PreAmp.Gain (dB)
3. Result (dBuV/m) = Reading (dBuV) + Correction Factor (dB/m)
4. Margin (dB) = Remark result (dBuV/m) - Quasi-peak limit (dBuV/m).

Above 1 GHz

Product Name	Bluetooth Amplifier	Test By	Rex Chiu
Test Model	BSS-005	Test Date	2017/04/05
Test Mode	TX / CH Low	Temp. & Humidity	25°C, 50%

966Chamber_B at 3Meter / Horizontal

Freq. MHz	Reading dBuV	C.F. dB/m	Result dBuV/m	Limit dBuV/m	Margin dB	Azimuth deg	Height cm	Remark
1996.00	44.54	-4.22	40.32	74.00	-33.68	128	100	Peak
2558.00	46.56	-2.02	44.54	74.00	-29.46	279	200	Peak
4803.00	48.20	5.19	53.39	54.00	-0.61	70	100	Average
4803.00	50.11	5.19	55.30	74.00	-18.70	70	100	Peak
5976.00	39.22	7.75	46.97	74.00	-27.03	262	100	Peak
7212.00	39.10	12.38	51.48	54.00	-2.52	64	200	Average
7212.00	45.07	12.38	57.45	74.00	-16.55	64	200	Peak
9348.00	38.23	14.11	52.34	74.00	-21.66	302	100	Peak

966Chamber_B at 3Meter / Vertical

Freq. MHz	Reading dBuV	C.F. dB/m	Result dBuV/m	Limit dBuV/m	Margin dB	Azimuth deg	Height cm	Remark
1112.00	51.21	-8.61	42.60	74.00	-31.40	249	200	Peak
1662.00	48.07	-5.47	42.60	74.00	-31.40	45	100	Peak
4803.00	48.56	5.19	53.75	54.00	-0.25	232	100	Average
4803.00	50.49	5.19	55.68	74.00	-18.32	232	100	Peak
5916.00	38.81	7.64	46.45	74.00	-27.55	143	200	Peak
7200.00	40.60	12.37	52.97	54.00	-1.03	233	200	Average
7200.00	46.77	12.37	59.14	74.00	-14.86	233	200	Peak
8664.00	37.81	13.42	51.23	74.00	-22.77	322	100	Peak

Remark:

1. Measuring frequencies from 1 GHz to the 10th harmonic of highest fundamental frequency.
2. Average test would be performed if the peak result were greater than the average limit.
3. Measurements above show only up to 6 maximum emissions noted, or would be lesser, with " N/A " remark, if no specific emissions from the EUT are recorded (ie: margin>20dB from the applicable limit) and considered that's already beyond the background noise floor.
4. Result = Reading + Correction Factor
 Margin = Result - Limit
 Remark Peak = Result(PK) - Limit(PK)
 Remark AVG = Result(AV) - Limit(AV)

Product Name	Bluetooth Amplifier	Test By	Rex Chiu
Test Model	BSS-005	Test Date	2017/04/05
Test Mode	TX / CH Middle	Temp. & Humidity	25°C, 50%

966Chamber_B at 3Meter / Horizontal

Freq. MHz	Reading dBuV	C.F. dB/m	Result dBuV/m	Limit dBuV/m	Margin dB	Azimuth deg	Height cm	Remark
1166.00	56.19	-8.25	47.94	74.00	-26.06	343	200	Peak
2596.00	45.66	-1.91	43.75	74.00	-30.25	259	200	Peak
4881.00	42.29	5.39	47.68	74.00	-26.32	217	200	Peak
5661.00	39.05	7.14	46.19	74.00	-27.81	67	200	Peak
7320.00	40.90	12.44	53.34	54.00	-0.66	60	200	Average
7320.00	47.28	12.44	59.72	74.00	-14.28	60	200	Peak
9252.00	37.53	14.00	51.53	74.00	-22.47	238	100	Peak

966Chamber_B at 3Meter / Vertical

Freq. MHz	Reading dBuV	C.F. dB/m	Result dBuV/m	Limit dBuV/m	Margin dB	Azimuth deg	Height cm	Remark
1032.00	51.78	-9.13	42.65	74.00	-31.35	95	100	Peak
1496.00	48.65	-6.10	42.55	74.00	-31.45	84	100	Peak
4881.00	43.13	5.39	48.52	74.00	-25.48	57	200	Peak
5553.00	39.56	6.93	46.49	74.00	-27.51	279	100	Peak
7320.00	41.20	12.44	53.64	54.00	-0.36	301	200	Average
7320.00	48.46	12.44	60.90	74.00	-13.10	301	200	Peak
9204.00	37.16	13.95	51.11	74.00	-22.89	338	200	Peak

Remark:

1. Measuring frequencies from 1 GHz to the 10th harmonic of highest fundamental frequency.
2. Average test would be performed if the peak result were greater than the average limit.
3. Measurements above show only up to 6 maximum emissions noted, or would be lesser, with " N/A " remark, if no specific emissions from the EUT are recorded (ie: margin>20dB from the applicable limit) and considered that's already beyond the background noise floor.
4. Result = Reading + Correction Factor
 Margin = Result – Limit
 Remark Peak = Result(PK) – Limit(PK)
 Remark AVG = Result(AV) – Limit(AV)

Product Name	Bluetooth Amplifier	Test By	Rex Chiu
Test Model	BSS-005	Test Date	2017/04/05
Test Mode	TX / CH High	Temp. & Humidity	25°C, 50%

966Chamber_B at 3Meter / Horizontal

Freq. MHz	Reading dBuV	C.F. dB/m	Result dBuV/m	Limit dBuV/m	Margin dB	Azimuth deg	Height cm	Remark
1920.00	46.46	-4.51	41.95	74.00	-32.05	127	100	Peak
2376.00	43.47	-2.69	40.78	74.00	-33.22	262	100	Peak
4959.00	46.02	5.59	51.61	74.00	-22.39	333	200	Peak
5508.00	39.81	6.85	46.66	74.00	-27.34	137	100	Peak
7440.00	39.30	12.52	51.82	54.00	-2.18	359	200	Average
7440.00	45.62	12.52	58.14	74.00	-15.86	359	200	Peak
10080.00	36.82	15.38	52.20	74.00	-21.80	54	200	Peak

966Chamber_B at 3Meter / Vertical

Freq. MHz	Reading dBuV	C.F. dB/m	Result dBuV/m	Limit dBuV/m	Margin dB	Azimuth deg	Height cm	Remark
1032.00	50.29	-9.13	41.16	74.00	-32.84	263	100	Peak
1662.00	47.00	-5.47	41.53	74.00	-32.47	97	100	Peak
4959.00	47.20	5.59	52.79	54.00	-1.21	72	100	Average
4959.00	49.15	5.59	54.74	74.00	-19.26	72	100	Peak
5961.00	39.58	7.72	47.30	74.00	-26.70	302	100	Peak
7440.00	41.10	12.52	53.62	54.00	-0.38	226	200	Average
7440.00	47.03	12.52	59.55	74.00	-14.45	226	200	Peak
9216.00	37.71	13.96	51.67	74.00	-22.33	0	100	Peak

Remark:

1. Measuring frequencies from 1 GHz to the 10th harmonic of highest fundamental frequency.
2. Average test would be performed if the peak result were greater than the average limit.
3. Measurements above show only up to 6 maximum emissions noted, or would be lesser, with " N/A " remark, if no specific emissions from the EUT are recorded (ie: margin>20dB from the applicable limit) and considered that's already beyond the background noise floor.
4. Result = Reading + Correction Factor
 Margin = Result – Limit
 Remark Peak = Result(PK) – Limit(PK)
 Remark AVG = Result(AV) – Limit(AV)

Restricted Band Edges

Detector Mode: Peak

Polarity: Horizontal

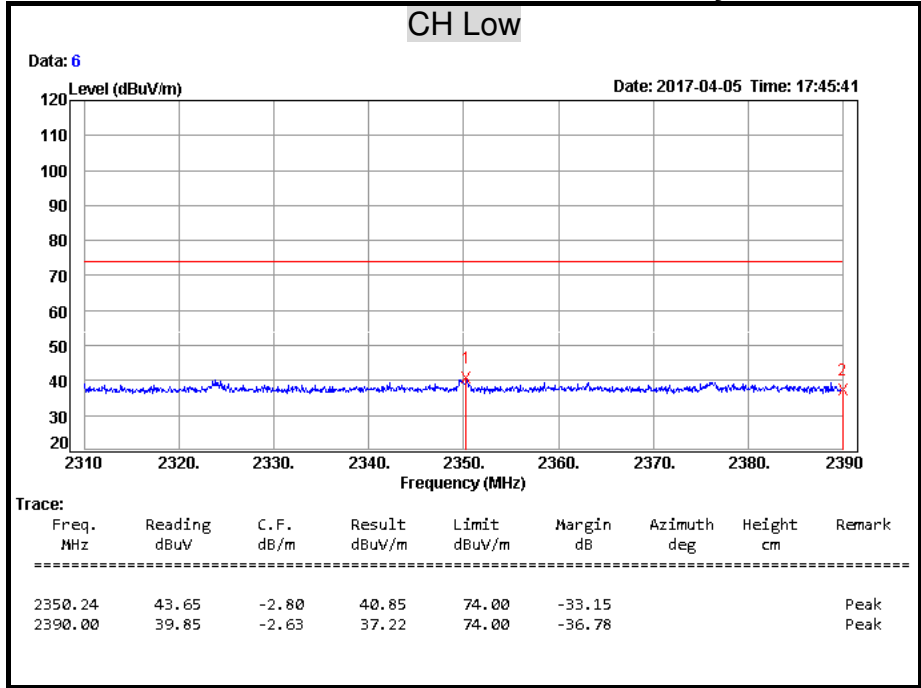

Remark: Result = Reading + Correction Factor
 Margin = Result – Limit
 Remark Peak = Result(PK) – Limit(PK)

Detector Mode: Average

Polarity: Horizontal

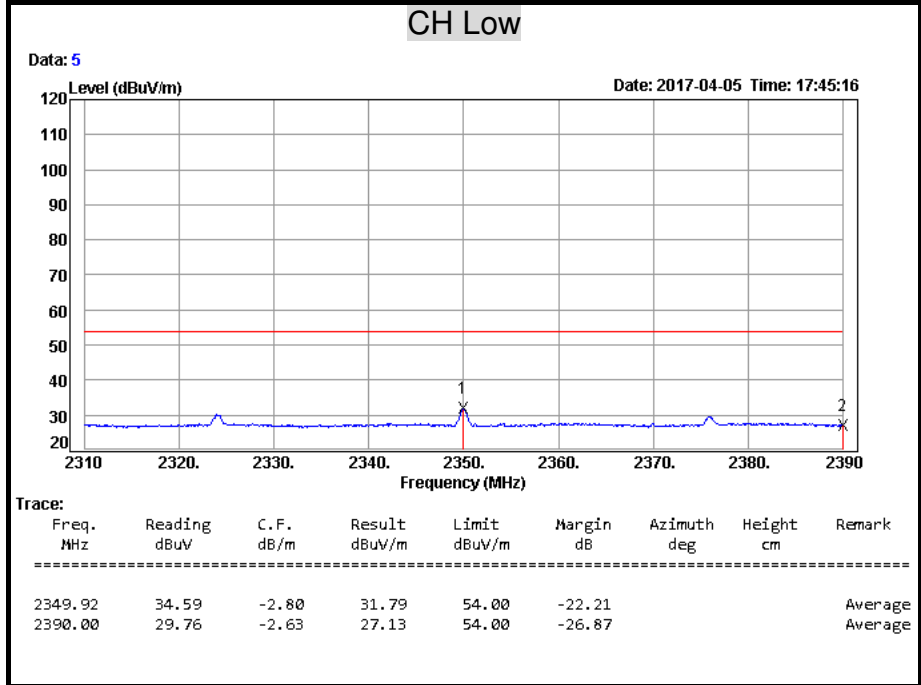

Remark: Result = Reading + Correction Factor
 Margin = Result – Limit
 Remark AVG = Result(AV) – Limit(AV)

Detector Mode: Peak

Polarity: Vertical

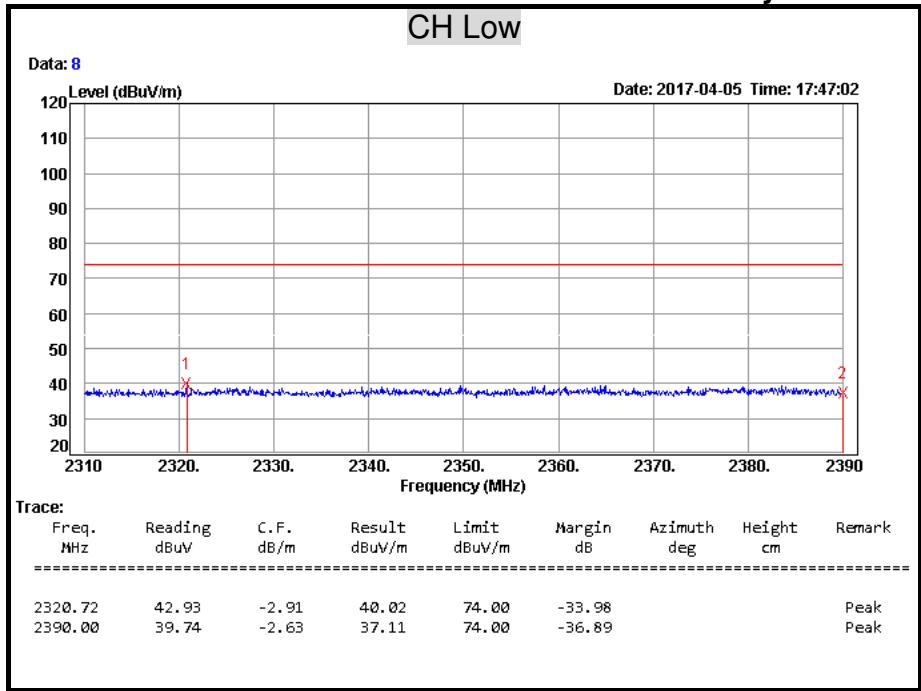

Remark: $Result = Reading + Correction\ Factor$
 $Margin = Result - Limit$
 $Remark\ Peak = Result(PK) - Limit(PK)$

Detector Mode: Average

Polarity: Vertical

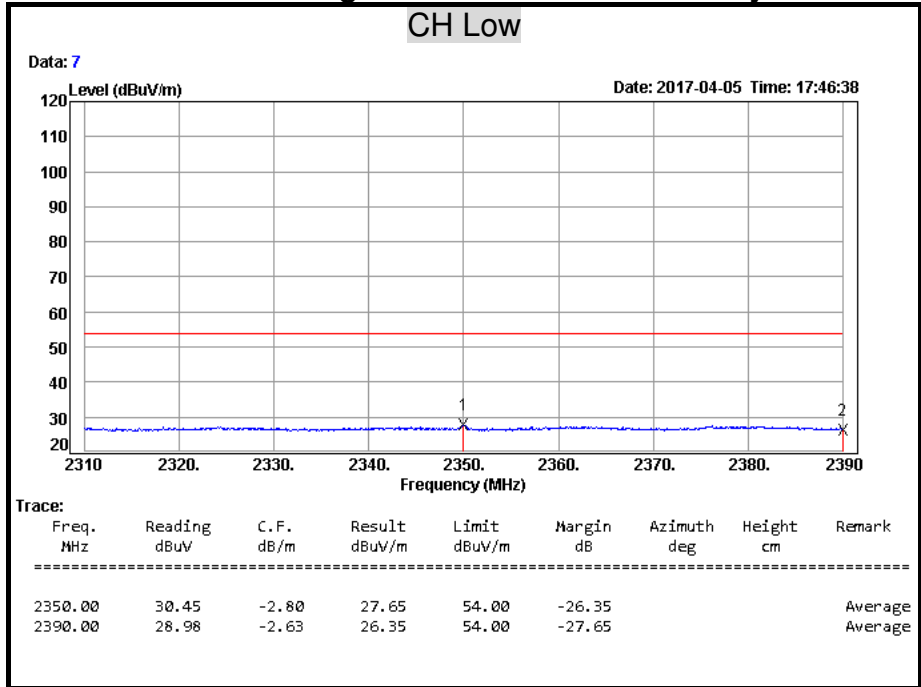

Remark: $Result = Reading + Correction\ Factor$
 $Margin = Result - Limit$
 $Remark\ AVG = Result(AV) - Limit(AV)$

Detector Mode: Peak

Polarity: Horizontal

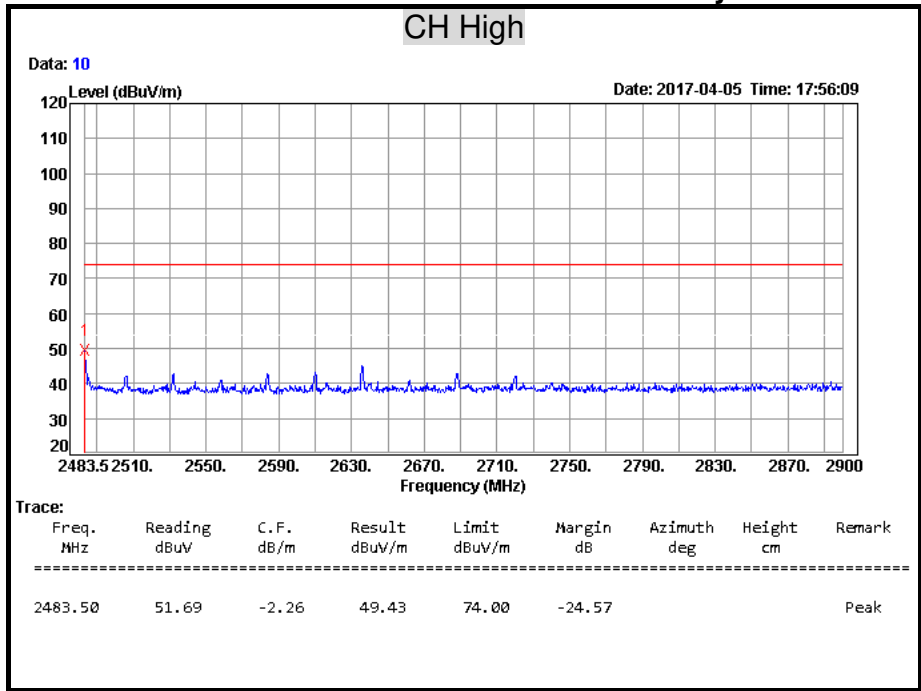

Remark: $Result = Reading + Correction\ Factor$
 $Margin = Result - Limit$
 $Remark\ Peak = Result(PK) - Limit(PK)$

Detector Mode: Average

Polarity: Horizontal

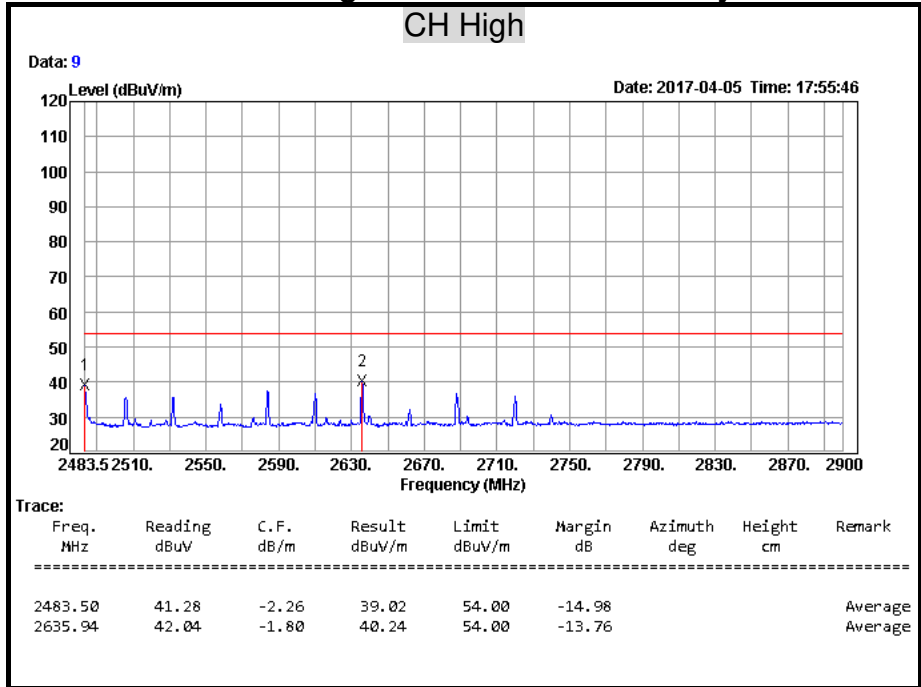

Remark: $Result = Reading + Correction\ Factor$
 $Margin = Result - Limit$
 $Remark\ AVG = Result(AV) - Limit(AV)$

Detector Mode: Peak

Polarity: Vertical

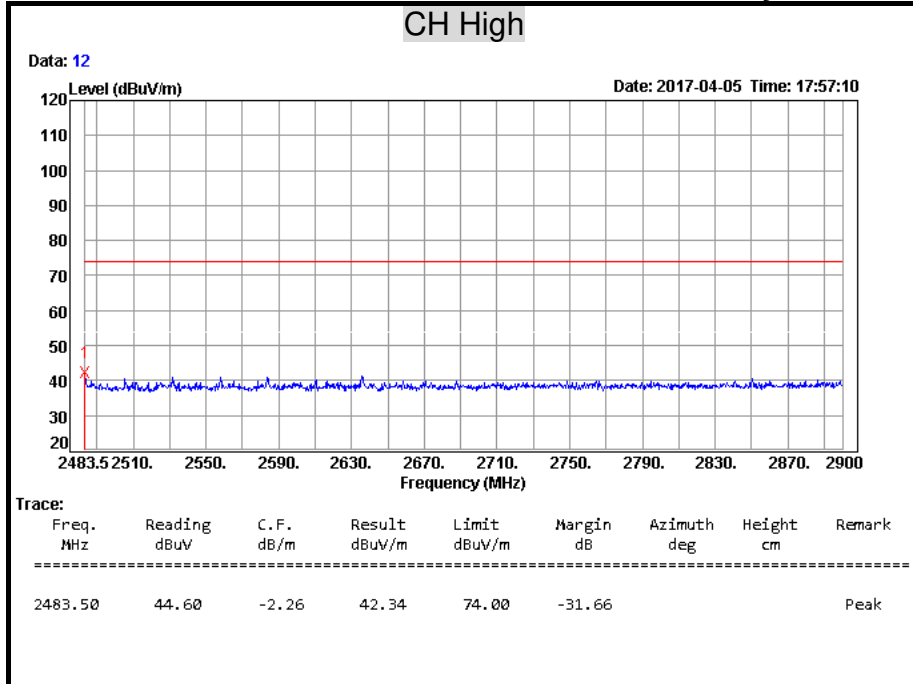

Remark: $Result = Reading + Correction\ Factor$
 $Margin = Result - Limit$
 $Remark\ Peak = Result(PK) - Limit(PK)$

Detector Mode: Average

Polarity: Vertical

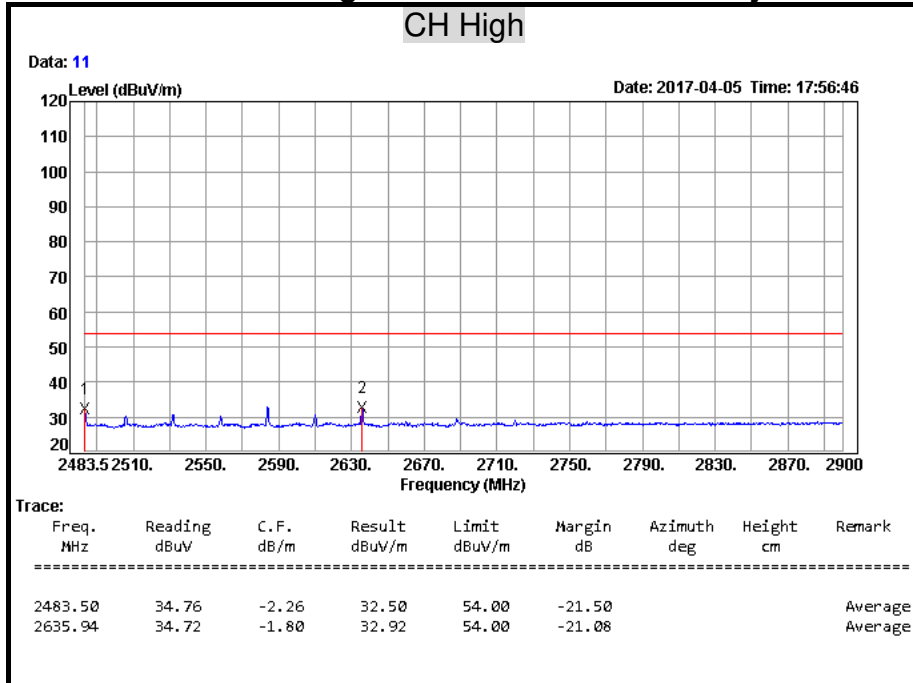

Remark: $Result = Reading + Correction\ Factor$
 $Margin = Result - Limit$
 $Remark\ AVG = Result(AV) - Limit(AV)$

7.8 CONDUCTED EMISSION

LIMITS

§ 15.207 (a) Except as shown in paragraph (b) and (c) this section, for an intentional radiator that is designed to be connected to the public utility (AC) power line, the radio frequency voltage that is conducted back onto the AC power line on any frequency or frequencies within the band 150 kHz to 30 MHz shall not exceed the limits in the following table, as measured using a 50 μ H/50 ohms line impedance stabilization network (LISN). Compliance with the provisions of this paragraph shall be based on the measurement of the radio frequency voltage between each power line and ground at the power terminal. The lower limit applies at the boundary between the frequency ranges.

Frequency Range (MHz)	Conducted Limit (dB μ v)	
	Quasi-peak	Average
0.15 - 0.50	66 to 56	56 to 46
0.50 - 5.00	56	46
5.00 - 30.0	60	50

TEST EQUIPMENT

Name of Equipment	Manufacturer	Model	Serial Number	Calibration Due
L.I.S.N	Schwarzbeck	NSLK 8127	8127465	07/28/2017
L.I.S.N	Schwarzbeck	NSLK 8127	8127473	03/12/2018
EMI Test Receiver	Rohde & Schwarz	ESHS 30	838550/003	10/25/2017
Pulse Limiter	Rohde & Schwarz	ESH3-Z2	100111	06/27/2017
Test S/W	E3.815206a			

Remark: Each piece of equipment is scheduled for calibration once a year.

TEST SETUP

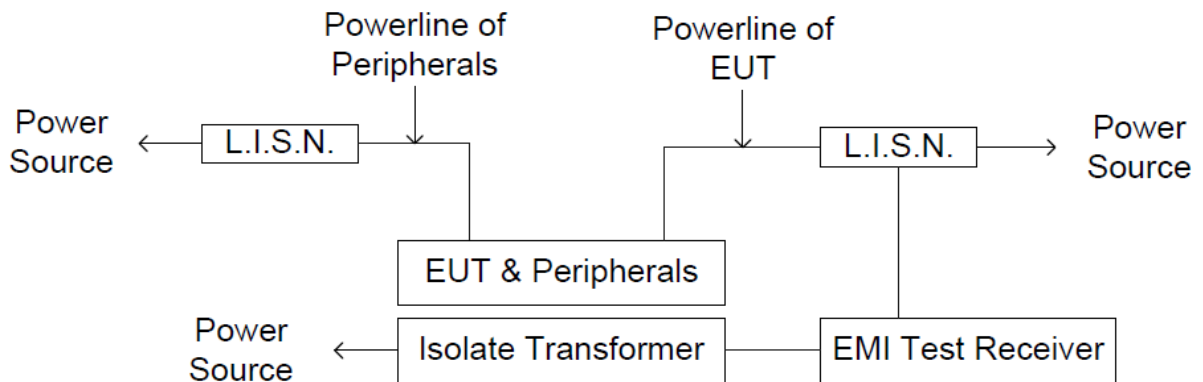
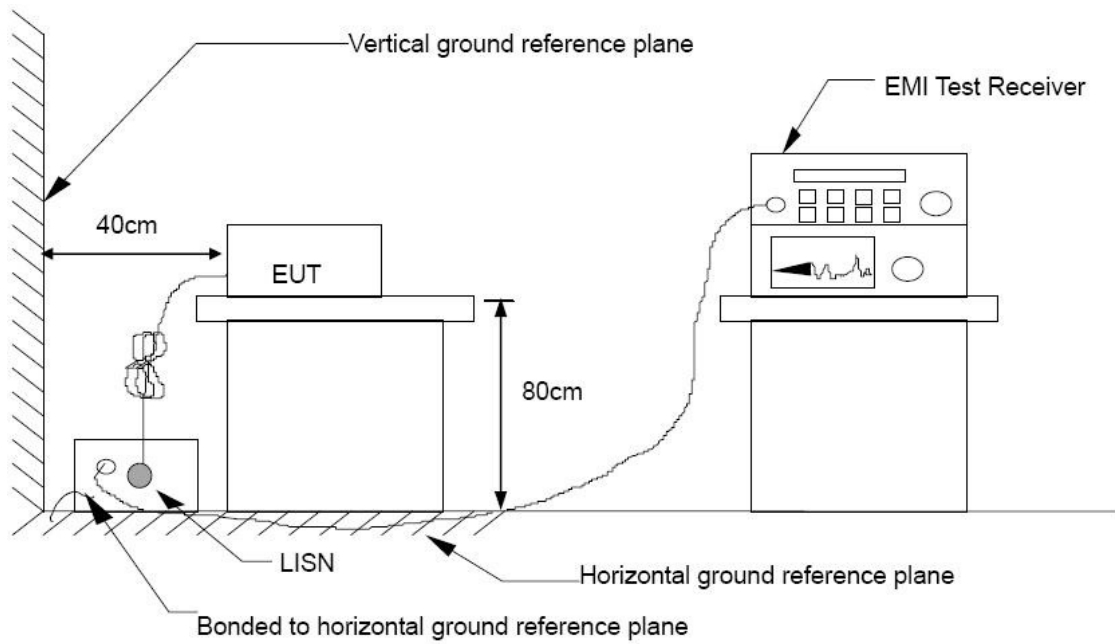

TEST PROCEDURE

The basic test procedure was in accordance with ANSI C63.10:2013.

The test procedure is performed in a 4m × 3m × 2.4m (L×W×H) shielded room.

The EUT along with its peripherals were placed on a 1.0m (W) × 1.5m (L) and 0.8m in height wooden table and the EUT was adjusted to maintain a 0.4 meter space from a vertical reference plane.

The EUT was connected to power mains through a line impedance stabilization network (LISN) which provides 50 ohm coupling impedance for measuring instrument and the chassis ground was bounded to the horizontal ground plane of shielded room. All peripherals were connected to the second LISN and the chassis ground also bounded to the horizontal ground plane of shielded room.

The EUT was located so that the distance between the boundary of the EUT and the closest surface of the LISN is 0.8 m. Where a mains flexible cord was provided by the manufacturer shall be 1 m long, or if in excess of 1 m, the excess cable was folded back and forth as far as possible so as to form a bundle not exceeding 0.4 m in length.

TEST RESULTS

Product Name	Bluetooth Amplifier	Test By	Waternil Guan
Test Model	BSS-005	Test Date	2017/04/06
Test Mode	Mode 2	Temp. & Humidity	25°C, 59%

LINE

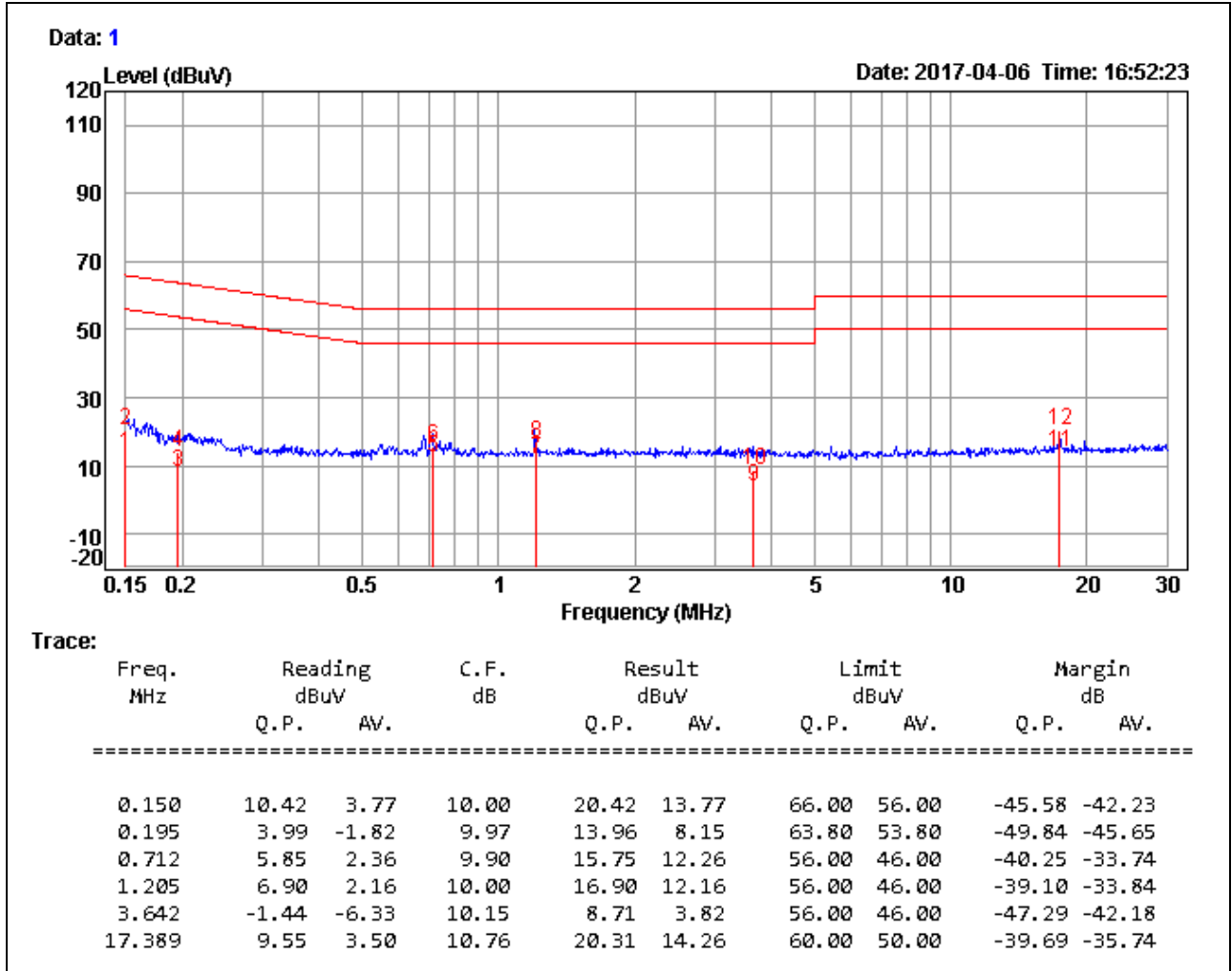

Remark:

1. Correction Factor = Insertion loss + Cable loss
2. Result level = Reading Value + Correction factor
3. Margin value = Result level – Limit value

Product Name	Bluetooth Amplifier	Test By	Waternil Guan
Test Model	BSS-005	Test Date	2017/04/06
Test Mode	Mode 2	Temp. & Humidity	25°C, 59%

NEUTRAL

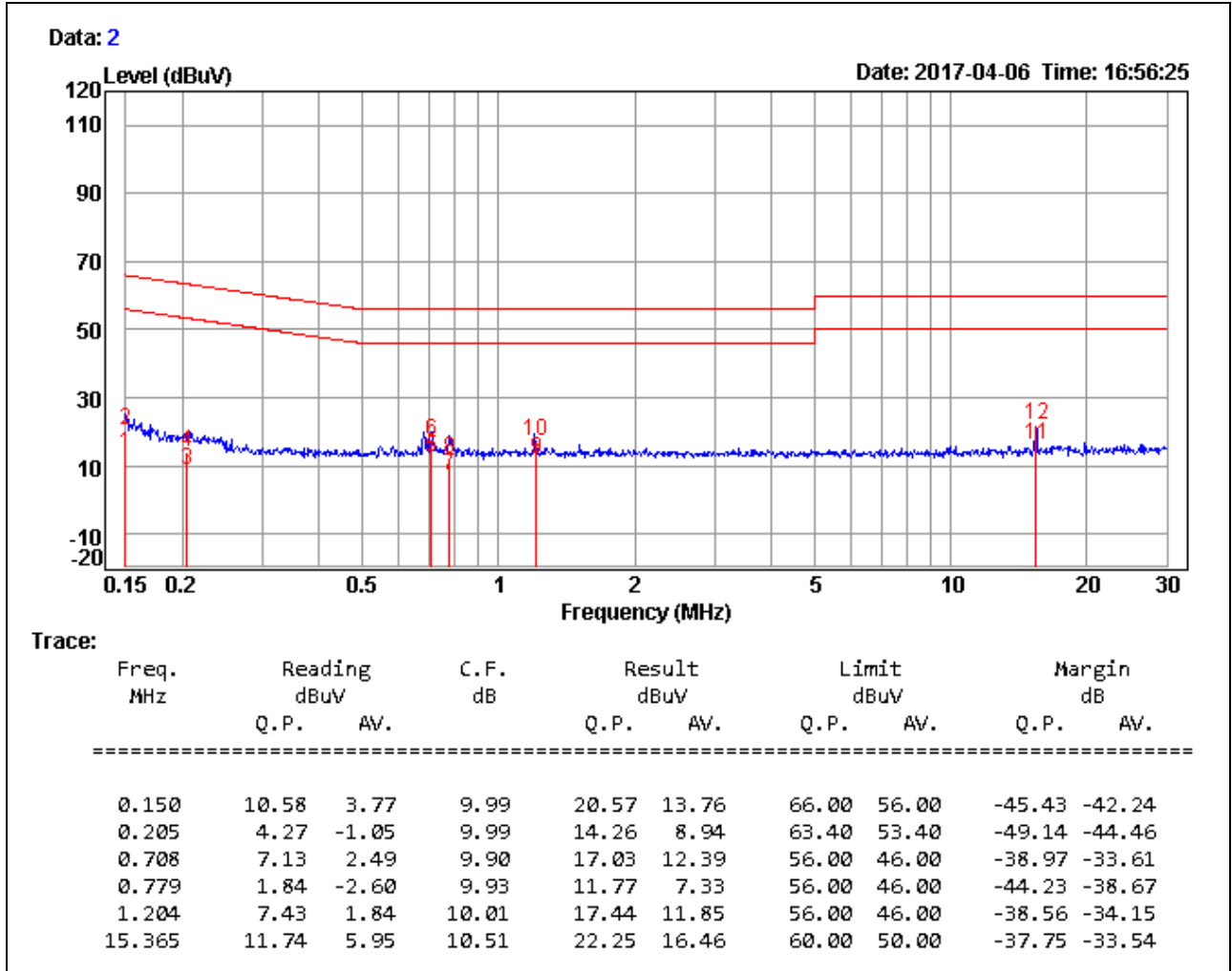

Remark:

1. Correction Factor = Insertion loss + Cable loss
2. Result level = Reading Value + Correction factor
3. Margin value = Result level – Limit value