

Thank you for choosing KitchenAid® Appliances.

We hold our company to highest quality standards and it is important to us that you have a positive experience owning a KitchenAid® product.

Register your microwave oven at www.kitchenaid.com/owners.

For future reference, please make a note of your model and serial number located on the front facing of the microwave oven opening, behind the door.

Model Number _____ Serial Number _____

Para una versión de estas instrucciones en español, visite www.kitchenaid.com/owners

MICROWAVE HOOD COMBINATION SAFETY

Your safety and the safety of others are very important.

We have provided many important safety messages in this manual and on your appliance. Always read and obey all safety messages.



This is the safety alert symbol.

This symbol alerts you to potential hazards that can kill or hurt you and others.

All safety messages will follow the safety alert symbol and either the word "DANGER" or "WARNING."

These words mean:

⚠ DANGER

You can be killed or seriously injured if you don't immediately follow instructions.

⚠ WARNING

You can be killed or seriously injured if you don't follow instructions.

All safety messages will tell you what the potential hazard is, tell you how to reduce the chance of injury, and tell you what can happen if the instructions are not followed.

IMPORTANT SAFETY INSTRUCTIONS

When using electrical appliances basic safety precautions should be followed, including the following:

WARNING: To reduce the risk of burns, electric shock, fire, injury to persons, or exposure to excessive microwave energy:

- Read all instructions before using the microwave oven.
- Read and follow the specific "PRECAUTIONS TO AVOID POSSIBLE EXPOSURE TO EXCESSIVE MICROWAVE ENERGY" found in this section.
- The microwave oven must be grounded. Connect only to properly grounded outlet. See "GROUNDING INSTRUCTIONS" found in this section and in the provided Installation Instructions.
- Install or locate the microwave oven only in accordance with the provided Installation Instructions.
- Some products such as whole eggs in the shell and sealed containers - for example, closed glass jars - are able to explode and should not be heated in the microwave oven.

SAVE THESE INSTRUCTIONS



W11236924A

IMPORTANT SAFETY INSTRUCTIONS

- Use the microwave oven only for its intended use as described in the manual. Do not use corrosive chemicals or vapors in the microwave oven. This type of oven is specifically designed to heat, cook, or dry food. It is not designed for industrial or laboratory use.
- As with any appliance, close supervision is necessary when used by children.
- Do not operate the microwave oven if it has a damaged cord or plug, if it is not working properly, or if it has been damaged or dropped.
- The microwave oven should be serviced only by qualified service personnel. Call an authorized service company for examination, repair, or adjustment.
- Do not cover or block any openings on the microwave oven.
- Do not store this microwave oven outdoors. Do not use the microwave oven near water - for example, near a kitchen sink, in a wet basement, near a swimming pool, or similar locations.
- Do not immerse cord or plug in water.
- Keep cord away from heated surfaces.
- Do not let cord hang over edge of table or counter.
- See door surface cleaning instructions in the "Microwave Oven Care" section.
- To reduce the risk of fire in the oven cavity:
 - Do not overcook food. Carefully attend the microwave oven when paper, plastic, or other combustible materials are placed inside the oven to facilitate cooking.
 - Remove wire twist-ties from paper or plastic bags before placing bags in oven.
 - If materials inside the oven ignite, keep oven door closed, turn oven off, and disconnect the power cord, or shut off power at the fuse or circuit breaker panel.
 - Do not use the cavity for storage purposes. Do not leave paper products, cooking utensils, or food in the cavity when not in use.
- Liquids, such as water, coffee, or tea are able to be overheated beyond the boiling point without appearing to be boiling. Visible bubbling or boiling when the container is removed from the microwave oven is not always present. **THIS COULD RESULT IN VERY HOT LIQUIDS SUDDENLY BOILING OVER WHEN THE CONTAINER IS DISTURBED OR A SPOON OR OTHER UTENSIL IS INSERTED INTO THE LIQUID.**
 - To reduce the risk of injury to persons:
 - Do not overheat the liquid.
 - Stir the liquid both before and halfway through heating it.
 - Do not use straight-sided containers with narrow necks.
 - After heating, allow the container to stand in the microwave oven for a short time before removing the container.
 - Use extreme care when inserting a spoon or other utensil into the container.
- Do not mount over a sink.
- Do not store anything directly on top of the microwave oven when the microwave oven is in operation.
- Clean Ventilating Hoods Frequently - Grease should not be allowed to accumulate on hood or filter.
- When flambing foods under the hood, turn the fan on.
- Suitable for use above both gas and electric cooking equipment.
- Intended to be used above ranges with maximum width of 36" (91.44 cm).
- Use care when cleaning the vent-hood filter. Corrosive cleaning agents, such as lye-based oven cleaners, may damage the filter.

SAVE THESE INSTRUCTIONS

PRECAUTIONS TO AVOID POSSIBLE EXPOSURE TO EXCESSIVE MICROWAVE ENERGY

- (a) Do not attempt to operate this oven with the door open since open-door operation can result in harmful exposure to microwave energy. It is important not to defeat or tamper with the safety interlocks.
- (b) Do not place any object between the oven front face and the door or allow soil or cleaner residue to accumulate on sealing surfaces.
- (c) Do not operate the oven if it is damaged. It is particularly important that the oven door close properly and that there is no damage to the:
 - (1) Door (bent),
 - (2) Hinges and latches (broken or loosened),
 - (3) Door seals and sealing surfaces.
- (d) The oven should not be adjusted or repaired by anyone except properly qualified service personnel.

State of California Proposition 65 Warnings:

WARNING: This product contains one or more chemicals known to the State of California to cause cancer.

WARNING: This product contains one or more chemicals known to the State of California to cause birth defects or other reproductive harm.

Electrical Requirements

⚠ WARNING



Electrical Shock Hazard

Plug into a grounded 3 prong outlet.

Do not remove ground prong.

Do not use an adapter.

Do not use an extension cord.

Failure to follow these instructions can result in death, fire, or electrical shock.

Observe all governing codes and ordinances.

Required:

- A 120 V, 60 Hz, AC-only, 15 or 20 A electrical supply with a fuse or circuit breaker

Recommended:

- A time-delay fuse or time-delay circuit breaker
- A separate circuit serving only this microwave oven

GROUNDING INSTRUCTIONS

■ For all cord connected appliances:

The microwave oven must be grounded. In the event of an electrical short circuit, grounding reduces the risk of electric shock by providing an escape wire for the electric current. The microwave oven is equipped with a cord having a grounding wire with a grounding plug. The plug must be plugged into an outlet that is properly installed and grounded.

WARNING: Improper use of the grounding plug can result in a risk of electric shock. Consult a qualified electrician or serviceman if the grounding instructions are not completely understood, or if doubt exists as to whether the microwave oven is properly grounded.

Do not use an extension cord. If the power supply cord is too short, have a qualified electrician or serviceman install an outlet near the microwave oven.

SAVE THESE INSTRUCTIONS

This device complies with Part 18 of the FCC Rules.

FEATURES

Feature Guide

This manual covers several models. Your model may have some or all of the items listed. Refer to this manual or the Product Help section of our website at www.whirlpool.com for more detailed instructions.



WARNING





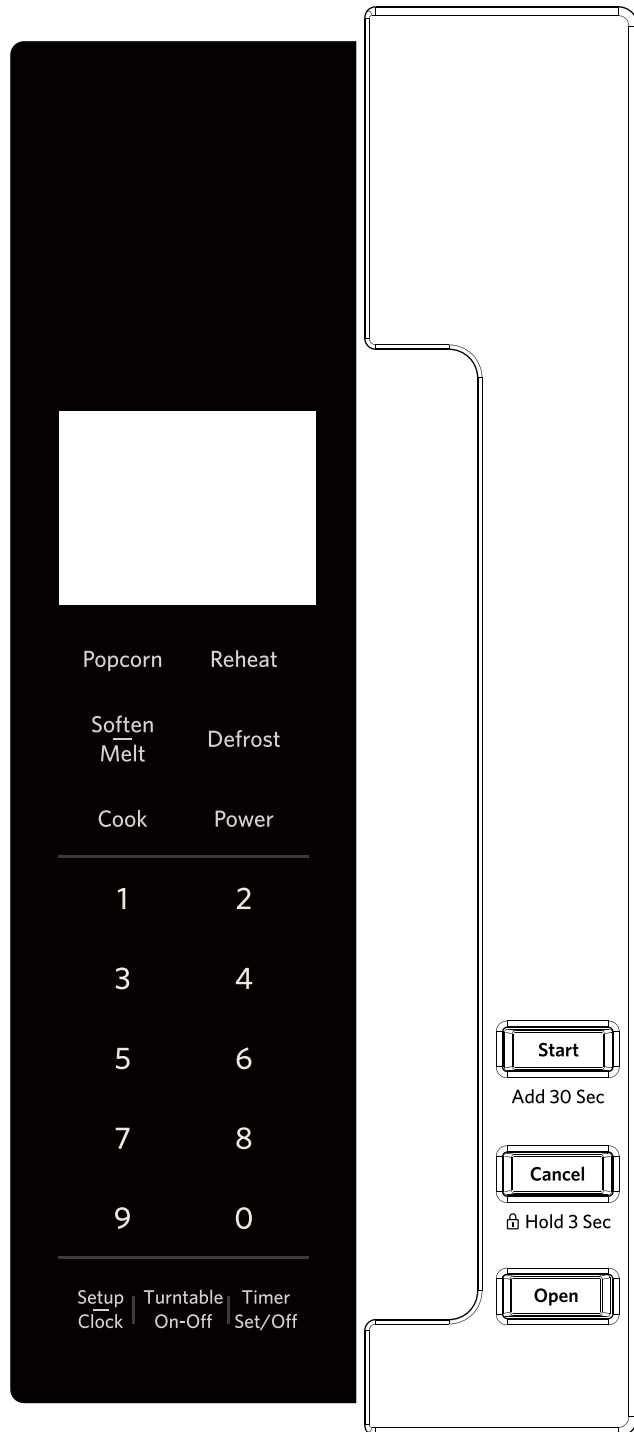

Food Poisoning Hazard

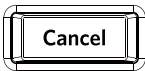
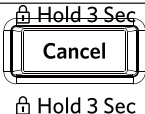
Do not let food sit in oven more than one hour before or after cooking.

Doing so can result in food poisoning or sickness.



Keypad	Feature	Instructions
	Timer Set/Off	Set Kitchen Timer
		<ol style="list-style-type: none"> 1. Touch TIMER keypad. 2. Touch the number keypads to enter time up to 99 minutes and 59 seconds. 3. For example, to set 12 minutes length time, touch TIMER keypad. 4. Use the number keypads to enter 12:00. 5. Touch Start.
 Add 30 Sec	Add 30 Seconds	<p>In Manual cooking, touch the START keypad will start 30 seconds of cook time with full power MW cycle. Duration can be adjusted by pressing START keypad, it adds 30 seconds per each press while the unit is running. Pressing and holding the START keypad, it will add more duration automatically.</p> <p>For example: Add 30 seconds cooking time, press START keypad once. Add 1 minute cooking time, press START keypad twice. Add more duration, press and hold START keypad until your prefer cooking time.</p> <p>Note: User holds the START keypad, the duration can be add up to 10 minutes to the current time countdown. When 10 minutes has been added or the max time has been reached, invalid/retry tone sound and the display shows the final time setting. If you want more duration, you can release the keypad, then press and hold the START keypad again to add up to another 10 minutes.</p>
 Add 30 Sec	Start Function	Press the START keypad to start any cooking functions. If cooking is interrupted by opening the door, touch START after the door is closed again will resume the preset cycle.
 Add 30 Sec	Microwave Oven Cancel	The CANCEL keypad stops any microwave oven function except for the clock and control lock.
 Hold 3 Sec	Activate Control Lock	Activate to avoid unintended start. Touch and hold the CANCEL keypad for about 3 seconds until tone sound and the CONTROL LOCKED icon appears in the display. Repeat to unlock control.
Setup /Clock	Set the Clock	<p>The Clock is a 12-hour(1:00-12:59), no leading 0 for 1:00-9:59.</p> <ol style="list-style-type: none"> 1. Press the Setup/Clock keypad repeatedly until Clock. 2. Pressing number keypad to set the clock. 3. Press START or SETUP/CLOCK to save. <p>Note:</p> <ul style="list-style-type: none"> ■ If the clock set is not correctly, start the clock with the clock in memory or “.”. ■ The default clock value in the memory is “ : ”.
Setup /Clock	Set the Sound	<p>Disable or enable button tones, and set the volume level.</p> <p>Press the Setup/Clock keypad repeatedly until Sound.</p> <p>Press number keypad 1-Button Tones 2-Volume.</p> <p>Press START or SETUP/CLOCK to save.</p> <ul style="list-style-type: none"> ■ Button Tones: Press 1-On 2-Off ■ Volume: Press 1-Low 2-Med 3-High
Setup /Clock	Set Scrolling Speed	<p>Scrolling speed options will be between Low, Medium and High speeds.</p> <ol style="list-style-type: none"> 1. Press the Setup/Clock keypad repeatedly until Scrolling Speed. 2. Press number keypad 1 for Low, 2 for Medium and 3 for High. 3. Press START or SETUP/CLOCK to save.
Setup /Clock	Set Display Auto Off	<p>This feature would allow user to set a display mode on / off. When mode is set, display will turn off after two minutes being in idle state.</p> <ol style="list-style-type: none"> 1. Press the Setup/Clock keypad repeatedly until Display Auto Off. 2. Press number keypad 1-Yes 2-No. 3. Press START or SETUP/CLOCK to save.

Keypad	Feature	Instructions
Setup /Clock	Activate Demo Mode	<p>Activate to practice using the control without actually turning on the magnetron. Touch SETUP/CLOCK to reach the Demo mode submenu, then follow the prompts to activate. The Clock or : will light up in the display. Repeat to deactivate.</p> <p>If the microwave oven has not been used for 5 min (no key press for 5min), the display will show "DEMO ON".</p>
Setup /Clock	Factory Reset	<p>User may set microwave oven back to default state. To Activate factory reset mode, at idle state, press the Setup/Clock repeatedly until Factory Reset. Press Start to reset.</p>
Power/Timer	Set Manual Cooking Time and Power	<p>Touch POWER/TIMER to set manual power and cooking time. The default power level is 100%, press any number keypad to change the power level. For example to set the time to 2:30 in 90% power level.</p> <ol style="list-style-type: none"> 1. Touch POWER/TIMER,  icon show on the display. 2. Use the number keypad 9 to set the power level in 90%. 3. Touch POWER/TIMER again,  icon show on the display. 4. Use the number keypads to enter the cooking time length 2:30. "Start?" icon flash on the display. 5. Touch Start. <p>When the stop time is reached, the microwave oven will shut off automatically, and end tones will sound.</p>
DEFROST	Automatic Defrost	<ol style="list-style-type: none"> 1. Touch DEFROST,  icon show on the display. 2. Touch number keypad to select food category, see DEFROST section for the food category or the door sticker on the unit. 3. Touch number keypad to enter the quantity. 4. Touch Start. <p>The display will count down the defrost time. For better results, a preset standing time is included in the defrosting time. This may make the defrosting time seem longer than expected.</p> <p>When the stop time is reached, the microwave oven will shut off automatically, and end tones will sound.</p>
REHEAT	Automatic Reheat	<ol style="list-style-type: none"> 1. Touch REHEAT,  icon show on the display. 2. Touch number keypad to select food category, see REHEAT section for the food category or the door sticker on the unit. 3. Touch number keypad to enter the quantity. 4. Touch Start. <p>When the stop time is reached, the microwave oven will shut off automatically, and end tones will sound.</p>
POPCORN	Popcorn	<ol style="list-style-type: none"> 1. Touch POPCORN repeatedly to select bag size. 3.0 oz is the default bag size. "Start?" flash on the display. 2. Touch the Start. <p>When the stop time is reached, the microwave oven will shut off automatically, and end tones will sound.</p>
SOFTEN/MELT	Soften/Melt	<ol style="list-style-type: none"> 1. Touch SOFTEN/MELT,  icon show on the display. 2. Touch number keypad to select food category, see SOFTEN/MELT section for the food category or the door sticker on the unit. 3. Touch number keypad to enter the quantity. "Start?" flash on the display 4. Touch Start. <p>When the stop time is reached, the microwave oven will shut off automatically, and end tones will sound.</p>
COOK	Auto Cook	<ol style="list-style-type: none"> 1. Touch COOK,  icon show on the display. 2. Touch number keypad to select food category, see COOK section for the food category or the door sticker on the unit. 3. Touch number keypad to enter the quantity. "Start?" flash on the display 4. Touch Start. <p>When the stop time is reached, the microwave oven will shut off automatically, and end tones will sound.</p>

Standby Mode

When no functions are working, microwave oven will switch to Standby Power mode and dim the display brightness after 2 minutes. Touch any keypad or open/close the door, and the display will return to the normal brightness.

Auto Vent Fan

To keep the microwave oven from overheating, the auto vent fan will automatically turn on to prevent the hardware. When this occurs, the vent fan cannot be turned off. "AUTO FAN" will stay lit until the safe temperature is reached.

Control Lock

The Control Lock shuts down the control panel keypads to avoid unintended use of the microwave oven. The Control Lock will remain set after a power failure, if set before the power failure occurs.

When the control is locked, only the fan and light will function.

The Control Lock is preset unlocked, but can be locked.

To Lock Control: Touch CANCEL for approximately 3 seconds, until two tones sound and a  icon appears in the display.

To Unlock Control: Repeat to unlock. Two tones will sound and the  icon will be removed.

MICROWAVE OVEN USE

A magnetron in the microwave oven produces microwaves which reflect off the metal floor, walls, and ceiling and pass through the turntable and appropriate cookware to the food. Microwaves are attracted to and absorbed by fat, sugar, and water molecules in the food, causing them to move, producing friction and heat which cooks the food.

Water molecules in the food, causing them to move, producing friction and heat which cooks the food.

- To avoid damage to the microwave oven, do not lean on or allow children to swing on the microwave oven door.
 - To avoid damage to the microwave oven, do not operate microwave oven when it is empty.
 - The turntable must be in place and correct side up when microwave oven is in use. Do not use if turntable is chipped or broken. See the "Accessories" section to reorder.
 - Baby bottles and baby food jars should not be heated in microwave oven.
 - Clothes, flowers, fruit, herbs, wood, gourds, and paper, including brown paper bags and newspaper, should not be dried in the microwave oven.
 - Paraffin wax will not melt in the microwave oven because it does not absorb microwaves.
 - Use oven mitts or pot holders when removing containers from microwave oven.
 - Do not overcook potatoes. At the end of the recommended cook time, potatoes should be slightly firm. Let potatoes stand for 5 minutes. They will finish cooking while standing.
 - Do not cook or reheat whole eggs inside the shell. Steam buildup in whole eggs may cause them to burst. Cover poached eggs and allow a standing time.
-

Food Characteristics

When the microwave oven is cooking, the amount, size and shape, starting temperature, composition and density of the food affect cooking results.

Amount of Food

The more food that is heated at once, the longer the cook time that is needed. Check for doneness and add small increments of time, if necessary.

Size and Shape

Smaller pieces of food will cook more quickly than larger pieces, and uniformly shaped foods cook more evenly than irregularly shaped food.

Starting Temperature

Room temperature foods will heat faster than refrigerated foods, and refrigerated foods will heat faster than frozen foods.

Composition and Density

Foods high in fat and sugar will reach a higher temperature and will heat faster than other foods. Heavy, dense foods, such as meat and potatoes, require a longer cook time than the same size of a light, porous food, such as cake.

Cooking Guidelines

Covering

Covering food helps retain moisture, shorten cook time, and reduce spattering. Use the lid supplied with cookware. If a lid is not available, wax paper, paper towels, or plastic wrap approved for microwave ovens may be used. Plastic wrap should be turned back at one corner to provide an opening to vent steam. Condensation on the door and cavity surfaces is normal during heavy cooking.

Stirring and Turning

Stirring and turning redistributes heat evenly to avoid overcooking the outer edges of food. Stir from outside to center. If possible, turn food over from bottom to top.

Arranging

If heating irregularly shaped or different-sized foods, arrange the thinner parts and smaller-sized items toward the center. If cooking several items of the same size and shape, place them in a ring pattern, leaving the center of the ring empty.

Piercing

Before heating, use a fork or small knife to pierce or prick foods that have a skin or membrane, such as potatoes, egg yolks, chicken livers, hot dogs, and sausage. Prick in several places to allow steam to vent.

Shielding

Use small, flat pieces of aluminum foil to shield the thin pieces of irregularly shaped foods, bones, and foods such as chicken wings, leg tips, and fish tails. See the “Aluminum Foil and Metal” section first.

Standing Time

Food will continue to cook by the natural conduction of heat, even after the microwave cooking cycle ends. The length of standing time depends on the volume and density of the food.

Cookware and Dinnerware

Cookware and dinnerware must fit on the turntable. Always use oven mitts or pot holders when handling because any dish may become hot from heat transferred from the food. Do not use cookware and dinnerware with gold or silver trim. Use the following chart as a guide, then test before using.

Material	Recommendations
Aluminum Foil, Metal	See the “Aluminum Foil and Metal” section.
Browning Dish	Bottom must be at least 3/16" (5 mm) above the turntable. Follow manufacturer's recommendations.
Ceramic Glass, Glass	Acceptable for use.
China, Earthenware	Follow manufacturer's recommendations.
Melamine	Follow manufacturer's recommendations.
Paper: Towels, Dinnerware, Napkins	Use non-recycled and those approved by the manufacturer for microwave oven use.
Plastic: Wraps, Bags, Covers, Dinnerware, Containers	Use those approved by the manufacturer for microwave oven use.
Pottery and Clay	Follow manufacturer's recommendations.
Silicone Bakeware	Follow manufacturer's recommendations.
Straw, Wicker, Wooden Containers	Do not use in microwave oven.
Styrofoam ^{®†}	Do not use in microwave oven.
Wax Paper	Acceptable for use.

To Test Cookware or Dinnerware for Microwave Use:

1. Place cookware or dinnerware in microwave oven with 1 cup (250 mL) of water beside it.
2. Cook at 100% cooking power for 1 minute.

Do not use cookware or dinnerware if it becomes hot and the water stays cool.

Aluminum Foil and Metal

Always use oven mitts or pot holders when removing dishes from the microwave oven.

Aluminum foil and some metal can be used in the microwave oven. If not used properly, arcing (a blue flash of light) can occur and cause damage to the microwave oven.

OK for Use

Racks and bakeware supplied with the microwave oven (on some models), aluminum foil for shielding, and approved meat thermometers may be used with the following guidelines:

- To avoid damage to the microwave oven, do not allow aluminum foil or metal to touch the inside cavity walls, ceiling, or floor.
- Always use the turntable.
- To avoid damage to the microwave oven, do not allow contact with another metal object during microwave cooking.

Do Not Use

Metal cookware and bakeware, gold, silver, pewter, non-approved meat thermometers, skewers, twist ties, foil liners, such as sandwich wrappers, staples, and objects with gold or silver trim or a metallic glaze, should not be used in the microwave oven.

Metal bakeware may be used only during convection (bake) cycles. Use ovenproof, microwave-safe cookware for all other convection and combination.

Microwave Cooking Power

Many recipes for microwave cooking specify which cooking power to use by percent, name, or number. For example, 70%=Medium-High=7.

Use the following chart as a general guide for the suggested cooking power of specific foods.

MICROWAVE COOKING POWER CHART

Percent/Name	Number	Use
100%, High (default setting)	10	Quick-heating convenience foods and foods with high water content, such as soups, beverages, and most vegetables.
90%	9	Cooking small, tender pieces of meat, ground meat, poultry pieces, and fish fillets. Heating cream soups.
80%	8	Heating rice, pasta, or casseroles. Cooking and heating foods that need a cook power lower than high, for example, whole fish and meat loaf.
70%, Medium-High	7	Reheating a single serving of food.
60%	6	Cooking sensitive foods such as cheese and egg dishes, pudding, and custards. Cooking non-stirrable casseroles, such as lasagna.
50%, Medium	5	Cooking ham, whole poultry, and pot roasts. Simmering stews.
40%	4	Melting chocolate. Heating bread, rolls, and pastries.
30%, Medium-Low, Defrost	3	Defrosting bread, fish, meats, poultry, and precooked foods.
20%	2	Softening butter, cheese, and ice cream.
10%, Low	1	Taking chill out of fruit.

[†]Styrofoam[®] is a registered trademark of The Dow Chemical Company.

Defrost

- For optimal results, food should be 0°F (-18°C) or colder when defrosting.
- Unwrap foods and remove lids (from fruit juice) before defrosting.
- Shallow packages will defrost more quickly than deep blocks.
- Separate food pieces as soon as possible during or at the end of the cycle for more even defrosting.
- Foods left outside the freezer for more than 20 minutes or frozen ready-made food should not be defrosted using the Defrost feature but should be defrosted manually.
- Use small pieces of aluminum foil to shield parts of food such as chicken wings, leg tips, and fish tails. See the “Aluminum Foil and Metal” section first
- Times and cooking powers have been preset for defrosting a number of food types.

Item	Food Category	Weight
1	Meats*	0.2 to 6.6 lbs (90 g to 3 kg)
2	Poultry*	0.2 to 6.6 lbs (90 g to 3 kg)
3	Fish*	0.2 to 4.4 lbs (90 g to 2 kg)
4	Quick	1.0 lb only

* See the Defrost Preparation Chart at end of the “Defrost” section for cuts, sizes, and instructions.

Use the following chart as a guide when defrosting meat, poultry, or fish.

DEFROST PREPARATION CHART

MEAT

Beef: ground, steaks, roast, stew	The narrow or fatty areas of irregular-shaped cuts should be shielded with foil before defrosting.
Lamb: stew and chops	
Pork: chops, ribs, roasts, sausage	Do not defrost less than 1/4 lb (113 g) or two 4 oz (113 g) patties. Place all meats in a microwave-safe baking dish.

POULTRY

Chicken: whole and cut up	Place in a microwave-safe baking dish, chicken breast-side up.
Cornish hens	Remove giblets from whole chicken.
Turkey: breast	

FISH

Fillets, Steaks, Whole, Shellfish	Place in a microwave-safe baking dish.
--	--

Reheat

Times and cooking powers have been preset for reheating a number of food types.

Use the following chart as a guide.

REHEAT CHART

Item	Food Category	Quantity
1	Beverage Do not cover.	1-2 cups (250 mL-500 mL)
2	Casserole Place in microwave-safe container. Cover with plastic wrap and vent. Stir and let stand 2-3 minutes after reheating.	1-4 cups (250 mL-1 L)
3	Dinner plate Place food on plate. Cover with plastic wrap and vent. Let stand 2-3 minutes after reheating.	1 plate, about 8-16 oz (227-454 g)
4	Pizza Place on paper towel lined microwave-safe plate.	1-3 slice, 4 oz (113 g) each
5	Soup/Sauce Place in microwave-safe container. Cover with plastic wrap and vent. Stir and let stand 2-3 minutes after reheating.	1-4 cups (250 mL-1 L)

Cook

Item	Food Category	Quantity
1	Bacon Average thickness: Follow directions on package. For best results, place bacon on microwave-safe bacon rack.	1-6 slices
2	Canned Vegetable Place in microwave-safe container. Cover with plastic wrap, and vent. Stir and let stand 2-3 minutes after cooking.	1, 2, 3 or 4 cups (250, 500, 750 mL or 1 L)
3	Fresh Vegetable Place in microwave-safe container and add 2-4 tbs water. Cover with plastic wrap and vent. Stir and let stand 2-3 minutes after cooking.	1-4 cups (250 mL-1 L)
4	Frozen Vegetable Place in microwave-safe container and add 2-4 tbs water. Cover with plastic wrap and vent. Stir and let stand 2-3 minutes after cooking.	1-4 cups (250 mL-1 L)
5	Small Potatoes Pierce each potato several times with a fork. Place on paper towel, around turntable edges, at least 1" (2.5 cm) apart. Place single potato to the side of the turntable. Let stand 5 minutes after cooking.	1-4 pieces, 4-7 oz (113-198 g)
6	Large Potatoes Pierce each potato several times with a fork. Place on paper towel, around turntable edges, at least 1" (2.5 cm) apart. Place single potato to the side of the turntable. Let stand 5 minutes after cooking.	1-4 pieces, 8-10 oz (227-283 g).
7	Rice Follow measurements on package for ingredient amounts. Place rice and liquid in microwave-safe dish. Cover with loose fitting lid. Let stand 5 minutes after cooking, or until liquid is absorbed. Stir.	0.5, 1.0, 1.5, 2.0 cups (125, 250, 375, 500 mL) (dry, white long grain)

Popcorn

3.0 or 3.5 oz bags.

- Do not use regular paper bags or glassware.
- Pop only one package of popcorn at a time.
- Follow manufacturer's instructions when using a microwave popcorn popper.
- Listen for popping to slow to one pop every 1 or 2 seconds, and then stop the cycle. Do not repop unpopped kernels.
- For best results, use fresh bags of popcorn.
- Cooking results may vary by brand and fat content.

NOTE: Follow the instructions provided by the microwave popcorn manufacturer.

Soften/Melt

Soften and Melt functions may be used to soften or melt your food. Times and cooking powers have been preset for a number of food types. Use the following chart as a guide.

Item	Food Category	Quantity	Preparation
1	Soften Butter	0.5, 1.0, 1.5, 2.0 sticks	Unwrap and place in microwave-safe container.
2	Soften Ice Cream	16, 32, or 64 oz (473, 946 or 1893 mL)	Place ice cream container on turntable.
3	Soften Cream Cheese	8 oz (227 g)	Unwrap and place in microwave-safe container.
4	Soften Frozen Juice	12oz (340 g)	Remove lid.
5	Melt Butter	0.5, 1.0, 1.5, 2.0 sticks	Unwrap and place in microwave-safe container.
6	Melt Chocolate	4, 6, 8 or 12 oz (113, 170, 227 or 340 g)	Cut squares into small pieces or use chips. Place in microwave-safe container.
7	Melt Cheese	8 or 16 oz (227 or 454 g)	Cut into small pieces and place in microwave-safe container.
8	Melt Marshmallows	5 or 10 oz (142 or 283 g)	Place in microwave-safe container.

MICROWAVE OVEN CARE

General Cleaning

IMPORTANT: Before cleaning, make sure all controls are off and the microwave oven is cool. Always follow label instructions on cleaning products.

Soap, water, and a soft cloth or sponge are suggested first, unless otherwise noted.

STAINLESS STEEL (on some models)

NOTE: To avoid damage to stainless steel surfaces, do not use soap-filled scouring pads, abrasive cleaners, cooktop polishing creme, steel-wool pads, gritty washcloths, or abrasive paper towels. Damage may occur to stainless steel surfaces, even with one-time or limited use.

Rub in direction of grain to avoid damaging.

Cleaning Method:

- Affresh® Stainless Steel Cleaner Part Number W10355016 (not included);
See the “Accessories” section to order.
- Vinegar for hard water spots

MICROWAVE OVEN DOOR EXTERIOR

Cleaning Method:

- Glass cleaner and a soft cloth or sponge:
Apply glass cleaner to soft cloth or sponge, not directly on panel.
- Affresh® Kitchen Appliance Cleaner Part Number W10355010 (not included);
See the “Accessories” section to order.

MICROWAVE OVEN CAVITY

To avoid damage to microwave oven cavity, do not use soap-filled scouring pads, abrasive cleaners, steel-wool pads, gritty washcloths, or some paper towels.

On stainless steel models, rub in direction of grain to avoid damaging.

The area where the microwave oven door and frame touch when closed should be kept clean.

Cleaning Method:

Average soil

- Mild, nonabrasive soaps and detergents:
Rinse with clean water and dry with soft, lint-free cloth.

Heavy soil

- Mild, nonabrasive soaps and detergents:
Heat 1 cup (250 mL) of water for 2 to 5 minutes in microwave oven. Steam will soften soil. Rinse with clean water and dry with soft, lint-free cloth.

Odors

- Lemon juice or vinegar:
Heat 1 cup (250 mL) of water with 1 tbs (15 mL) of either lemon juice or vinegar for 2 to 5 minutes in microwave oven.

TURNTABLE

Replace turntable immediately after cleaning. Do not operate the microwave oven without the turntable in place.

Cleaning Method:

- Mild soap and water
- Dishwasher

TURNTABLE SUPPORT AND ROLLERS, HUB

- Mild soap and water or dishwasher

NONSTICK CAVITY COATING (on some models)

To avoid damage to the microwave oven cavity, do not use metal or sharp utensils or scrapers or any type of abrasive cleanser or scrubbers.

MICROWAVE OVEN CARE

Cavity Light is located at the top front of the microwave oven, under the cover and is replaceable.

To replace the cavity light refer the following steps.

- Using a Philips screwdriver to remove the 4 long wood screws from the trim kit.

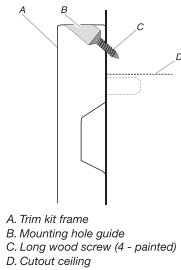

- Slide the microwave oven out of the cabinet. Put the microwave on a stable desk.

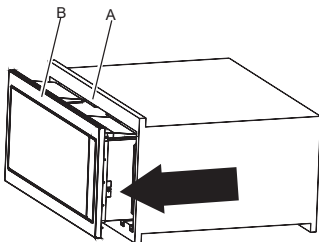

- Loosen the 3 short screws to release the leftside cooling duct, see below pictorial. Take out the leftside cooling duct, and set aside.

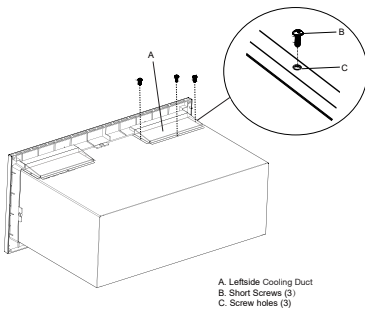

- Loosen the 4 screws which fast the trim kit frame to the microwave oven, and set the 4 screws aside.

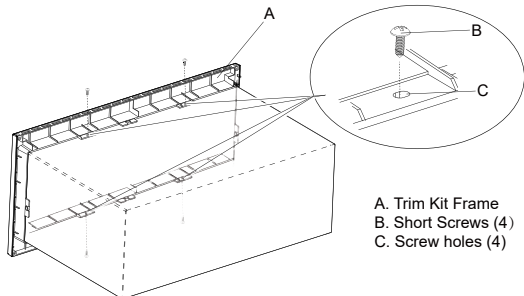

- Release the 4 locating pins from locating holes, take out the trim kit frame, and set aside.

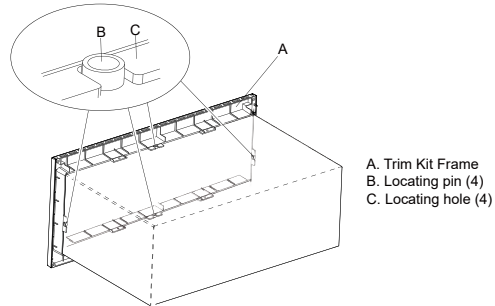

- Remove the light cover screw from the top front of the microwave oven.

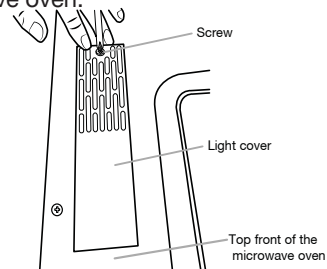

- Remove the light cover.

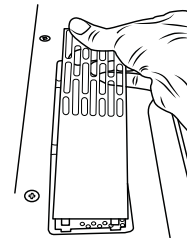

- Pull out the halogen light from the light holder.

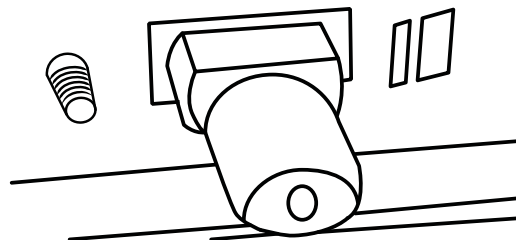

- Replace a new halogen.
- Reattach the light cover with the screw removed in step 7.
- Reattach the light cover screw removed in step step 6.
- Reattach the trim kit frame back to the microwave oven by inserting the 4 locating pins into the locating holes remove in step 5.
- Fix the 4 screws to fast the trim kit frame back to the microwave oven removed in step 4.
- Fix the leftside cooling duct by screw the 3 short screws removed in step 3.
- Slide the microwave oven back to the cabinet.
- Fix the 4 long wood screws to the trim kit removed from step 1.

TROUBLESHOOTING

First try the solutions suggested here. If you need further assistance or more recommendations that may help you avoid a service call, refer to the warranty page in this manual, or visit producthelp.whirlpool.com.

Contact us by mail with any questions or concerns at the address below:

In the U.S.A.:

Whirlpool Brand Home Appliances
Customer eXperience Center
553 Benson Road
Benton Harbor, MI 49022-2692

Please include a daytime phone number in your correspondence.

If you experience	Recommended Solutions
Microwave oven will not operate	<p>Check the following:</p> <ul style="list-style-type: none">■ Household fuse or circuit breaker: If a household fuse has blown or a circuit breaker has tripped, replace the fuse or reset the circuit breaker. If the problem continues, call an electrician.■ Magnetron: Try to heat 1 cup (250 mL) of cold water for 2 minutes at 100% cooking power. If water does not heat, try the steps in the bullets below. If microwave oven still does not operate, call for service.■ Door: Firmly close door. On some models, if a packaging spacer is attached to inside of the door, remove it, then firmly close door. If a message about the door appears in the display, the door has been closed for 5 minutes or more without the microwave oven being started. This occurs to avoid unintended starting of the microwave oven. Open and close the door, then start the cycle.■ Control: Make sure control is set properly. Make sure Control Lock is off. Make sure Demo mode (on some models) is off.
Arcing in the microwave oven	<p>Check the following:</p> <ul style="list-style-type: none">■ Soil buildup: Soil buildup on cavity walls, microwave inlet cover, cooking rack supports, and area where the door touches the frame can cause arcing. See “General Cleaning” in the “Microwave Oven Care” section.
Turntable alternates rotation directions	<ul style="list-style-type: none">■ This is normal and depends on motor rotation at the beginning of the cycle.
Display shows messages	<ul style="list-style-type: none">■ “Enter clock” with flashing digits means there has been a power failure. Reset the clock.■ A letter followed by a number is an error indicator. Call for assistance.
Fan running during cooktop usage	<ul style="list-style-type: none">■ This is normal. The microwave oven’s cooling fan, which is separate from the vent fan, automatically comes on during microwave oven operation to cool the microwave oven. It may also automatically come on and cycle on and off to cool the microwave oven’s controls while the cooktop below is being used.
Radio, TV, or cordless phone interference	<p>Check the following:</p> <ul style="list-style-type: none">■ Proximity: Move the receiver away from the microwave oven, or adjust the radio or TV antenna.■ Soil: Make sure the microwave oven door and sealing surfaces are clean.■ Frequency: Some 2.4 GHz-based cordless phones and home wireless networks may experience static or noise while microwave oven is on. Use a corded phone, a different frequency cordless phone, or avoid using these items during microwave oven operation.

ACCESSORIES

For accessories in the U.S.A., you can visit our website at www.whirlpool.com or call us at **1-800-253-1301**.

Cleaning Supplies

- | | |
|--------------------------------------|------------------------------------|
| ■ Heavy-duty Degreaser | ■ Affresh® Stainless Steel Cleaner |
| ■ Affresh® Kitchen Appliance Cleaner | ■ Affresh® Stainless Steel Wipes |