



FCC ID: PQY-4710874203747
Issued on Aug. 08, 2005

Report No.: FR521708-01

FCC TEST REPORT

CATEGORY : Portable
PRODUCT NAME : Bluetooth Stereo Audio Dongle
FCC ID. : PQY-4710874203747
FILING TYPE : Certification
BRAND NAME : Cellink
MODEL NAME : BTA-9000

APPLICANT : **CELLINK CO., LTD**
11F., No.102. Sec.1, Hsin Tai Wu Rd., His-Chin, Taipei,
Taiwan, R.O.C.

MANUFACTURER : **CELLINK CO., LTD**
11F., No.102. Sec.1, Hsin Tai Wu Rd., His-Chin, Taipei,
Taiwan, R.O.C.

ISSUED BY : **SPORTON INTERNATIONAL INC.**
6F, No. 106, Sec. 1, Hsin Tai Wu Rd., His Chih, Taipei Hsien,
Taiwan, R.O.C.

Statements:

The test result in this report refers exclusively to the presented test model / sample.

Without written approval of SPORTON International Inc., the test report shall not be reproduced except in full.

Certificate or Test Report could not be used by the applicant to claim the product endorsement by NVLAP and any agency of U.S. government.

The test equipment used to perform the test is calibrated and traceable to NML/ROC or NIST/USA.



Lab Code: 200079-0

SPORTON International Inc.

TEL : 886-2-2696-2468

FAX : 886-2-2696-2255



Table of Contents

HISTORY OF THIS TEST REPORT	II
CERTIFICATE OF COMPLIANCE.....	III
1. GENERAL DESCRIPTION OF EQUIPMENT UNDER TEST.....	1
1.1. Applicant	1
1.2. Manufacturer	1
1.3. Basic Description of Equipment under Test.....	1
1.4. Features of Equipment under Test	1
1.5. Antenna Description.....	2
1.6. Table for Carrier Frequencies	2
2. TEST CONFIGURATION OF THE EQUIPMENT UNDER TEST	3
2.1. Connection Diagram of Test System	3
2.2. The Test Mode Description	4
2.3. Description of Test Supporting Units	4
3. GENERAL INFORMATION OF TEST	5
3.1. Test Facility	5
3.2. Standards for Methods of Measurement.....	5
3.3. DoC Statement	5
3.4. Frequency Range Investigated	5
3.5. Test Distance	5
3.6. Test Software.....	5
4. LIST OF MEASUREMENTS	6
4.1. Summary of the Test Results.....	6
5. TEST RESULT	7
5.1. Test of Hopping Channel Bandwidth	7
5.2. Test of Hopping Channel Separation.....	10
5.3. Test of Number of Hopping Frequency.....	13
5.4. Test of Dwell Time of Each Frequency.....	15
5.5. Maximum Peak Output Power	22
5.6. Test of Band Edges Emission.....	23
5.7. Test of AC Power Line Conducted Emission	28
5.8. Test of Spurious Radiated Emission.....	33
5.9. Antenna Requirements	45
6. LIST OF MEASURING EQUIPMENTS USED.....	46
7. COMPANY PROFILE.....	48
7.1. Certificate of Accreditation	48
7.2. Test Location	48
8. CERTIFICATE OF NVLAP ACCREDITATION.....	49
APPENDIX A. PHOTOGRAPHS OF EUT	A1 ~ A25



HISTORY OF THIS TEST REPORT

Received Date: April 23, 2005

Test Date: Aug, 06 2005

Original Report Issue Date: Aug. 08, 2005

Report No.: FR521708-01

No additional attachment.

Additional attachment were issued as following record:

Attachment No.	Issue Date	Description



CERTIFICATE OF COMPLIANCE

with

47 CFR FCC Part 15 Subpart C

PRODUCT NAME : Bluetooth Stereo Audio Dongle

BRAND NAME : Cellink

MODEL NAME : BTA-9000

APPLICANT : **CELLINK CO., LTD**

11F., No.102. Sec.1, Hsin Tai Wu Rd., His-Chin, Taipei,
Taiwan, R.O.C.

MANUFACTURER : **CELLINK CO., LTD**

11F., No.102. Sec.1, Hsin Tai Wu Rd., His-Chin, Taipei,
Taiwan, R.O.C.

I **HEREBY** CERTIFY THAT:

The measurements shown in this test report were made in accordance with the procedures given in ANSI C63.4-2003 and all test are performed according to 47 CFR FCC Part 15 Subpart C. Testing was carried out on Aug, 06 2005 at SPORTON International Inc. LAB.



Wayne Hsu / Supervisor
Sporton International Inc.



1. General Description of Equipment under Test

1.1. Applicant

CELLINK CO., LTD

11F., No.102. Sec.1, Hsin Tai Wu Rd., His-Chin, Taipei, Taiwan, R.O.C.

1.2. Manufacturer

CELLINK CO., LTD

11F., No.102. Sec.1, Hsin Tai Wu Rd., His-Chin, Taipei, Taiwan, R.O.C.

1.3. Basic Description of Equipment under Test

This product is a Bluetooth stereo Dongle. The technical data has been listed on section " Features of Equipment under Test " .

1.4. Features of Equipment under Test

Items	Description
Type of Modulation	GFSK
Number of Channels	79
Frequency Band	2400 MHz ~ 2483.5 MHz
Carrier Frequency	See section 1.6 for details
Data Rate	1Mbps
Channel Bandwidth	1MHz
Max. Peak Power	-0.09 dBm
Antenna Type	See section 1.5 for details
Testing Duty Cycle	50.00%
Test Power Source	3.7V DC from battery
Temperature Range (Operating)	0 ~ 55 °C



1.5. Antenna Description

No.	Antenna Type	Gain (dBi)
1	Chip Antenna	1.00

1.6. Table for Carrier Frequencies

Channel	Frequency	Channel	Frequency	Channel	Frequency	Channel	Frequency
00	2402 MHz	20	2422 MHz	40	2442 MHz	60	2462 MHz
01	2403 MHz	21	2423 MHz	41	2443 MHz	61	2463 MHz
02	2404 MHz	22	2424 MHz	42	2444 MHz	62	2464 MHz
03	2405 MHz	23	2425 MHz	43	2445 MHz	63	2465 MHz
04	2406 MHz	24	2426 MHz	44	2446 MHz	64	2466 MHz
05	2407 MHz	25	2427 MHz	45	2447 MHz	65	2467 MHz
06	2408 MHz	26	2428 MHz	46	2448 MHz	66	2468 MHz
07	2409 MHz	27	2429 MHz	47	2449 MHz	67	2469 MHz
08	2410 MHz	28	2430 MHz	48	2450 MHz	68	2470 MHz
09	2411 MHz	29	2431 MHz	49	2451 MHz	69	2471 MHz
10	2412 MHz	30	2432 MHz	50	2452 MHz	70	2472 MHz
11	2413 MHz	31	2433 MHz	51	2453 MHz	71	2473 MHz
12	2414 MHz	32	2434 MHz	52	2454 MHz	72	2474 MHz
13	2415 MHz	33	2435 MHz	53	2455 MHz	73	2475 MHz
14	2416 MHz	34	2436 MHz	54	2456 MHz	74	2476 MHz
15	2417 MHz	35	2437 MHz	55	2457 MHz	75	2477 MHz
16	2418 MHz	36	2438 MHz	56	2458 MHz	76	2478 MHz
17	2419 MHz	37	2439 MHz	57	2459 MHz	77	2479 MHz
18	2420 MHz	38	2440 MHz	58	2460 MHz	78	2480 MHz
19	2421 MHz	39	2441 MHz	59	2461 MHz		

2. Test Configuration of the Equipment Under Test

2.1. Connection Diagram of Test System

Conducted

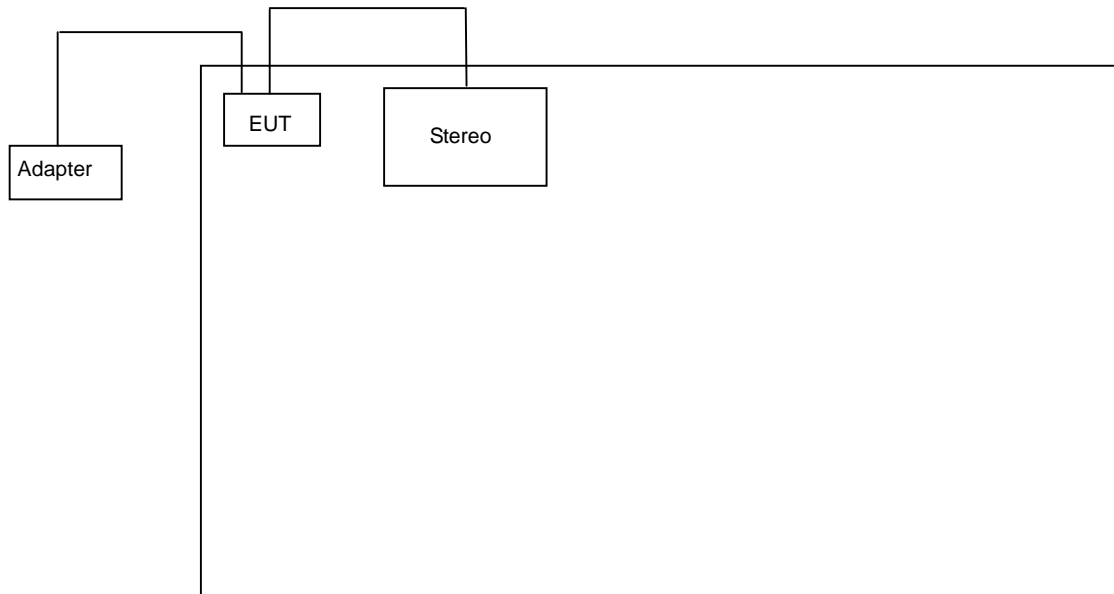

Radiated

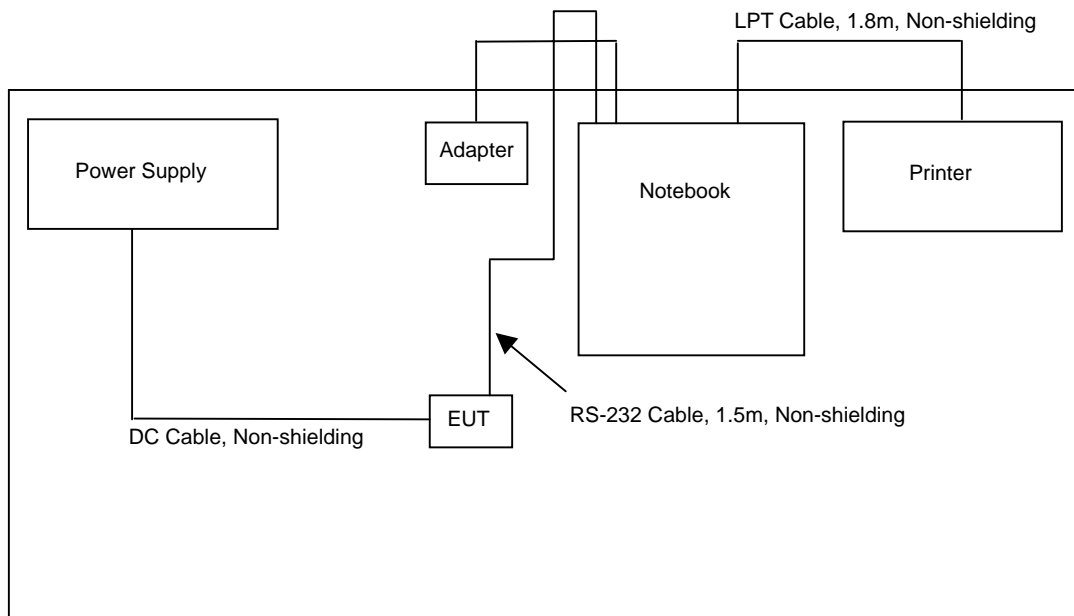



2.2. The Test Mode Description

1. For FHSS modulation, GFSK is the worst case on all test items.
2. According to ANSI C63.4-2003: If frequency range of EUT is more than 10 MHz, we have to test the lowest, middle and highest channels of EUT.
3. Spurious emission below 1GHz is independent of channel selection, so only channel 78 with GFSK modulation was tested.
4. AC conduction emission is independent of channel selection, so only channel 78 with GFSK modulation was tested.

2.3. Description of Test Supporting Units

Support unit	Brand	Model No.	FCC ID
Notebook	DELL	D505	-
Power Supply	GW	GPC-6030D	-
Printer	EPSON	Stylus Color 061	-
Stereo	KOKA	KW-247	-



3. General Information of Test

3.1. Test Facility

Test Site Location : No. 52, Hwa Ya 1st Rd., Hwa Ya Technology Park, Kwei-Shan Hsiag, Tao Yuan Hsien, Taiwan, R.O.C.
: TEL 886-3-327-3456
: FAX 886-3-318-0055

Test Site No : 03CH03-HY / TH01-HY / CO04-HY

3.2. Standards for Methods of Measurement

Here is the list of the standards followed in this test report.

ANSI C63.4-2003
47 CFR FCC Part 15 Subpart C

3.3. DoC Statement

This EUT is also classified as a device of computer peripheral Class B which DoC has to be followed. It has been verified according to the rule of 47 CFR part 15 Subpart B, and found that all the requirements has been fulfilled.

3.4. Frequency Range Investigated

Radiated emission test: from 30 MHz to 10th carrier harmonic.

3.5. Test Distance

The test distance of radiated emission (30MHz~1GHz) test from antenna to EUT is 3 M.
The test distance of radiated emission (1GHz~10th carrier harmonic) test from antenna to EUT is 3 M.

3.6. Test Software

During testing, Channel & Power Controlling Software: This was provided by the manufacturer and is able to let the test engineer select the operating channel as well as the RF output power. The parameters for channel selection is trying to offer the test engineer the ability to fix the operating channel for testing, both normal data and continuously transmitting modes are allowed, and that for RF output power selection is for the setting of RF output power expected by the customer and is going to be fixed on the firmware of the final end product.

Power Parameter Table

Test Software	Bluetest		
	CH 00	CH 39	CH 79
Test Channel	CH 00	CH 39	CH 79
Test Frequency	2402MHz	2441MHz	2480MHz
TX Power	55	55	55



4. List of Measurements

4.1. Summary of the Test Results

Applied Standard: 47 CFR FCC Part 15 Subpart C			
Paragraph	FCC Section	Description of Test	Result
5.1	15.247(a)(1)	Hopping Channel Bandwidth	Pass
5.2	15.247(a)(1)	Hopping Channel Separation	Pass
5.3	15.247(b)(1)	Number of Hopping Frequency Used	Pass
5.4	15.247(a)(1)(iii)	Dwell Time of Each Frequency	Pass
5.5	15.247(b)(1)	Maximum Peak Output Power	Pass
5.6	15.247(d)	Band Edges Emission	Pass
5.7	15.207	AC Power Line Conducted Emission	Pass
5.8	15.247(d)	Spurious Radiated Emission	Pass
5.9	15.203/15.247(b)/(c)	Antenna Requirement	Pass

5. Test Result

5.1. Test of Hopping Channel Bandwidth

5.1.1. Applicable Standard

Section 15.247(a)(1): Frequency hopping systems shall have hopping channel carrier frequencies separated by a minimum of 25 kHz or the 20 dB bandwidth of the hopping channel, whichever is greater.

5.1.2. Measuring Instruments

Please reference on section 6.

5.1.3. Description of Major Test Instruments Setting

- Spectrum Analyzer : R&S FSP30
- Attenuation : Auto
- Center Frequency : 2402 MHz / 2441 MHz / 2480 MHz
- Span Frequency : > 20dB Bandwidth
- RB : 30 kHz
- VB : 100 kHz
- Detector : Peak
- Trace : Max Hold
- Sweep Time : Auto

5.1.4. Test Procedures

1. The transmitter output was connected to the spectrum analyzer through an attenuator.
2. Set RBW of spectrum analyzer to 30KHz and VBW to 100KHz.
3. Set Detector to Peak, Trace to Max Hold and Sweep Time is Auto.
4. The spectrum width with level higher than 20dB below the peak level.
5. Repeat above 1~3 points for the lowest, middle and highest channel of the EUT.

5.1.5. Test Setup Layout

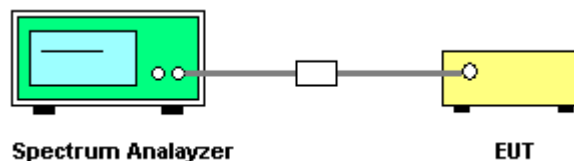

5.1.6. Test Criteria

All test results complied with the requirements of Section 15.247(a)(1). Measurement Uncertainty is 1×10^{-5} .



5.1.7. Test Result

- Temperature: 18°C
- Relative Humidity: 64%
- Duty Cycle of the Equipment During the Test: 50.00%
- Test Engineer: Leo Hung

Modulation Type	Channel No.	Frequency (MHz)	20dB Bandwidth (kHz)	Min. Limit (kHz)
GFSK	00	2402 MHz	822.00	25
GFSK	39	2441 MHz	810.00	25
GFSK	78	2480 MHz	837.00	25

Modulation Type: GFSK (Channel 00) :

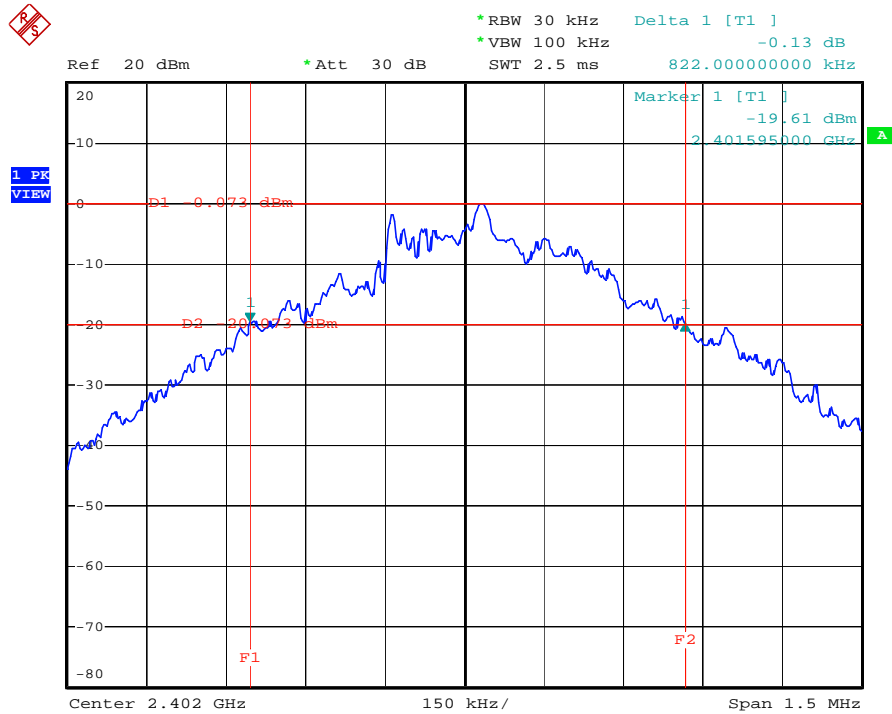

Date: 21.JUN.2005 13:52:28



Modulation Type: GFSK (Channel 39) :

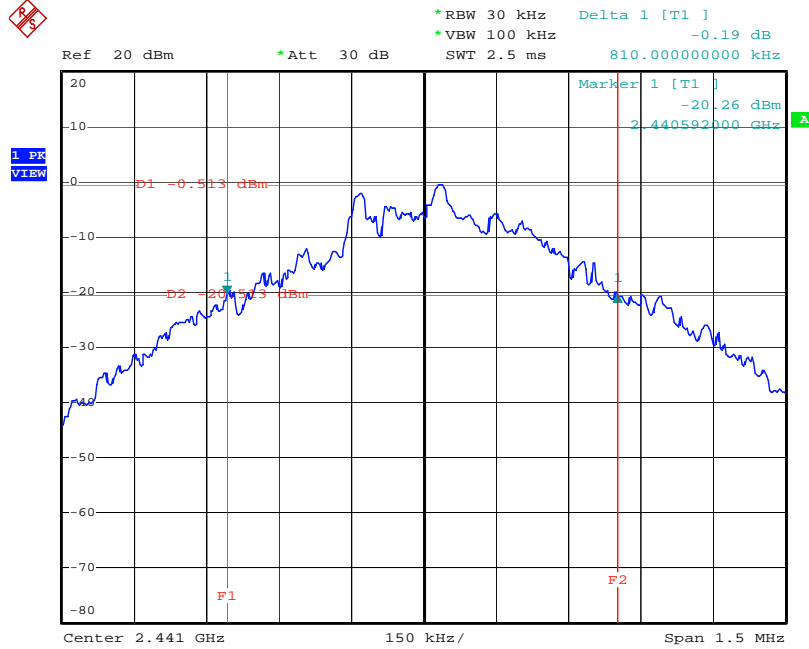

Date: 21.JUN.2005 13:57:28

Modulation Type: GFSK (Channel 78) :

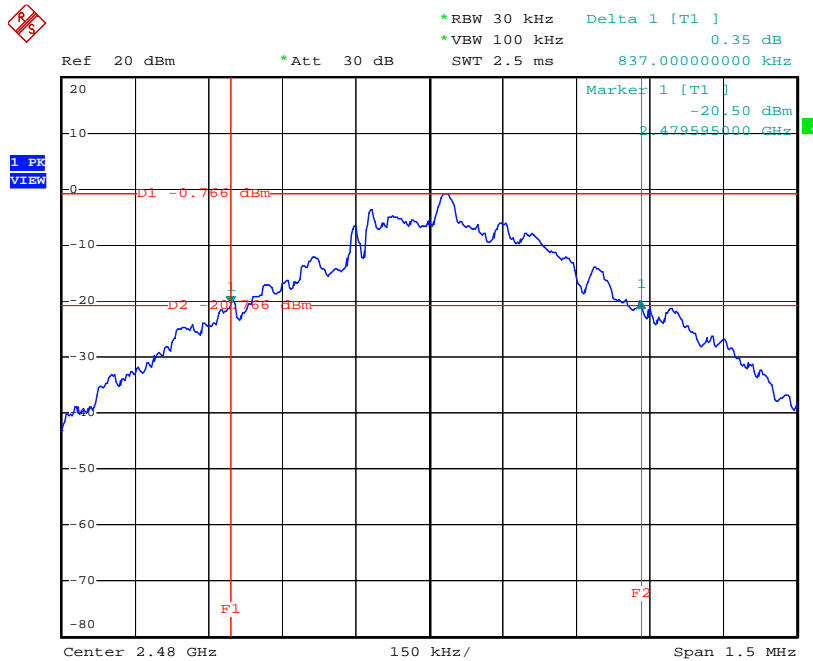

Date: 21.JUN.2005 13:59:09

5.2. Test of Hopping Channel Separation

5.2.1. Applicable Standard

Section 15.247(a)(1): Frequency hopping systems shall have hopping channel carrier frequencies separated by a minimum of 25 kHz or the 20 dB bandwidth of the hopping channel, whichever is greater.

5.2.2. Measuring Instruments

Please reference on section 6.

5.2.3. Description of Major Test Instruments Setting

- Spectrum Analyzer : R&S FSP30
- Attenuation : Auto
- Center Frequency : 2402 MHz / 2441 MHz / 2480 MHz
- Span Frequency : > One time channel separation
- RB : 100 kHz
- VB : 100 kHz
- Detector : Peak
- Trace : Max Hold
- Sweep Time : Auto

5.2.4. Test Procedures

1. The transmitter output was connected to the spectrum analyzer through an attenuator.
2. Set RBW of spectrum analyzer to 100KHz and VBW to 300KHz.
3. Set Detector to Peak, Trace to Max Hold and Sweep Time is Auto.
4. The Hopping Channel Separation is defined as the separation between 2 neighboring hopping frequencies.
5. Repeat above 1~3 points for the lowest, middle and highest channel of the EUT.

5.2.5. Test Setup Layout

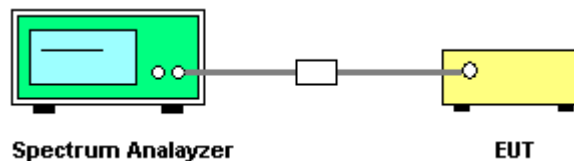

5.2.6. Test Criteria

All test results complied with the requirements of Section 15.247(a)(1). Measurement Uncertainty is 1×10^{-5} .



5.2.7. Test Result

- Temperature: 18°C
- Relative Humidity: 64%
- Duty Cycle of the Equipment During the Test: 50.00%
- Test Engineer: Leo Hung

Modulation Type	Channel No.	Frequency (MHz)	Hopping Channel Separation (kHz)	Min. Limit (kHz)
GFSK	00	2402 MHz	1000	822.00
GFSK	39	2441 MHz	1000	810.00
GFSK	78	2480 MHz	1000	837.00

Modulation Type: GFSK (Channel 00) :

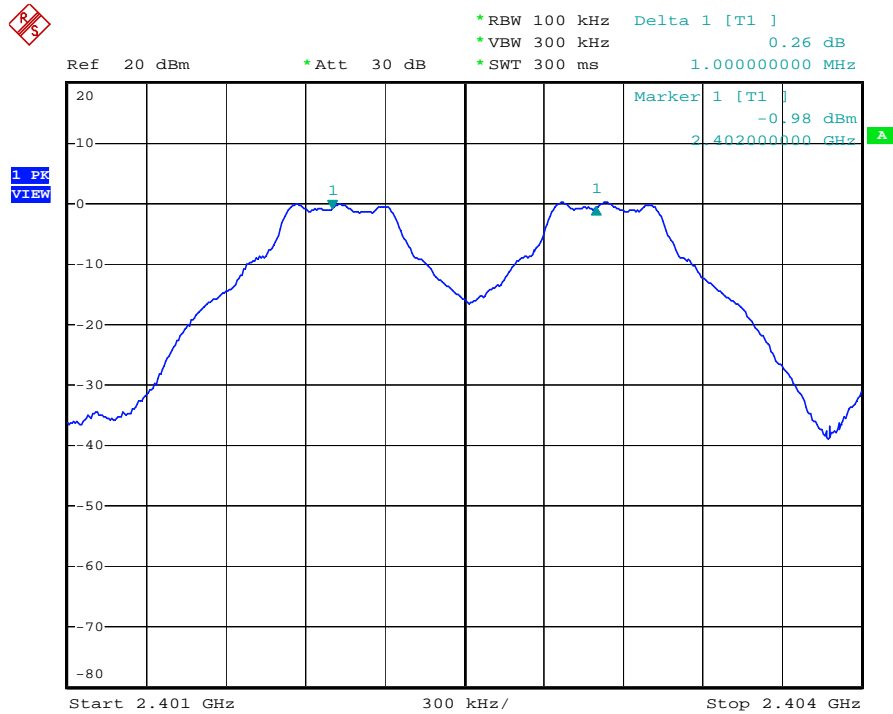

Date: 21.JUN.2005 13:52:13



Modulation Type: GFSK (Channel 39) :

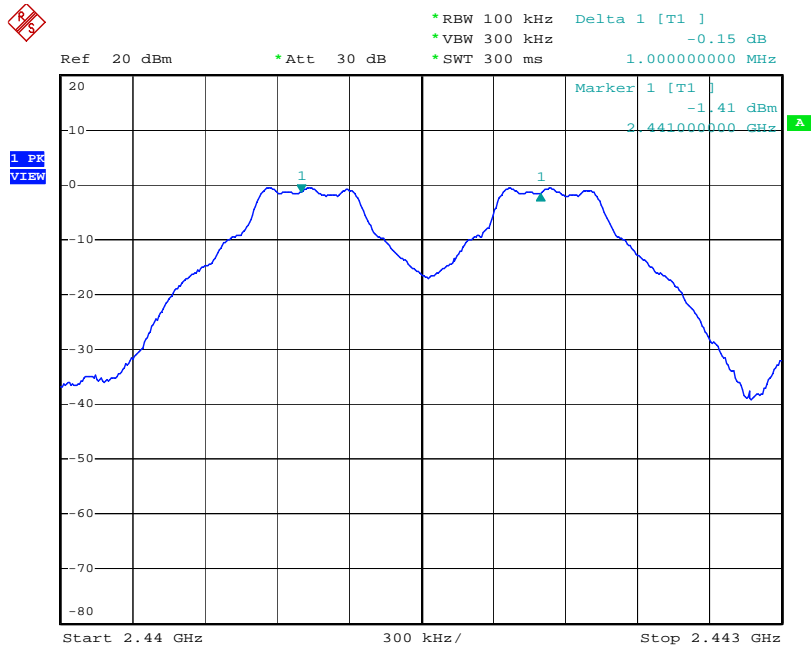

Date: 21.JUN.2005 13:57:12

Modulation Type: GFSK (Channel 78) :

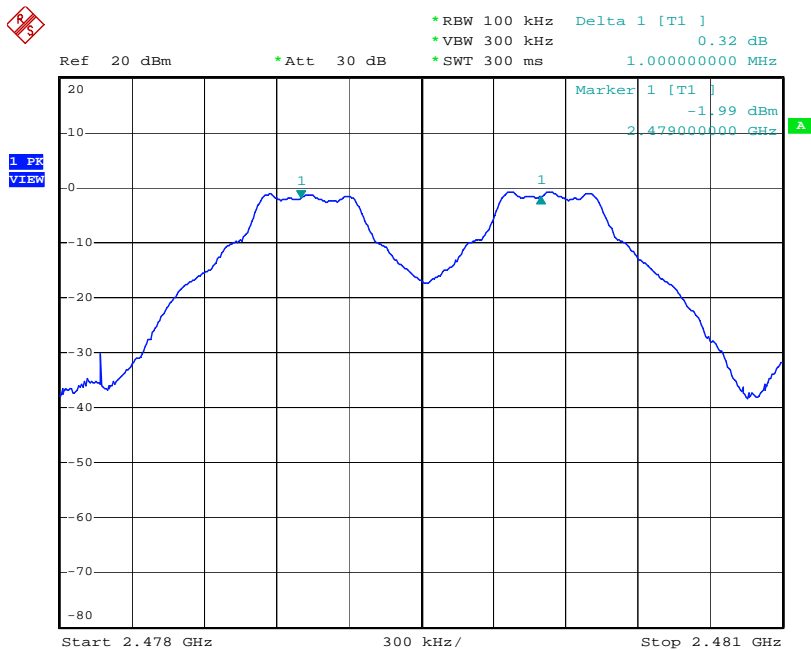

Date: 21.JUN.2005 13:58:53

5.3. Test of Number of Hopping Frequency

5.3.1. Applicable Standard

Section 15.247(b)(1): For frequency hopping systems operating in the 2400-2483.5 MHz band employing at least 75 non-overlapping hopping channels.

5.3.2. Measuring Instruments

Please reference on section 6.

5.3.3. Description of Major Test Instruments Setting

- Spectrum Analyzer : R&S FSP30
- Attenuation : Auto
- Center Frequency : 2402 MHz ~ 2480 MHz
- Span Frequency : > Operation frequency range
- RB : 100 kHz
- VB : 100 kHz

5.3.4. Test Procedures

1. The transmitter output was connected to the spectrum analyzer through an attenuator.
2. Set RBW of spectrum analyzer to 100KHz and VBW to 100KHz.
3. Set Detector to Peak, Trace to Max Hold and Sweep Time is Auto.
4. Observe frequency hopping in 2400MHz~2483.5MHz, there are at least 75 non-overlapping channels.

5.3.5. Test Setup Layout

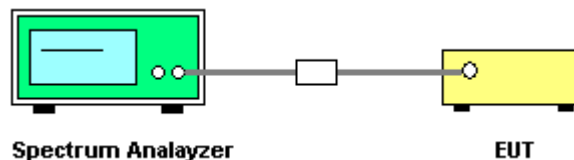

5.3.6. Test Criteria

All test results complied with the requirements of Section 15.247(b)(1).

5.3.7. Test Result

- Temperature: 18°C
- Relative Humidity: 64%
- Duty Cycle of the Equipment During the Test: 50.00%
- Test Engineer: Leo Hung

Modulation Type	Channel No.	Frequency (MHz)	Number of Hopping Ch. (Channels)	Min. Limit (Channels)
GFSK	00 ~ 78	2402 MHz ~ 2480 MHz	79	75

5.4. Test of Dwell Time of Each Frequency

5.4.1. Applicable Standard

47 CFR FCC Part 15 Subpart C, section 15.247(a)(1): Frequency hopping systems in the 2400-2483.5 MHz band shall use at least 15 channels. The average time of occupancy on any channel shall not be greater than 0.4 seconds within a period of 0.4 seconds multiplied by the number of hopping channels employed.

5.4.2. Measuring Instruments

Please reference on section 6.

5.4.3. Description of Major Test Instruments Setting

- Spectrum Analyzer : R&S FSP30
- Attenuation : Auto
- Center Frequency : 2402 MHz / 2441 MHz / 2480 MHz
- Span Frequency : 0MHz
- RB : 1 MHz
- VB : 1 MHz
- Detector : Peak
- Trigger : Video
- Sweep Time : > One pulse time

5.4.4. T Test Procedures and Test Instruments Setting

1. The transmitter output was connected to the spectrum analyzer through an attenuator.
2. Set RBW of spectrum analyzer to 1000kHz and VBW to 1000kHz.
3. Set Detector to Peak, Trace to Max Hold and Sweep Time is more than once pulse time.
4. Set the center frequency on any frequency would be measure and set the frequency span to zero span.
5. Set the EUT for DH5, DH3 and DH1 packet transmitting.
6. Measure the maximum time duration of one single pulse.
7. DH5 Packet permit maximum 3.37 hops per second in each channel. So, the dwell time is the time duration of the pulse times 106.6 within 31.6 seconds.
8. DH3 Packet permit maximum 5.06 hops per second in each channel. So, the dwell time is the time duration of the pulse times 160 within 31.6 seconds.
9. DH1 Packet permit maximum 10.12 hops per second in each channel. So, the dwell time is the time duration of the pulse times 320 within 31.6 seconds.

5.4.5. Test Setup Layout

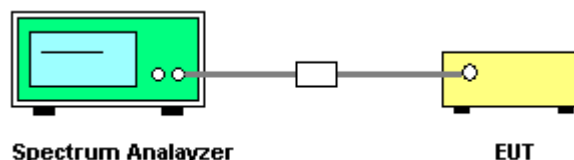

5.4.6. Test Criteria

All test results complied with the requirements of Section 15.247(a)(1)(iii). Measurement Uncertainty is 1×10^{-5} .



5.4.7. Test Result

- Temperature: 18°C
- Relative Humidity: 64%
- Duty Cycle of the Equipment During the Test: 50.00%
- Test Engineer: Leo Hung

Data Packet	Frequency (MHz)	Pulse Duration (ms)	Dwell Time (s)	Limits (s)
DH5	2402 MHz	3.1000	0.3307	0.4
DH3	2402 MHz	1.8550	0.2968	0.4
DH1	2402 MHz	0.5750	0.1840	0.4
DH5	2441 MHz	3.1100	0.3317	0.4
DH3	2441 MHz	1.8650	0.2984	0.4
DH1	2441 MHz	0.5800	0.1856	0.4
DH5	2480 MHz	3.1100	0.3317	0.4
DH3	2480 MHz	1.8700	0.2992	0.4
DH1	2480 MHz	0.5850	0.1872	0.4



DH5 Modulation Type: GFSK (Channel 00) :

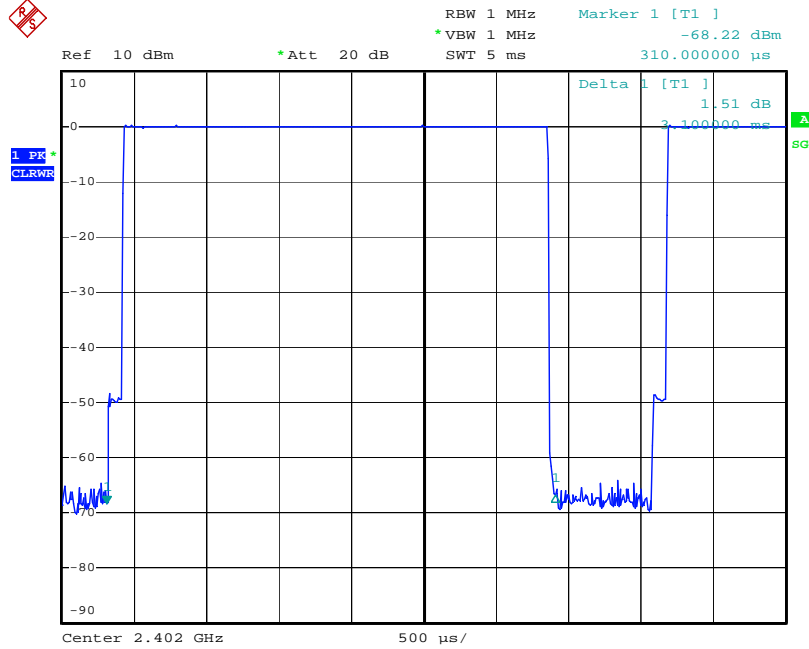

Date: 21.JUN.2005 14:11:05

DH3 Modulation Type: GFSK (Channel 00) :

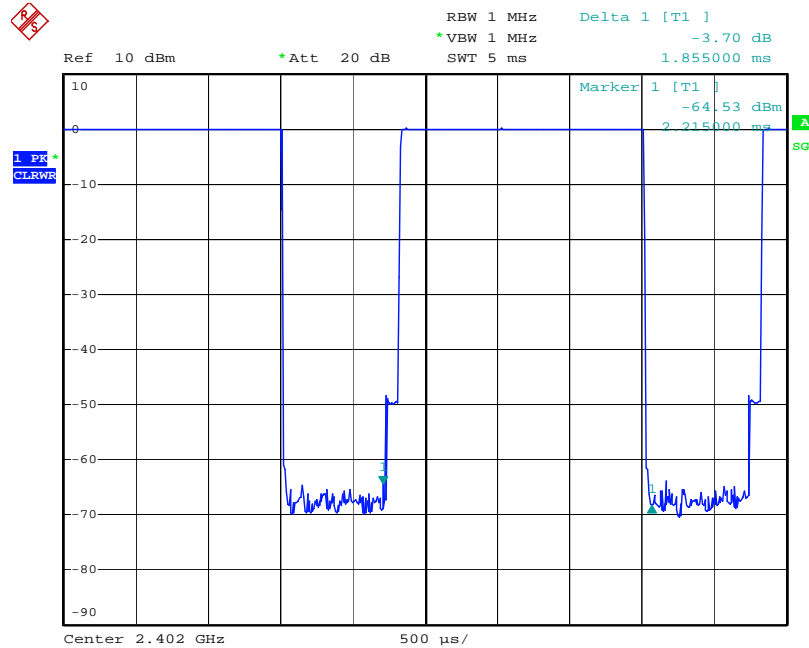

Date: 21.JUN.2005 14:09:39



DH1 Modulation Type: GFSK (Channel 00) :

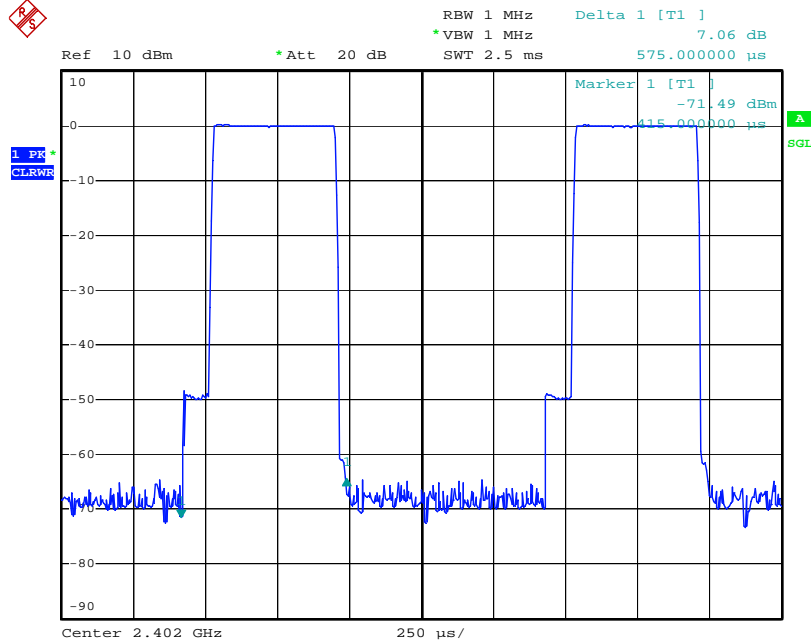

Date: 21.JUN.2005 14:07:42

DH5 Modulation Type: GFSK (Channel 39) :

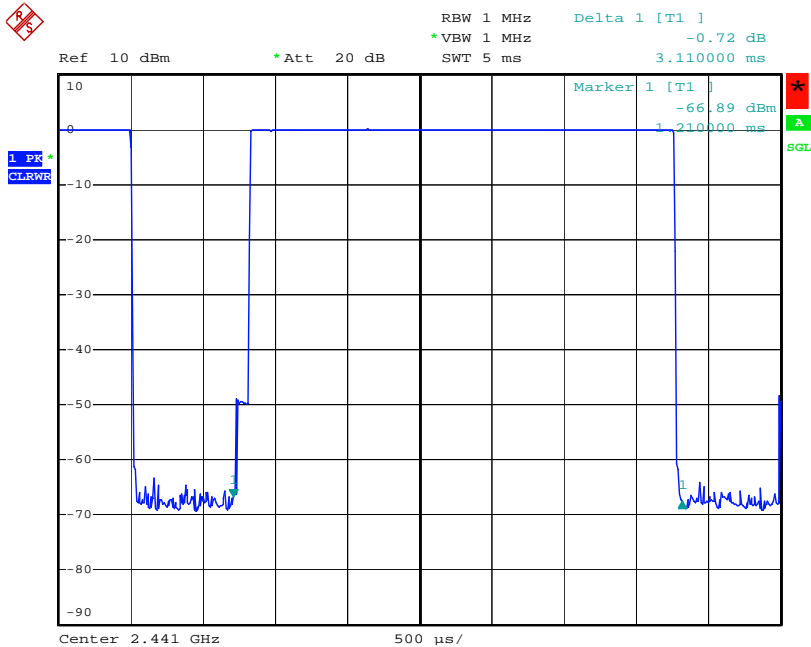

Date: 21.JUN.2005 14:11:35



DH3 Modulation Type: GFSK (Channel 39) :

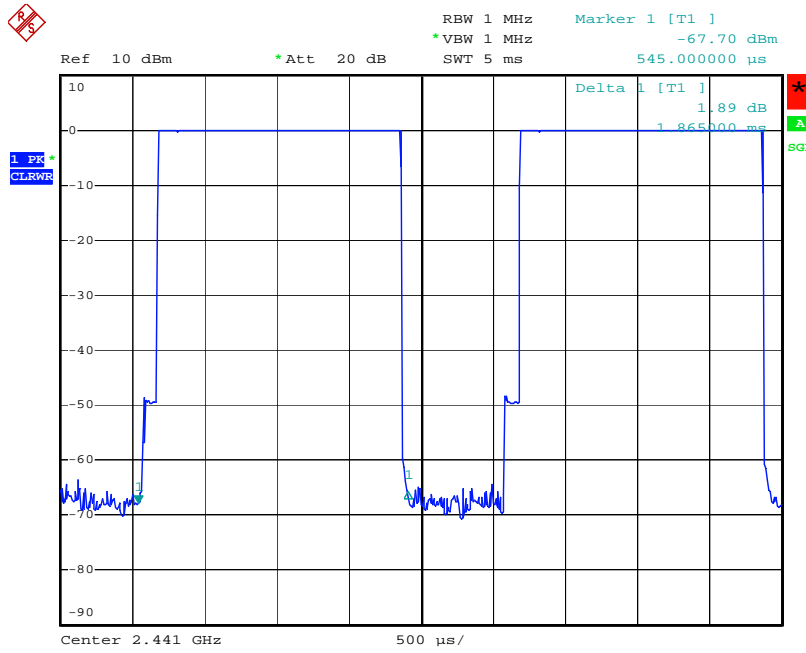

Date: 21.JUN.2005 14:10:02

DH1 Modulation Type: GFSK (Channel 39) :

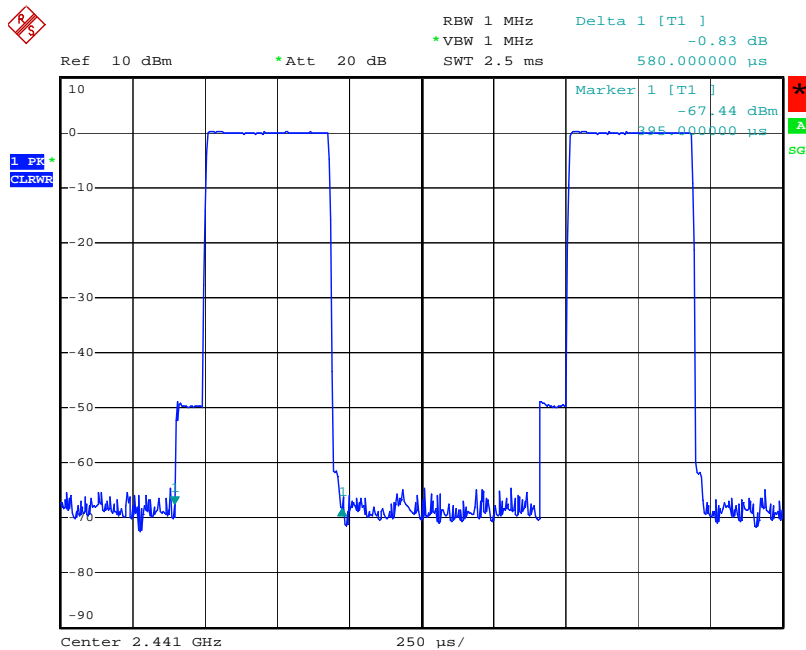

Date: 21.JUN.2005 14:08:11



DH5 Modulation Type: GFSK (Channel 78) :

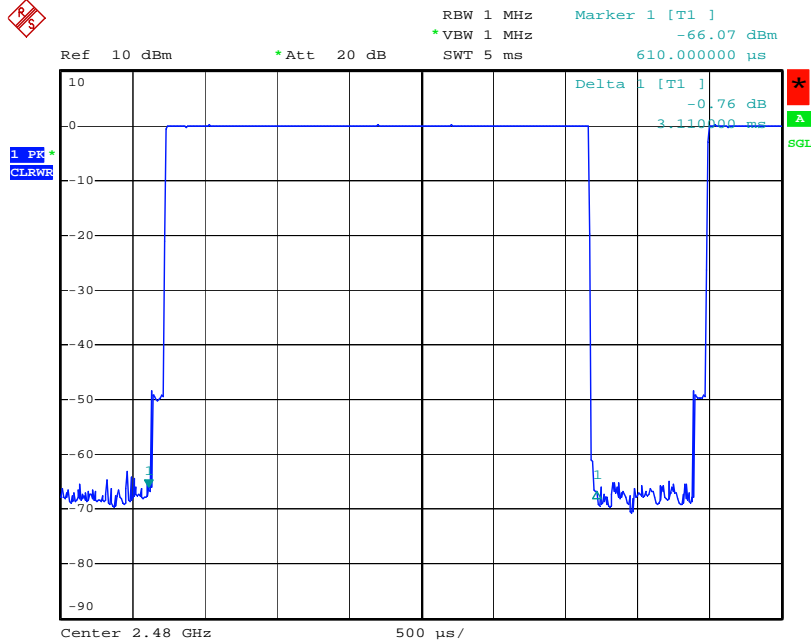

Date: 21.JUN.2005 14:12:03

DH3 Modulation Type: GFSK (Channel 78) :

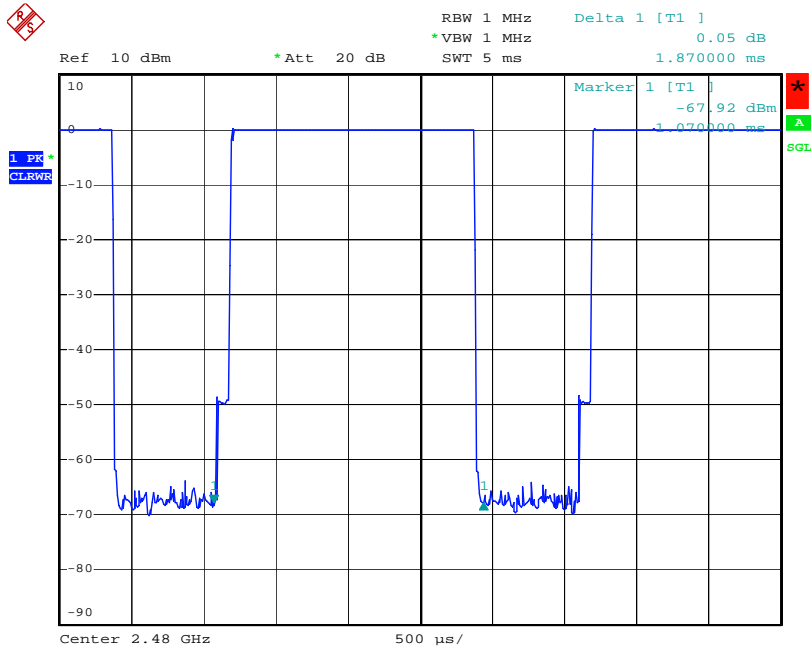

Date: 21.JUN.2005 14:10:29

5.5. Maximum Peak Output Power

5.5.1. Applicable Standard

Section 15.247(b)(1): For frequency hopping systems operating in the 2400-2483.5 MHz band employing at least 75 non-overlapping hopping channels and The maximum peak output power shall not exceed 1 watt.

5.5.2. Measuring Instruments

Please reference on section 6.

5.5.3. Test Procedures and Test Instruments Setting

1. The transmitter output was connected to the peak power meter and recorded the peak value.
2. The filter and attenuator has the same peak value instrument parameters.
3. Repeated the 1 for the lowest, middle and highest channel of the EUT.

5.5.4. Test Setup Layout

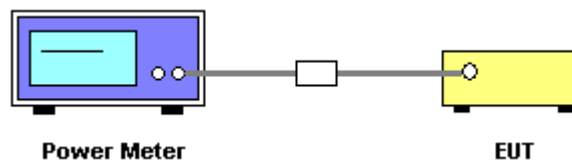

5.5.5. Test Criteria

All test results complied with the requirements of 15.247(b)(1). Measurement Uncertainty is 1.5dB.

5.5.6. Test Result of Conducted Peak Power

- Temperature: 18°C
- Relative Humidity: 64%
- Duty Cycle of the Equipment During the Test: 50.00%
- Test Engineer: Leo Hung

Modulation Type	Channel No.	Frequency (MHz)	Output Power (dBm)	Limits (dBm)
GFSK	00	2402 MHz	-0.09	30
GFSK	39	2441 MHz	-0.52	30
GFSK	78	2480 MHz	-0.71	30



5.6. Test of Band Edges Emission

5.6.1. Applicable Standard

Section 15.247(d): In any 100 kHz bandwidth outside the frequency band in which the spread spectrum or digitally modulated intentional radiator is operating, the radio frequency power that is produced by the intentional radiator shall be at least 20 dB below that in the 100 kHz bandwidth within the band that contains the highest level of the desired power, based on either an RF conducted or a radiated measurement. In addition, radiated emissions that fall in the restricted bands, as defined in Section 15.205, must also comply with the radiated emission limits specified in Section 15.209.

5.6.2. Measuring Instruments

Please reference on section 6.

5.6.3. Description of Major Test Instruments Setting

- Spectrum Analyzer : R&S FSP30 (Conducted Measurement)
 - Attenuation : Auto
 - Center Frequency : 2402 MHz / 2480 MHz
 - Span Frequency : 100MHz
 - RB : 100 kHz
 - VB : 100 kHz
 - Detector : Peak
 - Trace : Max Hold
 - Sweep Time : Auto

- Spectrum Analyzer : R&S FSP40 (Radiated Measurement)
 - Attenuation : Auto
 - Center Frequency : 2402 MHz / 2480 MHz
 - Span Frequency : 100MHz
 - RB : 1 MHz for PK value / 1 MHz for AV value
 - VB : 1 MHz for PK value / 10 Hz for AV value
 - Detector : Peak
 - Trace : Max Hold
 - Sweep Time : Auto

5.6.4. Test Procedures

Conducted Measurement

1. The transmitter is set to the lowest channel.
2. The transmitter output was connected to the spectrum analyzer via a cable and cable loss is used as the offset of the spectrum analyzer.
3. Set both RBW and VBW of spectrum analyzer to 100KHz with convenient frequency span including 100MHz bandwidth from lower band edge. Then detector set to peak and max hold this trace.
4. The lowest band edges emission was measured and recorded.
5. The transmitter set to the highest channel and repeated 2~4.
6. The transmitter set to the highest channel and repeated 2~5.

Radiated Measurement

1. Configure the EUT according to ANSI C63.4.
2. The turntable was rotated by 360 degrees to determine the position of the highest radiation.
3. The height of the broadband receiving antenna was varied between one meter and four meters above ground to find the maximum emission field strength of both horizontal and vertical polarization.
4. For band edge emission, the antenna tower was scan (from 1 M to 4 M) and then the turn table was rotated (from 0 degree to 360 degrees) to find the maximum reading.
5. For band edge emission, use 10Hz VBW and 1MHz RBW for reading under AV and use 1MHz VBW and 1 MHz RBW for reading under PK.

5.6.5. Test Setup

Radiated Method

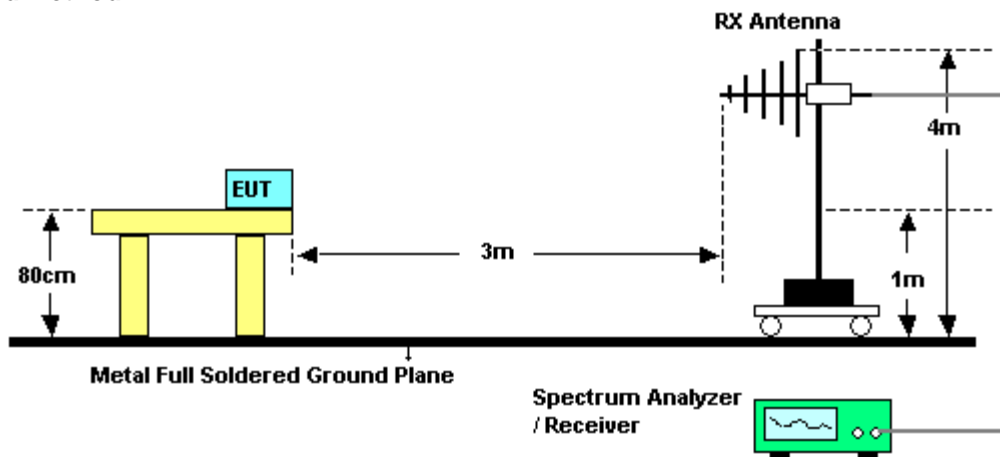

Conducted Method

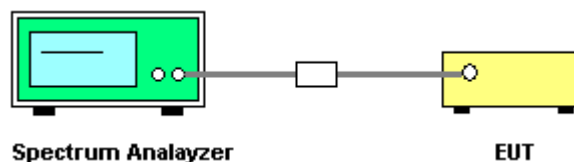

5.6.6. Test Criteria

All test results complied with the requirements of 15.247(d). Measurement Uncertainty is 2.26dB.



5.6.7. Test Result of Radiated Emission

- Temperature: 18°C
- Relative Humidity: 64%
- Duty Cycle of the Equipment During the Test: 50.00%
- Test Engineer: Leo Hung

CH 00 2402MHz

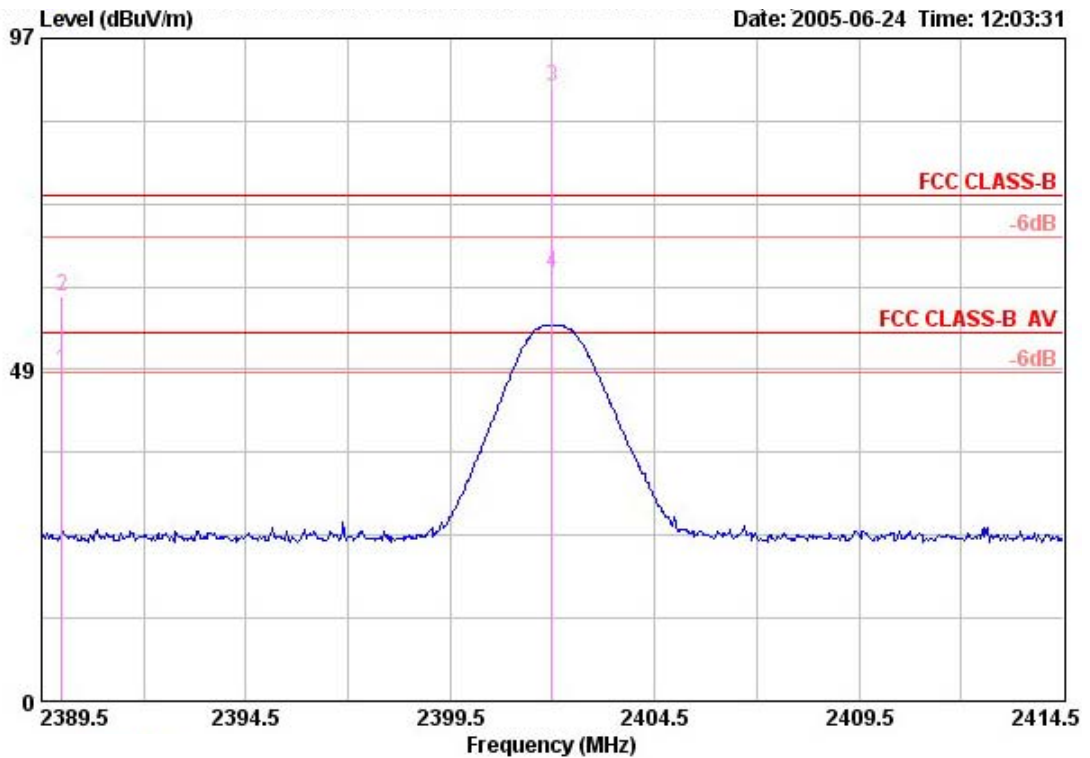

	Freq	Level	Over Limit	Limit	Antenna Line	Factor	Cable Loss	Preamp Factor	Read Level	Remark
	MHz	dBuV/m	dB	dBuV/m	dB/m		dB	dB	dBuV	
1 *	2390.000	48.36	-5.64	54.00	28.88		6.72	0.00	12.76	AVERAGE
2	2390.000	59.27	-14.73	74.00	28.88		6.72	0.00	23.68	PEAK



CH 78 2480MHz

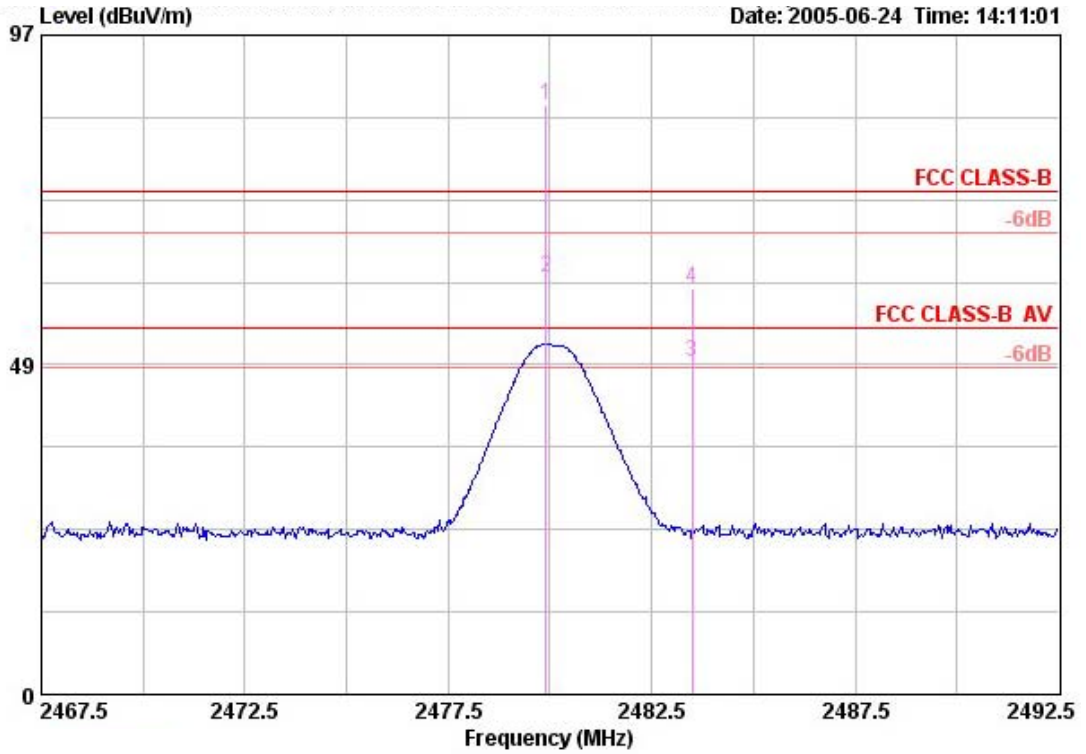

	Freq	Level	Over Limit	Limit	Antenna Line Factor	Cable Loss	Preamp Factor	Read Level	Remark
	MHz	dBuV/m	dB	dBuV/m	dB/m	dB	dB	dBuV	
3 *	2483.500	49.01	-4.99	54.00	28.98	6.94	0.00	13.09	AVERAGE
4	2483.500	59.70	-14.30	74.00	28.98	6.94	0.00	23.78	PEAK



Test Result of Conducted Emission
Modulation Type: GFSK (Channel 00) :

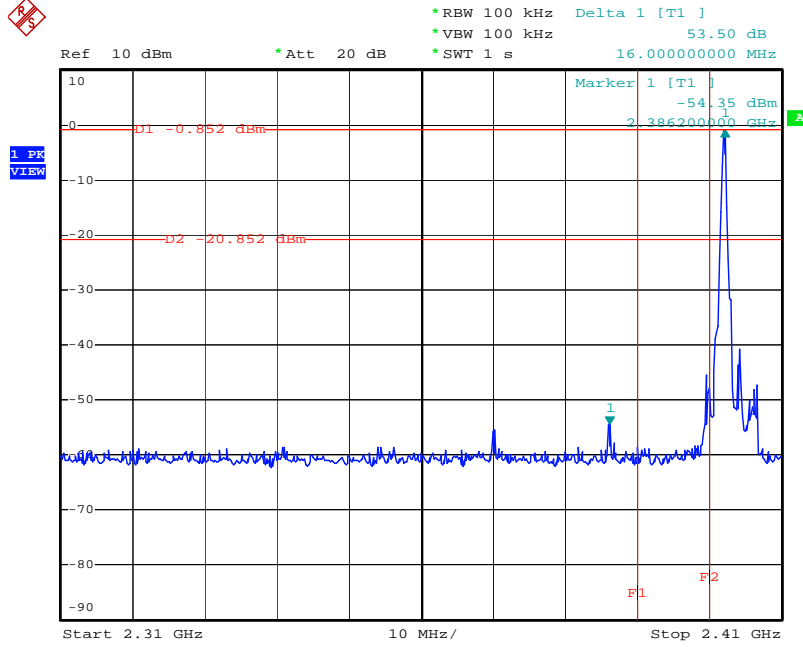

Date: 21.JUN.2005 13:52:46

Modulation Type: GFSK (Channel 78) :

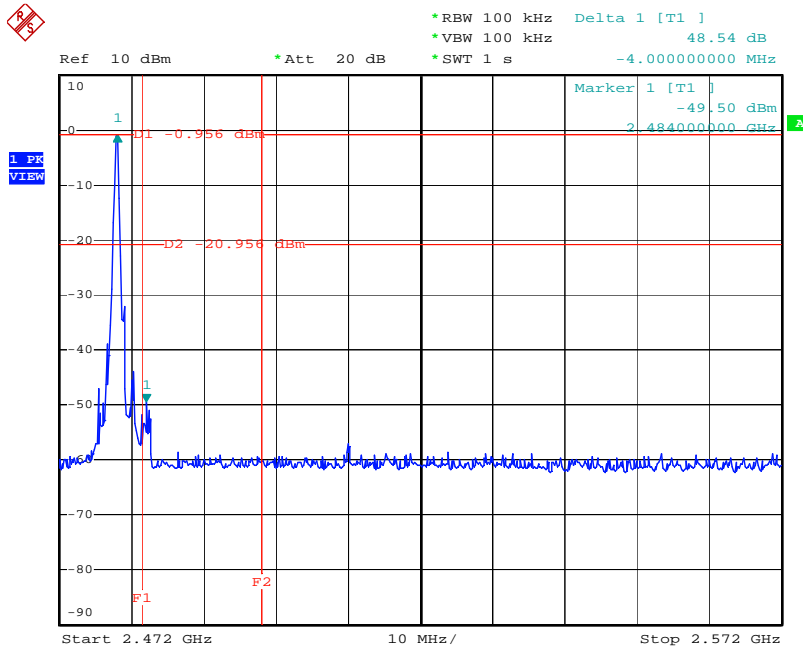

Date: 21.JUN.2005 13:59:35

5.7. Test of AC Power Line Conducted Emission

5.7.1. Applicable Standard

Section 15.207: For a Low-power Radio-frequency Device is designed to be connected to the AC power line, the radio frequency voltage that is conducted back onto the AC power line on any frequency or frequencies within the band 150 kHz to 30 MHz shall not exceed below limits table.

Frequency (MHz)	QP Limit (dBuV)	AV Limit (dBuV)
0.15~0.5	66~56	56~46
0.5~5	56	46
5~30	60	50

5.7.2. Measuring Instruments

Please reference on section 6.

5.7.3. Description of Major Test Instruments Setting

- Test Receiver : R&S ESCS 30
- Attenuation : 10 dB
- Start Frequency : 0.15 MHz
- Stop Frequency : 30 MHz
- IF Bandwidth : 9 KHz

5.7.4. Test Procedures

1. Configure the EUT according to ANSI C63.4.
2. The EUT has to be placed 0.4 meter far from the conducting wall of the shielding room and at least 80 centimeters from any other grounded conducting surface.
3. Connect EUT to the power mains through a line impedance stabilization network (LISN)
4. All the support units are connected to the other LISNs. The LISN should provides 50uH/50ohms coupling impedance.
5. The frequency range from 150 KHz to 30 MHz was searched.
6. Set the test-receiver system to Peak Detect Function and Specified Bandwidth with Maximum Hold Mode.
7. The measurement has to be done between each power line and ground at the power terminal for each RF channel. Only one RF channel has to be investigated since this test is independent with the RF channel selection.

5.7.5. Test Setup Layout

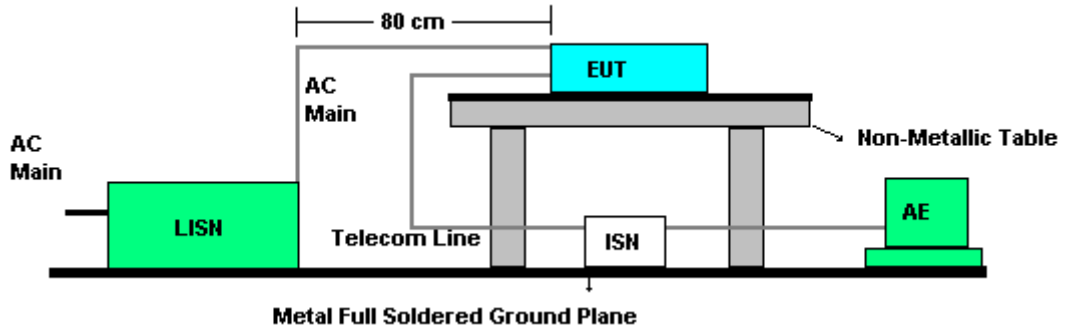

5.7.6. Test Criteria

All test results complied with the requirements of 15.207. Measurement Uncertainty is 2.54dB.



5.7.7. Test Result of Conducted Emission for CH 78 / 2480 MHz

- Modulation Type: GFSK
- Temperature: 18°C
- Relative Humidity: 64%
- Test Engineer: Sky Wu

Line to Ground

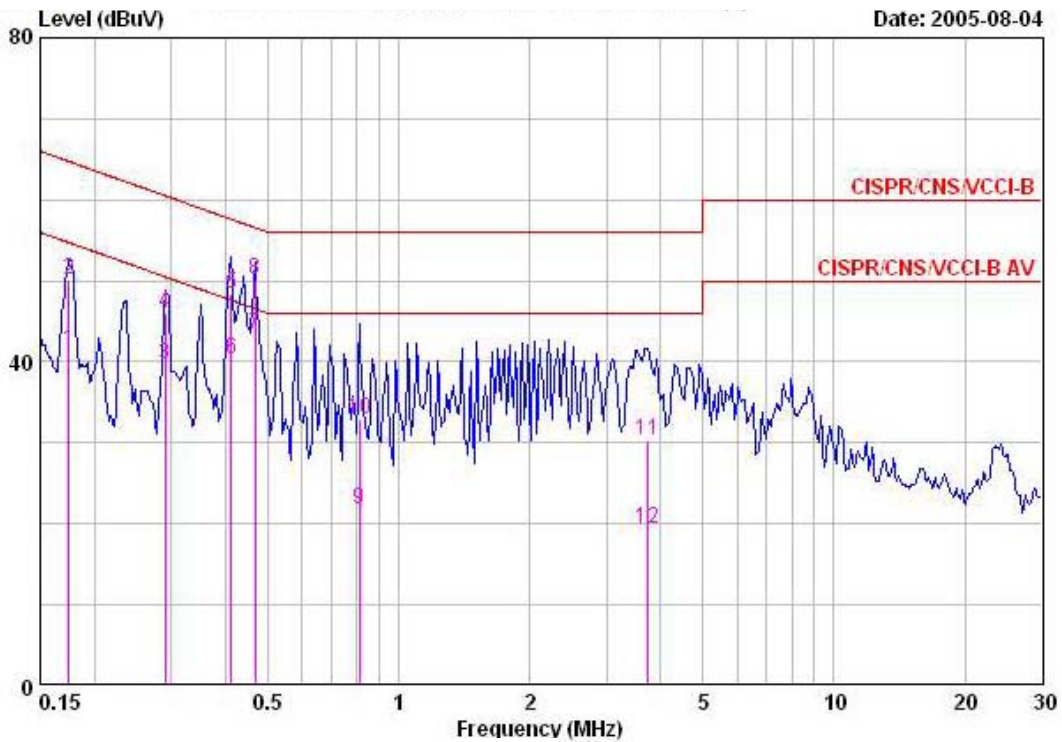

	Freq	Level	Over	Limit	Read	LISN	Cable	Remark
	MHz	dBuV	Limit	Line	Level	Factor	Loss	
			dB	dBuV	dBuV	dB	dB	
1	0.17491	41.41	-13.31	54.72	39.41	1.80	0.20	AVERAGE
2	0.17491	50.18	-14.54	64.72	48.18	1.80	0.20	QP
3	0.29088	39.74	-10.76	50.50	38.74	0.80	0.20	AVERAGE
4	0.29088	46.00	-14.50	60.50	45.00	0.80	0.20	QP
5	0.41266	48.46	-9.13	57.59	47.76	0.50	0.20	QP
6	0.41266	40.40	-7.19	47.59	39.70	0.50	0.20	AVERAGE
7	0.46861	43.34	-3.20	46.54	42.64	0.50	0.20	AVERAGE
8	0.46861	50.20	-6.34	56.54	49.50	0.50	0.20	QP
9	0.81306	21.69	-24.31	46.00	21.19	0.30	0.20	AVERAGE
10	0.81306	32.82	-23.18	56.00	32.32	0.30	0.20	QP
11	3.740	30.27	-25.73	56.00	29.62	0.35	0.30	QP
12	3.740	19.40	-26.60	46.00	18.75	0.35	0.30	AVERAGE



Neutral to Ground

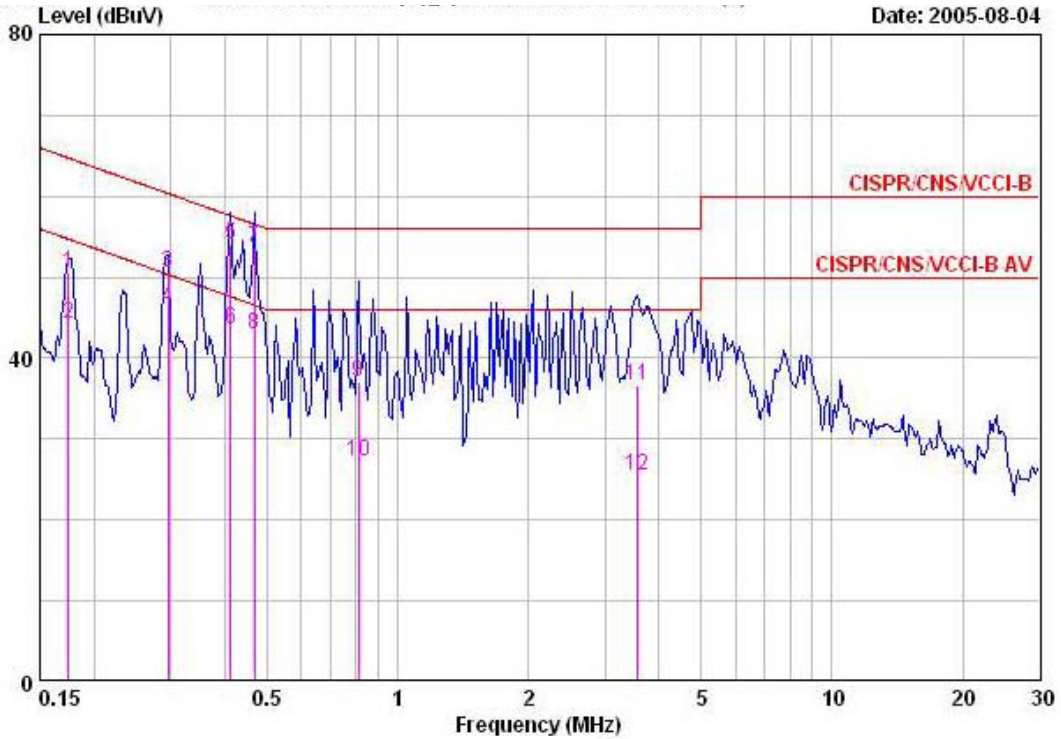

	Freq	Level	Over Limit	Limit Line	Read Level	LISN Factor	Cable Loss	Remark
	MHz	dBuV	dB	dBuV	dBuV	dB	dB	
1	0.17491	50.55	-14.17	64.72	48.75	1.60	0.20	QP
2	0.17491	44.33	-10.39	54.72	42.53	1.60	0.20	AVERAGE
3	0.29555	50.63	-9.73	60.37	49.79	0.64	0.20	QP
4	0.29555	46.11	-4.25	50.37	45.27	0.64	0.20	AVERAGE
5	0.41266	54.14	-3.45	57.59	53.54	0.40	0.20	QP
6	0.41266	43.60	-3.99	47.59	43.00	0.40	0.20	AVERAGE
7	0.46861	53.52	-3.02	56.54	52.92	0.40	0.20	QP
8	0.46861	42.94	-3.60	46.54	42.34	0.40	0.20	AVERAGE
9	0.81306	37.09	-18.91	56.00	36.59	0.30	0.20	QP
10	0.81306	27.35	-18.65	46.00	26.85	0.30	0.20	AVERAGE
11	3.565	36.72	-19.28	56.00	36.12	0.30	0.30	QP
12	3.565	25.42	-20.58	46.00	24.82	0.30	0.30	AVERAGE

Note:

Corrected Reading: Probe (LISN / ISN) Factor + Cable Loss + Read Level = Level.

5.7.8. Photographs of Conducted Emission Test Configuration

FRONT VIEW



REAR VIEW





5.8. Test of Spurious Radiated Emission

5.8.1. Applicable Standard

Section 15.247(d): In any 100 kHz bandwidth outside the frequency band in which the spread spectrum or digitally modulated intentional radiator is operating, the radio frequency power that is produced by the intentional radiator shall be at least 20 dB below that in the 100 kHz bandwidth within the band that contains the highest level of the desired power, based on either an RF conducted or a radiated measurement. In addition, radiated emissions that fall in the restricted bands, as defined in Section 15.205, must also comply with the radiated emission limits specified in Section 15.209.

5.8.2. Measuring Instruments

Please reference on section 6.

5.8.3. Description of Major Test Instruments Setting

- Spectrum Analyzer : R&S FSP40
 - Attenuation : Auto
 - Start Frequency : 1000 MHz
 - Stop Frequency : 10th carrier harmonic
 - RB / VB : 1 MHz / 1MHz for Peak
 - RB / VB : 1 MHz / 10Hz for Average

- Test Receiver : R&S ESCS 30
 - Attenuation : Auto
 - Start Frequency : 30 MHz
 - Stop Frequency : 1000 MHz
 - RB : 120 KHz for QP or PK

5.8.4. Test Procedures

1. Configure the EUT according to ANSI C63.4.
2. The EUT was placed on the top of the turntable 0.8 meter above ground.
3. The phase center of the receiving antenna mounted on the top of a height-variable antenna tower was placed 3 meters far away from the turntable.
4. Power on the EUT and all the supporting units.
5. The turntable was rotated by 360 degrees to determine the position of the highest radiation.
6. The height of the broadband receiving antenna was varied between one meter and four meters above ground to find the maximum emission field strength of both horizontal and vertical polarization.
7. For each suspected emission, the antenna tower was scan (from 1 M to 4 M) and then the turntable was rotated (from 0 degree to 360 degrees) to find the maximum reading.
8. Set the test-receiver system to Peak or CISPR quasi-peak Detect Function with specified bandwidth under Maximum Hold Mode.
9. For emission above 1GHz, use 1MHz VBW and RBW for peak reading. Then 1MHz RBW and 10Hz VBW for average reading in spectrum analyzer.

10. If the emission level of the EUT in peak mode was 3 dB lower than the average limit specified, then testing will be stopped and peak values of EUT will be reported, otherwise, the emissions which do not have 3 dB margin will be repeated one by one using the quasi-peak method for below 1GHz and average method for above the 1GHz. the reported.
11. For testing above 1GHz, the emission level of the EUT in peak mode was 20dB higher than average limit (that means the emission level in peak mode also complies with the limit in average mode), then testing will be stopped and peak values of EUT will be reported, otherwise, the emissions will be measured in average mode again and reported.

5.8.5. Test Setup Layout

For radiated emissions below 30MHz

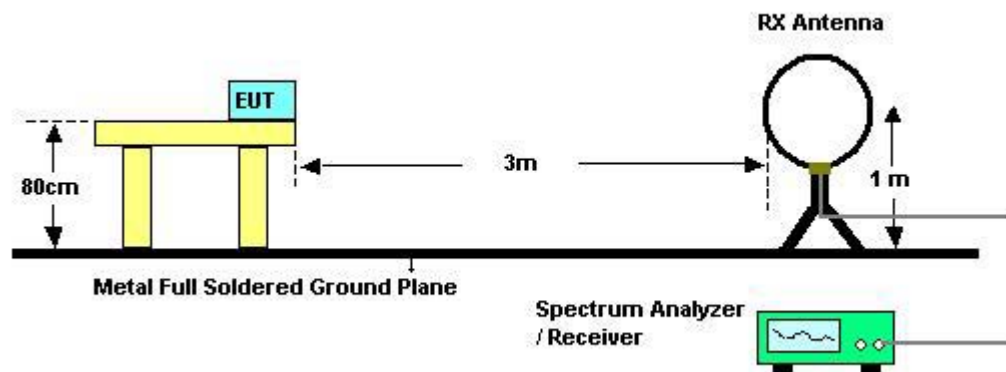

For radiated emissions above 30MHz

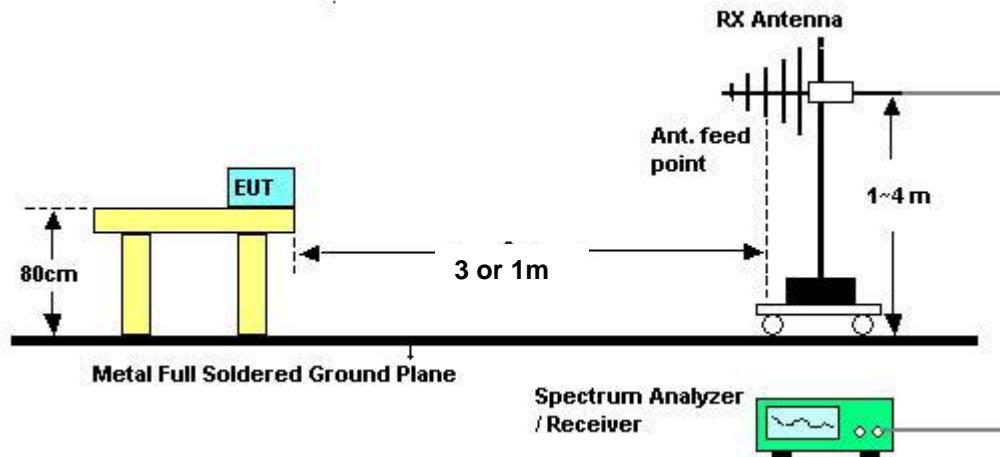

Above 10 GHz shall be extrapolated to the specified distance using an extrapolation factor of 20 dB/decade from 3m to 1m.

Distance extrapolation factor = $20 \log (\text{specific distanc [3m]} / \text{test distance [1m]})$ (dB);

Limit line = specific limits (dBuV) + distance extrapolation factor [9.54 dB].



5.8.6. Test Criteria

All test results complied with the requirements of 15.247(d). Measurement Uncertainty is 2.26dB.

5.8.7. Test Deviation

There are no deviations with the original standard.

5.8.8. EUT Operation during Test

The EUT was programmed to be in continuously transmitting mode.

5.8.9. Results of Radiated Emissions (9kHz~30MHz)

Temperature	18	Humidity	64 %
Test Engineer	Ming Tai, Kao	Configurations	channel 39

Freq. (MHz)	Level (dBuV)	Over Limit (dB)	Limit Line (dBuV)	Remark
-	-	-	-	See Note

Note:

The amplitude of spurious emissions which are attenuated by more than 20 dB below the permissible value has no need to be reported.

Distance extrapolation factor = $40 \log(\text{specific distance} / \text{test distance})$ (dB);

Limit line = specific limits (dBuV) + distance extrapolation factor.



5.8.10. Test Results for CH 78 / 2480 MHz (for emission below 1GHz)

- Modulation Type: GFSK
- Temperature: 18°C
- Relative Humidity: 64%
- Duty Cycle of the Equipment During the Test: 50.00%
- Test Engineer: Ming Tai, Kao

(A) Polarization: Horizontal

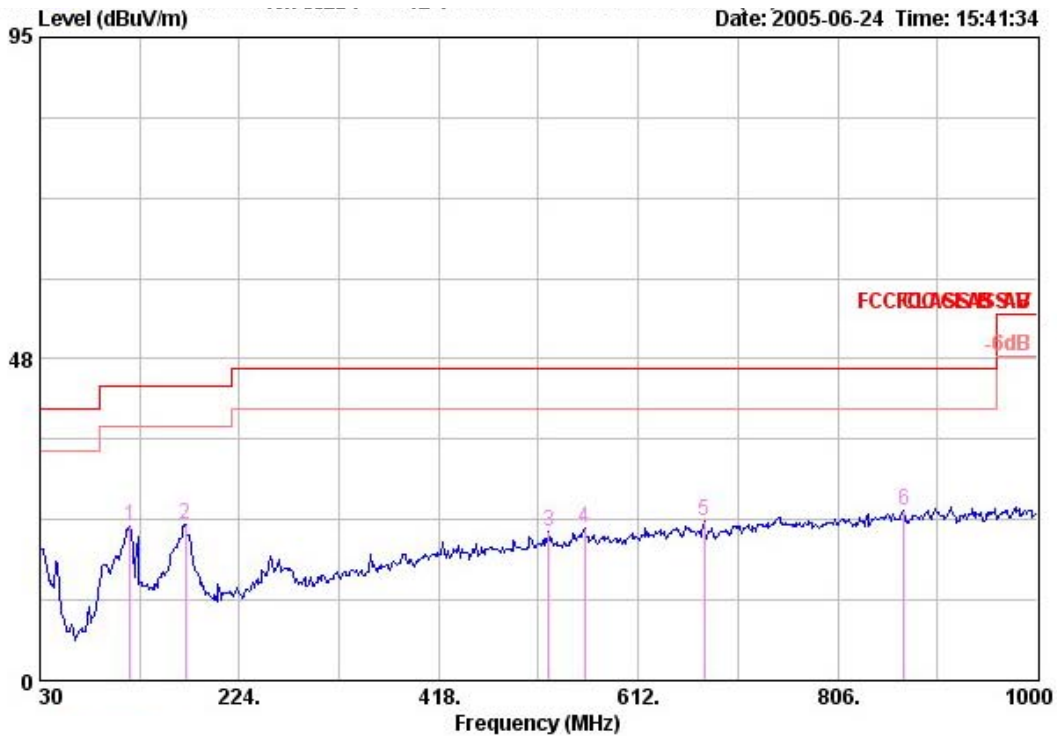

	Freq	Level	Over Limit	Limit	Antenna Line Factor	Cable Loss	Preamp Factor	Read Level	Remark
	MHz	dBuV/m	dB	dBuV/m	dB/m	dB	dB	dBuV	
1	117.300	22.80	-20.70	43.50	11.37	1.53	31.75	41.65	Peak
2	171.620	23.16	-20.34	43.50	8.78	1.87	31.58	44.10	Peak
3	524.700	22.13	-23.87	46.00	17.56	3.25	30.85	32.16	Peak
4	559.620	22.40	-23.60	46.00	18.50	3.18	30.75	31.47	Peak
5	676.020	23.61	-22.39	46.00	18.72	3.55	30.41	31.76	Peak
6	870.020	25.21	-20.79	46.00	20.54	4.04	29.95	30.58	Peak



(B) Polarization: Vertical

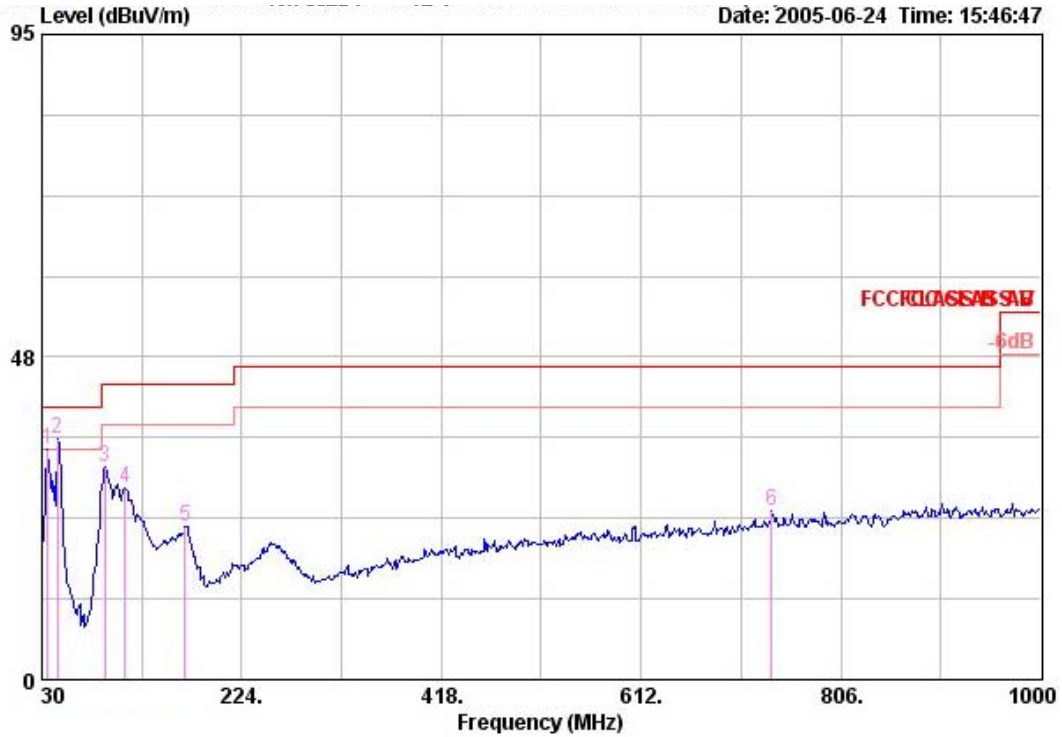

	Freq	Level	Over Limit	Limit	Antenna Line Factor	Cable Loss	Preamp Factor	Read Level	Remark
	MHz	dBuV/m	dB	dBuV/m	dB/m	dB	dB	dBuV	
1	35.820	33.92	-6.08	40.00	14.50	1.20	31.70	49.92	Peak
2	44.550	35.58	-4.42	40.00	10.40	1.10	31.75	55.83	Peak
3	91.110	31.30	-12.20	43.50	9.00	1.43	31.59	52.46	Peak
4	110.510	28.17	-15.33	43.50	11.30	1.50	31.74	47.10	Peak
5	168.710	22.58	-20.92	43.50	9.08	1.90	31.57	43.17	Peak
6	739.070	24.79	-21.21	46.00	20.00	3.84	30.32	31.28	Peak

Note:

Emission level (dBUV/m) = 20 log Emission level (uV/m)

Corrected Reading: Probe Factor + Cable Loss + Read Level - Preamp Factor = Level



5.8.11. Test Results for CH 00 / 2402 MHz (for emission above 1GHz)

- Modulation Type: GFSK
- Temperature: 18°C
- Relative Humidity: 64%
- Duty Cycle of the Equipment During the Test: 50.00%
- Test Engineer: Ming Tai, Kao

(A) Polarization: Horizontal

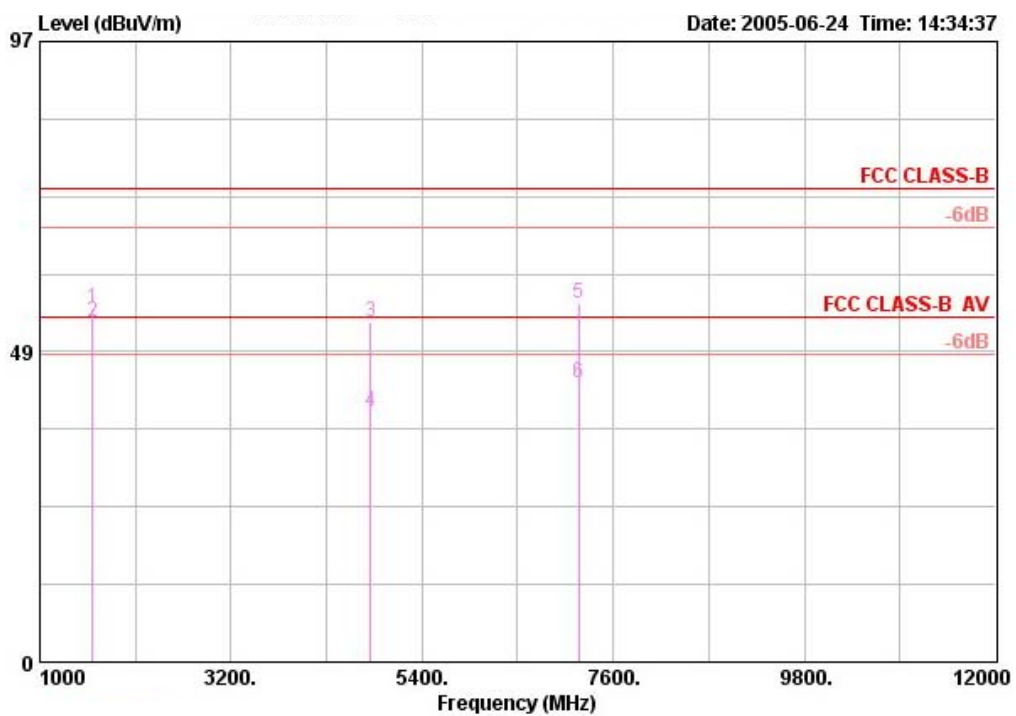

	Freq	Level	Over	Limit	Antenna	Cable	Preamp	Read	Remark
	MHz	dBuV/m	dB	dBuV/m	dB/m	dB	dB	dBuV	
1	1601.970	55.22	-18.78	74.00	25.92	6.22	34.72	57.80	PEAK
2	1601.970	53.17	-0.83	54.00	25.92	6.22	34.72	55.75	AVERAGE
3	4804.050	53.09	-20.91	74.00	32.81	12.62	35.17	42.82	PEAK
4	4804.050	39.23	-14.77	54.00	32.81	12.62	35.17	28.96	AVERAGE
5	7206.030	55.92	-18.08	74.00	35.88	13.25	35.21	41.99	PEAK
6	7206.030	43.62	-10.38	54.00	35.88	13.25	35.21	29.70	AVERAGE



(B) Polarization: Vertical

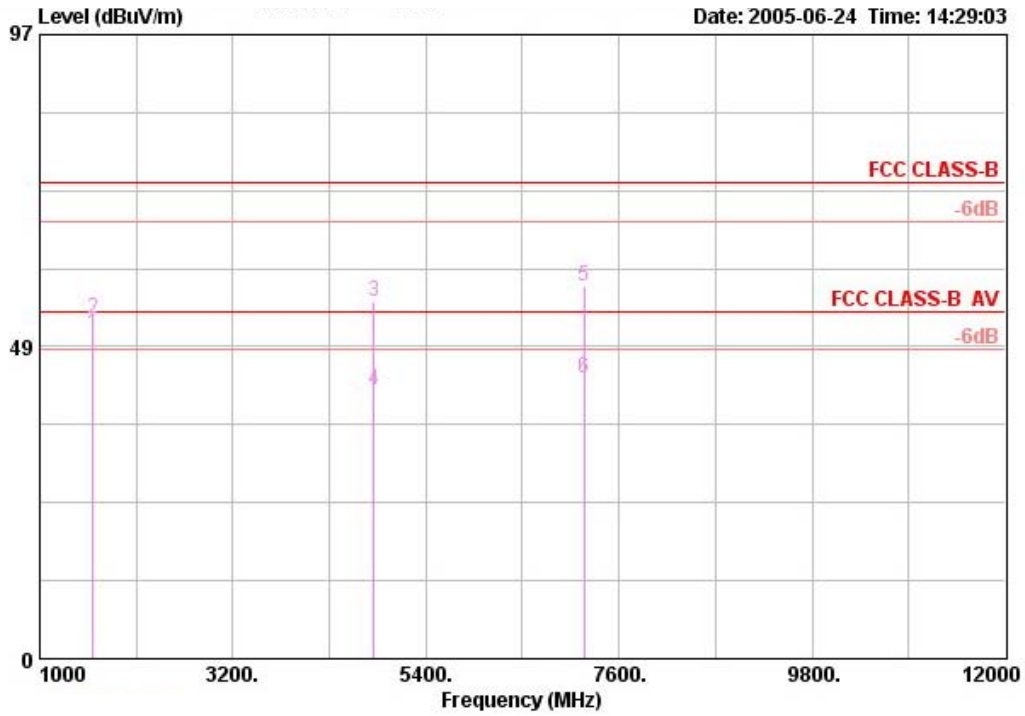

	Freq	Level	Over	Limit	Antenna	Cable	Preamp	Read	Remark
	MHz	dBuV/m	dB	dBuV/m	dB/m	dB	dB	dBuV	
1	1602.035	50.53	-3.47	54.00	25.92	6.22	34.72	53.11	AVERAGE
2	1602.045	52.85	-21.15	74.00	25.92	6.22	34.72	55.43	PEAK
3	4803.930	55.43	-18.57	74.00	32.81	12.62	35.17	45.17	PEAK
4	4803.930	41.85	-12.15	54.00	32.81	12.62	35.17	31.59	AVERAGE
5	7206.152	57.75	-16.25	74.00	35.88	13.25	35.21	43.83	PEAK
6	7206.152	43.74	-10.26	54.00	35.88	13.25	35.21	29.82	AVERAGE

Note:

Emission level (dBuV/m) = 20 log Emission level (uV/m)

Corrected Reading: Probe Factor + Cable Loss + Read Level - Preamp Factor = Level



5.8.12. Test Results for CH 39 / 2441 MHz (for emission above 1GHz)

- Modulation Type: GFSK
- Temperature: 18°C
- Relative Humidity: 64%
- Duty Cycle of the Equipment During the Test: 50.00%
- Test Engineer: Ming Tai, Kao

(A) Polarization: Horizontal

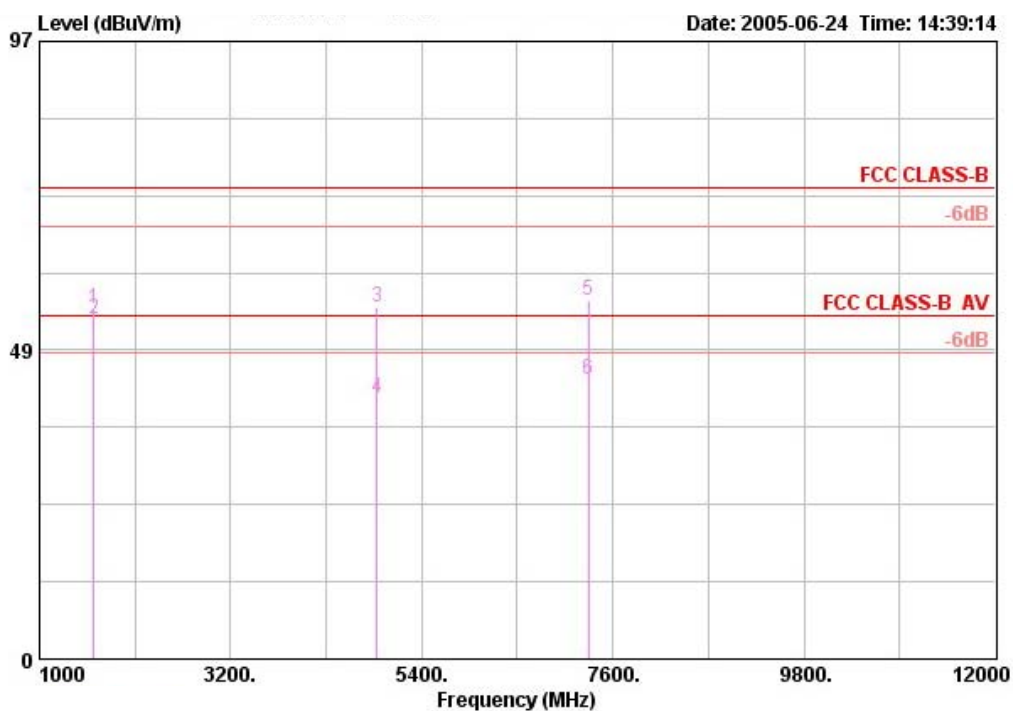

	Freq	Level	Over	Limit	Antenna	Cable	Preamp	Read	Remark
	MHz	dBuV/m	dB	dBuV/m	dB/m	dB	dB	dBuV	
1	1627.990	55.10	-18.90	74.00	26.13	6.22	34.73	57.48	PEAK
2	1627.990	53.29	-0.71	54.00	26.13	6.22	34.73	55.68	AVERAGE
3	4881.962	55.13	-18.87	74.00	32.88	12.67	35.15	44.73	PEAK
4	4881.962	41.08	-12.92	54.00	32.88	12.67	35.15	30.68	AVERAGE
5	7322.991	56.32	-17.68	74.00	36.22	13.23	35.18	42.06	PEAK
6	7322.991	43.78	-10.22	54.00	36.22	13.23	35.18	29.52	AVERAGE



(B) Polarization: Vertical

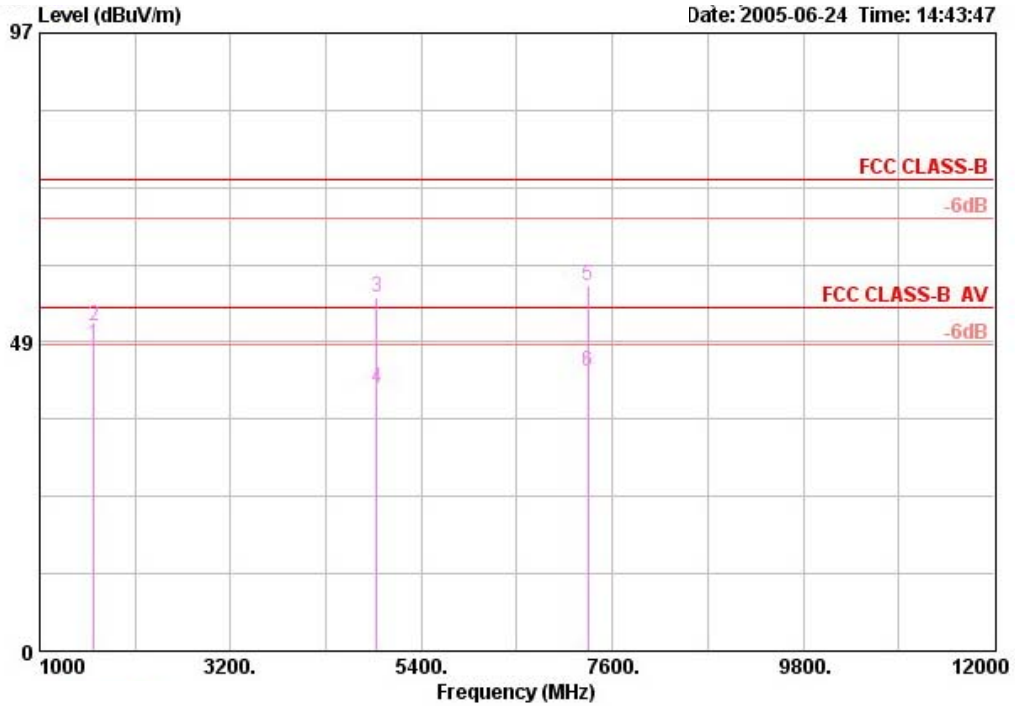

	Freq	Level	Over Limit	Limit	Antenna Line	Factor	Cable Loss	Preamp Factor	Read Level	Remark
	MHz	dBuV/m	dB	dBuV/m	dB/m		dB	dB	dBuV	
1	1628.030	48.06	-5.94	54.00	26.13	6.22	34.73	50.44	AVERAGE	
2	1628.030	51.05	-22.95	74.00	26.13	6.22	34.73	53.43	PEAK	
3	4882.090	55.54	-18.46	74.00	32.88	12.67	35.15	45.14	PEAK	
4	4882.090	41.34	-12.66	54.00	32.88	12.67	35.15	30.94	AVERAGE	
5	7322.981	57.27	-16.73	74.00	36.22	13.23	35.18	43.01	PEAK	
6	7322.981	43.76	-10.24	54.00	36.22	13.23	35.18	29.50	AVERAGE	

Note:

Emission level (dBuV/m) = 20 log Emission level (uV/m)

Corrected Reading: Probe Factor + Cable Loss + Read Level - Preamp Factor = Level



5.8.13. Test Results for CH 78 / 2480 MHz (for emission above 1GHz)

- Modulation Type: GFSK
- Temperature: 18°C
- Relative Humidity: 64%
- Duty Cycle of the Equipment During the Test: 50.00%
- Test Engineer: Ming Tai, Kao

(A) Polarization: Horizontal

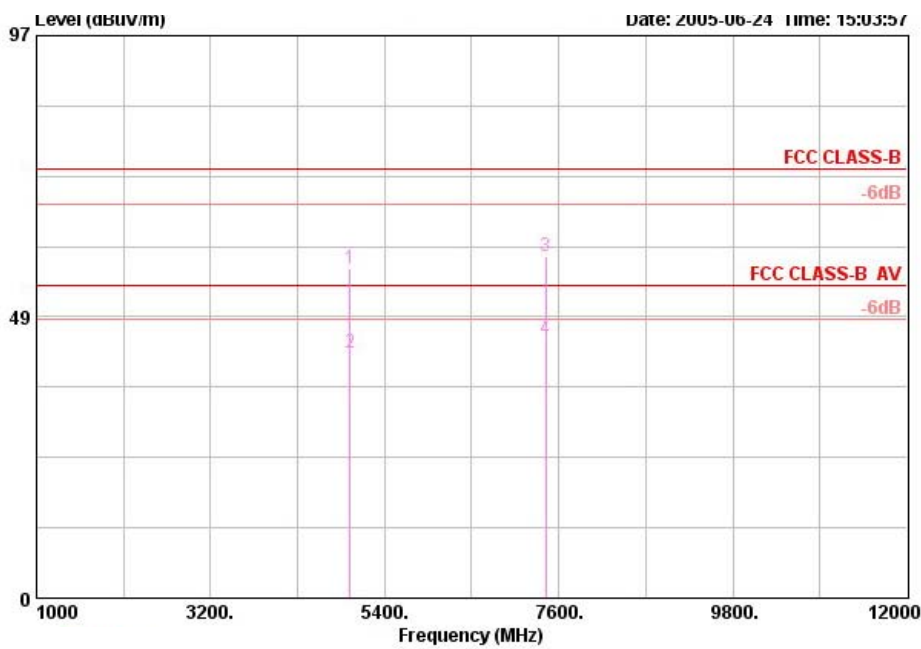

	Freq	Level	Over Limit	Limit Line	ReadAntenna Level	Antenna Factor	Cable Loss	Preamp Factor	Remark	Ant Pos	Table Pos
	MHz	dBuV/m	dB	dBuV/m	dBuV	dB/m	dB	dB		cm	deg
1	4959.800	56.81	-17.19	74.00	46.26	32.97	12.72	35.14	PEAK	---	---
2	4959.800	42.27	-11.73	54.00	31.73	32.97	12.72	35.14	AVERAGE	---	---
3	7440.037	58.96	-15.04	74.00	44.35	36.56	13.20	35.15	PEAK	---	---
4	7440.037	44.54	-9.46	54.00	29.93	36.56	13.20	35.15	AVERAGE	---	---



(B) Polarization: Vertical

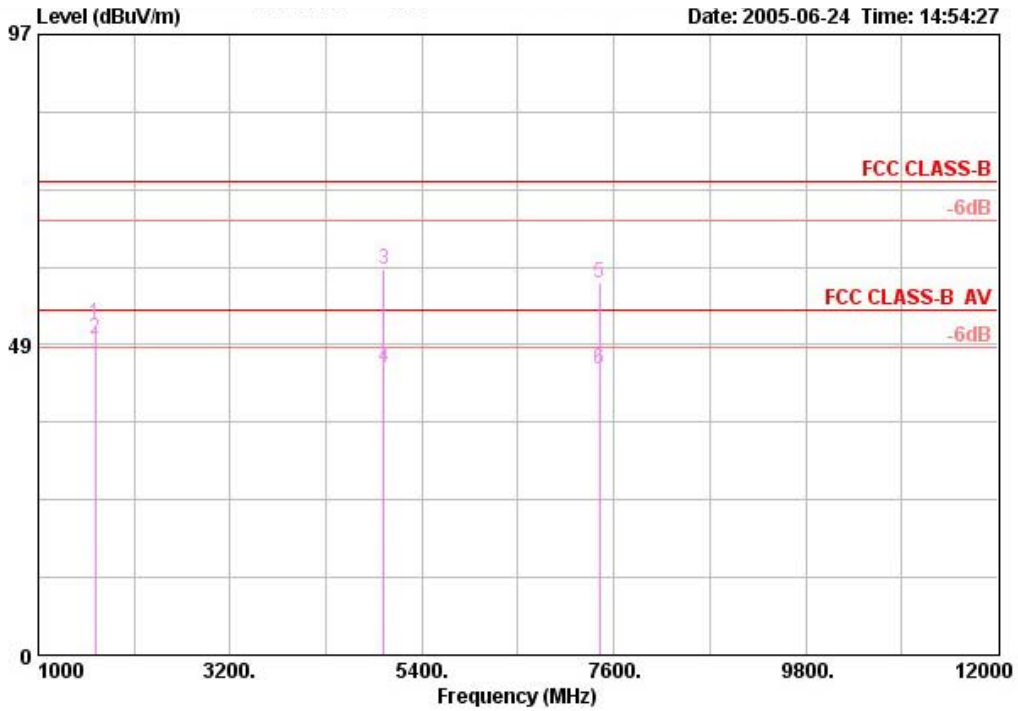

	Freq	Level	Over Limit	Limit	Antenna Line	Factor	Cable Loss	Preamp Factor	Read Level	Remark
	MHz	dBuV/m	dB	dBuV/m	dB/m		dB	dB	dBuV	
1	1654.000	51.74	-22.26	74.00	26.23		6.29	34.74	53.96	PEAK
2	1654.000	49.45	-4.55	54.00	26.23		6.29	34.74	51.67	AVERAGE
3	4959.930	60.19	-13.81	74.00	32.97		12.72	35.14	49.65	PEAK
4	4959.930	44.88	-9.12	54.00	32.97		12.72	35.14	34.33	AVERAGE
5	7439.989	58.24	-15.76	74.00	36.56		13.20	35.15	43.63	PEAK
6	7439.989	44.56	-9.44	54.00	36.56		13.20	35.15	29.95	AVERAGE

Note:

Emission level (dBuV/m) = 20 log Emission level (uV/m)

Corrected Reading: Probe Factor + Cable Loss + Read Level - Preamp Factor = Level

5.8.14. Photographs of Radiated Emission Test Configuration

FRONT VIEW



REAR VIEW





5.9. Antenna Requirements

5.9.1. Standard Applicable

Section 15.203:

An intentional radiator shall be designed to ensure that no antenna other than that furnished by the responsible party shall be used with the device. The use of a permanently attached antenna or of an antenna that uses a unique coupling to the intentional radiator shall be considered sufficient to comply with the provisions of this Section. The manufacturer may design the unit so that a broken antenna can be replaced by the user, but the use of a standard antenna jack or electrical connector is prohibited.

Section 15.247(b)/(c):

If transmitting antennas of directional gain greater than 6 dBi are used, the peak output power from the intentional radiator shall be reduced by the amount in dB that the directional gain of the antenna exceeds 6 dBi.

If the intentional radiator is used exclusively for fixed, point-to-point operations may employ transmitting antennas with directional gain greater than 6 dBi provided the maximum peak output power of the intentional radiator is reduced by 1 dB for every 3 dB that the directional gain of the antenna exceeds 6 dBi.

5.9.2. Antenna Connected Construction

There is no antenna connector for chip antenna.

5.9.3. Antenna Gain

All antenna gain of EUT is less than 6dBi. Therefore peak conducted power limit shall not be degraded any more. Antenna report of manufacturer will have more detail antenna gain or antenna pattern.

5.9.4. Test Criteria

All test results complied with the requirements of 15.203/15.247(b)/(c).

6. List of Measuring Equipments Used

Items	Instrument	Manufacturer	Model No.	Serial No.	Characteristics	Calibration Date	Remark
1	EMC Receiver	R&S	ESCS 30	100174	9kHz – 2.75GHz	Feb. 16, 2005	Conduction (CO04-HY)
2	LISN	MessTec	NNB-2/16Z	2001/004	9kHz – 30MHz	Apr. 20, 2005	Conduction (CO04-HY)
3	LISN (Support Unit)	MessTec	NNB-2/16Z	99041	9kHz – 30MHz	May. 05, 2005	Conduction (CO04-HY)
4	RF Cable-CON	UTIFLEX	3102-26886-4	CB049	9kHz – 30MHz	Apr. 20, 2005	Conduction (CO04-HY)
5	EMI Filter	LINDGREN	LRE-2030	2651	< 450 Hz	N/A	Conduction (CO04-HY)
6	3m Semi Anechoic Chamber	SIDT FRANKONIA	SAC-3M	03CH03-HY	30MHz ~ 1GHz 3m	Jun. 16, 2005	Radiation (03CH03-HY)
7	Spectrum analyzer	R&S	FSP40	100004	9KHZ ~ 40GHz	Aug. 31, 2004	Radiation (03CH03-HY)
8	Amplifier	SCHAFFNER	CPA9231A	18667	9KHz ~ 2GHz	Jan. 10, 2005	Radiation (03CH03-HY)
9	Amplifier	Agilent	8449B	3008A02120	1GHz ~ 26.5GHz	May 31, 2005	Radiation (03CH03-HY)
10	Amplifier	MITEQ	AMF-6F-260400	923364	26.5GHz ~ 40GHz	Jan. 05, 2004*	Radiation (03CH03-HY)
11	Loop Antenna	R&S	HFH2-Z2	860004/001	9kHz ~ 30MHz	May 24, 2004*	Radiation (03CH03-HY)
12	Biconical Antenna	SCHWARZBECK	VHBB 9124	301	30MHz ~ 200MHz	Jul. 22, 2005	Radiation (03CH03-HY)
13	Log Antenna	SCHWARZBECK	VUSLP 9111	221	200MHz ~ 1GHz	Jul. 22, 2005	Radiation (03CH03-HY)
14	Horn Antenna	EMCO	3115	6741	1GHz ~ 18GHz	Apr. 22, 2005	Radiation (03CH03-HY)
15	Horn Antenna	SCHWARZBECK	BBHA9170	BBHA9170154	15GHz ~ 40GHz	Jun. 09, 2004*	Radiation (03CH03-HY)
16	RF Cable-R03m	Jye Bao	RG142	CB021	30MHz ~ 1GHz	Feb. 22, 2005	Radiation (03CH03-HY)
17	RF Cable-HIGH	SUHNER	SUCOFLEX 106	03CH03-HY	1GHz ~ 40GHz	Dec.01, 2004	Radiation (03CH03-HY)
18	Turn Table	HD	DS 420	420/650/00	0 ~ 360 degree	N/A	Radiation (03CH03-HY)
19	Antenna Mast	HD	MA 240	240/560/00	1 m - 4 m	N/A	Radiation (03CH03-HY)

Calibration Interval of instruments listed above is one year.



Items	Instrument	Manufacturer	Model No.	Serial No.	Characteristics	Calibration Date	Remark
1	Spectrum analyzer	R&S	FSP30	100023	9kHz ~ 30GHz	Aug. 02, 2004	Conducted (TH01-HY)
2	Power meter	R&S	NRVS	100444	DC ~ 40GHz	Jul. 06, 2005	Conducted (TH01-HY)
3	Power sensor	R&S	NRV-Z55	100049	DC ~ 40GHz	Jul. 06, 2005	Conducted (TH01-HY)
4	Power Sensor	R&S	NRV-Z32	100057	30MHz ~ 6GHz	Apr. 28, 2005	Conducted (TH01-HY)
5	AC power source	HPC	HPA-500W	HPA-9100024	AC 0 ~ 300V	Apr. 21, 2005	Conducted (TH01-HY)
6	DC power source	G.W.	GPC-6030D	C671845	DC 1V ~ 60V	Nov. 28, 2004	Conducted (TH01-HY)
7	Temp. and Humidity Chamber	KSON	THS-C3L	612	N/A	Oct. 01, 2004	Conducted (TH01-HY)
8	RF CABLE-1m	Jye Bao	RG142	CB034-1m	20MHz ~ 7GHz	Jan. 01, 2005	Conducted (TH01-HY)
9	RF CABLE-2m	Jye Bao	RG142	CB035-2m	20MHz ~ 1GHz	Jan. 01, 2005	Conducted (TH01-HY)
10	Oscilloscope	Tektronix	TDS1012	CO38515	100MHz / 1GS/s	Apr. 15, 2005	Conducted (TH01-HY)
11	Signal Generator	R&S	SMR40	100116	10MHz ~ 40GHz	Dec. 31, 2004	Conducted (TH01-HY)
12	Data Generator	Tektronix	DG2030	063-2920-50	0.1Hz~400MHz	Jun. 02, 2005	Conducted (TH01-HY)

Calibration Interval of instruments listed above is one year.



7. Company Profile

SPORTON Lab. was established in 1986 with one shielded room: the first private EMI test facility, offering local manufacturers an alternative EMI test facility apart from ERSO. In 1988, one 3M and 10M/3M open area test site were setup and also obtained official accreditation from FCC, VCCI and NEMKO. In 1993, a Safety laboratory was founded and obtained accreditation from UL of USA, CSA of Canada and TUV (Rhineland & PS) of Germany. In 1995, one EMC lab, including EMI and EMS test facilities was setup. In 1997, SPORTON Group has provided financial expense to relocate the headquarter to Orient Scientific Park in Taipei Hsien to offer more comprehensive, more qualified and better service to local suppliers and manufactures. In 1999, Safety Group and Component Group were setup. In 2001, SPORTON has established 3M/10M chamber in Hwa Ya Technology Park.

7.1. Certificate of Accreditation

Taiwan	BSMI, CNLA, DGT
USA	FCC, NVLAP, UL
EU	Nemko, TUV
Japan	VCCI
Canada	Industry Canada

7.2. Test Location

SHIJR	ADD : 6Fl., No. 106, Sec. 1, Shintai 5th Rd., Shijr City, Taipei, Taiwan 221, R.O.C. TEL : 02-2696-2468 FAX : 02-2696-2255
HWA YA	ADD : No. 52, Hwa Ya 1st Rd., Hwa Ya Technology Park, Kwei-Shan Hsiang, Tao Yuan Hsien, Taiwan, R.O.C. TEL : 03-327-3456 FAX : 03-318-0055
LINKOU	ADD : No. 30-2, Dingfu Tsuen, Linkou Shiang, Taipei, Taiwan 244, R.O.C TEL : 02-2601-1640 FAX : 02-2601-1695
DUNGHU	ADD : No. 3, Lane 238, Kangle St., Neihu Chiu, Taipei, Taiwan 114, R.O.C. TEL : 02-2631-4739 FAX : 02-2631-9740
JUNGHE	ADD : 7Fl., No. 758, Jungjeng Rd., Junghe City, Taipei, Taiwan 235, R.O.C. TEL : 02-8227-2020 FAX : 02-8227-2626
NEIHU	ADD : 4Fl., No. 339, Hsin Hu 2 nd Rd., Taipei 114, Taiwan, R.O.C. TEL : 02-2794-8886 FAX : 02-2794-9777



8. Certificate of NVLAP Accreditation

United States Department of Commerce
National Institute of Standards and Technology

NVLAP[®]

ISO/IEC 17025:1999
ISO 9002:1994

Certificate of Accreditation



SPORTON INTERNATIONAL, INC.
TAIPEI HSIEN 221
TAIWAN

*is recognized by the National Voluntary Laboratory Accreditation Program
for satisfactory compliance with criteria set forth in NIST Handbook 150:2001,
all requirements of ISO/IEC 17025:1999, and relevant requirements of ISO 9002:1994.
Accreditation is awarded for specific services, listed on the Scope of Accreditation, for:*

ELECTROMAGNETIC COMPATIBILITY AND TELECOMMUNICATIONS

December 31, 2005

Effective through

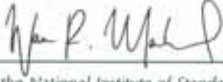
For the National Institute of Standards and Technology
NVLAP Lab Code: 200079-0

NVLAP-01C (06-01)