



**Spectrum Research & Testing Lab., Inc.**  
No. 101-10, Ling 8,  
Shan-Tong Li,  
Chung-Li City,  
Taoyuan, Taiwan

# TEST REPORT

Reference No.:A04031803  
Report No.:FCCA04031803  
FCC ID:PQY-4710874200425  
Page:1 of 47  
Date:Jun. 01, 2004

Product Name: Bluetooth Handsfree Car Kit  
Model Number: BTHF-6200, BTHF-6200-L  
Applicant: CELLINK CO., LTD.  
11F, NO.102, SEC.1, HSIN TAI WU RD., HSI-CHIH,  
TAIPEI, TAIWAN, R.O.C.  
Date of Receipt: Mar. 18, 2004  
Finished date of Test: May 27, 2004  
Applicable Standards: 47 CFR Part 15, Subpart C  
ANSI C63.4:2003  
Public DA00-705 (March 2000)

We, **Spectrum Research & Testing Laboratory Inc.**, hereby certify that one sample of the above was tested in our laboratory with positive results according to the above-mentioned standards. The records in the report are an accurate account of the results. Details of the results are given in the subsequent pages of this report.

Checked By : Ken Su for , Date: 06 / 01 / 2004  
( Sunyou Chen )

Approved By : JH , Date: 6/1/2004  
( Johnson Ho, Director )



Lab Code: 200099-0



## TABLE OF CONTENTS

1. DOCUMENT POLICY AND TEST STATEMENT.....	4
1.1 DOCUMENT POLICY.....	4
1.2 TEST STATEMENT.....	4
2. DESCRIPTION OF EUT AND TEST MODE.....	5
2.1 GENERAL DESCRIPTION OF EUT.....	5
2.2 DESCRIPTION OF EUT INTERNAL DEVICE.....	5
2.3 DESCRIPTION OF TEST MODE.....	6
2.4 DESCRIPTION OF SUPPORT UNIT.....	6
3. DESCRIPTION OF APPLIED STANDARDS.....	7
4. CONDUCTED EMISSION TEST.....	8
4.1 CONDUCTED EMISSION LIMIT.....	8
4.2 TEST EQUIPMENT.....	8
4.3 TEST SETUP.....	9
4.4 TEST PROCEDURE.....	9
4.5 EUT OPERATING CONDITION.....	9
4.6 TEST RESULT.....	10
4.2 CHANNEL SEPARATION TEST.....	13
4.2.1 LIMIT.....	13
4.2.2 TEST EQUIPMENT.....	13
4.2.3 TEST SET-UP.....	13
4.2.4 TEST PROCEDURE.....	13
4.2.5 EUT OPERATING CONDITION.....	13
4.2.6 TEST RESULT.....	14
4.3 QUANTITY OF HOPPING CHANNEL TEST.....	16
4.3.1 LIMIT.....	16
4.3.2 TEST EQUIPMENT.....	16
4.3.3 TEST SET-UP.....	16
4.3.4 TEST PROCEDURE.....	16
4.3.5 EUT OPERATING CONDITION.....	16
4.3.6 TEST RESULT.....	17
4.4 20DB BANDWIDTH.....	18
4.4.1 LIMIT.....	18
4.4.2 TEST EQUIPMENT.....	18
4.4.3 TEST SET-UP.....	18
4.4.4 TEST PROCEDURE.....	18
4.4.5 EUT OPERATING CONDITION.....	18
4.4.6 TEST RESULT.....	19
4.5 TIME OF OCCUPANCY (DWELL TIME).....	21
4.5.1 LIMIT.....	21
4.5.2 TEST EQUIPMENT.....	21
4.5.3 TEST SET-UP.....	21



**Spectrum Research &  
Testing Lab., Inc.**  
No. 101-10, Ling 8,  
Shan-Tong Li,  
Chung-Li City,  
Taoyuan, Taiwan

## TEST REPORT

Reference No.:A04031803  
Report No.:FCCA04031803  
FCC ID:PQY-4710874200425  
Page:3 of 47  
Date:Jun. 01, 2004

4.5.4	TEST PROCEDURE .....	21
4.5.5	EUT OPERATING CONDITION .....	21
4.5.6	TEST RESULT .....	22
4.6	PEAK POWER TEST .....	26
4.6.1	LIMIT .....	26
4.6.2	TEST EQUIPMENT.....	26
4.6.3	TEST SET-UP .....	27
4.6.4	TEST PROCEDURE .....	27
4.6.5	EUT OPERATING CONDITION .....	27
4.6.6	TEST RESULT .....	27
4.7	BAND EDGE TEST .....	30
4.7.1	LIMIT .....	30
4.7.2	TEST EQUIPMENT.....	31
4.7.3	TEST SET-UP .....	32
4.7.4	TEST PROCEDURE .....	33
4.7.5	EUT OPERATING CONDITION .....	33
4.7.6	TEST RESULT .....	33
4.8	SPURIOUS RADIATED EMISSION TEST .....	35
4.8.1	LIMIT .....	35
4.8.2	TEST EQUIPMENT.....	36
4.8.3	TEST SET-UP .....	37
4.8.4	TEST PROCEDURE .....	38
4.8.5	EUT OPERATING CONDITION .....	38
4.8.6	TEST RESULT .....	39
3.	ANTENNA APPLICATION.....	43
5.1	ANTENNA REQUIREMENT .....	43
5.2	RESULT .....	43
6.	PHOTOS OF TESTING .....	44
7.	TERMS OF ABRIVATION .....	47



**Spectrum Research &  
Testing Lab., Inc.**  
No. 101-10, Ling 8,  
Shan-Tong Li,  
Chung-Li City,  
Taoyuan, Taiwan

## **TEST REPORT**

Reference No.:A04031803  
Report No.:FCCA04031803  
FCC ID:PQY-4710874200425  
Page:4 of 47  
Date:Jun. 01, 2004

### **1. DOCUMENT POLICY AND TEST STATEMENT**

#### **1.1 DOCUMENT POLICY**

- The report shall not be reproduced except in full, without the written approval of SRT Lab, Inc.
- The report must not be used by the applicant to claim that the product is endorsed by NVLAP.
- The NVLAP logo applies only to the applicable standards specified in this report.

#### **1.2 TEST STATEMENT**

- The test results in the report apply only to the unit tested by SRT Lab.
- There was no deviation from the requirements of test standards during the test.
- AC power source, 120 VAC/60 Hz, was used during the test.



Spectrum Research &  
Testing Lab., Inc.  
No. 101-10, Ling 8,  
Shan-Tong Li,  
Chung-Li City,  
Taoyuan, Taiwan

## TEST REPORT

Reference No.:A04031803  
Report No.:FCCA04031803  
FCC ID:PQY-4710874200425  
Page:5 of 47  
Date:Jun. 01, 2004

## 2. DESCRIPTION OF EUT AND TEST MODE

### 2.1 GENERAL DESCRIPTION OF EUT

<b>PRODUCT</b>	Bluetooth Handsfree Car Kit
<b>MODEL NO.</b>	BTHF-6200, BTHF-6200-L
<b>POWER SUPPLY</b>	DC 9.2V, 400mA
<b>CABLE</b>	N/A
<b>I/O PORT</b>	N/A
<b>FREQUENCY BAND</b>	2400 ~ 2483.5MHz
<b>CARRIER FREQUENCY</b>	CH0: 2402MHz ~ CH78: 2480MHz
<b>NUMBER OF CHANNEL</b>	79
<b>CHANNEL SPACING</b>	1MHz
<b>RATED RF OUTPUT POWER</b>	0dBm
<b>I.F. &amp; L.O.</b>	I.F.: 0MHz
<b>MODULATION TYPE</b>	GFSK
<b>MODE OF OPERATION</b>	Duplex
<b>DUTY CYCLE</b>	50%
<b>BIT RATE OF TRANSMISSION</b>	723Kbps
<b>ANTENNA TYPE</b>	PCB antenna
<b>ANTENNA GAIN</b>	1dBi

**NOTE :** The EUT has two model numbers as above on market. They are identical in all aspects except for the BTHF-6200-L without panel.

For more detailed features, please refer to the manufacturer's specification or User's Manual of EUT.

### 2.2 DESCRIPTION OF EUT INTERNAL DEVICE

DEVICE	BRAND / MAKER	MODEL #	FCC ID/DOC	REMARK
N/A				



**Spectrum Research & Testing Lab., Inc.**  
No. 101-10, Ling 8,  
Shan-Tong Li,  
Chung-Li City,  
Taoyuan, Taiwan

## TEST REPORT

Reference No.:A04031803  
Report No.:FCCA04031803  
FCC ID:PQY-4710874200425  
Page:6 of 47  
Date:Jun. 01, 2004

### 2.3 DESCRIPTION OF TEST MODE

79 channels are provided by EUT. The 3 channels of lowest, medium and highest were chosen for test.

Channel	Frequency(MHz)
0	2402
39	2441
78	2480

#### NOTE :

1. Below 1 GHz, the channel 0, 39, and 78 were pre-tested in chamber. The channel 78, worst case one, was chosen for conducted and radiated emission test.
2. Above 1 GHz, the channel 0, 39 and 78 were tested individually

### 2.4 DESCRIPTION OF SUPPORT UNIT

The transmitter part of EUT was tested with a PC system and configured by the requirement of ANSI C63.4:2003. All interface ports were connected to the appropriate support units via specific cables. The support units and cables are listed below.

NO	DEVICE	BRAND	MODEL #	FCC ID/DOC	CABLE
1	DC POWER SUPPLY	LEADER	LPS-161A	N/A	1.5m unshielded power cable
2	PLUG-IN CHARGER	CINCON	C5-092V07-150A75	N/A	0.13m unshielded power cable
3	NOTEBOOK	DELL	C510/C610	DOC	1.8m unshielded power cord
4	BLUETOOTH DONGLE	CELLINK	BTA-3000	PQY-4710874200258	N/A

**NOTE :** For the actual test configuration, please refer to the photos of testing.



**Spectrum Research &  
Testing Lab., Inc.**

No. 101-10, Ling 8,  
Shan-Tong Li,  
Chung-Li City,  
Taoyuan, Taiwan

## **TEST REPORT**

Reference No.:A04031803  
Report No.:FCCA04031803  
FCC ID:PQY-4710874200425  
Page:7 of 47  
Date:Jun. 01, 2004

### **3. DESCRIPTION OF APPLIED STANDARDS**

The EUT is a kind of wireless product and to be connected with a PC system for normal use. According to the specifications provided by the applicant, it must comply with the requirements of the following standards:

47 CFR Part 15, Subpart C

ANSI C63.4:2003

Public DA00-705 (March 2000)

All tests have been performed and recorded as per the above standards.



**Spectrum Research & Testing Lab., Inc.**  
 No. 101-10, Ling 8,  
 Shan-Tong Li,  
 Chung-Li City,  
 Taoyuan, Taiwan

# TEST REPORT

Reference No.:A04031803  
 Report No.:FCCA04031803  
 FCC ID:PQY-4710874200425  
 Page:8 of 47  
 Date:Jun. 01, 2004

## 4. CONDUCTED EMISSION TEST

### 4.1 CONDUCTED EMISSION LIMIT

FREQUENCY (MHz)	Class A (dBmV)		Class B (dBmV)	
	Quasi-peak	Average	Quasi-peak	Average
0.15 - 0.5	79	66	66 - 56	56 - 46
0.5 - 5.0	73	60	56	46
5.0 - 30.0	73	60	60	50

#### NOTE:

1. The lower limit shall apply at the transition frequencies.
2. The limit decreases in line with the logarithm of the frequency in the range of 0.15 to 0.50 MHz.

### 4.2 TEST EQUIPMENT

The following test equipment was used for the test:

EQUIPMENT/ FACILITIES	SPECIFICATIONS	MANUFACTURER	MODEL#/ SERIAL#	DUE DATE OF CAL. & CAL. CENTER
EMI TEST RECEIVER	9 kHz TO 2750 MHz	ROHDE & SCHWARZ	ESCS30/ 830245/012	AUG. 2004 ETC
LISN (for EUT)	50 $\mu$ H, 50 ohm	SOLAR ELECTRONICS	8012-50-R-24-BNC / 924839	JUN. 2004 ETC
LISN (for Peripheral)	50 $\mu$ H, 50 ohm	SOLAR ELECTRONICS	9252-50-R-24-BNC / 951318	JUN. 2004 ETC
50 ohm TERMINATOR	50 ohm	HP	11593A/ 4	MAR. 2005 ETC
COAXIAL CABLE	3m	SUNCITY	J400/ 3M	JUL. 2004 SRT
ISOLATION TRANSFORMER	N/A	APC	AFC-11015/ F102040016	N/A
FILTER	2 LINE, 30A	FIL.COIL	FC-943/ 771	N/A
GROUND PLANE	2.3M (H) x 2.4M (W)	SRT	N/A	N/A
GROUND PLANE	2.4M (H) x 2.4M (W)	SRT	N/A	N/A

**NOTE:** The calibration interval of the above test equipment is one year and the calibrations are traceable to NML/ROC and NIST/USA.





## 4.3 TEST SETUP

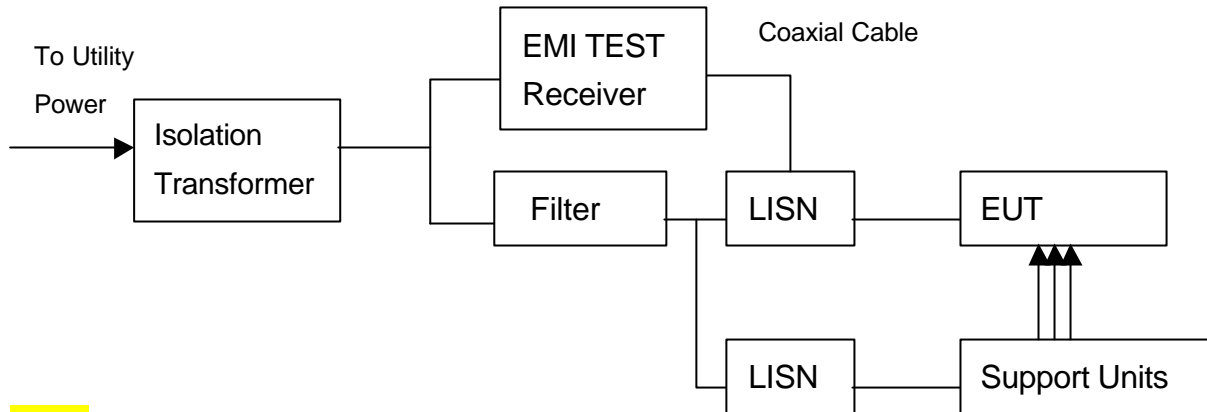

### NOTE:

1. The EUT was put on a wooden table with 0.8m height above ground plane, and 0.4m away from reference ground plane (> 2mx2m).
2. For the actual test configuration, please refer to the photos of testing.
3. The serial no. of the LISN connected to EUT is 951318.
4. The serial no. of the LISN connected to support units is 924839.

## 4.4 TEST PROCEDURE

The EUT was tested according to the requirement of ANSI C63.4:2003 and CISRP22:2003. The frequency spectrum from 0.15 MHz to 30 MHz was investigated. The LISN used was 50 ohm/50 $\mu$ H as specified. All readings were quasi-peak and average values with 10 kHz resolution bandwidth of the test receiver. The EUT system was operated in all typical methods by users. Both lines of the power mains of EUT were measured and the cables connected to EUT and support units were moved to find the maximum emission levels for each frequency. First, Find the margin or higher points at least 6 points by software, then use manual to find the maximum data. The procedure is referred on the test procedure of SRT LAB.

## 4.5 EUT OPERATING CONDITION

1. Set the EUT under transmission condition continuously at specific channel frequency.
2. Under Windows XP run "EMI TEST" program and PC sent "H" pattern or accessed the following peripherals directly or via EUT:
  - RS232
  - Printer
  - FDD
  - HDD



# TEST REPORT

## 4.6 TEST RESULT

Temperature:	26°C	Humidity:	50 %RH
Ferquency Range:	0.15 – 30 MHz	Tested Mode:	CH 0: 2402MHz
Receiver Detector:	Q.P. and AV.	Tested Date:	May 27, 2004
Tested By:	Yujeng Wu		

Power Line Measured : Line

Freq. (MHz)	Correct. Factor (dB)	Reading Value (dBmV)		Emission Level (dBmV)		Limit (dBmV)		Margin (dB)	
		Q.P.	AV.	Q.P.	AV.	Q.P.	AV.	Q.P.	AV.
0.291	0.20	34.2	31.3	34.4	31.5	60.5	50.5	-26.1	-19.0
0.294	0.20	33.1	31.2	33.3	31.4	60.4	50.4	-27.1	-19.0
1.685	0.20	29.2	26.3	29.4	26.5	56.0	46.0	-26.6	-19.5
1.735	0.20	29.1	22.7	29.3	22.9	56.0	46.0	-26.7	-23.1
5.203	0.32	14.8	8.4	15.1	8.7	60.0	50.0	-44.9	-41.3
6.959	0.35	20.0	3.4	20.3	3.8	60.0	50.0	-39.7	-46.2

Power Line Measured : Neutral

Freq. (MHz)	Correct. Factor (dB)	Reading Value (dBmV)		Emission Level (dBmV)		Limit (dBmV)		Margin (dB)	
		Q.P.	AV.	Q.P.	AV.	Q.P.	AV.	Q.P.	AV.
0.291	0.20	34.9	32.2	35.1	32.4	60.5	50.5	-25.3	-18.1
0.438	0.20	29.9	29.8	30.1	30.0	57.1	47.1	-26.9	-17.1
1.095	0.20	28.7	28.3	28.9	28.5	56.0	46.0	-27.1	-17.5
1.606	0.20	29.1	27.9	29.3	28.1	56.0	46.0	-26.7	-17.9
1.754	0.20	28.7	27.2	28.9	27.4	56.0	46.0	-27.1	-18.6
5.477	0.32	25.4	22.5	25.7	22.9	60.0	50.0	-34.3	-27.1

### NOTE :

1. Measurement uncertainty is +/-1.32dB
2. Emission level = Reading value + Correction factor
3. Correction Factor = Cable loss + Insertion loss of LISN
4. Margin value = Emission level - Limit
5. The emission of other frequencies were very low against the limit.
6. "-": The Quasi-peak reading value also meets average limit and measurement with the average detector is unnecessary.



**Spectrum Research & Testing Lab., Inc.**  
No. 101-10, Ling 8,  
Shan-Tong Li,  
Chung-Li City,  
Taoyuan, Taiwan

## TEST REPORT

Reference No.:A04031803  
Report No.:FCCA04031803  
FCC ID:PQY-4710874200425  
Page:11 of 47  
Date:Jun. 01, 2004

Temperature: 26° C Humidity: 50 %RH  
Ferquency Range: 0.15 – 30 MHz Tested Mode: CH 39: 2441MHz  
Receiver Detector: Q.P. and AV. Tested Date: May 27, 2004  
Tested By: Yujeng Wu

Power Line Measured : Line

Freq. (MHz)	Correct. Factor (dB)	Reading Value (dBmV)		Emission Level (dBmV)		Limit (dBmV)		Margin (dB)	
		Q.P.	AV.	Q.P.	AV.	Q.P.	AV.	Q.P.	AV.
0.288	0.20	43.1	41.7	43.3	41.9	60.6	50.6	-17.3	-8.6
0.291	0.20	44.2	42.4	44.4	42.6	60.5	50.5	-16.1	-7.9
1.182	0.20	37.4	27.5	37.6	27.7	56.0	46.0	-18.4	-18.3
1.210	0.20	35.5	26.4	35.7	26.6	56.0	46.0	-20.3	-19.4
1.279	0.20	36.7	28.0	36.9	28.2	56.0	46.0	-19.1	-17.8
5.832	0.33	24.6	21.4	24.9	21.7	60.0	50.0	-35.1	-28.3

Power Line Measured : Neutral

Freq. (MHz)	Correct. Factor (dB)	Reading Value (dBmV)		Emission Level (dBmV)		Limit (dBmV)		Margin (dB)	
		Q.P.	AV.	Q.P.	AV.	Q.P.	AV.	Q.P.	AV.
0.207	0.20	46.6	42.0	46.8	42.2	63.3	53.3	-16.5	-11.1
0.291	0.20	47.6	46.4	47.8	46.6	60.5	50.5	-12.7	-3.9
1.162	0.20	45.1	34.6	45.3	34.8	56.0	46.0	-10.7	-11.2
1.259	0.20	44.8	35.2	45.0	35.4	56.0	46.0	-11.0	-10.6
1.309	0.20	41.7	34.8	41.9	35.0	56.0	46.0	-14.1	-11.0
7.801	0.36	25.2	19.0	25.6	19.4	60.0	50.0	-34.4	-30.6

### NOTE :

1. Measurement uncertainty is +/-1.32dB
2. Emission level = Reading value + Correction factor
3. Correction Factor = Cable loss + Insertion loss of LISN
4. Margin value = Emission level - Limit
5. The emission of other frequencies were very low against the limit.
6. "-": The Quasi-peak reading value also meets average limit and measurement with the average detector is unnecessary.



**Spectrum Research & Testing Lab., Inc.**  
No. 101-10, Ling 8,  
Shan-Tong Li,  
Chung-Li City,  
Taoyuan, Taiwan

# TEST REPORT

Reference No.:A04031803  
Report No.:FCCA04031803  
FCC ID:PQY-4710874200425  
Page:12 of 47  
Date:Jun. 01, 2004

Temperature: 26° C Humidity: 50 %RH  
Frequency Range: 0.15 – 30 MHz Tested Mode: CH 78: 2480MHz  
Receiver Detector: Q.P. and AV. Tested Date: May 27, 2004  
Tested By: Yujeng Wu

Power Line Measured : Line

Freq. (MHz)	Correct. Factor (dB)	Reading Value (dBmV)		Emission Level (dBmV)		Limit (dBmV)		Margin (dB)	
		Q.P.	AV.	Q.P.	AV.	Q.P.	AV.	Q.P.	AV.
0.168	0.20	40.8	39.4	41.0	39.6	65.0	55.0	-24.0	-15.4
0.169	0.20	41.0	39.1	41.2	39.3	65.0	55.0	-23.8	-15.7
0.772	0.20	25.7	20.6	25.9	20.8	56.0	46.0	-30.1	-25.2
1.422	0.20	29.6	26.5	29.8	26.7	56.0	46.0	-26.2	-19.4
13.613	0.47	41.8	37.9	42.3	38.3	60.0	50.0	-17.7	-11.7
17.691	0.55	35.8	32.0	36.4	32.5	60.0	50.0	-23.6	-17.5

Power Line Measured : Neutral

Freq. (MHz)	Correct. Factor (dB)	Reading Value (dBmV)		Emission Level (dBmV)		Limit (dBmV)		Margin (dB)	
		Q.P.	AV.	Q.P.	AV.	Q.P.	AV.	Q.P.	AV.
0.167	0.20	38.5	38.4	38.7	38.6	65.1	55.1	-26.4	-16.5
0.168	0.20	40.7	38.6	40.9	38.8	65.0	55.0	-24.2	-16.3
1.422	0.20	32.7	29.2	32.9	29.4	56.0	46.0	-23.1	-16.6
13.604	0.47	36.6	29.9	37.1	30.4	60.0	50.0	-22.9	-19.6
13.613	0.47	41.2	36.4	41.7	36.9	60.0	50.0	-18.3	-13.1
17.691	0.55	34.5	34.2	35.0	34.8	60.0	50.0	-25.0	-15.2

## NOTE :

1. Measurement uncertainty is +/-1.32dB
2. Emission level = Reading value + Correction factor
3. Correction Factor = Cable loss + Insertion loss of LISN
4. Margin value = Emission level - Limit
5. The emission of other frequencies were very low against the limit.
6. "-": The Quasi-peak reading value also meets average limit and measurement with the average detector is unnecessary.

	<b>Spectrum Research &amp; Testing Lab., Inc.</b> No. 101-10, Ling 8, Shan-Tong Li, Chung-Li City, Taoyuan, Taiwan	<h1>TEST REPORT</h1>	Reference No.:A04031803 Report No.:FCCA04031803 FCC ID:PQY-4710874200425 Page:13 of 47 Date:Jun. 01, 2004
---	--	----------------------	---

## 4.2 CHANNEL SEPARATION TEST

### 4.2.1 LIMIT

FCC Part15, Subpart C Section 15.247(a)(1) . Frequency hopping systems shall have hopping channel carrier frequencies separated by a minimum of 25 kHz or the 20 dB bandwidth of the hopping channel, whichever is greater.

FREQUENCY RANGE (MHz)	Limit(kHz)
902-928	>25kHz
2400-2483.5	>25kHz
5725-5850	>25kHz

### 4.2.2 TEST EQUIPMENT

The following test equipment was used during the radiated emission test:

EQUIPMENT/ FACILITIES	SPECIFICATIONS	MANUFACTURER	MODEL#/ SERIAL#	DUE DATE OF CAL. & CAL. CENTER
SPECTRUM	9kHz-7GHz	ROHDE & SCHWARZ	FSP7/ 839511/010	MAR. 2005 ETC

**NOTE:** The calibration interval of the above test equipment is one year and the calibrations are traceable to NML/ROC and NIST/USA.

### 4.2.3 TEST SET-UP

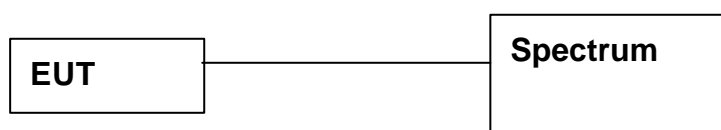

The EUT was connected to a spectrum through a 50 RF cable.

### 4.2.4 TEST PROCEDURE

The EUT was operating in hopping mode or could be controlled its channel. Printed out the test result from the spectrum by hard copy function.

### 4.2.5 EUT OPERATING CONDITION

Same as section 4.1.5 of this report.



**Spectrum Research & Testing Lab., Inc.**  
 No. 101-10, Ling 8,  
 Shan-Tong Li,  
 Chung-Li City,  
 Taoyuan, Taiwan

# TEST REPORT

Reference No.:A04031803  
 Report No.:FCCA04031803  
 FCC ID:PQY-4710874200425  
 Page:14 of 47  
 Date:Jun. 01, 2004

## 4.2.6 TEST RESULT

Temperature:	<u>26°C</u>	Humidity:	<u>55%RH</u>
Spectrum Detector:	<u>PK</u>	Tested By	<u>Yujent Wu</u>
Tested Result	<u>Pass</u>	Tested Date:	<u>May 24, 2004</u>

CHANNEL NUMBER	CHANNEL FREQUENCY (MHz)	SEPARATION READ VALUE (kHz)	SEPARATION LIMIT (kHz)
0	2402	996	>25kHz
39	2441	1000	>25kHz
78	2480	1000	>25kHz

CH0:

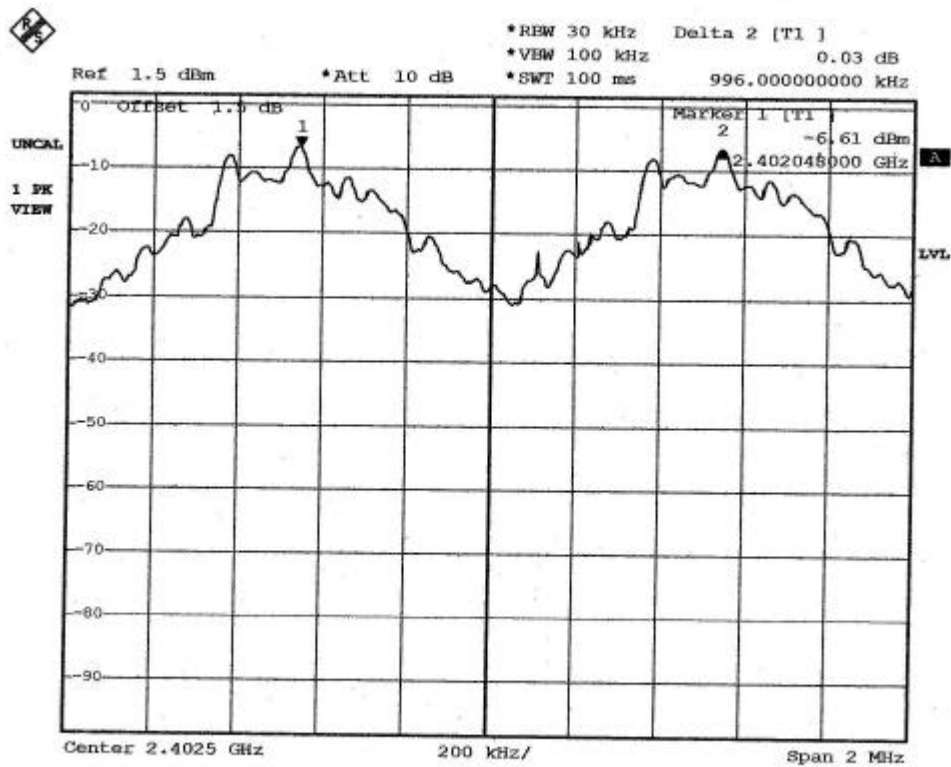

Date: 24.MAR.2004 10:21:33



**Spectrum Research & Testing Lab., Inc.**  
No. 101-10, Ling 8,  
Shan-Tong Li,  
Chung-Li City,  
Taoyuan, Taiwan

# TEST REPORT

Reference No.:A04031803  
Report No.:FCCA04031803  
FCC ID:PQY-4710874200425  
Page:15 of 47  
Date:Jun. 01, 2004

CH39:

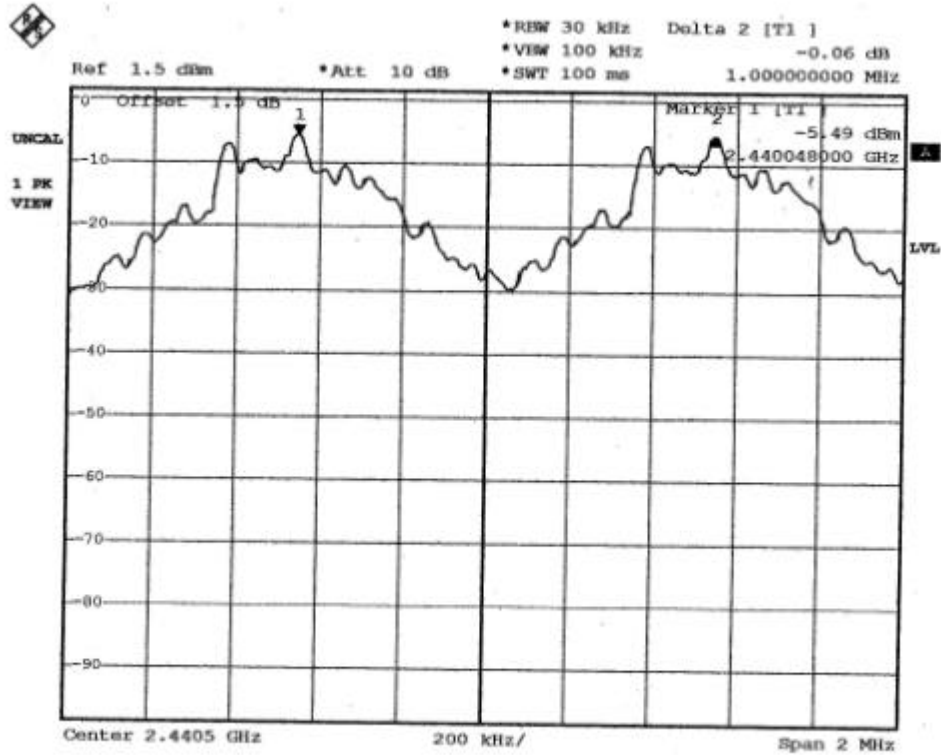

Date: 24.MAR.2004 10:23:12

CH78:



Date: 24.MAR.2004 10:25:21

	<b>Spectrum Research &amp; Testing Lab., Inc.</b> No. 101-10, Ling 8, Shan-Tong Li, Chung-Li City, Taoyuan, Taiwan	<h1>TEST REPORT</h1>	Reference No.:A04031803 Report No.:FCCA04031803 FCC ID:PQY-4710874200425 Page:16 of 47 Date:Jun. 01, 2004
---	--	----------------------	---

### 4.3 QUANTITY OF HOPPING CHANNEL TEST

#### 4.3.1 LIMIT

FCC Part15, Subpart C Section 15.247.

FREQUENCY RANGE (MHz)	Limit (Quantity of Hopping Channel)			
	20dB bandwidth <250kHz	20dB bandwidth >250kHz	20dB bandwidth <1MHz	20dB bandwidth >1MHz
902-928	50	25	N/A	N/A
2400-2483.5	N/A	N/A	75	15
5725-5850	N/A	N/A	75	N/A

#### 4.3.2 TEST EQUIPMENT

The following test equipment was used during the test:

EQUIPMENT/FACILITIES	SPECIFICATIONS	MANUFACTURER	MODEL#/SERIAL#	DUE DATE OF CAL. & CAL. CENTER
SPECTRUM	9kHz-7GHz	ROHDE & SCHWARZ	FSP7/ 839511/010	MAR. 2005 ETC

**NOTE:** The calibration interval of the above test equipment is one year and the calibrations are traceable to NML/ROC and NIST/USA.

#### 4.3.3 TEST SET-UP

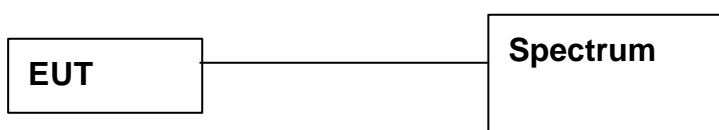

The EUT was connected to a spectrum through a 50 Ω RF cable.

#### 4.3.4 TEST PROCEDURE

The EUT was operating in hopping mode or could be controlled its channel. Printed out the test result from the spectrum by hard copy function.

#### 4.3.5 EUT OPERATING CONDITION

Same as section 4.1.5 of this report.





**Spectrum Research & Testing Lab., Inc.**  
 No. 101-10, Ling 8,  
 Shan-Tong Li,  
 Chung-Li City,  
 Taoyuan, Taiwan

# TEST REPORT

Reference No.:A04031803  
 Report No.:FCCA04031803  
 FCC ID:PQY-4710874200425  
 Page:17 of 47  
 Date:Jun. 01, 2004

## 4.3.6 TEST RESULT

Temperature:	<u>26°C</u>	Humidity:	<u>55%RH</u>
Spectrum Detector:	<u>PK</u>	Tested By	<u>Yujent Wu</u>
Tested Result	<u>Pass</u>	Tested Date:	<u>May 24, 2004</u>

HOPPING CHANNEL FREQUENCY RANGE	QUANTITY OF HOPPING CHANNEL READ VALUE	QUANTITY OF HOPPING CHANNEL LIMIT
2402~2480	79	75

CH0-CH78

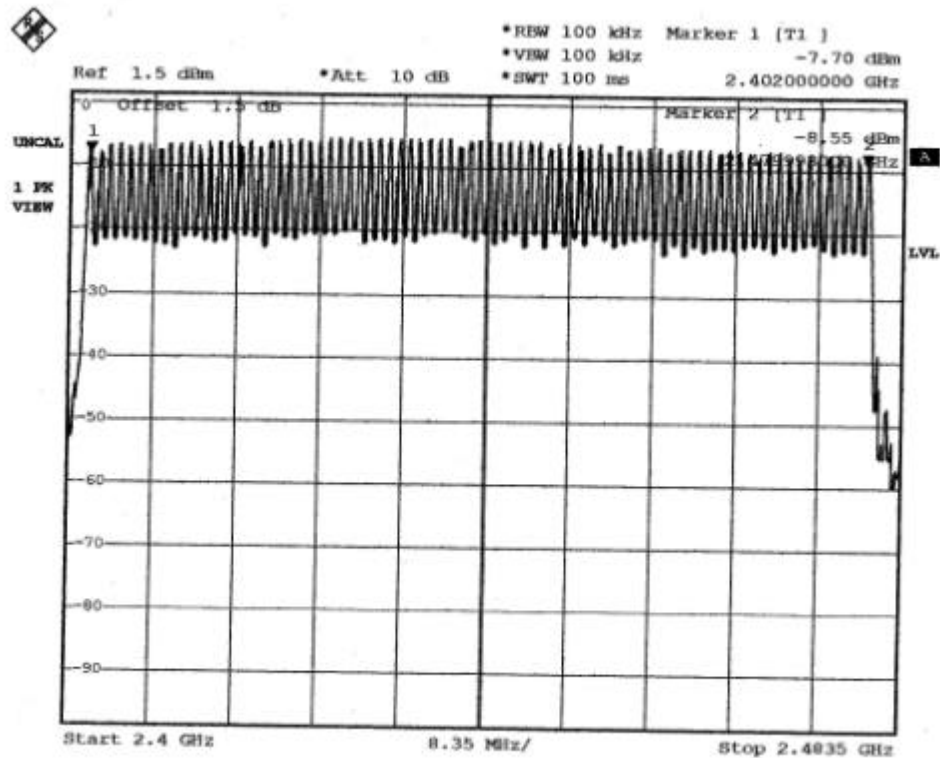

Date: 24.MAR.2004 10:17:01

	<b>Spectrum Research &amp; Testing Lab., Inc.</b> No. 101-10, Ling 8, Shan-Tong Li, Chung-Li City, Taoyuan, Taiwan	<h1>TEST REPORT</h1>	Reference No.:A04031803 Report No.:FCCA04031803 FCC ID:PQY-4710874200425 Page:18 of 47 Date:Jun. 01, 2004
---	--	----------------------	---

#### 4.4 20dB Bandwidth

##### 4.4.1 LIMIT

FREQUENCY Range (MHz)	Quantity of Hopping Channel	Limit(kHz)			
		50	25	15	75
902-928		<250	>250	NA	NA
2400-2483.5		NA	NA	>1000	<1000

##### 4.4.2 TEST EQUIPMENT

The following test equipment was used during the test:

EQUIPMENT/ FACILITIES	SPECIFICATIONS	MANUFACTURER	MODEL#/ SERIAL#	DUE DATE OF CAL. & CAL. CENTER
SPECTRUM	9kHz-7GHz	ROHDE & SCHWARZ	FSP7/ 839511/010	MAR. 2005 ETC

**NOTE:** The calibration interval of the above test equipment is one year and the calibrations are traceable to NML/ROC and NIST/USA.

##### 4.4.3 TEST SET-UP

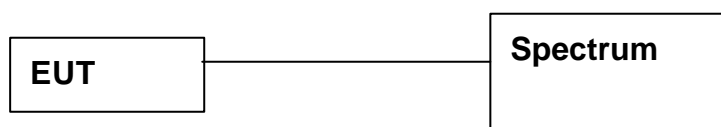

The EUT was connected to a spectrum through a 50 RF cable.

##### 4.4.4 TEST PROCEDURE

The EUT was operating in hopping mode or could be controlled its channel. Printed out the test result from the spectrum by hard copy function.

##### 4.4.5 EUT OPERATING CONDITION

Same as section 4.1.5 of this report.



**Spectrum Research & Testing Lab., Inc.**  
 No. 101-10, Ling 8,  
 Shan-Tong Li,  
 Chung-Li City,  
 Taoyuan, Taiwan

# TEST REPORT

Reference No.:A04031803  
 Report No.:FCCA04031803  
 FCC ID:PQY-4710874200425  
 Page:19 of 47  
 Date:Jun. 01, 2004

## 4.4.6 TEST RESULT

Temperature:	<u>26°C</u>	Humidity:	<u>55%RH</u>
Spectrum Detector:	<u>PK</u>	Tested By	<u>Yujent Wu</u>
Tested Result	<u>Pass</u>	Tested Date:	<u>May 24, 2004</u>

CHANNEL NUMBER	CHANNEL FREQUENCY (MHz)	20dB DOWN BW (MHz)	MINIMUM LIMIT (MHz)
0	2402	0.792	1
39	2441	0.784	1
78	2480	0.784	1

CH0:

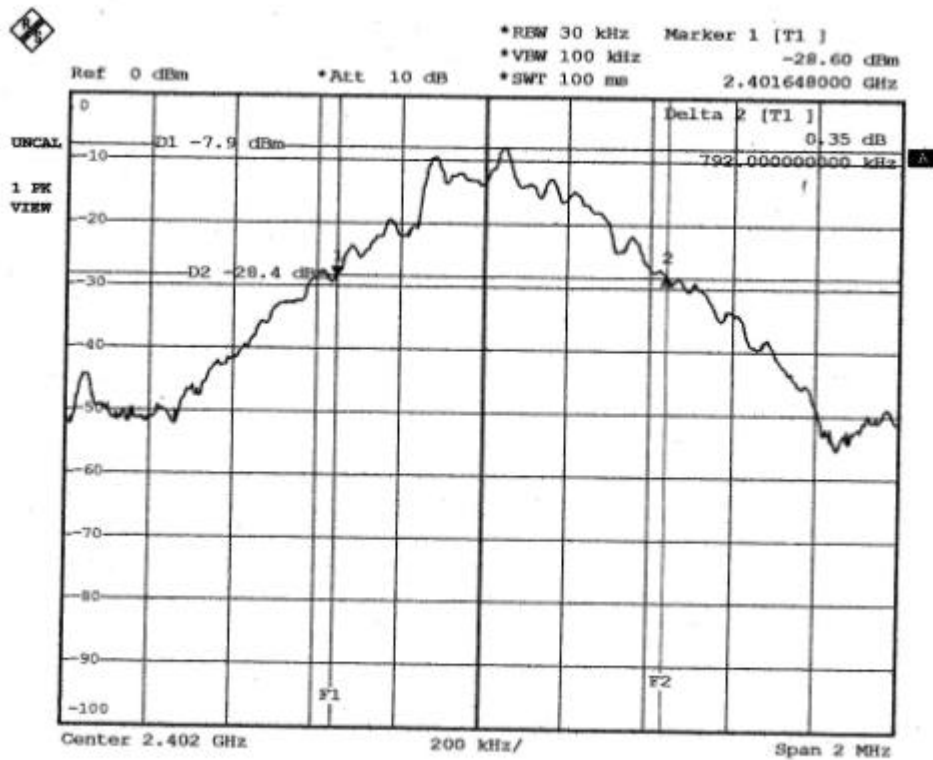

Date: 24.MAR.2004 10:02:02



**Spectrum Research & Testing Lab., Inc.**  
 No. 101-10, Ling 8,  
 Shan-Tong Li,  
 Chung-Li City,  
 Taoyuan, Taiwan

# TEST REPORT

Reference No.:A04031803  
 Report No.:FCCA04031803  
 FCC ID:PQY-4710874200425  
 Page:20 of 47  
 Date:Jun. 01, 2004

CH39:

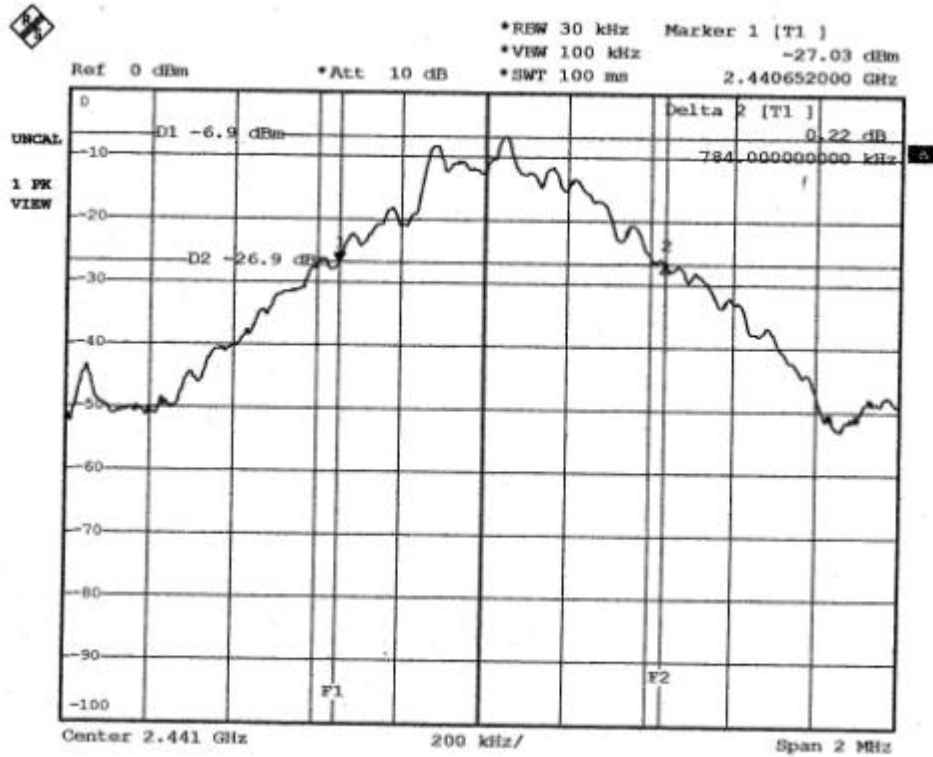

Date: 24.MAR.2004 10:04:20

CH78:

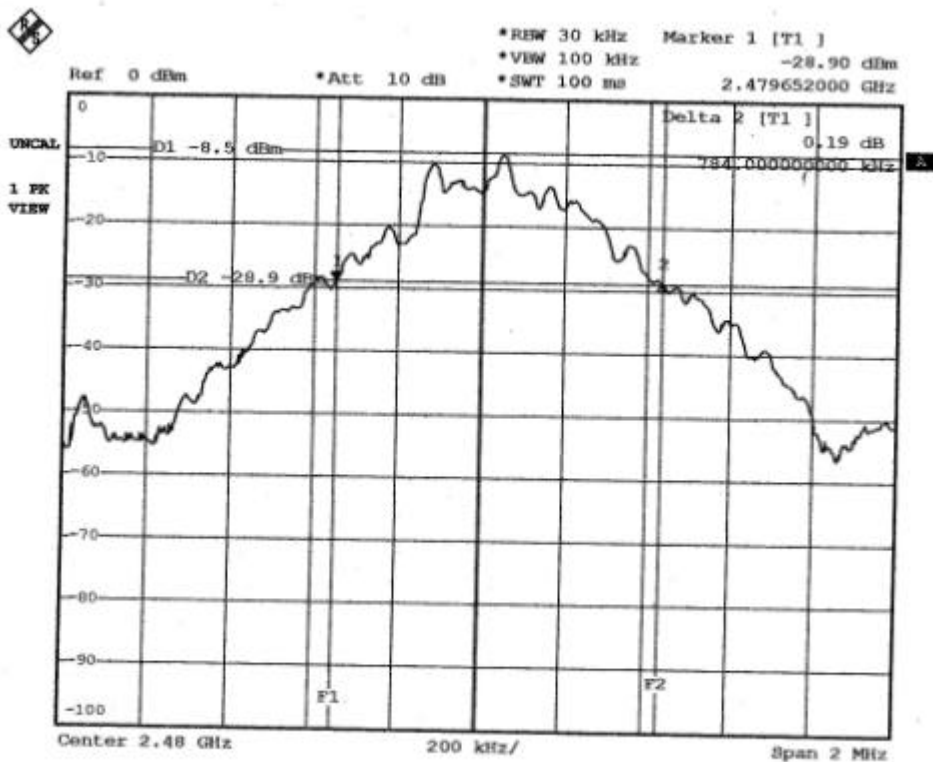

Date: 24.MAR.2004 10:05:53

	<b>Spectrum Research &amp; Testing Lab., Inc.</b> No. 101-10, Ling 8, Shan-Tong Li, Chung-Li City, Taoyuan, Taiwan	<h1>TEST REPORT</h1>	Reference No.:A04031803 Report No.:FCCA04031803 FCC ID:PQY-4710874200425 Page:21 of 47 Date:Jun. 01, 2004
---	--	----------------------	---

## 4.5 Time of occupancy (Dwell Time)

### 4.5.1 LIMIT

FCC Part15, Subpart C Section 15.247.

FREQUENCY RANGE (MHz)	LIMIT (ms)		
	20dB bandwidth <250kHz(50Channel)	20dB bandwidth >250kHz(25Channel)	20dB bandwidth <1MHz(75Channel)
902-928	400(20s)	400(10s)	NA
2400-2483.5	NA	NA	400(30s)
5725-5850	NA	NA	400(30s)

**NOTE:** The “( )” is all channel’ s average time of occupancy.

### 4.5.2 TEST EQUIPMENT

The following test equipment was used during the test:

EQUIPMENT/ FACILITIES	SPECIFICATIONS	MANUFACTURER	MODEL#/ SERIAL#	DUE DATE OF CAL. & CAL. CENTER
SPECTRUM	9kHz-7GHz	ROHDE & SCHWARZ	FSP7/ 839511/010	MAR. 2005 ETC

**NOTE:** The calibration interval of the above test equipment is one year and the calibrations are traceable to NML/ROC and NIST/USA.

### 4.5.3 TEST SET-UP

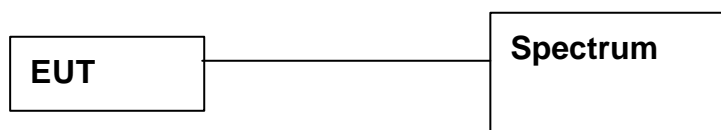

The EUT was connected to a spectrum through a 50 RF cable.

### 4.5.4 TEST PROCEDURE

The EUT was operating in hopping mode or could be controlled its channel. Printed out the test result from the spectrum by hard copy function.

### 4.5.5 EUT OPERATING CONDITION

Same as section 4.1.5 of this report.



**Spectrum Research & Testing Lab., Inc.**  
No. 101-10, Ling 8,  
Shan-Tong Li,  
Chung-Li City,  
Taoyuan, Taiwan

## TEST REPORT

Reference No.:A04031803  
Report No.:FCCA04031803  
FCC ID:PQY-4710874200425  
Page:22 of 47  
Date:Jun. 01, 2004

### 4.5.6 TEST RESULT

Temperature: 26°C Humidity: 55%RH  
Spectrum Detector: PK Tested By: Yujent Wu  
Tested Result: Pass Tested Date: May 24, 2004

CHANNEL NUMBER	CHANNEL FREQUENCY (MHz)	Pulse Time (i s)	Burts (in 1 sec.)	Time of occupancy (Dwell Time) (ms)	Average time of occupancy LIMIT (ms)
0	2402.00	418	10	132.088	400
39	2441.00	418	10	132.088	400
78	2480.00	418	10	132.088	400

Note:

Dwell Time:

CH0:  $418 \times 10 \times 79 \times 0.4 = 132088(i s) = 132.088ms$

CH39:  $418 \times 10 \times 79 \times 0.4 = 132088(i s) = 132.088ms$

CH78:  $418 \times 10 \times 79 \times 0.4 = 132088(i s) = 132.088ms$



**Spectrum Research & Testing Lab., Inc.**  
No. 101-10, Ling 8,  
Shan-Tong Li,  
Chung-Li City,  
Taoyuan, Taiwan

# TEST REPORT

Reference No.:A04031803  
Report No.:FCCA04031803  
FCC ID:PQY-4710874200425  
Page:23 of 47  
Date:Jun. 01, 2004

CH0:

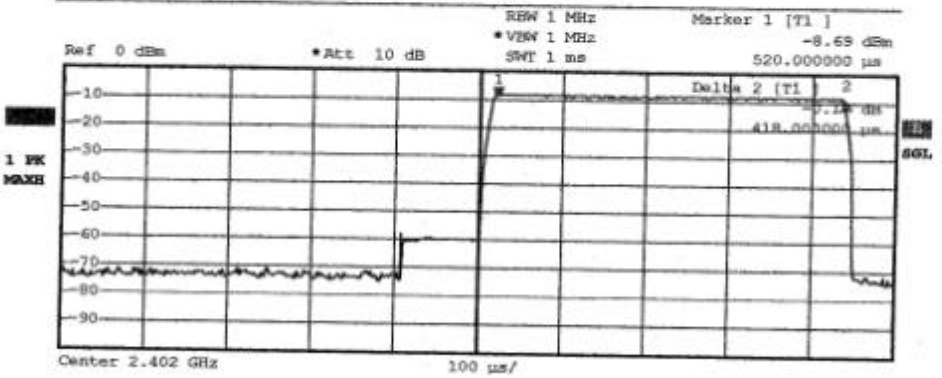
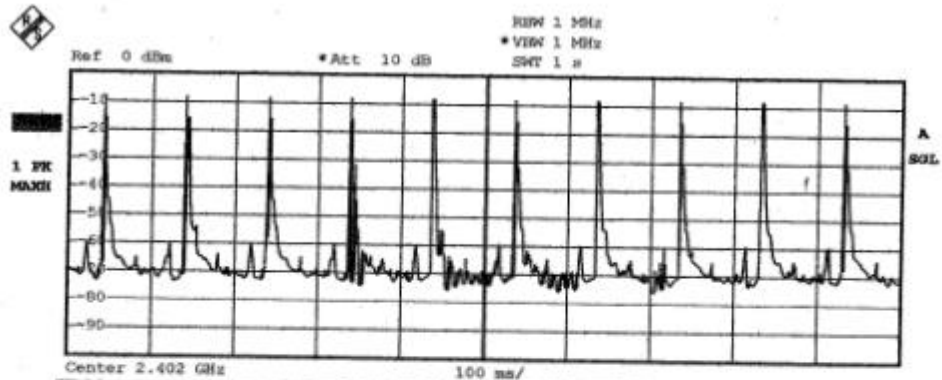

Date: 24.MAR.2004 10:41:06



**Spectrum Research & Testing Lab., Inc.**  
No. 101-10, Ling 8,  
Shan-Tong Li,  
Chung-Li City,  
Taoyuan, Taiwan

# TEST REPORT

Reference No.:A04031803  
Report No.:FCCA04031803  
FCC ID:PQY-4710874200425  
Page:24 of 47  
Date:Jun. 01, 2004

CH39:

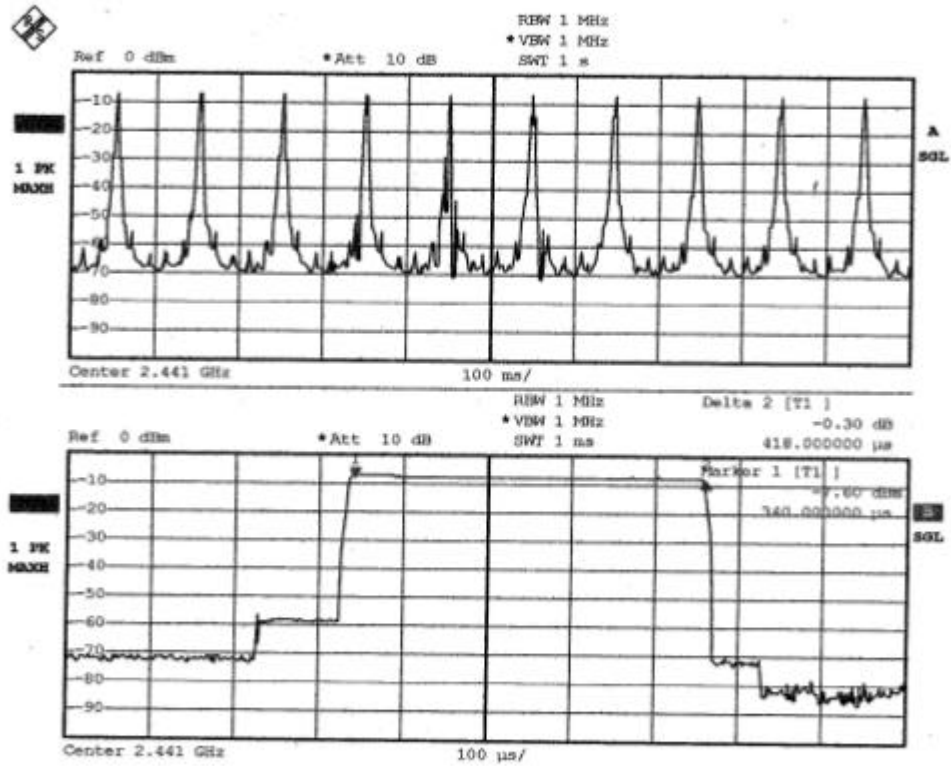

Date: 24.MAR.2004 10:43:59





**Spectrum Research & Testing Lab., Inc.**  
No. 101-10, Ling 8,  
Shan-Tong Li,  
Chung-Li City,  
Taoyuan, Taiwan

# TEST REPORT

Reference No.:A04031803  
Report No.:FCCA04031803  
FCC ID:PQY-4710874200425  
Page:25 of 47  
Date:Jun. 01, 2004

CH78:

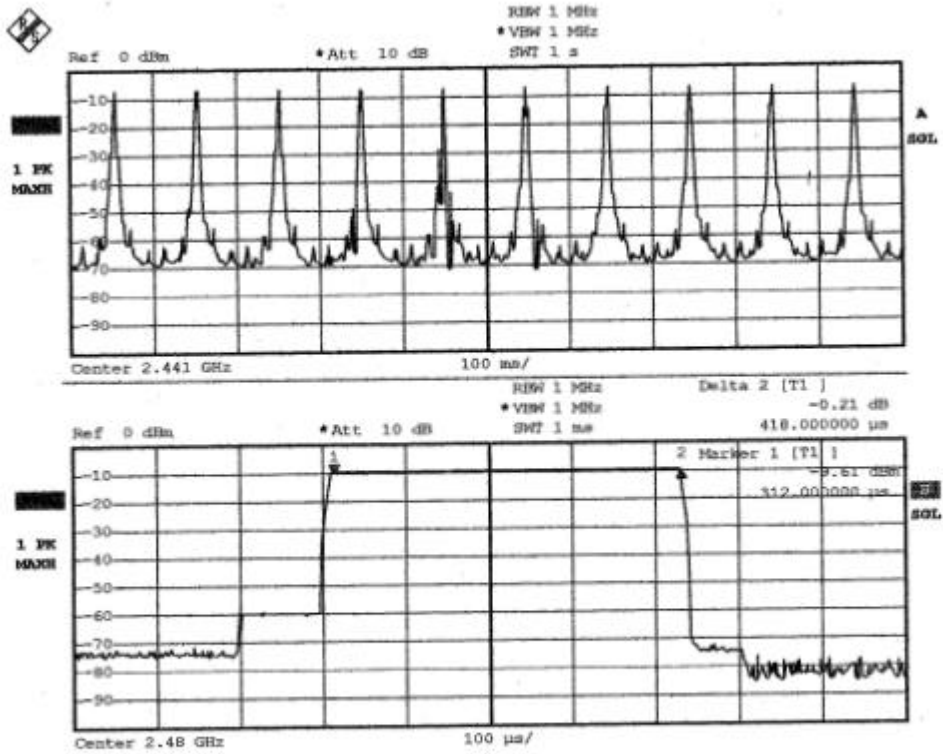

Date: 24.MAR.2004 10:47:51

	<b>Spectrum Research &amp; Testing Lab., Inc.</b> No. 101-10, Ling 8, Shan-Tong Li, Chung-Li City, Taoyuan, Taiwan	<h1>TEST REPORT</h1>	Reference No.:A04031803 Report No.:FCCA04031803 FCC ID:PQY-4710874200425 Page:26 of 47 Date:Jun. 01, 2004
---	--	----------------------	---

## 4.6 PEAK POWER TEST

### 4.6.1 LIMIT

FCC Part15, Subpart C Section 15.247.

FREQUENCY RANGE (MHz)	LIMIT (W)				
	Quantity of Hopping Channel	50	25	15	75
902-928	1(30dBm)	0.125(21dBm)	NA	NA	NA
2400-2483.5	NA	NA	0.125(21dBm)	1(30dBm)	1(30dBm)
5725-5850	NA	NA	NA	1(30dBm)	1(30dBm)

### 4.6.2 TEST EQUIPMENT

The following test equipment was used during the test:

EQUIPMENT/FACILITIES	SPECIFICATIONS	MANUFACTURER	MODEL#/SERIAL#	DUE DATE OF CAL. & CAL. CENTER
SPECTRUM	9kHz-7GHz	ROHDE & SCHWARZ	FSP7/ 839511/010	MAR. 2005 ETC
POWER METER	N/A	BOONTON	4232A/ 29001	MAY 2005 ETC
POWER SENSOR	DC-18GHz 0.3μW-100mW 50	BOONTON	51011-EMC/ 31184	JUN. 2004 ETC

**NOTE:** The calibration interval of the above test equipment is one year and the calibrations are traceable to NML/ROC and NIST/USA.



**4.6.3 TEST SET-UP**

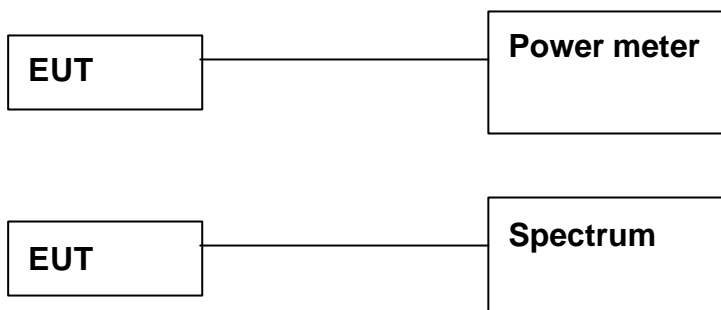

The EUT was connected to a spectrum through a 50 RF cable.

**4.6.4 TEST PROCEDURE**

The EUT was operating in hopping mode or could control its channel.  
 Printed out the test result from the spectrum by hard copy function.  
 Recorded the read value of the power meter.

**4.6.5 EUT OPERATING CONDITION**

Same as section 4.1.5 of this report.

**4.6.6 TEST RESULT**

Temperature:	<u>26°C</u>	Humidity:	<u>55%RH</u>
Spectrum Detector:	<u>PK</u>	Tested By	<u>Yujent Wu</u>
Tested Result	<u>Pass</u>	Tested Date:	<u>May 24, 2004</u>

CHANNEL NUMBER	CHANNEL FREQUENCY (MHz)	PEAK POWER OUTPUT (dBm)	PEAK POWER LIMIT (dBm)
0	2402.0000	-5.10	30
39	2441.0000	-4.40	30
78	2480.0000	-4.71	30



**Spectrum Research & Testing Lab., Inc.**  
No. 101-10, Ling 8,  
Shan-Tong Li,  
Chung-Li City,  
Taoyuan, Taiwan

# TEST REPORT

Reference No.:A04031803  
Report No.:FCCA04031803  
FCC ID:PQY-4710874200425  
Page:28 of 47  
Date:Jun. 01, 2004

CH0:

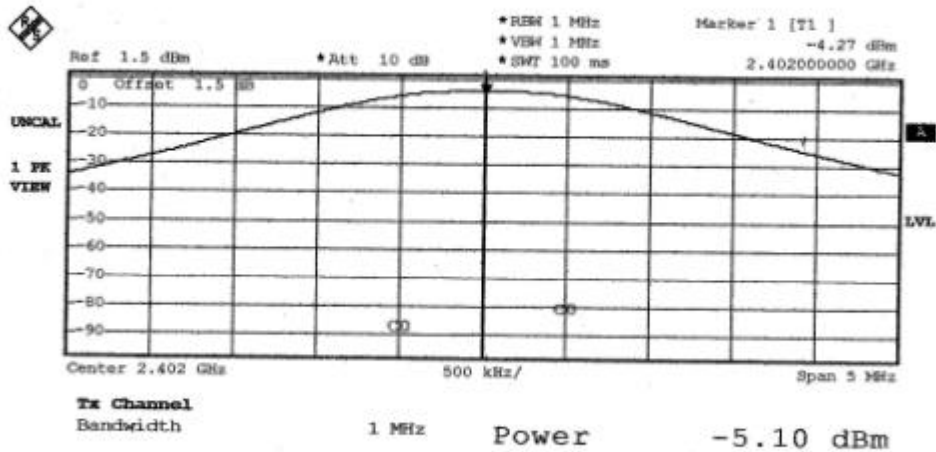

CH39:

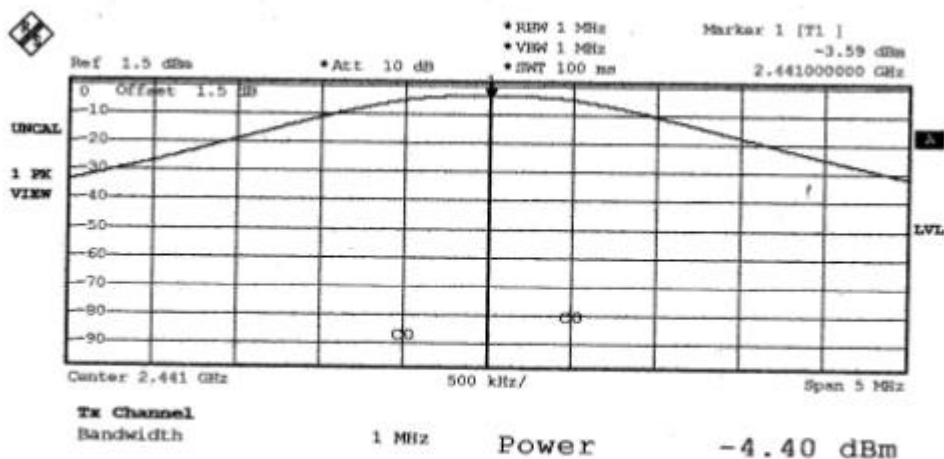



**Spectrum Research & Testing Lab., Inc.**  
No. 101-10, Ling 8,  
Shan-Tong Li,  
Chung-Li City,  
Taoyuan, Taiwan

# TEST REPORT

Reference No.:A04031803  
Report No.:FCCA04031803  
FCC ID:PQY-4710874200425  
Page:29 of 47  
Date:Jun. 01, 2004

CH78:

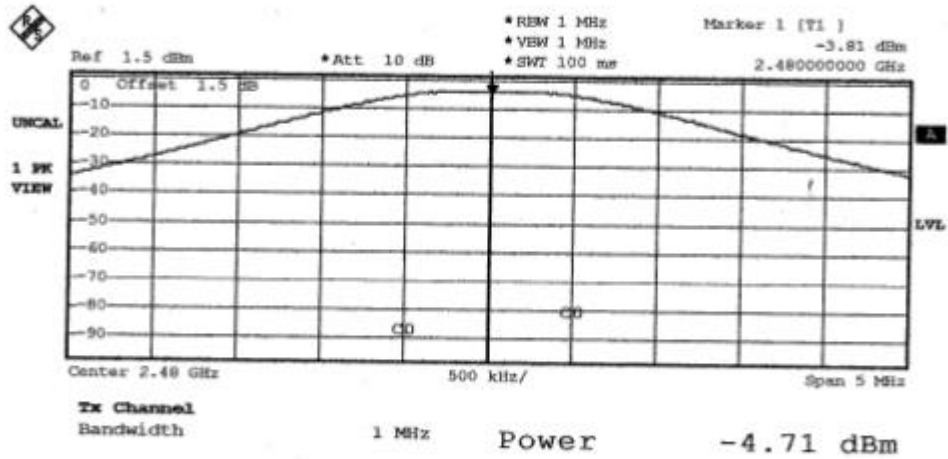



**Spectrum Research & Testing Lab., Inc.**  
No. 101-10, Ling 8,  
Shan-Tong Li,  
Chung-Li City,  
Taoyuan, Taiwan

## TEST REPORT

Reference No.:A04031803  
Report No.:FCCA04031803  
FCC ID:PQY-4710874200425  
Page:30 of 47  
Date:Jun. 01, 2004

### 4.7 BAND EDGE TEST

#### 4.7.1 LIMIT

FCC Part15, Subpart C Section 15.247. In any 100 kHz bandwidth outside the frequency band in which the spread spectrum intentional radiator is operating, the radio frequency power that is produced by the intentional radiator shall be at least 20 dB below that in the 100 kHz bandwidth within the band that contains the highest level of the desired power, based on either an RF conducted or a radiated measurement. Attenuation below the general limits specified in Section 15.209(a) is not required. In addition, radiated emissions which fall in the restricted bands, as defined in Section 15.205(a), must also comply with the radiated emission limits specified in Section 15.209(a) (see Section 15.205(c)).

OPERATING FREQUENCY RANGE (MHz)	SPURIOUS EMISSION FREQUENCY (MHz)	LIMIT	
		Peak power ration to emission(dBc)	Emission level(dBuV/m)
902-928	<902	>20	NA
	>928	>20	NA
	960-1240	NA	54
2400-2483.5	<2400	>20	NA
	>2483.5-2500	NA	54
5725-5850	<5350-5460	NA	54
	<5725	>20	NA
	>5850	>20	NA



**Spectrum Research & Testing Lab., Inc.**  
No. 101-10, Ling 8,  
Shan-Tong Li,  
Chung-Li City,  
Taoyuan, Taiwan

## TEST REPORT

Reference No.:A04031803  
Report No.:FCCA04031803  
FCC ID:PQY-4710874200425  
Page:31 of 47  
Date:Jun. 01, 2004

### 4.7.2 TEST EQUIPMENT

The following test equipment was used during the test:

EQUIPMENT/ FACILITIES	SPECIFICATIONS	MANUFACTURER	MODEL#/ SERIAL#	DUE DATE OF CAL. & CAL. CENTER
SPECTRUM	9kHz-7GHz	ROHDE & SCHWARZ	FSP7/ 839511/010	MAR. 2005 ETC
EMI TEST RECEIVER	9 kHz TO 2750 MHz	ROHDE & SCHWARZ	ESCS30/ 830245/012	AUG. 2004 ETC
SPECTRUM	9KHz-26.5GHz	HP	8953E/ 3710A03220	MAY 2005 ETC
PRE-AMPLIFIER	1GHz-26.5GHz Gain:30dB	HP	8449B/ 3008A01019	DEC. 2004 ETC
BI-LOG ANTENNA	25 MHz TO 2 GHz	EMCO	3142/ 9701-1124	APR. 2005 ETC
HORN ANTENNA	1GHz to 18GHz	EMCO	3115/ 9602-4681	NOV. 2004 ETC
OATS	3 - 10 M measurement	SRT	SRT-1	APR. 2005 SRT

**NOTE:** The calibration interval of the above test equipment is one year and the calibrations are traceable to NML/ROC and NIST/USA.



## 4.7.3 TEST SET-UP

### FOR RF CONDUCTED TEST (dBc)

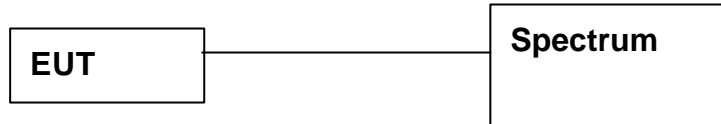

The EUT was connected to the spectrum through a 50 Ω RF cable.

### FOR RADIATED EMISSION TEST

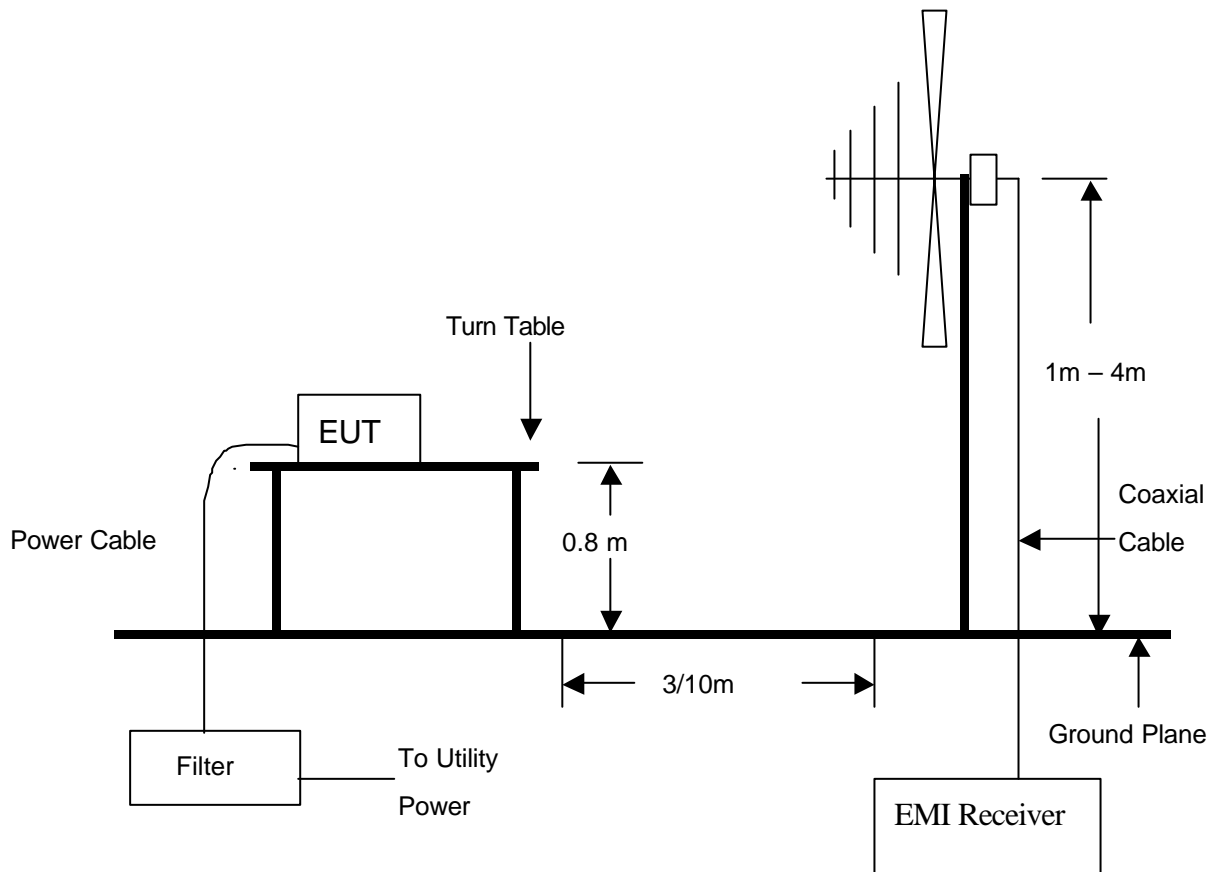

#### NOTE :

1. The EUT system was put on a wooden table with 0.8m heights above a ground plane.
2. For the actual test configuration, please refer to the photos of testing.





**4.7.4 TEST PROCEDURE**

1. The EUT was operating in hopping mode or could be controlled its channel.  
 Printed out the test result from the spectrum by hard copy function.
2. The EUT was tested according to the requirement of ANSI C63.4 and CISPR 22.  
 The measurements were made at an open area test site with 10 meter measurement distance under 1 GHz and with 3m distance above 1GHz. The frequency spectrum measured started from 30 MHz. Under 1 GHz. All readings were quasi-peak values with 120 kHz resolution bandwidth of the test receiver. Above 1 GHz, the measurements were made at an open area test site with 3 meter measurement distance and all readings were peak and average values with 1 MHz resolution bandwidth of the test receiver. The EUT system was operated in all typical methods by users. The cables connected to EUT and support units were moved to find the maximum emission levels for each frequency.

**4.7.5 EUT OPERATING CONDITION**

Same as section 4.1.5 of this report.

**4.7.6 TEST RESULT**

Temperature:	<u>26°C</u>	Humidity:	<u>55%RH</u>
Spectrum Detector:	<u>PK &amp; AV</u>	Tested By	<u>Yujeng Wu</u>
Tested Result	<u>Pass</u>	Tested Date:	<u>May 24, 2004</u>

1. Conducted test

Frequency (MHz)	PEAK POWER OUTPUT (dBm)	Emission read Value(dBm)	Result of Band edge (dBc)	Band edge LIMIT (dBc)
<2400	-7.71	-47.56	39.85	>20dBc
>2483.5	-8.76	-54.85	46.09	>20dBc

2. Radiated emission test

Frequency (MHz)	Antenna polarization (H/V)	PEAK POWER OUTPUT (dBuV/m)	Emission read Value(dBuV/m)	Band edge LIMIT (dBuV/m)
<2400	H	40.7	37.0	54
>2483.5	H	39.6	37.3	54



**Spectrum Research & Testing Lab., Inc.**  
 No. 101-10, Ling 8,  
 Shan-Tong Li,  
 Chung-Li City,  
 Taoyuan, Taiwan

# TEST REPORT

Reference No.:A04031803  
 Report No.:FCCA04031803  
 FCC ID:PQY-4710874200425  
 Page:34 of 47  
 Date:Jun. 01, 2004

<2400MHz:

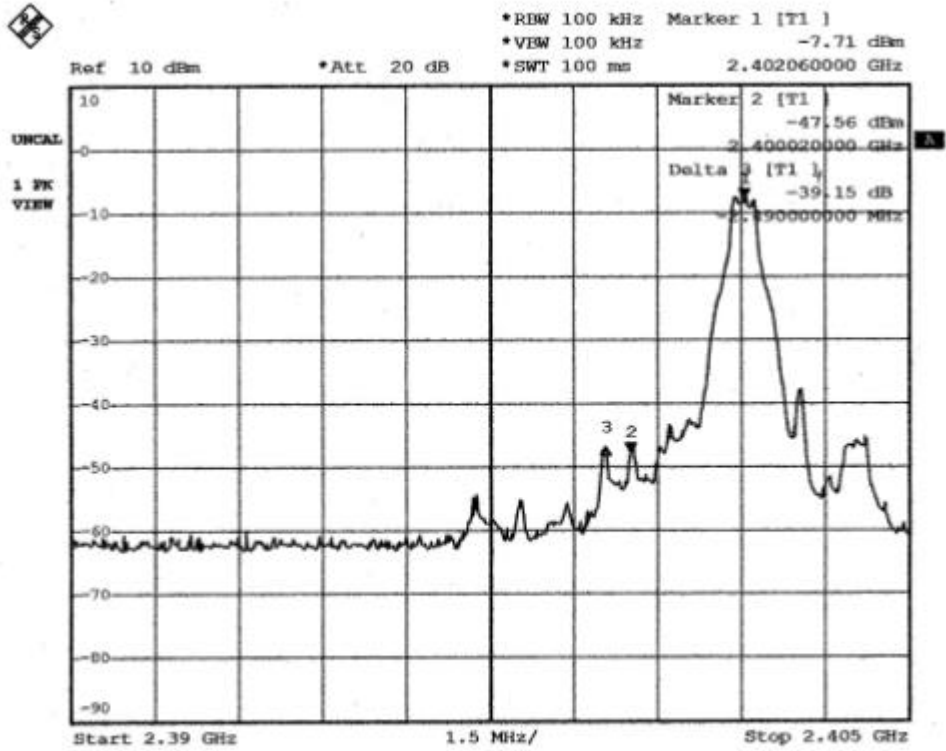

Date: 24.MAR.2004 09:53:40

>2483.5MHz

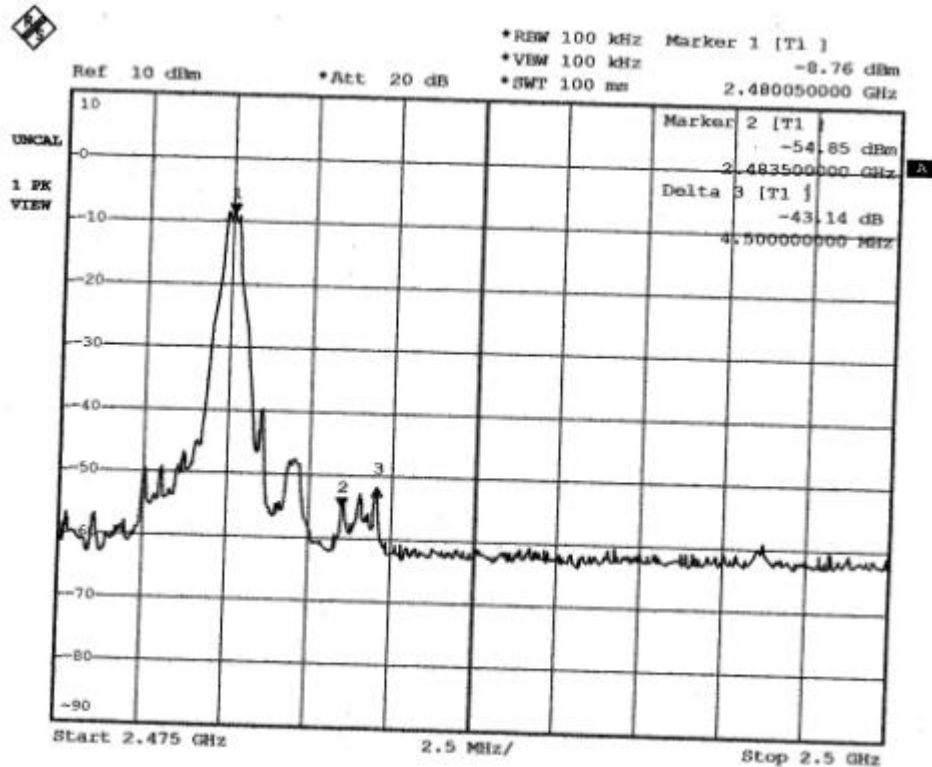

Date: 24.MAR.2004 09:56:40



## 4.8 SPURIOUS RADIATED EMISSION TEST

### 4.8.1 LIMIT

FCC Part15, Subpart C Section 15.209 limit of radiated emission for frequency below1000MHz. The emissions from an intentional radiator shall not exceed the field strength levels specified in the following table:

FREQUENCY (MHz)	DISTANCE (m)	FIELD STRENGTH (dBmV/m)
30 - 88	3	40.0
88 - 216	3	43.5
216 - 960	3	46.0
Above 960	3	54.0

- NOTE:**
- In the emission tables above , the tighter limit applies at the band edges.
  - Distance refers to the distance between measuring instrument , antenna , and the closest point of any part of the device or system.

FCC Part 15, Section15.35(b) limit of radiated emission for frequency above 1000 MHz

FREQUENCY (MHz)	Class A (dBuV/m) (at 3m)		Class B (dBuV/m) (at 3m)	
	PEAK	AVERAGE	PEAK	AVERAGE
Above 1000	80.0	60.0	74.0	54.0

FCC Part 15, Subpart C Section 15.249. The field strength of emissions from intentional radiators operated within these frequency bands shall comply with the following:

FUNDAMENTAL FREQUENCY (MHz)	FILED STRENGTH OF FUNDAMENTAL (dBuV/m) (at 3m)		FIELD STRENGTH OF HARMONICS (dBuV/m) (at 3m)	
	PEAK	AVERAGE	PEAK	AVERAGE
902-928	114	94	74.0	54.0
2400-2483.5	114	94	74.0	54.0
5725-5875	114	94	74.0	54.0
24000-24250	128	108	88.0	68.0

	<b>Spectrum Research &amp; Testing Lab., Inc.</b> No. 101-10, Ling 8, Shan-Tong Li, Chung-Li City, Taoyuan, Taiwan	<h1>TEST REPORT</h1>	Reference No.:A04031803 Report No.:FCCA04031803 FCC ID:PQY-4710874200425 Page:36 of 47 Date:Jun. 01, 2004
---	--	----------------------	---

## 4.8.2 TEST EQUIPMENT

The following test equipment was used during the radiated emission test:

EQUIPMENT/ FACILITIES	SPECIFICATIONS	MANUFACTURER	MODEL#/ SERIAL#	DUE DATE OF CAL. & CAL. CENTER
EMI TEST RECEIVER	9 kHz TO 2750 MHz	ROHDE & SCHWARZ	ESCS30/ 830245/012	AUG. 2004 ETC
SPECTRUM	9KHz-26.5GHz	HP	8953E/ 3710A03220	MAY 2005 ETC
PRE-AMPLIFIER	1GHz-26.5GHz Gain:30dB	HP	8449B/ 3008A01019	DEC. 2004 ETC
BI-LOG ANTENNA	25 MHz TO 2 GHz	EMCO	3142/ 9701-1124	APR. 2005 ETC
HORN ANTENNA	1GHz to 18GHz	EMCO	3115/ 9602-4681	NOV. 2004 ETC
OATS	3 - 10 M measurement	SRT	SRT-1	APR. 2005 SRT
HORN ANTENNA	15GHz TO 40GHz	EMCO	3116/ 2567	JUL. 2004 ETC

### NOTE:

1. The calibration interval of the above test equipment is one year and the calibrations are traceable to NML/ROC and NIST/USA.
2. The Open Area Test Site (SRT-1) is registered by FCC with No. 90957 and VCCI with No. R-1081.
3. The Open Area Test Site (SRT-2) is registered by FCC with No. 98458 and VCCI with No. R-1168.



## 4.8.3 TEST SET-UP

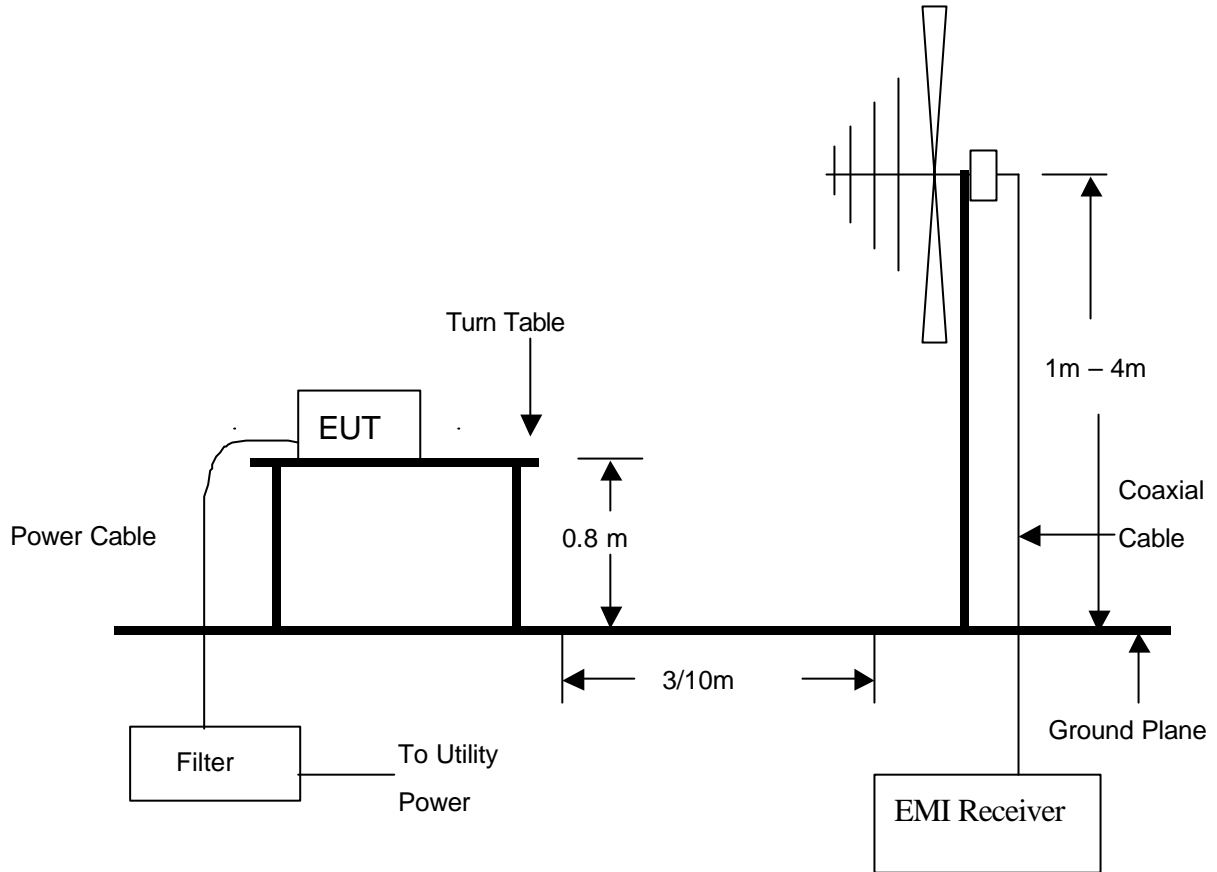

### NOTE :

1. The EUT system was put on a wooden table with 0.8m heights above a ground plane.
2. For the actual test configuration, please refer to the photos of testing.



**Spectrum Research &  
Testing Lab., Inc.**  
No. 101-10, Ling 8,  
Shan-Tong Li,  
Chung-Li City,  
Taoyuan, Taiwan

## **TEST REPORT**

Reference No.:A04031803  
Report No.:FCCA04031803  
FCC ID:PQY-4710874200425  
Page:38 of 47  
Date:Jun. 01, 2004

### **4.8.4 TEST PROCEDURE**

The EUT was tested according to the requirement of ANSI C63.4 and CISPR 22. The measurements were made at an open area test site with 10 meter measurement distance under 1 GHz and with 3m distance above 1GHz. The frequency spectrum measured started from 30 MHz. Under 1 GHz. All readings were quasi-peak values with 120 kHz resolution bandwidth of the test receiver. Above 1 GHz, the measurements were made at an open area test site with 3 meter measurement distance and all readings were peak and average values with 1 MHz resolution bandwidth of the test receiver. The EUT system was operated in all typical methods by users. The cables connected to EUT and support units were moved to find the maximum emission levels for each frequency.

### **4.8.5 EUT OPERATING CONDITION**

Same as section 4.1.5 of this report.



**Spectrum Research & Testing Lab., Inc.**  
 No. 101-10, Ling 8,  
 Shan-Tong Li,  
 Chung-Li City,  
 Taoyuan, Taiwan

## TEST REPORT

Reference No.:A04031803  
 Report No.:FCCA04031803  
 FCC ID:PQY-4710874200425  
 Page:39 of 47  
 Date:Jun. 01, 2004

### 4.8.6 TEST RESULT

Temperature:	<u>21°C</u>	Humidity:	<u>59%RH</u>
Ferquency Range:	<u>30 – 1000 MHz</u>	Tested Mode:	<u>RX</u>
Receiver Detector:	<u>Q.P. or AV.</u>	Measured Distance:	<u>3m</u>
Tested By:	<u>Yujeng Wu</u>	Tested Date:	<u>May 03, 2004</u>

Antenna Polarization:Horizontal

Frequency (MHz)	Cable Loss (dB)	Antenna Factor (dB)	Reading Data (dBμV)	Emission Level (dBμV/m)	Limit (dBμV/m)	Margin (dB)	AZ(°)	EL(m)
132.8200	1.10	8.24	18.3	27.6	43.5	-15.9	215.6	2.40
232.6700	1.42	11.90	17.8	31.1	46.0	-14.9	295.2	1.05
397.5040	1.94	16.26	16.4	34.6	46.0	-11.4	342.7	1.24
454.9500	2.03	17.15	12.1	31.3	46.0	-14.7	350.1	1.20
666.4900	2.50	21.05	11.8	35.4	46.0	-10.6	21.7	1.68
729.8000	2.64	21.70	8.1	32.4	46.0	-13.6	346.8	1.00

Antenna Polarization:Vertical

Frequency (MHz)	Cable Loss (dB)	Antenna Factor (dB)	Reading Data (dBμV)	Emission Level (dBμV/m)	Limit (dBμV/m)	Margin (dB)	AZ(°)	EL(m)
52.4900	0.78	10.38	15.8	27.0	40.0	-13.0	193.4	1.05
132.1200	1.10	8.24	19.2	28.5	43.5	-15.0	302.1	1.07
256.0700	1.47	12.86	17.2	31.5	46.0	-14.5	317.9	1.00
398.8700	1.94	16.27	14.6	32.8	46.0	-13.2	342.8	1.23
454.8600	2.03	17.15	12.9	32.1	46.0	-13.9	82.1	1.69
666.5100	2.50	21.05	10.1	33.7	46.0	-12.3	311.5	1.82

#### NOTE :

1. Measurement uncertainty is +/-2dB.
2. "": Measurement does not apply for this frequency.
3. Emission Level = Reading Value + Ant. Factor + Cable Loss.
4. The field strength of other emission frequencies were very low against the limit.



**Spectrum Research & Testing Lab., Inc.**  
No. 101-10, Ling 8,  
Shan-Tong Li,  
Chung-Li City,  
Taoyuan, Taiwan

# TEST REPORT

Reference No.:A04031803  
Report No.:FCCA04031803  
FCC ID:PQY-4710874200425  
Page:40 of 47  
Date:Jun. 01, 2004

Temperature:	<u>28°C</u>	Humidity:	<u>51%RH</u>
Ferquency Range:	<u>1 – 25 GHz</u>	Tested Mode:	<u>TX: CH0</u>
Receiver Detector:	<u>Q.P. or AV.</u>	Measured Distance:	<u>3m</u>
Tested By:	<u>Yujeng Wu</u>	Tested Date:	<u>May 03, 2004</u>

Antenna Polarization : Horizontal

Frequency (MHz)	Correct Factor (dB)	Antenna Factor (dB/m)	Reading Data (dB $\mu$ V)		Emission Level (dB $\mu$ V/m)		Limit (dB $\mu$ V/m)		Margin (dB)		AZ (°)	EL (m)
			PK.	AV.	PK.	AV.	PK.	AV.	PK.	AV.		
2402.00(F)	-32.16	28.00	91.6	82.8	87.4	78.7	N/A	N/A	N/A	N/A	103.0	1.52
2400.00	-32.16	28.00	65.2	41.2	61.0	37.0	74.0	54.0	-13.0	-17.0	104.0	1.50
2370.00	-32.27	27.94	46.8	32.8	42.5	28.4	74.0	54.0	-31.5	-25.6	111.0	1.67
2434.80	-32.21	28.07	47.2	36.2	43.0	32.0	74.0	54.0	-31.0	-22.0	103.0	1.49
4804.00	-30.47	33.64	45.6	*	48.8	*	74.0	54.0	-25.2	*	153.0	1.00
7206.00	-28.90	36.26	42.2	*	49.5	*	74.0	54.0	-24.5	*	211.0	1.01

Antenna Polarization : Vertical

Frequency (MHz)	Correct Factor (dB)	Antenna Factor (dB/m)	Reading Data (dB $\mu$ V)		Emission Level (dB $\mu$ V/m)		Limit (dB $\mu$ V/m)		Margin (dB)		AZ (°)	EL (m)
			PK.	AV.	PK.	AV.	PK.	AV.	PK.	AV.		
2402.00(F)	-32.16	28.00	86.4	77.6	82.2	73.5	N/A	N/A	N/A	N/A	195.0	1.00
2400.00	-32.16	28.00	60.4	40.7	56.3	36.6	74.0	54.0	-17.8	-17.4	197.0	1.00
2396.70	-32.18	27.99	44.1	34.1	39.9	29.9	74.0	54.0	-34.1	-24.1	242.0	1.01
2385.60	-32.22	27.97	42.7	33.7	38.5	29.5	74.0	54.0	-35.5	-24.5	193.0	1.12
4804.00	-30.47	33.64	46.3	*	49.5	*	74.0	54.0	-24.5	*	82.5	1.28
7206.00	-28.90	36.26	45.1	*	52.5	*	74.0	54.0	-21.5	*	67.3	1.30

## NOTE :

1. Measurement uncertainty is +/-2dB.
2. "\*": Measurement does not apply for this frequency.
3. Emission Level = Reading Value + Ant. Factor + Cable Loss.
4. The field strength of other emission frequencies were very low against the limit.
5. (F):The field strength of fundamental frequency.





**Spectrum Research & Testing Lab., Inc.**  
No. 101-10, Ling 8,  
Shan-Tong Li,  
Chung-Li City,  
Taoyuan, Taiwan

# TEST REPORT

Reference No.:A04031803  
Report No.:FCCA04031803  
FCC ID:PQY-4710874200425  
Page:41 of 47  
Date:Jun. 01, 2004

Temperature:	<u>28°C</u>	Humidity:	<u>51%RH</u>
Ferquency Range:	<u>1 – 25 GHz</u>	Tested Mode:	<u>TX: CH39</u>
Receiver Detector:	<u>Q.P. or AV.</u>	Measured Distance:	<u>3m</u>
Tested By:	<u>Yujeng Wu</u>	Tested Date:	<u>May 03, 2004</u>

Antenna Polarization : Horizontal

Frequency (MHz)	Correct Factor (dB)	Antenna Factor (dB/m)	Reading Data (dB $\mu$ V)		Emission Level (dB $\mu$ V/m)		Limit (dB $\mu$ V/m)		Margin (dB)		AZ (°)	EL (m)
			PK.	AV.	PK.	AV.	PK.	AV.	PK.	AV.		
2441.00(F)	-32.23	28.08	91.6	82.8	87.4	78.7	N/A	N/A	N/A	N/A	265.0	1.47
2400.00	-32.16	28.00	46.4	36.2	42.2	32.0	74.0	54.0	-31.8	-22.0	169.0	1.49
2474.20	-32.20	28.15	50.1	39.5	46.0	35.4	74.0	54.0	-28.0	-18.6	253.0	1.24
2483.50	-32.19	28.17	46.1	33.2	42.1	29.2	74.0	54.0	-31.9	-24.8	78.2	1.27
4882.00	-30.26	33.71	46.2	37.1	49.7	40.5	74.0	54.0	-24.3	-13.5	241.0	1.37
7323.00	-29.04	36.36	44.2	*	51.5	*	74.0	54.0	-22.5	*	45.9	1.59

Antenna Polarization : Vertical

Frequency (MHz)	Correct Factor (dB)	Antenna Factor (dB/m)	Reading Data (dB $\mu$ V)		Emission Level (dB $\mu$ V/m)		Limit (dB $\mu$ V/m)		Margin (dB)		AZ (°)	EL (m)
			PK.	AV.	PK.	AV.	PK.	AV.	PK.	AV.		
2441.00(F)	-32.23	28.08	87.9	79.1	83.7	75.0	N/A	N/A	N/A	N/A	222.0	1.00
2400.00	-32.16	28.00	45.2	36.2	41.1	32.0	74.0	54.0	-32.9	-22.0	221.0	1.00
2473.50	-32.20	28.15	47.5	36.7	43.4	32.6	74.0	54.0	-30.6	-21.4	187.0	1.27
2483.50	-32.19	28.17	44.6	32.7	40.6	28.7	74.0	54.0	-33.4	-25.3	242.0	1.21
4882.00	-30.26	33.71	45.1	*	48.6	*	74.0	54.0	-25.4	*	196.0	1.25
7323.00	-29.04	36.36	43.2	*	50.5	*	74.0	54.0	-23.5	*	53.7	1.30

**NOTE :**

1. Measurement uncertainty is +/-2dB.
2. "\*": Measurement does not apply for this frequency.
3. Emission Level = Reading Value + Ant. Factor + Cable Loss.
4. The field strength of other emission frequencies were very low against the limit.
5. (F):The field strength of fundamental frequency.



**Spectrum Research & Testing Lab., Inc.**  
 No. 101-10, Ling 8,  
 Shan-Tong Li,  
 Chung-Li City,  
 Taoyuan, Taiwan

# TEST REPORT

Reference No.:A04031803  
 Report No.:FCCA04031803  
 FCC ID:PQY-4710874200425  
 Page:42 of 47  
 Date:Jun. 01, 2004

Temperature:	<u>28°C</u>	Humidity:	<u>51%RH</u>
Ferquency Range:	<u>1 – 25 GHz</u>	Tested Mode:	<u>TX: CH78</u>
Receiver Detector:	<u>Q.P. or AV.</u>	Measured Distance:	<u>3m</u>
Tested By:	<u>Yujeng Wu</u>	Tested Date:	<u>May 03, 2004</u>

Antenna Polarization : Horizontal

Frequency (MHz)	Correct Factor (dB)	Antenna Factor (dB/m)	Reading Data (dB $\mu$ V)		Emission Level (dB $\mu$ V/m)		Limit (dB $\mu$ V/m)		Margin (dB)		AZ (°)	EL (m)
			PK.	AV.	PK.	AV.	PK.	AV.	PK.	AV.		
2480.00(F)	-32.19	28.16	94.1	85.3	90.1	81.3	N/A	N/A	N/A	N/A	254.0	1.48
2483.50	-32.19	28.17	52.4	41.3	48.4	37.3	74.0	54.0	-25.6	-16.7	254.0	1.52
2512.50	-32.08	28.27	47.0	34.1	43.2	30.3	74.0	54.0	-30.8	-23.7	241.0	1.21
2400.00	-32.16	28.00	47.1	32.6	42.9	28.4	74.0	54.0	-31.1	-25.6	24.3	1.52
4960.00	-30.26	33.77	48.4	*	51.9	*	74.0	54.0	-22.1	*	24.3	1.52
7440.00	-28.95	36.45	42.1	*	49.6	*	74.0	54.0	-24.4	*	163.0	1.62

Antenna Polarization : Vertical

Frequency (MHz)	Correct Factor (dB)	Antenna Factor (dB/m)	Reading Data (dB $\mu$ V)		Emission Level (dB $\mu$ V/m)		Limit (dB $\mu$ V/m)		Margin (dB)		AZ (°)	EL (m)
			PK.	AV.	PK.	AV.	PK.	AV.	PK.	AV.		
2480.00(F)	-32.19	28.16	87.8	79.0	83.7	75.0	N/A	N/A	N/A	N/A	176.0	1.00
2483.50	-32.19	28.17	47.3	39.6	43.2	35.6	74.0	54.0	-30.8	-18.4	169.0	1.00
2448.30	-32.24	28.10	45.7	36.1	41.5	32.0	74.0	54.0	-32.5	-22.0	175.0	1.04
2400.00	-32.16	28.00	44.1	32.6	39.9	28.4	74.0	54.0	-34.1	-25.6	169.0	1.10
4960.00	-30.26	33.77	45.3	*	48.8	*	74.0	54.0	-25.2	*	153.0	1.24
7440.00	-28.95	36.45	44.2	*	51.7	*	74.0	54.0	-22.3	*	124.0	1.26

**NOTE :**

1. Measurement uncertainty is +/-2dB.
2. "\*": Measurement does not apply for this frequency.
3. Emission Level = Reading Value + Ant. Factor + Cable Loss.
4. The field strength of other emission frequencies were very low against the limit.
5. (F):The field strength of fundamental frequency.



**Spectrum Research &  
Testing Lab., Inc.**  
No. 101-10, Ling 8,  
Shan-Tong Li,  
Chung-Li City,  
Taoyuan, Taiwan

## **TEST REPORT**

Reference No.:A04031803  
Report No.:FCCA04031803  
FCC ID:PQY-4710874200425  
Page:43 of 47  
Date:Jun. 01, 2004

### **3. Antenna application**

#### **5.1 Antenna requirement**

The EUT' s antenna is met the requirement of FCC part15C section15.203 and 15.204.

FCC part15C section15.247 requirement:

Systems operating in the 2400-2483.5 MHz band that are used exclusively for fixed, point-to-point operations may employ transmitting antennas with directional gain greater than 6 dBi provided the maximum peak output power of the intentional radiator is reduced by 1 dB for every 3 dB that the directional gain of the antenna exceeds 6 dBi.

#### **5.2 Result**

The EUT' s antenna used a dipole antenna and integrated on PCB. The antenna' s gain is 1dBi and meets the requirement.



**Spectrum Research & Testing Lab., Inc.**  
No. 101-10, Ling 8,  
Shan-Tong Li,  
Chung-Li City,  
Taoyuan, Taiwan

## TEST REPORT

Reference No.:A04031803  
Report No.:FCCA04031803  
FCC ID:PQY-4710874200425  
Page:44 of 47  
Date:Jun. 01, 2004

### 6. PHOTOS OF TESTING

- Conducted test

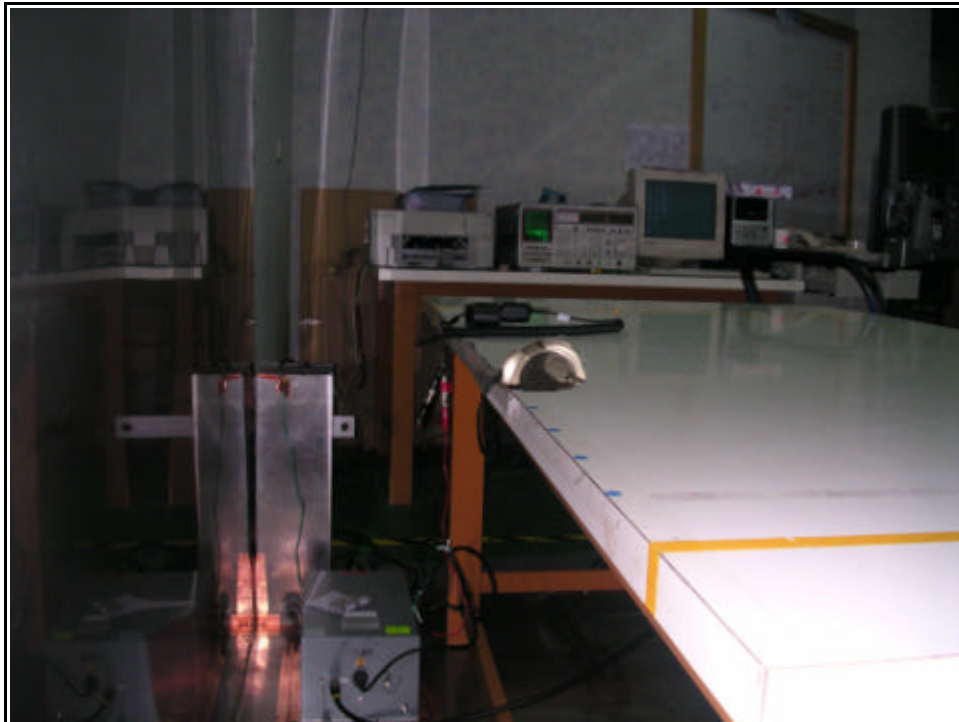
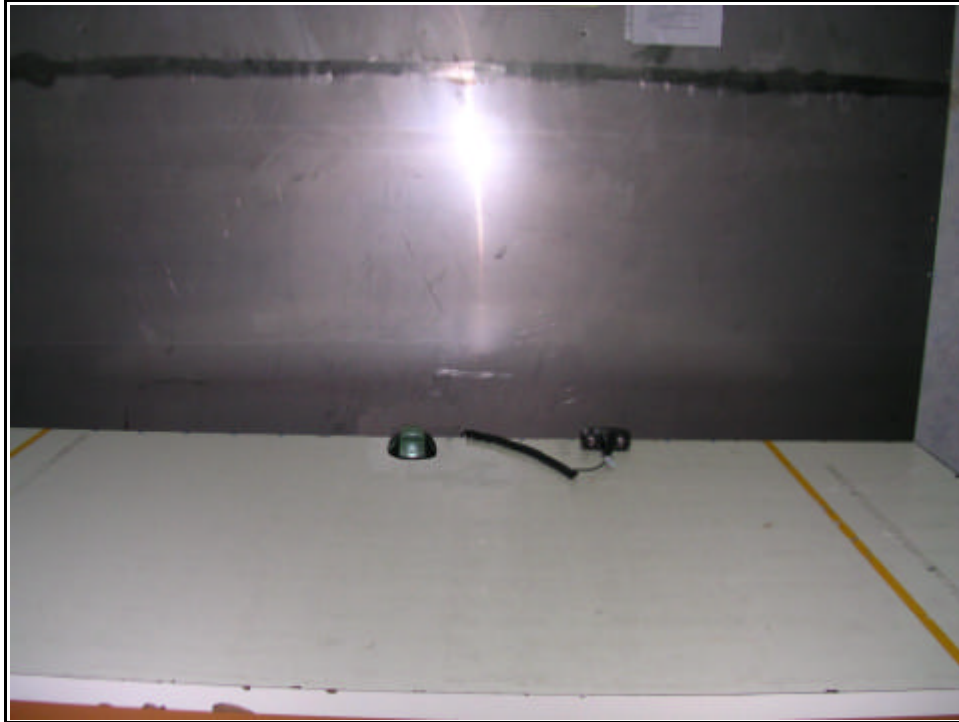



**Spectrum Research & Testing Lab., Inc.**  
No. 101-10, Ling 8,  
Shan-Tong Li,  
Chung-Li City,  
Taoyuan, Taiwan

# TEST REPORT

Reference No.:A04031803  
Report No.:FCCA04031803  
FCC ID:PQY-4710874200425  
Page:45 of 47  
Date:Jun. 01, 2004

- Radiated test (RX)

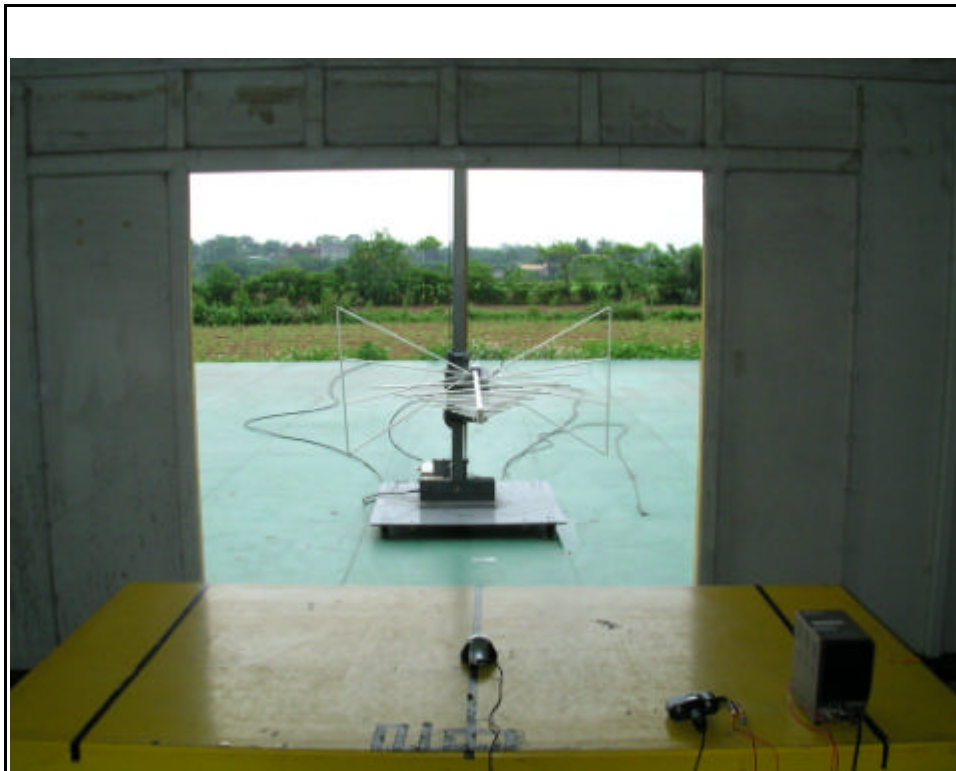
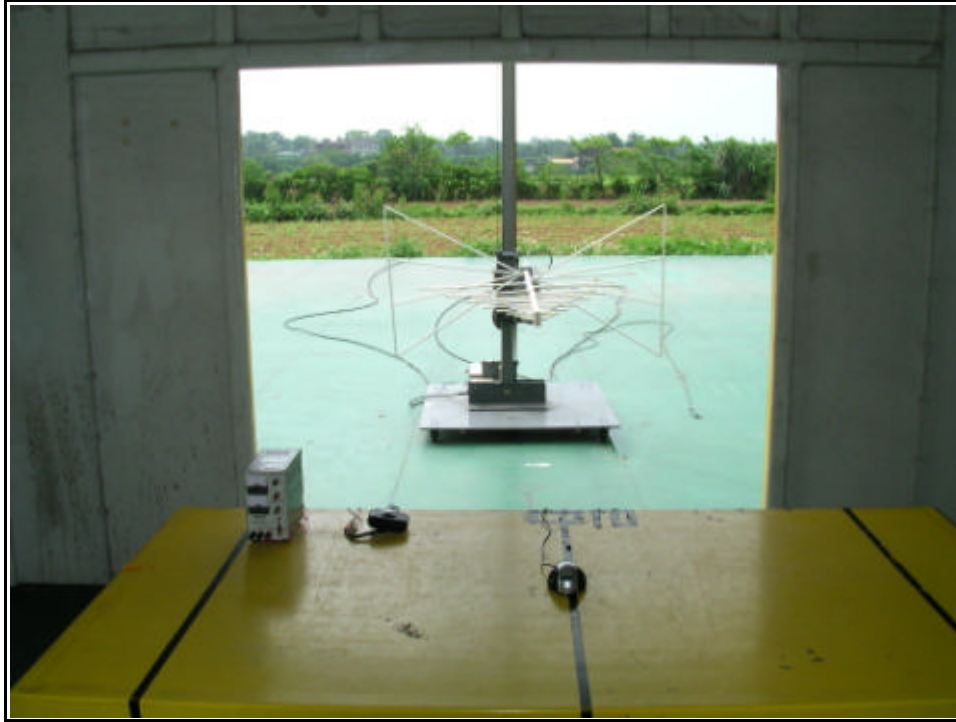



**Spectrum Research & Testing Lab., Inc.**  
No. 101-10, Ling 8,  
Shan-Tong Li,  
Chung-Li City,  
Taoyuan, Taiwan

# TEST REPORT

Reference No.:A04031803  
Report No.:FCCA04031803  
FCC ID:PQY-4710874200425  
Page:46 of 47  
Date:Jun. 01, 2004

- Radiated test (TX)

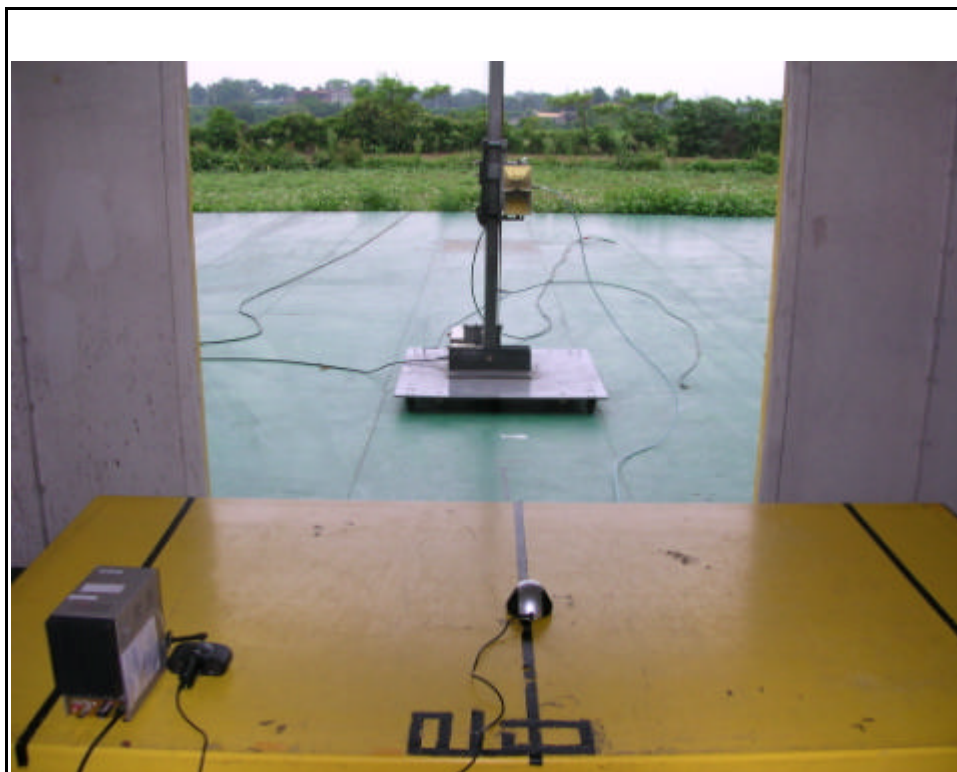
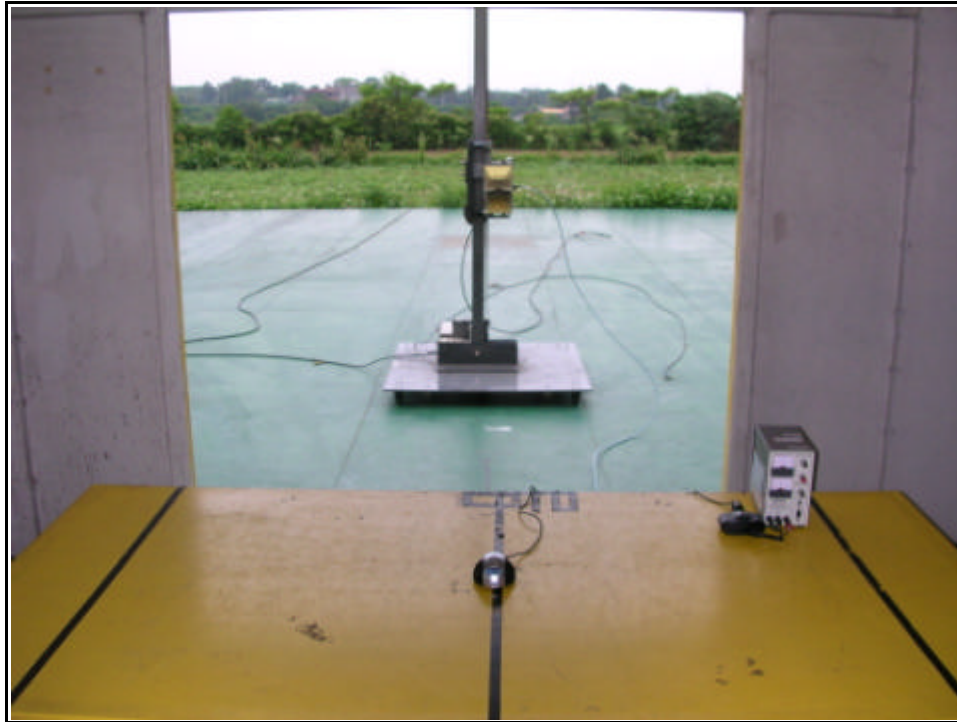



**Spectrum Research & Testing Lab., Inc.**  
No. 101-10, Ling 8,  
Shan-Tong Li,  
Chung-Li City,  
Taoyuan, Taiwan

## TEST REPORT

Reference No.:A04031803  
Report No.:FCCA04031803  
FCC ID:PQY-4710874200425  
Page:47 of 47  
Date:Jun. 01, 2004

### 7. TERMS OF ABRIVATION

AV.	Average detection
AZ(°)	Turn table azimuth
Correct.	Correction
EL(m)	Antenna height (meter)
EUT	Equipment Under Test
Horiz.	Horizontal direction
LISN	Line Impedance Stabilization Network
NSA	Normalized Site Attenuation
Q.P.	Quasi-peak detection
SRT Lab	Spectrum Research & Testing Laboratory, Inc.
Vert.	Vertical direction