



**Spectrum Research & Testing Lab., Inc.**  
No. 101-10, Ling 8,  
Shan-Tong Li, Chung-Li  
City, Taoyuan, Taiwan

## TEST REPORT

Reference No.:A03060503  
Report No.:FCCA03020605-01  
FCC ID:PQY-4710874200258  
Page:1 of 47  
Date: Jun. 25, 2003

Product Name: Bluetooth USB Adapter  
Model Number: BTA-3000  
Applicant: CELLINK CO., LTD.  
11F, NO.102, SEC.1, HSIN TAI WU RD., HSI-CHIH,  
TAIPEI, TAIWAN, R.O.C.  
Date of Receipt: Jun. 05, 2003  
Finished date of Test: Jun. 16, 2003  
Applicable Standards: 47 CFR Part 15, Subpart C  
ANSI C63.4:1992

We, **Spectrum Research & Testing Laboratory Inc.**, hereby certify that one sample of the above was tested in our laboratory with positive results according to the above-mentioned standards. The records in the report are an accurate account of the results. Details of the results are given in the subsequent pages of this report.

Checked By :                     J A                    Foy                     , Date:                     Jun. 25, 2003                      
( Sunyou Chen )

Approved By :                     J H                     , Date:                     6/25/2003                      
( Johnson Ho, Director )

**NVLAP**

Lab Code: 200099-0



## TABLE OF CONTENTS

1. DOCUMENT POLICY AND TEST STATEMENT.....	4
1.1 DOCUMENT POLICY.....	4
1.2 TEST STATEMENT.....	4
2. DESCRIPTION OF EUT AND TEST MODE.....	4
2.1 GENERAL DESCRIPTION OF EUT.....	4
2.3 DESCRIPTION OF TEST MODE.....	5
3. DESCRIPTION OF APPLIED STANDARDS.....	5
4.1 CONDUCTED EMISSION TEST.....	6
4.1.1 LIMIT.....	6
4.1.2 TEST EQUIPMENT.....	6
4.1.3 TEST SETUP.....	7
4.1.4 TEST PROCEDURE.....	7
4.1.5 EUT OPERATING CONDITION.....	7
4.1.6 TEST RESULT.....	8
4.2 RADIATED EMISSION TEST.....	9
4.2.1 LIMIT.....	9
4.2.2 TEST EQUIPMENT.....	10
4.2.3 TEST SET-UP.....	11
4.2.4 TEST PROCEDURE.....	12
4.2.5 EUT OPERATING CONDITION.....	12
4.2.6 TEST RESULT.....	13
4.3 CHANNEL SEPARATION TEST.....	17
4.3.1 LIMIT.....	17
4.3.2 TEST EQUIPMENT.....	17
4.3.3 TEST SET-UP.....	17
4.3.5 EUT OPERATING CONDITION.....	17
4.3.6 TEST RESULT.....	18
4.4 QUANTITY OF HOPPING CHANNEL TEST.....	21
4.4.1 LIMIT.....	21
4.4.2 TEST EQUIPMENT.....	21
4.4.3 TEST SET-UP.....	21
4.4.5 EUT OPERATING CONDITION.....	21
4.4.6 TEST RESULT.....	22
4.5 AVERAGE TIME OF OCCUPANCY TEST.....	23
4.5.1 LIMIT.....	23
4.5.2 TEST EQUIPMENT.....	23
4.5.3 TEST SET-UP.....	23
4.5.5 EUT OPERATING CONDITION.....	23
4.5.6 TEST RESULT.....	24
4.7 PEAK POWER TEST.....	27



# TEST REPORT

4.7.1 LIMIT .....	27
4.7.2 TEST EQUIPMENT.....	27
4.7.3 TEST SET-UP.....	28
4.7.5 EUT OPERATING CONDITION .....	28
4.7.6 TEST RESULT.....	28
4.8 BAND EDGE TEST.....	32
4.8.1 LIMIT .....	32
4.8.2 TEST EQUIPMENT.....	32
4.8.3 TEST SET-UP.....	33
4.8.5 EUT OPERATING CONDITION .....	34
4.8.6 TEST RESULT.....	34
4.9 POWER DENSITY TEST.....	37
4.9.1 LIMIT .....	37
4.9.2 TEST EQUIPMENT.....	37
4.9.3 TEST SET-UP.....	37
4.9.5 EUT OPERATING CONDITION .....	37
4.9.6 TEST RESULT.....	38
4.10 RF POWER EXPOSURE EVALUATION TEST.....	41
4.10.1 LIMIT .....	41
4.10.2 TEST EQUIPMENT .....	42
4.10.3 TEST SET-UP.....	42
4.10.5 EUT OPERATING CONDITION .....	43
4.10.6 RESULT.....	43
5. ANTENNA APPLICATION.....	44
5.1 ANTENNA REQUIREMENT.....	44
5.2 RESULT .....	44
6. TERMS OF ABRIVATION .....	45



## 1. DOCUMENT POLICY AND TEST STATEMENT

### 1.1 DOCUMENT POLICY

- The report shall not be reproduced except in full, without the written approval of SRT Lab, Inc.
- The original FCC ID: PQY-4710874200258 was approved by FCC.  
Date of Grant : 05/06/2003  
The different between new one and old one is changed EUT case.

### 1.2 TEST STATEMENT

- The test results in the report apply only to the unit tested by SRT Lab.
- There was no deviation from the requirements of test standards during the test.
- AC power source, 120 VAC/60 Hz, was used during the test.

## 2. DESCRIPTION OF EUT AND TEST MODE

### 2.1 GENERAL DESCRIPTION OF EUT

<b>PRODUCT</b>	Bluetooth USB Adapter
<b>MODEL NO.</b>	BTA-3000
<b>POWER SUPPLY</b>	5Vdc from USB port of PC system
<b>CABLE</b>	N/A
<b>I/O PORT</b>	USB interface
<b>FREQUENCY BAND</b>	2400~2483.5MHz
<b>CARRIER FREQUENCY</b>	CH0: 2402MHz~CH78: 2480MHz
<b>NUMBER OF CHANNEL</b>	79
<b>CHANNEL SPACING</b>	1MHz
<b>RATED RF OUTPUT POWER</b>	0.02mW
<b>I.F. &amp; L.O.</b>	I.F.: 0MHz, L.O.:2402~2480MHz
<b>MODULATION TYPE</b>	GFSK (FHSS)
<b>BIT RATE OF TRANSMISSION</b>	743Kbps
<b>ANTENNA TYPE</b>	Dipole antenna
<b>ANTENNA GAIN</b>	2 dBi

**NOTE:** For more detailed features, please refer to the manufacturer' s specification or User' s Manual of EUT.



## 2.2 DESCRIPTION OF SUPPORT UNIT

The transmitter part of EUT was tested with a PC system and configured by the requirement of ANSI C63.4. All interface ports were connected to the appropriate support units via specific cables. The support units and cables are listed below.

NO	DEVICE	BRAND	MODEL #	FCC ID / DOC	CABLE
1.	Notebook	DELL	PP01L/ 3F438A01	DOC	1.8m unshielded AC power cable 1.8m unshielded DC power cable
2	PRINTER	EPSON	P310B	DOC	1.5m unshielded power cord 1.2m shielded data cable
3	MODEM	DATATRONICS	1200CK	E2050V1200CK	1.5m unshielded DC power cable 1.2m shielded data cable

**NOTE :** For the actual test configuration, please refer to the photos of testing.

## 2.3 DESCRIPTION OF TEST MODE

79 channels are provided by EUT. The 3 channels of lower, medium and higher were chosen for test.

Channel	Frequency(MHz)
0	2402
39	2441
78	2480

**NOTE :**

1. Below 1 GHz, the channel 0, 39, and 78 were pre-tested in chamber. The channel 78, worst case one, was chosen for conducted and radiated emission test.
2. Above 1 GHz, the channel 0, 39 and 78 were tested individually

## 3. DESCRIPTION OF APPLIED STANDARDS

The EUT is a kind of wireless product and to be connected with a PC system for normal use. According to the specifications provided by the applicant, it must comply with the requirements of the following standards:

47 CFR Part 15, Subpart C  
ANSI C63.4:1992

All tests have been performed and recorded as the above standards.



## 4 TECHNICAL CHARACTERISTICS TEST

### 4.1 CONDUCTED EMISSION TEST

#### 4.1.1 LIMIT

Frequency (MHz)	Class A (dB $\mu$ V)		Class B (dB $\mu$ V)	
	Quasi-peak	Average	Quasi-peak	Average
0.15 - 0.5	79	66	66 - 56	56 - 46
0.50 - 5.0	73	60	56	46
5.0 - 30.0	73	60	60	50

#### NOTE :

1. The lower limit shall apply at the transition frequencies.
2. The limit decreases in line with the logarithm of the frequency in the range of 0.15 to 0.50 MHz.

#### 4.1.2 TEST EQUIPMENT

The following test equipment was used for the test:

EQUIPMENT/ FACILITIES	SPECIFICATIONS	MANUFACTURER	MODEL#/ SERIAL#	DUE DATE OF CAL. & CAL. CENTER
EMI TEST RECEIVER	9 kHz TO 30 MHz	ROHDE & SCHWARZ	ESHS30/ 826003/008	JUL. 2003 R&S
LISN (for EUT)	50 $\mu$ H, 50 ohm	SOLAR ELECTRONICS	8012-50-R-24-BNC / 924839	JUN. 2004 ETC
LISN (for Peripheral)	50 $\mu$ H, 50 ohm	SOLAR ELECTRONICS	9252-50-R-24-BNC / 951318	JUN. 2004 ETC
50 ohm TERMINATOR	50 ohm	HP	11593A/ 2	MAY 2004 ETC
COAXIAL CABLE	3m	SUNCITY	J400/ 3M	JUL. 2003 SRT
ISOLATION TRANSFORMER	N/A	APC	AFC-11015/ F102040016	N/A
FILTER	2 LINE, 30A	FIL.COIL	FC-943/ 771	N/A
GROUND PLANE	2.3M (H) x 2.4M (W)	SRT	N/A	APR. 2004 SRT
GROUND PLANE	2.4M (H) x 2.4M (W)	SRT	N/A	APR. 2004 SRT

**NOTE :** The calibration interval of the above test equipment is one year and the calibrations are traceable to NML/ROC and NIST/USA.



## 4.1.3 TEST SETUP

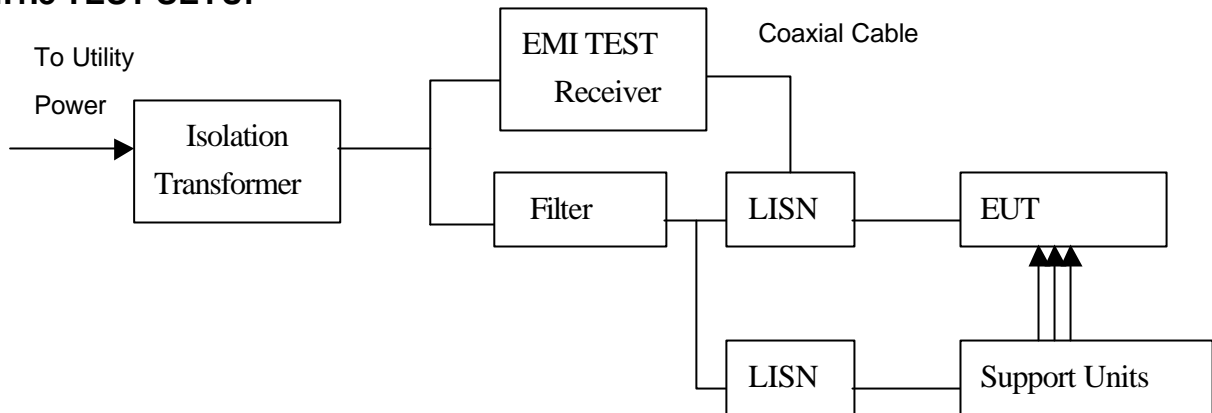

### NOTE :

1. The EUT was put on a wooden table with 0.8m height above ground plane, and 0.4m away from reference ground plane (> 2mx2m).
2. For the actual test configuration, please refer to the photos of testing.

## 4.1.4 TEST PROCEDURE

The EUT was tested according to the requirement of ANSI C63.4:1992 and CISRP22:1997. The frequency spectrum from 0.15 MHz to 30 MHz was investigated. The LISN used was 50 ohm/50 $\mu$ H as specified. All readings were quasi-peak and average values with 10 kHz resolution bandwidth of the test receiver. The EUT system was operated in all typical methods by users. Both lines of the power mains of EUT were measured and the cables connected to EUT and support units were moved to find the maximum emission levels for each frequency. First, Find the margin or higher points at least 6 points by software, then use manual to find the maximum data. The procedure is referred on the test procedure of SRT LAB..

## 4.1.5 EUT OPERATING CONDITION

Set the EUT under transmission condition continuously at a specific channel frequency.

Under Windows XP ran "EMI TEST" program, PC sent "H" pattern or accessed the following peripherals :

- RS232 (modem)
- Printer
- FDD
- HDD



## 4.1.6 TEST RESULT

Temperature:	<u>26 °C</u>	Humidity:	<u>53 %RH</u>
Ferquency Range:	<u>0.15 – 30 MHz</u>	Test Mode:	<u>CH78</u>
Receiver Detector:	<u>Q.P. and AV.</u>	Tested By:	<u>Ken Su</u>

### Power Line Measured : Line

Freq. (MHz)	Correct. Factor (dB)	Reading Value (dB $\mu$ V)		Emission Level (dB $\mu$ V)		Limit (dB $\mu$ V)		Margin (dB)	
		Q.P.	AV.	Q.P.	AV.	Q.P.	AV.	Q.P.	AV.
0.174	0.20	46.8	38.1	47.0	38.3	64.8	54.8	-17.8	-16.5
0.710	0.20	26.1	21.9	26.3	22.1	56.0	46.0	-29.7	-23.9
3.660	0.26	30.7	20.2	31.0	20.5	56.0	46.0	-25.0	-25.5
4.530	0.31	21.8	15.6	22.1	15.9	56.0	46.0	-33.9	-30.1
13.780	0.47	21.4	14.8	21.9	15.3	60.0	50.0	-38.1	-34.7
19.990	0.60	29.2	20.5	29.8	21.1	60.0	50.0	-30.2	-28.9

### Power Line Measured : Neutral

Freq. (MHz)	Correct. Factor (dB)	Reading Value (dB $\mu$ V)		Emission Level (dB $\mu$ V)		Limit (dB $\mu$ V)		Margin (dB)	
		Q.P.	AV.	Q.P.	AV.	Q.P.	AV.	Q.P.	AV.
0.176	0.20	48.1	37.9	48.3	38.1	64.7	54.7	-16.4	-16.6
0.408	0.20	31.2	25.6	31.4	25.8	57.7	47.7	-26.3	-21.9
0.580	0.20	27.3	15.0	27.5	15.2	56.0	46.0	-28.5	-30.8
1.030	0.20	22.1	14.1	22.3	14.3	56.0	46.0	-33.7	-31.7
12.950	0.46	24.5	16.5	25.0	17.0	60.0	50.0	-35.0	-33.0
22.980	0.66	25.7	20.2	26.4	20.9	60.0	50.0	-33.6	-29.1

### NOTE :

1. Measurement uncertainty is +/-2dB
2. Emission level = Reading value + Correction factor
3. Correction Factor = Cable loss + Insertion loss of LISN
4. Margin value = Emission level - Limit
5. The emission of other frequencies were very low against the limit.
6. "-": The Quasi-peak reading value also meets average limit and measurement with the average detector is unnecessary.





## 4.2 RADIATED EMISSION TEST

### 4.2.1 LIMIT

FCC Part15, Subpart C Section 15.209 limit of radiated emission for frequency below1000MHz. The emissions from an intentional radiator shall not exceed the field strength levels specified in the following table:

FREQUENCY (MHz)	DISTANCE (m)	FIELD STRENGTH (dBmV/m)
30 - 88	3	40.0
88 - 216	3	43.5
216 - 960	3	46.0
ABOVE 960	3	54.0

- NOTE** :
1. In the emission tables above , the tighter limit applies at the band edges.
  2. Distance refers to the distance between measuring instrument , antenna , and the closest point of any part of the device or system.

FCC Part 15, Section15.35(b) limit of radiated emission for frequency above 1000 MHz

FREQUENCY (MHz)	Class A (dBuV/m) (at 3m)		Class B (dBuV/m) (at 3m)	
	PEAK	AVERAGE	PEAK	AVERAGE
Above 1000	80.0	60.0	74.0	54.0

FCC Part 15, Subpart C Section 15.249. The field strength of emissions from intentional radiators operated within these frequency bands shall comply with the following:

FUNDAMENTAL FREQUENCY (MHz)	FILED STRENGTH OF FUNDAMENTAL (dBuV/m) (at 3m)		FIELD STRENGTH OF HARMONICS (dBuV/m) (at 3m)	
	PEAK	AVERAGE	PEAK	AVERAGE
902-928	114	94	74.0	54.0
2400-2483.5	114	94	74.0	54.0
5725-5875	114	94	74.0	54.0
24000-24250	128	108	88	68



## 4.2.2 TEST EQUIPMENT

The following test equipment was used during the radiated emission test :

EQUIPMENT/ FACILITIES	SPECIFICATIONS	MANUFACTURER	MODEL#/ SERIAL#	DUE DATE OF CAL. & CAL. CENTER
EMI TEST RECEIVER	9 kHz TO 2750 MHz	ROHDE & SCHWARZ	ESCS30/ 830245/012	AUG. 2003 R&S
SPECTRUM	9KHz-26.5GHz	HP	8953E/ 3710A03220	MAY. 2004 ETC
PRE-AMPLIFIER	1GHz-26.5GHz Gain:30dB	HP	8449B/ 3008A01019	DEC. 2003 ETC
BI-LOG ANTENNA	25 MHz TO 2 GHz	EMCO	3142/ 9701-1124	APR. 2004 SRT
HORN ANTENNA	1GHz to 18GHz	EMCO	3115/ 9602-4681	DEC. 2003 ETC
OATS	3 – 10 M MEASUREMENT	SRT	SRT-1	APR. 2004 SRT
COAXIAL CABLE	25M	SUNCITY	J400/ 25M	JUL. 2003 SRT
FILTER	2 LINE, 30A	FIL.COIL	FC-943/ 869	N/A
FREQUENCY CONVERTER	N/A	APC	AFC-1KW/ 860612	JUL. 2003 SRT

### NOTE:

1. The calibration interval of the above test equipment is one year and the calibrations are traceable to NML/ROC and NIST/USA.
2. The Open Area Test Site (SRT-1) is registered by FCC with No. 90957 and VCCI with No. R-1081.
3. The Open Area Test Site (SRT-2) is registered by FCC with No. 98458 and VCCI with No. R-1168.



## 4.2.3 TEST SET-UP

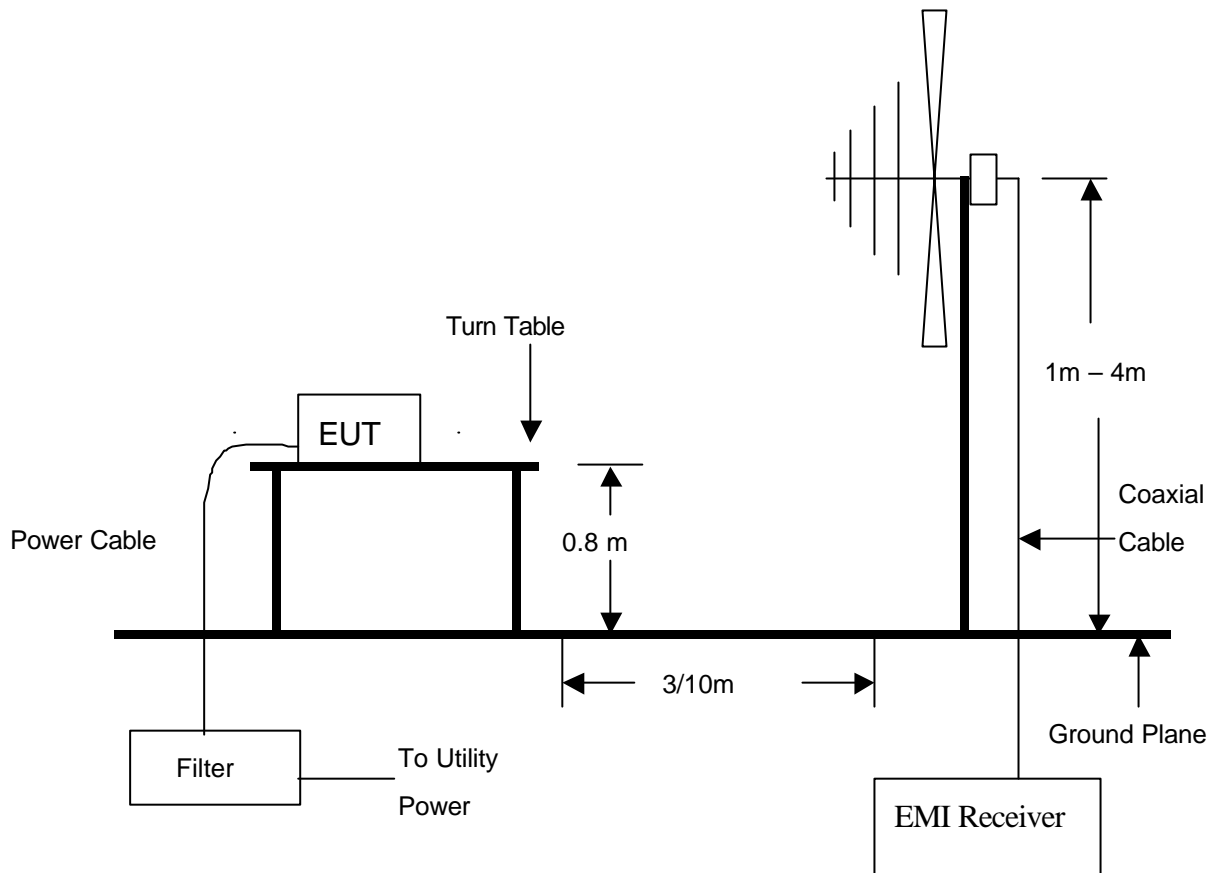

**NOTE :**

1. The EUT system was put on a wooden table with 0.8m heights above a ground plane.
2. For the actual test configuration, please refer to the photos of testing.



**Spectrum Research &  
Testing Lab., Inc.**  
No. 101-10, Ling 8,  
Shan-Tong Li, Chung-Li  
City, Taoyuan, Taiwan

## **TEST REPORT**

Reference No.:A03060503  
Report No.:FCCA03020605-01  
FCC ID:PQY-4710874200258  
Page:12 of 45  
Date:Jun. 25, 2003

### **4.2.4 TEST PROCEDURE**

The EUT was tested according to the requirement of ANSI C63.4 and CISPR 22. The measurements were made at an open area test site with 10 meter measurement distance under 1 GHz and with 3m distance above 1GHz. The frequency spectrum measured started from 30 MHz. Under 1 GHz. All readings were quasi-peak values with 120 kHz resolution bandwidth of the test receiver. Above 1 GHz, the measurements were made at an open area test site with 3 meter measurement distance and all readings were peak and average values with 1 MHz resolution bandwidth of the test receiver. The EUT system was operated in all typical methods by users. The cables connected to EUT and support units were moved to find the maximum emission levels for each frequency.

### **4.2.5 EUT OPERATING CONDITION**

Same as section 4.1.5 of this report.



## 4.2.6 TEST RESULT

Temperature: 23°C Humidity: 51%RH  
 Frequency Range: 30 – 1000 MHz Test mode: CH78  
 Receiver Detector: Q.P. or AV. Measured Distance: 3m  
 Tested by: Ken Su

### Antenna Polarization : Horizontal

Frequency (MHz)	Cable Loss (dB)	Antenna Factor (dB/m)	Reading Data (dBμV)	Emission Level (dBμV/m)	Limit (dBμV/m)	Margin (dB)	EL(m)	AZ(°)
65.7485	1.02	8.35	25.6	35.0	40.0	-5.0	360.0	4.0
232.5990	1.89	11.90	15.0	28.8	47.0	-18.2	360.9	1.37
265.7688	1.94	13.18	17.4	32.5	47.0	-14.5	0	1.00
398.6050	2.64	16.27	16.5	35.4	47.0	-11.6	360.9	1.00
451.7388	2.57	17.08	13.5	33.1	47.0	-13.9	352.8	4.00
669.2330	2.53	21.13	18.2	41.9	47.0	-5.1	310.8	3.40

### Antenna Polarization : Vertical

Frequency (MHz)	Cable Loss (dB)	Antenna Factor (dB/m)	Reading Data (dBμV)	Emission Level (dBμV/m)	Limit (dBμV/m)	Margin (dB)	EL(m)	AZ(°)
66.8675	1.02	8.28	17.6	26.9	40.0	-13.1	114.2	4.00
128.5596	1.36	8.22	18.5	28.1	43.5	-15.4	25.0	1.20
183.6620	1.60	9.92	19.1	30.6	43.5	-122.9	235.0	1.21
193.2466	1.60	10.29	9.5	21.4	40.0	-18.6	0	1.00
232.5133	1.89	11.90	8.5	22.3	47.0	-24.7	231.3	1.00
451.7413	2.57	17.08	20.0	39.6	47.0	-7.4	79.4	2.94

- NOTE :**
1. Measurement uncertainty is less than 4dB
  2. "\*\*": Measurement does not apply for this frequency.
  3. Emission Level = Reading Value + Ant. Factor + Cable Loss
  4. The field strength of other emission frequencies were very low against the limit.



**Spectrum Research & Testing Lab., Inc.**  
No. 101-10, Ling 8,  
Shan-Tong Li, Chung-Li  
City, Taoyuan, Taiwan

# TEST REPORT

Reference No.:A03060503  
Report No.:FCCA03020605-01  
FCC ID:PQY-4710874200258  
Page:14 of 45  
Date:Jun. 25, 2003

Temperature: 23° C Humidity: 51%RH  
 Frequency Range: 1 – 25 GHz Test mode: Ch0  
 Receiver Detector: PK. or AV. Measured Distance: 3m  
 Tested by: Ken Su

Antenna Polarization : Horizontal

Freq./MHz	Cable Loss (dB)	Ant. Fact. (dB)	Reading (dBuV)		Emission (dBuV/m)		Limit Line (dBuV/m)		Margin (dBuV/m)		AZ (o)	EL (m)
			PK	AV	PK	AV	PK	AV	PK	AV		
2402.00(F)	-32.16	28.54	81.1	51.5	77.5	47.9	N/A	N/A	N/A	N/A	23.3	1.0
2355.00	-32.33	27.91	50.1	*	45.7	*	74.0	54.0	-28.3	*	46.8	1.0
2463.23	-32.22	28.13	49.4	*	45.3	*	74.0	54.0	-28.7	*	45.0	1.0
4804.00	-30.47	33.64	45.2	*	48.4	*	74.0	54.0	-25.6	*	25.1	1.05
7206.00	-28.90	36.26	47.6	*	55.0	*	74.0	54.0	-19.0	*	28.5	1.2

Antenna Polarization : Vertical

Freq/MHz	Cable Loss (dB)	Ant. Fact. (dB)	Reading (dBuV)		Emission (dBuV/m)		Limit Line (dBuV/m)		Margin (dBuV/m)		AZ (o)	EL (m)
			PK	AV	PK	AV	PK	AV	PK	AV		
2402.00(F)	-32.16	28.00	79.1	52.6	74.9	48.4	N/A	N/A	N/A	N/A	58.1	1.73
2328.10	-32.35	27.86	48.8	*	44.3	*	74.0	54.0	-29.7	*	56.4	1.7
2435.60	-32.22	28.07	49.1	*	45.0	*	74.0	54.0	-29.0	*	57.0	1.5
4804.00	-30.47	33.64	45.6	*	48.8	*	74.0	54.0	-25.2	*	60.4	1.72
7206.00	-28.90	36.26	46.7	*	54.1	*	74.0	54.0	-19.9	*	65.2	1.65

- NOTE :**
1. Measurement uncertainty is less than 4dB
  2. "\*\*": Measurement does not apply for this frequency.
  3. Emission Level = Reading Value + Ant. Factor + Cable Loss
  4. The field strength of other emission frequencies were very low against the limit.
  - 5.(F):The field strength of fundamental frequency.



# TEST REPORT

Temperature:	<u>23°C</u>	Humidity:	<u>55%RH</u>
Ferquency Range:	<u>1 – 25 GHz</u>	Test mode:	<u>Ch39</u>
Receiver Detector:	<u>PK. or AV.</u>	Measured Distance:	<u>3m</u>
Tested by:	<u>Ken Su</u>		

## Antenna Polarization : Horizontal

Freq./MHz	Cable Loss (dB)	Ant. Fact. (dB)	Reading (dBuV)		Emission (dBuV/m)		Limit Line (dBuV/m)		Margin (dBuV/m)		AZ (o)	EL (m)
			PK	AV	PK	AV	PK	AV	PK	AV		
2441.00(F)	-32.22	28.62	80.8	52.9	77.2	49.3	N/A	N/A	N/A	N/A	51.7	2.05
2408.00	-32.17	28.02	53.6	40.1	49.4	35.9	74.0	54.0	-24.6	-18.1	50.7	2.05
2422.60	-32.20	28.04	56.3	42.8	52.1	38.6	74.0	54.0	-21.9	-15.4	51.7	2.0
4882.00	-30.26	33.71	45.8	*	49.2	*	74.0	54.0	-24.8	*	50.1	1.95
7323.10	-29.04	36.36	48.0	*	55.3	*	74.0	54.0	-18.7	*	45.0	1.8

## Antenna Polarization : Vertical

Freq./MHz	Cable Loss (dB)	Ant. Fact. (dB)	Reading (dBuV)		Emission (dBuV/m)		Limit Line (dBuV/m)		Margin (dBuV/m)		AZ (o)	EL (m)
			PK	AV	PK	AV	PK	AV	PK	AV		
2441.00(F)	-32.23	29.87	85.9	54.7	83.5	52.2	N/A	N/A	N/A	N/A	314.6	1.08
2425.00	-32.20	28.05	56.9	40.1	52.7	35.9	74.0	54.0	-21.3	-18.1	311.0	1.0
2463.10	-32.22	28.13	53.2	41.7	49.1	37.6	74.0	54.0	-24.9	-16.4	326.0	1.0
4882.00	-30.26	33.71	46.9	*	50.3	*	74.0	54.0	-23.7	*	305.4	1.2
7323.10	-29.04	36.36	44.7	*	52.0	*	74.0	54.0	-22.0	*	310.5	1.2

- NOTE :**
1. Measurement uncertainty is less than 4dB
  2. "\*\*": Measurement does not apply for this frequency.
  3. Emission Level = Reading Value + Ant. Factor + Cable Loss
  4. The field strength of other emission frequencies were very low against the limit.
  - 5.(F):The field strength of fundamental frequency.



# TEST REPORT

Temperature: 25°C Humidity: 50%RH  
 Frequency Range: 1 – 25 GHz Test mode: Ch78  
 Receiver Detector: PK. or AV. Measured Distance: 3m  
 Tested by: Ken Su

## Antenna Polarization : Horizontal

Freq./MHz	Cable Loss (dB)	Ant. Fact. (dB)	Reading (dBuV)		Emission (dBuV/m)		Limit Line (dBuV/m)		Margin (dBuV/m)		AZ (o)	EL (m)
			PK	AV	PK	AV	PK	AV	PK	AV		
2480.00(F)	-32.19	28.73	82.5	52.0	79.0	48.5	N/A	N/A	N/A	N/A	314.6	1.29
2388.00	-32.21	27.98	52.1	42.1	47.9	37.9	74.0	54.0	-26.1	-16.1	334.0	1.29
2483.50	-32.19	28.17	48.7	*	44.7	*	74.0	54.0	-29.3	*	316.0	1.29
4960.00	-30.26	33.77	44.8	*	48.3	*	74.0	54.0	-25.7	*	313.2	1.25
7440.00	-28.95	36.45	47.3	*	54.8	*	74.0	54.0	-19.2	*	315.2	1.2

## Antenna Polarization : Vertical

Freq./MHz	Cable Loss (dB)	Ant. Fact. (dB)	Reading (dBuV)		Emission (dBuV/m)		Limit Line (dBuV/m)		Margin (dBuV/m)		AZ (o)	EL (m)
			PK	AV	PK	AV	PK	AV	PK	AV		
2480.00(F)	-32.19	28.16	81.4	51.9	77.3	47.9	N/A	N/A	N/A	N/A	63.5	1.96
2425.00	-32.20	28.05	52.7	40.1	48.5	35.9	74.0	54.0	-25.5	-18.1	63.5	1.96
2483.50	-32.19	28.17	49.2	*	45.2	*	74.0	54.0	-28.8	*	65.0	1.9
4960.00	-30.26	33.77	45.8	*	49.3	*	74.0	54.0	-24.7	*	59.1	1.85
7440.00	-28.95	36.45	46.2	*	53.7	*	74.0	54.0	-20.3	*	65.2	1.9

- NOTE :**
1. Measurement uncertainty is less than +/- 4dB
  2. "\*\*": Measurement does not apply for this frequency.
  3. Emission Level = Reading Value + Ant. Factor + Cable Loss
  4. The field strength of other emission frequencies were very low against the limit.
  - 5.(F):The field strength of fundamental frequency.





## 4.3 CHANNEL SEPARATION TEST

### 4.3.1 LIMIT

FCC Part15, Subpart C Section 15.247(a)(1) . Frequency hopping systems shall have hopping channel carrier frequencies separated by a minimum of 25 kHz or the 20 dB bandwidth of the hopping channel, whichever is greater.

FREQUENCY RANGE (MHz)	Limit(kHz)
902-928	>25kHz
2400-2483.5	>25kHz
5725-5850	>25kHz

### 4.3.2 TEST EQUIPMENT

The following test equipment was used during the radiated emission test :

EQUIPMENT/ FACILITIES	SPECIFICATIONS	MANUFACTURER	MODEL#/ SERIAL#	DUE DATE OF CAL. & CAL. CENTER
SPECTRUM	9kHz-7GHz	ROHDE & SCHWARZ	FSP7/ 839511/010	MAR.2004 R & S

**NOTE:** The calibration interval of the above test equipment is one year and the calibrations are traceable to NML/ROC and NIST/USA.

### 4.3.3 TEST SET-UP

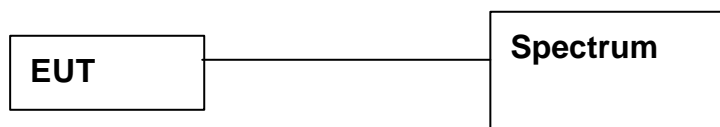

The EUT was connected to a spectrum through a 50 RF cable.

### 4.3.4 TEST PROCEDURE

The EUT was operating in hopping mode or could be controlled its channel. Printed out the test result from the spectrum by hard copy function.

### 4.3.5 EUT OPERATING CONDITION

Same as section 4.1.5 of this report.



**Spectrum Research & Testing Lab., Inc.**  
 No. 101-10, Ling 8,  
 Shan-Tong Li, Chung-Li  
 City, Taoyuan, Taiwan

# TEST REPORT

Reference No.:A03060503  
 Report No.:FCCA03020605-01  
 FCC ID:PQY-4710874200258  
 Page:18 of 45  
 Date:Jun. 25, 2003

## 4.3.6 TEST RESULT

Temperature: 25°C Humidity: 60%RH  
 Spectrum Detector: PK Tested by Ken Su  
 Test Result PASS

CHANNEL NUMBER	CHANNEL FREQUENCY (MHz)	SEPARATION READ VALUE (kHz)	SEPARATION LIMIT (kHz)
0	2402	1000.000	>25kHz
39	2441	1000.000	>25kHz
78	2479	1000.000	>25kHz

CH0:

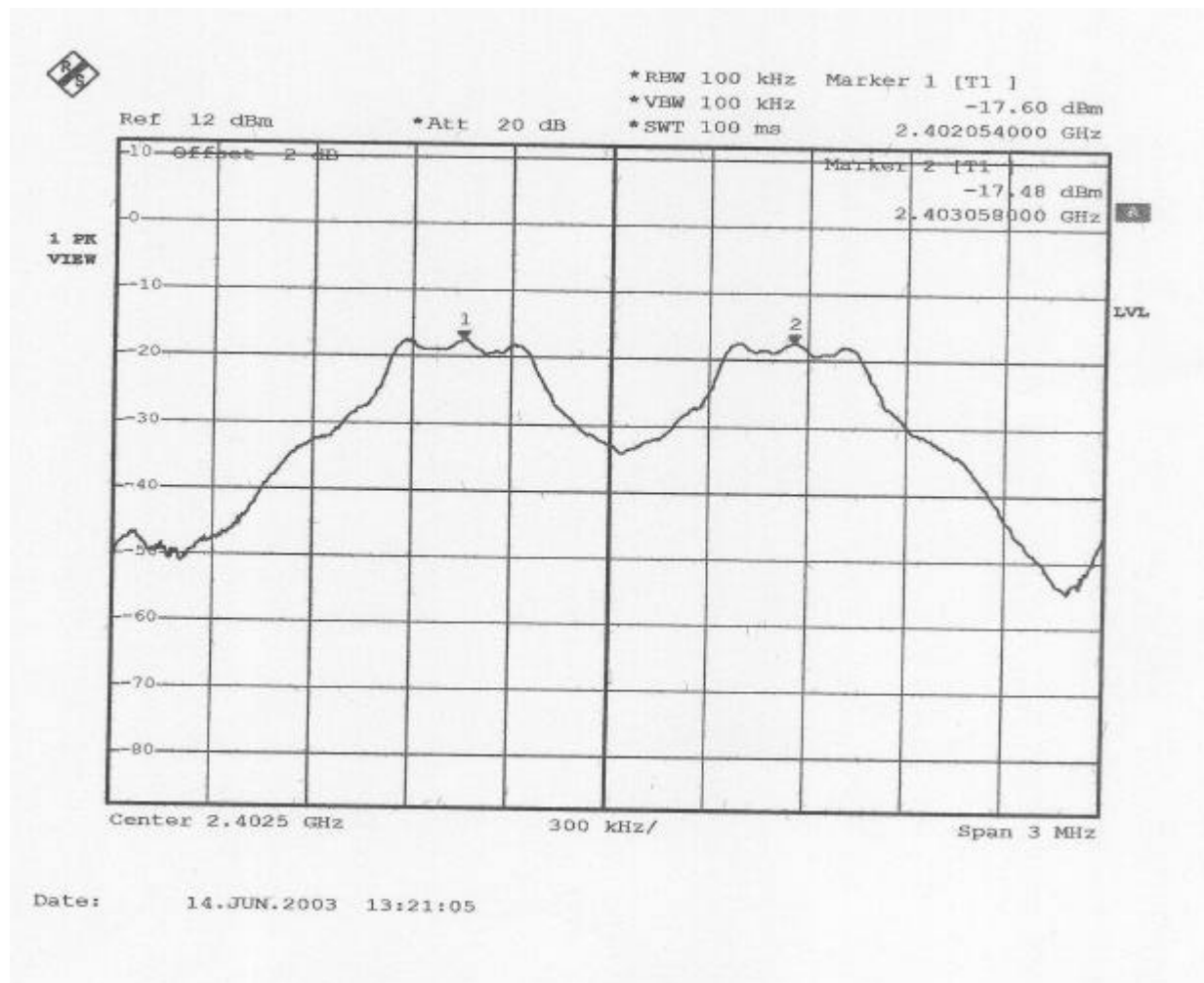



**Spectrum Research & Testing Lab., Inc.**  
No. 101-10, Ling 8,  
Shan-Tong Li, Chung-Li  
City, Taoyuan, Taiwan

# TEST REPORT

Reference No.:A03060503  
Report No.:FCCA03020605-01  
FCC ID:PQY-4710874200258  
Page:19 of 45  
Date:Jun. 25, 2003

CH39:

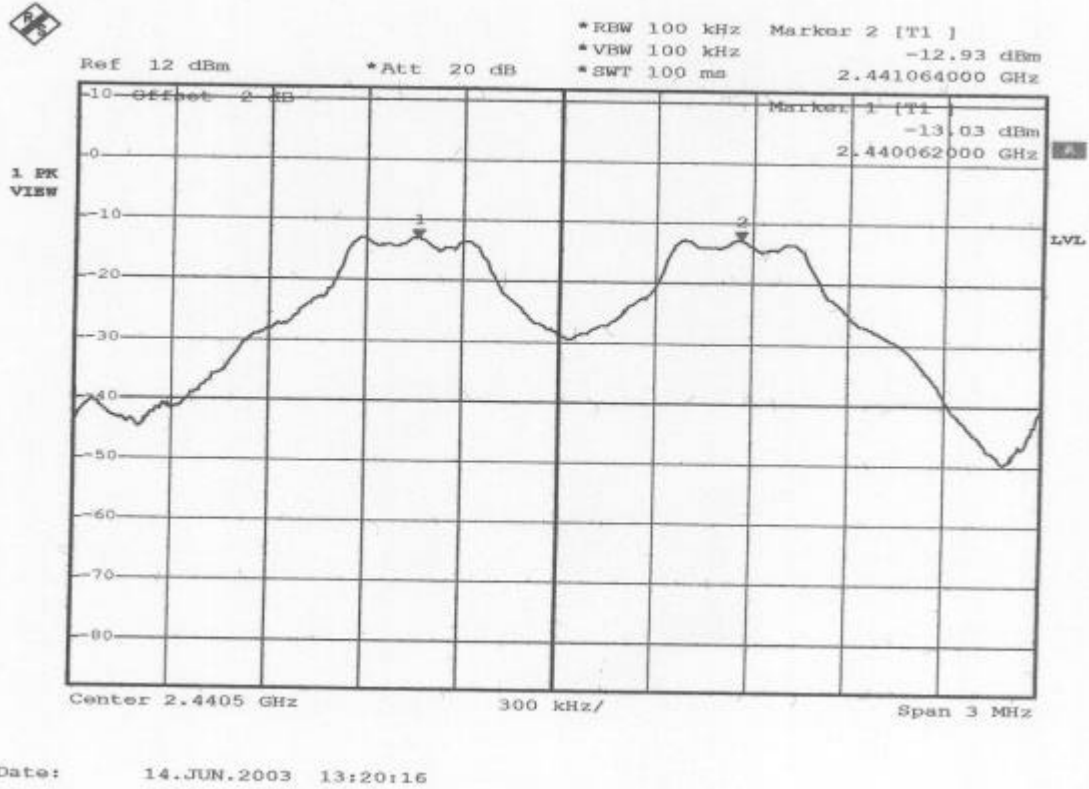



**Spectrum Research & Testing Lab., Inc.**  
No. 101-10, Ling 8,  
Shan-Tong Li, Chung-Li  
City, Taoyuan, Taiwan

# TEST REPORT

Reference No.:A03060503  
Report No.:FCCA03020605-01  
FCC ID:PQY-4710874200258  
Page:20 of 45  
Date:Jun. 25, 2003

CH78:

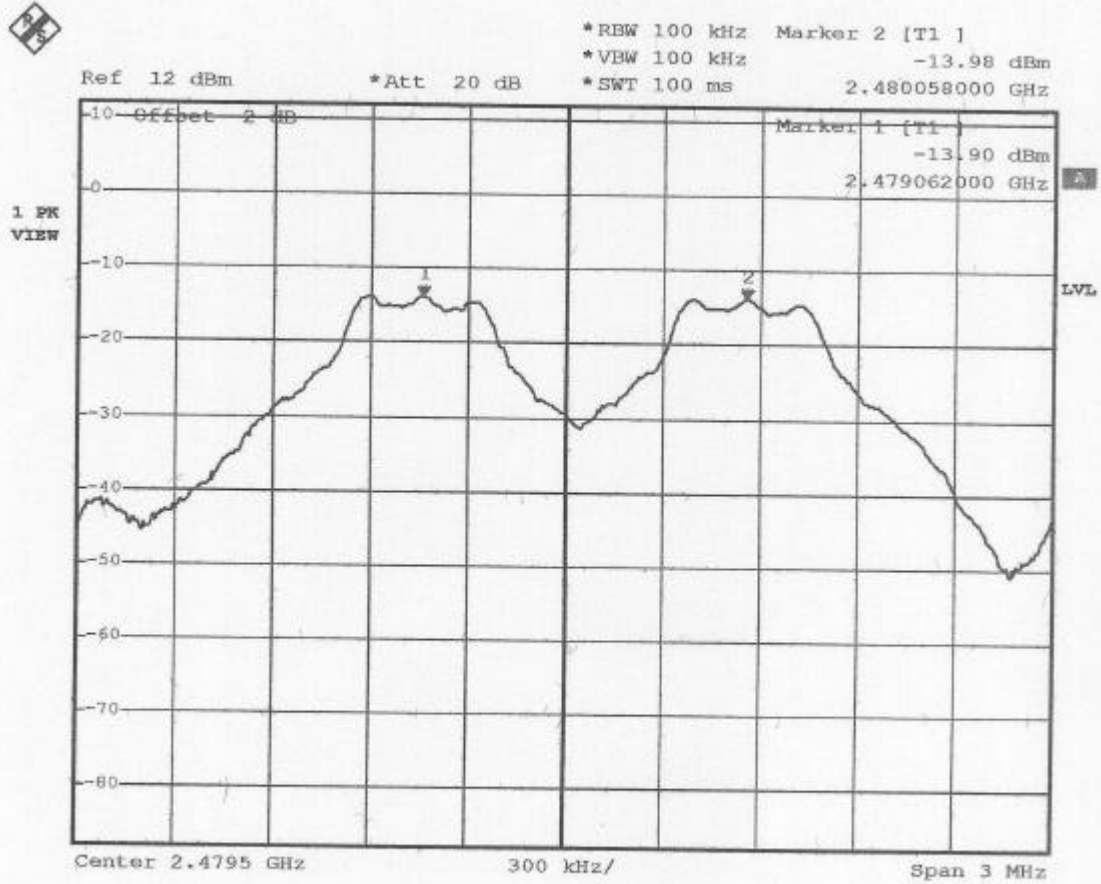

Date: 14.JUN.2003 13:19:14



## 4.4 QUANTITY OF HOPPING CHANNEL TEST

### 4.4.1 LIMIT

FCC Part15, Subpart C Section 15.247.

FREQUENCY RANGE (MHz)	Limit (Quantity of Hopping Channel)			
	20dB bandwidth <250kHz	20dB bandwidth >250kHz	20dB bandwidth <1MHz	20dB bandwidth >1MHz
902-928	50	25	NA	NA
2400-2483.5	NA	NA	75	15
5725-5850	NA	NA	75	NA

### 4.4.2 TEST EQUIPMENT

The following test equipment was used during the test:

EQUIPMENT/FACILITIES	SPECIFICATIONS	MANUFACTURER	MODEL#/SERIAL#	DUE DATE OF CAL. & CAL. CENTER
SPECTRUM	9kHz-7GHz	ROHDE & SCHWARZ	FSP7/ 839511/010	MAR. 2004 R & S

**NOTE:** The calibration interval of the above test equipment is one year and the calibrations are traceable to NML/ROC and NIST/USA.

### 4.4.3 TEST SET-UP

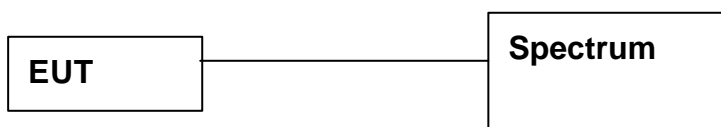

The EUT was connected to a spectrum through a 50 RF cable.

### 4.4.4 TEST PROCEDURE

The EUT was operating in hopping mode or could be controlled its channel. Printed out the test result from the spectrum by hard copy function.

### 4.4.5 EUT OPERATING CONDITION

Same as section 4.1.5 of this report.



**Spectrum Research & Testing Lab., Inc.**  
 No. 101-10, Ling 8,  
 Shan-Tong Li, Chung-Li  
 City, Taoyuan, Taiwan

# TEST REPORT

Reference No.:A03060503  
 Report No.:FCCA03020605-01  
 FCC ID:PQY-4710874200258  
 Page:22 of 45  
 Date:Jun. 25, 2003

## 4.4.6 TEST RESULT

Temperature: 25°C Humidity: 60%RH  
 Spectrum Detector: PK Tested by Ken Su  
 Test Result PASS

HOPPING CHANNEL FREQUENCY RANGE	QUANTITY OF HOPPING CHANNEL READ VALUE	QUANTITY OF HOPPING CHANNEL LIMIT
2402~2480	79	75

CH0-CH78

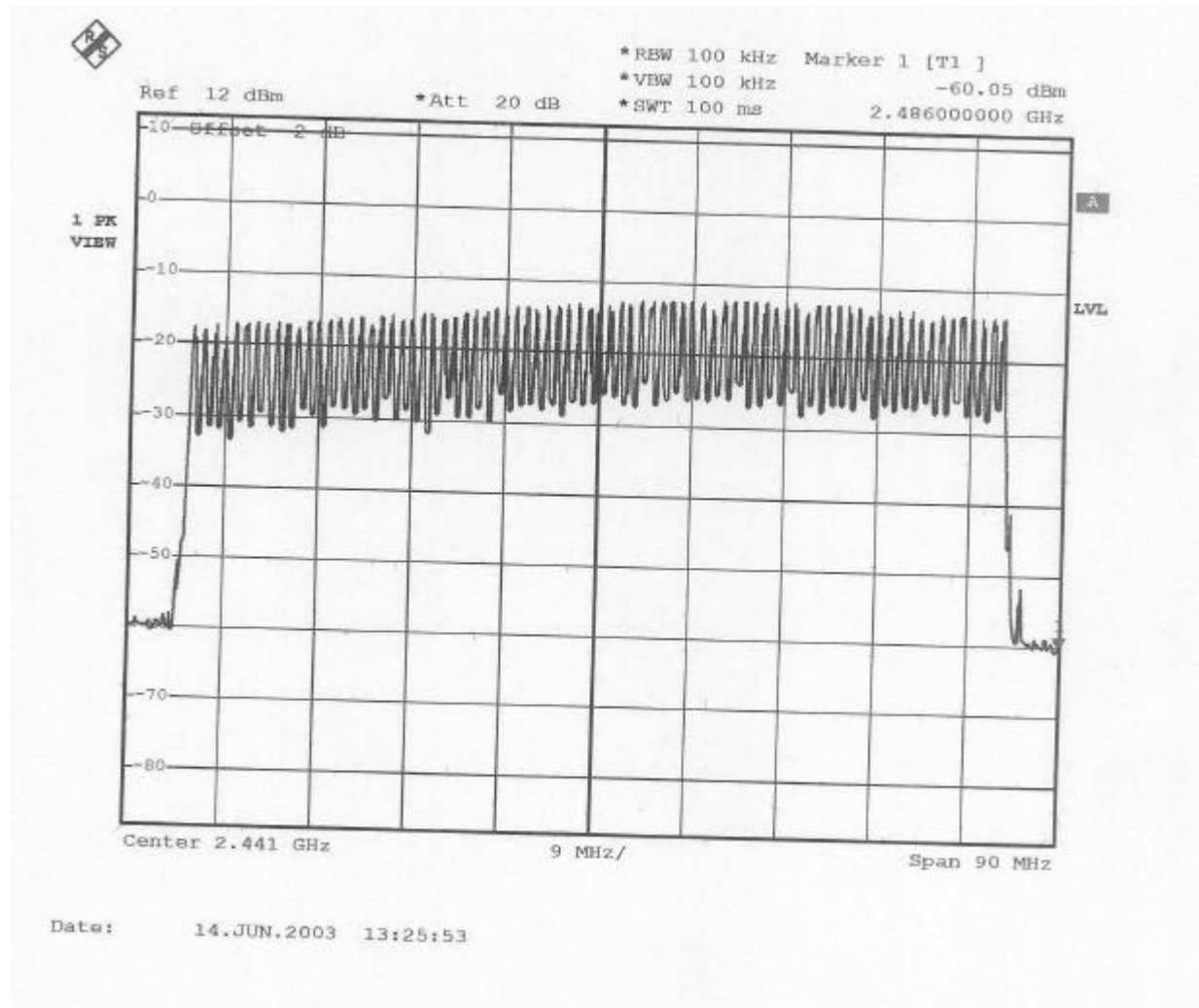



## 4.5 AVERAGE TIME OF OCCUPANCY TEST

### 4.5.1 LIMIT

FCC Part15, Subpart C Section 15.247.

FREQUENCY RANGE (MHz)	LIMIT (ms)		
	20dB bandwidth <250kHz(50Channel)	20dB bandwidth >250kHz(25Channel)	20dB bandwidth <1MHz(75Channel)
902-928	400(20s)	400(10s)	NA
2400-2483.5	NA	NA	400(30s)
5725-5850	NA	NA	400(30s)

**NOTE:** The “( )” is all channel’ s average time of occupancy.

### 4.5.2 TEST EQUIPMENT

The following test equipment was used during the test:

EQUIPMENT/ FACILITIES	SPECIFICATIONS	MANUFACTURER	MODEL#/ SERIAL#	DUE DATE OF CAL. & CAL. CENTER
SPECTRUM	9kHz-7GHz	ROHDE & SCHWARZ	FSP7/ 839511/010	MAR. 2004 R & S

**NOTE:** The calibration interval of the above test equipment is one year and the calibrations are traceable to NML/ROC and NIST/USA.

### 4.5.3 TEST SET-UP

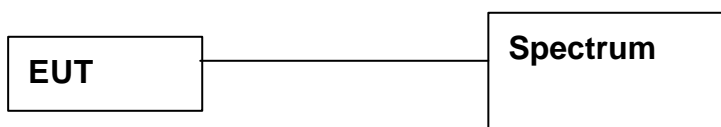

The EUT was connected to a spectrum through a 50 RF cable.

### 4.5.4 TEST PROCEDURE

The EUT was operating in hopping mode or could be controlled its channel. Printed out the test result from the spectrum by hard copy function.

### 4.5.5 EUT OPERATING CONDITION

Same as section 4.1.5 of this report.



**Spectrum Research & Testing Lab., Inc.**  
 No. 101-10, Ling 8,  
 Shan-Tong Li, Chung-Li  
 City, Taoyuan, Taiwan

# TEST REPORT

Reference No.:A03060503  
 Report No.:FCCA03020605-01  
 FCC ID:PQY-4710874200258  
 Page:24 of 45  
 Date:Jun. 25, 2003

## 4.5.6 TEST RESULT

Temperature: 25°C Humidity: 60%RH  
 Spectrum Detector: PK Tested by Ken Su  
 Test Result PASS

CHANNEL NUMBER	CHANNEL FREQUENCY (MHz)	Average time of occupancy READ VALUE (ms)	Average time of occupancy LIMIT (ms)
0	2402.049	1.876	400
39	2441.046	1.828	400
78	2480.466	1.788	400

CH0:

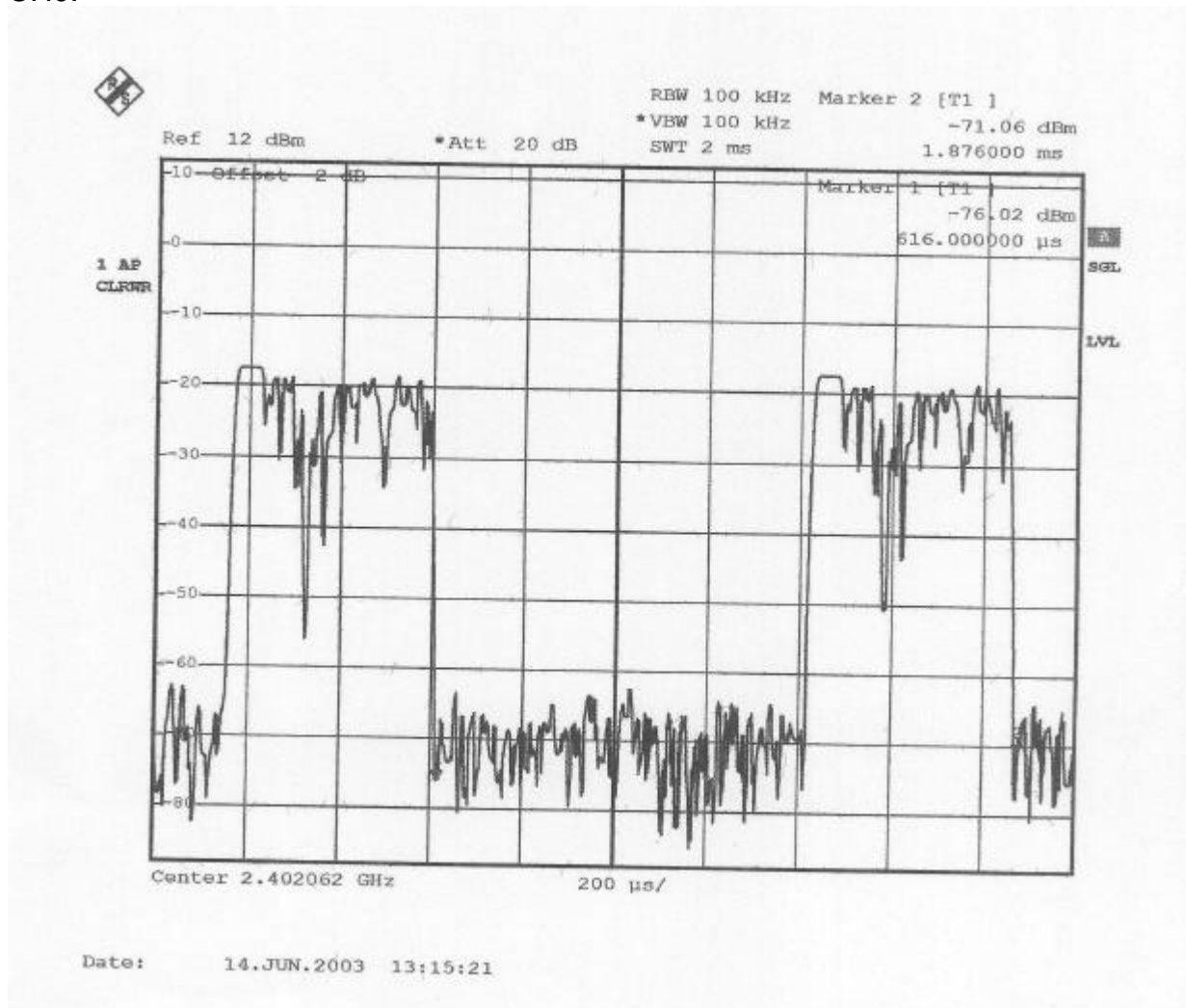





**Spectrum Research & Testing Lab., Inc.**  
No. 101-10, Ling 8,  
Shan-Tong Li, Chung-Li  
City, Taoyuan, Taiwan

# TEST REPORT

Reference No.:A03060503  
Report No.:FCCA03020605-01  
FCC ID:PQY-4710874200258  
Page:25 of 45  
Date:Jun. 25, 2003

Ch39:

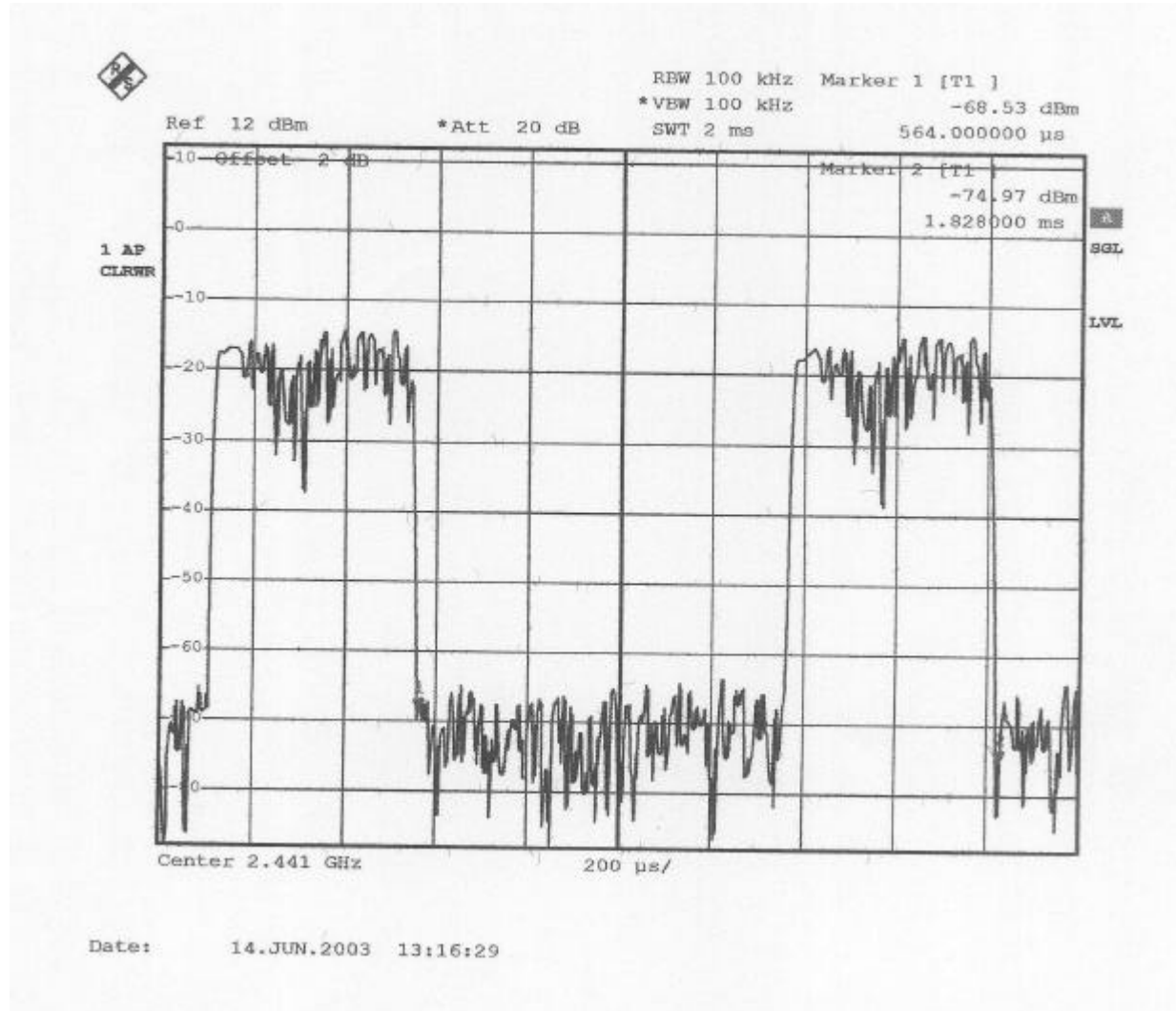



**Spectrum Research & Testing Lab., Inc.**  
No. 101-10, Ling 8,  
Shan-Tong Li, Chung-Li  
City, Taoyuan, Taiwan

# TEST REPORT

Reference No.:A03060503  
Report No.:FCCA03020605-01  
FCC ID:PQY-4710874200258  
Page:26 of 45  
Date:Jun. 25, 2003

CH78:

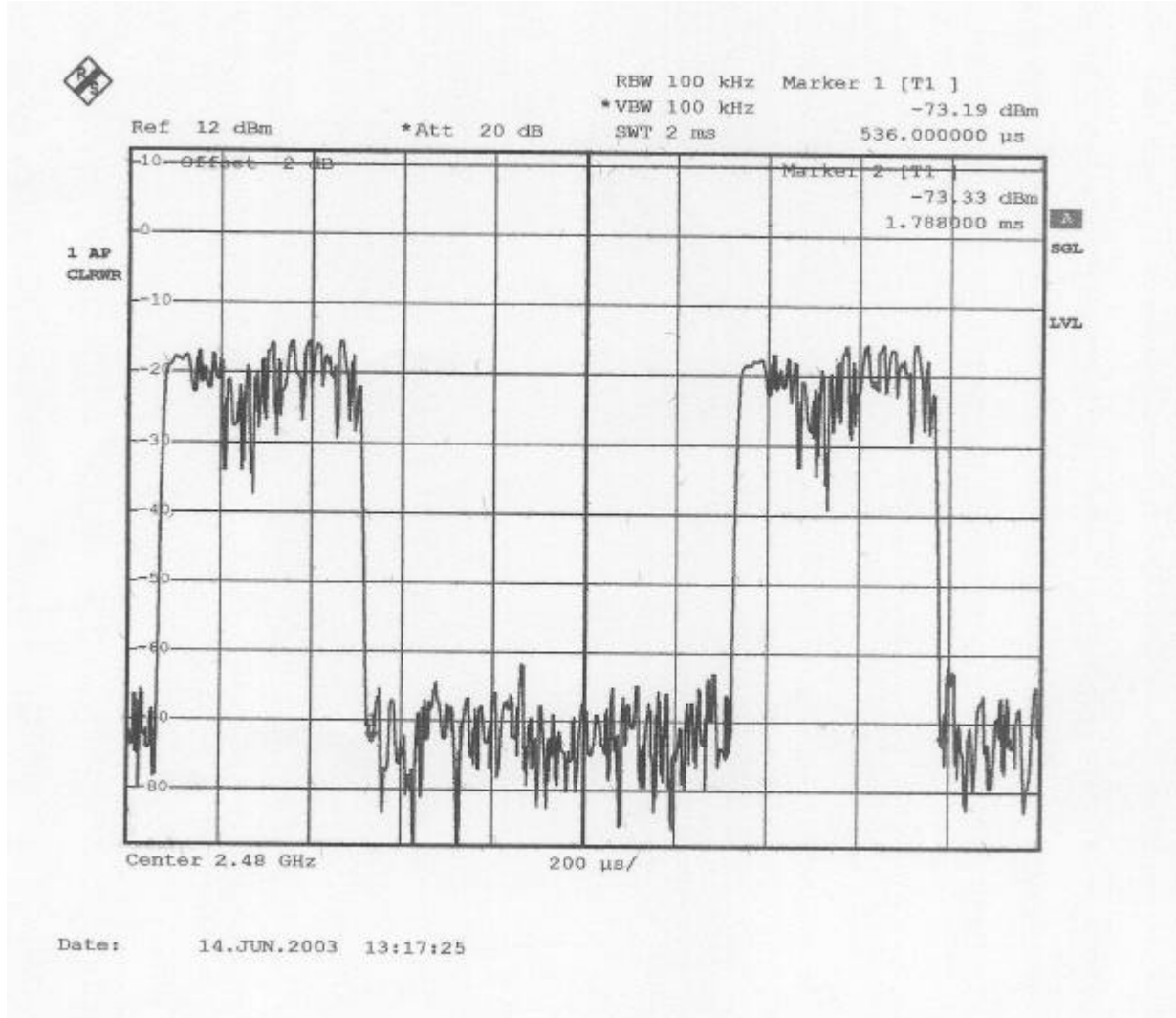



**Spectrum Research & Testing Lab., Inc.**  
No. 101-10, Ling 8,  
Shan-Tong Li, Chung-Li  
City, Taoyuan, Taiwan

## TEST REPORT

Reference No.:A03060503  
Report No.:FCCA03020605-01  
FCC ID:PQY-4710874200258  
Page:27 of 45  
Date:Jun. 25, 2003

### 4.7 PEAK POWER TEST

#### 4.7.1 LIMIT

FCC Part15, Subpart C Section 15.247.

FREQUENCY RANGE (MHz)	LIMIT (W)				
	Quantity of Hopping Channel	50	25	15	75
902-928	1(30dBm)	0.125(21dBm)	NA	NA	NA
2400-2483.5	NA	NA	0.125(21dBm)	1(30dBm)	NA
5725-5850	NA	NA	NA	1(30dBm)	NA

#### 4.7.2 TEST EQUIPMENT

The following test equipment was used during the test :

EQUIPMENT/ FACILITIES	SPECIFICATIONS	MANUFACTURER	MODEL#/ SERIAL#	DUE DATE OF CAL. & CAL. CENTER
SPECTRUM	9kHz-7GHz	ROHDE & SCHWARZ	FSP7/ 839511/010	MAR. 2004 R & S
POWER METER	N/A	BOONTON	4232A/ 29001	MAY 2004 ETC
POWER SENSOR	DC-18GHz 0.3 $\mu$ W-100mW 50	BOONTON	51011-EMC/ 31184	JUN. 2003 ETC

**NOTE:** The calibration interval of the above test equipment is one year and the calibrations are traceable to NML/ROC and NIST/USA.



### 4.7.3 TEST SET-UP

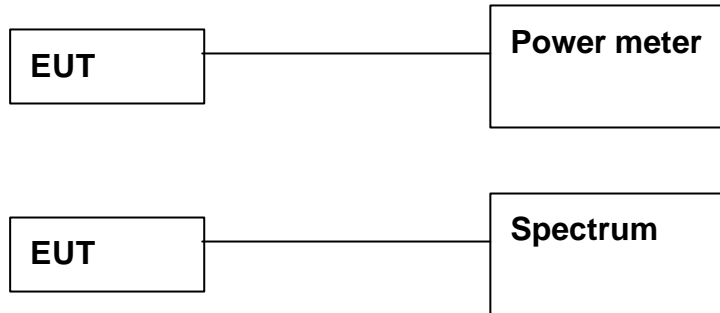

The EUT was connected to a spectrum through a 50 RF cable.

### 4.7.4 TEST PROCEDURE

The EUT was operating in hopping mode or could control its channel.  
 Printed out the test result from the spectrum by hard copy function.  
 Recorded the read value of the power meter.

### 4.7.5 EUT OPERATING CONDITION

Same as section 4.1.5 of this report.

### 4.7.6 TEST RESULT

Temperature: 25°C Humidity: 60%RH  
 Spectrum Detector: PK Tested by Ken Su  
 Test Result PASS

CHANNEL NUMBER	CHANNEL FREQUENCY (MHz)	PEAK POWER OUTPUT (dBm)	PEAK POWER LIMIT (dBm)
0	2.4020	-11.93	30
39	2.4410	-10.19	30
78	2.4800	-9.87	30



**Spectrum Research & Testing Lab., Inc.**  
No. 101-10, Ling 8,  
Shan-Tong Li, Chung-Li  
City, Taoyuan, Taiwan

# TEST REPORT

Reference No.:A03060503  
Report No.:FCCA03020605-01  
FCC ID:PQY-4710874200258  
Page:29 of 45  
Date:Jun. 25, 2003

CH0:

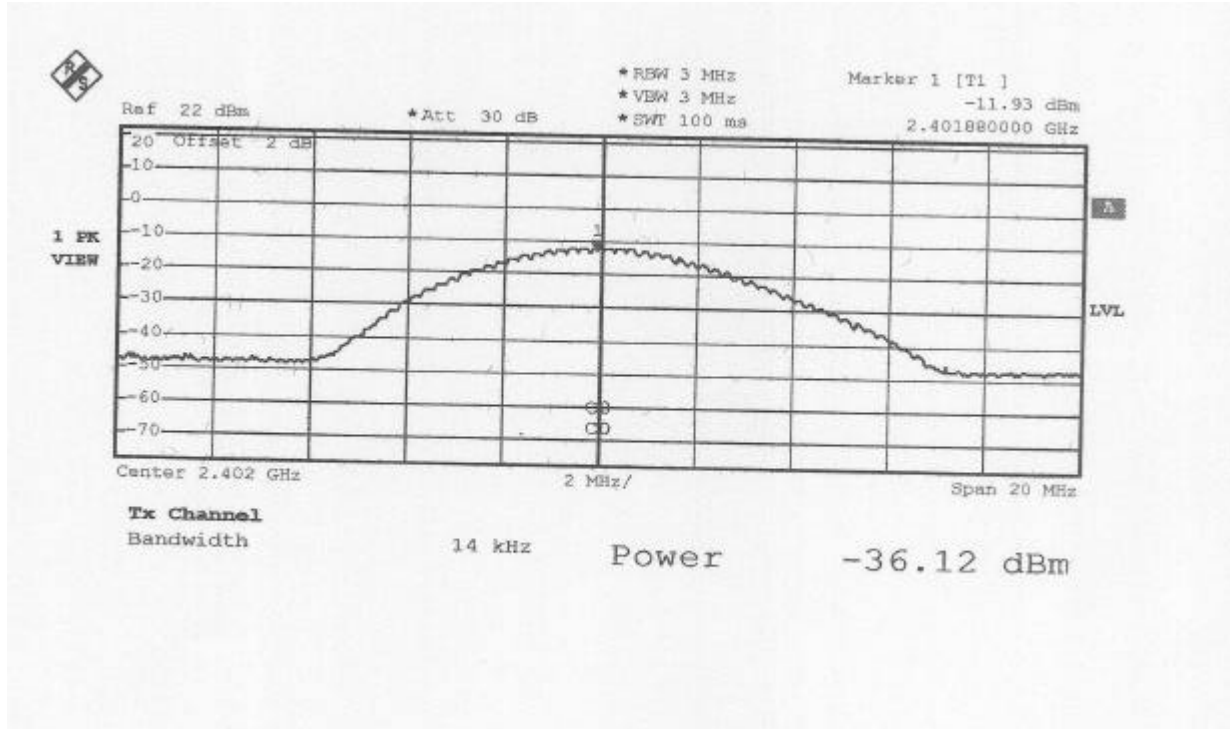



**Spectrum Research & Testing Lab., Inc.**  
No. 101-10, Ling 8,  
Shan-Tong Li, Chung-Li  
City, Taoyuan, Taiwan

# TEST REPORT

Reference No.:A03060503  
Report No.:FCCA03020605-01  
FCC ID:PQY-4710874200258  
Page:30 of 45  
Date:Jun. 25, 2003

CH39:

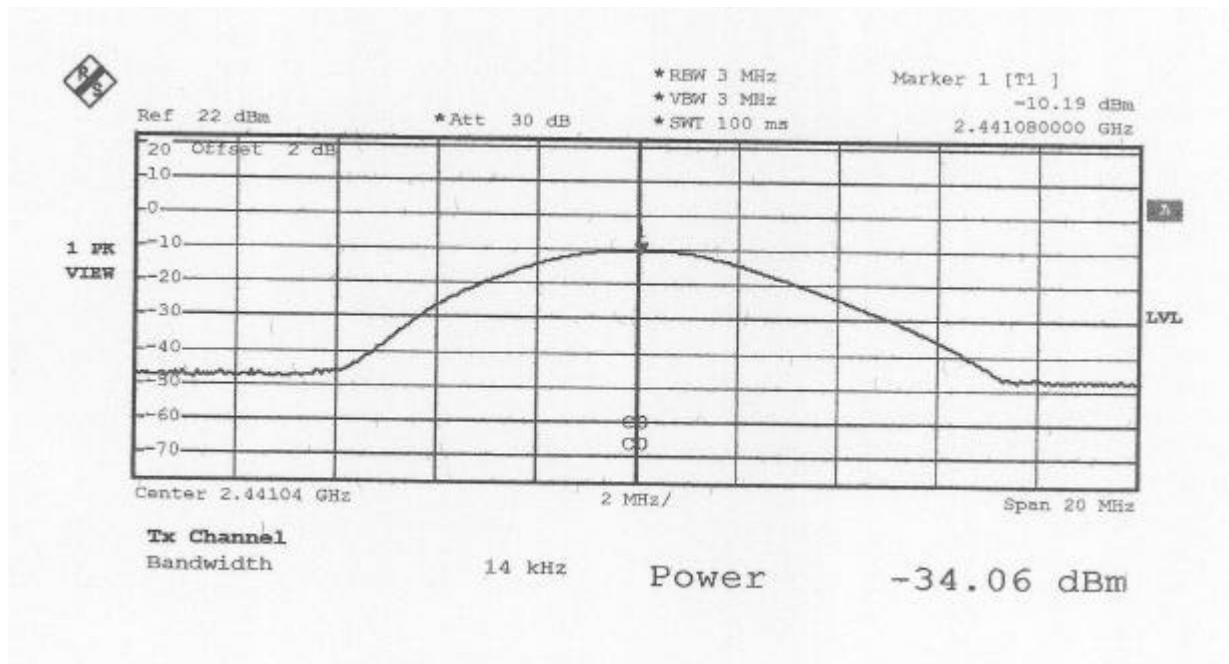



**Spectrum Research & Testing Lab., Inc.**  
No. 101-10, Ling 8,  
Shan-Tong Li, Chung-Li  
City, Taoyuan, Taiwan

# TEST REPORT

Reference No.:A03060503  
Report No.:FCCA03020605-01  
FCC ID:PQY-4710874200258  
Page:31 of 45  
Date:Jun. 25, 2003

CH78:

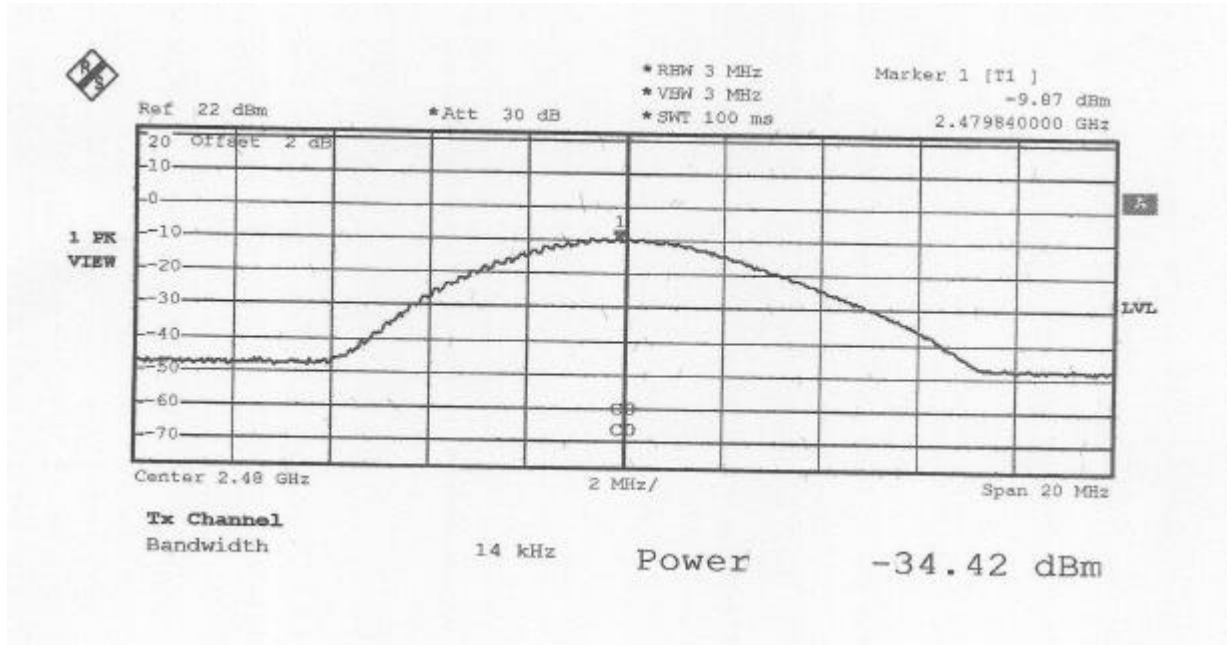



## 4.8 BAND EDGE TEST

### 4.8.1 LIMIT

FCC Part15, Subpart C Section 15.247. In any 100 kHz bandwidth outside the frequency band in which the spread spectrum intentional radiator is operating, the radio frequency power that is produced by the intentional radiator shall be at least 20 dB below that in the 100 kHz bandwidth within the band that contains the highest level of the desired power, based on either an RF conducted or a radiated measurement. Attenuation below the general limits specified in Section 15.209(a) is not required. In addition, radiated emissions which fall in the restricted bands, as defined in Section 15.205(a), must also comply with the radiated emission limits specified in Section 15.209(a) (see Section 15.205(c)).

OPERATING FREQUENCY RANGE (MHz)	SPURIOUS EMISSION FREQUENCY (MHz)	LIMIT	
		Peak power ration to emission(dBc)	Emission level(dBuV/m)
902-928	<902	>20	NA
	>928	>20	NA
	960-1240	NA	54
2400-2483.5	<2400	>20	NA
	>2483.5-2500	NA	54
5725-5850	<5350-5460	NA	54
	<5725	>20	NA
	>5850	>20	NA

### 4.8.2 TEST EQUIPMENT

The following test equipment was used during the test :

EQUIPMENT/ FACILITIES	SPECIFICATIONS	MANUFACTURER	MODEL#/ SERIAL#	DUE DATE OF CAL. & CAL. CENTER
SPECTRUM	9kHz-7GHz	ROHDE & SCHWARZ	FSP7/ 839511/010	MAR. 2004 R & S
SPECTRUM	9KHz-26.5GHz	HP	8953E/ 3710A03220	MAY 2004 ETC
PRE-AMPLIFIER	1GHz-26.5GHz Gain:30dB	HP	8449B/ 3008A01019	DEC. 2003 ETC
HORN ANTENNA	1GHz to 18GHz	EMCO	3115/ 9602-4681	DEC. 2003 ETC
OATS	3 - 10 M measurement	SRT	SRT-1	MAY 2003

**NOTE:** The calibration interval of the above test equipment is one year and the calibrations are traceable to NML/ROC and NIST/USA.





## 4.8.3 TEST SET-UP

### FOR RF CONDUCTED TEST (dBc)

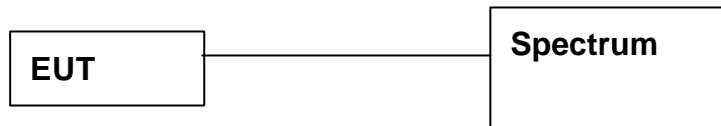

The EUT was connected to the spectrum through a 50 Ω RF cable.

### FOR RADIATED EMISSION TEST

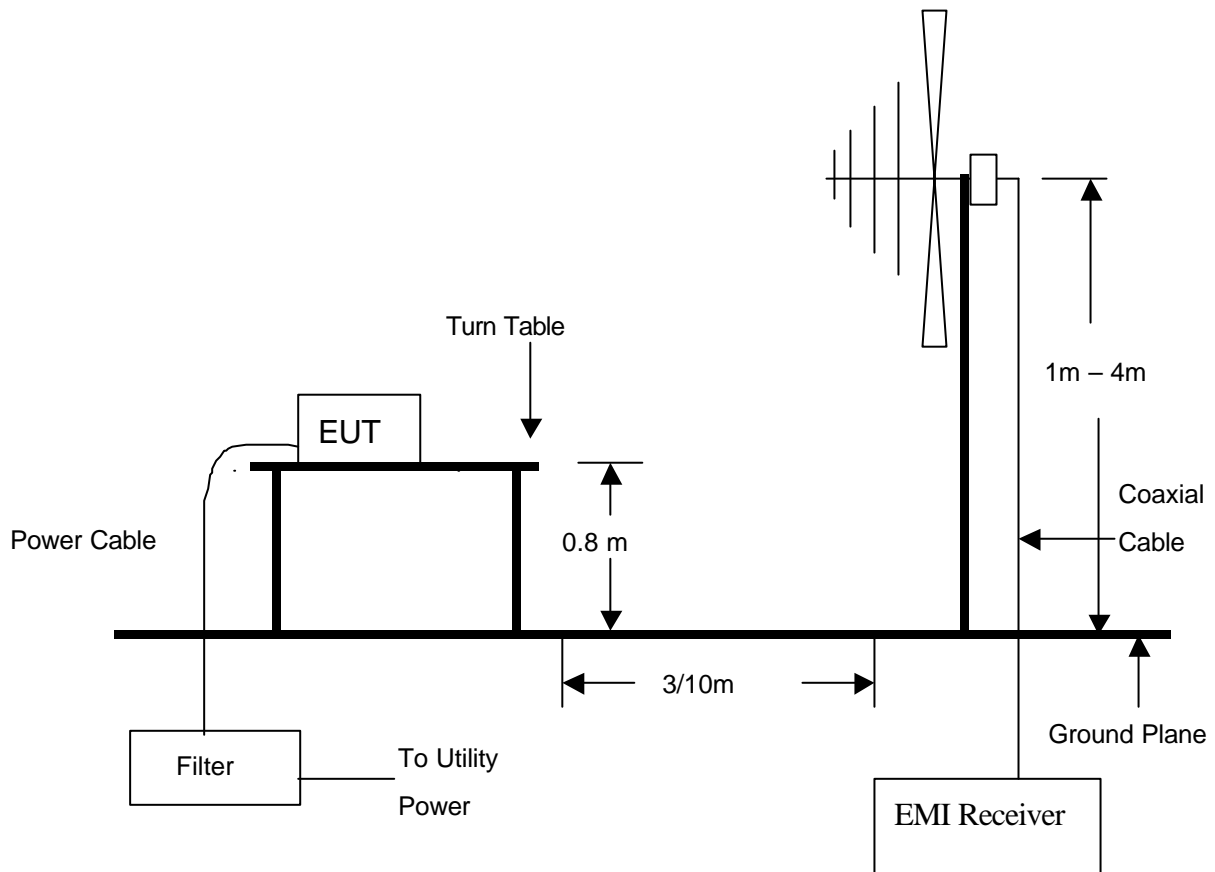

#### NOTE :

3. The EUT system was put on a wooden table with 0.8m heights above a ground plane.
4. For the actual test configuration, please refer to the photos of testing.



#### 4.8.4 TEST PROCEDURE

- The EUT was operating in hopping mode or could be controlled its channel.  
Printed out the test result from the spectrum by hard copy function.
- The EUT was tested according to the requirement of ANSI C63.4 and CISPR 22.  
The measurements were made at an open area test site with 10 meter measurement distance under 1 GHz and with 3m distance above 1GHz. The frequency spectrum measured started from 30 MHz. Under 1 GHz. All readings were quasi-peak values with 120 kHz resolution bandwidth of the test receiver. Above 1 GHz, the measurements were made at an open area test site with 3 meter measurement distance and all readings were peak and average values with 1 MHz resolution bandwidth of the test receiver. The EUT system was operated in all typical methods by users. The cables connected to EUT and support units were moved to find the maximum emission levels for each frequency.

#### 4.8.5 EUT OPERATING CONDITION

Same as section 4.1.5 of this report.

#### 4.8.6 TEST RESULT

Temperature: 25°C Humidity: 60%RH  
Spectrum Detector: PK & AV Tested by Ken Su  
Test Result PASS

##### 1. Conducted test

Frequency (MHz)	PEAK POWER OUTPUT (dBm)	Emission read Value(dBm)	Result of Band edge (dBc)	Band edge LIMIT (dBc)
<2400	-15.88	-56.48	40.60	>20dBc
>2483.5	-12.27	-56.20	43.93	>20dBc

##### 2. Radiated emission test

Frequency (MHz)	Antenna polarization (H/V)	PEAK POWER OUTPUT (dBuV/m)	Emission read Value(dBuV/m)	Band edge LIMIT (dBuV/m)
<2400	H	52.6	48.4	54
>2483.5	V	52.0	48.5	54



**Spectrum Research & Testing Lab., Inc.**  
No. 101-10, Ling 8,  
Shan-Tong Li, Chung-Li  
City, Taoyuan, Taiwan

# TEST REPORT

Reference No.:A03060503  
Report No.:FCCA03020605-01  
FCC ID:PQY-4710874200258  
Page:35 of 45  
Date:Jun. 25, 2003

<2400MHz:

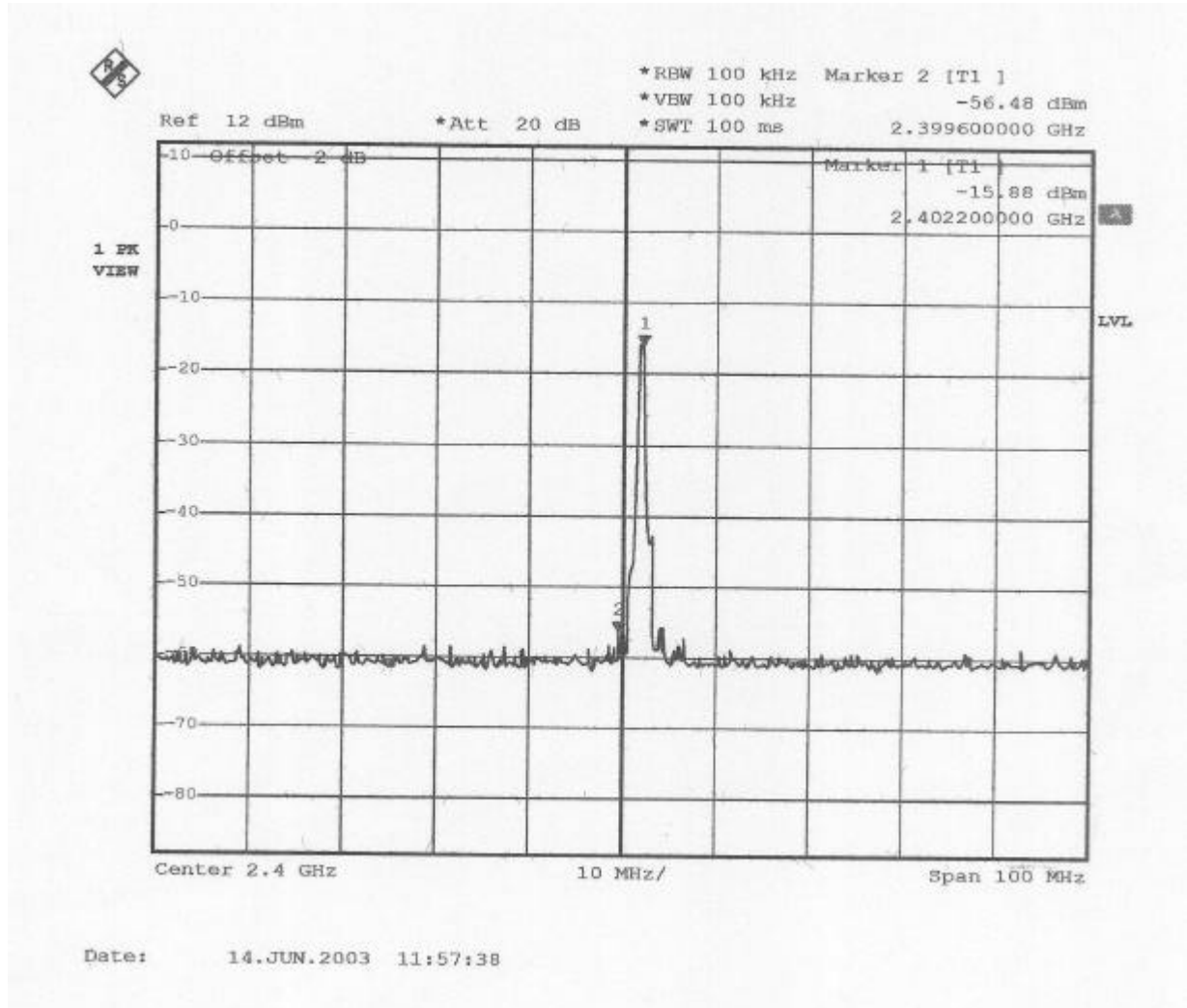



**Spectrum Research & Testing Lab., Inc.**  
No. 101-10, Ling 8,  
Shan-Tong Li, Chung-Li  
City, Taoyuan, Taiwan

# TEST REPORT

Reference No.:A03060503  
Report No.:FCCA03020605-01  
FCC ID:PQY-4710874200258  
Page:36 of 45  
Date:Jun. 25, 2003

>2483.5MHz

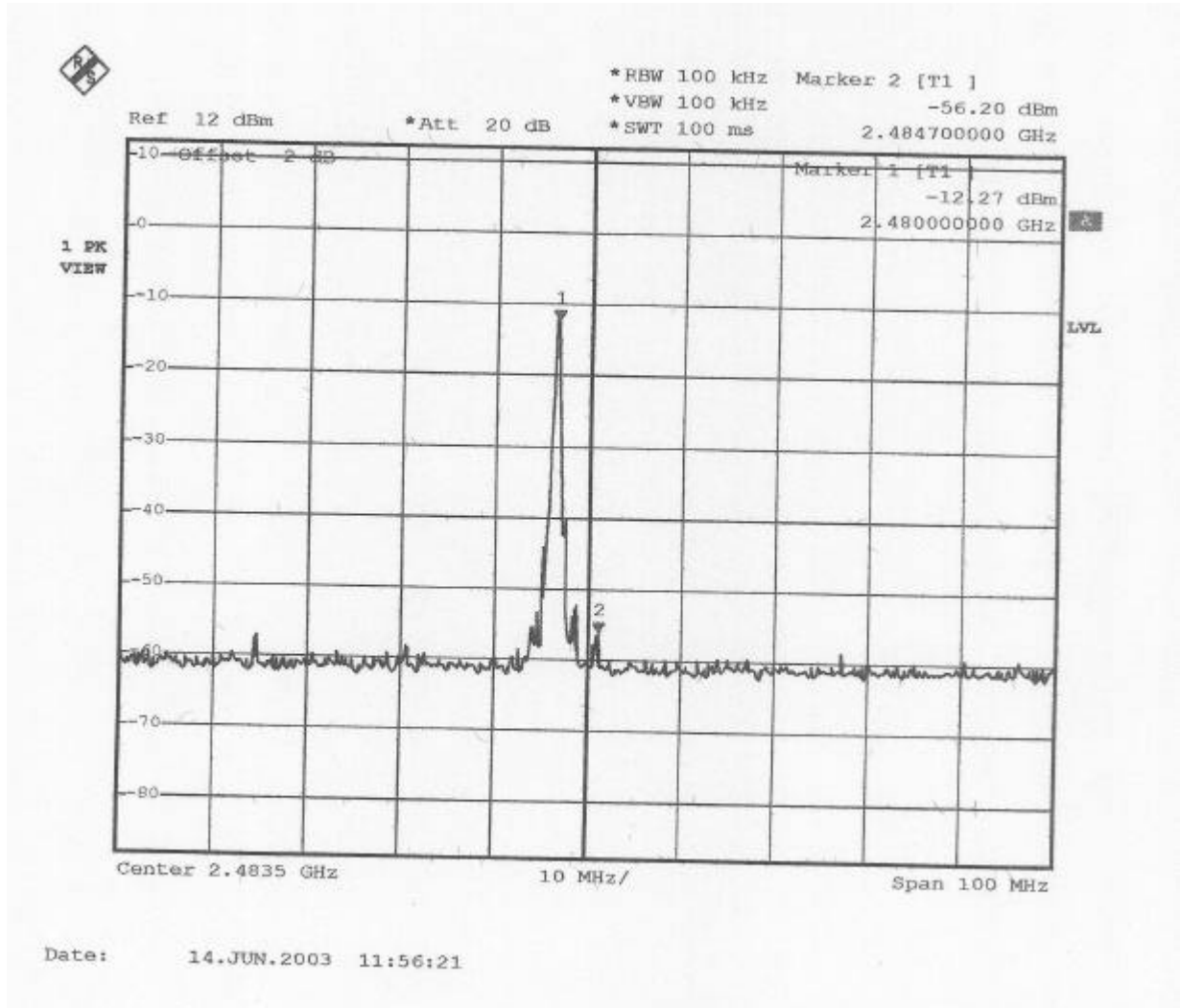

	<b>Spectrum Research &amp; Testing Lab., Inc.</b> No. 101-10, Ling 8, Shan-Tong Li, Chung-Li City, Taoyuan, Taiwan	<h1>TEST REPORT</h1>	Reference No.:A03060503 Report No.:FCCA03020605-01 FCC ID:PQY-4710874200258 Page:37 of 45 Date:Jun. 25, 2003
---	---	----------------------	--

## 4.9 POWER DENSITY TEST

### 4.9.1 LIMIT

FCC Part15, Subpart C Section 15.247.

FREQUENCY RANGE (MHz)	Limit(dBm/kHz)
902-928	8dBm/3kHz
2400-2483.5	
5725-5850	

### 4.9.2 TEST EQUIPMENT

The following test equipment was used during the radiated emission test :

EQUIPMENT/FACILITIES	SPECIFICATIONS	MANUFACTURER	MODEL#/SERIAL#	DUE DATE OF CAL. & CAL. CENTER
SPECTRUM	9kHz-7GHz	ROHDE & SCHWARZ	FSP7/ 839511/010	MAR. 2004 R & S

**NOTE:** The calibration interval of the above test equipment is one year and the calibrations are traceable to NML/ROC and NIST/USA.

### 4.9.3 TEST SET-UP

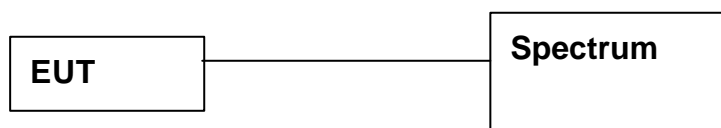

The EUT was connected to a spectrum through a 50 RF cable.

### 4.9.4 TEST PROCEDURE

The EUT was operating in hopping mode or could control its channel. Printed out the test result from the spectrum by hard copy function.

### 4.9.5 EUT OPERATING CONDITION

Same as section 4.1.5 of this report.



**Spectrum Research & Testing Lab., Inc.**  
 No. 101-10, Ling 8,  
 Shan-Tong Li, Chung-Li  
 City, Taoyuan, Taiwan

# TEST REPORT

Reference No.:A03060503  
 Report No.:FCCA03020605-01  
 FCC ID:PQY-4710874200258  
 Page:38 of 45  
 Date:Jun. 25, 2003

## 4.9.6 TEST RESULT

Temperature: 25°C Humidity: 60%RH  
 Spectrum Detector: PK Tested by Ken Su  
 Test Result PASS

CHANNEL NUMBER	CHANNEL FREQUENCY (MHz)	RF POWER LEVEL IN 3kHz BW (dBm/3kHz)	MAXIMUM LIMIT (dBm/3kHz)
0	2402.051	-25.72	8
39	2441.059	-20.41	8
78	2480.061	-22.01	8

CH0:

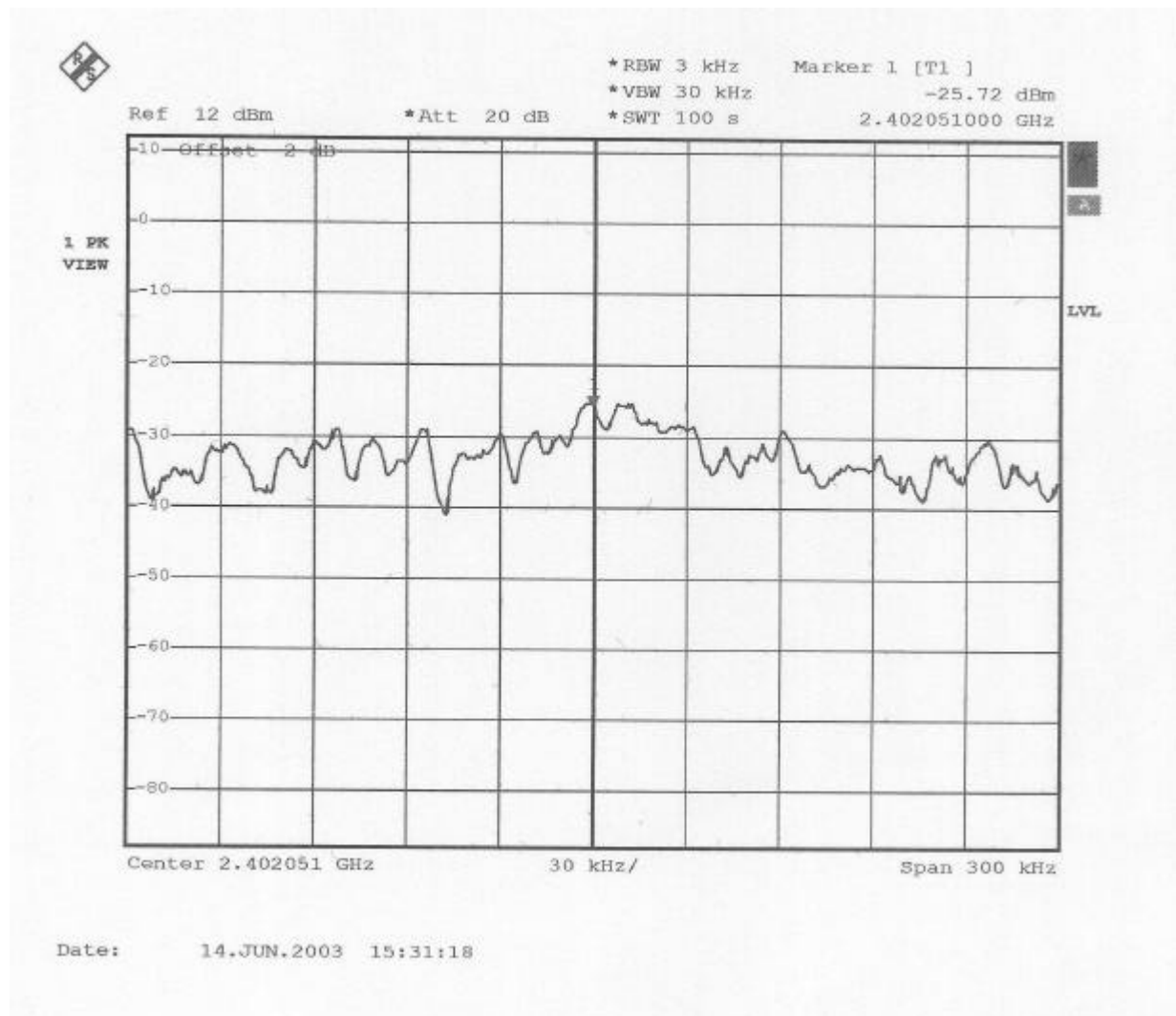

Date: 14.JUN.2003 15:31:18



**Spectrum Research & Testing Lab., Inc.**  
No. 101-10, Ling 8,  
Shan-Tong Li, Chung-Li  
City, Taoyuan, Taiwan

# TEST REPORT

Reference No.:A03060503  
Report No.:FCCA03020605-01  
FCC ID:PQY-4710874200258  
Page:39 of 45  
Date:Jun. 25, 2003

CH39:

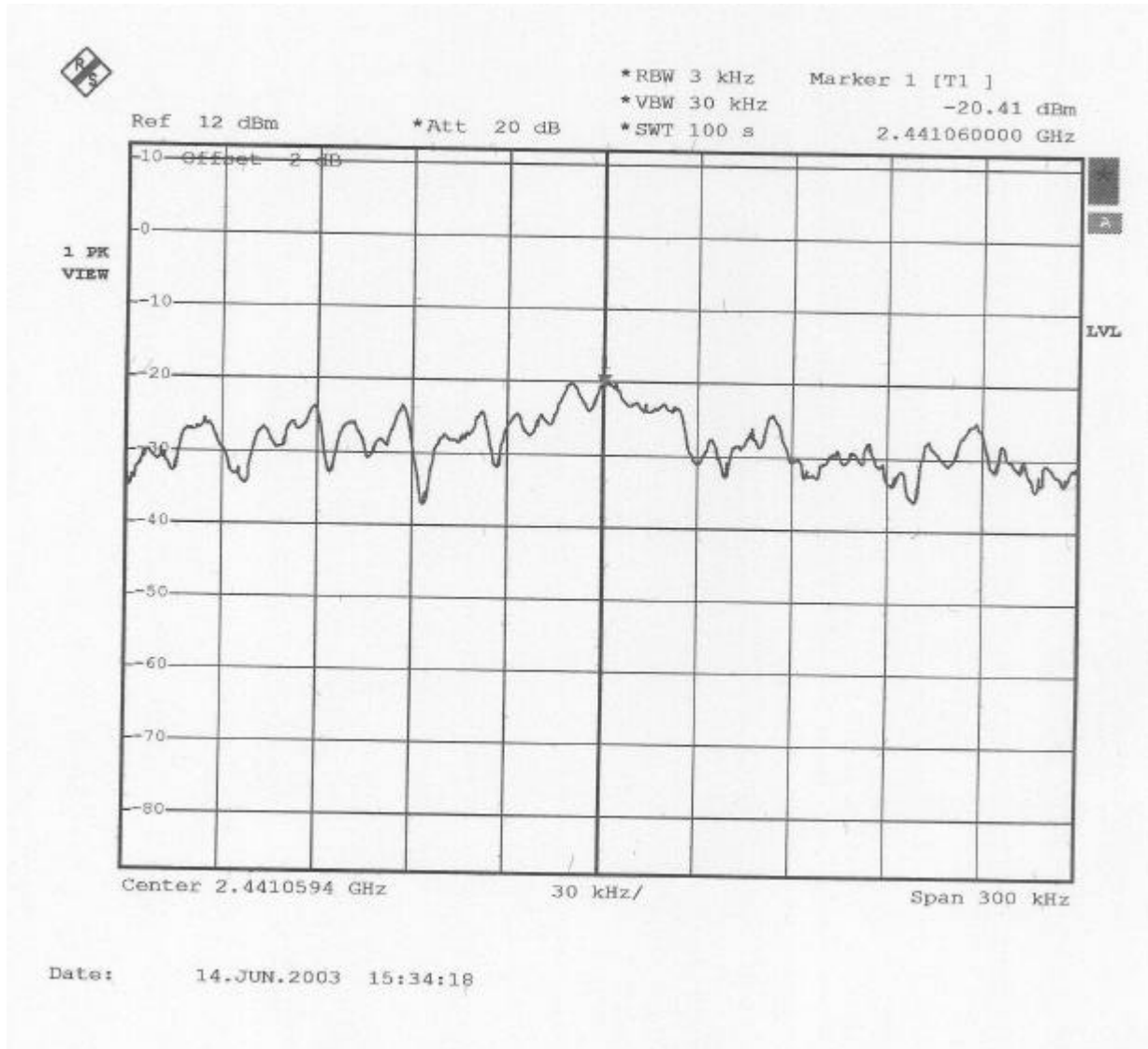



**Spectrum Research & Testing Lab., Inc.**  
No. 101-10, Ling 8,  
Shan-Tong Li, Chung-Li  
City, Taoyuan, Taiwan

# TEST REPORT

Reference No.:A03060503  
Report No.:FCCA03020605-01  
FCC ID:PQY-4710874200258  
Page:40 of 45  
Date:Jun. 25, 2003

CH78:

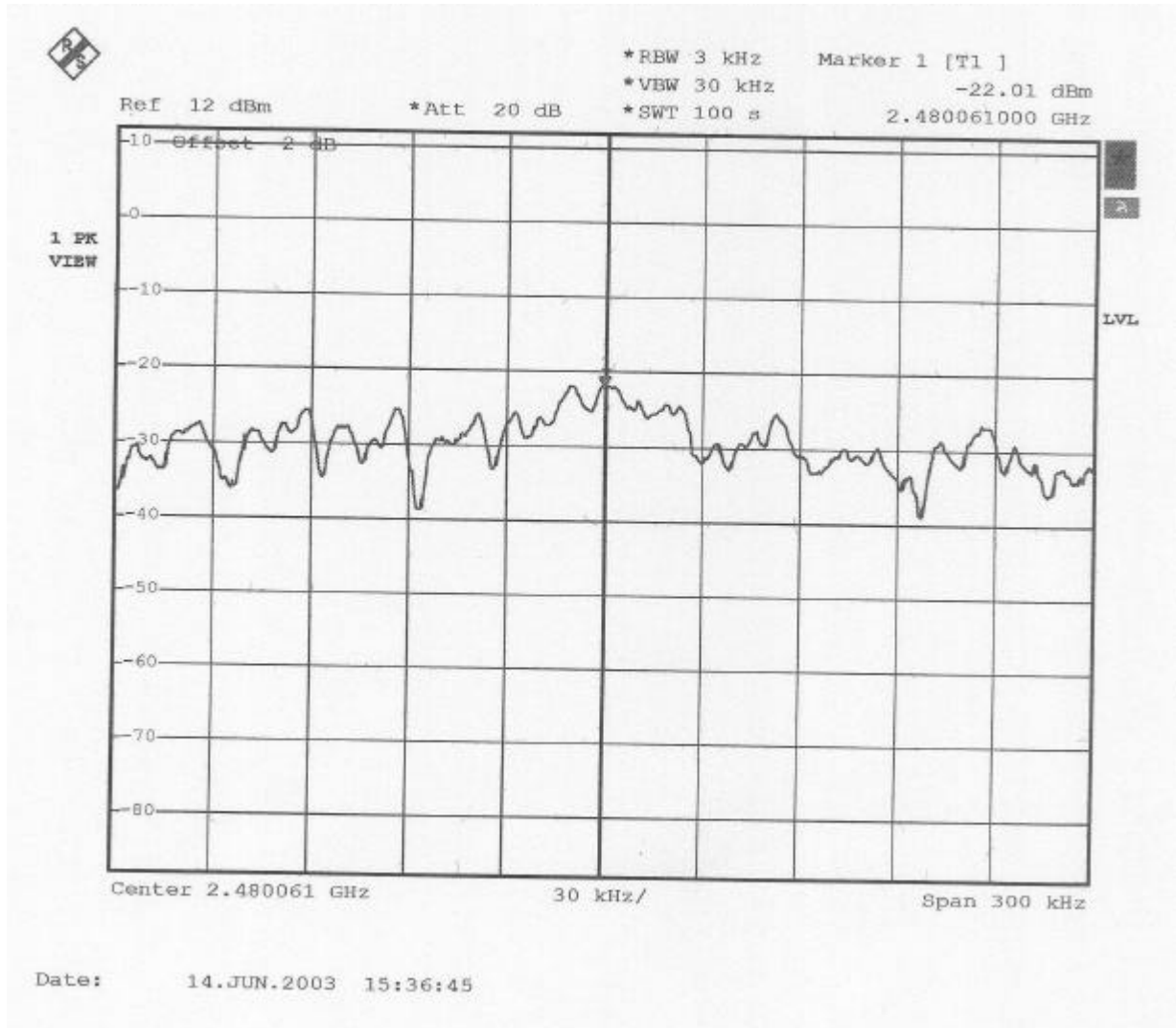





## 4.10 RF POWER EXPOSURE EVALUATION TEST

### 4.10.1 LIMIT

According to the requirement of IEEE C95.1 and FCC OET Bulletin 65.

#### Limits for Occupational/Controlled Exposure

Frequency Range (MHz)	Electric Field Strength(E) (V/m)	Magnetic Field Strength(H) (A/m)	Power density (S) (mW/cm <sup>2</sup> )	Averaging Time  E  <sup>2</sup> ,  H  <sup>2</sup> or S (minutes)
0.3-3.0	614	1.63	(100)*	6
3.0-30	1842/f	4.89/f	(900/f <sup>2</sup> )*	6
30-300	61.4	0.163	1.0	6
300-1500	--	--	f/300	6
1500-100,000	--	--	5	6

#### Limits for General Population/Uncontrolled Exposure

Frequency Range (MHz)	Electric Field Strength(E) (V/m)	Magnetic Field Strength(H) (A/m)	Power density (S) (mW/cm <sup>2</sup> )	Averaging Time  E  <sup>2</sup> ,  H  <sup>2</sup> or S (minutes)
0.3-1.34	614	1.63	(100)*	30
1.34-30	824/f	2.19/f	(180/f <sup>2</sup> )*	30
30-300	27.5	0.073	0.2	30
300-1500	--	--	f/1500	30
1500-100,000	--	--	1.0	30

f = frequency in MHz \*Plane-wave equivalent power density

**NOTE 1:** Occupational/controlled limits apply in situations in which persons are exposed as a consequence of their employment provided those persons are fully aware of the potential for exposure and can exercise control over their exposure. Limits for occupational/controlled exposure also apply in situations when an individual is transient through a location where occupational/controlled limits apply provided he or she is made aware of the potential for exposure.

**NOTE 2:** General population/uncontrolled exposures apply in situations in which the general public may be exposed, or in which persons that are exposed as a consequence of their employment may not be fully aware of the potential for exposure or cannot exercise control over their exposure.

	<b>Spectrum Research &amp; Testing Lab., Inc.</b> No. 101-10, Ling 8, Shan-Tong Li, Chung-Li City, Taoyuan, Taiwan	<h1>TEST REPORT</h1>	Reference No.:A03060503 Report No.:FCCA03020605-01 FCC ID:PQY-4710874200258 Page:42 of 45 Date:Jun. 25, 2003
---	---	----------------------	--

#### 4.10.2 TEST EQUIPMENT

The following test equipment was used during the test :

EQUIPMENT/ FACILITIES	SPECIFICATIONS	MANUFACTURER	MODEL#/ SERIAL#	DUE DATE OF CAL. & CAL. CENTER
SPECTRUM	9kHz-7GHz	ROHDE & SCHWARZ	FSP7/ 839511/010	MAR. 2004 R & S
POWER METER	N/A	HP	435A/ 1810A08277	JAN. 2004 ETC
POWER SENSOR	DC-18GHz 0.3 μ W-100mW 50	HP	8481A	JAN. 2004 ETC

**NOTE:** The calibration interval of the above test equipment is one year and the calibrations are traceable to NML/ROC and NIST/USA.

#### 4.10.3 TEST SET-UP

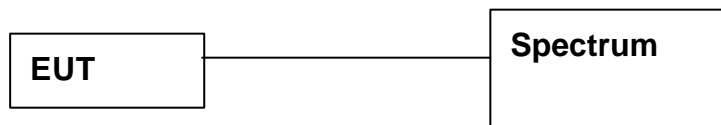

The EUT was connected to the spectrum through a 50 Ω RF cable.

#### 4.10.4 TEST PROCEDURE

1. The EUT was operating in hopping mode or could be controlled its channel. The power meter read power value.
2. The EUT uses an integral antenna and the antenna gain is 0dBi declared by manufacturer.
3. As discussed in OET Bulletin 65, calculations can be made to predict RF field strength and power density levels around typical RF sources. For example, in the case of a non-directional antenna, a prediction for power density in the far-field of the antenna can be made by use of the general Equations (1) or (2) below [for conversion to electric or magnetic field strength see Equation (3) above]. These equations are generally accurate in the far-field of an antenna but will over-predict power density in the near field, where it could be used for making a " worst case" or conservative prediction.

$$S = PG/4 R^2 \quad (\text{Eq.1})$$

$$S = EIRP/4 R^2 \quad (\text{Eq. 2})$$

$$S = E^2/3770 = 37.7H^2 \quad (\text{Eq. 3})$$

where: S = power density (mW/cm<sup>2</sup>)



**Spectrum Research & Testing Lab., Inc.**  
 No. 101-10, Ling 8,  
 Shan-Tong Li, Chung-Li  
 City, Taoyuan, Taiwan

# TEST REPORT

Reference No.:A03060503  
 Report No.:FCCA03020605-01  
 FCC ID:PQY-4710874200258  
 Page:43 of 45  
 Date:Jun. 25, 2003

E = electric field strength (V/m)

H = magnetic field strength (A/m)

S = power density (in appropriate units, e.g. mW/cm<sup>2</sup>)

P = power input to the antenna (in appropriate units, e.g., mW)

G = power gain of the antenna in the direction of interest relative to an isotropic radiator (dBi)

R = distance to the center of radiation of the antenna (appropriate units, e.g., cm)

where: EIRP = equivalent (or effective) isotropically radiated power

## 4.10.5 EUT OPERATING CONDITION

Same as section 4.1.5 of this report.

## 4.10.6 RESULT

Temperature:	<u>25°C</u>	Humidity:	<u>60%RH</u>
Spectrum Detector:	<u>PK</u>	Tested by	<u>Ken Su</u>
Result	<u>PASS</u>		

CHANNEL NUMBER	CHANNEL FREQUENCY (MHz)	RF Output Power to antenna (mW)(e.i.r.p.)	Result calculated when nearby person (cm)	Limit when nearby person (cm)
0	2402	0.06	0.07	20
39	2441	0.09	0.08	20
78	2480	0.10	0.09	20



**Spectrum Research &  
Testing Lab., Inc.**  
No. 101-10, Ling 8,  
Shan-Tong Li, Chung-Li  
City, Taoyuan, Taiwan

## **TEST REPORT**

Reference No.:A03060503  
Report No.:FCCA03020605-01  
FCC ID:PQY-4710874200258  
Page:44 of 45  
Date:Jun. 25, 2003

### **5. Antenna application**

#### **5.1 Antenna requirement**

The EUT' s antenna is met the requirement of FCC part15C section15.203 and 15.204.

FCC part15C section15.247 requirement:

Systems operating in the 2400-2483.5 MHz band that are used exclusively for fixed, point-to-point operations may employ transmitting antennas with directional gain greater than 6 dBi provided the maximum peak output power of the intentional radiator is reduced by 1 dB for every 3 dB that the directional gain of the antenna exceeds 6 dBi.

#### **5.2 Result**

The EUT' s antenna used a dipole antenna and integrated on PCB. The antenna' s gain is 2dBi and meets the requirement.



**Spectrum Research & Testing Lab., Inc.**  
No. 101-10, Ling 8,  
Shan-Tong Li, Chung-Li  
City, Taoyuan, Taiwan

## TEST REPORT

Reference No.:A03060503  
Report No.:FCCA03020605-01  
FCC ID:PQY-4710874200258  
Page:45 of 45  
Date:Jun. 25, 2003

### 6. TERMS OF ABRIVATION

AV.	Average detection
AZ(°)	Turn table azimuth
Correct.	Correction
EL(m)	Antenna height (meter)
EUT	Equipment Under Test
Horiz.	Horizontal direction
LISN	Line Impedance Stabilization Network
NSA	Normalized Site Attenuation
Q.P.	Quasi-peak detection
SRT Lab	Spectrum Research & Testing Laboratory, Inc.
Vert.	Vertical direction