

Class B Certification Application

Under Part 15, Subpart C

EUT : RF Wireless Keyboard

MODEL : RF Combo 1

FCC ID : PQY-4710874200036

SRT REPORT # FID1H018

PREPARED FOR :

CELLINK CO., LTD.

11F, NO. 102, SEC. 1,
HSIN TAI WU RD.,
HIS-CHIH, TAIPEI,
TAIWAN, R.O.C.

CELLINK CO., LTD

**11F, NO. 102, SEC.1, Hsin Tai Wu Rd., His Chih,
Taipei, Taiwan, R.O.C.**

TEL : 886-02-2696-2773

FAX : 886-02-2696-2774

Federal Communications Commission
Authorization and Evaluation Division
7435 Oakland Mills Road
Columbia, MD 21046

To whom it may concern :

This is to serve as proper written authorization that Spectrum Research and Testing Laboratory, Inc., 15200, Shady Grove Rd, Rockville, MD. 20850, will act as our representative in all matters relating to FCC applications for equipment approval. This includes the signing of all related documents, the transmitting of required fees, and receiving correspondence and notifications from the FCC. All acts performed by Spectrum Research and Testing Laboratory, Inc., especially modifications to our equipment under testing will be carried out on our behalf.

Meantime, the applicant certifies that in the case of an individual applicant (e.g., corporation), no party to the applicant is subject to a denial of federal benefits, that includes FCC denial of federal benefits, that includes FCC benefits, pursuant to Section 5301 of the Anti-Drug Abuse Act of 1998, 21 U.S.C. 862. For a definition of a " party " for these purposes see 47 C.F.R. 1.2002 (b).

If you have any questions regarding our applications for equipment approval, please contact Spectrum Research and Testing Laboratory, Inc. by calling (301) 670-2818.

Respectfully,

TING-TING, Huang
(Name, Surname)

Effective Dates :

From 27-Jun-2001 27-Jun-2002

Vice-President
(Position/Title)
CELLINK CO., LTD.

DATE : 27-Jun-2001

gvone@cellink.com.tw

EMI TESTING REPORT

EUT : RF Wireless Keyboard

MODEL : RF Combo 1

FCC ID : PQY-4710874200036

PREPARED FOR :

CELLINK CO., LTD.

11F, NO. 102, SEC. 1, HSIN TAI WU RD.,

HIS-CHIH, TAIPEI,

TAIWAN, R.O.C.

PREPARED BY :

SPECTRUM RESEARCH & TESTING LABORATORY INC.

NO. 101-10, LING 8 , SHAN-TONG LI CHUNG- LI CITY ,
TAOYUAN, TAIWAN , R. O. C.

TEL : (03) 4987684

FAX : (03) 4986528

TABLE OF CONTENTS

1. TEST REPORT CERTIFICATION.....	5
2. TEST STATEMENT	
2.1 TEST STATEMENT.....	6
2.2 DEPARTURE FROM DOCUMENT POLICIES, PROCEDURE OR SPECIFICATIONS, TEST STATEMENT.....	6
3. EUT MODIFICATIONS.....	7
4. CONDUCTED POWER LINE TEST	
4.1 TEST EQUIPMENT.....	8
4.2 TEST PROCEDURE.....	8
4.3 TEST SETUP.....	9
4.4 CONFIGURATION OF THE EUT.....	10-11
4.5 EUT OPERATING CONDITION.....	12
4.6 EMISSION LIMITS.....	12
4.7 CONDUCTED EMISSION TEST RESULTS.....	13
5. RADIATED EMISSION TEST	
5.1 TEST EQUIPMENT.....	14
5.2 TEST PROCEDURE.....	14
5.3 TEST SETUP.....	15-16
5.4 CONFIGURATION OF THE EUT.....	17
5.5 EUT OPERATING CONDITION.....	17
5.6 EMISSION LIMITS.....	17
5.7 RADIATED EMISSION TEST RESULTS.....	18
5.8 FUNDAMENTAL FREQUENCY TEST.....	19-24
6. BANDWIDTH	
6.1 LIMIT.....	25
6.2 RESULTS.....	25
7. CHANGE THE VOLTAGE +/-15% TEST.....	26
8. CHANGE THE TEMPERATURE TEST.....	27-29

1. TEST REPORT CERTIFICATION

APPLICANT : CELLINK CO., LTD.

ADDRESS : 11F, NO. 102, SEC. 1, HSIN TAI WU RD.,
HIS-CHIH, TAIPEI,
TAIWAN, R.O.C.

EUT DESCRIPTION : RF Wireless Keyboard

(A) POWER SUPPLY : RECEIVER FROM PC
TRANSMITTER FROM BATTERY

(B) MODEL : RF Combo 1

(C) FCC ID : POY-4710874200036

FINAL TEST DATE : 08/31/2001

MEASUREMENT PROCEDURE USED :

- * PART 15 SUBPART C OF FCC RULES AND REGULATIONS (47 CFR PART 15)
- * ANSI C63.4 - 1992
- * TEST PROCEDURE AND DATA ARE TRACEABLE TO NATIONAL OR INTERNATIONAL STANDARDS.

We hereby certify that :

The measurements contained in this report were made in accordance with the procedures indicated, and the energy emitted by the equipment was found to be within the limits applicable.

TESTING ENGINEER : _____ DATE _____
 Ken Su

SUPERVISOR : _____ DATE _____
 Sunyou Chen

APPROVED BY : _____ DATE _____
 Johnson Ho

2. TEST STATEMENT

2 . 1 TEST STATEMENT

1. This letter is to explain the test condition of this project.
The EUT be tested as the following status.
2. The data was shown in this report reflects the worst – case data for the condition as listed above.
Please disregard any other processor (s) speed shown in this user manual.
3. EUT Conditions.

Transmitting frequency : 27 .175MHz

Operation range : 6 feet

Hardware resolution : 600 dpi

4. NVLAP logo is to be approved by management (it is according to NVLAP requirement if it need) before use.

2 . 2 DEPARTURE FROM DOCUMENT POLICIES, PROCEDURE OR SPECIFICATIONS , THE STATEMENT

1. Did have
Any departure from document policies & procedures or from specifications.
Yes _____, No _____ .
If yes , the description as below.
2. The certificate and report shall not be reproduced except in full , without the written approval of SRT laboratory.
3. The report must not be used by the client to claim product endorsement by NVLAP or any agency the government.
4. This product is a test sample that was shown as the photos of this test report only.
5. The effect that the results relate only to the items tested.

3. EUT MODIFICATIONS

No modification by SRT lab.

4. CONDUCTED POWER LINE TEST

4.1 TEST EQUIPMENT

The following test equipment were used during the conducted power line test :

EQUIPMENT/ FACILITIES	SPECIFICATIONS	MANUFACTURER	MODEL#/ SERIAL#	DATE OF CAL. & CAL. CENTER	DUE DATE	FINAL TEST
EMI TEST RECEIVER	9 KHz TO 30 MHz	ROHDE & SCHWARZ	ESHS30/ 826003/008	MARCH 2001 R & S	1Y	
EMI TEST RECEIVER	9 KHz TO 2750 MHz	ROHDE & SCHWARZ	ESCS30/ 830245/012	JULY 2001 ETC	1Y	√
LISN	50 uH, 50 ohm	SOLAR ELECTRONICS	9252-50- R-24-BNC/ 951315	JULY 2001 ETC	1Y	√
LISN	50uH, 50 ohm	SOLAR ELECTRONICS	9252-50- R-24-BNC/ 951318	JULY 2001 ETC	1Y	√
SIGNAL GENERATOR	9 KHz TO 1080 MHz	ROHDE & SCHWARZ	SMY01/ 841104/019	MARCH 2001 ETC	1Y	√
POWER CONVERTER	50 TO 300 VAC 47 TO 63/50/60Hz	AFC	AFC-2KBB/ F100030030	APRIL 2001 SRT	1Y	√

4.2 TEST PROCEDURE

The EUT was tested according to ANSI C63.4 -1992. The frequency spectrum from 0.45 MHz to 30 MHz was investigated. The LISN used was 50 ohm / 50 uHenry as specified by section 5.1 of ANSI C63.4 - 1992 . Cables and peripherals were moved to find the maximum emission levels for each frequency.

4 . 3 TEST SETUP

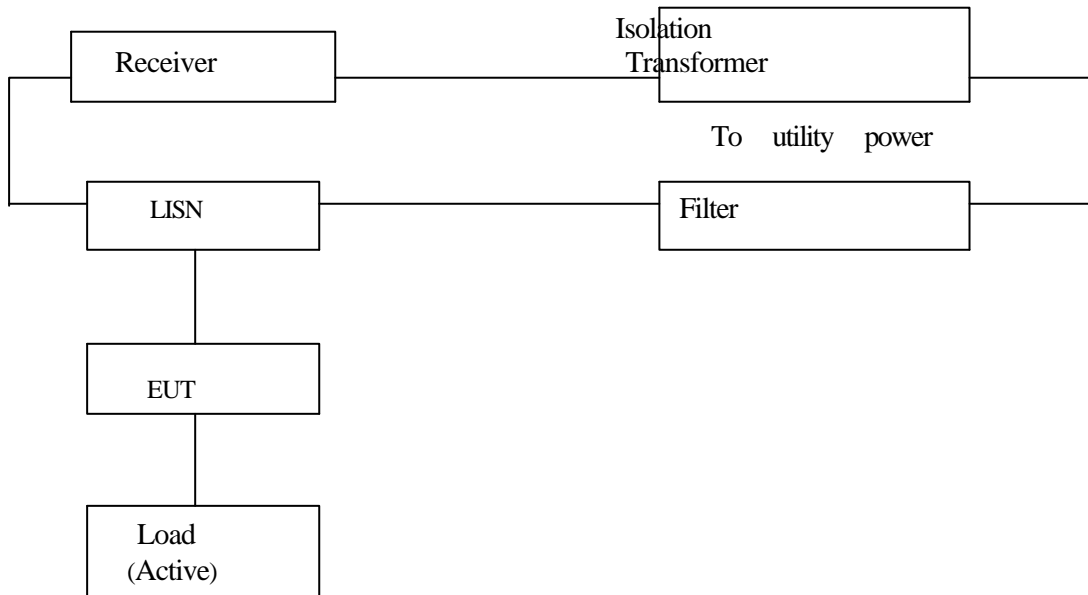
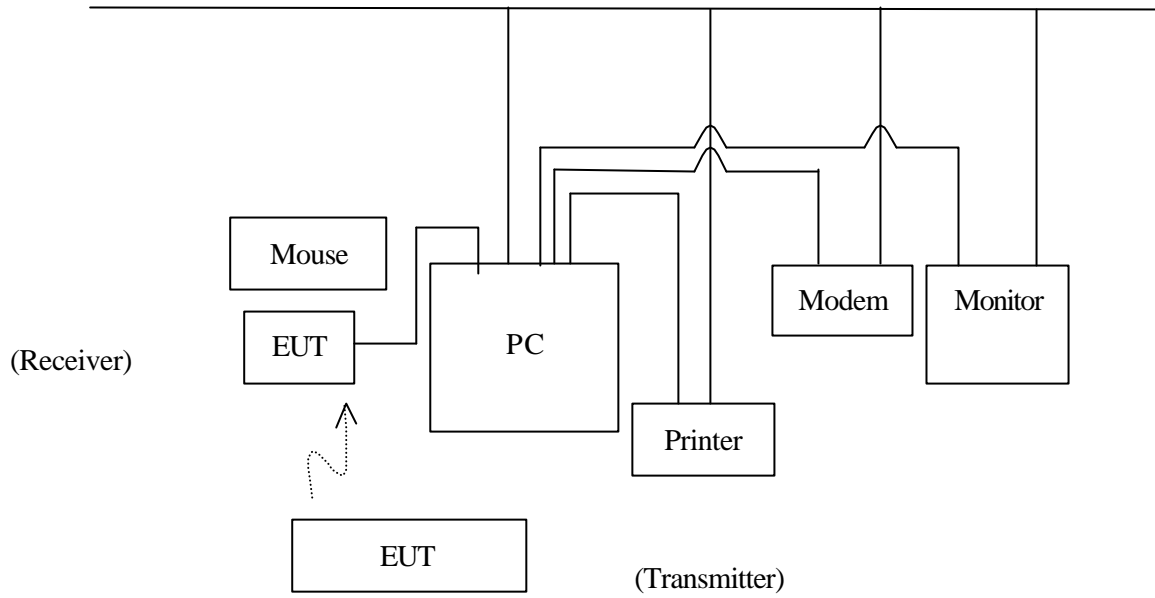

4 . 4 CONFIGURATION OF THE EUT

The EUT was configured according to ANSI C63.4 - 1992. All interface ports were connected to the appropriate peripherals. All peripherals and cables are listed below.

1. EUT

DEVICE	MANUFACTURER	MODEL #	FCCID/DoC
RF Wireless Keyboard	CELLINK CO., LTD.	RF Combo 1	PQY-4710874200036

2. INTERNAL DEVICES

DEVICE	MANUFACTURER	MODEL #	FCCID/DoC
N/A			

3. PERIPHERALS

DEVICE	MANUFACTURER	MODEL # SERIAL #	FCCID / DoC	CABLE
PRINTER	HP	2225C+	DSIXU2225	1.5m unshielded power cord 1.2m shielded data cable(S2)
MODEM	DATATRONICS	1200CK	E2050V-1200CK	1.5m unshielded power cord 1.2m shielded data cable(S2)
MONITOR	SAMSUNG	700IFT	DoC	1.5m unshielded power cord 1.2m shielded data cable(S2)
MOUSE	CELLINK	O-MOUSE	PQY-47108742 00012	N/A
MAIN BOARD	MSI	MS-6176	DoC	N/A
POWER SUPPLY	ENHANCE	SFX-1209F	DoC	N/A
HDD	MAXTOR	90432D2	DoC	N/A
FDD	NEC	FD-1231H	DoC	N/A
CD-ROM	ASUS	CD-S400/A	DoC	N/A

REMARK :

1. Cable - S1 : Single point shielding.
S2 : 360 ° shielding.
S3 : Double point shielding
2. Cables - All 1m or greater in length - bundled according to regulations.

4 . 5 EUT OPERATING CONDITION

Operating condition is according to ANSI C63.4 - 1992.

1. EUT power on.
2. Under WIN 98 run "EMI TEST" program.
" H" pattern sent to the following peripherals :
 - Monitor or VGA
 - RS232 (modem)
 - Keyboard
 - Printer
 - FDD
 - HDD

4 . 6 CONDUCTED POWER LINE EMISSION LIMITS

FREQUENCY RANGE (MHz)	CLASS A	CLASS B
0 . 45 - 1.705	60.0dB μ V	48.0dB μ V
1.705 - 30	69.5dB μ V	48.0dB μ V

NOTE : In the above table, the tighter limit applies at the band edges.

4 . 7 CONDUCTED POWER LINE TEST RESULTS

The frequency spectrum from 0.45 MHz to 30 MHz was investigated. All readings are quasi – peak values with a resolution bandwidth of 9 KHz.

- . Temperature : 23
- . Humidity : 55 %RH
- . Test result :

FREQUENCY (MHz)	LINE1 (dBmV)	LINE2 (dBmV)	LIMIT (dBmV)
0.61	40.3	*	48.0
0.92	39.5	38.5	48.0
1.42	42.2	*	48.0
1.63	*	40.4	48.0
2.65	35.6	39.0	48.0
24.00	33.5	33.5	48.0

- REMARKS** :
1. * = Measurement does not apply for this frequency
 2. Uncertainty in conducted emission measured is <+/-2dB
 3. Any departure from specification : N/A

SIGNED BY TESTING ENGINEER : _____

5. RADIATED EMISSION TEST

5.1 TEST EQUIPMENT

The following test equipment were used during the radiated emission test :

EQUIPMENT / FACILITIES	SPECIFICATIONS	MANUFACTURER - ER	MODEL # / SERIAL #	DATE OF CAL. & CAL. CENTER	DUE DATE	FINAL TEST
TEST RECEIVER	9 KHz TO 2.75 MHz	R & S	ESCS30/ 830245/012	JULY 2000 ETC	1Y	
TEST RECEIVER	20 MHz TO 1000 MHz	R & S	ESVS30/ 841977/003	JUNE 2001 ETC	1Y	√
SPECTRUM ANALYZER	100 Hz TO 1500 MHz	HP	8568B/ 3001A04931	AUG. 2001 ETC	1Y	
SPECTRUM ANALYZER	9 KHz TO 22 GHz	HP	8593E/ 3322A00670	MARCH 2001 ETC	1Y	
SIGNAL GENERATOR	9 KHz TO 1080 MHz	ROHDE & SCHWARZ	SMY01/ 841104/019	MARCH 2001 ETC	1Y	√
DIPOLE ANTENNA	28 MHz TO 1000 MHz	EMCO	3121C/ 9003-534	FEB. 2001 SRT	1Y	
DIPOLE ANTENNA	28 MHz TO 1000 MHz	EMCO	3121C/ 9611-1239	FEB. 2001 SRT	1Y	
BI-LOG ANTENNA	26 MHz TO 2000 MHz	EMCO	3142/ 9701-1124	NOV. 2000 SRT	1Y	
BI-LOG ANTENNA	26 MHz TO 2000 MHz	EMCO	3142/ 9608-1073	SET. 2000 SRT	1Y	
BI-LOG ANTENNA	30MHz TO 2.0GHz	SCHAFFNER -CHASE	CBL6141A/ 4181	JULY 2001 ETC	1Y	√
PRE-AMPLIFIER	0.1 MHz TO 1300 MHz	HP	8447D/ 2944A08402	MARCH 2001 SRT	1Y	
PRE-AMPLIFIER	0.1 MHz TO 1300 MHz	HP	8447D/ 2944A06412	AUG. 2000 ETC	1Y	
HORN ANTENNA	1 GHz TO 18 GHz	EMCO	3115/ 9012-3619	JAN. 2001 ETC	1Y	

5 . 2 TEST PROCEDURE

1. The EUT was tested according to ANSI C63.4 - 1992. The radiated test was performed at SRT lab's open site. This site is on file with the FCC laboratory division, reference 31040/SIT.
2. The EUT, peripherals were put on the turntable which table size is 1m x 1.5m, table high 0.8m. All set up is according to ANSIC63.4-1992.
3. The frequency spectrum from 26 MHz to 1 GHz was investigated. All readings from 30 MHz to 1 GHz are quasi-peak values with a resolution bandwidth of 120 KHz. All readings are above 1 GHz , peak values with a resolution bandwidth of 1 MHz . Measurements were made at 3 meters.
4. The antenna high were varied from 1 m to 4 m high to find the maximum emission for each frequency.
5. The antenna polarization : Vertical polarization and horizontal polarization.

5 . 3 RADIATED TEST SET-UP

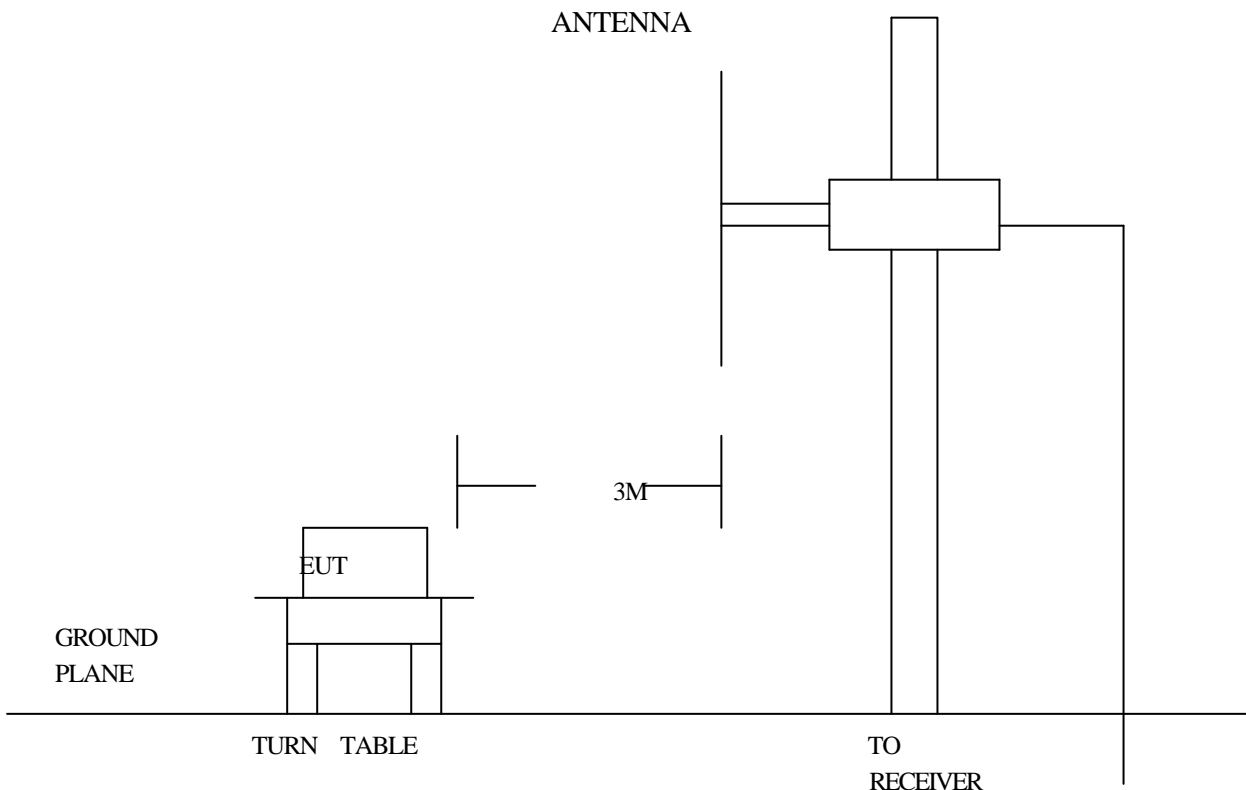

5 . 3 RADIATED TEST SET-UP

ANSI C63.4-1992

ELECTRICAL AND ELECTRONIC EQUIPMENT IN THE RANGE IN THE RANGE OF 9 KHz TO 40 GHz

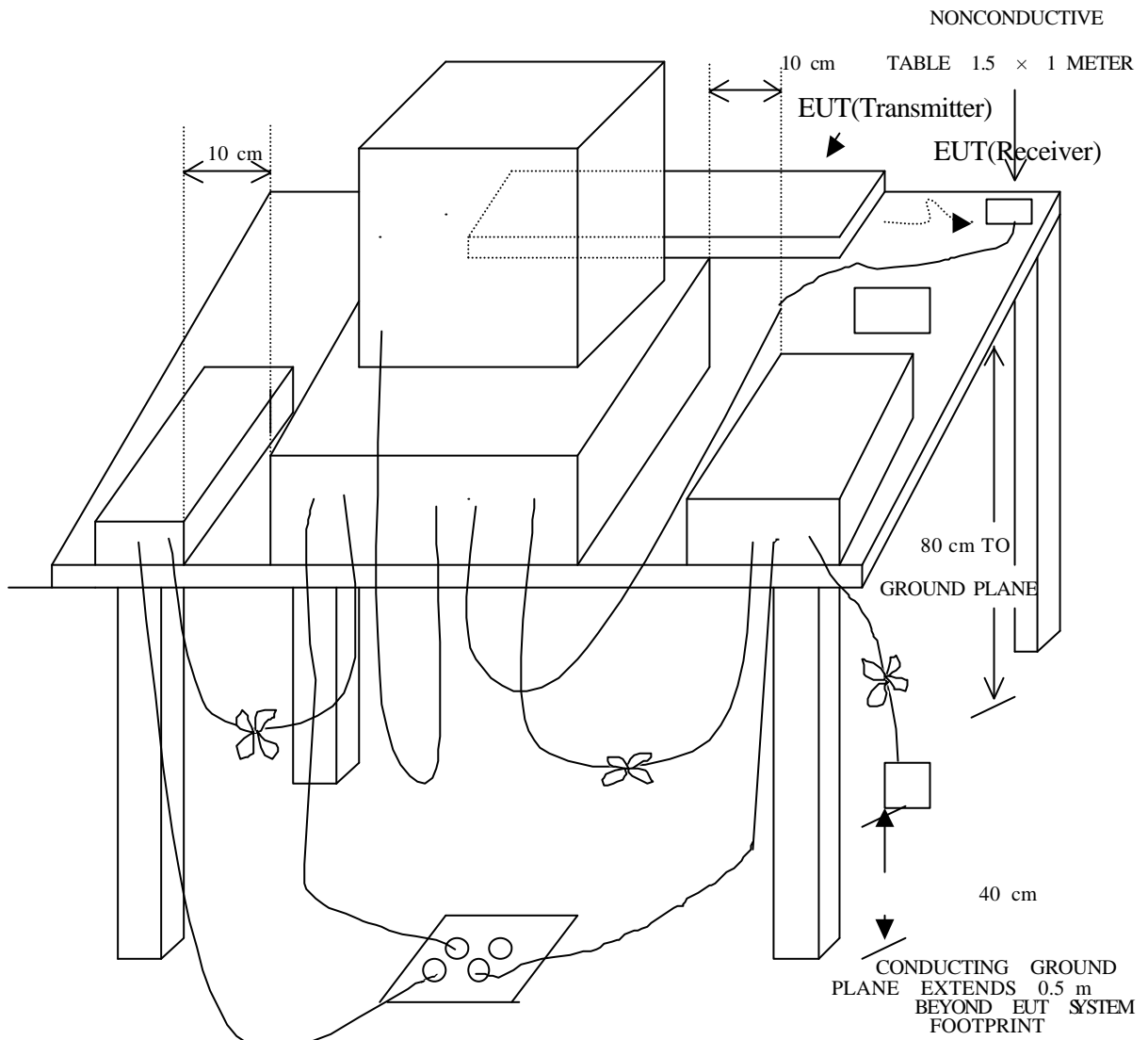

5 . 4 CONFIGURATION OF THE THE EUT

Same as section 4.4 of this report

5 . 5 EUT OPERATING CONDITION

Same as section 4.5 of this report.

5 . 6 RADIATED EMISSION LIMITS

All emission from a digital device, including any network of conductors and apparatus connected thereto, shall not exceed the level of field strength specified below :

CLASS B

FREQUENCY (MHz)	DISTANCE (m)	FIELD STRENGTH (dBmV/m)	DET.
30 - 88	3	40.0	QUASI-PEAK
88 - 216	3	43.5	QUASI-PEAK
216 - 960	3	46.0	QUASI-PEAK
ABOVE 960	3	54.0	QUASI-PEAK

According to 47 CFR § 15.227

FREQUENCY (MHz)	DISTANCE (m)	FIELD STRENGTH (dBmV/m)	DET.
26.96 - 27.28	3	80.0	AVERAGE

- NOTE** : 1. In the emission tables above , the tighter limit applies at the band edges.
2. Distance refers to the distance between measuring instrument, antenna ,and the closest point of any part of the device or system.

5 . 7 RADIATED EMISSION TEST RESULTS

The frequency spectrum from 26 MHz to 1 GHz was investigated. All readings from 30 MHz to 1 GHz are quasi-peak values with a resolution bandwidth of 120 KHz . All readings are above 1 GHz , peak values with a resolution bandwidth of 1 MHz. Measurements were made at 3 meters.

- . Temperature : 23
- . Humidity : 55 %RH
- . Test result :

FREQ. (MHz)	FACTOR (dB)	ANT. FACTOR (dB/m)	READING (dBmV)		EMISSION (dBmV/m)		LIMITS (dBmV/m)	AZ (°)	EL(M)
			HORIZ	VERT	HORIZ	VERT			
27.1778	0.2	20.0	48.2	39.4	68.4	59.6	80.0	155.0	1.5
54.3486	1.2	13.4	*	20.1	*	34.7	40.0	198.0	1.55
108.6972	1.5	11.3	*	21.2	*	34.0	43.5	188.0	1.45
163.0458	1.9	12.2	19.5	*	33.6	*	43.5	155.0	1.6
217.3944	2.2	12.2	21.8	*	36.2	*	46.0	222.0	1.55
67.00	1.2	8.6	24.8	22.6	34.3	32.4	40.0	188.0	1.6
117.20	1.5	12.2	*	20.7	*	34.4	43.5	237.0	1.5
122.86	1.7	12.6	20.1	*	34.4	*	43.5	155.0	1.6
177.66	2.1	11.0	21.6	*	34.7	*	43.5	195.0	1.6
301.06	2.7	13.6	22.8	22.9	39.1	39.2	46.0	225.6	1.4

- REMARKS** :
1. *= Measurement does not apply for this frequency.
 2. Uncertainty in radiated emission measured is <+/-4dB
 3. Any departure from specification : N/A
 4. Factor will include cable loss and correction factor.
 5. Sample calculation
Emission(dB μ v/m) = Factor (dB) + Ant. Factor (dB/m) + reading (dB μ V)
 6. AZ(°) : Turn table azimuth
 7. EL(M) : Antenna height (Meter)
 8. The frequency of 27.1178MHz is measured by Loop Antenna, and the others are measured by BI-LOG Antenna.

SIGNED BY TESTING ENGINEER : _____

5.8 FUNDAMENTAL FREQUENCY TEST

5.8.1 TEST EQUIPMENT

EQUIPMENT/ FACILITIES	SPECIFICATIONS	MANUFACTURER	MODEL#/ SERIAL#	DATE OF CAL. & CAL. CENTER	DUE DATE	FINAL TEST
EMI TEST RECEIVER	9 KHz TO 2750 MHz	ROHDE & SCHWARZ	ESCS30/ 830245/012	JULY 2000 ETC	1Y	√
LOOP ANTENNA	9 KHz TO 30 MHz	ROHDE & SCHWARZ	HFH 2-Z2/ 860 605/002	JUNE 2001 R&S	1Y	√

5.8.2 TEST PROCEDURE

1. Sst-up LOOP antenna at 3m distance.
2. Turn the turn table.
3. After find the max. data then changed the height of antenna from 1m to 2m to find the max of emission.
4. Turn the turn table again.
5. Changed the LOOP antenna to polarization.

NOTE :

1. Both polarizations (vertical and horizontal were tested) .
2. The testing distance is under 15 cm between TX and RX. We can not pick up any emission if the distance is over 15 cm. We found the max. Signal is on the vertical and pen touch to the TX (board).

5.8.3 TEST SETUP

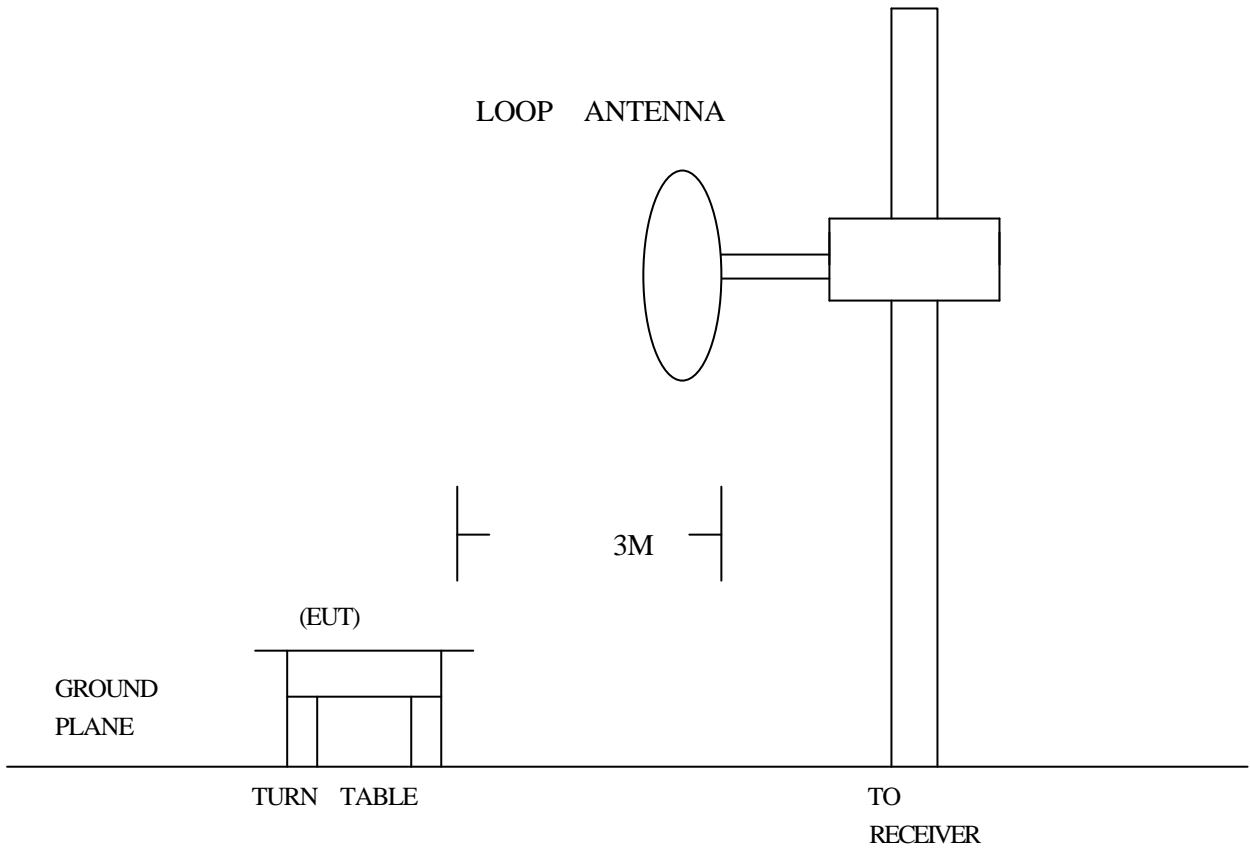

5.8.4 CONFIGURATION OF THE EUT

Same as section 4.5 of this report

5.8.5 EUT OPERATING CONDITION

Same as section 4.6 of this report

5.8.6 LIMIT

ACCORDING TO 47 CFR § 15.227

FREQUENCY (MHz)	DISTANCE (m)	FIELD STRENGTH (dBmV/m)	DET.
26.96 - 27.28	3	80.0	AVERAGE

5.8.7 RADIATED EMISSION TEST RESULT

The frequency spectrum from 450 KHz to 30 MHz was investigated.
The values under 30MHz with a resolution bandwidth of 10KHz.
The distance was 3 meter.

- . Temperature : 25
- . Humidity : 56 %RH
- . Test result :

FREQ. (KHz)	FACTOR (dB)	ANT. FACTOR (dB/m)	READING (dB μ V)		EMISSION (dB μ V/m)		LIMITS (dB μ V/m)
			HORIZ	VERT	HORIZ	VERT	
27.1778	0.2	20.0	48.2	39.4	68.4	59.6	80.0

- REMARKS** :
1. *= Measurement does not apply for this frequency.
 2. Uncertainty in radiated emission measured is ± 4 dB
 3. Any departure from specification : N/A
 4. Factor will include cable loss and correction factor.
 5. Sample calculation

$$\text{Emission(dB}\mu\text{v/m)} = \text{Factor (dB)} + \text{Ant. Factor (dB/m)} + \text{reading (dB}\mu\text{V)}$$

SIGNED BY TESTING ENGINEER : _____

*Horizontal

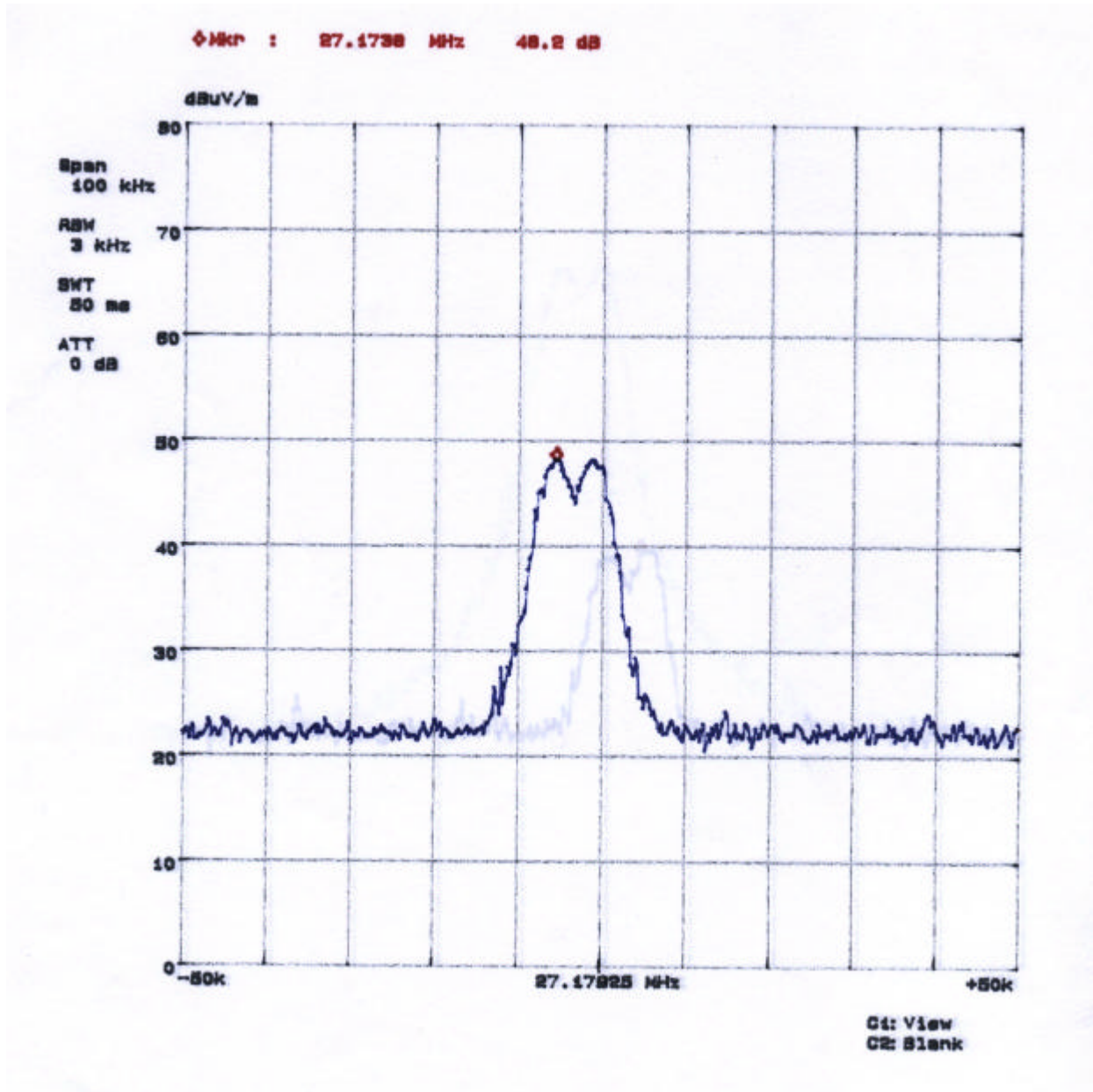

*Vertical

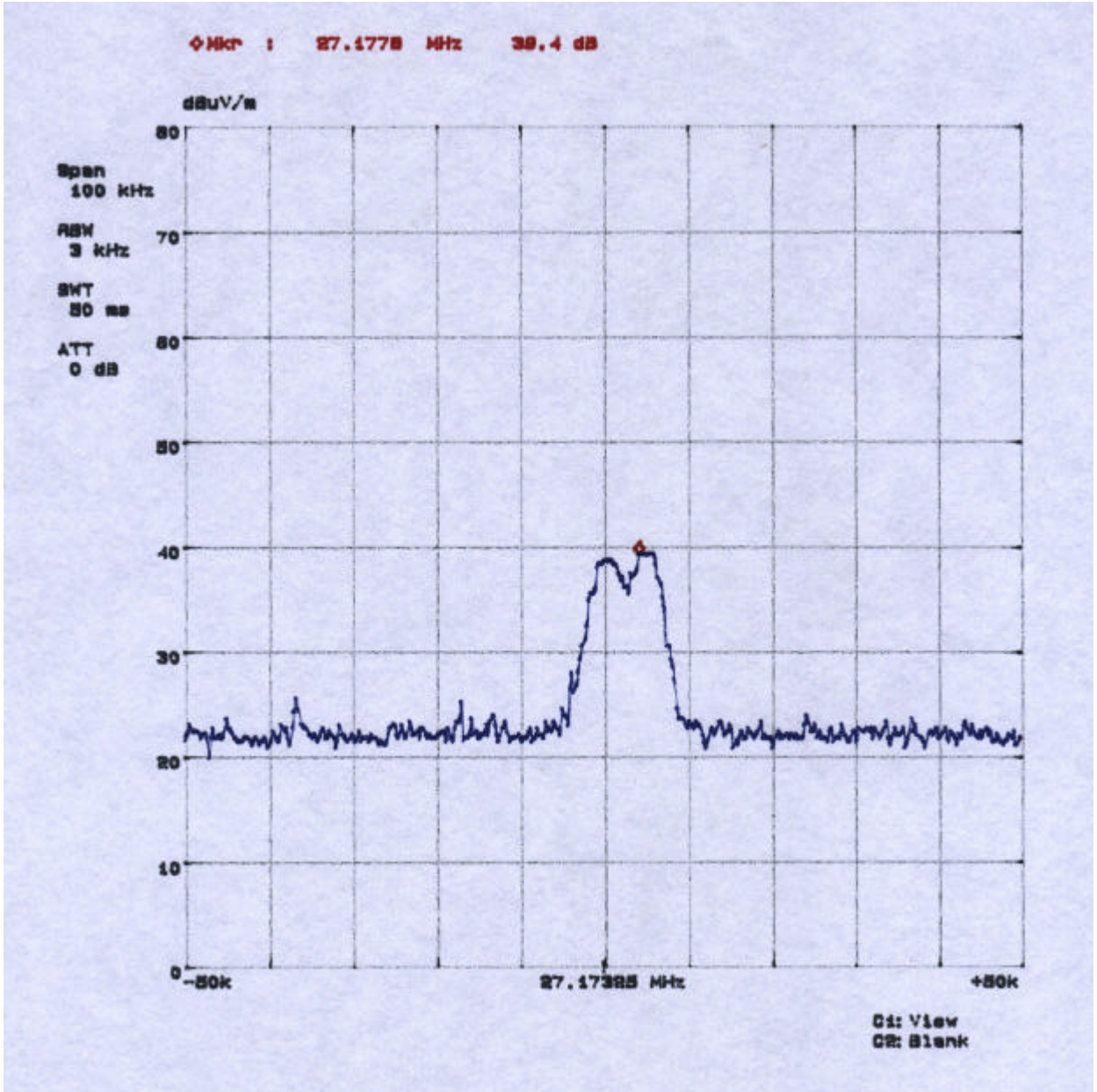

6. BANDWIDTH

6 . 1 LIMIT

20dB bandwidth

6 . 2 TEST RESULTS

Operation frequency	20dB bandwidth
27MHz	13.3KHz

Please see attached plotter.

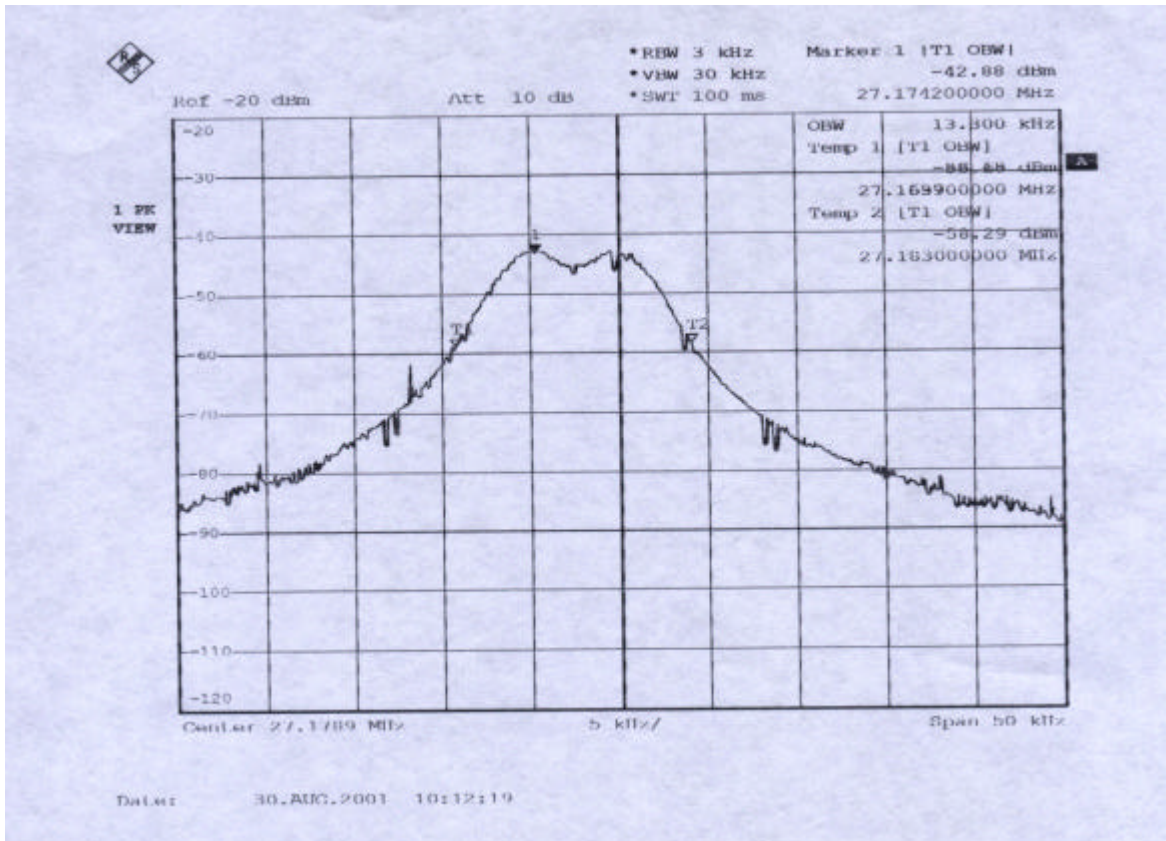

7. CHANGE THE VOLTAGE FROM -15% TO +15% TO CHECK THE FREQUENCY VARIATION

- A. When voltage is 3V
- B. When voltage is 3.45V (change +15%)
- C. When voltage is 2.55V (change -15%)

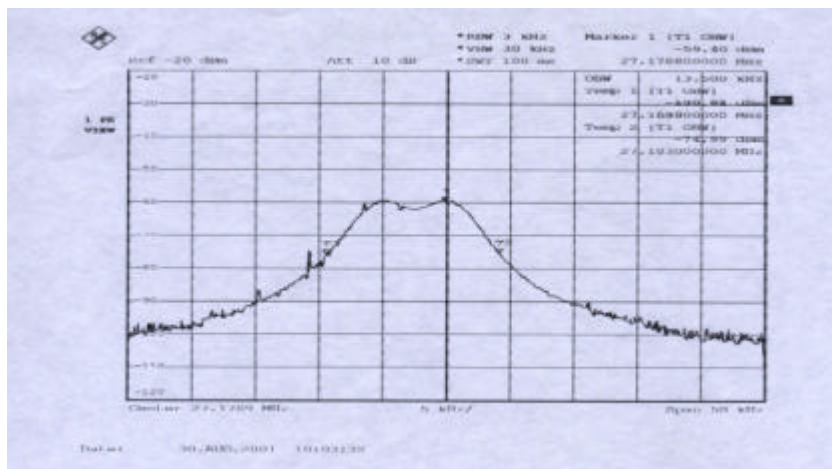
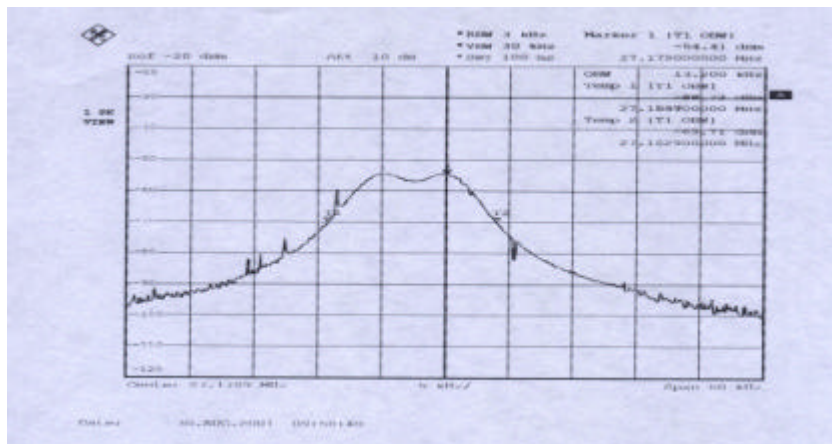
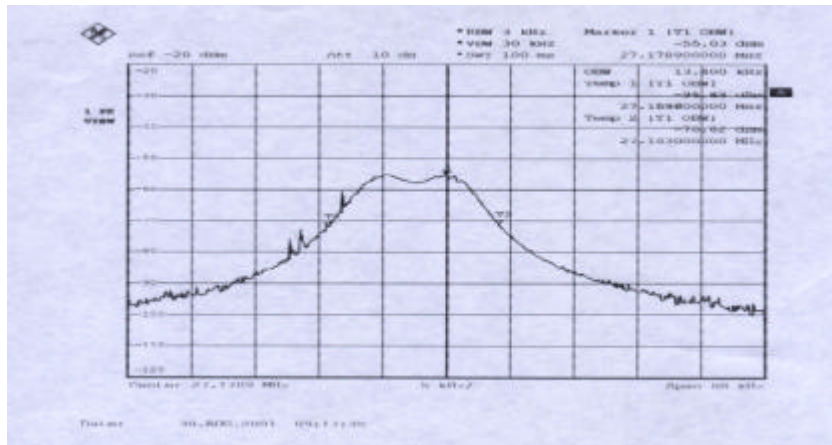

8. THE TEMPERATURE CHANGE TEST

A. Temperature is -20°C, -10°C and 0°C

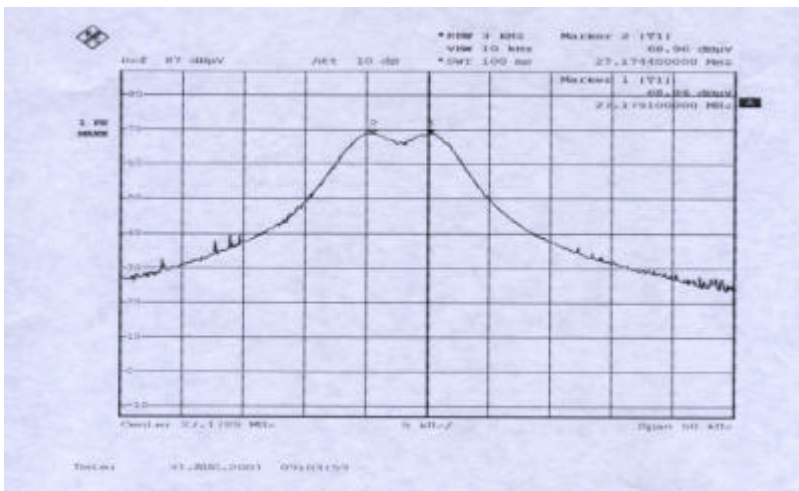
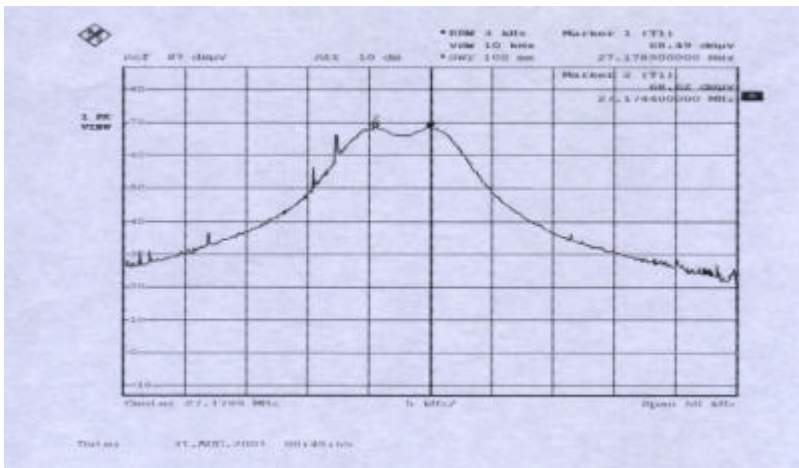
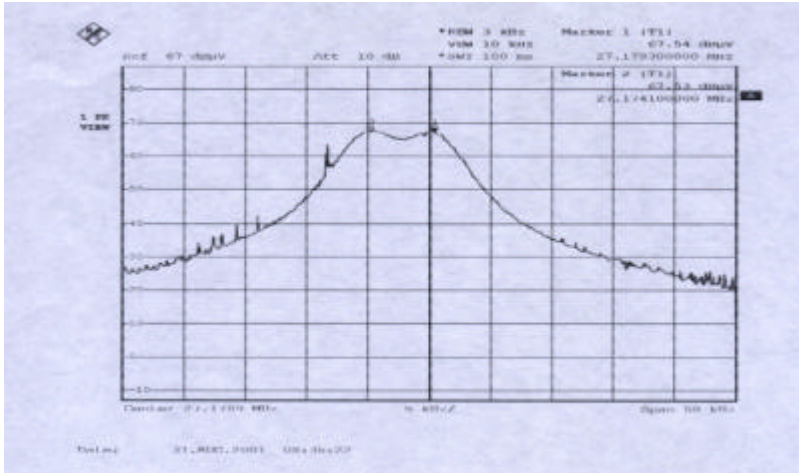

B. Temperature is 10°C, 20°C and 30°C

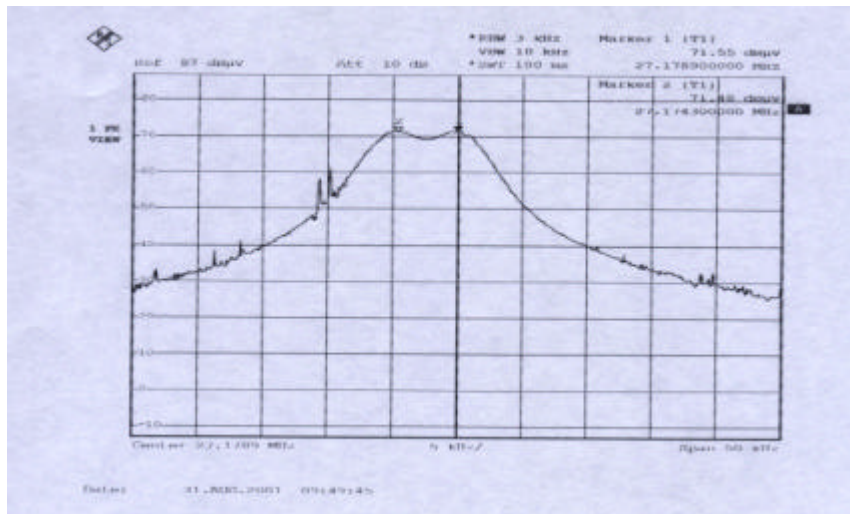
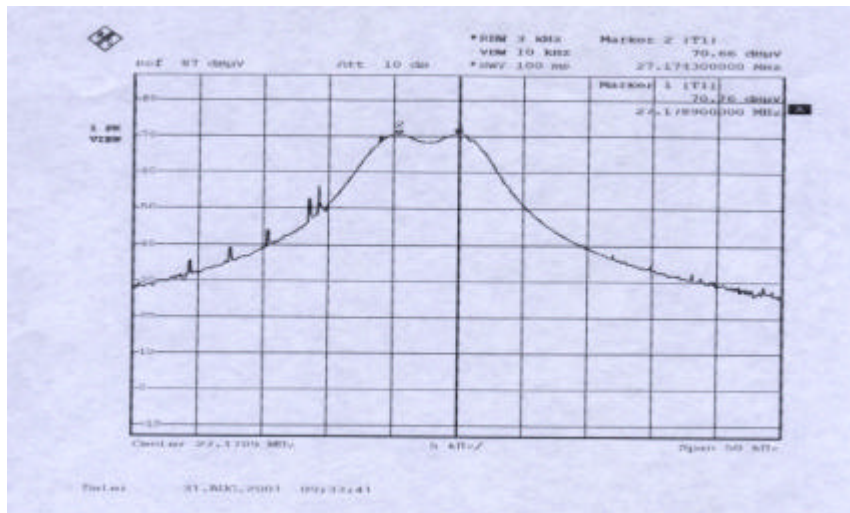
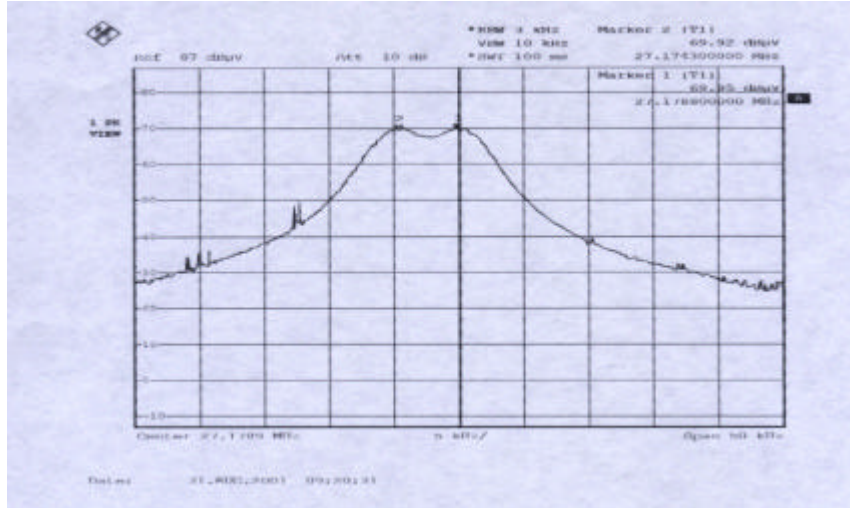

C. Temperature is 40°C and 50°C

