

FCC Test Report

Report No.: RF120113E07J

FCC ID: PQRFXE2000-G

Test Model: FXE2000-G

Received Date: Apr. 20, 2016

Test Date: May 04 to 05, 2016

Issued Date: May 25, 2016

Applicant: Contec Co., Ltd.

Address: 3-9-31, Himesato, Nishiyodogawa-ku Osaka Japan 555-0025

Issued By: Bureau Veritas Consumer Products Services (H.K.) Ltd., Taoyuan Branch
Hsin Chu Laboratory

Lab Address: E-2, No.1, Li Hsin 1st Road, Hsinchu Science Park, Hsinchu City 300,
Taiwan R.O.C.

Test Location: E-2, No.1, Li Hsin 1st Road, Hsinchu Science Park, Hsinchu City 300,
Taiwan R.O.C.



This report is for your exclusive use. Any copying or replication of this report to or for any other person or entity, or use of our name or trademark, is permitted only with our prior written permission. This report sets forth our findings solely with respect to the test samples identified herein. The results set forth in this report are not indicative or representative of the quality or characteristics of the lot from which a test sample was taken or any similar or identical product unless specifically and expressly noted. Our report includes all of the tests requested by you and the results thereof based upon the information that you provided to us. You have 60 days from date of issuance of this report to notify us of any material error or omission caused by our negligence, provided, however, that such notice shall be in writing and shall specifically address the issue you wish to raise. A failure to raise such issue within the prescribed time shall constitute your unqualified acceptance of the completeness of this report, the tests conducted and the correctness of the report contents. Unless specific mention, the uncertainty of measurement has been explicitly taken into account to declare the compliance or non-compliance to the specification. The report must not be used by the client to claim product certification, approval, or endorsement by TAF or any government agencies.

Table of Contents

Release Control Record	4
1 Certificate of Conformity	5
2 Summary of Test Results	6
2.1 Measurement Uncertainty	6
2.2 Modification Record	6
3 General Information	7
3.1 General Description of EUT	7
3.2 Description of Test Modes	10
3.2.1 Test Mode Applicability and Tested Channel Detail	11
3.3 Duty Cycle of Test Signal	13
3.4 Description of Support Units	14
3.4.1 Configuration of System under Test	15
3.5 General Description of Applied Standard	16
4 Test Types and Results	17
4.1 Radiated Emission and Bandedge Measurement	17
4.1.1 Limits of Radiated Emission and Bandedge Measurement	17
4.1.2 Test Instruments	19
4.1.3 Test Procedure	20
4.1.4 Deviation from Test Standard	20
4.1.5 Test Setup	21
4.1.6 EUT Operating Condition	21
4.1.7 Test Results	22
4.2 Transmit Power Measurement	40
4.2.1 Limits of Transmit Power Measurement	40
4.2.2 Test Setup	41
4.2.3 Test Instruments	41
4.2.4 Test Procedure	41
4.2.5 Deviation from Test Standard	41
4.2.6 EUT Operating Condition	41
4.2.7 Test Result	42
4.3 Peak Power Spectral Density Measurement	43
4.3.1 Limits of Peak Power Spectral Density Measurement	43
4.3.2 Test Setup	43
4.3.3 Test Instruments	43
4.3.4 Test Procedure	43
4.3.5 Deviation from Test Standard	43
4.3.6 EUT Operating Condition	43
4.3.7 Test Results	44
4.4 Frequency Stability Measurement	46
4.4.1 Limits of Frequency Stability Measurement	46
4.4.2 Test Setup	46
4.4.3 Test Instruments	46
4.4.4 Test Procedure	46
4.4.5 Deviation from Test Standard	46
4.4.6 EUT Operating Condition	46
4.4.7 Test Results	47
4.5 6dB Bandwidth Measurement	48
4.5.1 Limits of 6dB Bandwidth Measurement	48
4.5.2 Test Setup	48
4.5.3 Test Instruments	48
4.5.4 Test Procedure	48
4.5.5 Deviation from Test Standard	48
4.5.6 EUT Operating Condition	48



4.5.7 Test Results	49
5 Pictures of Test Arrangements.....	51
Annex A- Radiated Out of Band Emisison (OOBE) Measurement (For U-NII-3 band)	52
Appendix – Information on the Testing Laboratories	55



A D T

Release Control Record

Issue No.	Description	Date Issued
RF120113E07J	Original release.	May 25, 2016

1 Certificate of Conformity

Product: Wireless LAN Adapter

Brand: CONTEC

Test Model: FXE2000-G

Sample Status: ENGINEERING SAMPLE

Applicant: Contec Co., Ltd.

Test Date: May 04 to 05, 2016

Standard: 47 CFR FCC Part 15, Subpart E (Section 15.407)
ANSI C63.10: 2013

The above equipment has been tested by **Bureau Veritas Consumer Products Services (H.K.) Ltd., Taoyuan Branch**, and found compliance with the requirement of the above standards. The test record, data evaluation & Equipment Under Test (EUT) configurations represented herein are true and accurate accounts of the measurements of the sample's EMC characteristics under the conditions specified in this report.

Prepared by : Wendy Wu , **Date:** May 25, 2016
Wendy Wu / Specialist

Approved by : May Chen , **Date:** May 25, 2016
May Chen / Manager

2 Summary of Test Results

47 CFR FCC Part 15, Subpart E (SECTION 15.407)			
FCC Clause	Test Item	Result	Remarks
15.407(b) (1/2/3/4(i/ii)/6)	Radiated Emissions & Band Edge Measurement*	Pass	Meet the requirement of limit. Minimum passing margin is -3.0dB at 87.64MHz.
15.407(a)(1/2/3)	Max Average Transmit Power	Pass	Meet the requirement of limit.
15.407(a)(1/2/3)	Peak Power Spectral Density	Pass	Meet the requirement of limit.
15.407(e)	6dB bandwidth	Pass	Meet the requirement of limit. (U-NII-3 Band only)
15.407(g)	Frequency Stability	Pass	Meet the requirement of limit.
15.203	Antenna Requirement	Pass	Antenna connector is U.FL not a standard connector.

*For U-NII-3 band compliance with rule part 15.407(b)(4)(i), the OOB test plots were recorded in Annex A.

NOTE: 1. This report is prepared for FCC Class II change. (Upgraded the standard to section 15.407 under new rule for UNII-3 band)

2.1 Measurement Uncertainty

Where relevant, the following measurement uncertainty levels have been estimated for tests performed on the EUT as specified in CISPR 16-4-2:

Measurement	Frequency	Expanded Uncertainty (k=2) (±)
Radiated Emissions up to 1 GHz	30MHz ~ 1GHz	5.19 dB
Radiated Emissions above 1 GHz	1GHz ~ 6GHz	3.43 dB
	6GHz ~ 18GHz	3.49 dB
	18GHz ~ 40GHz	4.11 dB

2.2 Modification Record

There were no modifications required for compliance.

3 General Information

3.1 General Description of EUT

Product	Wireless LAN Adapter
Brand	CONTEC
Test Model	FXE2000-G
Status of EUT	ENGINEERING SAMPLE
Power Supply Rating	DC 5V from power adapter
Modulation Type	CCK, DQPSK, DBPSK for DSSS 64QAM, 16QAM, QPSK, BPSK for OFDM
Modulation Technology	DSSS, OFDM
Transfer Rate	802.11b: up to 11Mbps 802.11a/g: up to 54Mbps 802.11n: up to 300Mbps
Operating Frequency	For 15.407: 5.18GHz ~ 5.24GHz, 5.26GHz ~ 5.32GHz, 5.50GHz ~ 5.70GHz, 5.745GHz ~ 5.825GHz For 15.247: 2.412 ~ 2.462GHz
Number of Channel	For 15.407: 802.11a, 802.11n (HT20): 24 802.11n (HT40): 11 For 15.247: 802.11b, 802.11g, 802.11n (HT20): 11 802.11n (HT40): 7
Output Power	For 15.407: 5.18GHz ~ 5.24GHz 25.827mW 5.26GHz ~ 5.32GHz 30.624mW 5.50GHz ~ 5.70GHz 62.559mW 5.745GHz ~ 5.825GHz 101.569mW For 15.247: 662.965mW
Antenna Type	Refer to Note
Antenna Connector	Refer to Note
Accessory Device	Adapter x 1
Data Cable Supplied	NA

Note:

1. This report is prepared for FCC class II permissive change. The difference compared with the Report No.: RF120113E07 is as the following information:

◆ Upgrade the standard to section 15.407 under new rule for U-NII-3 band.

2. For U-NII-1, UNII-2A and UNII-2C Band: There is no increase in authorized power level, so RF test data refer to the original test report (RF120113E07-1).

3. According to above conditions, all test items of U-NII-3 band test item need to be performed, except for AC power conducted emission test item. And all data was verified to meet the requirements.

4. The EUT needs to be supplied with a power adapter as following table:

Brand	Model No.	Spec.
Sino-American	SA115B-05U	Input: 100-240V, 0.4A, 50-60Hz AC input cable (1.8m, unshielded) Output: 5V, 2A, 10W DC output cable (1.9m, unshielded)

5. The EUT incorporates a MIMO function.

MODULATION MODE	TX/RX FUNCTION
802.11b	2Tx/2Rx
802.11g	2Tx/2Rx
802.11a	2Tx/2Rx
802.11n (HT20)	2Tx/2Rx
802.11n (HT40)	2Tx/2Rx

6. The antennas provided to the EUT, please refer to the following table:

Set 1									
Brand	Model	Antenna Type	Peak Gain(dBi) (Exclude cable loss)	Net Gain (dBi) (Include cable loss)	Connector Type	Cable Length (cm)	Cable Loss (dB)	Transmitter Circuit	
FDK	AN1523	chip	2.4GHz: 2	2.4GHz: 0.6	U.FL	16	1.4	Chain (0) & Chain (1)	
			5GHz :1	5GHz :-0.4					
Set 2									
Brand	Model	Antenna Type	Peak Gain(dBi) (Exclude cable loss)	Net Gain (dBi) (Include cable loss)	Connector Type	Cable Length (cm)	Cable Loss (dB)	Total Cable Loss (dB)	Transmitter Circuit
Azure Solutions, Inc.	MR-1700-W	Vehicle	2.4GHz: 4	2.4GHz: 2.1695	Cable 1: R-SMA	Cable 1: 152	Cable 1: 0.9305	1.8305	Chain (0) & Chain (1)
					Cable 2: U.FL	Cable 2: 20	Cable 2: 0.9		
Set 3									
Brand	Model	Antenna Type	Peak Gain(dBi) (Exclude cable loss)	Net Gain (dBi) (Include cable loss)	Connector Type	Cable Length (cm)	Cable Loss (dB)	Total Cable Loss (dB)	Transmitter Circuit
Azure Solutions, Inc.	MR-6000	Vehicle	5GHz :4	5GHz: 0.7978	Cable 1: R-SMA	Cable 1: 152	Cable 1: 1.5022	3.2022	Chain (0) & Chain (1)
					Cable 2: U.FL	Cable 2: 20	Cable 2: 1.7		

Note: When operating with Ant Set 2 or Set 3. The antenna cable1 & cable2 should be connected together.

7. 2.4GHz and 5GHz technology cannot transmit at same time.
8. When the EUT operating in 802.11n, the software operation, which is defined by manufacturer, MCS (Modulation and Coding Schemes) from 0 to 15.
9. The above EUT information is declared by manufacturer and for more detailed features description, please refer to the manufacturer's specifications or user's manual.

3.2 Description of Test Modes

FOR 5745 ~ 5825MHz:

5 channels are provided for 802.11a, 802.11n (HT20):

Channel	Frequency	Channel	Frequency
149	5745MHz	161	5805MHz
153	5765MHz	165	5825MHz
157	5785MHz		

2 channels are provided for 802.11n (HT40):

Channel	Frequency	Channel	Frequency
151	5755MHz	159	5795MHz

3.2.1 Test Mode Applicability and Tested Channel Detail

EUT Configure Mode	Applicable To			Description
	RE \geq 1G	RE<1G	APCM	
-	√	√	√	-

Where **RE \geq 1G**: Radiated Emission above 1GHz **RE<1G**: Radiated Emission below 1GHz
APCM: Antenna Port Conducted Measurement

NOTE:

- EUT with antenna set 1: In original report, the EUT had been pre-tested on the positioned of each 3 axis. The worst case was found when positioned on **X-plane** (Below 1GHz) & **Y-plane** (Above 1GHz).

Radiated Emission Test (Above 1GHz):

- Pre-Scan has been conducted to determine the worst-case mode from all possible combinations between available modulations, data rates and antenna ports (if EUT with antenna diversity architecture).
- Following channel(s) was (were) selected for the final test as listed below.

Ant Set 1						
Mode	FREQ. Band (MHz)	Available Channel	Tested Channel	Modulation Technology	Modulation Type	Data Rate (Mbps)
802.11a	5745-5825	149 to 165	149, 157, 165	OFDM	BPSK	6
802.11n (HT20)		149 to 165	149, 157, 165	OFDM	BPSK	6.5
802.11n (HT40)		151 to 159	151, 159	OFDM	BPSK	13.5
Ant Set 3						
Mode	FREQ. Band (MHz)	Available Channel	Tested Channel	Modulation Technology	Modulation Type	Data Rate (Mbps)
802.11a	5745-5825	149 to 165	149, 157, 165	OFDM	BPSK	6
802.11n (HT20)		149 to 165	149, 157, 165	OFDM	BPSK	6.5
802.11n (HT40)		151 to 159	151, 159	OFDM	BPSK	13.5

Radiated Emission Test (Below 1GHz):

- Pre-Scan has been conducted to determine the worst-case mode from all possible combinations between available modulations, data rates and antenna ports (if EUT with antenna diversity architecture).
- Following channel(s) was (were) selected for the final test as listed below.

Ant Set 1						
Mode	FREQ. Band (MHz)	Available Channel	Tested Channel	Modulation Technology	Modulation Type	Data Rate (Mbps)
802.11a	5745-5825	149 to 165	165	OFDM	BPSK	6
Ant Set 3						
Mode	FREQ. Band (MHz)	Available Channel	Tested Channel	Modulation Technology	Modulation Type	Data Rate (Mbps)
802.11a	5745-5825	149 to 165	165	OFDM	BPSK	6

Antenna Port Conducted Measurement:

- This item includes all test value of each mode, but only includes spectrum plot of worst value of each mode.
- Pre-Scan has been conducted to determine the worst-case mode from all possible combinations between available modulations, data rates and antenna ports (if EUT with antenna diversity architecture).
- Following channel(s) was (were) selected for the final test as listed below.

Mode	FREQ. Band (MHz)	Available Channel	Tested Channel	Modulation Technology	Modulation Type	Data Rate (Mbps)
802.11a	5745-5825	149 to 165	149, 157, 165	OFDM	BPSK	6
802.11n (HT20)		149 to 165	149, 157, 165	OFDM	BPSK	6.5
802.11n (HT40)		151 to 159	151, 159	OFDM	BPSK	13.5

Test Condition:

Applicable To	Environmental Conditions	Input Power	Tested By
RE\geq1G	22deg. C, 76%RH	120Vac, 60Hz	Gary Cheng
RE$<$1G	25deg. C, 68%RH	120Vac, 60Hz	Gary Cheng
APCM	25deg. C, 60%RH	120Vac, 60Hz	Gary Cheng

3.3 Duty Cycle of Test Signal

Duty cycle of test signal is 100 %, duty factor is not required.

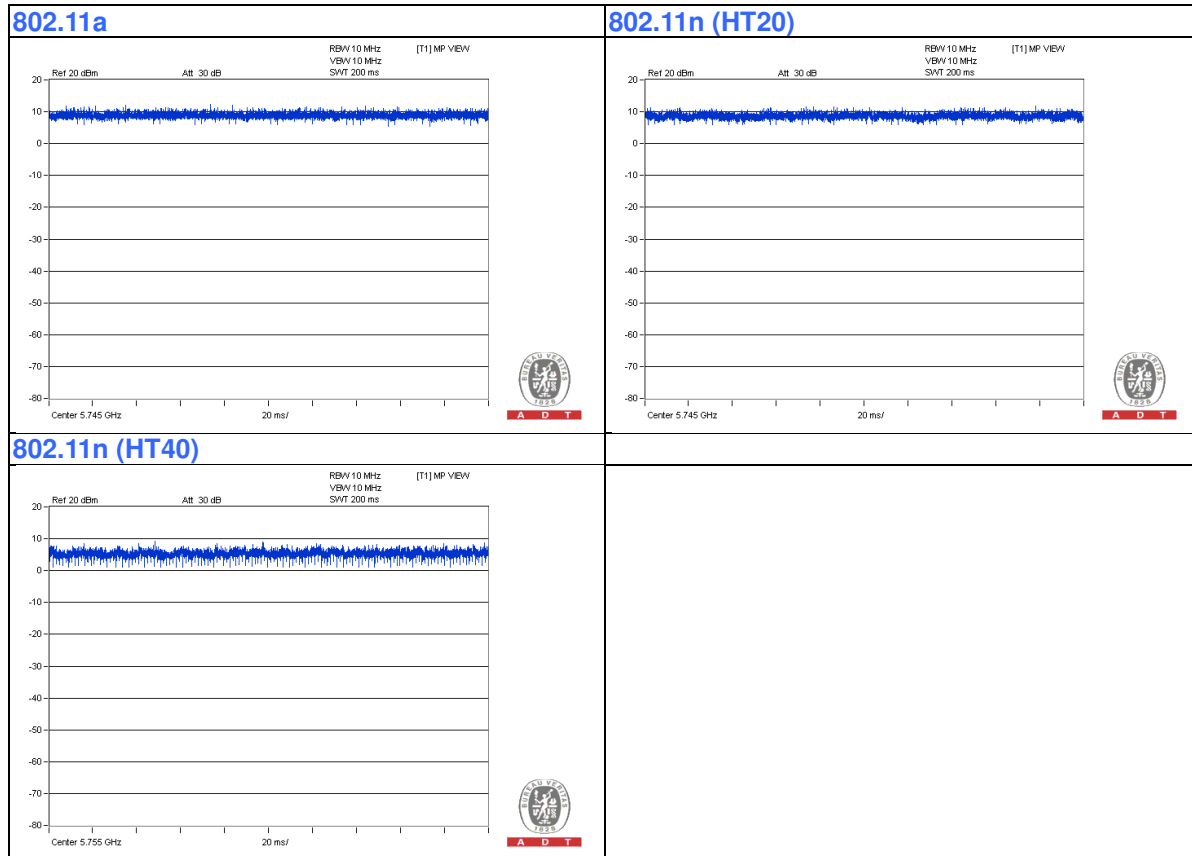

3.4 Description of Support Units

The EUT has been tested as an independent unit together with other necessary accessories or support units. The following support units or accessories were used to form a representative test configuration during the tests.

ID	Product	Brand	Model No.	Serial No.	FCC ID	Remarks
A.	Notebook Computer	DELL	E6420	B92T3R1	FCC DoC	Provided by Lab

Note:

1. All power cords of the above support units are non-shielded (1.8m).

ID	Descriptions	Qty.	Length (m)	Shielding (Yes/No)	Cores (Qty.)	Remarks
1.	RJ45 cable	1	10	No	0	Provided by Lab
2.	DC cable	1	1.9	No	0	Supplied by Client
3.	AC cable	1	1.8	No	0	Supplied by Client

3.4.1 Configuration of System under Test

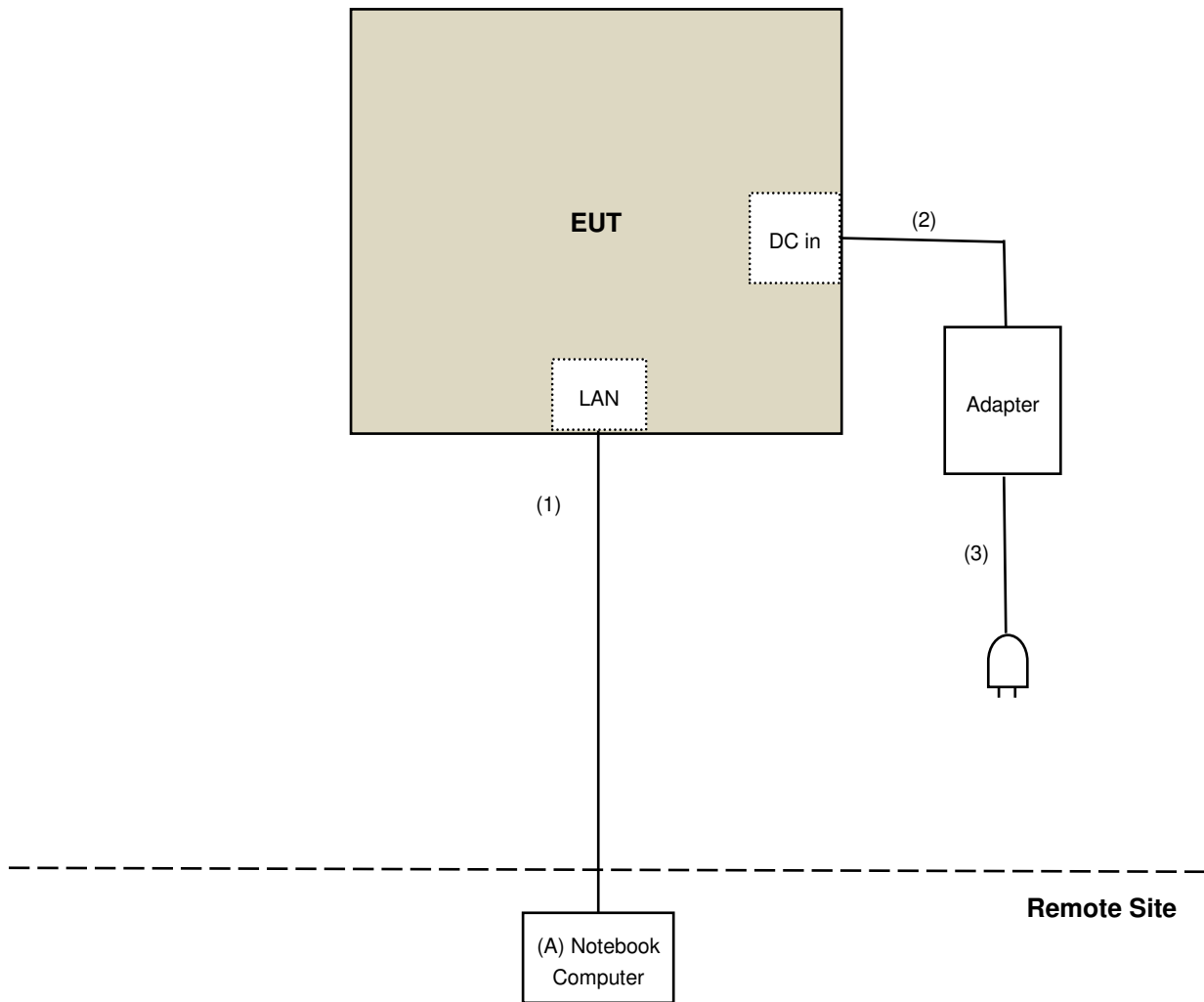

3.5 General Description of Applied Standard

The EUT is a RF Product. According to the specifications of the manufacturer, it must comply with the requirements of the following standards:

FCC Part 15, Subpart E (15.407)

KDB 789033 D02 General UNII Test Procedure New Rules v01r02

KDB 662911 D01 Multiple Transmitter Output v02r01

ANSI C63.10-2013

All test items have been performed and recorded as per the above standards.

4 Test Types and Results

4.1 Radiated Emission and Bandedge Measurement

4.1.1 Limits of Radiated Emission and Bandedge Measurement

Radiated emissions which fall in the restricted bands must comply with the radiated emission limits specified as below table.

Frequencies (MHz)	Field Strength (microvolts/meter)	Measurement Distance (meters)
0.009 ~ 0.490	2400/F(kHz)	300
0.490 ~ 1.705	24000/F(kHz)	30
1.705 ~ 30.0	30	30
30 ~ 88	100	3
88 ~ 216	150	3
216 ~ 960	200	3
Above 960	500	3

NOTE:

1. The lower limit shall apply at the transition frequencies.
2. Emission level (dBuV/m) = 20 log Emission level (uV/m).
3. For frequencies above 1000MHz, the field strength limits are based on average detector, however, the peak field strength of any emission shall not exceed the maximum permitted average limits, specified above by more than 20dB under any condition of modulation.

Limits OF UNWANTED EMISSION OUT OF THE RESTRICTED Bands

Applicable To	Limit	
789033 D02 General UNII Test Procedure New Rules v01r02	FIELD STRENGTH at 3m	
	PK:74 (dBuV/m)	AV:54 (dBuV/m)
Applicable To	EIRP Limit	Equivalent Field Strength at 3m
15.407(b)(1)	PK:-27 (dBm/MHz)	PK:68.2(dBuV/m)
15.407(b)(2)		
15.407(b)(3)		
15.407(b)(4)(i)	PK:-27 (dBm/MHz) ^{*1} PK:10 (dBm/MHz) ^{*2} PK:15.6 (dBm/MHz) ^{*3} PK:27 (dBm/MHz) ^{*4}	PK: 68.2(dBuV/m) ^{*1} PK:105.2 (dBuV/m) ^{*2} PK: 110.8(dBuV/m) ^{*3} PK:122.2 (dBuV/m) ^{*4}
15.407(b)(4)(ii)	FIELD STRENGTH at 3m / § 15.247(d),	
	PK:74 (dBuV/m)	AV:54 (dBuV/m)
^{*1} beyond 75 MHz or more above of the band edge. ^{*2} below the band edge increasing linearly to 10 dBm/MHz at 25 MHz above. ^{*3} below the band edge increasing linearly to a level of 15.6 dBm/MHz at 5 MHz above. ^{*4} from 5 MHz above or below the band edge increasing linearly to a level of 27 dBm/MHz at the band edge.		

NOTE:

The following formula is used to convert the equipment isotropic radiated power (eirp) to field strength:

$$E = \frac{1000000\sqrt{30P}}{3} \mu\text{V/m, where } P \text{ is the eirp (Watts).}$$



4.1.2 Test Instruments

DESCRIPTION & MANUFACTURER	MODEL NO.	SERIAL NO.	CALIBRATED DATE	CALIBRATED UNTIL
Test Receiver Agilent	N9038A	MY54450088	July 24, 2015	July 23, 2016
Pre-Amplifier ^(*) EMCI	EMC001340	980142	Jan. 20, 2016	Jan. 19, 2018
Loop Antenna ^(*) Electro-Metrics	EM-6879	264	Dec. 16, 2014	Dec. 15, 2016
RF Cable	NA	LOOPCAB-001 LOOPCAB-002	Jan. 18, 2016	Jan. 17, 2017
Pre-Amplifier Mini-Circuits	ZFL-1000VH2B	AMP-ZFL-01	Nov. 11, 2015	Nov. 10, 2016
Trilog Broadband Antenna SCHWARZBECK	VULB 9168	9168-406	Jan. 04, 2016	Jan. 03, 2017
RF Cable	8D	966-4-1 966-4-2 966-4-3	Apr. 02, 2016	Apr. 01, 2017
Horn Antenna SCHWARZBECK	BBHA 9120D	9120D-783	Jan. 19, 2016	Jan. 18, 2017
Pre-Amplifier Agilent	8449B	3008A01922	Sep. 19, 2015	Sep. 18, 2016
RF Cable	EMC104-SM-SM-2000 EMC104-SM-SM-5000 EMC104-SM-SM-5000	150318 150323 150324	Mar. 30, 2016	Mar. 29, 2017
Pre-Amplifier EMCI	EMC184045	980143	Jan. 15, 2016	Jan. 14, 2017
Horn Antenna SCHWARZBECK	BBHA 9170	BBHA9170608	Jan. 08, 2016	Jan. 07, 2017
RF Cable	SUCOFLEX 102	36432/2 36441/2	Jan. 16, 2016	Jan. 15, 2017
Software	ADT_Radiated_V8.7.07	NA	NA	NA
Antenna Tower & Turn Table CT	NA	NA	NA	NA
Boresight Antenna Fixture	NA	NA	NA	NA
Spectrum Analyzer R&S	FSP40	100060	May 11, 2016	May 10, 2017
Power meter Anritsu	ML2495A	1014008	May 5, 2016	May 4, 2017
Power sensor Anritsu	MA2411B	0917122	May 5, 2016	May 4, 2017
Temperature & Humidity Chamber Giant Force	GTH-150-40-SP-AR	MAA0812-008	Jan. 15, 2016	Jan. 14, 2017

Note:

1. The calibration interval of the above test instruments is 12 months and the calibrations are traceable to NML/ROC and NIST/USA.
2. *The calibration interval of the above test instruments is 24 months and the calibrations are traceable to NML/ROC and NIST/USA.
- 3 Loop antenna was used for all emissions below 30 MHz.
4. The test was performed in 966 Chamber No. 4.
5. The FCC Site Registration No. is 292998
6. The CANADA Site Registration No. is 20331-2
7. Tested Date: May 04, 2016

4.1.3 Test Procedure

- a. The EUT was placed on the top of a rotating table 0.8 meters (for below 1GHz) / 1.5 meters (for above 1GHz) above the ground at 3 meter chamber room for test. The table was rotated 360 degrees to determine the position of the highest radiation.
- b. The EUT was set 3 meters away from the interference-receiving antenna, which was mounted on the top of a variable-height antenna tower.
- c. The height of antenna is varied from one meter to four meters above the ground to determine the maximum value of the field strength. Both horizontal and vertical polarizations of the antenna are set to make the measurement.
- d. For each suspected emission, the EUT was arranged to its worst case and then the antenna was tuned to heights from 1 meter to 4 meters and the rotatable table was turned from 0 degrees to 360 degrees to find the maximum reading.
- e. The test-receiver system was set to quasi-peak detect function and specified bandwidth with maximum hold mode when the test frequency is below 1 GHz.
- f. The test-receiver system was set to peak and average detect function and specified bandwidth with maximum hold mode when the test frequency is above 1 GHz. If the peak reading value also meets average limit, measurement with the average detector is unnecessary.

Note:

1. The resolution bandwidth and video bandwidth of test receiver/spectrum analyzer is 120kHz for Quasi-peak detection (QP) at frequency below 1GHz.
2. The resolution bandwidth of test receiver/spectrum analyzer is 1 MHz and the video bandwidth is 3 MHz for Peak detection (PK) at frequency above 1GHz.
3. The resolution bandwidth of test receiver/spectrum analyzer is 1MHz and the video bandwidth is 3MHz for RMS Average (Duty cycle < 98%) for Average detection (AV) at frequency above 1GHz, then the measurement results was added to a correction factor ($10 \log(1/\text{duty cycle})$).
4. The resolution bandwidth of test receiver/spectrum analyzer is 1MHz and the video bandwidth is 10Hz (Duty cycle $\geq 98\%$) for Average detection (AV) at frequency above 1GHz.
5. All modes of operation were investigated and the worst-case emissions are reported.

4.1.4 Deviation from Test Standard

No deviation.

4.1.5 Test Setup

<Frequency Range below 1GHz>

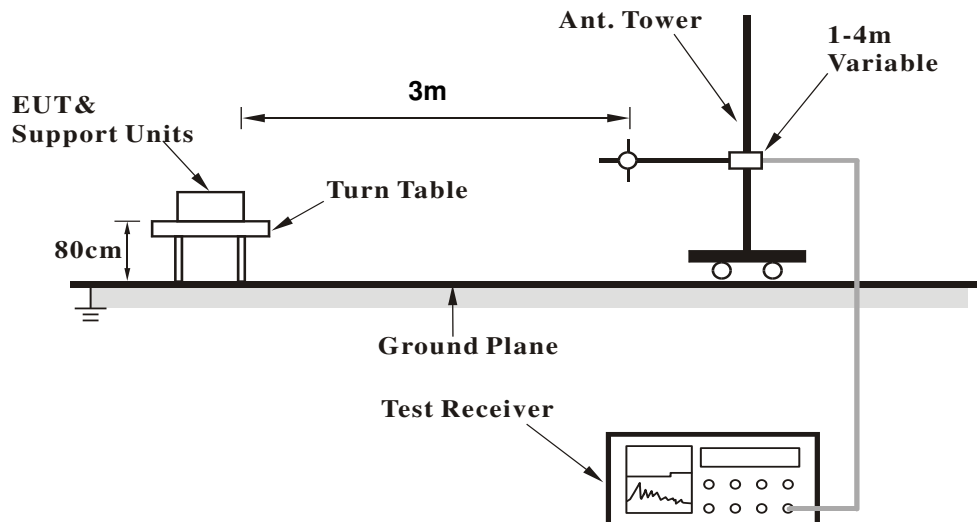

<Frequency Range above 1GHz>

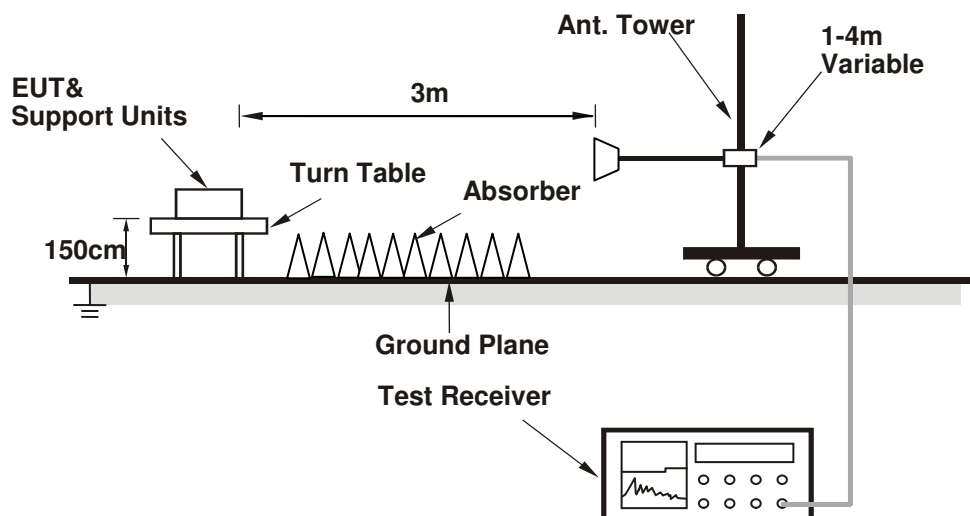

For the actual test configuration, please refer to the attached file (Test Setup Photo).

4.1.6 EUT Operating Condition

- a. Connect the EUT with Notebook Computer which is placed on a testing table.
- b. The communication partner run test program "art.exe (v0 9 b27 ar928xALL)" to enable EUT under transmission/receiving condition continuously at specific channel frequency.

4.1.7 Test Results

Above 1GHz Data:

Ant Set 1

802.11a

CHANNEL	TX Channel 149	DETECTOR FUNCTION	Peak (PK)
FREQUENCY RANGE	1GHz ~ 40GHz		Average (AV)

ANTENNA POLARITY & TEST DISTANCE: HORIZONTAL AT 3 M

NO.	FREQ. (MHz)	EMISSION LEVEL (dBuV/m)	LIMIT (dBuV/m)	MARGIN (dB)	ANTENNA HEIGHT (m)	TABLE ANGLE (Degree)	RAW VALUE (dBuV)	CORRECTION FACTOR (dB/m)
1	#5644.05	58.9 PK	68.2	-9.3	1.50 H	47	54.86	4.04
2	*5745.00	105.4 PK			1.50 H	47	103.66	1.74
3	*5745.00	95.4 AV			1.50 H	47	93.66	1.74
4	#5921.45	57.6 PK	70.8	-13.2	1.50 H	47	53.25	4.34
5	11490.00	42.2 PK	74.0	-31.8	1.64 H	231	29.79	12.41
6	11490.00	31.0 AV	54.0	-23.0	1.64 H	231	18.59	12.41
7	#17235.00	41.6 PK	74.0	-32.4	1.55 H	123	24.88	16.72
8	#17235.00	31.1 AV	54.0	-22.9	1.55 H	123	14.38	16.72

ANTENNA POLARITY & TEST DISTANCE: VERTICAL AT 3 M

NO.	FREQ. (MHz)	EMISSION LEVEL (dBuV/m)	LIMIT (dBuV/m)	MARGIN (dB)	ANTENNA HEIGHT (m)	TABLE ANGLE (Degree)	RAW VALUE (dBuV)	CORRECTION FACTOR (dB/m)
1	#5651.65	58.5 PK	69.4	-11.0	2.51 V	224	54.38	4.07
2	*5745.00	104.7 PK			2.51 V	224	102.96	1.74
3	*5745.00	95.3 AV			2.51 V	224	93.56	1.74
4	#5920.02	57.8 PK	71.9	-14.0	2.51 V	224	53.50	4.33
5	11490.00	42.5 PK	74.0	-31.5	1.59 V	118	30.09	12.41
6	11490.00	31.5 AV	54.0	-22.5	1.59 V	118	19.09	12.41
7	#17235.00	41.1 PK	74.0	-32.9	1.46 V	231	24.38	16.72
8	#17235.00	29.3 AV	54.0	-24.7	1.46 V	231	12.58	16.72

REMARKS:

1. Emission Level(dBuV/m) = Raw Value(dBuV) + Correction Factor(dB/m)
2. Correction Factor(dB/m) = Antenna Factor(dB/m) + Cable Factor(dB) – Pre-Amplifier Factor(dB)
3. The other emission levels were very low against the limit.
4. Margin value = Emission Level – Limit value
5. " * ": Fundamental frequency.
6. " # ": The radiated frequency is out of the restricted band.

CHANNEL	TX Channel 157	DETECTOR FUNCTION	Peak (PK)
FREQUENCY RANGE	1GHz ~ 40GHz		Average (AV)

ANTENNA POLARITY & TEST DISTANCE: HORIZONTAL AT 3 M

NO.	FREQ. (MHz)	EMISSION LEVEL (dBuV/m)	LIMIT (dBuV/m)	MARGIN (dB)	ANTENNA HEIGHT (m)	TABLE ANGLE (Degree)	RAW VALUE (dBuV)	CORRECTION FACTOR (dB/m)
1	#5583.73	60.0 PK	68.2	-8.2	1.47 H	39	56.13	3.91
2	*5785.00	104.9 PK			1.47 H	39	103.10	1.80
3	*5785.00	95.3 AV			1.47 H	39	93.50	1.80
4	#5965.62	58.1 PK	68.2	-10.1	1.47 H	39	53.72	4.40
5	11570.00	41.9 PK	74.0	-32.1	1.66 H	239	29.72	12.18
6	11570.00	31.0 AV	54.0	-23.0	1.66 H	239	18.82	12.18
7	#17355.00	42.1 PK	74.0	-31.9	1.49 H	138	24.83	17.27
8	#17355.00	31.4 AV	54.0	-22.6	1.49 H	138	14.13	17.27

ANTENNA POLARITY & TEST DISTANCE: VERTICAL AT 3 M

NO.	FREQ. (MHz)	EMISSION LEVEL (dBuV/m)	LIMIT (dBuV/m)	MARGIN (dB)	ANTENNA HEIGHT (m)	TABLE ANGLE (Degree)	RAW VALUE (dBuV)	CORRECTION FACTOR (dB/m)
1	#5643.10	59.1 PK	68.2	-9.1	2.32 V	223	55.02	4.04
2	*5785.00	104.5 PK			2.32 V	223	102.70	1.80
3	*5785.00	95.1 AV			2.32 V	223	93.30	1.80
4	#5919.07	57.3 PK	72.6	-15.3	2.32 V	223	52.96	4.33
5	11570.00	42.5 PK	74.0	-31.5	1.56 V	122	30.32	12.18
6	11570.00	31.7 AV	54.0	-22.3	1.56 V	122	19.52	12.18
7	#17355.00	41.1 PK	74.0	-32.9	1.41 V	218	23.83	17.27
8	#17355.00	29.3 AV	54.0	-24.7	1.41 V	218	12.03	17.27

REMARKS:

1. Emission Level(dBuV/m) = Raw Value(dBuV) + Correction Factor(dB/m)
2. Correction Factor(dB/m) = Antenna Factor(dB/m) + Cable Factor(dB) – Pre-Amplifier Factor(dB)
3. The other emission levels were very low against the limit.
4. Margin value = Emission Level – Limit value
5. " * ": Fundamental frequency.
6. " # ": The radiated frequency is out of the restricted band.

CHANNEL	TX Channel 165	DETECTOR FUNCTION	Peak (PK)
FREQUENCY RANGE	1GHz ~ 40GHz		Average (AV)

ANTENNA POLARITY & TEST DISTANCE: HORIZONTAL AT 3 M

NO.	FREQ. (MHz)	EMISSION LEVEL (dBuV/m)	LIMIT (dBuV/m)	MARGIN (dB)	ANTENNA HEIGHT (m)	TABLE ANGLE (Degree)	RAW VALUE (dBuV)	CORRECTION FACTOR (dB/m)
1	#5640.73	58.9 PK	68.2	-9.3	1.49 H	25	54.83	4.04
2	*5825.00	105.9 PK			1.49 H	25	104.07	1.83
3	*5825.00	95.8 AV			1.49 H	25	93.97	1.83
4	#5939.50	57.1 PK	68.2	-11.1	1.49 H	25	52.71	4.37
5	11650.00	42.0 PK	74.0	-32.0	1.65 H	225	29.97	12.03
6	11650.00	30.9 AV	54.0	-23.1	1.65 H	225	18.87	12.03
7	#17475.00	41.9 PK	74.0	-32.1	1.51 H	133	24.14	17.76
8	#17475.00	31.1 AV	54.0	-22.9	1.51 H	133	13.34	17.76

ANTENNA POLARITY & TEST DISTANCE: VERTICAL AT 3 M

NO.	FREQ. (MHz)	EMISSION LEVEL (dBuV/m)	LIMIT (dBuV/m)	MARGIN (dB)	ANTENNA HEIGHT (m)	TABLE ANGLE (Degree)	RAW VALUE (dBuV)	CORRECTION FACTOR (dB/m)
1	#5622.20	58.7 PK	68.2	-9.5	1.85 V	229	54.71	4.00
2	#5671.60	58.0 PK	84.2	-26.3	1.85 V	229	53.85	4.11
3	*5825.00	106.0 PK			1.85 V	229	104.17	1.83
4	*5825.00	96.1 AV			1.85 V	229	94.27	1.83
5	#5914.32	57.1 PK	76.1	-19.0	1.85 V	229	52.78	4.33
6	#5968.48	57.3 PK	68.2	-10.9	1.85 V	229	52.93	4.40
7	11650.00	42.5 PK	74.0	-31.5	1.61 V	118	30.47	12.03
8	11650.00	31.6 AV	54.0	-22.4	1.61 V	118	19.57	12.03
9	#17475.00	40.7 PK	74.0	-33.3	1.41 V	206	22.94	17.76
10	#17475.00	28.9 AV	54.0	-25.1	1.41 V	206	11.14	17.76

REMARKS:

1. Emission Level(dBuV/m) = Raw Value(dBuV) + Correction Factor(dB/m)
2. Correction Factor(dB/m) = Antenna Factor(dB/m) + Cable Factor(dB) – Pre-Amplifier Factor(dB)
3. The other emission levels were very low against the limit.
4. Margin value = Emission Level – Limit value
5. " * ": Fundamental frequency.
6. " # ": The radiated frequency is out of the restricted band.

802.11n (HT20)

CHANNEL	TX Channel 149	DETECTOR FUNCTION	Peak (PK)
FREQUENCY RANGE	1GHz ~ 40GHz		Average (AV)

ANTENNA POLARITY & TEST DISTANCE: HORIZONTAL AT 3 M								
NO.	FREQ. (MHz)	EMISSION LEVEL (dBuV/m)	LIMIT (dBuV/m)	MARGIN (dB)	ANTENNA HEIGHT (m)	TABLE ANGLE (Degree)	RAW VALUE (dBuV)	CORRECTION FACTOR (dB/m)
1	#5608.43	58.6 PK	68.2	-9.6	1.45 H	27	54.66	3.95
2	*5745.00	106.5 PK			1.45 H	27	104.76	1.74
3	*5745.00	95.6 AV			1.45 H	27	93.86	1.74
4	#5944.73	56.9 PK	68.2	-11.3	1.45 H	27	52.55	4.37
5	11490.00	42.1 PK	74.0	-31.9	1.64 H	226	29.69	12.41
6	11490.00	31.0 AV	54.0	-23.0	1.64 H	226	18.59	12.41
7	#17235.00	41.9 PK	74.0	-32.1	1.50 H	142	25.18	16.72
8	#17235.00	30.0 AV	54.0	-24.0	1.50 H	142	13.28	16.72

ANTENNA POLARITY & TEST DISTANCE: VERTICAL AT 3 M								
NO.	FREQ. (MHz)	EMISSION LEVEL (dBuV/m)	LIMIT (dBuV/m)	MARGIN (dB)	ANTENNA HEIGHT (m)	TABLE ANGLE (Degree)	RAW VALUE (dBuV)	CORRECTION FACTOR (dB/m)
1	#5636.45	57.8 PK	68.2	-10.4	1.78 V	227	53.75	4.03
2	*5745.00	105.6 PK			1.78 V	227	103.86	1.74
3	*5745.00	95.5 AV			1.78 V	227	93.76	1.74
4	#5930.00	58.0 PK	68.2	-10.2	1.78 V	227	53.64	4.35
5	11490.00	43.0 PK	74.0	-31.0	1.64 V	112	30.59	12.41
6	11490.00	32.0 AV	54.0	-22.0	1.64 V	112	19.59	12.41
7	#17235.00	40.9 PK	74.0	-33.1	1.37 V	194	24.18	16.72
8	#17235.00	29.3 AV	54.0	-24.7	1.37 V	194	12.58	16.72

REMARKS:

- Emission Level(dBuV/m) = Raw Value(dBuV) + Correction Factor(dB/m)
- Correction Factor(dB/m) = Antenna Factor(dB/m) + Cable Factor(dB) – Pre-Amplifier Factor(dB)
- The other emission levels were very low against the limit.
- Margin value = Emission Level – Limit value
- " * ": Fundamental frequency.
- " # ": The radiated frequency is out of the restricted band.

CHANNEL	TX Channel 157	DETECTOR FUNCTION	Peak (PK)
FREQUENCY RANGE	1GHz ~ 40GHz		Average (AV)

ANTENNA POLARITY & TEST DISTANCE: HORIZONTAL AT 3 M

NO.	FREQ. (MHz)	EMISSION LEVEL (dBuV/m)	LIMIT (dBuV/m)	MARGIN (dB)	ANTENNA HEIGHT (m)	TABLE ANGLE (Degree)	RAW VALUE (dBuV)	CORRECTION FACTOR (dB/m)
1	#5570.43	59.5 PK	68.2	-8.7	1.49 H	25	55.57	3.89
2	#5632.65	58.1 PK	68.2	-10.1	1.49 H	25	54.10	4.01
3	*5785.00	105.4 PK			1.49 H	25	103.60	1.80
4	*5785.00	95.9 AV			1.49 H	25	94.10	1.80
5	#5914.80	57.3 PK	75.7	-18.4	1.49 H	25	52.99	4.33
6	#5974.65	57.1 PK	68.2	-11.1	1.49 H	25	52.66	4.40
7	11570.00	42.7 PK	74.0	-31.3	1.67 H	228	30.52	12.18
8	11570.00	31.4 AV	54.0	-22.6	1.67 H	228	19.22	12.18
9	#17355.00	42.5 PK	74.0	-31.5	1.51 H	130	25.23	17.27
10	#17355.00	30.4 AV	54.0	-23.6	1.51 H	130	13.13	17.27

ANTENNA POLARITY & TEST DISTANCE: VERTICAL AT 3 M

NO.	FREQ. (MHz)	EMISSION LEVEL (dBuV/m)	LIMIT (dBuV/m)	MARGIN (dB)	ANTENNA HEIGHT (m)	TABLE ANGLE (Degree)	RAW VALUE (dBuV)	CORRECTION FACTOR (dB/m)
1	#5599.87	59.8 PK	68.2	-8.4	2.40 V	235	55.84	3.93
2	*5785.00	105.6 PK			2.40 V	235	103.80	1.80
3	*5785.00	96.1 AV			2.40 V	235	94.30	1.80
4	#5976.07	57.7 PK	68.2	-10.5	2.40 V	235	53.25	4.41
5	11570.00	42.9 PK	74.0	-31.1	1.67 V	119	30.72	12.18
6	11570.00	31.9 AV	54.0	-22.1	1.67 V	119	19.72	12.18
7	#17355.00	40.4 PK	74.0	-33.6	1.42 V	180	23.13	17.27
8	#17355.00	29.1 AV	54.0	-24.9	1.42 V	180	11.83	17.27

REMARKS:

1. Emission Level(dBuV/m) = Raw Value(dBuV) + Correction Factor(dB/m)
2. Correction Factor(dB/m) = Antenna Factor(dB/m) + Cable Factor(dB) – Pre-Amplifier Factor(dB)
3. The other emission levels were very low against the limit.
4. Margin value = Emission Level – Limit value
5. " * ": Fundamental frequency.
6. " # ": The radiated frequency is out of the restricted band.

CHANNEL	TX Channel 165	DETECTOR FUNCTION	Peak (PK)
FREQUENCY RANGE	1GHz ~ 40GHz		Average (AV)

ANTENNA POLARITY & TEST DISTANCE: HORIZONTAL AT 3 M

NO.	FREQ. (MHz)	EMISSION LEVEL (dBuV/m)	LIMIT (dBuV/m)	MARGIN (dB)	ANTENNA HEIGHT (m)	TABLE ANGLE (Degree)	RAW VALUE (dBuV)	CORRECTION FACTOR (dB/m)
1	#5640.73	58.4 PK	68.2	-9.8	1.43 H	19	54.35	4.04
2	*5825.00	105.1 PK			1.43 H	19	103.27	1.83
3	*5825.00	95.3 AV			1.43 H	19	93.47	1.83
4	#5967.52	58.4 PK	68.2	-9.8	1.43 H	19	54.00	4.40
5	11650.00	42.9 PK	74.0	-31.1	1.69 H	239	30.87	12.03
6	11650.00	31.7 AV	54.0	-22.3	1.69 H	239	19.67	12.03
7	#17475.00	42.8 PK	74.0	-31.2	1.50 H	127	25.04	17.76
8	#17475.00	30.7 AV	54.0	-23.3	1.50 H	127	12.94	17.76

ANTENNA POLARITY & TEST DISTANCE: VERTICAL AT 3 M

NO.	FREQ. (MHz)	EMISSION LEVEL (dBuV/m)	LIMIT (dBuV/m)	MARGIN (dB)	ANTENNA HEIGHT (m)	TABLE ANGLE (Degree)	RAW VALUE (dBuV)	CORRECTION FACTOR (dB/m)
1	#5635.02	58.7 PK	68.2	-9.5	2.47 V	235	54.71	4.02
2	*5825.00	105.2 PK			2.47 V	235	103.37	1.83
3	*5825.00	95.4 AV			2.47 V	235	93.57	1.83
4	#5950.90	58.2 PK	68.2	-10.1	2.47 V	235	53.77	4.38
5	11650.00	42.4 PK	74.0	-31.6	1.67 V	132	30.37	12.03
6	11650.00	31.4 AV	54.0	-22.6	1.67 V	132	19.37	12.03
7	#17475.00	40.2 PK	74.0	-33.8	1.46 V	178	22.44	17.76
8	#17475.00	29.1 AV	54.0	-24.9	1.46 V	178	11.34	17.76

REMARKS:

1. Emission Level(dBuV/m) = Raw Value(dBuV) + Correction Factor(dB/m)
2. Correction Factor(dB/m) = Antenna Factor(dB/m) + Cable Factor(dB) – Pre-Amplifier Factor(dB)
3. The other emission levels were very low against the limit.
4. Margin value = Emission Level – Limit value
5. " * ": Fundamental frequency.
6. " # ": The radiated frequency is out of the restricted band.

802.11n (HT40)

CHANNEL	TX Channel 151	DETECTOR FUNCTION	Peak (PK)
FREQUENCY RANGE	1GHz ~ 40GHz		Average (AV)

ANTENNA POLARITY & TEST DISTANCE: HORIZONTAL AT 3 M								
NO.	FREQ. (MHz)	EMISSION LEVEL (dBuV/m)	LIMIT (dBuV/m)	MARGIN (dB)	ANTENNA HEIGHT (m)	TABLE ANGLE (Degree)	RAW VALUE (dBuV)	CORRECTION FACTOR (dB/m)
1	#5609.85	59.7 PK	68.2	-8.5	2.46 H	174	55.72	3.96
2	*5755.00	103.0 PK			2.46 H	174	101.24	1.76
3	*5755.00	91.2 AV			2.46 H	174	89.44	1.76
4	#5950.90	58.3 PK	68.2	-10.0	2.46 H	174	53.87	4.38
5	11510.00	42.8 PK	74.0	-31.2	1.65 H	234	30.42	12.38
6	11510.00	31.6 AV	54.0	-22.4	1.65 H	234	19.22	12.38
7	#17265.00	42.6 PK	74.0	-31.4	1.49 H	127	25.80	16.80
8	#17265.00	30.3 AV	54.0	-23.7	1.49 H	127	13.50	16.80

ANTENNA POLARITY & TEST DISTANCE: VERTICAL AT 3 M								
NO.	FREQ. (MHz)	EMISSION LEVEL (dBuV/m)	LIMIT (dBuV/m)	MARGIN (dB)	ANTENNA HEIGHT (m)	TABLE ANGLE (Degree)	RAW VALUE (dBuV)	CORRECTION FACTOR (dB/m)
1	#5576.12	60.7 PK	68.2	-7.5	1.90 V	227	56.83	3.89
2	*5755.00	102.4 PK			1.90 V	227	100.64	1.76
3	*5755.00	91.1 AV			1.90 V	227	89.34	1.76
4	#5938.55	56.7 PK	68.2	-11.5	1.90 V	227	52.32	4.37
5	11510.00	42.1 PK	74.0	-31.9	1.70 V	127	29.72	12.38
6	11510.00	31.2 AV	54.0	-22.8	1.70 V	127	18.82	12.38
7	#17265.00	40.8 PK	74.0	-33.2	1.44 V	188	24.00	16.80
8	#17265.00	29.6 AV	54.0	-24.4	1.44 V	188	12.80	16.80

REMARKS:

1. Emission Level(dBuV/m) = Raw Value(dBuV) + Correction Factor(dB/m)
2. Correction Factor(dB/m) = Antenna Factor(dB/m) + Cable Factor(dB) – Pre-Amplifier Factor(dB)
3. The other emission levels were very low against the limit.
4. Margin value = Emission Level – Limit value
5. " * ": Fundamental frequency.
6. " # ": The radiated frequency is out of the restricted band.



CHANNEL	TX Channel 159	DETECTOR FUNCTION	Peak (PK)
FREQUENCY RANGE	1GHz ~ 40GHz		Average (AV)

ANTENNA POLARITY & TEST DISTANCE: HORIZONTAL AT 3 M

NO.	FREQ. (MHz)	EMISSION LEVEL (dBuV/m)	LIMIT (dBuV/m)	MARGIN (dB)	ANTENNA HEIGHT (m)	TABLE ANGLE (Degree)	RAW VALUE (dBuV)	CORRECTION FACTOR (dB/m)
1	#5587.52	58.9 PK	68.2	-9.3	2.47 H	180	55.03	3.91
2	*5795.00	102.8 PK			2.47 H	180	100.98	1.82
3	*5795.00	91.1 AV			2.47 H	180	89.28	1.82
4	#5941.87	58.1 PK	68.2	-10.1	2.47 H	180	53.70	4.37
5	11590.00	43.3 PK	74.0	-30.7	1.66 H	225	31.19	12.11
6	11590.00	32.1 AV	54.0	-21.9	1.66 H	225	19.99	12.11
7	#17385.00	42.7 PK	74.0	-31.3	1.55 H	137	25.24	17.46
8	#17385.00	30.2 AV	54.0	-23.8	1.55 H	137	12.74	17.46

ANTENNA POLARITY & TEST DISTANCE: VERTICAL AT 3 M

NO.	FREQ. (MHz)	EMISSION LEVEL (dBuV/m)	LIMIT (dBuV/m)	MARGIN (dB)	ANTENNA HEIGHT (m)	TABLE ANGLE (Degree)	RAW VALUE (dBuV)	CORRECTION FACTOR (dB/m)
1	#5583.25	59.5 PK	68.2	-8.7	2.41 V	110	55.57	3.91
2	*5795.00	102.4 PK			2.41 V	110	100.58	1.82
3	*5795.00	91.2 AV			2.41 V	110	89.38	1.82
4	#5951.37	58.4 PK	68.2	-9.8	2.41 V	110	53.98	4.38
5	11590.00	42.4 PK	74.0	-31.6	1.75 V	139	30.29	12.11
6	11590.00	31.3 AV	54.0	-22.7	1.75 V	139	19.19	12.11
7	#17385.00	41.0 PK	74.0	-33.0	1.40 V	184	23.54	17.46
8	#17385.00	30.1 AV	54.0	-23.9	1.40 V	184	12.64	17.46

REMARKS:

1. Emission Level(dBuV/m) = Raw Value(dBuV) + Correction Factor(dB/m)
2. Correction Factor(dB/m) = Antenna Factor(dB/m) + Cable Factor(dB) – Pre-Amplifier Factor(dB)
3. The other emission levels were very low against the limit.
4. Margin value = Emission Level – Limit value
5. " * ": Fundamental frequency.
6. " # ": The radiated frequency is out of the restricted band.

Ant Set 3
802.11a

CHANNEL	TX Channel 149	DETECTOR FUNCTION	Peak (PK)
FREQUENCY RANGE	1GHz ~ 40GHz		Average (AV)

ANTENNA POLARITY & TEST DISTANCE: HORIZONTAL AT 3 M

NO.	FREQ. (MHz)	EMISSION LEVEL (dBuV/m)	LIMIT (dBuV/m)	MARGIN (dB)	ANTENNA HEIGHT (m)	TABLE ANGLE (Degree)	RAW VALUE (dBuV)	CORRECTION FACTOR (dB/m)
1	#5658.30	57.5 PK	74.4	-16.9	1.06 H	316	53.40	4.08
2	*5745.00	94.1 PK			1.06 H	316	92.36	1.74
3	*5745.00	84.7 AV			1.06 H	316	82.96	1.74
4	#5944.25	56.5 PK	68.2	-11.7	1.06 H	316	52.16	4.37
5	11490.00	41.5 PK	74.0	-32.5	1.63 H	244	29.09	12.41
6	11490.00	30.5 AV	54.0	-23.5	1.63 H	244	18.09	12.41
7	#17235.00	41.6 PK	74.0	-32.4	1.50 H	135	24.88	16.72
8	#17235.00	30.8 AV	54.0	-23.2	1.50 H	135	14.08	16.72

ANTENNA POLARITY & TEST DISTANCE: VERTICAL AT 3 M

NO.	FREQ. (MHz)	EMISSION LEVEL (dBuV/m)	LIMIT (dBuV/m)	MARGIN (dB)	ANTENNA HEIGHT (m)	TABLE ANGLE (Degree)	RAW VALUE (dBuV)	CORRECTION FACTOR (dB/m)
1	#5669.23	59.0 PK	82.5	-23.5	3.15 V	60	54.84	4.11
2	*5745.00	103.7 PK			3.15 V	60	101.96	1.74
3	*5745.00	93.6 AV			3.15 V	60	91.86	1.74
4	#5928.10	57.2 PK	68.2	-11.0	3.15 V	60	52.89	4.35
5	11490.00	42.3 PK	74.0	-31.7	1.57 V	109	29.89	12.41
6	11490.00	31.5 AV	54.0	-22.5	1.57 V	109	19.09	12.41
7	#17235.00	41.6 PK	74.0	-32.4	1.40 V	244	24.88	16.72
8	#17235.00	29.7 AV	54.0	-24.3	1.40 V	244	12.98	16.72

REMARKS:

1. Emission Level(dBuV/m) = Raw Value(dBuV) + Correction Factor(dB/m)
2. Correction Factor(dB/m) = Antenna Factor(dB/m) + Cable Factor(dB) – Pre-Amplifier Factor(dB)
3. The other emission levels were very low against the limit.
4. Margin value = Emission Level – Limit value
5. " * ": Fundamental frequency.
6. " # ": The radiated frequency is out of the restricted band.

CHANNEL	TX Channel 157	DETECTOR FUNCTION	Peak (PK)
FREQUENCY RANGE	1GHz ~ 40GHz		Average (AV)

ANTENNA POLARITY & TEST DISTANCE: HORIZONTAL AT 3 M

NO.	FREQ. (MHz)	EMISSION LEVEL (dBuV/m)	LIMIT (dBuV/m)	MARGIN (dB)	ANTENNA HEIGHT (m)	TABLE ANGLE (Degree)	RAW VALUE (dBuV)	CORRECTION FACTOR (dB/m)
1	#5637.87	57.1 PK	68.2	-11.1	1.07 H	307	53.09	4.03
2	*5785.00	93.9 PK			1.07 H	307	92.10	1.80
3	*5785.00	84.3 AV			1.07 H	307	82.50	1.80
4	#5958.50	58.2 PK	68.2	-10.0	1.07 H	307	53.80	4.38
5	11570.00	41.7 PK	74.0	-32.3	1.64 H	254	29.52	12.18
6	11570.00	30.7 AV	54.0	-23.3	1.64 H	254	18.52	12.18
7	#17355.00	41.8 PK	74.0	-32.2	1.53 H	147	24.53	17.27
8	#17355.00	31.0 AV	54.0	-23.0	1.53 H	147	13.73	17.27

ANTENNA POLARITY & TEST DISTANCE: VERTICAL AT 3 M

NO.	FREQ. (MHz)	EMISSION LEVEL (dBuV/m)	LIMIT (dBuV/m)	MARGIN (dB)	ANTENNA HEIGHT (m)	TABLE ANGLE (Degree)	RAW VALUE (dBuV)	CORRECTION FACTOR (dB/m)
1	#5651.18	57.9 PK	69.1	-11.2	3.14 V	44	53.81	4.07
2	*5785.00	103.6 PK			3.14 V	44	101.80	1.80
3	*5785.00	93.2 AV			3.14 V	44	91.40	1.80
4	#5929.05	58.6 PK	68.2	-9.6	3.14 V	44	54.29	4.35
5	11570.00	42.7 PK	74.0	-31.3	1.57 V	118	30.52	12.18
6	11570.00	31.7 AV	54.0	-22.3	1.57 V	118	19.52	12.18
7	#17355.00	41.3 PK	74.0	-32.7	1.40 V	229	24.03	17.27
8	#17355.00	29.4 AV	54.0	-24.6	1.40 V	229	12.13	17.27

REMARKS:

1. Emission Level(dBuV/m) = Raw Value(dBuV) + Correction Factor(dB/m)
2. Correction Factor(dB/m) = Antenna Factor(dB/m) + Cable Factor(dB) – Pre-Amplifier Factor(dB)
3. The other emission levels were very low against the limit.
4. Margin value = Emission Level – Limit value
5. " * ": Fundamental frequency.
6. " # ": The radiated frequency is out of the restricted band.

CHANNEL	TX Channel 165	DETECTOR FUNCTION	Peak (PK)
FREQUENCY RANGE	1GHz ~ 40GHz		Average (AV)

ANTENNA POLARITY & TEST DISTANCE: HORIZONTAL AT 3 M

NO.	FREQ. (MHz)	EMISSION LEVEL (dBuV/m)	LIMIT (dBuV/m)	MARGIN (dB)	ANTENNA HEIGHT (m)	TABLE ANGLE (Degree)	RAW VALUE (dBuV)	CORRECTION FACTOR (dB/m)
1	#5616.98	57.9 PK	68.2	-10.3	1.04 H	304	53.88	3.98
2	*5825.00	94.1 PK			1.04 H	304	92.27	1.83
3	*5825.00	83.6 AV			1.04 H	304	81.77	1.83
4	#5972.75	56.7 PK	68.2	-11.5	1.04 H	304	52.34	4.40
5	11650.00	41.3 PK	74.0	-32.7	1.60 H	240	29.27	12.03
6	11650.00	30.1 AV	54.0	-23.9	1.60 H	240	18.07	12.03
7	#17475.00	41.8 PK	74.0	-32.2	1.47 H	145	24.04	17.76
8	#17475.00	30.8 AV	54.0	-23.2	1.47 H	145	13.04	17.76

ANTENNA POLARITY & TEST DISTANCE: VERTICAL AT 3 M

NO.	FREQ. (MHz)	EMISSION LEVEL (dBuV/m)	LIMIT (dBuV/m)	MARGIN (dB)	ANTENNA HEIGHT (m)	TABLE ANGLE (Degree)	RAW VALUE (dBuV)	CORRECTION FACTOR (dB/m)
1	#5621.73	57.8 PK	68.2	-10.4	3.79 V	24	53.85	3.99
2	#5663.05	57.6 PK	77.9	-20.3	3.79 V	24	53.47	4.09
3	*5825.00	103.9 PK			3.79 V	24	102.07	1.83
4	*5825.00	92.5 AV			3.79 V	24	90.67	1.83
5	#5977.50	57.5 PK	68.2	-10.8	3.79 V	24	53.04	4.41
6	11650.00	42.4 PK	74.0	-31.6	1.61 V	114	30.37	12.03
7	11650.00	31.5 AV	54.0	-22.5	1.61 V	114	19.47	12.03
8	#17475.00	41.2 PK	74.0	-32.8	1.44 V	218	23.44	17.76
9	#17475.00	29.4 AV	54.0	-24.6	1.44 V	218	11.64	17.76

REMARKS:

1. Emission Level(dBuV/m) = Raw Value(dBuV) + Correction Factor(dB/m)
2. Correction Factor(dB/m) = Antenna Factor(dB/m) + Cable Factor(dB) – Pre-Amplifier Factor(dB)
3. The other emission levels were very low against the limit.
4. Margin value = Emission Level – Limit value
5. " * ": Fundamental frequency.
6. " # ": The radiated frequency is out of the restricted band.



802.11n (HT20)

CHANNEL	TX Channel 149	DETECTOR FUNCTION	Peak (PK)
FREQUENCY RANGE	1GHz ~ 40GHz		Average (AV)

ANTENNA POLARITY & TEST DISTANCE: HORIZONTAL AT 3 M								
NO.	FREQ. (MHz)	EMISSION LEVEL (dBuV/m)	LIMIT (dBuV/m)	MARGIN (dB)	ANTENNA HEIGHT (m)	TABLE ANGLE (Degree)	RAW VALUE (dBuV)	CORRECTION FACTOR (dB/m)
1	#5551.90	57.7 PK	68.2	-10.5	1.10 H	293	53.85	3.87
2	*5745.00	93.2 PK			1.10 H	293	91.46	1.74
3	*5745.00	84.0 AV			1.10 H	293	82.26	1.74
4	#5936.18	57.5 PK	68.2	-10.7	1.10 H	293	53.10	4.36
5	11490.00	41.1 PK	74.0	-32.9	1.65 H	250	28.69	12.41
6	11490.00	30.1 AV	54.0	-23.9	1.65 H	250	17.69	12.41
7	#17235.00	41.2 PK	74.0	-32.8	1.55 H	129	24.48	16.72
8	#17235.00	30.4 AV	54.0	-23.6	1.55 H	129	13.68	16.72

ANTENNA POLARITY & TEST DISTANCE: VERTICAL AT 3 M								
NO.	FREQ. (MHz)	EMISSION LEVEL (dBuV/m)	LIMIT (dBuV/m)	MARGIN (dB)	ANTENNA HEIGHT (m)	TABLE ANGLE (Degree)	RAW VALUE (dBuV)	CORRECTION FACTOR (dB/m)
1	#5648.80	58.2 PK	68.2	-10.0	3.92 V	60	54.13	4.05
2	*5745.00	102.6 PK			3.92 V	60	100.86	1.74
3	*5745.00	92.8 AV			3.92 V	60	91.06	1.74
4	#5990.80	59.1 PK	68.2	-9.1	3.92 V	60	54.65	4.43
5	11490.00	42.3 PK	74.0	-31.7	1.66 V	102	29.89	12.41
6	11490.00	31.2 AV	54.0	-22.8	1.66 V	102	18.79	12.41
7	#17235.00	41.1 PK	74.0	-32.9	1.39 V	207	24.38	16.72
8	#17235.00	29.4 AV	54.0	-24.6	1.39 V	207	12.68	16.72

REMARKS:

1. Emission Level(dBuV/m) = Raw Value(dBuV) + Correction Factor(dB/m)
2. Correction Factor(dB/m) = Antenna Factor(dB/m) + Cable Factor(dB) – Pre-Amplifier Factor(dB)
3. The other emission levels were very low against the limit.
4. Margin value = Emission Level – Limit value
5. " * ": Fundamental frequency.
6. " # ": The radiated frequency is out of the restricted band.

CHANNEL	TX Channel 157	DETECTOR FUNCTION	Peak (PK)
FREQUENCY RANGE	1GHz ~ 40GHz		Average (AV)

ANTENNA POLARITY & TEST DISTANCE: HORIZONTAL AT 3 M

NO.	FREQ. (MHz)	EMISSION LEVEL (dBuV/m)	LIMIT (dBuV/m)	MARGIN (dB)	ANTENNA HEIGHT (m)	TABLE ANGLE (Degree)	RAW VALUE (dBuV)	CORRECTION FACTOR (dB/m)
1	#5636.93	57.2 PK	68.2	-11.0	1.14 H	285	53.19	4.03
2	*5785.00	93.7 PK			1.14 H	285	91.90	1.80
3	*5785.00	84.2 AV			1.14 H	285	82.40	1.80
4	#5999.82	57.5 PK	68.2	-10.7	1.14 H	285	53.09	4.44
5	11570.00	41.0 PK	74.0	-33.0	1.64 H	246	28.82	12.18
6	11570.00	30.0 AV	54.0	-24.0	1.64 H	246	17.82	12.18
7	#17355.00	41.1 PK	74.0	-32.9	1.59 H	117	23.83	17.27
8	#17355.00	30.5 AV	54.0	-23.5	1.59 H	117	13.23	17.27

ANTENNA POLARITY & TEST DISTANCE: VERTICAL AT 3 M

NO.	FREQ. (MHz)	EMISSION LEVEL (dBuV/m)	LIMIT (dBuV/m)	MARGIN (dB)	ANTENNA HEIGHT (m)	TABLE ANGLE (Degree)	RAW VALUE (dBuV)	CORRECTION FACTOR (dB/m)
1	#5623.15	57.3 PK	68.2	-10.9	3.10 V	43	53.29	4.00
2	#5673.50	57.9 PK	85.6	-27.8	3.10 V	43	53.76	4.12
3	*5785.00	103.0 PK			3.10 V	43	101.20	1.80
4	*5785.00	93.4 AV			3.10 V	43	91.60	1.80
5	#5925.25	56.7 PK	68.2	-11.5	3.10 V	43	52.31	4.35
6	#5973.70	56.9 PK	68.2	-11.3	3.10 V	43	52.51	4.40
7	11570.00	42.2 PK	74.0	-31.8	1.70 V	109	30.02	12.18
8	11570.00	31.1 AV	54.0	-22.9	1.70 V	109	18.92	12.18
9	#17355.00	41.2 PK	74.0	-32.8	1.35 V	215	23.93	17.27
10	#17355.00	29.3 AV	54.0	-24.7	1.35 V	215	12.03	17.27

REMARKS:

1. Emission Level(dBuV/m) = Raw Value(dBuV) + Correction Factor(dB/m)
2. Correction Factor(dB/m) = Antenna Factor(dB/m) + Cable Factor(dB) – Pre-Amplifier Factor(dB)
3. The other emission levels were very low against the limit.
4. Margin value = Emission Level – Limit value
5. " * ": Fundamental frequency.
6. " # ": The radiated frequency is out of the restricted band.



CHANNEL	TX Channel 165	DETECTOR FUNCTION	Peak (PK)
FREQUENCY RANGE	1GHz ~ 40GHz		Average (AV)

ANTENNA POLARITY & TEST DISTANCE: HORIZONTAL AT 3 M

NO.	FREQ. (MHz)	EMISSION LEVEL (dBuV/m)	LIMIT (dBuV/m)	MARGIN (dB)	ANTENNA HEIGHT (m)	TABLE ANGLE (Degree)	RAW VALUE (dBuV)	CORRECTION FACTOR (dB/m)
1	#5638.35	56.8 PK	68.2	-11.4	1.08 H	301	52.75	4.03
2	*5825.00	93.1 PK			1.08 H	301	91.27	1.83
3	*5825.00	83.9 AV			1.08 H	301	82.07	1.83
4	#5998.40	56.2 PK	68.2	-12.0	1.08 H	301	51.76	4.44
5	11650.00	40.8 PK	74.0	-33.2	1.67 H	247	28.77	12.03
6	11650.00	29.7 AV	54.0	-24.3	1.67 H	247	17.67	12.03
7	#17475.00	41.3 PK	74.0	-32.7	1.58 H	125	23.54	17.76
8	#17475.00	30.2 AV	54.0	-23.8	1.58 H	125	12.44	17.76

ANTENNA POLARITY & TEST DISTANCE: VERTICAL AT 3 M

NO.	FREQ. (MHz)	EMISSION LEVEL (dBuV/m)	LIMIT (dBuV/m)	MARGIN (dB)	ANTENNA HEIGHT (m)	TABLE ANGLE (Degree)	RAW VALUE (dBuV)	CORRECTION FACTOR (dB/m)
1	#5665.43	57.6 PK	79.7	-22.1	3.98 V	360	53.49	4.10
2	*5825.00	102.5 PK			3.98 V	360	100.67	1.83
3	*5825.00	92.8 AV			3.98 V	360	90.97	1.83
4	#5936.65	57.5 PK	68.2	-10.7	3.98 V	360	53.16	4.36
5	#5970.37	56.9 PK	68.2	-11.3	3.98 V	360	52.53	4.40
6	11650.00	42.1 PK	74.0	-31.9	1.72 V	110	30.07	12.03
7	11650.00	30.8 AV	54.0	-23.2	1.72 V	110	18.77	12.03
8	#17475.00	41.1 PK	74.0	-32.9	1.31 V	219	23.34	17.76
9	#17475.00	29.2 AV	54.0	-24.8	1.31 V	219	11.44	17.76

REMARKS:

1. Emission Level(dBuV/m) = Raw Value(dBuV) + Correction Factor(dB/m)
2. Correction Factor(dB/m) = Antenna Factor(dB/m) + Cable Factor(dB) – Pre-Amplifier Factor(dB)
3. The other emission levels were very low against the limit.
4. Margin value = Emission Level – Limit value
5. " * ": Fundamental frequency.
6. " # ": The radiated frequency is out of the restricted band.

802.11n (HT40)

CHANNEL	TX Channel 151	DETECTOR FUNCTION	Peak (PK)
FREQUENCY RANGE	1GHz ~ 40GHz		Average (AV)

ANTENNA POLARITY & TEST DISTANCE: HORIZONTAL AT 3 M								
NO.	FREQ. (MHz)	EMISSION LEVEL (dBuV/m)	LIMIT (dBuV/m)	MARGIN (dB)	ANTENNA HEIGHT (m)	TABLE ANGLE (Degree)	RAW VALUE (dBuV)	CORRECTION FACTOR (dB/m)
1	#5635.50	57.1 PK	68.2	-11.1	1.02 H	328	53.10	4.02
2	*5755.00	92.4 PK			1.02 H	328	90.64	1.76
3	*5755.00	80.5 AV			1.02 H	328	78.74	1.76
4	#5944.25	56.9 PK	68.2	-11.3	1.02 H	328	52.50	4.37
5	11510.00	41.1 PK	74.0	-32.9	1.67 H	257	28.72	12.38
6	11510.00	29.6 AV	54.0	-24.4	1.67 H	257	17.22	12.38
7	#17265.00	41.6 PK	74.0	-32.4	1.52 H	120	24.80	16.80
8	#17265.00	30.2 AV	54.0	-23.8	1.52 H	120	13.40	16.80

ANTENNA POLARITY & TEST DISTANCE: VERTICAL AT 3 M								
NO.	FREQ. (MHz)	EMISSION LEVEL (dBuV/m)	LIMIT (dBuV/m)	MARGIN (dB)	ANTENNA HEIGHT (m)	TABLE ANGLE (Degree)	RAW VALUE (dBuV)	CORRECTION FACTOR (dB/m)
1	#5655.45	56.6 PK	72.3	-15.6	3.53 V	52	52.54	4.08
2	*5755.00	99.5 PK			3.53 V	52	97.74	1.76
3	*5755.00	88.3 AV			3.53 V	52	86.54	1.76
4	#5968.95	56.9 PK	68.2	-11.3	3.53 V	52	52.53	4.40
5	11510.00	41.7 PK	74.0	-32.3	1.76 V	118	29.32	12.38
6	11510.00	30.5 AV	54.0	-23.5	1.76 V	118	18.12	12.38
7	#17265.00	40.6 PK	74.0	-33.4	1.29 V	223	23.80	16.80
8	#17265.00	28.9 AV	54.0	-25.1	1.29 V	223	12.10	16.80

REMARKS:

1. Emission Level(dBuV/m) = Raw Value(dBuV) + Correction Factor(dB/m)
2. Correction Factor(dB/m) = Antenna Factor(dB/m) + Cable Factor(dB) – Pre-Amplifier Factor(dB)
3. The other emission levels were very low against the limit.
4. Margin value = Emission Level – Limit value
5. " * ": Fundamental frequency.
6. " # ": The radiated frequency is out of the restricted band.



CHANNEL	TX Channel 159	DETECTOR FUNCTION	Peak (PK)
FREQUENCY RANGE	1GHz ~ 40GHz		Average (AV)

ANTENNA POLARITY & TEST DISTANCE: HORIZONTAL AT 3 M

NO.	FREQ. (MHz)	EMISSION LEVEL (dBuV/m)	LIMIT (dBuV/m)	MARGIN (dB)	ANTENNA HEIGHT (m)	TABLE ANGLE (Degree)	RAW VALUE (dBuV)	CORRECTION FACTOR (dB/m)
1	#5647.37	56.3 PK	68.2	-11.9	1.02 H	320	52.27	4.05
2	*5795.00	93.5 PK			1.02 H	320	91.68	1.82
3	*5795.00	82.9 AV			1.02 H	320	81.08	1.82
4	#5966.10	57.2 PK	68.2	-11.0	1.02 H	320	52.76	4.40
5	11590.00	41.1 PK	74.0	-32.9	1.65 H	243	28.99	12.11
6	11590.00	29.9 AV	54.0	-24.1	1.65 H	243	17.79	12.11
7	#17385.00	41.2 PK	74.0	-32.8	1.51 H	115	23.74	17.46
8	#17385.00	30.4 AV	54.0	-23.6	1.51 H	115	12.94	17.46

ANTENNA POLARITY & TEST DISTANCE: VERTICAL AT 3 M

NO.	FREQ. (MHz)	EMISSION LEVEL (dBuV/m)	LIMIT (dBuV/m)	MARGIN (dB)	ANTENNA HEIGHT (m)	TABLE ANGLE (Degree)	RAW VALUE (dBuV)	CORRECTION FACTOR (dB/m)
1	#5646.43	57.4 PK	68.2	-10.8	3.24 V	74	53.34	4.04
2	*5795.00	100.6 PK			3.24 V	74	98.78	1.82
3	*5795.00	90.7 AV			3.24 V	74	88.88	1.82
4	#5968.00	58.2 PK	68.2	-10.0	3.24 V	74	53.80	4.40
5	11590.00	41.5 PK	74.0	-32.5	1.73 V	108	29.39	12.11
6	11590.00	30.5 AV	54.0	-23.5	1.73 V	108	18.39	12.11
7	#17385.00	40.8 PK	74.0	-33.2	1.32 V	230	23.34	17.46
8	#17385.00	29.3 AV	54.0	-24.7	1.32 V	230	11.84	17.46

REMARKS:

1. Emission Level(dBuV/m) = Raw Value(dBuV) + Correction Factor(dB/m)
2. Correction Factor(dB/m) = Antenna Factor(dB/m) + Cable Factor(dB) – Pre-Amplifier Factor(dB)
3. The other emission levels were very low against the limit.
4. Margin value = Emission Level – Limit value
5. " * ": Fundamental frequency.
6. " # ": The radiated frequency is out of the restricted band.

Below 1GHz Data:
Ant Set 1
802.11a

CHANNEL	TX Channel 165	DETECTOR FUNCTION	Quasi-Peak (QP)
FREQUENCY RANGE	below 1GHz		

ANTENNA POLARITY & TEST DISTANCE: HORIZONTAL AT 3 M

NO.	FREQ. (MHz)	EMISSION LEVEL (dBuV/m)	LIMIT (dBuV/m)	MARGIN (dB)	ANTENNA HEIGHT (m)	TABLE ANGLE (Degree)	RAW VALUE (dBuV)	CORRECTION FACTOR (dB/m)
1	88.88	33.5 QP	43.5	-10.0	2.00 H	116	48.04	-14.56
2	101.88	34.4 QP	43.5	-9.1	2.00 H	91	47.01	-12.65
3	250.00	39.2 QP	46.0	-6.8	1.00 H	265	49.15	-9.95
4	308.90	39.0 QP	46.0	-7.1	1.00 H	76	46.61	-7.66
5	680.00	38.9 QP	46.0	-7.1	1.00 H	338	38.52	0.36
6	874.99	39.5 QP	46.0	-6.6	1.50 H	344	36.06	3.39

ANTENNA POLARITY & TEST DISTANCE: VERTICAL AT 3 M

NO.	FREQ. (MHz)	EMISSION LEVEL (dBuV/m)	LIMIT (dBuV/m)	MARGIN (dB)	ANTENNA HEIGHT (m)	TABLE ANGLE (Degree)	RAW VALUE (dBuV)	CORRECTION FACTOR (dB/m)
1	87.64	37.0 QP	40.0	-3.0	1.50 V	2	51.59	-14.61
2	108.81	36.8 QP	43.5	-6.7	1.00 V	276	48.33	-11.55
3	340.01	41.7 QP	46.0	-4.3	1.50 V	0	48.68	-6.94
4	510.00	36.4 QP	46.0	-9.6	2.00 V	33	38.94	-2.57
5	680.00	39.7 QP	46.0	-6.3	1.00 V	360	39.30	0.36
6	874.97	36.6 QP	46.0	-9.4	1.00 V	356	33.19	3.39

REMARKS:

1. Emission Level(dBuV/m) = Raw Value(dBuV) + Correction Factor(dB/m)
2. Correction Factor(dB/m) = Antenna Factor(dB/m) + Cable Factor(dB) – Pre-Amplifier Factor(dB)
3. The other emission levels were very low against the limit.
4. Margin value = Emission Level – Limit value

Ant Set 3
802.11a

CHANNEL	TX Channel 165	DETECTOR FUNCTION	Quasi-Peak (QP)
FREQUENCY RANGE	below 1GHz		

ANTENNA POLARITY & TEST DISTANCE: HORIZONTAL AT 3 M

NO.	FREQ. (MHz)	EMISSION LEVEL (dBuV/m)	LIMIT (dBuV/m)	MARGIN (dB)	ANTENNA HEIGHT (m)	TABLE ANGLE (Degree)	RAW VALUE (dBuV)	CORRECTION FACTOR (dB/m)
1	88.80	33.5 QP	43.5	-10.0	1.90 H	106	48.08	-14.56
2	101.87	34.5 QP	43.5	-9.0	1.90 H	101	47.11	-12.65
3	249.99	39.1 QP	46.0	-6.9	1.10 H	205	49.01	-9.95
4	308.80	38.9 QP	46.0	-7.1	1.10 H	106	46.52	-7.66
5	679.88	38.7 QP	46.0	-7.3	1.10 H	308	38.36	0.36
6	874.90	39.3 QP	46.0	-6.7	1.10 H	314	35.94	3.39

ANTENNA POLARITY & TEST DISTANCE: VERTICAL AT 3 M

NO.	FREQ. (MHz)	EMISSION LEVEL (dBuV/m)	LIMIT (dBuV/m)	MARGIN (dB)	ANTENNA HEIGHT (m)	TABLE ANGLE (Degree)	RAW VALUE (dBuV)	CORRECTION FACTOR (dB/m)
1	87.65	36.8 QP	40.0	-3.2	1.20 V	102	51.38	-14.61
2	108.80	36.8 QP	43.5	-6.7	1.10 V	266	48.32	-11.55
3	340.00	41.7 QP	46.0	-4.3	1.10 V	16	48.64	-6.94
4	510.01	36.4 QP	46.0	-9.6	1.90 V	103	38.99	-2.57
5	679.90	39.7 QP	46.0	-6.3	1.10 V	300	39.36	0.36
6	874.80	36.4 QP	46.0	-9.6	1.00 V	306	33.06	3.38

REMARKS:

1. Emission Level(dBuV/m) = Raw Value(dBuV) + Correction Factor(dB/m)
2. Correction Factor(dB/m) = Antenna Factor(dB/m) + Cable Factor(dB) – Pre-Amplifier Factor(dB)
3. The other emission levels were very low against the limit.
4. Margin value = Emission Level – Limit value

4.2 Transmit Power Measurement

4.2.1 Limits of Transmit Power Measurement

Operation Band	EUT Category		Limit
U-NII-1		Outdoor Access Point	1 Watt (30 dBm) (Max. e.i.r.p \leq 125mW(21 dBm) at any elevation angle above 30 degrees as measured from the horizon)
		Fixed point-to-point Access Point	1 Watt (30 dBm)
		Indoor Access Point	1 Watt (30 dBm)
		Mobile and Portable client device	250mW (24 dBm)
U-NII-2A			250mW (24 dBm) or 11 dBm+10 log B*
U-NII-2C			250mW (24 dBm) or 11 dBm+10 log B*
U-NII-3	√		1 Watt (30 dBm)

*B is the 26 dB emission bandwidth in megahertz

Per KDB 662911 Method of conducted output power measurement on IEEE 802.11 devices,

Array Gain = 0 dB (i.e., no array gain) for $N_{ANT} \leq 4$;

Array Gain = 0 dB (i.e., no array gain) for channel widths ≥ 40 MHz for any N_{ANT} ;

Array Gain = $5 \log(N_{ANT}/N_{SS})$ dB or 3 dB, whichever is less for 20-MHz channel widths with $N_{ANT} \geq 5$.

For power measurements on all other devices: Array Gain = $10 \log(N_{ANT}/N_{SS})$ dB.

4.2.2 Test Setup

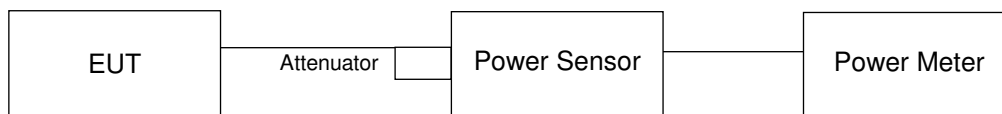

4.2.3 Test Instruments

Refer to section 4.1.2 to get information of above instrument.

4.2.4 Test Procedure

Method PM is used to perform output power measurement, trigger and gating function of wide band power meter is enabled to measure max output power of TX on burst. Duty factor is not added to measured value.

4.2.5 Deviation from Test Standard

No deviation.

4.2.6 EUT Operating Condition

The software provided by client to enable the EUT under transmission condition continuously at lowest, middle and highest channel frequencies individually.

4.2.7 Test Result

Power Output:

802.11a

Chan.	Chan. Freq. (MHz)	Maximum Conducted Power (dBm)		Total Power (mW)	Total Power (dBm)	Power Limit (dBm)	Pass/Fail
		Chain 0	Chain 1				
149	5745	15.82	16.94	87.625	19.43	30	Pass
157	5785	15.65	17.13	88.37	19.46	30	Pass
165	5825	16.45	17.59	101.569	20.07	30	Pass

802.11n (HT20)

Chan.	Chan. Freq. (MHz)	Maximum Conducted Power (dBm)		Total Power (mW)	Total Power (dBm)	Power Limit (dBm)	Pass/Fail
		Chain 0	Chain 1				
149	5745	15.86	17.00	88.667	19.48	30	Pass
157	5785	15.76	17.30	91.373	19.61	30	Pass
165	5825	16.22	17.34	96.079	19.83	30	Pass

802.11n (HT40)

Chan.	Chan. Freq. (MHz)	Maximum Conducted Power (dBm)		Total Power (mW)	Total Power (dBm)	Power Limit (dBm)	Pass/Fail
		Chain 0	Chain 1				
151	5755	15.61	17.25	89.48	19.52	30	Pass
159	5795	16.21	17.30	95.486	19.80	30	Pass

4.3 Peak Power Spectral Density Measurement

4.3.1 Limits of Peak Power Spectral Density Measurement

Operation Band	EUT Category		Limit
U-NII-1		Outdoor Access Point	17dBm/ MHz
		Fixed point-to-point Access Point	
		Indoor Access Point	
		Mobile and Portable client device	11dBm/ MHz
U-NII-2A			11dBm/ MHz
U-NII-2C			11dBm/ MHz
U-NII-3		√	30dBm/ 500kHz

4.3.2 Test Setup

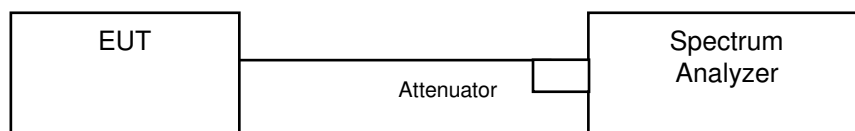

4.3.3 Test Instruments

Refer to section 4.1.2 to get information of above instrument.

4.3.4 Test Procedure

1. Set span to encompass the entire emission bandwidth (EBW) of the signal.
2. Set RBW = 300 kHz, Set VBW ≥ 1 MHz, Detector = RMS
3. Use the peak marker function to determine the maximum power level in any 300 kHz band segment within the fundamental EBW.
4. Scale the observed power level to an equivalent value in 500 kHz by adjusting (reducing) the measured power by a bandwidth correction factor (BWCF) where $BWCF = 10\log(500\text{ kHz}/300\text{ kHz})$
5. Sweep time = auto, trigger set to “free run”.
6. Trace average at least 100 traces in power averaging mode.
7. Record the max value

4.3.5 Deviation from Test Standard

No deviation.

4.3.6 EUT Operating Condition

Same as Item 4.2.6

4.3.7 Test Results

802.11a

TX chain	Channel	Freq. (MHz)	PSD (dBm/300kHz)	PSD (dBm/500kHz)	10 log (N=2) dB	Total PSD (dBm/500kHz)	Limit (dBm/500kHz)	Pass /Fail
0	149	5745	-6.12	-3.90	3.01	-0.89	30.00	Pass
	157	5785	-5.90	-3.68	3.01	-0.67	30.00	Pass
	165	5825	-4.98	-2.76	3.01	0.25	30.00	Pass
1	149	5745	-4.62	-2.40	3.01	0.61	30.00	Pass
	157	5785	-4.56	-2.34	3.01	0.67	30.00	Pass
	165	5825	-4.39	-2.17	3.01	0.84	30.00	Pass

Note: Directional gain = $10 \log[(10^{G1/20} + 10^{G2/20})^2 / 2] = 3.81\text{dBi} < 6\text{dBi}$, so the power density limit shall not be reduced.

802.11n (HT20)

TX chain	Channel	Freq. (MHz)	PSD (dBm/300kHz)	PSD (dBm/500kHz)	10 log (N=2) dB	Total PSD (dBm/500kHz)	Limit (dBm/500kHz)	Pass /Fail
0	149	5745	-6.41	-4.19	3.01	-1.18	30.00	Pass
	157	5785	-6.22	-4.00	3.01	-0.99	30.00	Pass
	165	5825	-5.53	-3.31	3.01	-0.30	30.00	Pass
1	149	5745	-5.15	-2.93	3.01	0.08	30.00	Pass
	157	5785	-4.92	-2.70	3.01	0.31	30.00	Pass
	165	5825	-4.66	-2.44	3.01	0.57	30.00	Pass

Note: Directional gain = $10 \log[(10^{G1/20} + 10^{G2/20})^2 / 2] = 3.81\text{dBi} < 6\text{dBi}$, so the power density limit shall not be reduced.

802.11n (HT40)

TX chain	Channel	Freq. (MHz)	PSD (dBm/300kHz)	PSD (dBm/500kHz)	10 log (N=2) dB	Total PSD (dBm/500kHz)	Limit (dBm/500kHz)	Pass /Fail
0	151	5755	-7.66	-5.44	3.01	-2.43	30.00	Pass
	159	5795	-7.96	-5.74	3.01	-2.73	30.00	Pass
1	151	5755	-8.79	-6.57	3.01	-3.56	30.00	Pass
	159	5795	-7.38	-5.16	3.01	-2.15	30.00	Pass

Note: Directional gain = $10 \log[(10^{G1/20} + 10^{G2/20})^2 / 2] = 3.81\text{dBi} < 6\text{dBi}$, so the power density limit shall not be reduced.

Spectrum Plot of Worst Value

802.11a – Chain 1: CH 165

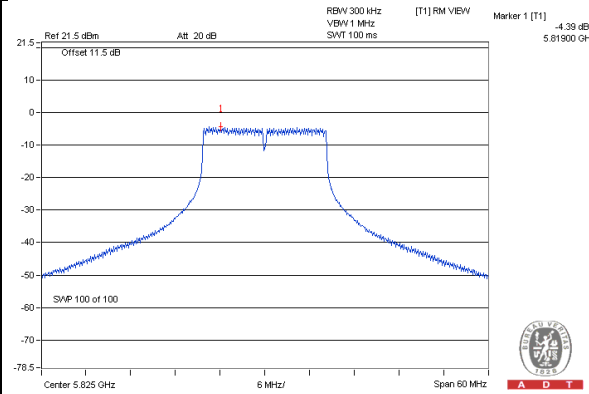

802.11n (HT20) – Chain 1: CH 165

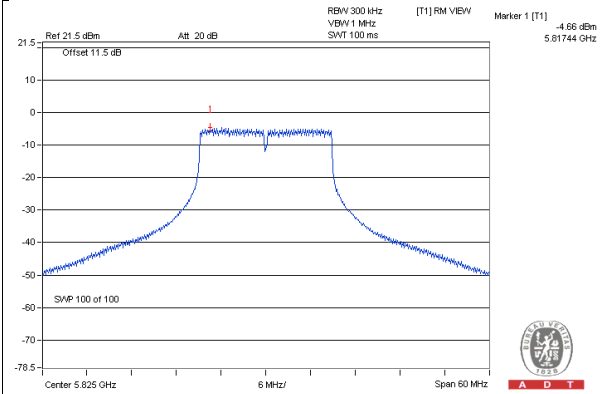

802.11n (HT40) – Chain 1: CH 159

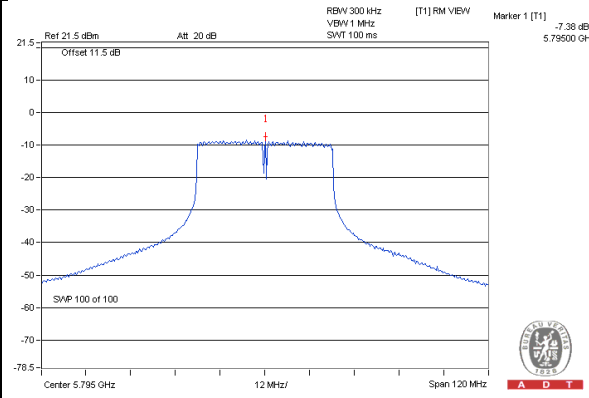

4.4 Frequency Stability Measurement

4.4.1 Limits of Frequency Stability Measurement

The frequency of the carrier signal shall be maintained within band of operation

4.4.2 Test Setup

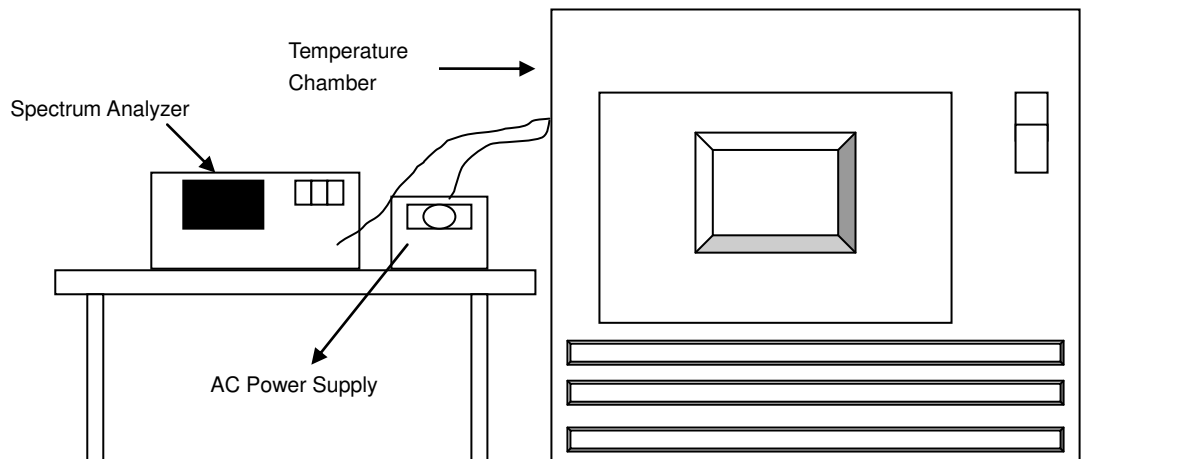

4.4.3 Test Instruments

Refer to section 4.1.2 to get information of above instrument.

4.4.4 Test Procedure

- The EUT was placed inside the environmental test chamber and powered by nominal AC voltage.
- Turn the EUT on and couple its output to a spectrum analyzer.
- Turn the EUT off and set the chamber to the highest temperature specified.
- Allow sufficient time (approximately 30 min) for the temperature of the chamber to stabilize, turn the EUT on and measure the operating frequency after 2, 5, and 10 Minutes.
- Repeat step 2 and 3 with the temperature chamber set to the lowest temperature.
- The test chamber was allowed to stabilize at +20 degree C for a minimum of 30 Minutes. The supply voltage was then adjusted on the EUT from 85% to 115% and the frequency record.

4.4.5 Deviation from Test Standard

No deviation.

4.4.6 EUT Operating Condition

Set the EUT transmit at un-modulation mode to test frequency stability.

4.4.7 Test Results

Frequency Stability Versus Temp.									
Operating Frequency: 5745 MHz									
TEMP. (°C)	Power Supply (Vac)	0 Minute		2 Minute		5 Minute		10 Minute	
		Measured Frequency (MHz)	Pass/Fail	Measured Frequency (MHz)	Pass/Fail	Measured Frequency (MHz)	Pass/Fail	Measured Frequency (MHz)	Pass/Fail
50	120	5744.9796	Pass	5744.9763	Pass	5744.9779	Pass	5744.9795	Pass
40	120	5745.0015	Pass	5744.9996	Pass	5745.001	Pass	5744.998	Pass
30	120	5744.9932	Pass	5744.9961	Pass	5744.9957	Pass	5744.9957	Pass
20	120	5745.0202	Pass	5745.0237	Pass	5745.0184	Pass	5745.0215	Pass
10	120	5744.9859	Pass	5744.9861	Pass	5744.9859	Pass	5744.989	Pass
0	120	5745.0114	Pass	5745.0119	Pass	5745.0081	Pass	5745.0085	Pass
-10	120	5744.9792	Pass	5744.9803	Pass	5744.982	Pass	5744.9801	Pass
-20	120	5745.0285	Pass	5745.0271	Pass	5745.0229	Pass	5745.0285	Pass
-30	120	5744.9989	Pass	5744.9959	Pass	5744.9994	Pass	5744.9976	Pass

Frequency Stability Versus Voltage									
Operating Frequency: 5745 MHz									
TEMP. (°C)	Power Supply (Vac)	0 Minute		2 Minute		5 Minute		10 Minute	
		Measured Frequency (MHz)	Pass/Fail	Measured Frequency (MHz)	Pass/Fail	Measured Frequency (MHz)	Pass/Fail	Measured Frequency (MHz)	Pass/Fail
20	138	5745.0191	Pass	5745.0239	Pass	5745.0195	Pass	5745.0224	Pass
	120	5745.0202	Pass	5745.0237	Pass	5745.0184	Pass	5745.0215	Pass
	102	5745.0212	Pass	5745.0228	Pass	5745.0179	Pass	5745.0208	Pass

4.5 6dB Bandwidth Measurement

4.5.1 Limits of 6dB Bandwidth Measurement

The minimum of 6dB Bandwidth Measurement is 0.5MHz.

4.5.2 Test Setup

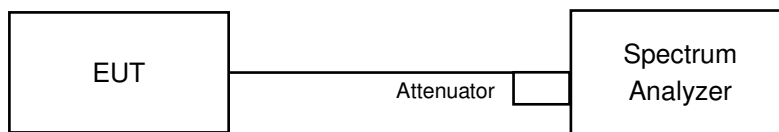

4.5.3 Test Instruments

Refer to section 4.1.2 to get information of above instrument.

4.5.4 Test Procedure

MEASUREMENT PROCEDURE REF

- Set resolution bandwidth (RBW) = 100kHz
- Set the video bandwidth (VBW) $\geq 3 \times$ RBW, Detector = Peak.
- Trace mode = max hold.
- Sweep = auto couple.
- Measure the maximum width of the emission that is constrained by the frequencies associated with the two amplitude points (upper and lower) that are attenuated by 6 dB relative to the maximum level measured in the fundamental emission

4.5.5 Deviation from Test Standard

No deviation.

4.5.6 EUT Operating Condition

The software provided by client to enable the EUT under transmission condition continuously at lowest, middle and highest channel frequencies individually.

4.5.7 Test Results

802.11a

Channel	Frequency (MHz)	6dB Bandwidth (MHz)		Minimum Limit (MHz)	Pass / Fail
		Chain 0	Chain 1		
149	5745	16.42	16.42	0.5	PASS
157	5785	16.42	16.47	0.5	PASS
165	5825	16.42	16.42	0.5	PASS

802.11ac (VHT20)

Channel	Frequency (MHz)	6dB Bandwidth (MHz)		Minimum Limit (MHz)	Pass / Fail
		Chain 0	Chain 1		
149	5745	17.64	17.64	0.5	PASS
157	5785	17.64	17.67	0.5	PASS
165	5825	17.66	17.65	0.5	PASS

802.11ac (VHT40)

Channel	Frequency (MHz)	6dB Bandwidth (MHz)		Minimum Limit (MHz)	Pass / Fail
		Chain 0	Chain 1		
151	5755	36.36	36.16	0.5	PASS
159	5795	36.34	36.19	0.5	PASS

Spectrum Plot of Worst Value

802.11a_Chain 1 / CH165

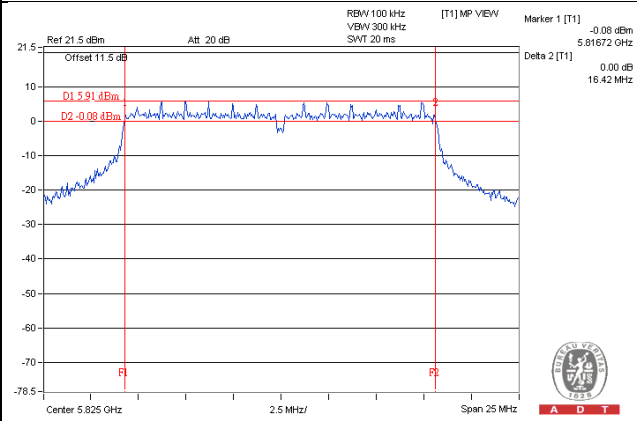

802.11n (HT20)_Chain 1 / CH149

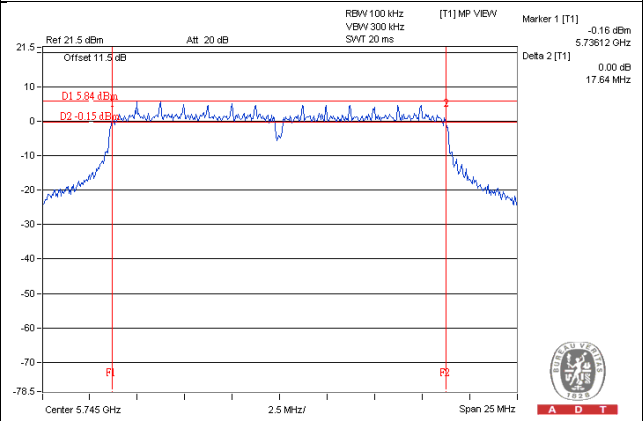

802.11n (HT40)_Chain 1 / CH151

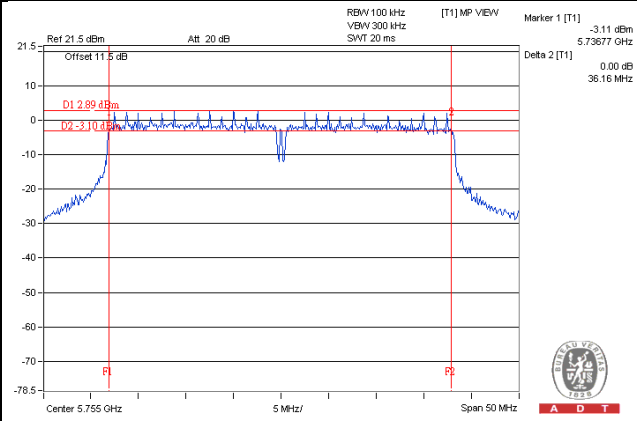

5 Pictures of Test Arrangements

Please refer to the attached file (Test Setup Photo).

Annex A- Radiated Out of Band Emission (OOBE) Measurement (For U-NII-3 band)

802.11a

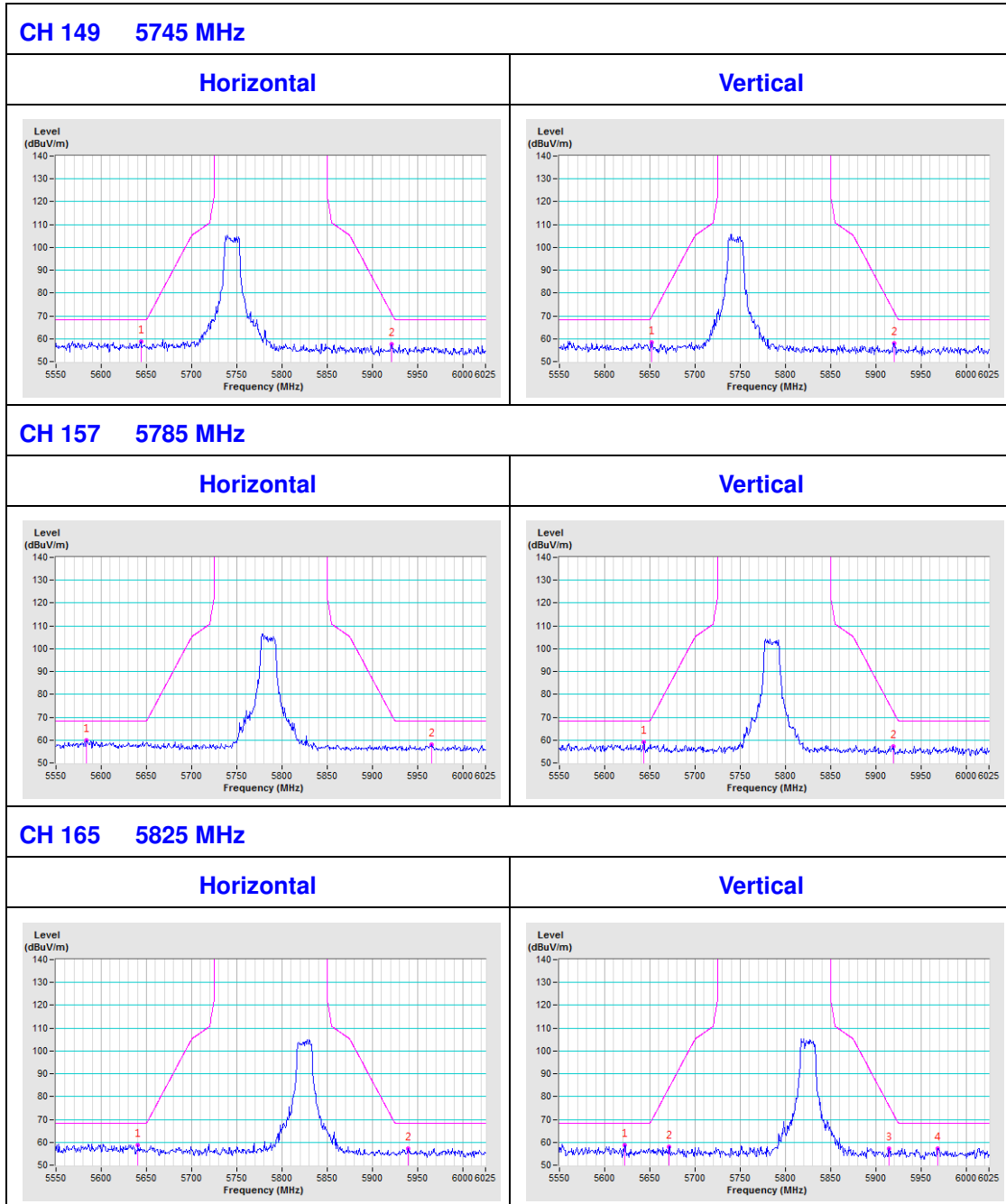

802.11n (HT20)

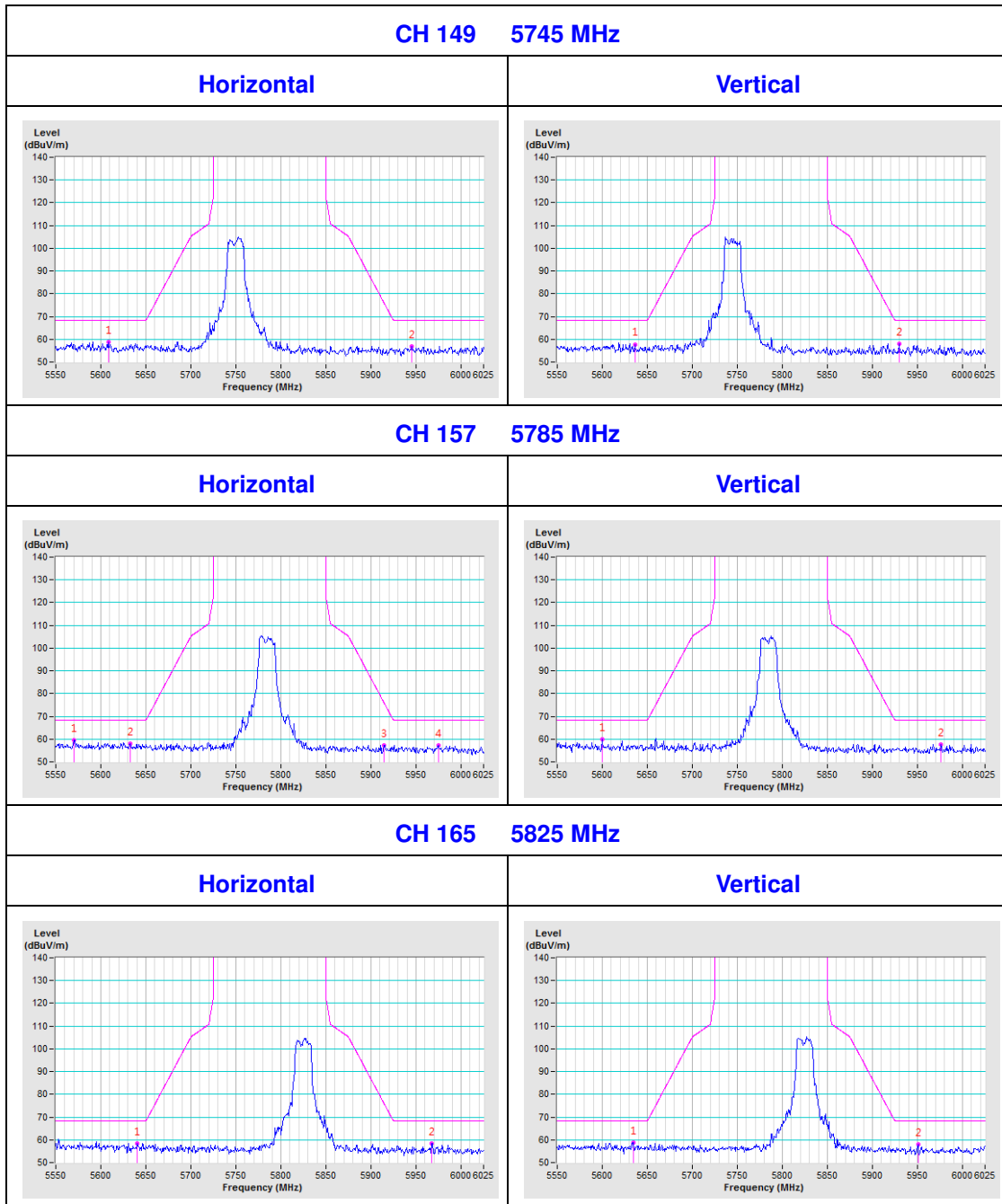

802.11n (HT40)

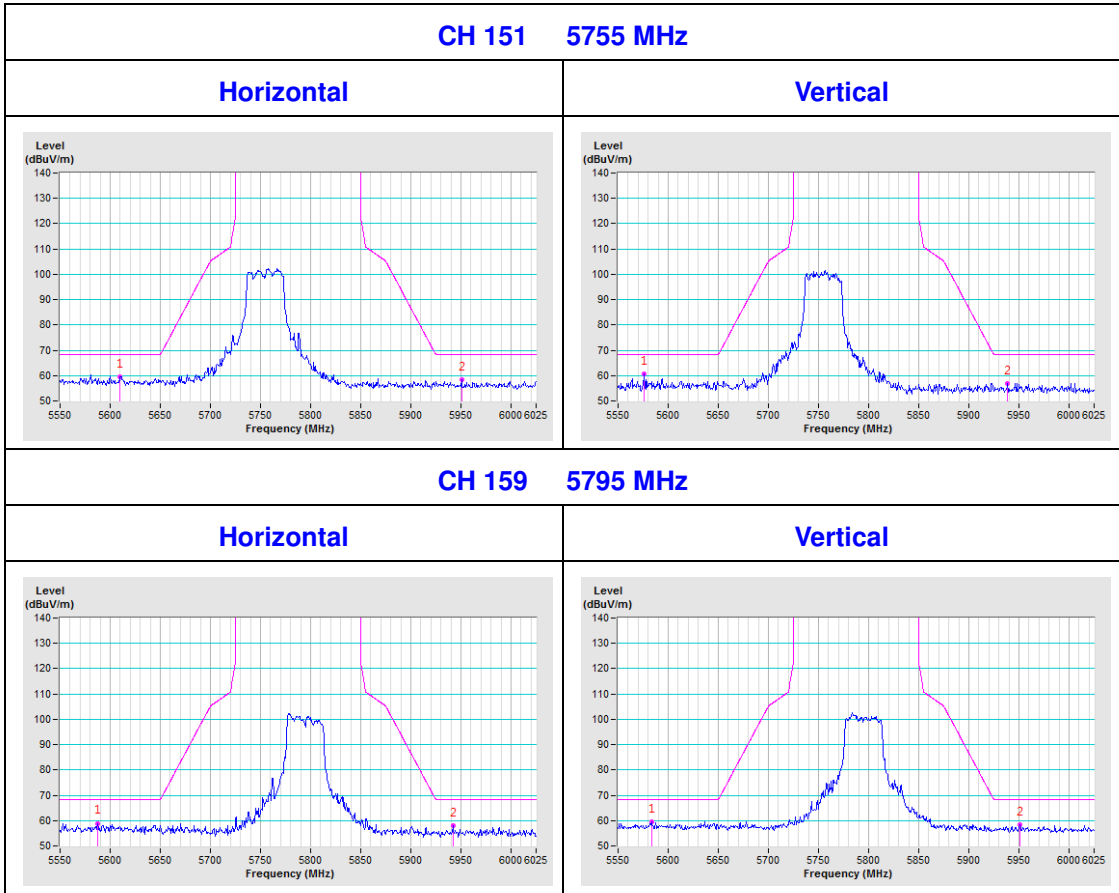



Appendix – Information on the Testing Laboratories

We, Bureau Veritas Consumer Products Services (H.K.) Ltd., Taoyuan Branch, were founded in 1988 to provide our best service in EMC, Radio, Telecom and Safety consultation. Our laboratories are accredited and approved according to ISO/IEC 17025.

If you have any comments, please feel free to contact us at the following:

Linko EMC/RF Lab

Tel: 886-2-26052180

Fax: 886-2-26051924

Hsin Chu EMC/RF/Telecom Lab

Tel: 886-3-6668565

Fax: 886-3-6668323

Hwa Ya EMC/RF/Safety Lab

Tel: 886-3-3183232

Fax: 886-3-3270892

Email: service.adt@tw.bureauveritas.com

Web Site: www.bureauveritas-adt.com

The address and road map of all our labs can be found in our web site also.

--- END ---