



Test Report

Product Name : Wireless LAN PC Card

Model No.: WP288P

FCC ID.: PQP-WP288P

Applicant : PRIME ELECTRONICS & SATELLITICS INC

Address : 69, Tung-Yuan Rd., Chung-Li Industrial Park, Chung-Li
City, Taoyuan, Taiwan.

Date of Receipt : Apr 8, 2003

Date of Test : Apr 10, 2003

Report No. : 034H032FI

The test results relate only to the samples tested.

The test report shall not be reproduced except in full without the written approval of Quietek Corporation.

This report must not be used to claim product endorsement by NVLAP any agency of the U.S. Government

Test Report Certification

Test Date : Apr 10, 2003

Report No. : 034H032FI



Accredited by NIST (NVLAP)
NVLAP Lab Code: 200347-0

Product Name : Wireless LAN PC Card

Applicant : PRIME ELECTRONICS & SATELLITICS INC

Address : 69, Tung-Yuan Rd., Chung-Li Industrial Park, Chung-Li City, Taoyuan, Taiwan.

Manufacturer : PRIME ELECTRONICS & SATELLITICS INC

Model No. : WP288P

FCC ID. : PQP-WP288P

Rated Voltage : DC 3.3V(Power By PC)

Trade Name : PESI

Measurement Standard : FCC Part 15 Subpart C Paragraph 15.247

Measurement Procedure : ANSI C63.4: 1992

Test Result : Complied



The Test Results relate only to the samples tested.
 The test report shall not be reproduced except in full without the written approval of Quietek Corporation.
 This report must not be used to claim product endorsement by NVLAP any agency of the U.S. Government

Documented By : Ginny Peng
 (Ginny Peng)

Tested By : Kenny Jwo
 (Kenny Jwo)

Approved By : [Signature]
 (Kevin Wang)

TABLE OF CONTENTS

Description	Page
1. GENERAL INFORMATION	5
1.1. EUT Description.....	5
1.2. Operational Description	6
1.3. Tested System Details.....	7
1.4. Configuration of tested System	8
1.5. EUT Exercise Software	8
1.6. Test Facility	9
2. Conducted Emission.....	10
2.1. Test Equipment.....	10
2.2. Test Setup	10
2.3. Limits	10
2.4. Test Procedure	11
2.5. Test Result of Conducted Emission.....	12
3. Peak Power Output	14
3.1. Test Equipment.....	14
3.2. Test Setup	14
3.3. Limits	14
3.4. Test Result of Peak Power Output.....	15
4. RF Exposure Evaluation	16
4.1. Limits	16
4.2. Test Procedure	16
4.3. Test Result of RF Exposure Evaluation.....	17
5. Radiated Emission.....	18
5.1. Test Equipment.....	18
5.2. Test Setup	18
5.3. Limits	19
5.4. Test Procedure	20
5.5. Test Result of Radiated Emission.....	21
6. Band Edge	27
6.1. Test Equipment.....	27
6.2. Test Setup	27
6.3. Limits	28
6.4. Test Procedure	28
6.5. Test Result of Band Edge	29
7. Occupied Bandwidth.....	31
7.1. Test Equipment.....	31
7.2. Test Setup	31
7.3. Limits	31
7.4. Test Result of Occupied Bandwidth	32
8. Power Density	33

8.1.	Test Equipment.....	33
8.2.	Test Setup	33
8.3.	Limits	33
8.4.	Test Result of Power Density	34
9.	EMI Reduction Method During Compliance Testing	35
Attachment 1:	EUT Test Photographs	
Attachment 2:	EUT Detailed Photographs	

1. GENERAL INFORMATION

1.1. EUT Description

Product Name : Wireless LAN PC Card
Trade Name : PESI
FCC ID. : PQP-WP288P
Model No. : WP288P
Frequency Range : 2412MHz to 2462MHz
Channel Number : 11
Chip Rate : 1Mbps, 2Mbps, 5.5Mbps, 11Mbps
Type of Modulation : Direct Sequence Spread Spectrum
Antenna type : Printed
Antenna Gain : 1.0dBi
Operator Selection of : Auto
Operating Frequency

Frequency of Each Channel:

Channel	Frequency	Channel	Frequency	Channel	Frequency
Channel 1:	2412 MHz	Channel 6:	2437 MHz	Channel 11:	2462 MHz
Channel 2:	2417 MHz	Channel 7:	2442 MHz		
Channel 3:	2422 MHz	Channel 8:	2447 MHz		
Channel 4:	2427 MHz	Channel 9:	2452 MHz		
Channel 5:	2432 MHz	Channel 10:	2457 MHz		

Note:

1. This device is a 2.4GHz Wireless LAN PC Card included a 2.4GHz receiving function, a 2.4GHz transmitting function.
2. Regards to the frequency band operation; the highest rate that was included the lowest, middle and highest frequency of channel were selected to perform the test, then shown on this report.
3. These tests were conducted on a sample of the equipment for the purpose of demonstrating compliance with Part 15 Subpart C Paragraph 15.247 for spread spectrum devices.
4. This device is a composite device in accordance with Part 15 regulations. The function receiving was measured and made a test report that the report number is 034H032F under Declaration of Conformity.

1.2. Operational Description

EUT is a Wireless LAN PC Card with 11 channels. This device provided four kind of transmitting speed 1,2,5.5 and 11Mbps. The device of RF carrier is DQPSK, DB PSK and CCK.

The device adapts direct sequence spread spectrum modulation. The printed antenna was provides diversity function to improve the receiving function.

This Wireless LAN PC Card is an IEEE 802.11b Wireless LAN adapter. It allows your computer to connect to a wireless network and to share resources, such as files or printers without being bound to the network wires. Operation in 2.4GHz Direst Sequence Spread Spectrum (DSSS) radio transmission, the Wireless LAN PC Card transfers data at speeds up to 64/128-bit Wired Equivalent Protection (WEP) algorithm is used. In addition, its standard compliance ensures that it can communicate with any 802.11b network.

1.3. Tested System Details

The types for all equipment, plus descriptions of all cables used in the tested system (including inserted cards) are:

	Product	Manufacturer	Model No.	Serial No.	Power Cord
(1)	Monitor	VIEWSNOIC	VCDDT21553-3P	10H010101110	Non-shielded, 1.8m
(2)	Notebook PC	LEO	DESIGNOTE	NB7017260B	Non-shielded, 1.6m
(3)	Printer	HP	C2642A	MY75J1D1D0	Non-shielded, 0.7m
(4)	Modem	ACEEX	DM-1414	0102027544	Non-shielded, 1.6m
(5)	Microphone & Earphone	TOKTO	SX-MI	N/A	--
(6)	Mouse	Logitech	M-S35	LZA74956375	--
(7)	USB Mouse	Logitech	M-UE55	N/A	--

	Signal Cable Type	Signal cable Description
A.	VGA Cable	Shielded, 1.7m, one ferrite core bonded
B.	Mouse Cable	Shielded, 1.8m
C.	USB Mouse Cable	Shielded, 1.2m
D.	Microphone & Earphone Cable	Non-shielded, 1.6m
E.	Modem Cable	Shielded, 1.6m
F.	Printer Cable	Shielded, 1.7m

1.4. Configuration of tested System

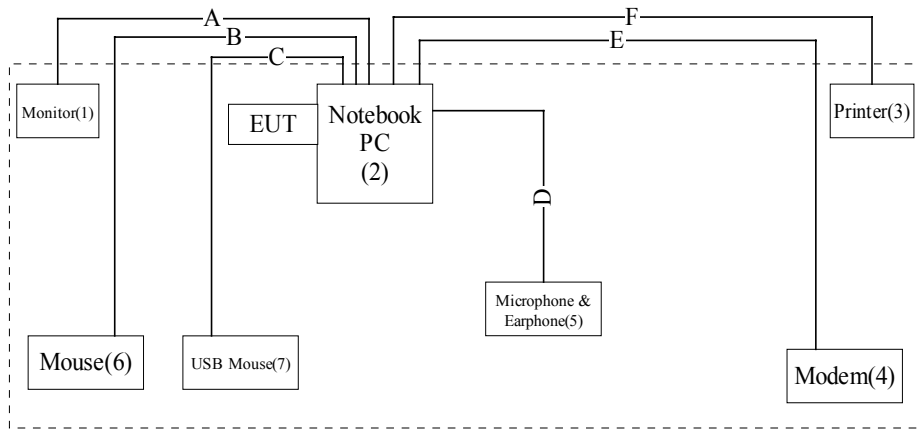

1.5. EUT Exercise Software

- (1) Setup the EUT and simulators as shown on 1.4
- (2) Turn on the power of all equipment.
- (3) Notebook PC reads data from disk.
- (4) Data will be transmitting through EUT.
- (5) The transmitted status will be shown on the monitor.
- (6) Repeat the above procedure 1.5.3 to 1.5.5

1.6. Test Facility

Ambient conditions in the laboratory:

Items	Required (IEC 68-1)	Actual
Temperature (°C)	15-35	20-35
Humidity (%RH)	25-75	50-65
Barometric pressure (mbar)	860-1060	950-1000

Site Description: November 3, 1998 File on
 Federal Communications Commission
 FCC Engineering Laboratory
 7435 Oakland Mills Road
 Columbia, MD 21046
 Reference 31040/SIT1300F2
 August 30, 2001 Accreditation on NVLAP
 NVLAP Lab Code: 200347-0



Site Name: Quietek Corporation

Site Address: No.75-1, Wang-Yeh Valley, Yung-Hsing,
 Chiung-Lin, Hsin-Chu County,
 Taiwan, R.O.C.
 TEL : 886-3-592-8858 / FAX : 886-3-592-8859
 E-Mail: service@quietek.com

2. Conducted Emission

2.1. Test Equipment

The following test equipment are used during the conducted emission test:

Item	Instrument	Manufacturer	Type No./Serial No	Last Cal.	Remark
1	Test Receiver	R & S	ESCS 30/825442/17	May, 2002	
2	L.I.S.N.	R & S	ESH3-Z5/825016/6	May, 2002	EUT
3	L.I.S.N.	Kyoritsu	KNW-407/8-1420-3	May, 2002	Peripherals
4	Pulse Limiter	R & S	ESH3-Z2	N/A	
5	No.2 Shielded Room			N/A	

Note: All equipment upon which need to calibrated are with calibration period of 1 year.

2.2. Test Setup

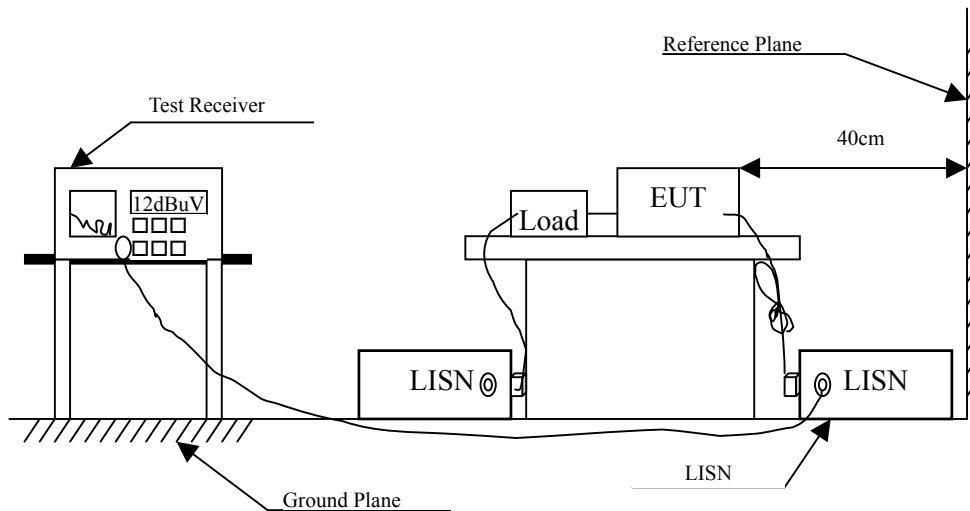

2.3. Limits

FCC Part 15 Subpart C Paragraph 15.207 (dBuV) Limit		
Frequency MHz	Limits	
	QP	AV
0.15 - 0.50	66-56	56-46
0.50-5.0	56	46
5.0 - 30	60	50

Remarks : In the above table, the tighter limit applies at the band edges.

2.4. Test Procedure

The EUT and simulators are connected to the main power through a line impedance stabilization network (L.I.S.N.). This provides a 50 ohm /50uH coupling impedance for the measuring equipment. The peripheral devices are also connected to the main power through a LISN that provides a 50ohm/50uH coupling impedance with 50ohm termination. (Please refer to the block diagram of the test setup and photographs.)

Both sides of A.C. line are checked for maximum conducted interference. In order to find the maximum emission, the relative positions of equipment and all of the interface cables must be changed according to ANSI C63.4:1992 on conducted measurement.

Conducted emissions were investigated over the frequency range from 0.15MHz to 30MHz using a receiver bandwidth of 9kHz.

2.5. Test Result of Conducted Emission

Product : Wireless LAN PC Card
 Test Item : Conducted Emission
 Power Line : Line 1
 Test Mode : Normal Operation

Frequency MHz	Cable Loss dB	Probe Factor dB	Reading Level dBuV	Emission Level dBuV	Limits dBuV
Quasi-Peak					
*0.173	-0.01	0.11	52.71	52.81	64.79
0.232	-0.03	0.14	42.79	42.91	62.38
0.349	0.02	0.18	35.39	35.59	58.98
4.115	0.28	0.41	24.31	25.00	56.00
17.845	0.22	0.55	19.63	20.41	60.00
27.193	0.39	0.59	30.07	31.05	60.00
Average					
0.173	-0.01	0.11	38.90	39.00	54.82
0.232	-0.03	0.14	30.40	30.52	52.38
0.349	0.02	0.18	22.40	22.60	48.99
4.115	0.28	0.41	19.80	20.49	46.00
17.845	0.22	0.55	14.00	14.78	50.00
27.193	0.39	0.59	27.20	28.18	50.00

Note:

1. All Reading Levels are Quasi-Peak and Average value.
2. “ * ”, means this data is the worst emission level.
3. Emission Level = Reading Level + LISN Factor + Cable Loss.

Product : Wireless LAN PC Card
 Test Item : Conducted Emission
 Power Line : Line 2
 Test Mode : Normal Operation

Frequency MHz	Cable Loss dB	Probe Factor dB	Reading Level dBuV	Emission Level dBuV	Limits dBuV
Quasi-Peak					
*0.173	-0.01	0.11	51.55	51.65	64.79
0.230	-0.03	0.14	41.95	42.07	62.45
0.349	0.02	0.18	33.53	33.73	58.98
9.396	0.10	0.49	20.35	20.94	60.00
15.998	0.18	0.54	23.35	24.07	60.00
27.193	0.39	0.59	29.91	30.89	60.00
Average					
0.173	-0.01	0.11	39.10	39.20	54.82
0.230	-0.03	0.14	28.90	29.02	52.45
0.349	0.02	0.18	22.80	23.00	48.99
9.396	0.10	0.49	15.70	16.29	50.00
15.998	0.18	0.54	17.80	18.52	50.00
27.193	0.39	0.59	26.80	27.78	50.00

Note:

1. All Reading Levels are Quasi-Peak and Average value.
2. “ * ”, means this data is the worst emission level.
3. Emission Level = Reading Level + LISN Factor + Cable Loss.

3. Peak Power Output

3.1. Test Equipment

The following test equipments are used during the radiated emission tests:

Equipment	Manufacturer	Model No./Serial No.	Last Cal.
X Spectrum Analyzer	Advantest	R3272 / 72421194	May, 2002

Note: 1. All equipment upon which need to calibrated are with calibration period of 1 year.
 2. Mark "X" test instruments are used to measure the final test results.

3.2. Test Setup

Conduction Power Measurement

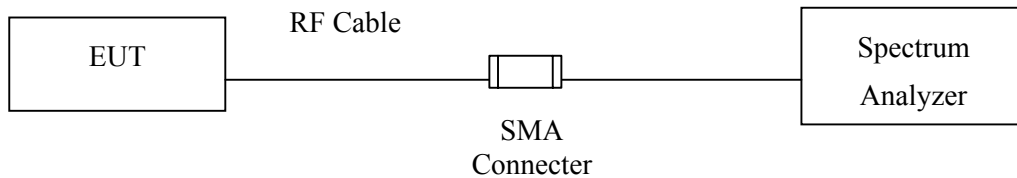

3.3. Limits

The maximum peak power shall be less 1 Watt.

3.4. Test Result of Peak Power Output

Product : Wireless LAN PC Card
Test Item : Peak Power Output
Test Site : No.1 OATS
Test Mode : Normal Operation

Channel No.	Frequency(MHz)	Measurement	Required Limit	Result
1	2412.00	12.17dBm	1 Watt= 30 dBm	Pass
6	2437.00	10.76dBm	1 Watt= 30 dBm	Pass
11	2462.00	10.04dBm	1 Watt= 30 dBm	Pass

Note:

1. Receiver setting (Peak Detector) : RBW:1MHz; VBW:1MHz; Span:100MHz ◦

4. RF Exposure Evaluation

4.1. Limits

According to FCC 1.1310: The criteria listed in the following table shall be used to evaluate the environment impact of human exposure to radio frequency (RF) radiation as specified in 1.1307(b)

LIMITS FOR MAXIMUM PERMISSIBLE EXPOSURE (MPE)

Frequency Range (MHz)	Electric Field Strength (V/m)	Magnetic Field Strength (A/m)	Power Density (mW/cm ²)	Average Time (Minutes)
(A) Limits for Occupational/ Control Exposures				
300-1500	--	--	F/300	6
1500-100,000	--	--	5	6
(B) Limits for General Population/ Uncontrolled Exposures				
300-1500	--	--	F/1500	6
1500-100,000	--	--	1	30

F= Frequency in MHz

Friis Formula

Friis transmission formula: $P_d = (P_{out} * G) / (4 * \pi * r^2)$

Where

P_d = power density in mW/cm²

P_{out} = output power to antenna in mW

G = gain of antenna in linear scale

π = 3.1416

R = distance between observation point and center of the radiator in cm

P_d is the limit of MPE, 1 mW/cm². If we know the maximum gain of the antenna and the total power input to the antenna, through the calculation, we will know the distance r where the MPE limit is reached.

4.2. Test Procedure

Software provided by client enabled the EUT to transmit and receive data at lowest, middle and highest channel individually.

The temperature and related humidity: 18°C and 78% RH.

4.3. Test Result of RF Exposure Evaluation

Product : Wireless LAN PC Card
 Test Item : RF Exposure Evaluation
 Test Site : No.1 OATS
 Test Mode : Normal Operation

Antenna Gain

Antenna Gain: The maximum Gain measured in fully anechoic chamber is 1dBi or 1.26 in linear scale.

Output Power Into Antenna & RF Exposure Evaluation Distance:

Channel	Channel Frequency (MHz)	Output Power to Antenna (mW)	Minimum Allowable Distance ® From Skin(cm)
1	2412.00	16.48	1.28
6	2437.00	11.91	1.09
11	2462.00	10.09	1.01

The distance r (4th column) calculated from the Fries transmission formula is far shorter than 20 cm separation requirement.

5. Radiated Emission

5.1. Test Equipment

The following test equipment are used during the radiated emission test:

Test Site	Equipment	Manufacturer	Model No./Serial No.	Last Cal.
Site # 1	X Test Receiver	R & S	ESCS 30 / 825442/14	May, 2002
	X Spectrum Analyzer	Advantest	R3261C / 71720140	May, 2002
	X Pre-Amplifier	HP	8447D/3307A01812	May, 2002
	X Bilog Antenna	Chase	CBL6112B / 12452	Sep., 2002
	X Horn Antenna	EM	EM6917 / 103325	May, 2002
Site # 2	Test Receiver	R & S	ESCS 30 / 825442/17	May, 2002
	Spectrum Analyzer	Advantest	R3261C / 71720609	May, 2002
	Pre-Amplifier	HP	8447D/3307A01814	May, 2002
	Bilog Antenna	Chase	CBL6112B / 2455	Sep., 2002
	Horn Antenna	EM	EM6917 / 103325	May, 2002

- Note:
1. All equipments that need to calibrate are with calibration period of 1 year.
 2. Mark "X" test instruments are used to measure the final test results.

5.2. Test Setup

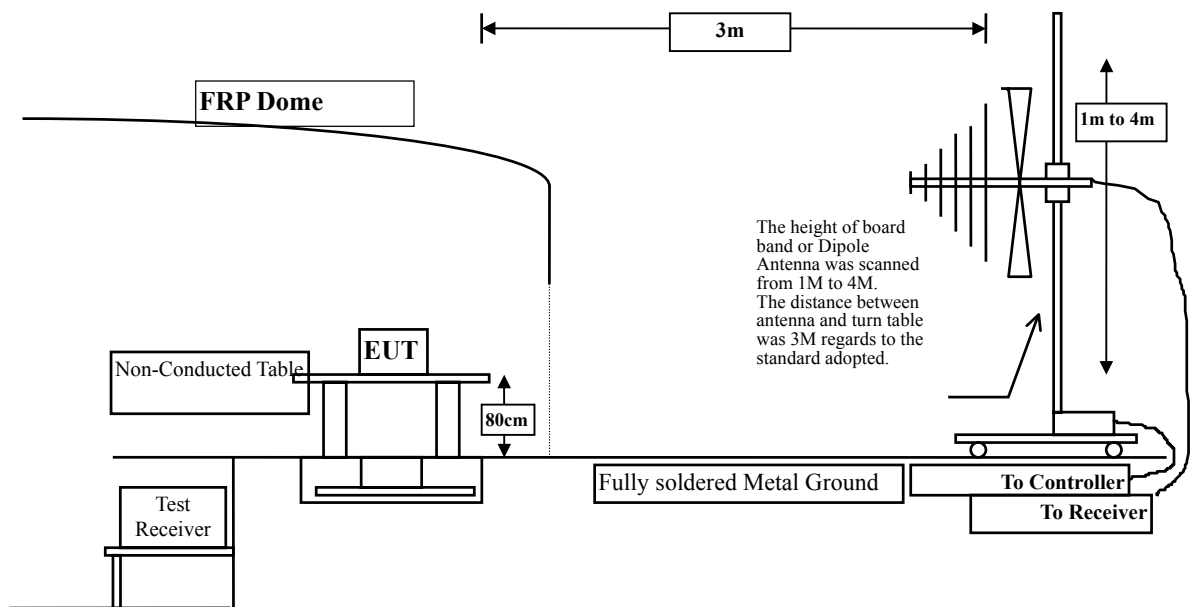

5.3. Limits

➤ **General Radiated Emission Limits**

Emissions radiated outside of the specified frequency bands, except for harmonics, shall be attenuated by at least 20dB below the level of the fundamental or to the general radiated emission limits in paragraph 15.209, whichever is the lesser attenuation.

FCC Part 15 Subpart C Paragraph 15.209 Limits		
Frequency MHz	uV/m @3m	dBuV/m@3m
30-88	100	40
88-216	150	43.5
216-960	200	46
Above 960	500	54

- Remarks :
1. RF Voltage (dBuV) = 20 log RF Voltage (uV)
 2. In the Above Table, the tighter limit applies at the band edges.
 3. Distance refers to the distance in meters between the measuring instrument antenna and the closed point of any part of the device or system.

5.4. Test Procedure

The EUT and its simulators are placed on a turn table which is 0.8 meter above ground. The turn table can rotate 360 degrees to determine the position of the maximum emission level.

The EUT was positioned such that the distance from antenna to the EUT was 3 meters.

The antenna can move up and down between 1 meter and 4 meters to find out the maximum emission level.

Both horizontal and vertical polarization of the antenna are set on measurement. In order to find the maximum emission, all of the interface cables must be manipulated according to ANSI C63.4:1992 on radiated measurement.

The additional latch filter below 1GHz was used to measure the level of harmonics radiated emission during field strength of harmonics measurement.

The bandwidth below 1GHz setting on the field strength meter (R&S Test Receiver ESCS 30)is 120 kHz, above 1GHz are 1 MHz.

The frequency range from 30MHz to 10th harmonics is checked.

5.5. Test Result of Radiated Emission

Product : Wireless LAN PC Card
 Test Item : Harmonic Radiated Emission
 Test Site : No.1 OATS
 Test Mode : Channel 1

Frequency	Cable	Probe	PreAMP	Reading	Emission	Margin	Limit
MHz	Loss	Factor	dB	Level	Level	dB	dBuV/m
	dB	dB/m		dBuV	dBuV/m		

Horizontal

Peak Detector:

4824.000	4.24	31.31	34.38	39.33	40.50	33.50	74.00
7236.100	5.63	36.54	34.94	38.70	< 45.93	28.07	74.00
9648.100	7.00	37.98	34.45	37.21	< 47.74	26.26	74.00

Vertical

Peak Detector:

4824.100	4.24	31.31	34.38	45.39	46.56	27.44	74.00
7236.000	5.63	36.54	34.94	39.30	< 46.53	27.47	74.00
9648.100	7.00	37.98	34.45	37.32	< 47.85	26.15	74.00

Note:

1. All Readings below 1GHz are Quasi-Peak, above are performed with peak and/or average measurements as necessary.
2. Receiver setting (Peak Detector) : RBW:1MHz; VBW:1MHz; Span:100MHz ◦
3. Receiver setting (AVG Detector) : RBW:1MHz; VBW:30Hz; Span:20MHz ◦
4. Emission Level = Reading Level + Probe Factor + Cable Loss – PreAMP.
5. The average measurement was not performed when the peak measured data under the limit of average detection. If the readings given are average, peak measurement should also be supplied.

Product : Wireless LAN PC Card
 Test Item : Harmonic Radiated Emission
 Test Site : No.1 OATS
 Test Mode : Channel 6

Frequency	Cable Loss	Probe Factor	PreAMP	Reading Level	Emission Level	Margin	Limit
MHz	dB	dB/m	dB	dBuV	dBuV/m	dB	dBuV/m

Horizontal

Peak Detector:

4874.000	4.27	31.37	34.37	37.65	38.93	35.07	74.00
7310.900	5.67	36.57	34.97	38.86	< 46.12	27.88	74.00
9748.200	7.07	38.13	34.31	37.22	< 48.11	25.89	74.00

Vertical

Peak Detector:

4873.900	4.27	31.37	34.37	42.46	43.74	30.26	74.00
7311.100	5.67	36.57	34.97	39.03	< 46.29	27.71	74.00
9748.100	7.07	38.13	34.31	38.43	< 49.32	24.68	74.00

Note:

1. All Readings below 1GHz are Quasi-Peak, above are performed with peak and/or average measurements as necessary.
2. Receiver setting (Peak Detector) : RBW:1MHz; VBW:1MHz; Span:100MHz ◦
3. Receiver setting (AVG Detector) : RBW:1MHz; VBW:30Hz; Span:20MHz ◦
4. Emission Level = Reading Level + Probe Factor + Cable Loss – PreAMP.
5. The average measurement was not performed when the peak measured data under the limit of average detection. If the readings given are average, peak measurement should also be supplied.

Product : Wireless LAN PC Card
 Test Item : Harmonic Radiated Emission
 Test Site : No.1 OATS
 Test Mode : Channel 11

Frequency	Cable	Probe	PreAMP	Reading	Emission	Margin	Limit
	Loss	Factor		Level	Level		
MHz	dB	dB/m	dB	dBuV	dBuV/m	dB	dBuV/m

Horizontal

Peak Detector:

4924.200	4.30	31.43	34.36	38.38	39.75	34.25	74.00
7385.900	5.72	36.58	35.02	38.56	< 45.85	28.15	74.00
9847.900	7.13	38.17	34.18	39.18	< 50.30	23.70	74.00

Vertical

Peak Detector:

4924.100	4.30	31.43	34.36	38.91	40.28	33.72	74.00
7386.100	5.72	36.58	35.02	37.50	< 44.79	29.21	74.00
9848.100	7.13	38.17	34.18	38.21	< 49.33	24.67	74.00

Note:

1. All Readings below 1GHz are Quasi-Peak, above are performed with peak and/or average measurements as necessary.
2. Receiver setting (Peak Detector) : RBW:1MHz; VBW:1MHz; Span:100MHz ◦
3. Receiver setting (AVG Detector) : RBW:1MHz; VBW:30Hz; Span:20MHz ◦
4. Emission Level = Reading Level + Probe Factor + Cable Loss – PreAMP.
5. The average measurement was not performed when the peak measured data under the limit of average detection. If the readings given are average, peak measurement should also be supplied.

Product : Wireless LAN PC Card
 Test Item : General Radiated Emission
 Test Site : No.1 OATS
 Test Mode : Channel 1

Frequency	Cable	Probe	PreAMP	Reading	Emission	Margin	Limit
MHz	Loss	Factor	dB	Level	Level	dB	dBuV/m
	dB	dB/m		dBuV	dBuV/m		

Horizontal

366.590	0.83	17.03	22.60	36.40	31.66	14.34	46.00
399.570	0.88	18.79	22.60	38.00	35.07	10.93	46.00
*621.700	1.21	23.36	22.60	34.60	36.57	9.43	46.00
699.300	1.32	23.99	22.60	30.60	33.31	12.69	46.00
723.550	1.36	24.15	22.60	33.40	36.31	9.69	46.00
995.150	1.76	25.87	22.60	28.20	33.23	20.77	54.00

Vertical

100.810	0.44	19.67	22.60	29.80	27.31	16.19	43.50
396.660	0.87	17.75	22.60	31.40	27.43	18.57	46.00
566.410	1.13	21.85	22.60	28.20	28.58	17.42	46.00
624.610	1.21	21.21	22.60	29.00	28.83	17.17	46.00
*896.210	1.62	23.84	22.60	29.00	31.86	14.14	46.00
996.120	1.76	25.21	22.60	30.60	34.97	19.03	54.00

Note:

1. All Readings below 1GHz are Quasi-Peak, above are performed with peak and/or average measurements as necessary.
2. “ * ”, means this data is the worst emission level.
3. Emission Level = Reading Level + Probe Factor + Cable Loss-PreAMP.

Product : Wireless LAN PC Card
 Test Item : General Radiated Emission
 Test Site : No.1 OATS
 Test Mode : Channel 6

Frequency	Cable	Probe	PreAMP	Reading	Emission	Margin	Limit
MHz	Loss	Factor	dB	Level	Level	dB	dBuV/m
	dB	dB/m		dBuV	dBuV/m		

Horizontal

368.530	0.83	17.15	22.60	36.60	31.98	14.02	46.00
398.600	0.88	18.76	22.60	35.60	32.63	13.37	46.00
*496.570	1.02	20.87	22.60	34.40	33.69	12.31	46.00
621.700	1.21	23.36	22.60	31.40	33.37	12.63	46.00
699.300	1.32	23.99	22.60	30.80	33.51	12.49	46.00
799.210	1.47	24.63	22.60	28.80	32.30	13.70	46.00

Vertical

395.690	0.87	17.71	22.60	31.80	27.78	18.22	46.00
500.450	1.03	20.12	22.60	31.00	29.54	16.46	46.00
568.350	1.13	21.83	22.60	28.00	28.36	17.64	46.00
623.640	1.21	21.22	22.60	28.40	28.24	17.76	46.00
679.900	1.30	21.33	22.60	28.60	28.63	17.37	46.00
*891.360	1.61	23.94	22.60	27.60	30.55	15.45	46.00

Note:

1. All Readings below 1GHz are Quasi-Peak, above are performed with peak and/or average measurements as necessary.
2. “ * ”, means this data is the worst emission level.
3. Emission Level = Reading Level + Probe Factor + Cable Loss-PreAMP.

Product : Wireless LAN PC Card
 Test Item : General Radiated Emission
 Test Site : No.1 OATS
 Test Mode : Channel 11

Frequency	Cable	Probe	PreAMP	Reading	Emission	Margin	Limit
MHz	Loss	Factor	dB	Level	Level	dB	dBuV/m
	dB	dB/m		dBuV	dBuV/m		

Horizontal

399.570	0.88	18.79	22.60	37.00	34.07	11.93	46.00
499.480	1.03	20.93	22.60	35.20	34.55	11.45	46.00
598.420	1.17	22.90	22.60	31.60	33.07	12.93	46.00
*622.670	1.21	23.38	22.60	33.60	35.59	10.41	46.00
696.390	1.32	23.97	22.60	31.40	34.09	11.91	46.00
798.240	1.47	24.62	22.60	31.00	34.49	11.51	46.00

Vertical

398.600	0.88	17.84	22.60	34.00	30.12	15.88	46.00
496.570	1.02	19.92	22.60	30.60	28.94	17.06	46.00
568.350	1.13	21.83	22.60	28.80	29.16	16.84	46.00
621.700	1.21	21.25	22.60	29.60	29.45	16.55	46.00
*805.030	1.48	23.50	22.60	30.20	32.58	13.42	46.00
997.090	1.77	25.23	22.60	29.80	34.20	19.80	54.00

Note:

1. All Readings below 1GHz are Quasi-Peak, above are performed with peak and/or average measurements as necessary.
2. “ * ”, means this data is the worst emission level.
3. Emission Level = Reading Level + Probe Factor + Cable Loss-PreAMP.

6. Band Edge

6.1. Test Equipment

The following test equipments are used during the band edge tests:

Equipment	Manufacturer	Model No./Serial No.	Last Cal.
X Spectrum Analyzer	Advantest	R3272 / 72421194	May, 2002
X Test Receiver	R & S	ESCS 30 / 825442/14	May, 2002
X Spectrum Analyzer	Advantest	R3261C / 71720140	May, 2002
X Pre-Amplifier	HP	8447D/3307A01812	May, 2002
X Bilog Antenna	Chase	CBL6112B / 12452	Sep., 2002
X Horn Antenna	EM	EM6917 / 103325	May, 2002

- Note: 1. All equipments that need to calibrate are with calibration period of 1 year.
 2. Mark "X" test instruments are used to measure the final test results.

6.2. Test Setup

RF Conducted Measurement:

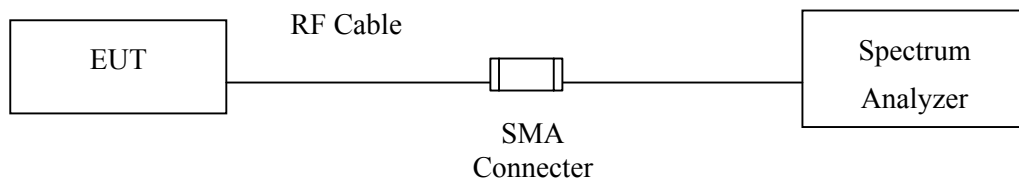

RF Radiated Measurement:

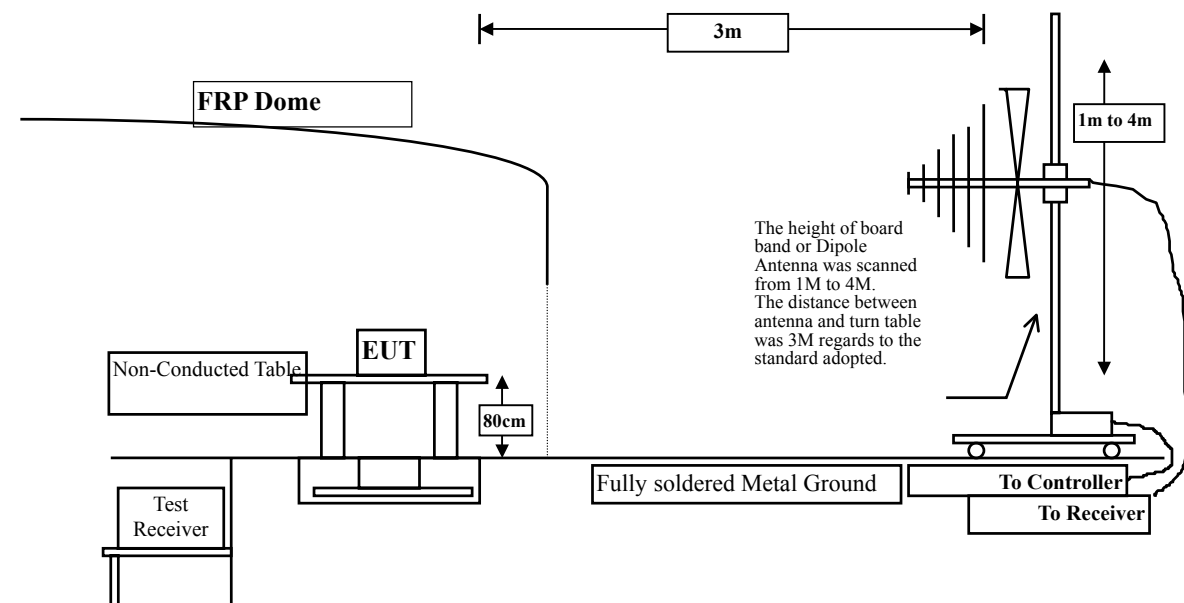

6.3. Limits

In any 100 kHz bandwidth outside the frequency band in which the spread spectrum intentional radiator is operating, the radio frequency power that is produced by the intentional radiator shall be at least 20 dB below that in the 100 kHz bandwidth within the band that contains the highest level of the desired power, based on either an RF conducted or a radiated measurement. Attenuation below the general limits specified in Section 15.209(a) is not required. In addition, radiated emissions which fall in the restricted bands, as defined in Section 15.205(a), must also comply with the radiated emission limits specified in Section 15.209(a) (see Section 15.205(c)).

6.4. Test Procedure

The EUT and its simulators are placed on a turn table which is 0.8 meter above ground. The turn table can rotate 360 degrees to determine the position of the maximum emission level. The EUT was positioned such that the distance from antenna to the EUT was 3 meters.

The antenna can move up and down between 1 meter and 4 meters to find out the maximum emission level.

Both horizontal and vertical polarization of the antenna are set on measurement. In order to find the maximum emission, all of the interface cables must be manipulated according to ANSI C63.4:1992 on radiated measurement.

The bandwidth below 1GHz setting on the field strength meter (R&S Test Receiver ESCS 30)is 120 kHz, above 1GHz are 1 MHz.

6.5. Test Result of Band Edge

Product : Wireless LAN PC Card
 Test Item : Band Edge
 Test Site : No.1 OATS
 Test Mode : Channel 1

RF Radiated Measurement:

Channel No.	Frequency (MHz)	Required Limit (dBc)	Result
1 (Horizontal)	<2400	>20	Pass
1 (Vertical)	<2400	>20	Pass

Figure Channel 1: (Horizontal)

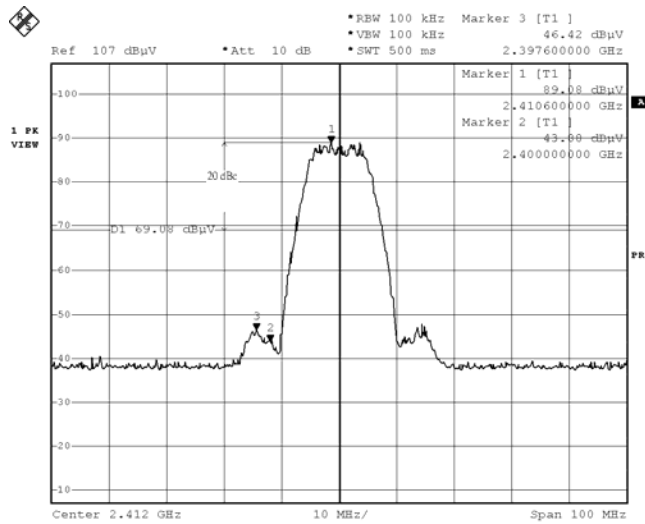

Date: 9.APR.2003 11:17:10

Figure Channel 1: (Vertical)

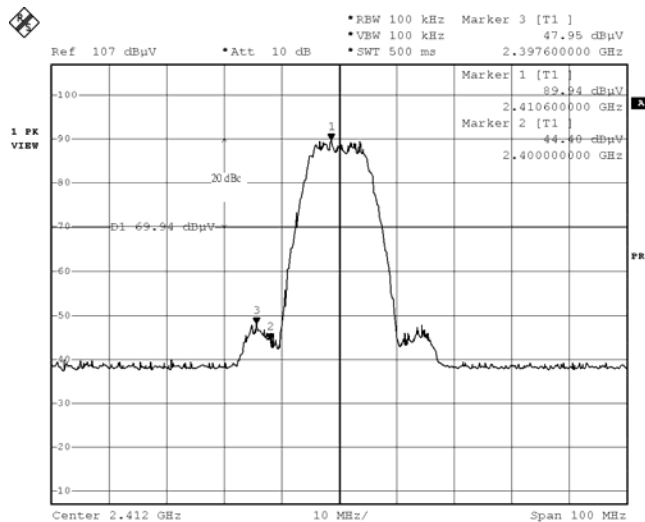

Date: 9.APR.2003 11:20:41

Product : Wireless LAN PC Card
 Test Item : Band Edge
 Test Site : No.1 OATS
 Test Mode : Channel 11

RF Radiated Measurement: (Peak Detector)

Channel No.	Frequency (MHz)	Reading Level (dBuV)	Probe Factor (dB/m)	Cable Loss (dB)	PreAMP (dB)	Emission Level (dBuV/m)	Limit (dBuV/m)	Result
11(Horizontal)	2485.00	42.00	27.58	2.90	34.58	37.90	74	Pass
11 (Vertical)	2492.80	42.14	27.58	2.91	34.56	38.07	74	Pass

Figure Channel 11:

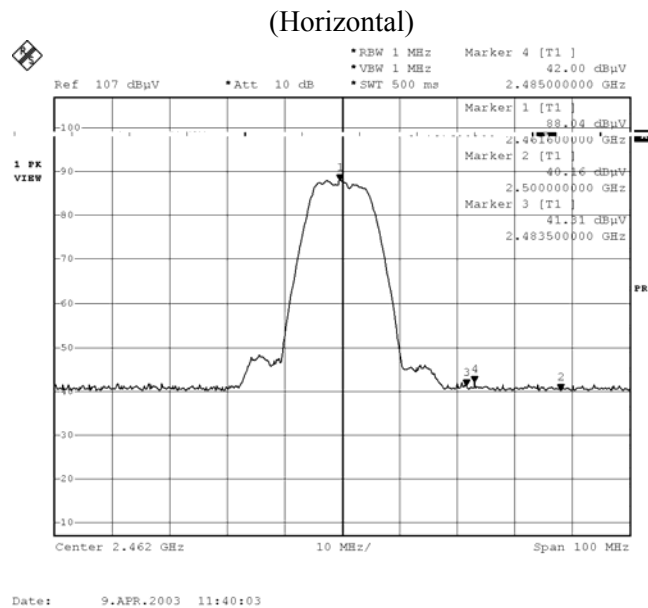
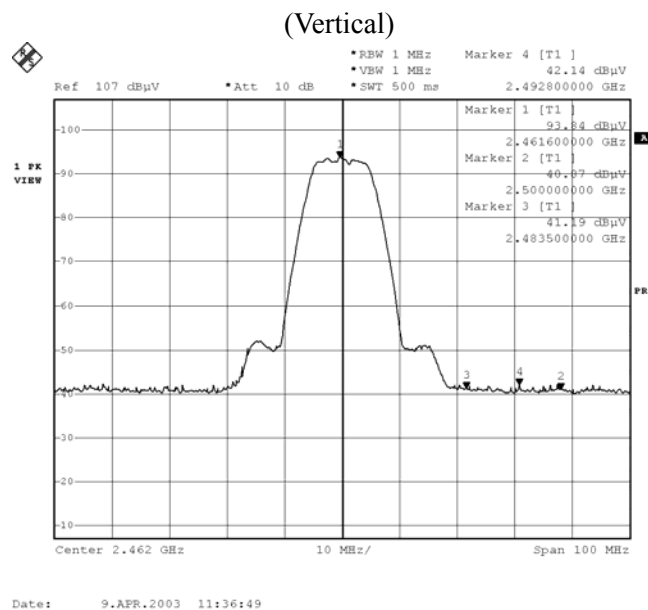

Figure Channel 11:



Note: The average measurement was not performed when the peak measured data under the limit of average detection. If the readings given are average, peak measurement should also be supplied.

7. Occupied Bandwidth

7.1. Test Equipment

The following test equipments are used during the radiated emission tests:

	Equipment	Manufacturer	Model No./Serial No.	Last Cal.
X	Spectrum Analyzer	Advantest	R3272 / 72421194	May, 2002

Note: 1. All equipment upon which need to calibrated are with calibration period of 1 year.
 2. Mark "X" test instruments are used to measure the final test results.

7.2. Test Setup

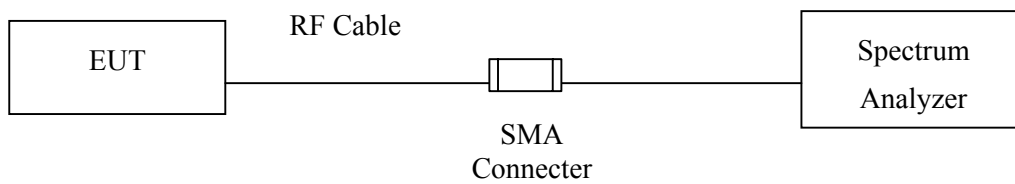

7.3. Limits

The minimum 6dB bandwidth shall be at least 500kHz.

7.4. Test Result of Occupied Bandwidth

Product : Wireless LAN PC Card
 Test Item : Occupied Bandwidth
 Test Site : No.1 OATS
 Test Mode : Normal Operation

Channel No.	Frequency (MHz)	Measurement Level (kHz)	Required Limit (kHz)	Result
1	2412	10600	>500	Pass
6	2437	10600	>500	Pass
11	2462	10600	>500	Pass

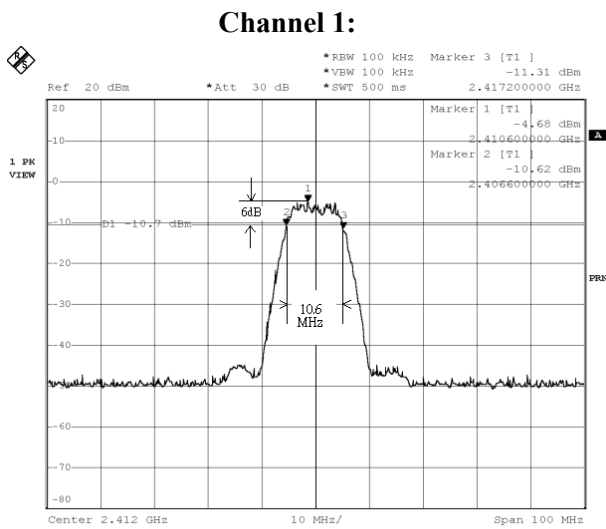

Date: 9.APR.2003 15:22:52

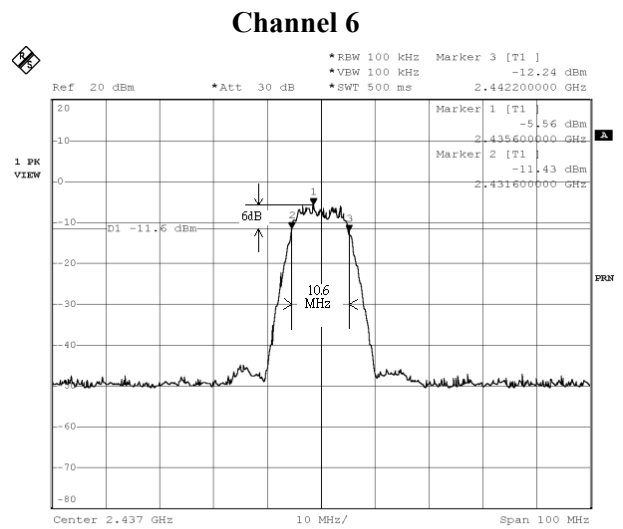

Date: 9.APR.2003 15:24:12

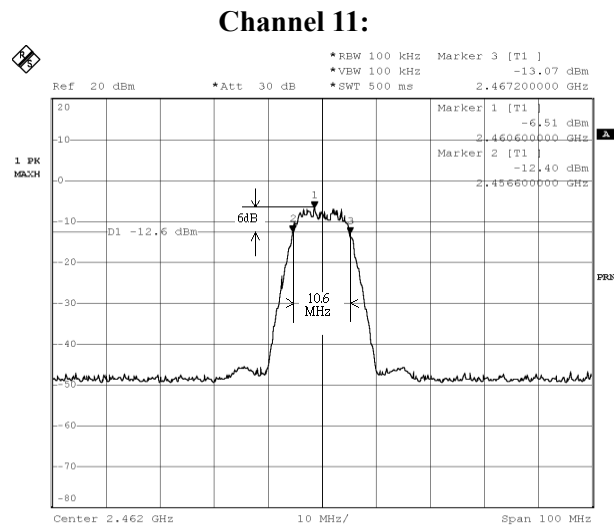

Date: 9.APR.2003 15:33:39

8. Power Density

8.1. Test Equipment

The following test equipments are used during the radiated emission tests:

Equipment	Manufacturer	Model No./Serial No.	Last Cal.
X Spectrum Analyzer	Advantest	R3272 / 72421194	May, 2002

Note: 1. All equipment upon which need to calibrated are with calibration period of 1 year.
 2. Mark "X" test instruments are used to measure the final test results.

8.2. Test Setup

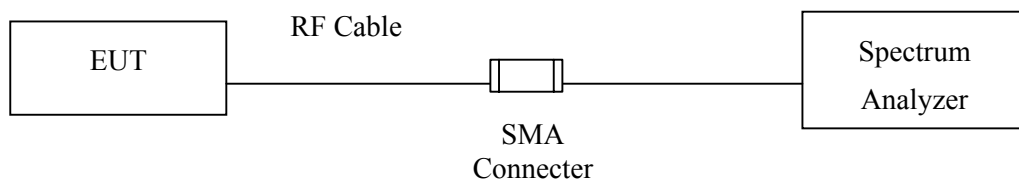

8.3. Limits

The transmitted power density averaged over any 1 second interval shall not be greater +8dBm in any 3kHz bandwidth.

8.4. Test Result of Power Density

Product : Wireless LAN PC Card
 Test Item : Power Density
 Test Site : No.1 OATS
 Test Mode : Normal Operation

Channel No.	Frequency (MHz)	Measurement Level (dBm)	Required Limit (dBm)	Result
1	2411.973	-17.36	< 8dBm	Pass
6	2436.973	-17.97	< 8dBm	Pass
11	2461.9724	-18.45	< 8dBm	Pass

Channel 1:

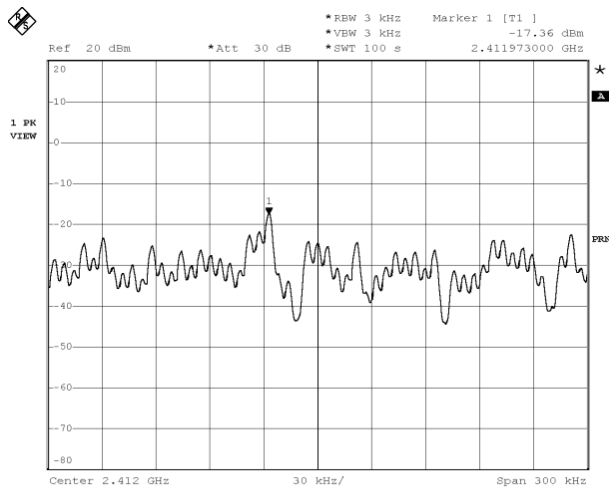

Date: 9.APR.2003 10:04:34

Channel 6

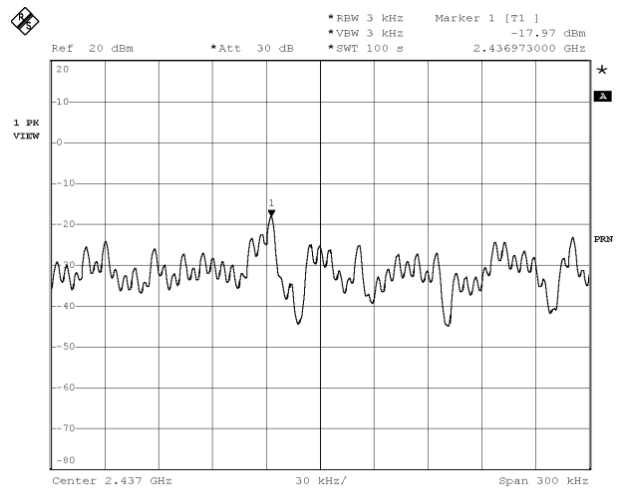

Date: 9.APR.2003 10:01:40

Channel 11:

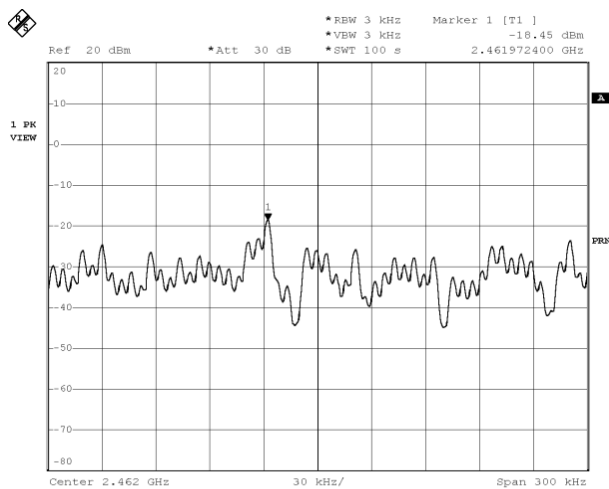

Date: 9.APR.2003 10:15:34

9. EMI Reduction Method During Compliance Testing

No modification was made during testing.

Attachment 1: EUT Test Photographs

Attachment 1: EUT Test Setup Photographs

Front View of Conducted Test



Back View of Conducted Test



Front View of Radiated Test



Back View of Radiated Test



Front View of Radiated Test (Horn)



Attachment 2: EUT Detailed Photographs

Attachment 2 : EUT Detailed Photographs

(1) EUT Photo



(2) EUT Photo



(3) EUT Photo



(4) EUT Photo



(5) EUT Photo

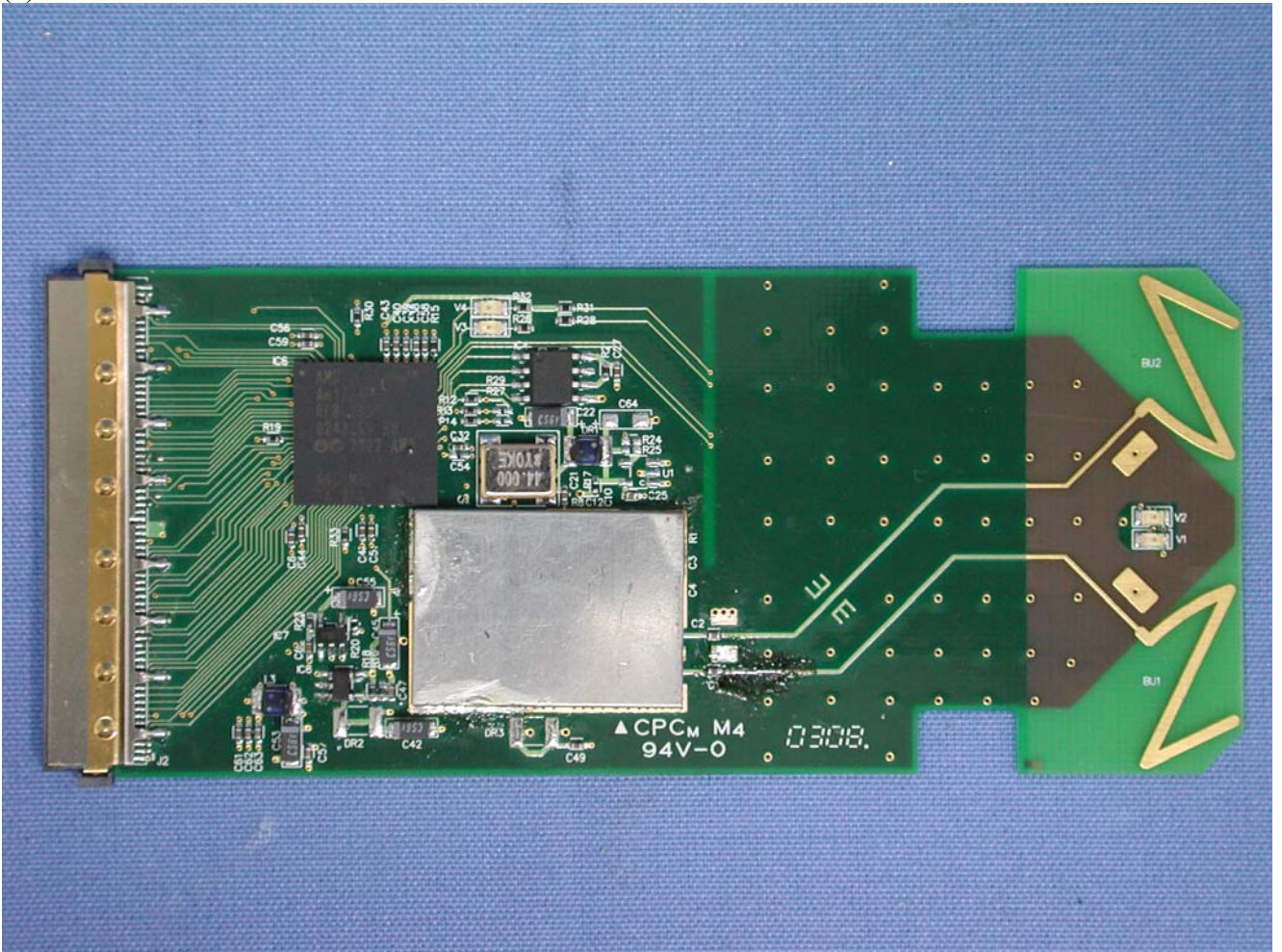

(6) EUT Photo

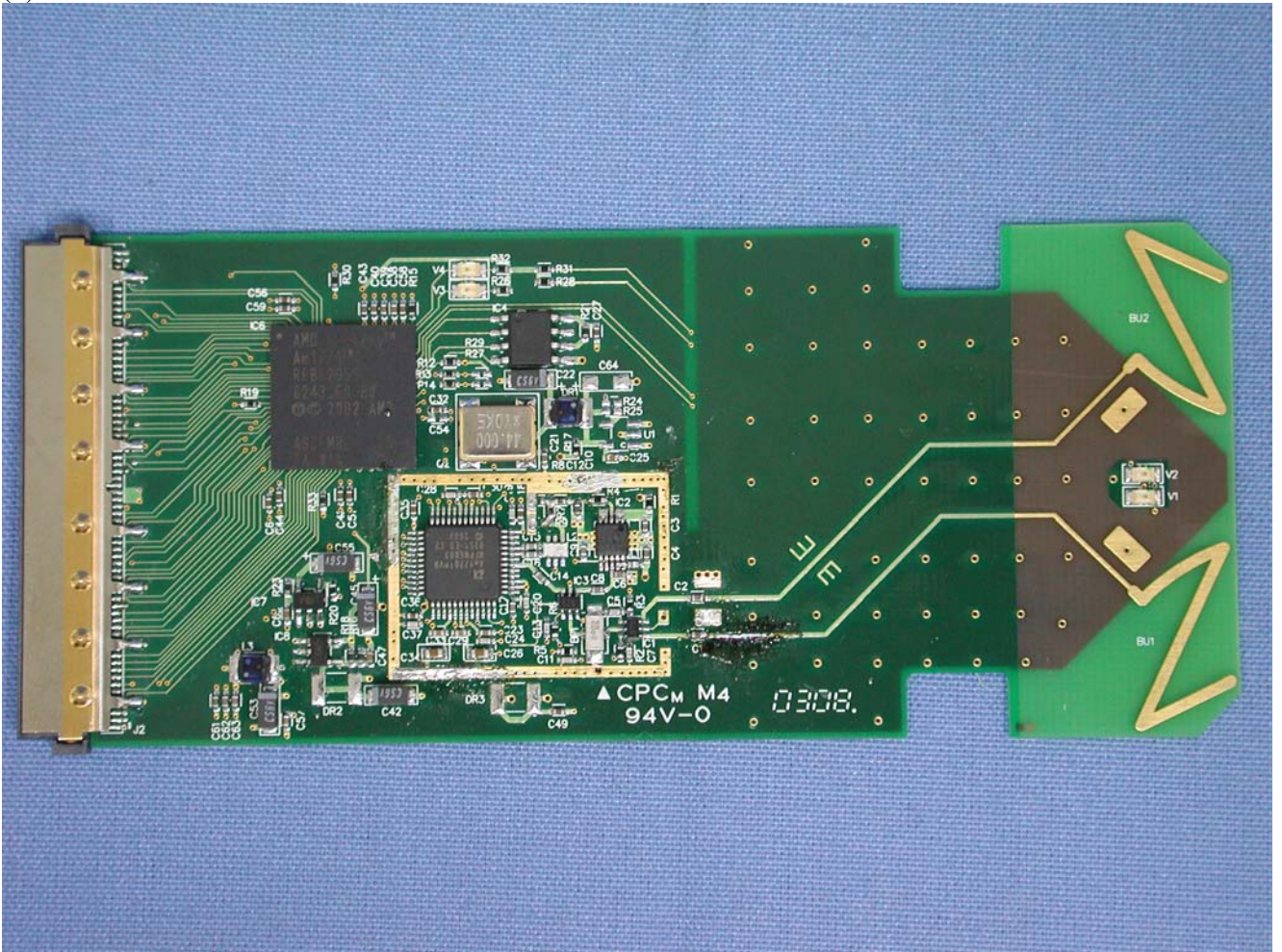

(7) EUT Photo

