



Test Report

Product Name : Wireless LAN PCMCIA Card

Model No. : WP221P-X

FCC ID.: PQP-WP221P-X

Applicant : PRIME ELECTRONICS & SATELLITICS INC.

Address : 69, Tung-Yuan Rd., Chung-Li Industrial Park,
Chung-Li City, Taoyuan, Taiwan.

Date of Receipt : Mar. 06, 2002

Date of Test : May 22, 2002

Report No. : 025H015FI

The Test Results relate only to the samples tested.

The test report shall not be reproduced except in full without the written approval of Quietek Corporation.

This report must not be used to claim product endorsement by NVLAP any agency of the U.S. Government

Test Report Certification

Test Date : May 22, 2002

Report No. : 025H015FI



Accredited by NIST (NVLAP)
NVLAP Lab Code: 200347-0

Product Name : Wireless LAN PCMCIA Card

Applicant : PRIME ELECTRONICS & SATELLITICS INC.

Address : 69, Tung-Yuan Rd., Chung-Li Industrial Park,
Chung-Li City, Taoyuan, Taiwan.

Manufacturer : PRIME ELECTRONICS & SATELLITICS INC.

Model No. : WP221P-X

FCC ID. : PQP-WP221P-X

Rated Voltage : DC 3.3V (Power by PC)

Trade Name : PESI

Measurement Standard : FCC Part 15 Subpart C Paragraph 15.247

Measurement Procedure : ANSI C63.4:1992

Test Result : Complied



The Test Results relate only to the samples tested.

The test report shall not be reproduced except in full without the written approval of Quietek Corporation.

This report must not be used to claim product endorsement by NVLAP any agency of the U.S. Government

Documented By : Zoe Lee
(Zoe Lee)

Tested By : Sean Chang
(Sean Chang)

Approved By : Kevin Wang
(Kevin Wang)

TABLE OF CONTENTS

Description	Page
1. GENERAL INFORMATION.....	5
1.1. EUT Description.....	5
1.2. Operational Description	5
1.3. Tested System Details.....	6
1.4. Configuration of tested System	7
1.5. EUT Exercise Software	7
1.6. Test Facility	8
2. Conducted Emission.....	9
2.1. Test Equipment.....	9
2.2. Test Setup	9
2.3. Limits	9
2.4. Test Procedure	10
2.5. Test Result of Conducted Emission.....	11
3. Peak Power Output	12
3.1. Test Equipment.....	12
3.2. Test Setup	12
3.3. Test Condition	12
3.4. Limit	12
3.5. Test Result of Peak Power Output.....	13
4. RF Exposure Evaluation.....	14
4.1. Friis Formula	14
4.2. EUT Operation condition	14
4.3. Test Result of RF Exposure Evaluation.....	15
5. Radiated Emission.....	16
5.1. Test Equipment.....	16
5.2. Test Setup	16
5.3. Limits	17
5.4. Test Procedure	17
5.5. Test Result of Radiated Emission.....	18
6. Band Edge	30
6.1. Test Equipment.....	30
6.2. Test Setup	30
6.3. Test Condition	31
6.4. Limit	31
6.5. Test Procedure	31
6.6. Test Result of Band Edge	32
7. Occupied Bandwidth.....	38
7.1. Test Equipment.....	38
7.2. Test Setup	38
7.3. Test Condition	38
7.4. Limit	38
7.5. Test Result of Occupied Bandwidth	39

8.	Transmitter Power Density.....	42
8.1.	Test Equipment.....	42
8.2.	Test Setup.....	42
8.3.	Test Condition.....	42
8.4.	Limit.....	42
8.5.	Test Result of Transmitter Power Density.....	43
9.	Processing Gain.....	46
9.1.	Test Condition.....	46
9.2.	Limit.....	46
9.3.	Test Result of Processing Gain.....	47
10.	EMI Reduction Method During Compliance Testing.....	48
Attachment 1:	EUT Test Photographs	
Attachment 2:	EUT Detailed Photographs	

1. GENERAL INFORMATION

1.1. EUT Description

Product Name : Wireless LAN PCMCIA Card
 Trade Name : PESI
 FCC ID. : PQP-WP221P-X
 Model No. : WP221P-X
 Frequency Range : 2412MHz to 2462MHz
 Channel Number : 11
 Chip Rate : 1Mbps, 2Mbps, 5.5Mbps, 11Mbps
 Type of Modulation : Direct Sequence Spread Spectrum
 Antenna type : Printed
 Operator Selection of Operating Frequency : By Auto

Frequency of Each Channel:

Channel	Frequency	Channel	Frequency	Channel	Frequency
Channel 1:	2412 MHz	Channel 2:	2417 MHz	Channel 3:	2422 MHz
Channel 4:	2427 MHz	Channel 5:	2432 MHz	Channel 6:	2437 MHz
Channel 7:	2442 MHz	Channel 8:	2447 MHz	Channel 9:	2452 MHz
Channel 10:	2457 MHz	Channel 11:	2462 MHz		

Note:

1. This device is a 2.4GHz Wireless LAN PCMCIA Card interface included a 2.4GHz receiving function, a 2.4GHz transmitting function for the desktop/ laptop computers. Direct Sequence device with 11 channels..
3. Regards to the frequency band operation; two rate that were included the lowest , middle and highest frequency of channel were selected to perform the test, then shown on this report.
4. These tests were conducted on a sample of the equipment for the purpose of demonstrating compliance with Part 15 Subpart C Paragraph 15.247 for spread spectrum devices.
5. This device is a composite device in accordance with Part 15 regulations. The function receiving was measured and made a test report that the report number is 025015HF under Declaration of Conformity.

1.2. Operational Description

EUT is an USB interface 2.4GHz wireless LAN with 11 channels. This device provided four kind of transmitting speed 1,2,5.5 and 11Mbps. The device of RF carrier is DQPSK, DB PSK and CCK.

The device adapts direct sequence spread spectrum modulation. The Printer antenna printed on PCB provides diversity function to improve the receiving function. Data can be transmitted by the radio signal connect to the Internet or Local network.

1.3. Tested System Details

The types for all equipment, plus descriptions of all cables used in the tested system (including inserted cards) are:

	Product	Manufacturer	Model No.	Serial No.	Power Cord
(1)	Monitor	VIEWSONIC	VCDTS21490-1P	ERO1502850	Non-shielded,1.8m
(2)	Keyboard	HP	5181	BD12900515	--
(3)	Notebook	DELL	PP01L	2724903568	Non-shielded,1.8m
(4)	USB Mouse	Logitech	M-UE55	LTC93813276	--
(5)	Printer	HP	C2642A	MY75L1D2XN	Non-Shielded,0.7m
(6)	Modem	ACEEX	2814	960018054	--
(7)	Headphone	beethoven	N/A	N/A	--

	Signal Cable Type	Signal cable Description
A.	VGA Cable	Shielded, 1.6m
B.	Keyboard Cable	Shielded, 1.8m
C.	USB Mouse Cable	Shielded, 1.0m
D.	Printer Cable	Shielded, 1.2m
E.	Head phone Cable	Non-shielded
F.	Modem Cable	Shielded, 1.5m

1.4. Configuration of tested System

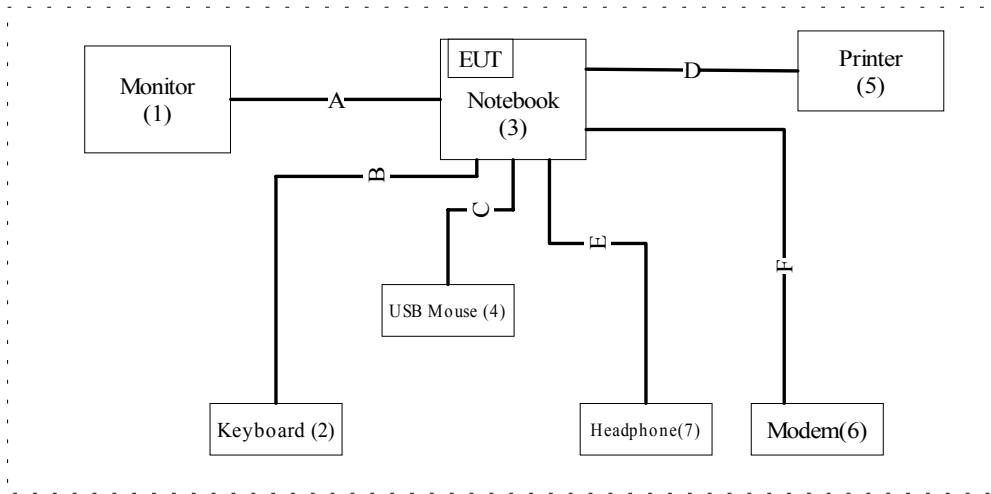

1.5. EUT Exercise Software

- 1.5.1 Setup the EUT and simulators as shown on 1.4.
- 1.5.2 Turn on the power of all equipment.
- 1.5.3 Notebook PC reads data from disk.
- 1.5.4 Data will be transmitting through EUT.
- 1.5.5 The transmitted status will be shown on the monitor.
- 1.5.6 Repeat the above procedure 1.5.4 to 1.5.5

1.6. Test Facility

Ambient conditions in the laboratory:

Items	Required (IEC 68-1)	Actual
Temperature (°C)	15-35	20-35
Humidity (%RH)	25-75	50-65
Barometric pressure (mbar)	860-1060	950-1000

Site Description: November 3, 1998 File on
 Federal Communications Commission
 FCC Engineering Laboratory
 7435 Oakland Mills Road
 Columbia, MD 21046
 Reference 31040/SIT1300F2
 August 30, 2001 Accreditation on NVLAP
 NVLAP Lab Code: 200347-0



Site Name: Quietek Corporation

Site Address: No.75-1, Wang-Yeh Valley, Yung-Hsing,
 Chiung-Lin, Hsin-Chu County,
 Taiwan, R.O.C.
 TEL : 886-3-592-8858 / FAX : 886-3-592-8859
 E-Mail: service@quietek.com

2. Conducted Emission

2.1. Test Equipment

The following test equipment are used during the conducted emission test:

Item	Instrument	Manufacturer	Type No./Serial No	Last Cal.	Remark
1	Test Receiver	R & S	ESCS 30/825442/17	May, 2002	
2	L.I.S.N.	R & S	ESH3-Z5/825016/6	May, 2002	EUT
3	L.I.S.N.	Kyoritsu	KNW-407/8-1420-3	May, 2002	Peripherals
4	Pulse Limiter	R & S	ESH3-Z2	N/A	
5	No.2 Shielded Room			N/A	

Note: All equipment upon which need to calibrated are with calibration period of 1 year.

2.2. Test Setup

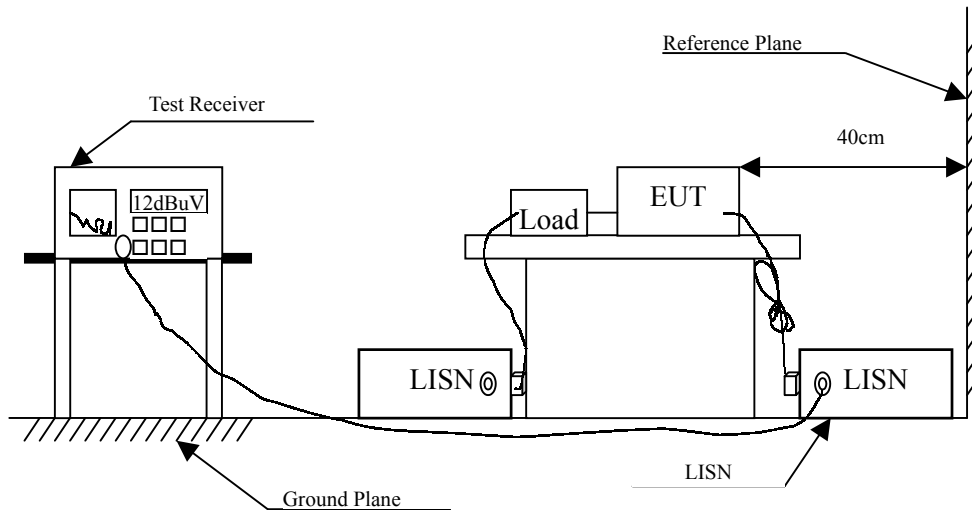

2.3. Limits

FCC Part 15 Paragraph 15.207 (dBuV)		
Frequency MHz	Limits	
	uV	dBuV
0.45 - 30	250	48.0

2.4. Test Procedure

The EUT and simulators are connected to the main power through a line impedance stabilization network (L.I.S.N.). This provides a 50 ohm /50uH coupling impedance for the measuring equipment. The peripheral devices are also connected to the main power through a LISN that provides a 50ohm/50uH coupling impedance with 50ohm termination. (Please refers to the block diagram of the test setup and photographs.)

Both sides of A.C. line are checked for maximum conducted interference. In order to find the maximum emission, the relative positions of equipment and all of the interface cables must be changed according to ANSI C63.4:1992 on conducted measurement.

Conducted emissions were investigated over the frequency range from 0.45MHz to 30MHz using a receiver bandwidth of 9kHz.

2.5. Test Result of Conducted Emission

Product : Wireless LAN PCMCIA Card
 Test Item : Conducted Emission Test
 Test Site : No.2 Shielded Room
 Test Mode : Normal Operation

Frequency	Cable	LISN	Reading Level	Emission Level	Limits
MHz	Loss	Factor	dBuV	dBuV	dBuV
	dB	dB			
Line 1					
Quasi-Peak:					
* 0.497	0.06	0.21	37.77	38.05	48.00
0.696	0.08	0.25	33.46	33.79	48.00
1.009	0.10	0.28	19.86	20.24	48.00
2.185	0.15	0.35	21.02	21.52	48.00
3.907	0.18	0.41	29.33	29.92	48.00
22.184	0.37	0.57	31.56	32.50	48.00
Line 2					
Quasi-Peak:					
0.473	0.06	0.21	26.47	26.74	48.00
0.772	0.09	0.26	31.59	31.93	48.00
0.949	0.10	0.27	20.85	21.22	48.00
2.134	0.15	0.35	23.56	24.06	48.00
2.432	0.15	0.36	24.89	25.41	48.00
* 21.942	0.37	0.57	32.56	33.50	48.00

Remarks :

1. All Readings below 1GHz are Quasi-Peak value.
2. “ * ” means that this data is the worst emission level.
3. Emission Level = Reading Level + LISN Factor + Cable loss

3. Peak Power Output

3.1. Test Equipment

The following test equipments are used during the radiated emission tests:

	Equipment	Manufacturer	Model No./Serial No.	Last Cal.
X	Spectrum Analyzer	Advantest	R3272 / 72421194	May, 2002

Note: 1. All equipment upon which need to calibrated are with calibration period of 1 year.
 2. Mark "X" test instruments are used to measure the final test results.

3.2. Test Setup

Conduction Power Measurement

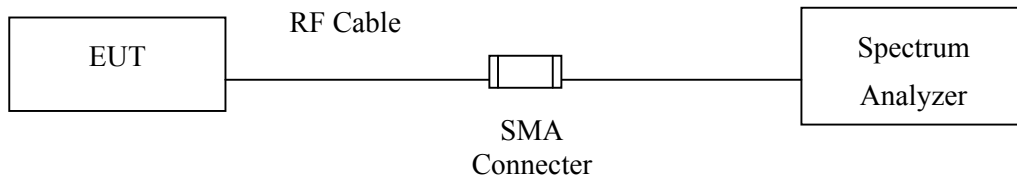

3.3. Test Condition

Standard Temperature and Humidity, Standard Test Voltage

3.4. Limit

The maximum peak power shall be less 1 Watt.

3.5. Test Result of Peak Power Output

Product : Wireless LAN PCMCIA Card
 Test Item : Peak Power Output Data
 Test Site : No.1 OATS
 Test Mode : Normal Operation

Data Speed: 1Mbps

Channel No.	Frequency (MHz)	Measurement (dBm)	Required Limit	Result
1	2412	8.15	1 Watt= 30 dBm	Pass
6	2437	7.28	1 Watt= 30 dBm	Pass
11	2462	6.29	1 Watt= 30 dBm	Pass

Data Speed: 11Mbps

Channel No.	Frequency (MHz)	Measurement (dBm)	Required Limit	Result
1	2412	9.65	1 Watt= 30 dBm	Pass
6	2437	7.30	1 Watt= 30 dBm	Pass
11	2462	6.30	1 Watt= 30 dBm	Pass

4. RF Exposure Evaluation

According to FCC 1.1310: The criteria listed in the following table shall be used to evaluate the environment impact of human exposure to radio frequency (RF) radiation as specified in 1.1307(b)

LIMITS FOR MAXIMUM PERMISSIBLE EXPOSURE (MPE)

Frequency Range (MHz)	Electric Field Strength (V/m)	Magnetic Field Strength (A/m)	Power Density (mW/cm ²)	Average Time (Minutes)
(A) Limits for Occupational/ Control Exposures				
300-1500	--	--	F/300	6
1500-100,000	--	--	5	6
(B) Limits for General Population/ Uncontrolled Exposures				
300-1500	--	--	F/1500	6
1500-100,000	--	--	1	30

F= Frequency in MHz

4.1. Friis Formula

Friis transmission formula: $P_d = (P_{out} * G) / (4 * \pi * r^2)$

Where

P_d = power density in mW/cm²

P_{out} = output power to antenna in mW

G = gain of antenna in linear scale

π = 3.1416

R = distance between observation point and center of the radiator in cm

P_d is the limit of MPE, 1 mW/cm². If we know the maximum gain of the antenna and the total power input to the antenna, through the calculation, we will know the distance r where the MPE limit is reached.

4.2. EUT Operation condition

A software provided by client enabled the EUT to transmit and receive data at lowest, middle and highest channel individually.

4.3. Test Result of RF Exposure Evaluation

Product : Wireless LAN PCMCIA Card
 Test Item : RF Exposure Evaluation Data
 Test Site : No.1 OATS
 Test Mode : Normal Operation

4.3.1 Antenna Gain

Antenna Gain: The maximum Gain measured in fully anechoic chamber is 2dBi .

4.3.2 Output Power Into Antenna & RF Exposure Evaluation Distance

Channel	Channel Frequency (MHz)	Output Power to Antenna (mW)	Minimum Allowable Distance ® From Skin(cm)
1 (1Mbps)	2412	6.53	0.91
1 (11Mbps)	2412	9.23	1.08
6 (1Mbps)	2437	5.35	0.82
6 (11Mbps)	2437	5.37	0.82
11 (1Mbps)	2462	4.26	0.73
11 (11Mbps)	2462	4.27	0.73

The distance r (4th column) calculated from the Friis transmission formula is far shorter than 20 cm separation requirement. So, RF exposure limit warning or SAR test are not required.

5. Radiated Emission

5.1. Test Equipment

The following test equipment are used during the radiated emission test:

Test Site	Equipment	Manufacturer	Model No./Serial No.	Last Cal.
Site # 1	X Test Receiver	R & S	ESCS 30 / 825442/14	May, 2002
	X Spectrum Analyzer	Advantest	R3261C / 71720140	May, 2002
	X Pre-Amplifier	HP	8447D/3307A01812	May, 2002
	X Bilog Antenna	Chase	CBL6112B / 12452	Sep., 2001
	X Horn Antenna	EM	EM6917 / 103325	May, 2002
Site # 2	Test Receiver	R & S	ESCS 30 / 825442/17	May, 2002
	Spectrum Analyzer	Advantest	R3261C / 71720609	May, 2002
	Pre-Amplifier	HP	8447D/3307A01814	May, 2002
	Bilog Antenna	Chase	CBL6112B / 2455	Sep., 2001
	Horn Antenna	EM	EM6917 / 103325	May, 2001

- Note:
1. All equipments that need to calibrate are with calibration period of 1 year.
 2. Mark "X" test instruments are used to measure the final test results.

5.2. Test Setup

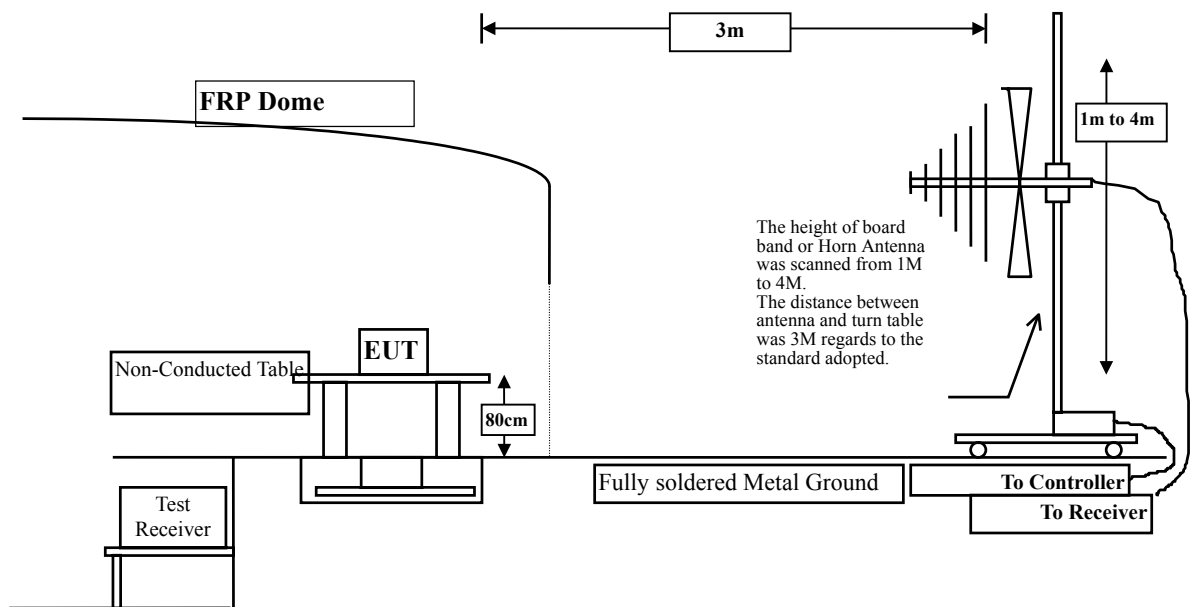

5.3. Limits

➤ General Radiated Emission Limits

Emissions radiated outside of the specified frequency bands, except for harmonics, shall be attenuated by at least 20dB below the level of the fundamental or to the general radiated emission limits in paragraph 15.209, whichever is the lesser attenuation.

FCC Part 15 Subpart C Paragraph 15.209(a) Limits		
Frequency MHz	uV/m @3m	dBuV/m@3m
30-88	100	40
88-216	150	43.5
216-960	200	46
Above 960	500	54

Remarks :

1. RF Voltage (dBuV) = 20 log RF Voltage (uV)
2. In the Above Table, the tighter limit applies at the band edges.
3. Distance refers to the distance in meters between the measuring instrument antenna and the closed point of any part of the device or system.

5.4. Test Procedure

The EUT and its simulators are placed on a turn table which is 0.8 meter above ground. The turn table can rotate 360 degrees to determine the position of the maximum emission level. The EUT was positioned such that the distance from antenna to the EUT was 3 meters.

The antenna can move up and down between 1 meter and 4 meters to find out the maximum emission level.

Both horizontal and vertical polarization of the antenna are set on measurement. In order to find the maximum emission, all of the interface cables must be manipulated according to ANSI C63.4:1992 on radiated measurement.

The additional latch filter below 1GHz was used to measure the level of harmonics radiated emission during field strength of harmonics measurement.

The bandwidth below 1GHz setting on the field strength meter (R&S Test Receiver ESCS 30)is 120 kHz, above 1GHz are 1 MHz.

The frequency range from 30MHz to 10th harmonics is checked.

5.5. Test Result of Radiated Emission

Product : Wireless LAN PCMCIA Card
 Test Item : Harmonic Radiated Emission Data
 Test Site : No.1 OATS
 Test Mode : Channel 1(1Mbps)

Freq.	Cable Loss	Probe Factor	PreAMP	Reading Level	Emission Level	Margin	Limit
MHz	dB	dB/m	dB	dBuV	dBuV/m	dB	dBuV/m

Horizontal

Peak Detector

4823.820	3.76	33.50	34.68	40.00	42.58	31.42	74.00
7235.720	4.87	36.24	34.97	37.48	< 43.62	30.38	74.00
9647.600	5.61	37.43	35.10	33.50	< 41.43	32.57	74.00

Vertical

Peak Detector

4824.020	3.76	33.50	34.68	38.42	41.00	33.00	74.00
7236.020	4.87	36.24	34.97	37.03	< 43.17	30.83	74.00
9648.100	5.61	37.43	35.10	34.35	< 42.28	31.72	74.00

Note:

1. All Readings below 1GHz are Quasi-Peak, above are average value.
2. Emission Level = Reading Level + Probe Factor + Cable loss -PreAMP.
3. The average measurement was not performed when the peak measured data under the limit of average detection.

Product : Wireless LAN PCMCIA Card
 Test Item : Harmonic Radiated Emission Data
 Test Site : No.1 OATS
 Test Mode : Channel 6(1Mbps)

Freq.	Cable	Probe	PreAMP	Reading	Emission	Margin	Limit
MHz	Loss	Factor	dB	Level	Level	dB	dBuV/m
	dB	dB/m		dBuV	dBuV/m		

Horizontal

Peak Detector

4874.070	3.78	33.56	34.69	39.03	41.68	32.32	74.00
7311.320	4.89	36.31	34.99	36.74	< 42.94	31.06	74.00
9747.900	5.67	37.45	35.10	36.02	< 44.03	29.97	74.00

Vertical

Peak Detector

4873.970	3.78	33.56	34.69	36.88	39.53	34.47	74.00
7310.870	4.89	36.31	34.99	36.34	< 42.54	31.46	74.00
9748.250	5.67	37.45	35.10	35.55	< 43.56	30.44	74.00

Note:

1. All Readings below 1GHz are Quasi-Peak, above are average value.
2. Emission Level = Reading Level + Probe Factor + Cable loss - PreAMP.
3. The average measurement was not performed when the peak measured data under the limit of average detection.

Product : Wireless LAN PCMCIA Card
 Test Item : Harmonic Radiated Emission Data
 Test Site : No.1 OATS
 Test Mode : Channel 11(1Mbps)

Freq.	Cable	Probe	PreAMP	Reading	Emission	Margin	Limit
MHz	Loss	Factor		Level	Level		
	dB	dB/m	dB	dBuV	dBuV/m	dB	dBuV/m

Horizontal

Peak Detector

4923.520	3.80	33.61	34.69	37.44	40.15	33.85	74.00
7383.720	4.91	36.39	35.02	34.20	< 40.48	33.52	74.00
9848.400	5.70	37.47	35.10	35.75	< 43.82	30.18	74.00

Vertical

Peak Detector

4923.320	3.80	33.61	34.69	36.70	39.41	34.59	74.00
7384.220	4.91	36.39	35.02	34.73	< 41.01	32.99	74.00
9847.790	5.70	37.47	35.10	35.89	< 43.96	30.04	74.00

Note:

1. All Readings below 1GHz are Quasi-Peak, above are average value.
2. Emission Level = Reading Level + Probe Factor + Cable loss - PreAMP.
3. The average measurement was not performed when the peak measured data under the limit of average detection.

Product : Wireless LAN PCMCIA Card
 Test Item : Harmonic Radiated Emission Data
 Test Site : No.1 OATS
 Test Mode : Channel 1(11Mbps)

Freq.	Cable Loss	Probe Factor	PreAMP	Reading Level	Emission Level	Margin	Limit
MHz	dB	dB/m	dB	dBuV	dBuV/m	dB	dBuV/m

Horizontal

Peak Detector

4823.970	3.76	33.50	34.68	39.31	41.89	32.11	74.00
7236.370	4.87	36.24	34.97	33.32	< 39.46	34.54	74.00
9648.190	5.61	37.43	35.10	35.16	< 43.09	30.91	74.00

Vertical

Peak Detector

4823.970	3.76	33.50	34.68	38.68	41.26	32.74	74.00
7235.970	4.87	36.24	34.97	34.58	< 40.72	33.28	74.00
9648.590	5.61	37.43	35.10	35.17	< 43.10	30.90	74.00

Note:

1. All Readings below 1GHz are Quasi-Peak, above are average value.
2. Emission Level = Reading Level + Probe Factor + Cable loss - PreAMP.
3. The average measurement was not performed when the peak measured data under the limit of average detection.

Product : Wireless LAN PCMCIA Card
 Test Item : Harmonic Radiated Emission Data
 Test Site : No.1 OATS
 Test Mode : Channel 6(11Mbps)

Freq.	Cable	Probe	PreAMP	Reading	Emission	Margin	Limit
MHz	Loss	Factor	dB	Level	Level	dB	dBuV/m
	dB	dB/m		dBuV	dBuV/m		

Horizontal

Peak Detector

4873.670	3.78	33.56	34.69	39.02	41.67	32.33	74.00
7311.220	4.89	36.31	34.99	36.51	< 42.71	31.29	74.00
9747.790	5.67	37.45	35.10	35.33	< 43.34	30.66	74.00

Vertical

Peak Detector

4874.020	3.78	33.56	34.69	36.84	39.49	34.51	74.00
7311.020	4.89	36.31	34.99	36.10	< 42.30	31.70	74.00
9748.400	5.67	37.45	35.10	35.43	< 43.44	30.56	74.00

Note:

1. All Readings below 1GHz are Quasi-Peak, above are average value.
2. Emission Level = Reading Level + Probe Factor + Cable loss - PreAMP.
3. The average measurement was not performed when the peak measured data under the limit of average detection.

Product : Wireless LAN PCMCIA Card
 Test Item : Harmonic Radiated Emission Data
 Test Site : No.1 OATS
 Test Mode : Channel 11(11Mbps)

Freq.	Cable Loss	Probe Factor	PreAMP	Reading Level	Emission Level	Margin	Limit
MHz	dB	dB/m	dB	dBuV	dBuV/m	dB	dBuV/m

Horizontal

Peak Detector

4923.970	3.80	33.61	34.69	37.17	39.88	34.12	74.00
7387.020	4.91	36.39	35.02	35.48	< 41.76	32.24	74.00
9847.840	5.70	37.47	35.10	36.40	< 44.47	29.53	74.00

Vertical

Peak Detector

4923.920	3.80	33.61	34.69	36.38	39.09	34.91	74.00
7387.470	4.91	36.39	35.02	34.48	< 40.76	33.24	74.00
9847.740	5.70	37.47	35.10	36.08	< 44.15	29.85	74.00

Note:

1. All Readings below 1GHz are Quasi-Peak, above are average value.
2. Emission Level = Reading Level + Probe Factor + Cable loss - PreAMP.
3. The average measurement was not performed when the peak measured data under the limit of average detection.

Product : Wireless LAN PCMCIA Card
 Test Item : General Radiated Emission Data
 Test Site : No.1 OATS
 Test Mode : Channel 1(1Mbps)

Freq. MHz	Cable Loss dB	Probe Factor dB/m	PreAMP Reading dB	Reading Level dBuV	Emission Level dBuV/m	Margin dB	Limit dBuV/m
Horizontal:							
60.660	1.45	5.78	0.00	2.91	10.14	29.86	40.00
71.580	1.55	7.56	0.00	5.15	14.26	25.74	40.00
111.750	1.93	12.54	0.00	2.44	16.91	26.59	43.50
134.400	2.16	12.52	0.00	3.83	18.51	24.99	43.50
173.150	2.53	10.58	0.00	8.32	21.43	22.07	43.50
* 195.700	2.75	9.48	0.00	17.79	30.02	13.48	43.50
206.300	2.85	10.21	0.00	9.17	22.23	21.27	43.50
292.200	3.67	13.37	0.00	4.93	21.97	24.03	46.00
333.700	3.93	14.66	0.00	13.63	32.22	13.78	46.00
501.600	4.80	17.96	0.00	1.65	24.41	21.59	46.00
603.100	5.33	18.96	0.00	1.95	26.25	19.75	46.00
703.100	5.86	19.30	0.00	0.42	25.58	20.42	46.00
903.100	6.90	20.87	0.00	0.08	27.85	18.15	46.00

Vertical:

34.380	1.20	16.69	0.00	3.88	21.76	18.24	40.00
46.860	1.31	10.51	0.00	8.92	20.74	19.26	40.00
71.280	1.55	8.53	0.00	13.91	23.99	16.01	40.00
85.080	1.68	9.51	0.00	11.30	22.49	17.51	40.00
137.900	2.19	11.78	0.00	8.37	22.34	21.16	43.50
176.550	2.56	8.27	0.00	13.22	24.05	19.45	43.50
293.600	3.69	13.61	0.00	3.81	21.11	24.89	46.00
* 333.600	3.93	14.05	0.00	14.31	32.29	13.71	46.00

Note:

1. All Readings below 1GHz are Quasi-Peak, above are average value.
2. “ * ”, means this data is the worst emission level.
3. Emission Level = Reading Level + Probe Factor + Cable loss.

Product : Wireless LAN PCMCIA Card
 Test Item : General Radiated Emission Data
 Test Site : No.1 OATS
 Test Mode : Channel 6(1Mbps)

Freq.	Cable	Probe	PreAMP	Reading	Emission	Margin	Limit
MHz	Loss	Factor	Level	Level	Level		
	dB	dB/m	dB	dBuV	dBuV/m	dB	dBuV/m
Horizontal:							
70.080	1.53	6.96	0.00	3.14	11.64	28.36	40.00
85.080	1.68	9.98	0.00	6.78	18.44	21.56	40.00
153.500	2.35	11.86	0.00	9.89	24.10	19.40	43.50
173.210	2.53	10.58	0.00	8.78	21.89	21.61	43.50
201.500	2.80	10.14	0.00	11.35	24.29	19.21	43.50
* 334.600	3.93	14.66	0.00	15.36	33.95	12.05	46.00
Vertical:							
43.800	1.28	11.54	0.00	8.48	21.30	18.70	40.00
59.160	1.43	7.67	0.00	14.19	23.29	16.71	40.00
136.950	2.18	11.86	0.00	11.13	25.17	18.33	43.50
167.250	2.47	9.63	0.00	13.88	25.98	17.52	43.50
207.300	2.86	9.71	0.00	5.87	18.44	25.06	43.50
* 334.300	3.93	14.15	0.00	14.28	32.36	13.64	46.00

Note:

1. All Readings below 1GHz are Quasi-Peak, above are average value.
2. “ * ”, means this data is the worst emission level.
3. Emission Level = Reading Level + Probe Factor + Cable loss.

Product : Wireless LAN PCMCIA Card
 Test Item : General Radiated Emission Data
 Test Site : No.1 OATS
 Test Mode : Channel 11(1Mbps)

Freq.	Cable	Probe	PreAMP	Reading	Emission	Margin	Limit
MHz	Loss	Factor	dB	Level	Level	dB	dBuV/m
	dB	dB/m		dBuV	dBuV/m		

Horizontal:

70.800	1.54	7.16	0.00	4.10	12.80	27.20	40.00
111.200	1.93	12.54	0.00	3.50	17.97	25.53	43.50
134.400	2.16	12.52	0.00	5.60	20.28	23.22	43.50
173.200	2.53	10.58	0.00	9.00	22.11	21.39	43.50
202.300	2.80	10.14	0.00	12.00	24.94	18.56	43.50
* 334.200	3.93	14.66	0.00	15.10	33.69	12.31	46.00

Vertical:

43.200	1.28	11.54	0.00	8.30	21.12	18.88	40.00
60.480	1.44	7.57	0.00	13.80	22.81	17.19	40.00
137.200	2.19	11.78	0.00	10.00	23.97	19.53	43.50
168.200	2.49	9.53	0.00	13.50	25.52	17.98	43.50
207.300	2.86	9.71	0.00	7.80	20.37	23.13	43.50
* 334.300	3.93	14.15	0.00	14.10	32.18	13.82	46.00

Note:

1. All Readings below 1GHz are Quasi-Peak, above are average value.
2. “ * ”, means this data is the worst emission level.
3. Emission Level = Reading Level + Probe Factor + Cable loss.

Product : Wireless LAN PCMCIA Card
 Test Item : General Radiated Emission Data
 Test Site : No.1 OATS
 Test Mode : Channel 1(11Mbps)

Freq.	Cable	Probe	PreAMP	Reading	Emission	Margin	Limit
MHz	Loss	Factor	dB	Level	Level	dB	dBuV/m
	dB	dB/m		dBuV	dBuV/m		

Horizontal:

60.720	1.45	5.78	0.00	1.61	8.84	31.16	40.00
86.280	1.69	9.98	0.00	1.78	13.45	26.55	40.00
137.700	2.19	12.82	0.00	4.83	19.83	23.67	43.50
172.850	2.52	10.58	0.00	9.32	22.42	21.08	43.50
228.700	3.06	10.82	0.00	7.03	20.92	25.08	46.00
328.700	3.90	14.49	0.00	10.44	28.83	17.17	46.00
467.750	4.63	17.52	0.00	1.31	23.45	22.55	46.00
* 747.950	6.09	20.29	0.00	6.06	32.44	13.56	46.00

Vertical:

46.740	1.31	10.51	0.00	8.12	19.94	20.06	40.00
67.500	1.51	8.04	0.00	11.60	21.16	18.84	40.00
85.560	1.68	9.51	0.00	12.66	23.85	16.15	40.00
112.300	1.94	12.10	0.00	6.04	20.08	23.42	43.50
138.750	2.20	11.68	0.00	7.87	21.74	21.76	43.50
176.450	2.56	8.27	0.00	13.72	24.55	18.95	43.50
228.100	3.06	11.55	0.00	5.69	20.31	25.69	46.00
* 334.200	3.93	14.05	0.00	14.13	32.11	13.89	46.00
747.950	6.09	20.18	0.00	5.30	31.57	14.43	46.00

Note:

1. All Readings below 1GHz are Quasi-Peak, above are average value.
2. “ * ”, means this data is the worst emission level.
3. Emission Level = Reading Level + Probe Factor + Cable loss.

Product : Wireless LAN PCMCIA Card
 Test Item : General Radiated Emission Data
 Test Site : No.1 OATS
 Test Mode : Channel 6(11Mbps)

Freq. MHz	Cable Loss dB	Probe Factor dB/m	PreAMP Reading dB	Reading Level dBuV	Emission Margin Level dBuV/m	Margin dB	Limit dBuV/m
Horizontal:							
69.240	1.53	6.96	0.00	1.96	10.46	29.54	40.00
85.320	1.68	9.98	0.00	6.08	17.74	22.26	40.00
135.850	2.17	12.92	0.00	7.57	22.66	20.84	43.50
167.150	2.47	11.10	0.00	11.88	25.45	18.05	43.50
208.000	2.86	10.26	0.00	9.99	23.11	20.39	43.50
* 334.300	3.93	14.66	0.00	11.38	29.97	16.03	46.00

Vertical:							
46.680	1.31	10.51	0.00	9.30	21.12	18.88	40.00
58.680	1.42	8.24	0.00	13.49	23.15	16.85	40.00
136.350	2.18	11.86	0.00	10.65	24.69	18.81	43.50
173.900	2.53	8.58	0.00	13.84	24.95	18.55	43.50
* 334.200	3.93	14.05	0.00	14.07	32.05	13.95	46.00
847.800	6.61	20.84	0.00	0.79	28.24	17.76	46.00

Note:

1. All Readings below 1GHz are Quasi-Peak, above are average value.
2. “ * ”, means this data is the worst emission level.
3. Emission Level = Reading Level + Probe Factor + Cable loss.

Product : Wireless LAN PCMCIA Card
 Test Item : General Radiated Emission Data
 Test Site : No.1 OATS
 Test Mode : Channel 11(11Mbps)

Freq. MHz	Cable Loss dB	Probe Factor dB/m	PreAMP Reading dB	Reading Level dBuV	Emission Level dBuV/m	Margin dB	Limit dBuV/m
Horizontal:							
62.300	1.46	5.79	0.00	2.10	9.35	30.65	40.00
86.100	1.69	9.98	0.00	6.10	17.77	22.23	40.00
138.310	2.20	12.50	0.00	6.90	21.60	21.90	43.50
172.850	2.52	10.58	0.00	11.10	24.20	19.30	43.50
208.200	2.86	10.26	0.00	9.80	22.92	20.58	43.50
* 333.800	3.93	14.66	0.00	12.10	30.69	15.31	46.00
Vertical:							
46.740	1.31	10.51	0.00	9.10	20.92	19.08	40.00
85.560	1.68	9.51	0.00	13.10	24.29	15.71	40.00
138.500	2.20	11.68	0.00	11.00	24.87	18.63	43.50
173.900	2.53	8.58	0.00	14.10	25.21	18.29	43.50
228.300	3.06	11.55	0.00	6.10	20.72	25.28	46.00
* 334.200	3.93	14.05	0.00	14.20	32.18	13.82	46.00

Note:

1. All Readings below 1GHz are Quasi-Peak, above are average value.
2. “ * ”, means this data is the worst emission level.
3. Emission Level = Reading Level + Probe Factor + Cable loss.

6. Band Edge

6.1. Test Equipment

The following test equipments are used during the band edge tests:

	Equipment	Manufacturer	Model No./Serial No.	Last Cal.
X	Spectrum Analyzer	Advantest	R3272 / 72421194	May, 2002
X	Test Receiver	R & S	ESCS 30 / 825442/14	May, 2002
X	Spectrum Analyzer	Advantest	R3261C / 71720140	May, 2002
X	Pre-Amplifier	HP	8447D/3307A01812	May, 2002
X	Bilog Antenna	Chase	CBL6112B / 12452	Sep., 2001
X	Horn Antenna	EM	EM6917 / 103325	May, 2002

- Note: 1. All equipments that need to calibrate are with calibration period of 1 year.
 2. Mark "X" test instruments are used to measure the final test results.

6.2. Test Setup

RF Conducted Measurement:

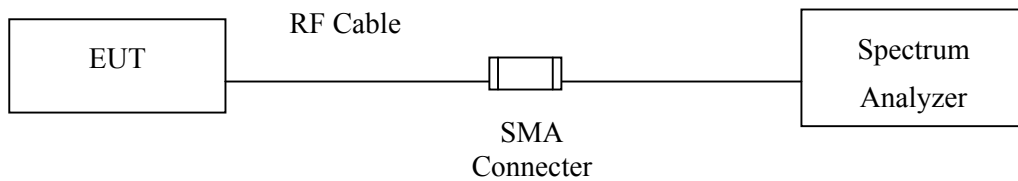

RF Radiated Measurement:

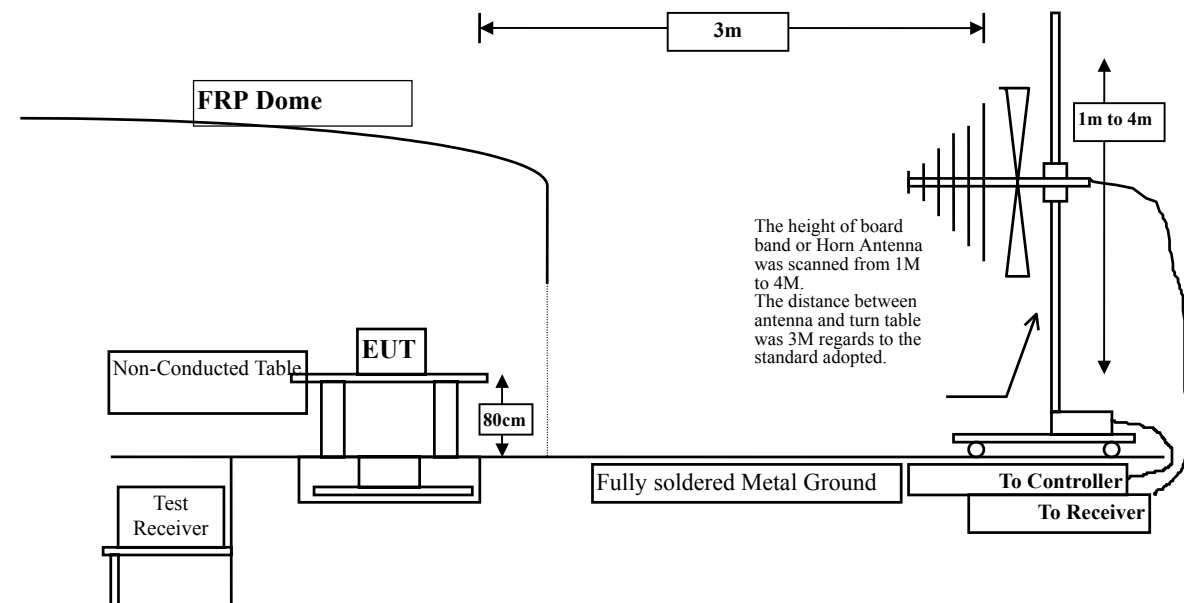

6.3. Test Condition

Standard Temperature and Humidity, Standard Test Voltage

6.4. Limit

In any 100 kHz bandwidth outside the frequency band in which the spread spectrum intentional radiator is operating, the radio frequency power that is produced by the intentional radiator shall be at least 20 dB below that in the 100 kHz bandwidth within the band that contains the highest level of the desired power, based on either an RF conducted or a radiated measurement. Attenuation below the general limits specified in Section 15.209(a) is not required. In addition, radiated emissions which fall in the restricted bands, as defined in Section 15.205(a), must also comply with the radiated emission limits specified in Section 15.209(a) (see Section 15.205(c)).

6.5. Test Procedure

The EUT and its simulators are placed on a turn table which is 0.8 meter above ground. The turn table can rotate 360 degrees to determine the position of the maximum emission level. The EUT was positioned such that the distance from antenna to the EUT was 3 meters.

The antenna can move up and down between 1 meter and 4 meters to find out the maximum emission level.

Both horizontal and vertical polarization of the antenna are set on measurement. In order to find the maximum emission, all of the interface cables must be manipulated according to ANSI C63.4:1992 on radiated measurement.

The additional latch filter below 1GHz was used to measure the level of harmonics radiated emission during field strength of harmonics measurement.

The bandwidth below 1GHz setting on the field strength meter is 120 kHz, above 1GHz are 1 MHz.

6.6. Test Result of Band Edge

Product : Wireless LAN PCMCIA Card
 Test Item : Band Edge Data
 Test Site : No.1 OATS
 Test Mode : Channel 1 (1Mbps)

RF Radiated Measurement:

Channel No.	Frequency (MHz)	Required Limit (dBc)	Result
1 (Horizontal)	<2400	>20	Pass
1 (Vertical)	<2400	>20	Pass

Figure Channel 1: (Horizontal)

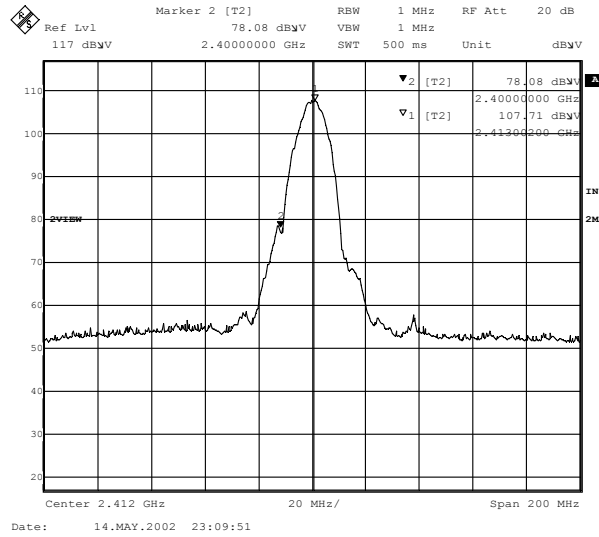
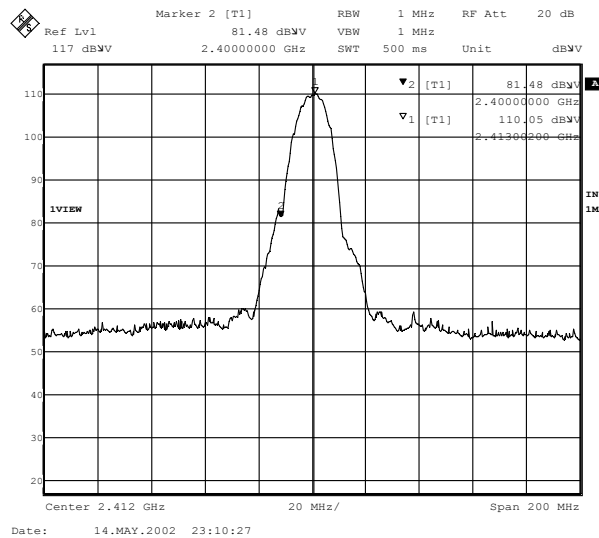

Figure Channel 1: (Vertical)



Product : Wireless LAN PCMCIA Card
 Test Item : Band Edge Data
 Test Site : No.1 OATS
 Test Mode : Channel 1 (11Mbps)

RF Radiated Measurement:

Channel No.	Frequency (MHz)	Required Limit (dBc)	Result
1 (Horizontal)	<2400	>20	Pass
1 (Vertical)	<2400	>20	Pass

Figure Channel 1:

(Horizontal)

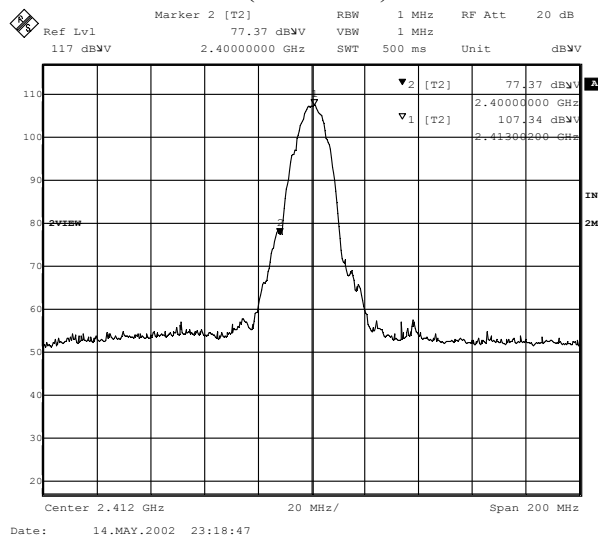
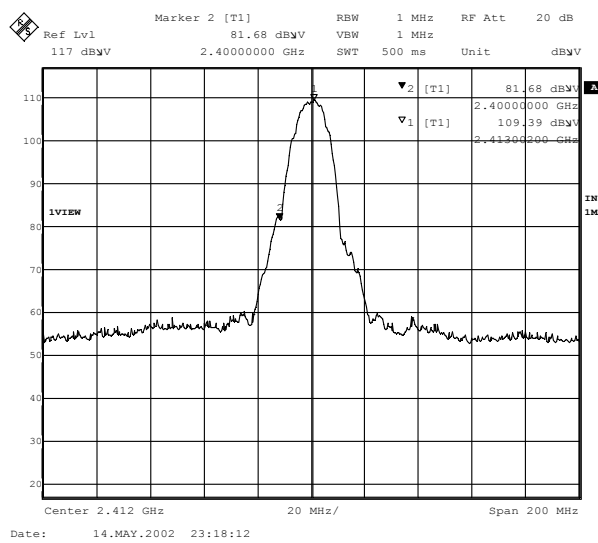

Figure Channel 1:

(Vertical)



Product : Wireless LAN PCMCIA Card
 Test Item : Band Edge Data
 Test Site : No.1 OATS
 Test Mode : Channel 11 (1Mbps)

RF Radiated Measurement: (Peak Detector)

Channel No.	Frequency (MHz)	Reading Level (dBuV)	Emission Level (dBuV/m)	Limit (dBuV/m)	Result
11(Horizontal)	2487.15	56.54	53.69	74	Pass
11 (Vertical)	2487.35	58.40	55.55	74	Pass

Figure Channel 11:

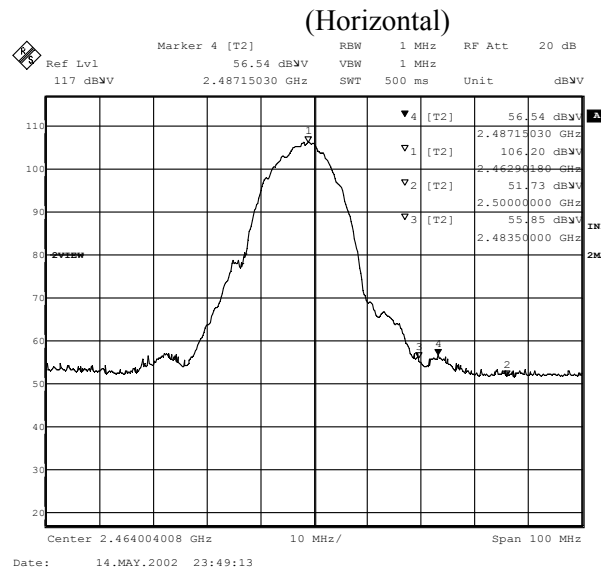
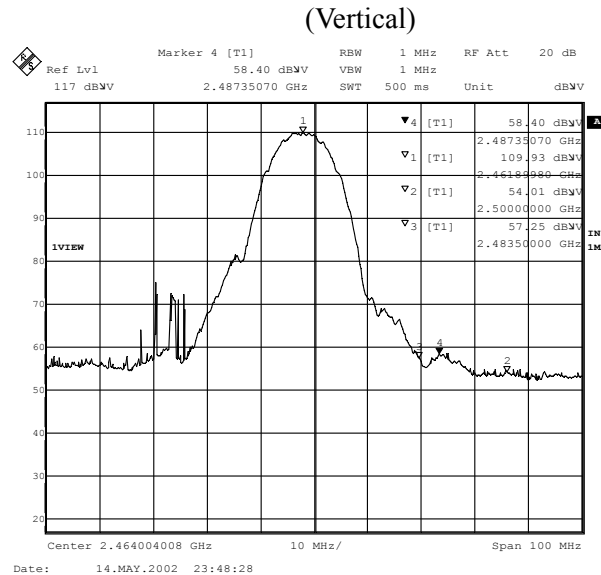

Figure Channel 11:



Note:

- 1) The average measurement was not performed when the peak measured data under the limit of average detector.

Product : Wireless LAN PCMCIA Card
 Test Item : Band Edge Data
 Test Site : No.1 OATS
 Test Mode : Channel 11 (1Mbps)

RF Radiated Measurement: (Average Detector)

Channel No.	Frequency (MHz)	Reading Level (dBuV)	Emission Level (dBuV/m)	Limit (dBuV/m)	Result
11(Horizontal)	2487.75	45.28	42.43	54	Pass
11 (Vertical)	2487.55	47.83	44.98	54	Pass

Figure Channel 11:

(Horizontal)

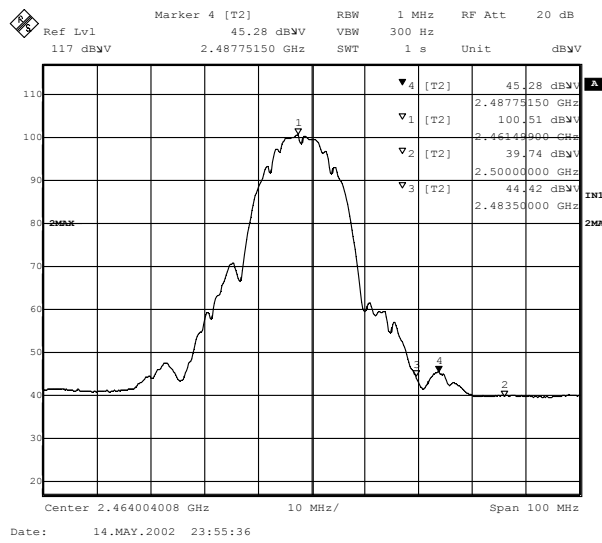
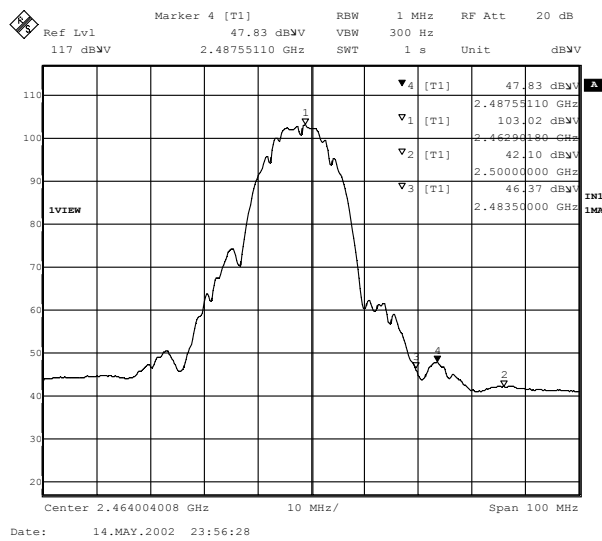

Figure Channel 11:

(Vertical)



Product : Wireless LAN PCMCIA Card
 Test Item : Band Edge Data
 Test Site : No.1 OATS
 Test Mode : Channel 11 (11Mbps)

RF Radiated Measurement: (Peak Detector)

Channel No.	Frequency (MHz)	Reading Level (dBuV)	Emission Level (dBuV/m)	Limit (dBuV/m)	Result
11(Horizontal)	2487.15	56.17	53.32	74	Pass
11(Vertical)	2487.55	60.12	57.27	74	Pass

Figure Channel 11:

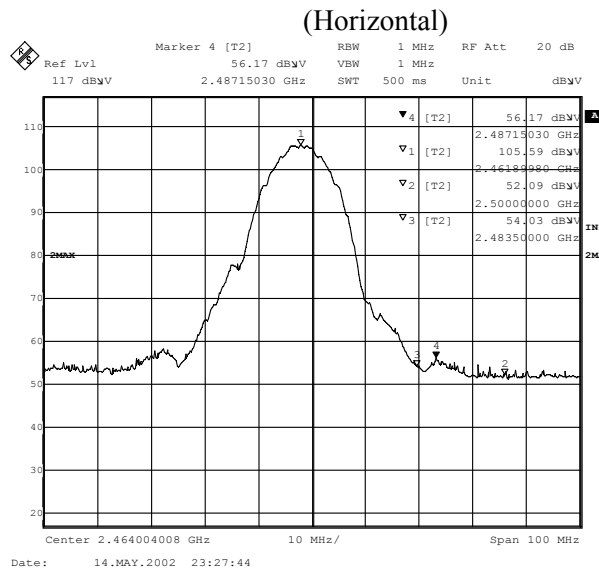
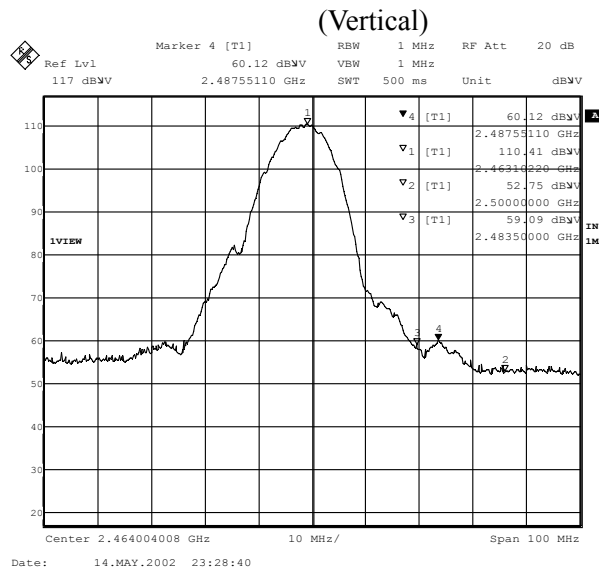

Figure Channel 11:



Note:

1) The average measurement was not performed when the peak measured data under the limit of average detector.

Product : Wireless LAN PCMCIA Card
 Test Item : Band Edge Data
 Test Site : No.1 OATS
 Test Mode : Channel 11 (11Mbps)

RF Radiated Measurement: (Average Detector)

Channel No.	Frequency (MHz)	Reading Level (dBuV)	Emission Level (dBuV/m)	Limit (dBuV/m)	Result
11(Horizontal)	2487.55	45.83	42.98	54	Pass
11(Vertical)	2487.75	50.32	47.47	54	Pass

Figure Channel 11:

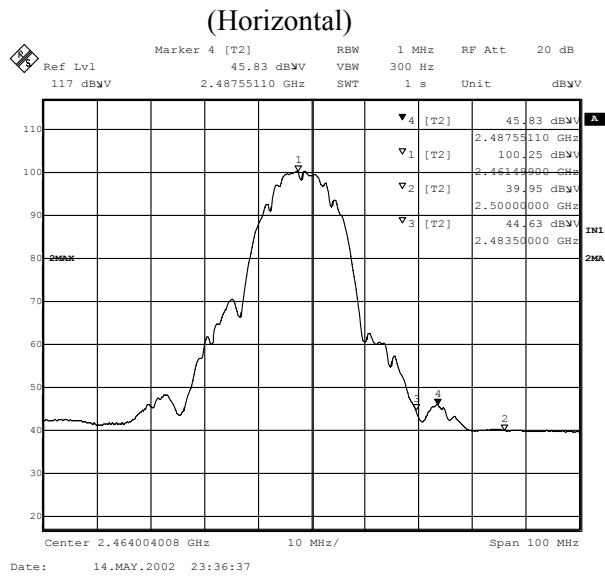
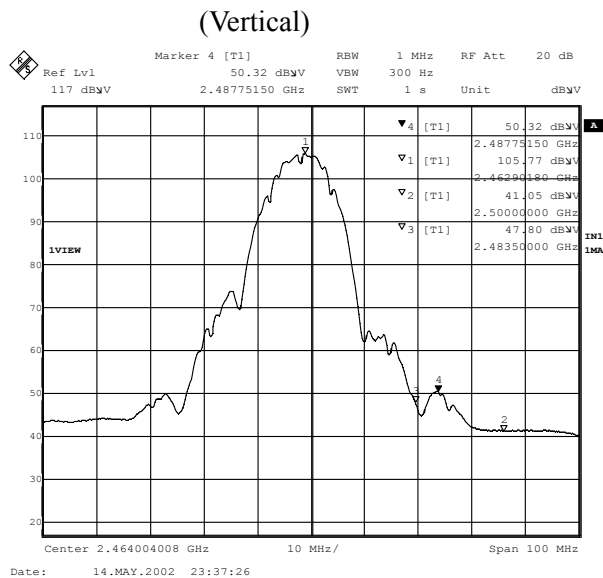

Figure Channel 11:



7. Occupied Bandwidth

7.1. Test Equipment

The following test equipments are used during the radiated emission tests:

Equipment	Manufacturer	Model No./Serial No.	Last Cal.
X Spectrum Analyzer	Advantest	R3272 / 72421194	May, 2002

Note: 1. All equipment upon which need to calibrated are with calibration period of 1 year.
 2. Mark "X" test instruments are used to measure the final test results.

7.2. Test Setup

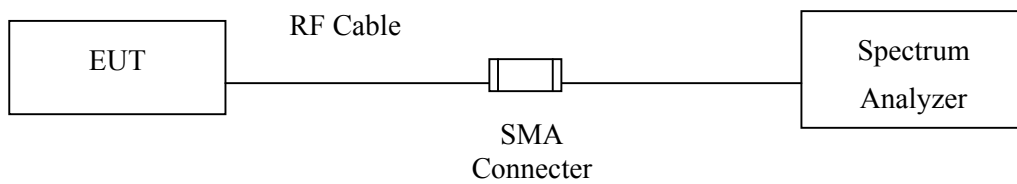

7.3. Test Condition

Standard Temperature and Humidity, Standard Test Voltage

7.4. Limit

The minimum bandwidth shall be at least 500kHz.

7.5. Test Result of Occupied Bandwidth

Product : Wireless LAN PCMCIA Card
 Test Item : Occupied Bandwidth Data
 Test Site : No.1 OATS
 Test Mode : Channel 1

Channel No.	Frequency (MHz)	Measurement Level (kHz)	Required Limit (kHz)	Result
1 (1Mbps)	2412	9950	>500	Pass
1 (11Mbps)	2412	10000	>500	Pass

Figure Channel 1: 1Mbps

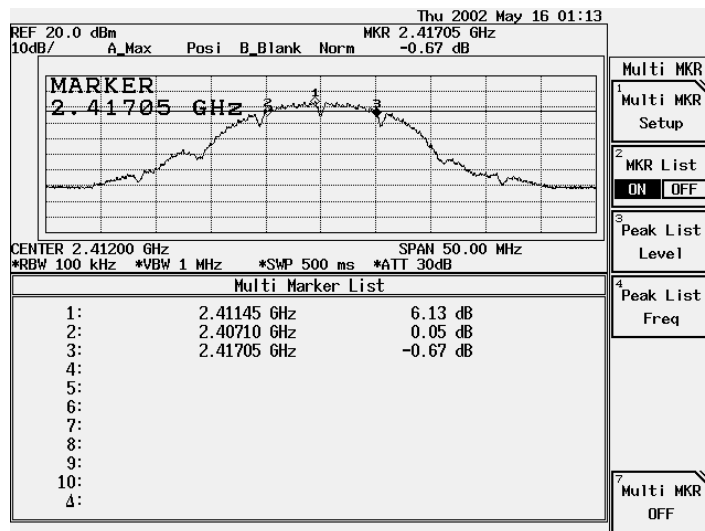
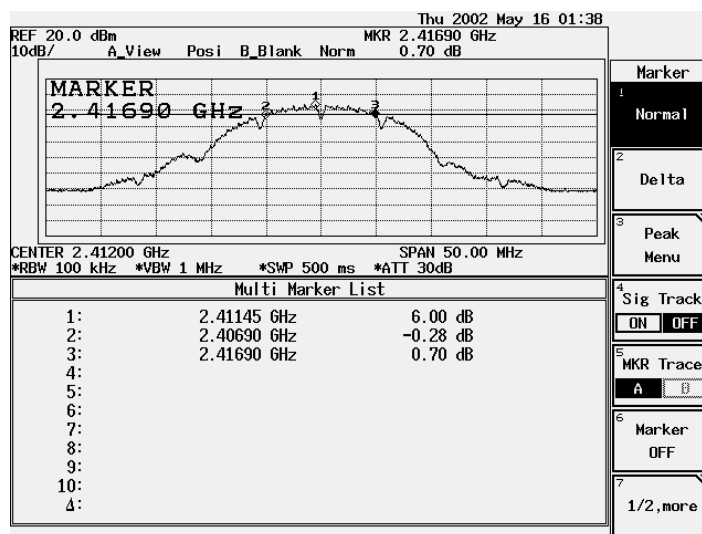

Figure Channel 1: 11Mbps



Product : Wireless LAN PCMCIA Card
 Test Item : Occupied Bandwidth Data
 Test Site : No.1 OATS
 Test Mode : Channel 6

Channel No.	Frequency (MHz)	Measurement Level (kHz)	Required Limit (kHz)	Result
6 (1Mbps)	2437	11500	>500	Pass
6 (11Mbps)	2437	9850	>500	Pass

Figure Channel 6: 1Mbps

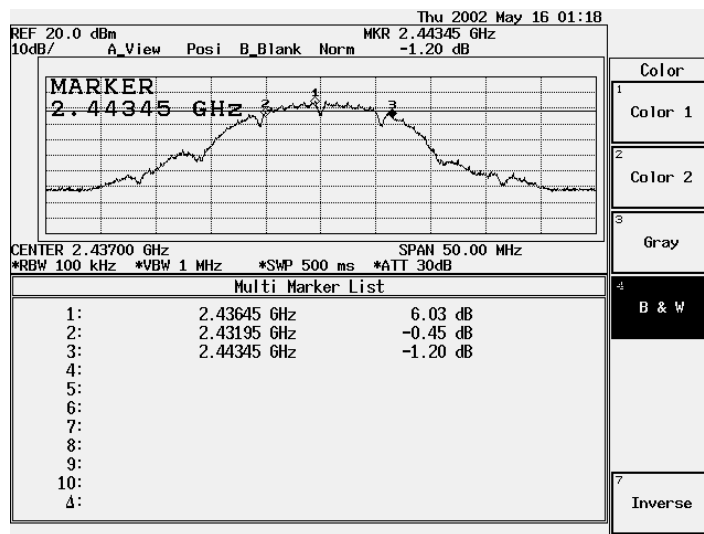
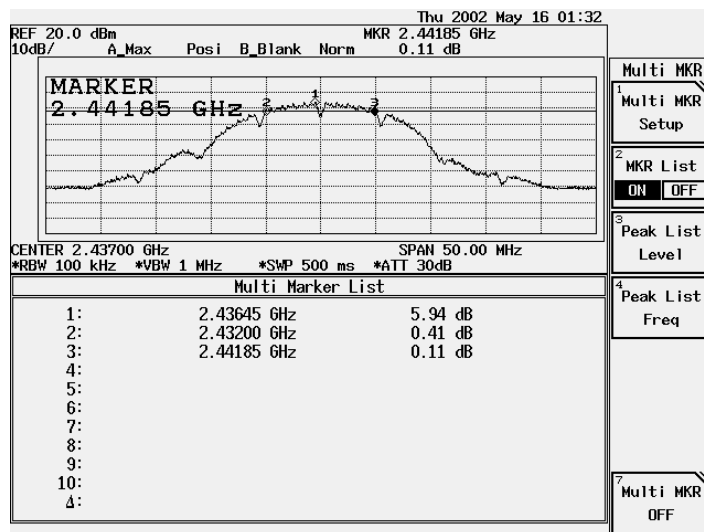

Figure Channel 6: 11Mbps



Product : Wireless LAN PCMCIA Card
 Test Item : Occupied Bandwidth Data
 Test Site : No.1 OATS
 Test Mode : Channel 11

Channel No.	Frequency (MHz)	Measurement Level (kHz)	Required Limit (kHz)	Result
11 (1Mbps)	2462	10000	>500	Pass
11 (11Mbps)	2462	9950	>500	Pass

Figure Channel 11: 1Mbps

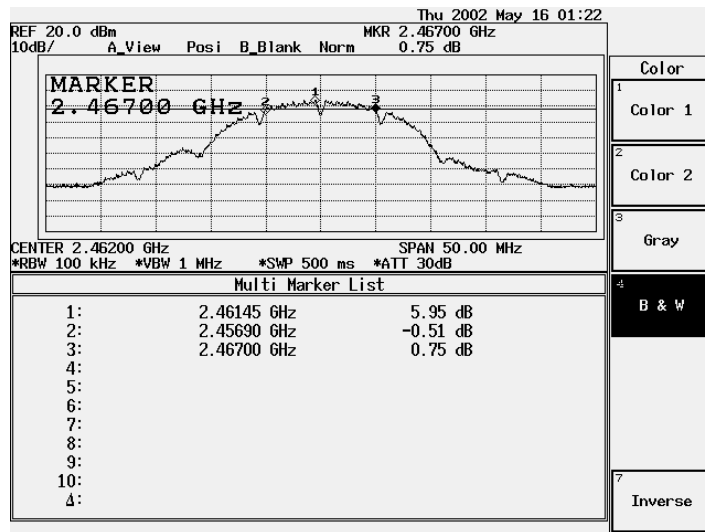
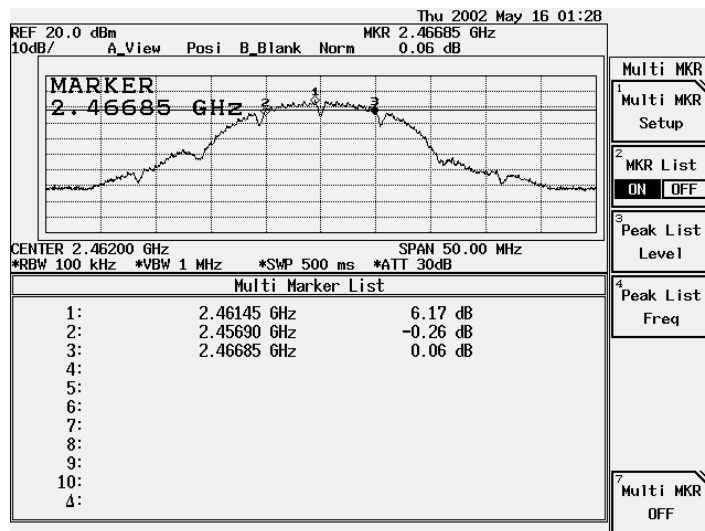

Figure Channel 11: 11Mbps



8. Transmitter Power Density

8.1. Test Equipment

The following test equipments are used during the radiated emission tests:

Equipment	Manufacturer	Model No./Serial No.	Last Cal.
X Spectrum Analyzer	Advantest	R3272 / 72421194	May, 2002

Note: 1. All equipment upon which need to calibrated are with calibration period of 1 year.
 2. Mark "X" test instruments are used to measure the final test results.

8.2. Test Setup

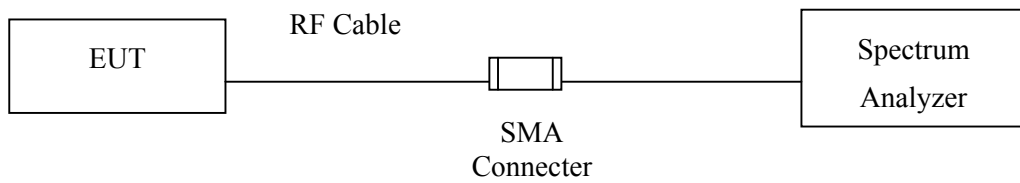

8.3. Test Condition

Standard Temperature and Humidity, Standard Test Voltage

8.4. Limit

The transmitted power density averaged over any 1 second interval shall not be greater +8dBm in any 3kHz bandwidth.

8.5. Test Result of Transmitter Power Density

Product : Wireless LAN PCMCIA Card
 Test Item : Transmitter Power Density Data
 Test Site : No.1 OATS
 Test Mode : Channel 1

Channel No.	Frequency (MHz)	Measurement Level (dBm)	Required Limit (dBm)	Result
1 (1Mbps)	2412.00	7.75	< 8dBm	Pass
1 (11Mbps)	2412.00	4.10	< 8dBm	Pass

1Mbps

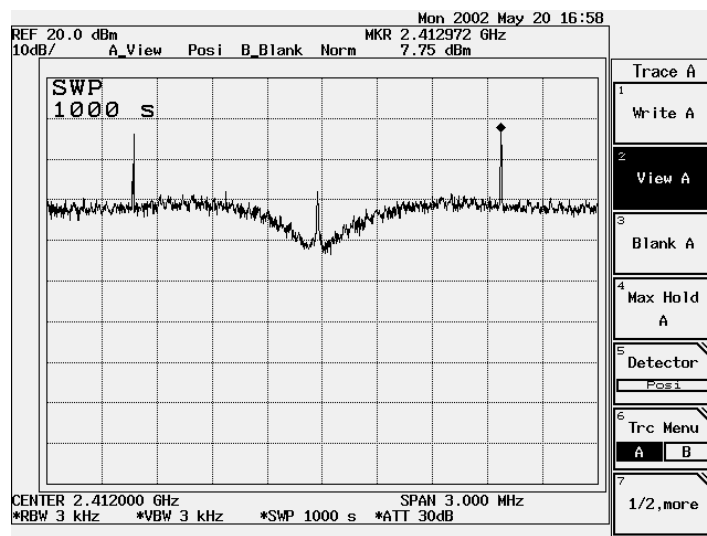

11Mbps

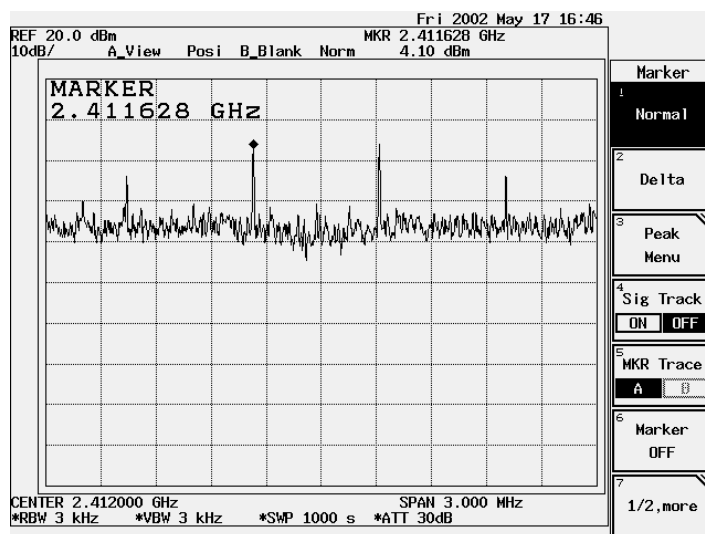

Product : Wireless LAN PCMCIA Card
 Test Item : Transmitter Power Density Data
 Test Site : No.1 OATS
 Test Mode : Channel 6

Channel No.	Frequency (MHz)	Measurement Level (dBm)	Required Limit (dBm)	Result
6 (2Mbps)	2437.00	4.31	< 8dBm	Pass
6 (11Mbps)	2437.00	4.45	< 8dBm	Pass

1Mbps

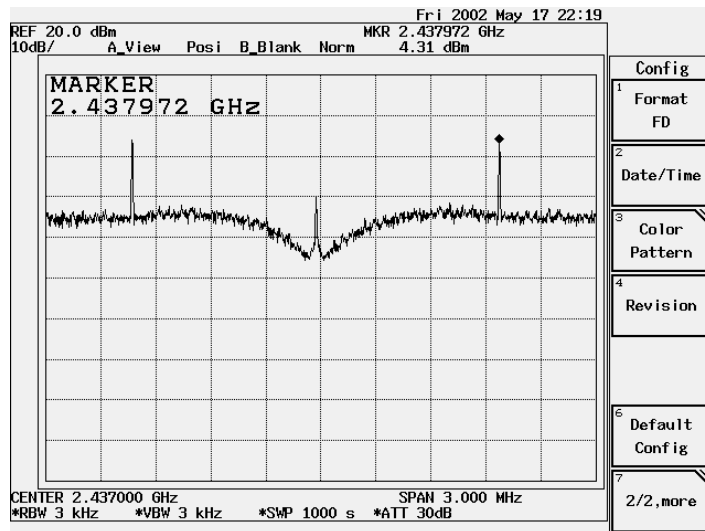

11Mbps

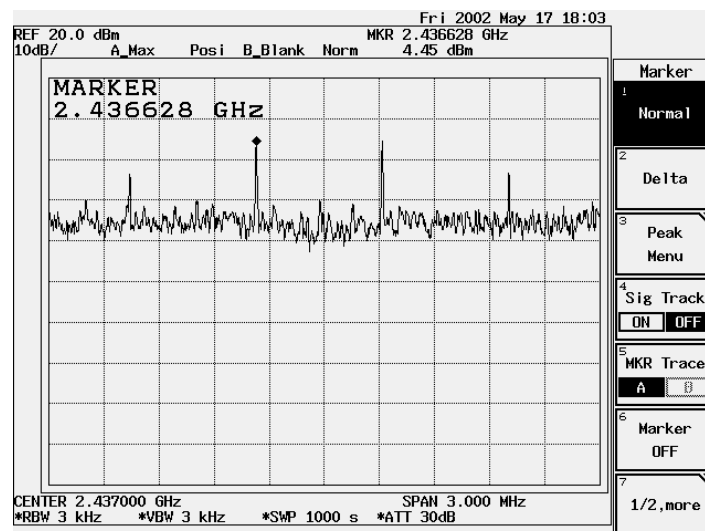

Product : Wireless LAN PCMCIA Card
 Test Item : Transmitter Power Density Data
 Test Site : No.1 OATS
 Test Mode : Channel 11

Channel No.	Frequency (MHz)	Measurement Level (dBm)	Required Limit (dBm)	Result
11 (2Mbps)	2462.00	4.17	< 8dBm	Pass
11 (11Mbps)	2462.00	4.56	< 8dBm	Pass

1Mbps

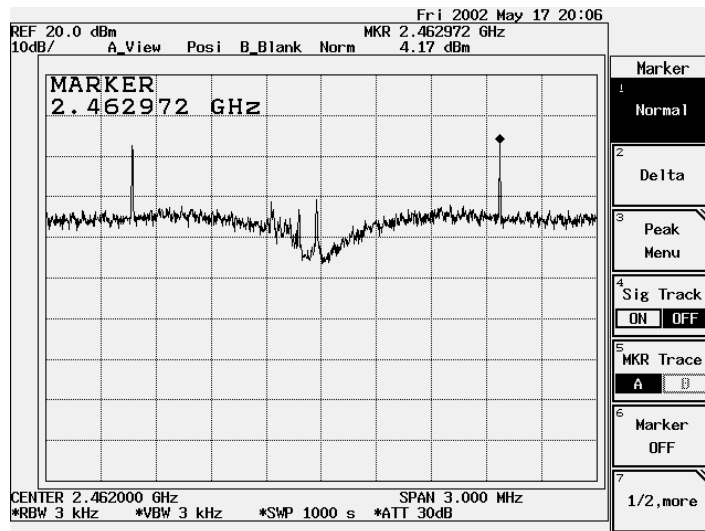

11Mbps

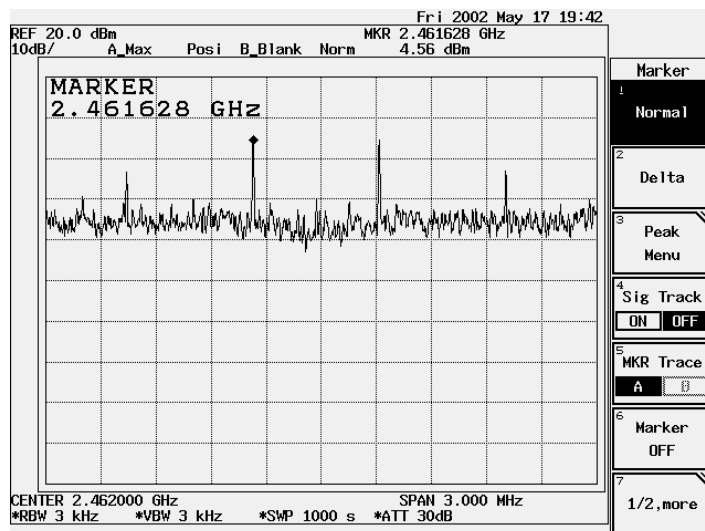

9. Processing Gain

9.1. Test Condition

Standard Temperature and Humidity, Standard Test Voltage

9.2. Limit

According to FCC Part 15 Subpart C Paragraph 15.247(e), The processing gain shall be at least 10 dB.

9.3. Test Result of Processing Gain

As EUT power is less than 20dBm, processing gain is not applicable.

10. EMI Reduction Method During Compliance Testing

No modification was made during testing.

Attachment 1 : EUT Test Photographs

Attachment 1: EUT Test Setup Photographs

Front View of Conducted Test



Back View of Conducted Test



Front View of Radiated Test



Back View of Radiated Test

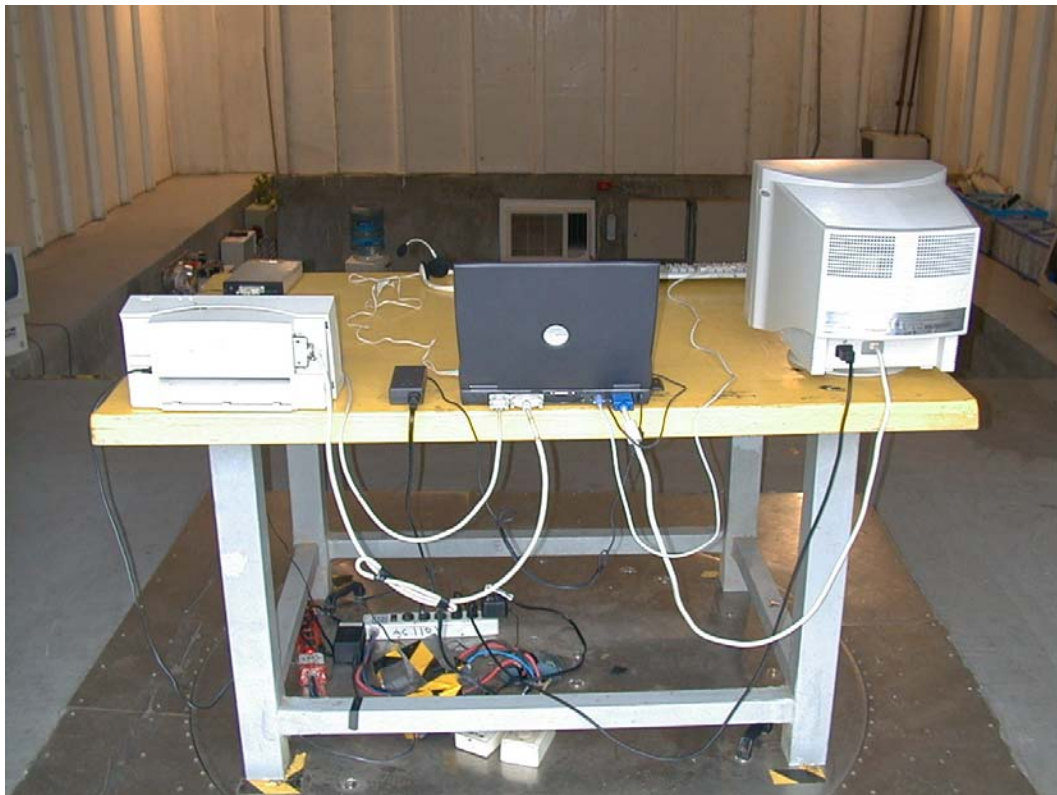

Front View of Radiated Test (Horn)



Attachment 2 : EUT Detailed Photographs

Attachment 2 : EUT Detailed Photographs

(1) EUT Photo



(2) EUT Photo



(3) EUT Photo



(6) EUT Photo

